

ENGINE EXPERTISE: VOLKSWAGEN GROUP



2014
2015

ENGINE EXPERTISE
AUDI, SEAT, SKODA AND VOLKSWAGEN

CATMX1301



FEDERAL MOGUL



ENGINE EXPERTISE

OE QUALITY YOU CAN TRUST

- An ultra light design and vertical location to save
- Reduced emissions and advanced engine protection due to increased oil capacity

FEDERAL MOGUL | GLYCO | GOETZE | Niral | Payen

5x MORE THAN LONGER LIFE BEARING SHELLS & CRANKSHAFT

IROX WATERLESS

FEDERAL MOGUL | GLYCO | GOETZE | Niral | Payen

125

SEEKING TO MAXIMISE FUEL ECONOMY?

CARBOLIFE

Provides exceptional scuffing and wear resistance compared to conventional piston rings

FEDERAL MOGUL | GLYCO | GOETZE | Niral | Payen

FITTED WITH GOETZE RINGS

WANT TO OPTIMISE ENGINE EFFICIENCY AND FUEL ECONOMY?

ECOTOUGH

The Ecotough® solution lies in the composition of the piston crown coating, thanks to a mix of solid lubricants, optimised for maximum performance

FEDERAL MOGUL | GLYCO | GOETZE | Niral | Payen

GASKETS

PERFORMS UNDER PRESSURE

FEDERAL MOGUL | GLYCO | GOETZE | Niral | Payen



ENGINEERED IN GERMANY

СЕРВИС ENGINEERED IN



INTRODUCTION

Dear Federal-Mogul partner,

Welcome to the new *Federal-Mogul Volkswagen Group Engine Expertise* catalogue. All engine and sealing parts for Audi, Seat, Skoda and Volkswagen engines are covered in this catalogue, which is compiled to meet the requirements and increase the efficiency of engine rebuilders and service technicians working on these vehicles.

Federal-Mogul is an innovative and diversified global supplier of quality products, trusted brands and creative solutions for the OE market. We prioritise value creation through technology and innovation in products, processes and services, which makes us the preferred supplier to the global OE market.

The complete service for Volkswagen engine rebuild specialists

Federal-Mogul's new catalogue provides specialists rebuilding Volkswagen engines with the latest, trusted OE specification technologies from a one-stop-shop. Our customers get to feel the benefit of Federal-Mogul's extensive experience in developing innovative products and also its range of expert brands that include: AE[®] for valvetrain, camtrain and belts; Payen[®] gaskets, sets, seals and headbolts; Nüral[®] pistons and assemblies; Goetze[®] piston rings and liners; and Glyco[®] engine bearings. All manufactured to exacting OE specification.

Future successes and reduced emissions

Federal-Mogul focuses on the quality and innovation that helps our global vehicle manufacturer customers continue to increase durability and drive down harmful CO₂ emissions. This proven expertise recognised through our brands is highly regarded by engine rebuild specialists worldwide.

Federal-Mogul's established business partnerships provide a reliable support network committed to servicing the needs of the automotive market, which helps optimise businesses' working practices and results in customer satisfaction.

We hope you enjoy the benefits of this catalogue!

Mark Whitehead,
Marketing Director Engine



Alexis Goslin,
Business Director Sealing



CONTENT



Content	II
How to use this catalogue	IV - VII
Terms of business	XXXVI
Engine index	XXXVIII - LI
Top engine applications	1 - 439
Bottom engine applications	441 - 732
Numerical parts list	734 - 785
OE interchange	786 - 788
Valve guides	789
Camshaft oil seals	790
Cylinder headbolts	791
Footnotes	792 - 799
Federal-Mogul anti-counterfeit programme	802



Inhaltsverzeichnis	II
So benutzen Sie diesen Katalog	VIII - XI
Geschäftsbedingungen	XXXVI
Motorindex	XXXVIII - LI
Zylinderkopfanwendungen	1 - 439
Motorblockanwendungen	441 - 732
Numerische Teileliste	734 - 785
OE-Entsprechungen	786 - 788
Ventilführungen	789
Nockenwellen-Öldichtungen	790
Zylinderkopfschrauben	791
Fußnoten	792 - 799
Federal-Mogul Anti-Fälschungsprogramm	802



Contenuto	II
Come si utilizza il catalogo	XII - XV
Condizioni generali	XXXVI
Indice motore	XXXVIII - LI
Applicazioni parte alta del motore	1 - 439
Applicazioni bassa inferiore del motore	441 - 732
Elenco riferimenti	734 - 785
Intercambio OE	786 - 788
Guidavalvole	789
Paraoli albero a camme	790
Viti testa cilindro	791
Note a piè di pagina	792 - 799
Programma anti-contraffazione di Federal-Mogul	802



Contenu	II
Comment se servir de ce catalogue	XVI - XIX
Conditions générales de vente	XXXVI
Index moteur	XXXVIII - LI
Applications haut moteur	1 - 439
Applications bas moteur	441 - 732
Liste numérique des références	734 - 785
Liste d'équivalence Première Monte (OE)	786 - 788
Guides de soupape	789
Bagues d'étanchéité d'arbre à cames	790
Vis de culasse	791
Notes de bas de page	792 - 799
Programme anti-contrefaçon de Federal-Mogul	802

CONTENT



Índice	III
Cómo utilizar este catálogo	XX - XXIII
Condiciones de venta	XXXVII
Índice de motores	XXXVIII - LI
Aplicaciones para la parte superior del motor	1 - 439
Aplicaciones para la parte inferior del motor	441 - 732
Lista de referencias	734 - 785
Cruce de referencias de equipo original	786 - 788
Guías de válvula	789
Retenes de aceite del árbol de levas	790
Tornillos de culata	791
Pies de página	792 - 799
Programa antifalsificación de Federal-Mogul	802



Spis treści	III
Jak używać tego katalogu	XXIV - XXVII
Warunki współpracy	XXXVII
Indeks silników	XXXVIII - LI
Góra silnika	1 - 439
Dół silnika	441 - 732
Lista części	734 - 785
Zamienniki OE	786 - 788
Prowadnice zaworów	789
Uszczelnienia olejowe wałka rozrządu	790
Śruby do głowicy cylindrów	791
Przypisy	792 - 799
Program Federal-Mogul zapobiegania fałszerstwom	802



Содержание	III
Как пользоваться каталогом	XXVIII - XXXI
Условия делового сотрудничества	XXXVII
Указатель двигателей	XXXVIII - LI
Детали верхней части двигателя	1 - 439
Детали нижней части двигателя	441 - 732
Список номеров деталей	734 - 785
Взаимозаменяемость с оригинальными деталями	786 - 788
Направляющие клапанов	789
Сальники распределительного вала	790
Болты ГБЦ	791
Примечания	792 - 799
Программа защиты от подделок Federal-Mogul	802



III	المحتوى
XXXV - XXXII	كيفية استخدام هذا الكatalog
XXXVII	شروط العمل
XXXVIII - LI	مؤشر المحرك
1 - 439	تطبيقات المحرك العلوية
441 - 732	تطبيقات المحرك السفلية
734 - 785	قائمة القطع المرقمة
786 - 788	تبادل المعدة الأصلية
789	موجهات الصمامات
790	سدادات زيت عمود الكامات
791	مسامير رأس الأسطوانة
792 - 799	الهوامش
802	برنامج Federal-Mogul لمكافحة إنتاج قطع الغيار المقلدة



HOW TO USE THIS CATALOGUE



VW GROUP

1 92	2 76.50	Petrol			
3 ATN	4 Cyl.	11.5:1	1598cc	77kW (105)PS	5 TD15531 150 6
4 LEON	09/00→06/06				

7 	8 	9 	10
TB634 58x17 TB658 26 130x20	TBK246		
		11 	12
		FOL179 (x16)	FOL167 (x16)

13 B x C x D	OE	MAT.	19 	20 45°	21 Y	22 H
V94116 14 29.50 x 6.00 x 100.90	036 109 601S		17 MB	20 45°		
V94117 14 26.00 x 6.00 x 100.50	036 109 611K		17 MG			
15	16		18			

23 E x F x G	24
VAG96073B 14 36.00 x 6.02 x 11.06	25 24

- 1** Panel no.
- 2** Bore size
- 3** Engine detail
- 4** Model detail
- 5** TecDoc / F-M engine no.
- 6** Corresponding bottom engine panel number
- 7** Timing belt references
No. of teeth x belt width
- 8** Timing belt kit references

- 9** Camshaft references
- 10** Camkit references
- 11** Rocker arm references
(required engine quantity in brackets)
- 12** Tappet & Thrust pad references
(required engine quantity in brackets)
- 13** Valve references
- 14** Fitting position
- 15** Valve dimensions
- 16** Valve OE reference

- 17** Material code
- 18** Valve stem coating
- 19** Cotter design
- 20** Seat angle
- 21** Seat treatment
- 22** Tip treatment
- 23** Valve guide references
- 24** Valve guide shape
- 25** Valve guide dimensions
- 26** See footnote section

MATERIAL CODE	TYPE	HEAD	STEM	SUITABLE FOR
MB	Mono-Metal	Martensitic chrome-silicon alloy steel	n/a	Petrol & diesel inlet valves and for stems in bimetallic exhaust valves
MD	Mono-Metal	Austenitic chrome-manganese-nickel steel	n/a	Exhaust valves operating up to 750°C
ME	Bi-Metal	Austenitic chrome-manganese-nickel steel with added niobium, tungsten and nitrogen	MB	Heavy duty exhaust valves, operating up to 780°C
MF	Bi-Metal	Nimonic™, nickel based super alloy with added chromium, cobalt and titanium	MB	Exhaust valves; good mechanical strength, resistance to fatigue, erosion & corrosion. Operating up to 820°C
MG	Bi-Metal	MD	MB	Exhaust valves operating up to 750°C

FEATURE CODE	DESCRIPTION
cr	Chrome layer on valve stem
tu	Tufrided/Nitrided valve
ss	Stellite welded seat
Y	Hardened valve seat
st	Stellite welded tip
H	Hardened valve tip

HOW TO USE THIS CATALOGUE



VW GROUP

1 179	2 76.50	Petrol				6
3 AEE	4 Cyl.	9.8:1	1598cc	55kW (75)PS	5 TD13394	75
4 FELICIA	08/95 → 04/02	OCTAVIA		09/96 → 09/04		
7	8	9	10	11	12	13
BZ180 (MLS), 0.500mm	DZ181		HBS075 15 M11x1.50x110.00mm (x10)	JD597 11 JD601 11	JP074 HM5062 12	HR599 13
						14 NA5001 32.00x47.00x10.00mm FPM
BZ180						

1 Panel no.

2 Bore size

3 Engine detail

4 Model detail

5 TecDoc / F-M engine no.

6 Corresponding bottom engine panel number

7 CYLINDER HEAD GASKET

= Left

= Right

= Piston protrusion

0.50mm = Thickness

1 hole = Identification mark

8 HEAD SET

= Without cylinder head gasket

= Without seals

= Without valve cover gasket

= Without valve stem seals

9 FULL SET

= Without cylinder head gasket

= Without seals

= Without valve cover gasket

= Without valve stem seals

10 HEADBOLT SET

Headbolt shape



Male hex



Female hex



Male star



Female star



Male torx



Female torx



Hexagon Collar



Female Splined (Ribe-CV)*

*Ribe-CV® is a registered trademark of Richard Bergner GmbH & Co.

11 MANIFOLD GASKET

Left =

Right =

Set =

Inlet =

Exhaust =

Upper =

Lower =

12 VALVE COVER GASKET

Left =

Right =

Inlet =

Exhaust =

Set =

13 VALVE STEM SEAL

Set =

Inlet =

Exhaust =

14 CAMSHAFT OIL SEALS

Front =

Rear =

15 See footnote section



HOW TO USE THIS CATALOGUE



VW GROUP	
1 99	2 76.50 2 Diesel
3 CY	4 Cyl. 23/23.5:1 1588cc 51kW (70)PS 5 TD4052 45 6
4 GOLF	03/82→07/83 JETTA 03/82→02/84 PASSAT 04/82→03/88
SANTANA	12/81→12/84
7	8
<p>7</p> <p>87-109800-10 STD 87-109807-10 [2] 0.50mm 87-109811-10 [2] 1.00mm</p> <p>A 41.70 B- 1.60 D 71.70 24x64</p> <p>11</p> <p>AK HA RT TP</p> <p>12</p> <p>[1] With recesses on crankshaft side [2] A = 41.450</p> <p>[1] Mit kurbelwellenseitigen Aussparungen [2] A = 41.450</p>	<p>8</p> <p>08-109800-00 STD 08-109807-00 0.50mm 08-109811-00 1.00mm</p> <p>1.75 CR P 2.00 CR P 3.00 CR P</p> <p>[1] Avec évidements côté vilebrequin [2] A = 41.450</p>
	<p>9</p> <p>14-021571-00 D B 79.56 C 142.00 D 82.50 E 4.50 14-028360-00 D [1] B 79.50 C 145.00 D 81.50 E 4.70</p> <p>10</p> <p>[1] Con nicchie sul lato albero motore [2] A = 41.450</p> <p>[1] Con escotaduras en la cara del cigüeñal [2] A = 41.450</p>

- 1** Panel no.
- 2** Bore size
- 3** Engine detail
- 4** Model detail
- 5** TecDoc / F-M engine no.
- 6** Corresponding top engine panel number
- 7** Piston reference
 - A = Compression height
 - B = Bowl depth / Crown height
 - BØ = Bowl diameter
 - C = Valve pocket depth
 - D = Length
 - RT = Alfin insert
 - KK = Oil cooling gallery
 - AK = Oil jet cut-out
 - HA = hard anodised coating on crown
 - NB = Bronze pin bush
 - TP = Trapezoidal Conrod

- 8** Ring set reference
 - Ring width
 - Ring design
 - Ring surface treatment
- 9** Liner reference
 - B = Outer diameter
 - C = Overall length
 - D = Flange diameter
 - E = Flange width
 - F = Firelip height
- 10** Liner type
 - D = Dry
 - WH = Wet Honed
 - DH = Dry Honed
- 11** Piston image and casting number (if applicable)
- 12** Footnote

HOW TO USE THIS CATALOGUE



VW GROUP										
1	99	2	Diesel							
3	CY	4 Cyl.	23/23.5:1	1588cc	51kW (70)PS	5 TD4052 45 6				
4	GOLF	03/82→07/83	JETTA	03/82→02/84	PASSAT	04/82→03/88				
	SANTANA	12/81→12/84								
7	8	9	10	11	12	13	14	15	16	
BE/PL	4	47.758/47.778	50.600/50.619	19.000	1.406	0.020/0.074	EC	71-3442	71-3442/4 STD 0.25 0.50 0.75	
MB/HL 1,2,4,5	8	53.958/53.978	59.000/59.019	18.500	2.502	0.020/0.082	AL-LF	02-3085U	H024/5 STD 0.25	
MB/HL 3	2	53.958/53.978	59.000/59.019	24.930	2.502	0.020/0.082	AL-LF	02-3086HU		
TW/A	2	59.500	73.200		1.975		AL-LF	04-3527	A123/4 STD	
TW/A	2	59.500	73.200		1.975		AL-LF	04-3528		
SE/PB	1	24.000/24.012	27.000/27.021	25.000			BC	55-3443	55-3443 SEMI	
CB/NWB 1-5	5	25.939/25.960	28.250/28.271	17.000	1.138		AL-LF	03-3317	N118/5 STD	

- 1** Panel no.
- 2** Bore size
- 3** Engine detail
- 4** Model detail
- 5** TecDoc / F-M engine no.
- 6** Corresponding top engine panel number
- 7** Bearing type and position
BE/PL = Connecting rod (big end) bearing
MB/HL = Main bearing
TW/A = Thrust washer
SE/PB = Piston pin (small end) bushing
CB/NWB = Camshaft bushing
BU = Other bushings
- 8** Set composition
- 9** Minimum and maximum standard journal diameter
- 10** Minimum and maximum housing bore diameter
- 11** Maximum bearing width
- 12** Maximum standard wall thickness
- 13** Oil clearance
- 14** Bearing material codes
AL = Steel back aluminium.....Bi-/Trimetallic
B = Brass
BB = Steel back babbit.....Bimetallic
BC = Steel back cast bronze - no overlay.....Bimetallic
BS = Steel back sintered bronze - no overlay...Bi-/Trimetallic
EC = Steel back bronze - electrocoated.....Trimetallic
SP = Steel back bronze - Sputter.....Trimetallic
IX = Steel back aluminium - Polymer
-LF= Lead-free
- 15** Component reference
- 16** Glyco set reference and available undersizes
H = Main bearing
N = Camshaft bushing
A = Thrust washer
.../4 = Number of pairs (bearings) or pieces (washers / bushings) per set
...H = Thrust (flange) bearing
- 17** See footnote section

SO BENUTZEN SIE DIESEN KATALOG



VW GROUP

1 92	2 76.50	Petrol			
3 ATN	4 Cyl.	11.5:1	1598cc	77kW (105)PS	5 TD15531 150 6
4 LEON		09/00 → 06/06			
7 	8 	9 	10 	11 	12
TB634 58x17 TB658 26 130x20	TBK246			FOL179 (x16)	FOL167 (x16)
13 B x C x D	OE	MAT.	19	20	21
V94116 14 29.50 x 6.00 x 100.90 V94117 14 26.00 x 6.00 x 100.50 15	036 109 601S 16 036 109 611K	17 18	45°	45°	Y 21 H 22
				23 E x F x G	24
				VAG96073B 14 36.00 x 6.02 x 11.06 25	24

- | | | |
|---|---|---|
| <ul style="list-style-type: none"> 1 Infotafel 2 Bohrung 3 Motordetails 4 Modellangaben 5 TecDoc-Nr. / F-M Motornummer 6 Entsprechende Infotafel für Motorblock 7 Steuerriemen, Teilenummern
Anzahl der Zähne x Riemenbreite 8 Steuerriemensätze, Teilenummern 9 Nockenwellen, Teilenummern | <ul style="list-style-type: none"> 10 Nockenwellensätze, Teilenummern 11 Kipphebel, Teilenummern
(erforderliche Anzahl pro Motor in Klammern) 12 Stößel und Druckstücke, Teilenummern
(erforderliche Anzahl pro Motor in Klammern) 13 Ventile, Teilenummern 14 Einbauseite 15 Ventilabmessungen | <ul style="list-style-type: none"> 16 Ventil-OE-Bezeichnung 17 Materialcode 18 Ventilschaftbeschichtung 19 Kegelstückkonstruktion 20 Sitzwinkel 21 Sitzbehandlung 22 Ventilenendenbehandlung 23 Ventilführungsbezeichnungen 24 Ventilführungsform 25 Ventilführungsabmessungen 26 Siehe Abschnitt »Fußnote« |
|---|---|---|

MATERIALCODE	BAUART	KOPF	SCHAFT	PASSEND FÜR
MB	Monometall	Martensitischer Chrom-Silizium-Legierungsstahl	k. A.	Einlassventile (für Otto- und Dieselmotoren) und für Schäfte in bimetalischen Auslassventile
MD	Monometall	Austenitischer Chrom-Mangan-Nickel-Stahl	k. A.	Auslassventile, Einsatz bis max. 750 °C
ME	Bimetall	Austenitischer Chrom-Mangan-Nickel-Stahl mit Zusatz von Niobium, Wolfram und Stickstoff	MB	Hochleistungs-Auslassventile, Einsatz bis max. 780 °C
MF	Bimetall	Nimonic™, nickelbasierte Superlegierung mit Zusatz von Chrom, Cobalt und Titan	MB	Auslassventile; gute mechanische Festigkeit, Ermüdungsfestigkeit, Erosions- und Korrosionsbeständigkeit Einsatz bis max. 820 °C
MG	Bimetall	MD	MB	Auslassventile, Einsatz bis max. 750 °C

KURZZEICHEN AUSSTATTUNG	BESCHREIBUNG
cr	Chrombeschichteter Ventilschaft
tu	Tufride-behandelter/nitrierter Schaft
ss	Geschweißter Stellitventilsitz
Y	Gehärteter Ventilsitz
st	Geschweißte Stellitspitze
H	Gehärtete Ventilspitze

SO BENUTZEN SIE DIESEN KATALOG



VW GROUP

1 179	2 76.50	Petrol			6
3 AEE	4 Cyl.	9.8:1	1598cc	55kW (75)PS	5 TD13394 75
4 FELICIA	08/95 → 04/02	OCTAVIA	09/96 → 09/04		
7	8	9	10	11	12
BZ180 (MLS), 0.500mm	DZ181		HBS075 M11x1.50x110.00mm (x10)	JD597 JD601	JP074 HM5062
				HR599	NA5001 32.00x47.00x10.00mm FPM
BZ180					

- 1** Infotafel
- 2** Bohrung
- 3** Motordetails
- 4** Modellangaben
- 5** TecDoc-Nr. / F-M Motornummer
- 6** Entsprechende Infotafel für Motorblock
- 7 ZYLINDERKOPFDICHTUNG**
 - = Links
 - = Rechts
 - = Kolbenüberstand
 - 0,50 mm = Dicke
 - 1 Öffnung = Kennzeichnung
- 8 ZYLINDERKOPFDICHTUNGSSATZ**
 - = Ohne Zylinderkopfdichtung
 - = Ohne Dichtringe
 - = Ohne Ventildeckeldichtung
 - = Ohne Ventilschaftdichtringe
- 9 VOLLSTÄNDIGER SATZ**
 - = Ohne Zylinderkopfdichtung
 - = Ohne Dichtringe
 - = Ohne Ventildeckeldichtung
 - = Ohne Ventilschaftdichtringe

10 ZYLINDERKOPFSCHRAUBENSATZ

- Zylinderkopfschrauben-Form
- Außensechskant Innensechskant
- Außenvielzahn Innenvielzahn
- Außentorx Innentorx
- Sechskantbund Außensechskant-Keilzahn (Ribe-CV®)*

*Ribe-CV® ist ein eingetragenes Warenzeichen der Richard Bergner GmbH & Co.

11 AUSPUFFKRÜMMERDICHTUNG

- Links =
- Rechts =
- Satz =
- Einlass =
- Auslass =
- Oben =
- Unten =

12 VENTILDECKELDICHTUNG

- Links =
- Rechts =
- Einlass =
- Auslass =
- Satz =

13 VENTILSCHAFTDICHTUNG

- Satz =
- Einlass =
- Auslass =

14 NOCKENWELLEN-ÖLDICHTUNGEN

- Vorn =
- Hinten =

15 Siehe Abschnitt »Fußnote«



SO BENUTZEN SIE DIESEN KATALOG



VW GROUP

1	99	76.50	Diesel						
3	CY	4 Cyl.	23/23.5:1	1588cc	51kW (70)PS	5	TD4052	45	6
4	GOLF	03/82→07/83	JETTA	03/82→02/84	PASSAT	04/82→03/88			
	SANTANA	12/81→12/84							

7

87-109800-10 STD
87-109807-10 [2] 0.50mm
87-109811-10 [2] 1.00mm

A 41.70
 B- 1.60
 D 71.70
 24x64

11

AK HA RT TP

12

[1] With recesses on crankshaft side
 [2] A = 41.450

8

08-109800-00 STD
08-109807-00 0.50mm
08-109811-00 1.00mm

1.75 CR P
 2.00 CR P
 3.00 CR P

9

14-021571-00 D B 79.56 C 142.00 D 82.50 E 4.50
14-028360-00 D [1] B 79.50 C 145.00 D 81.50 E 4.70

10

[1] Con nicchie sul lato albero motore
 [2] A = 41.450

[1] Con escotaduras en la cara del cigüeñal
 [2] A = 41.450

- 1** Infotafel
- 2** Bohrung
- 3** Motordetails
- 4** Modellangaben
- 5** TecDoc-Nr. / F-M Motornummer
- 6** Entsprechende Infotafel für Zylinderkopf
- 7** Kolben, Teilnummern
 - A = Kompressionshöhe
 - B = Muldentiefe/Bodenhöhe
 - BØ = Muldendurchmesser
 - C = Ventiltaschentiefe
 - D = Länge
 - RT = Alfin-Einsatz
 - KK = Ölkühlkanal
 - AK = Öldüsenausparung
 - HA = Hartanodisierter Kolbenboden
 - NB = Bolzenbuchse aus Bronze
 - TP = Trapezpleuel
- 8** Kolbenringsätze, Teilnummern
 - Ringhöhe
 - Ringbauart
 - Ring-Oberflächenbehandlung
- 9** Laufbuchsen, Teilnummern
 - B = Außendurchmesser
 - C = Gesamtlänge
 - D = Bunddurchmesser
 - E = Bundbreite
 - F = Feuersteghöhe
- 10** Laufbuchsentyp
 - D = trocken
 - WH = nass, gehont
 - DH = trocken, gehont
- 11** Kolbenabbildung und Kokille (falls zutreffend)
- 12** Fußnote

SO BENUTZEN SIE DIESEN KATALOG



VW GROUP

1	99	2	Diesel							5	TD4052	45	6
3	CY	4 Cyl.	23/23.5:1	1588cc			51kW (70)PS						
4	GOLF	03/82→07/83	JETTA		03/82→02/84	PASSAT		04/82→03/88					
	SANTANA	12/81→12/84											
7	8	9	10	11	12	13	14	15	16				
BE/PL	4	47.758/47.778	50.600/50.619	19.000	1.406	0.020/0.074	EC	71-3442	71-3442/4 STD 0.25 0.50 0.75				
MB/HL 1,2,4,5	8	53.958/53.978	59.000/59.019	18.500	2.502	0.020/0.082	AL-LF	02-3085U	H024/5 STD 0.25				
MB/HL 3	2	53.958/53.978	59.000/59.019	24.930	2.502	0.020/0.082	AL-LF	02-3086HU					
TW/A	2	59.500	73.200		1.975		AL-LF	04-3527	A123/4 STD				
TW/A	2	59.500	73.200		1.975		AL-LF	04-3528					
SE/PB	1	24.000/24.012	27.000/27.021	25.000			BC	55-3443	55-3443 SEMI				
CB/NWB 1-5	5	25.939/25.960	28.250/28.271	17.000	1.138		AL-LF	03-3317	N118/5 STD				

- 1** Infotafel
- 2** Bohrung
- 3** Motordetails
- 4** Modellangaben
- 5** TecDoc-Nr. / F-M Motornummer
- 6** Entsprechende Infotafel für Zylinderkopf
- 7** Gleitlager, Art und Position
BE/PL = Pleuell(fuß)lager
MB/HL = Hauptlager
TW/A = Druckscheibe
SE/PB = Pleuel(kopf)buchse
CB/NWB = Nockenwellenbuchse
BU = Andere Buchsen
- 8** Satzbestandteile
- 9** Min. und max. Standard-Zapfendurchmesser
- 10** Min. und max. Gehäusebohrungsdurchmesser
- 11** Max. Gleitlagerbreite
- 12** Max. Standardwandstärke
- 13** Ölspalt

- 14** Gleitlagermaterial-Abkürzungen
AL = Stahlrücken Aluminium.....Bi-/Trimetall
B = Messing
BB = Stahlrücken Babbitt.....Bimetall
BC = Stahlrücken Gussbronze – ohne Auflage.....Bimetall
BS = Stahlrücken Sinterbronze – ohne Auflage.....Bi-/Trimetall
EC = Stahlrücken Bronze – galvanisiert.....Trimetall
SP = Stahlrücken Bronze – Sputter.....Trimetall
IX = Stahlrücken Aluminium – Polymer
-LF= Bleifrei
- 15** Bauteile, Teilenummern
- 16** Glyco-Satz-Teilenummern und erhältliche Untergrößen
H = Hauptlager
N = Nockenwellenbuchse
A = Druckscheibe
.../4 = Anzahl Paare (Gleitlager) oder Stück (Scheiben/
Buchsen) pro Satz
...H = Axial(flansch)lager
- 17** Siehe Abschnitt »Fußnote«



COME SI UTILIZZA IL CATALOGO



VW GROUP

1 92	2 76.50	Petrol			5 TD15531 6 150
3 ATN	4 Cyl.	11.5:1	1598cc	77kW (105)PS	
4 LEON	09/00 → 06/06				
 7	 8 TBK246	 9	 10 KIT	 11 FOL179 (x16)	 12 FOL167 (x16)
TB634 58x17 TB658 26 130x20					
 13 B x C x D	OE	MAT.	 45°	 Y	 H
V94116 14 29.50 x 6.00 x 100.90	036 109 601S	 MB	19	21	22
V94117 14 26.00 x 6.00 x 100.50	036 109 611K	 MG	17 18	20	
15	16			 23 E x F x G	 24
			VAG96073B 14 36.00 x 6.02 x 11.06		
			25 24		

- | | | |
|---|---|--|
| <ul style="list-style-type: none"> 1 N. Pannello 2 Alesaggio 3 Dati motore 4 Dati modello 5 TecDoc / F-M N. motore 6 Numero pannello corrispondente alla parte bassa motore 7 Riferimenti cinghia di distribuzione N.di denti x larghezza cinghia 8 Riferimenti kit cinghia di distribuzione 9 Riferimenti albero a camme | <ul style="list-style-type: none"> 10 Riferimenti kit albero a camme 11 Riferimenti bilanciere (tra parentesi quantità richiesta per motore) 12 Riferimenti punterie e piattelli (tra parentesi quantità richiesta per motore) 13 Riferimenti valvola 14 Posizione di montaggio 15 Dimensioni valvola 16 Riferimento OE valvola | <ul style="list-style-type: none"> 17 Codice materiale 18 Rivestimento stelo valvola 19 Design coppia 20 Angolo sede 21 Trattamento sede 22 Trattamento puntale 23 Riferimenti guidavalvola 24 Forma guidavalvola 25 Dimensioni guidavalvola 26 Consultare la sezione note a piè di pagina |
|---|---|--|

CODICE MATERIALE	TIPO	TESTA	STELO	ADATTO A
MB	Monometallo	Acciaio martensitico cromo-silicio	n/d	Valvole di aspirazione diesel e benzina e per steli in valvole di aspirazione bimetalliche
MD	Monometallo	Acciaio nichel-manganese-cromo Austenitico	n/d	Valvole di scarico per temperature fino a 750°C
ME	Bimetallo	Acciaio nichel-manganese-cromo Austenitico con niobio, tungsteno e azoto in lega	MB	Valvole di scarico per applicazioni pesanti per temperature fino a 780°C
MF	Bimetallo	Nimonic™, lega super a base di nichel con cromo, cobalto e titanio in lega	MB	Valvole di scarico; buona resistenza meccanica, resistenza a fatica, erosione e corrosione. Per temperature fino a 820°C
MG	Bimetallo	MD	MB	Valvole di scarico per temperature fino a 750°C

CODICE CARATTERISTICHE	DESCRIZIONE
cr	Strato di cromo sullo stelo di valvola
tu	Valvola Carbotritura
ss	Sede saldata in stellite
Y	Sede valvola rinforzata
st	Puntale saldato in Stellite
H	Puntale valvola rinforzato

COME SI UTILIZZA IL CATALOGO



VW GROUP						
1 179	2 76.50	Petrol			6	
3 AEE	4 Cyl.	9.8:1	1598cc	55kW (75)PS	5 TD13394	75
4 FELICIA	08/95 → 04/02	OCTAVIA	09/96 → 09/04			
7	8	9	10	11	12	13
BZ180 (MLS), 0.500mm	DZ181		HBS075 15 M11x1.50x110.00mm (x10)	JD597 11 JD601 11	JP074 HM5062 12	HR599 13
						NA5001 32.00x47.00x10.00mm FPM
BZ180						

1 N. Pannello

2 Alesaggio

3 Dati motore

4 Dati modello

5 TecDoc / F-M N. motore

6 Numero pannello corrispondente alla parte superiore del motore

7 GUARNIZIONE TESTA CILINDRO

= Sinistra

= Destra

= Sporgenza pistone

0.50mm = spessore

1 foro = segno di identificazione

8 KIT TESTA

= Senza guarnizione testa cilindro

= Senza guarnizioni

= Senza guarnizione coperchio valvola

= Senza guarnizioni stelo valvola

9 KIT COMPLETO

= Senza guarnizione testa cilindro

= Senza guarnizioni

= Senza guarnizione coperchio valvola

= Senza guarnizioni stelo valvola

10 KIT VITI TESTA

Forma viti testa



Maschio esagonale



Femmina esagonale



Maschio a stella



Femmina a stella



Torx maschio



Torx femmina



Collare esagonale



Femmina scanalata (Ribe-CV®)*

*Ribe-CV® è un marchio registrato di Richard Bergner GmbH & Co.

11 GUARNIZIONE COLLETTORE

Sinistra =

Destra =

Kit =

Aspirazione =

Scarico =

Superiore =

Inferiore =

12 GUARNIZIONE COPERCHIO VALVOLA

Sinistra =

Destra =

Aspirazione =

Scarico =

Kit =

13 GUARNIZIONE STELO VALVOLA

Kit =

Aspirazione =

Scarico =

14 PARAOLIO ALBERO A CAMME

Anteriore =

Posteriore =

15 Consultare la sezione note a piè di pagina



COME SI UTILIZZA IL CATALOGO



VW GROUP

1	99	76.50	Diesel						
3	CY	4 Cyl.	23/23.5:1	1588cc	51kW (70)PS	5	TD4052	45	
4	GOLF SANTANA	03/82→07/83 12/81→12/84	JETTA	03/82→02/84	PASSAT	04/82→03/88			

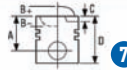

7

87-109800-10 STD
87-109807-10 [2] 0.50mm
87-109811-10 [2] 1.00mm

A 41.70
 B- 1.60
 D 71.70

 **11**
 24x64

AK HA RT TP

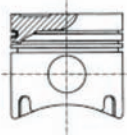

12



[1] With recesses on crankshaft side
 [2] A = 41.450

[1] Mit kurbelwellenseitigen Aussparungen
 [2] A = 41.450



8

08-109800-00 STD
08-109807-00 0.50mm
08-109811-00 1.00mm

1.75  CR P
 2.00  CR P
 3.00  CR P

[1] Avec évidements côté vilebrequin
 [2] A = 41.450



9

14-021571-00 D B 79.56 C 142.00 D 82.50 E 4.50
14-028360-00 D [1] B 79.50 C 145.00 D 81.50 E 4.70

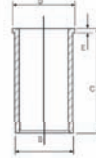

10

[1] Con nicchie sul lato albero motore
 [2] A = 41.450

[1] Con escotaduras en la cara del cigüeñal
 [2] A = 41.450

- 1** N. Pannello
- 2** Alesaggio
- 3** Dati motore
- 4** Dati modello
- 5** TecDoc / F-M N. motore
- 6** Numero pannello corrispondente alla parte superiore del motore
- 7** Codice Pistone
 - A = altezza di compressione
 - B = profondità camera di combustione /sporgenza testa
 - BØ = diametro camera di combustione
 - C = profondità sede valvola
 - D = Lunghezza
 - RT = inserto Alfin
 - KK = galleria di raffreddamento olio
 - AK = nicchia getto olio
 - HA = rivestimento anodizzato sul cielo
 - NB = boccola foro spinotto
 - TP = biella trapezoidale
- 8** Codice set segmenti
 - Larghezza segmento
 - Forma segmento
 - Trattamento superficiale segmento
- 9** Codice canna
 - B = diametro esterno
 - C = lunghezza totale
 - D = diametro flangia
 - E = larghezza flangia
 - F = altezza parafiamma fiamma
- 10** Tipo canna
 - D = A Secco
 - WH = Riportata in Umido
 - DH = Riportata a Secco
- 11** Immagine pistone e numero di fusione (dove applicabile)
- 12** Note a piè di pagina

COME SI UTILIZZA IL CATALOGO



VW GROUP									
1	99	2	76.50	Diesel					
3	CY	4 Cyl.	23/23.5:1	1588cc	51kW (70)PS	5	TD4052	45	6
4	GOLF	03/82→07/83	JETTA	03/82→02/84	PASSAT	04/82→03/88			
	SANTANA	12/81→12/84							
7	8	9	10	11	12	13	14	15	16
BE/PL	4	47.758/47.778	50.600/50.619	19.000	1.406	0.020/0.074	EC	71-3442	71-3442/4 STD 0.25 0.50 0.75
MB/HL 1,2,4,5	8	53.958/53.978	59.000/59.019	18.500	2.502	0.020/0.082	AL-LF	02-3085U	H024/5 STD 0.25
MB/HL 3	2	53.958/53.978	59.000/59.019	24.930	2.502	0.020/0.082	AL-LF	02-3086HU	
TW/A	2	59.500	73.200		1.975		AL-LF	04-3527	A123/4 STD
TW/A	2	59.500	73.200		1.975		AL-LF	04-3528	
SE/PB	1	24.000/24.012	27.000/27.021	25.000			BC	55-3443	55-3443 SEMI
CB/NWB 1-5	5	25.939/25.960	28.250/28.271	17.000	1.138		AL-LF	03-3317	N118/5 STD

1 N. Pannello

2 Alesaggio

3 Dati motore

4 Dati modello

5 TecDoc / F-M N. motore

6 Numero pannello corrispondente alla parte alta motore

7 Tipo e posizione cuscinetto

BE/PL = Cuscinetto (testa di) biella

MB/HL = Cuscinetto di banco

TW/A = Spallamenti

SE/PB = Boccola spinotto pistone (piede di biella)

CB/NWB = Boccola albero a camme

BU = Altre boccole

8 Composizione set

9 Diametro perno di banco standard minimo e massimo

10 Diametro alesaggio sede minimo e massimo

11 Larghezza massima del cuscinetto

12 Spessore parete standard massimo

13 Passaggio olio

14 Codici materiale cuscinetti

AL = Alluminio su supporto in acciaio.....Bi-/Trimetallico

B = Ottone

BB = Lega antiattrito fondo acciaio.....Bimetallico

BC = Bronzo su supporto in acciaio -

no rivestimento.....Bimetallico

BS = Bronzo sinterizzato con supporto in acciaio -

no rivestimento.....Bi-/Trimetallico

EC = Bronzo su supporto in acciaio -

elettrodeposto.....Trimetallico

SP = Bronzo su supporto in acciaio -

processo sputter.....Trimetallico

IX = Alluminio su supporto in acciaio - Polimerico

-LF= Senza piombo

15 Codice componente

16 Codice kit Glyco e misure (sottodimensionate) disponibili

H = Cuscinetto di banco

N = Boccola albero a camme

A = Spallamento

.../4 = Numero coppie (di cuscinetti) o pezzi (spallamenti/ boccole) per ciascun set

...H = Cuscinetto di spinta (flangiato)

17 Consultare la sezione note a piè di pagina



COMMENT SE SERVIR DE CE CATALOGUE



VW GROUP

1 92	2 76.50	Petrol			
3 ATN	4 Cyl.	11.5:1	1598cc	77kW (105)PS	5 TD15531 6 150
4 LEON 09/00 → 06/06					
7 	8 	9 	10 	11 	12
TB634 58x17 TB658 26 130x20	TBK246			FOL179 (x16)	FOL167 (x16)
13 	OE	MAT.	19 	20 45°	21 Y
V94116 14 29.50 x 6.00 x 100.90	036 109 601S	MB	22 H	23 E x F x G	24
V94117 14 26.00 x 6.00 x 100.50	036 109 611K	MG	25		
15	16	17 18			

- | | | |
|--|---|--|
| <ul style="list-style-type: none"> 1 N° d'encadré 2 Taille d'alésage 3 Détail du moteur 4 Détail du modèle 5 Numéro moteur F-M / Numéro TecDoc 6 N° d'encadré bas moteur correspondant 7 Références de courroie de distribution
Nbre de dents x largeur courroie 8 Références de kits de courroie de distribution 9 Références d'arbres à came | <ul style="list-style-type: none"> 10 Références de kit d'arbres à came 11 Références de culbuteur
(quantité moteur exigée entre parenthèses) 12 Références patin de butée et poussoir à tige
(quantité moteur exigée entre parenthèses) 13 Référence de soupape 14 Position de montage 15 Dimensions de soupape 16 Référence OE de soupape | <ul style="list-style-type: none"> 17 Code du matériau 18 Revêtement de la tige de soupape 19 Modèle à gouille 20 Angle du siège 21 Traitement du siège 22 Traitement de pointe 23 Référence du guide de soupape 24 Forme du guide de soupape 25 Dimensions du guide de soupape 26 Voir notes en bas de page |
|--|---|--|

CODE DU MATÉRIAU	TYPE	TÊTE	TIGE	VALABLE POUR
MB	Mono-métallique	Acier d'alliage silicone-chrome martensitique	S/O	Soupapes d'admission essence et diesel, et pour tiges des soupapes d'échappement bimétallique
MD	Mono-métallique	Acier nickel - manganèse - chrome austénitique	S/O	Soupapes d'échappement fonctionnant jusqu'à 750 °C
ME	Bimétallique	Acier nickel - manganèse - chrome austénitique avec niobium, tungstène et azote ajouté.	MB	Soupapes d'échappement haut de gamme fonctionnant jusqu'à 780 °C
MF	Bimétallique	Nimonic™, super alliage à base de nickel avec ajout de chrome, cobalt et titane.	MB	Soupapes d'échappement ; bonne résistance mécanique, à la fatigue, à l'érosion et à la corrosion. Fonctionnant jusqu'à 820 °C
MG	Bimétallique	MD	MB	Soupapes d'échappement fonctionnant jusqu'à 750 °C

CODE CARACTÉRISTIQUE	DESCRIPTION
cr	Couche de chrome sur tige de soupape
tu	Soupape Nitrurée
ss	Siège soudé Stellite
Y	Siège de soupape durci
st	Pointe soudée Stellite
H	Pointe de soupape durcie

COMMENT SE SERVIR DE CE CATALOGUE



VW GROUP

1 179	2 76.50	Petrol			
3 AEE	4 Cyl.	9.8:1	1598cc	55kW (75)PS	5 TD13394 6 75
4 FELICIA	08/95 → 04/02	OCTAVIA	09/96 → 09/04		

7

8

9

10

11

12

13

14

BZ180 (MLS), 0.500mm	DZ181		HBS075 M11x1.50x110.00mm (x10)	JD597 JD601	JP074 HM5062	HR599 NA5001 32.00x47.00x10.00mm FPM
-----------------------------	--------------	--	--	------------------------------	-------------------------------	--

BZ180

1 N° d'encadré

2 Taille d'alésage

3 Détail du moteur

4 Détail du modèle

5 Numéro moteur F-M / Numéro TecDoc

6 N° d'encadré bas moteur correspondant

7 JOINT DE CULASSE

= Gauche

= Droite

= Saillie piston

0,50 mm = épaisseur

1 trou = marque d'identification

8 ENSEMBLE CULASSE

= Sans joint de culasse

= Sans bagues d'étanchéité

= Sans joint de couvre culasse

= Sans joints de tige de soupape

9 ENSEMBLE COMPLET

= Sans joint de culasse

= Sans bagues d'étanchéité

= Sans joint de couvre culasse

= Sans joints de tige de soupape

10 JEU VIS DE CULASSE

Forme de vis de culasse



Hexagonale



Hexagonale type "Allen"



Cannelée



Cannelée intérieure / femelle



Etoile "Tork" mâle



Etoile "Tork" intérieure / femelle



Vis hexagonale à embase



Femelle à cannelure (Ribe-CV)*

11 JOINT COLLECTEUR

Gauche =

Droite =

Jeu =

Admission =

Échappement =

Supérieur =

Inférieur =

12 JOINT DE COUVRE CULASSE

Gauche =

Droite =

Admission =

Échappement =

Jeu =

13 JOINT DE TIGE DE SOUPE

Jeu =

Admission =

Échappement =

14 BAGUES D'ÉTANCHÉITÉ D'ARBRE À CAMES

Avant =

Arrière =

15 Voir notes en bas de page

*Ribe-CV® est une marque enregistrée de Richard Bergner GmbH & Co.



COMMENT SE SERVIR DE CE CATALOGUE



VW GROUP

1	99	76.50	Diesel				
3	CY	4 Cyl.	23/23.5:1	1588cc	51kW (70)PS	5	TD4052 45 6
4	GOLF	03/82→07/83	JETTA	03/82→02/84	PASSAT	04/82→03/88	
	SANTANA	12/81→12/84					

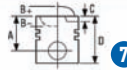

7

87-109800-10 STD
87-109807-10 [2] 0.50mm
87-109811-10 [2] 1.00mm

A 41.70
 B- 1.60
 D 71.70
 Bø 24x64

11

AK HA RT TP

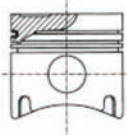

12

[1] With recesses on crankshaft side
 [2] A = 41.450



8

08-109800-00 STD
08-109807-00 0.50mm
08-109811-00 1.00mm

1.75 CR P
 2.00 CR P
 3.00 CR P

[1] Avec évidements côté vilebrequin
 [2] A = 41.450



9

14-021571-00 D B 79.56 C 142.00 D 82.50 E 4.50
14-028360-00 D [1] B 79.50 C 145.00 D 81.50 E 4.70

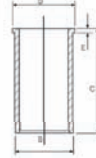

10

[1] Con nicchie sul lato albero motore
 [2] A = 41.450

[1] Con escotaduras en la cara del cigüeñal
 [2] A = 41.450

- 1** N° d'encadré
- 2** Taille d'alésage
- 3** Détail du moteur
- 4** Détail du modèle
- 5** Numéro moteur F-M / Numéro TecDoc
- 6** N° d'encadré haut moteur correspondant
- 7** Référence du piston
 - A = Hauteur d'axe
 - B = Profondeur de la chambre / Hauteur du bossage
 - Bø = Diamètre de la chambre du piston
 - C = Passage de la soupape
 - D = Longueur totale
 - RT = Piston à porte-segments
 - KK = Canal de refroidissement
 - AK = Dégagement pour gicleur d'huile de refroidissement
 - HA = Tête endurcie par oxydation
 - NB = Bague en bronze
 - TP = Bielle trapézoïdale
- 8** Référence du jeu de segments
 - Largeur de segment
 - Schémas des segments
 - Traitement de surface
- 9** Référence de chemise
 - B = Diamètre extérieur
 - C = Longueur totale
 - D = Diamètre bride
 - E = Largeur de collerette
 - F = Hauteur de parefeu
- 10** Type chemise
 - D = Sèche
 - WH = Traitée au sable humide
 - DH = Traitée au sable sec
- 11** Image piston et numéro coquille (le cas échéant)
- 12** Note de bas de page

COMMENT SE SERVIR DE CE CATALOGUE



VW GROUP										
1	99	76.50	2	Diesel						
3	CY	4 Cyl.	23/23.5:1	1588cc	51kW (70)PS		5 TD4052 45 6			
4	GOLF	03/82→07/83	JETTA		03/82→02/84	PASSAT		04/82→03/88		
	SANTANA	12/81→12/84								
7	8	9	10	11	12	13	14	15	16	
BE/PL	4	47.758/47.778	50.600/50.619	19.000	1.406	0.020/0.074	EC	71-3442	71-3442/4 STD 0.25 0.50 0.75	
MB/HL 1,2,4,5	8	53.958/53.978	59.000/59.019	18.500	2.502	0.020/0.082	AL-LF	02-3085U	H024/5 STD 0.25	
MB/HL 3	2	53.958/53.978	59.000/59.019	24.930	2.502	0.020/0.082	AL-LF	02-3086HU		
TW/A	2	59.500	73.200		1.975		AL-LF	04-3527	A123/4 STD	
TW/A	2	59.500	73.200		1.975		AL-LF	04-3528		
SE/PB	1	24.000/24.012	27.000/27.021	25.000			BC	55-3443	55-3443 SEMI	
CB/NWB 1-5	5	25.939/25.960	28.250/28.271	17.000	1.138		AL-LF	03-3317	N118/5 STD	

1 N° d'encadré

2 Taille d'alésage

3 Détail du moteur

4 Détail du modèle

5 Numéro moteur F-M / Numéro TecDoc

6 N° d'encadré haut moteur correspondant

7 Type et emplacement du coussinet

BE/PL = Coussinet de bielle (tête de bielle)

MB/HL = Coussinet de palier

TW/A = Flasque de butée

SE/PB = Bague de bielle

CB/NWB = Bague d'arbre à cames

BU = Autres bagues

8 Composition du jeu de coussinet

9 Diamètre minimum et maximum de maneton standard

10 Diamètre minimum et maximum d'alésage du logement

11 Largeur maximale de coussinet

12 Épaisseur maximale de standard

13 Jeu de fonctionnement

14 Codification des matériaux de coussinets

AL = Aluminium sur support acier.....Bi/trimétallique

B = Laiton

BB = Etain-plomb sur support acier.....Bimétallique

BC = Bronze coulé sur support acier -

sans revêtement.....Bimétallique

BS = Bronze fritté sur support acier -

sans revêtement.....Bi/trimétallique

EC = Bronze sur support acier - électrolytique

.....Trimétallique

SP = Bronze sur support acier - pulvérisé.....Trimétallique

IX = Aluminium sur support acier - polymère

-LF= Sans plomb

15 Référence du composant

16 Référence du jeu Glyco et cotes réparation disponibles

H = Coussinet de palier

N = Bague d'arbre à cames

A = Flasque de butée

.../4 = Paires (coussinets) ou pièces (flasques de butées/
bagues) par jeu

...H = Roulement de butée (à bride)

17 Voir notes en bas de page



CÓMO UTILIZAR ESTE CATÁLOGO



1		2		3		4		5		6	
92		76.50		Petrol		LEON		TD15531		150	
3		4 Cyl.		11.5:1		1598cc		77kW (105)PS		6	
4		09/00→06/06									
7		8		9		10		11		12	
TB634 58x17 TB658 26 130x20		TBK246				KIT		FOL179 (x16)		FOL167 (x16)	
13		OE		MAT.		45°		Y		H	
V94116 14 29.50 x 6.00 x 100.90		036 109 601S		MB		45°		21		22	
V94117 14 26.00 x 6.00 x 100.50		036 109 611K		MG		20		23		24	
15		16		17		18		25		26	

- 1 N.º panel
- 2 Diámetro del cilindro
- 3 Datos del motor
- 4 Datos del modelo
- 5 Número motor F-M / TecDoc
- 6 Número de panel del motor correspondiente
- 7 Referencias de las correas de distribución
N.º de dientes x anchura de la correa
- 8 Referencias del kit de correas de distribución
- 9 Referencias del árbol de levas
- 10 Referencias del kit de levas
- 11 Referencias de balancín (cantidad necesaria para el motor, entre paréntesis)
- 12 Referencias de pastillas de empuje y taqués (cantidad necesaria para el motor, entre paréntesis)
- 13 Referencias de válvula
- 14 Posición de montaje
- 15 Dimensiones de válvula
- 16 Referencia de equipo original de la válvula
- 17 Referencias
- 18 Revestimiento del vástago de la válvula
- 19 Diseño de la chaveta
- 20 Ángulo del asiento
- 21 Tratamiento del asiento
- 22 Tratamiento de la punta del vástago
- 23 Referencias de la guía de válvula
- 24 Forma de la guía de válvula
- 25 Dimensiones de la guía de válvula
- 26 Consulte la sección a pie de página

REFERENCIA	TIPO	CULATA	VÁSTAGO	ADECUADO PARA
MB	Monometálico	Aleación de acero al cromo-silicio martensítico	N/D	Válvulas de admisión de gasolina y diésel para vástagos de válvulas de escape bimetalicas
MD	Monometálico	Acero austenítico al cromo-manganeso-níquel	N/D	Válvulas de escape que soportan hasta 750 °C
ME	Bimetálico	Acero austenítico al cromo-manganeso-níquel con niobio, tungsteno y nitrógeno	MB	Válvulas de escape para vehículos pesados, rango de temperatura de trabajo de hasta 780 °C
MF	Bimetálico	Nimonic™, superaleación al níquel con cromo, cobalto y titanio	MB	Válvulas de escape de buena resistencia mecánica, con resistencia a la fatiga, la erosión y la corrosión; Rango de temperatura de hasta 820 °C
MG	Bimetálico	MD	MB	Válvulas de escape con rango de temperatura hasta 750 °C

CÓDIGO DE CARACTERÍSTICA	DESCRIPCIÓN
cr	Capa de cromo en el vástago de la válvula
tu	Válvula nitrurada / nitrocarburiada
ss	Asiento Stellite soldado
Y	Asiento de válvula endurecido
st	Punta Stellite soldada
H	Punta de válvula endurecida

CÓMO UTILIZAR ESTE CATÁLOGO



VW GROUP						
1 179	2 76.50	Petrol			6	
3 AEE	4 Cyl.	9.8:1	1598cc	55kW (75)PS	5 TD13394	75
4 FELICIA	08/95→04/02	OCTAVIA	09/96→09/04			
7	8	9	10	11	12	13
BZ180 (MLS), 0.500mm	DZ181		HBS075 15 M11x1.50x110.00mm (x10)	JD597 11 JD601	JP074 HM5062	HR599
						NA5001 32.00x47.00x10.00mm FPM
BZ180						

- 1** N.º panel
- 2** Diámetro del cilindro
- 3** Datos del motor
- 4** Datos del modelo
- 5** Número motor F-M / TecDoc
- 6** Número de panel de la parte inferior del motor correspondiente
- 7** **JUNTA DE CULATA**
 - = Izquierda
 - = Derecha
 - = Protrusión del pistón
 - 0.50 mm = Grosor
 - 1 orificio = Marca de identificación
- 8** **CONJUNTO DE CULATA**
 - = Sin junta de culata
 - = Sin juntas
 - = Sin junta de cubierta de la válvula
 - = Sin juntas del vástago de la válvula
- 9** **CONJUNTO COMPLETO**
 - = Sin junta de culata
 - = Sin juntas
 - = Sin junta de cubierta de la válvula
 - = Sin juntas del vástago de la válvula

10 CONJUNTO DE TORNILLOS DE CULATA

Forma de tornillos



Macho hex.



Hembra hex.



Macho estrella



Hembra estrella



Macho torx



Hembra torx



Hexágono con anillo



Hembra acanalada (Ribe-CV®)*

*Ribe-CV® es una marca comercial registrada de Richard Bergner GmbH & Co.

11 JUNTA DEL COLECTOR

- Izquierda =
- Derecha =
- Conjunto =
- Admisión =
- Escape =
- Parte superior =
- Parte inferior =

12 JUNTA DE CUBIERTA DE LA VÁLVULA

- Izquierda =
- Derecha =
- Admisión =
- Escape =
- Conjunto =

13 JUNTA DEL VÁSTAGO DE LA VÁLVULA

- Conjunto =
- Admisión =
- Escape =

14 RETENES DE ACEITE DEL ÁRBOL DE LEVAS

- Parte delantera =
- Parte trasera =

15 Consulte la sección de pie de página



CÓMO UTILIZAR ESTE CATÁLOGO



VW GROUP

1	99	76.50	Diesel				
3	CY	4 Cyl.	23/23.5:1	1588cc	51kW (70)PS	5	TD4052 45 6
4	GOLF SANTANA	03/82→07/83 12/81→12/84	JETTA	03/82→02/84	PASSAT	04/82→03/88	

7

87-109800-10	STD
87-109807-10 [2]	0.50mm
87-109811-10 [2]	1.00mm

A 41.70
B- 1.60
D 71.70

24x64 **11**

AK HA RT TP

12

[1] With recesses on crankshaft side
[2] A = 41.450

[1] Mit kurbelwellenseitigen Aussparungen
[2] A = 41.450

[1] Avec évidements côté vilebrequin
[2] A = 41.450

8

08-109800-00	STD
08-109807-00	0.50mm
08-109811-00	1.00mm

1.75 CR P
2.00 CR P
3.00 CR P

9

14-021571-00 D B 79.56 C 142.00 D 82.50 E 4.50
14-028360-00 D [1] B 79.50 C 145.00 D 81.50 E 4.70

10

[1] Con nicchie sul lato albero motore
[2] A = 41.450

[1] Con escotaduras en la cara del cigüeñal
[2] A = 41.450

- 1** N.º panel
- 2** Diámetro del cilindro
- 3** Datos del motor
- 4** Datos del modelo
- 5** Número motor F-M / TecDoc
- 6** Número de panel de la parte superior del motor correspondiente
- 7** Referencia del pistón
 - A = Altura de compresión
 - B = Profundidad de la cabeza / Altura de la corona
 - BØ = Diámetro de la cabeza
 - C = Profundidad asiento de válvula
 - D = Longitud
 - RT = Inserción alfin
 - KK = Conductos de refrigeración de aceite
 - AK = Corte del inyector de aceite
 - HA = Revestimiento duro anodizado en la corona
 - NB = Perno de bronce
 - TP = Cabeza de biela trapezoidal
- 8** Referencia del conjunto de segmentos
 - Anchura del segmento
 - Diseño del segmento
 - Tratamiento de la superficie del segmento
- 9** Referencia de la camisa
 - B = Diámetro exterior
 - C = Longitud general
 - D = Diámetro de la brida
 - E = Anchura de la brida
 - F = Altura cortafuego
- 10** Tipo de camisa
 - D = Seca
 - WH = Pulida húmeda
 - DH = Pulida seca
- 11** Número de moldeado e imagen del pistón (si procede)
- 12** Pie de página

CÓMO UTILIZAR ESTE CATÁLOGO



VW GROUP										
1	99	2	76.50	Diesel						
3	CY	4 Cyl.	23/23.5:1	1588cc	51kW (70)PS		5	TD4052	45	6
4	GOLF	03/82→07/83	JETTA	03/82→02/84	PASSAT	04/82→03/88				
	SANTANA	12/81→12/84								
7	8	9	10	11	12	13	14	15	16	
BE/PL	4	47.758/47.778	50.600/50.619	19.000	1.406	0.020/0.074	EC	71-3442	71-3442/4 STD 0.25 0.50 0.75	
MB/HL 1,2,4,5	8	53.958/53.978	59.000/59.019	18.500	2.502	0.020/0.082	AL-LF	02-3085U	H024/5 STD 0.25	
MB/HL 3	2	53.958/53.978	59.000/59.019	24.930	2.502	0.020/0.082	AL-LF	02-3086HU		
TW/A	2	59.500	73.200		1.975		AL-LF	04-3527	A123/4 STD	
TW/A	2	59.500	73.200		1.975		AL-LF	04-3528		
SE/PB	1	24.000/24.012	27.000/27.021	25.000			BC	55-3443	55-3443 SEMI	
CB/NWB 1-5	5	25.939/25.960	28.250/28.271	17.000	1.138		AL-LF	03-3317	N118/5 STD	

- 1 N.º panel
- 2 Diámetro de cilindro
- 3 Datos del motor
- 4 Datos del modelo
- 5 Número motor F-M / TecDoc
- 6 Número de panel de la parte superior del motor correspondiente
- 7 Tipo de cojinete y posición
BE/PL = Cojinete de biela
MB/HL = Cojinete principal
TW/A = Arandela de empuje
SE/PB = Casquillo del bulón
CB/NWB = Casquillo del árbol de levas
BU = Otros casquillos
- 8 Composición del conjunto
- 9 Diámetro de la muñequilla estándar mínimo y máximo
- 10 Diámetro mínimo y máximo de la carcasa
- 11 Anchura máxima del cojinete
- 12 Grosor estándar máximo de la pared
- 13 Paso de aceite

- 14 Códigos del material del cojinete
AL = Aluminio con acero..... Bi/trimetálico
B = Latón
BB = Antifricción con acero..... Bimetálico
BC = Bronce fundido con acero –
sin superposición..... Bimetálico
BS = Bronce aglomerado con acero –
sin superposición..... Bi/trimetálico
EC = Bronce con acero –
revestimiento electrónico..... Trimetálico
SP = Bronce con acero – pulverización catódica..... Trimetálico
IX = Aluminio con acero – polímero
-LF= Sin plomo
- 15 Referencia del componente
- 16 Referencia del conjunto de Glyco y dimensiones disponibles por debajo de la estándar
H = Cojinete de bancada
N = Casquillo del árbol de levas
A = Arandela de empuje
.../4 = Número de pares (cojinetes) o piezas (arandelas/casquillos) por conjunto
...H = Cojinete (brida) de empuje
- 17 Consulte el pie de página en la sección



JAK UŻYWAĆ TEGO KATALOGU



VW GROUP

1 92	2 76.50	Petrol			
3 ATN	4 Cyl.	11.5:1	1598cc	77kW (105)PS	5 TD15531 150 6
4 LEON 09/00→06/06					
 7	 8 TBK246	 9	 10 KIT	 11	 12
TB634 58x17 TB658 26 130x20				FOL179 (x16)	FOL167 (x16)
 13 B x C x D	OE	MAT.	 45°	 Y	 H
V94116 14 29.50 x 6.00 x 100.90 V94117 14 26.00 x 6.00 x 100.50 15	036 109 601S 16 036 109 611K	 17 18	45° 20 45° 20	21 22	 23 E x F x G VAG96073B 14 36.00 x 6.02 x 11.06 25 24

- | | | |
|--|--|--|
| <ul style="list-style-type: none"> 1 Numer 2 Średnica cylindra 3 Dane silnika 4 Model samochodu 5 Nr silnika F-M/TecDoc 6 Odpowiadający numer dotu silnika 7 Referencje paska rozrządu
Liczba zębów x szerokość paska 8 Referencje zestawu paska rozrządu 9 Referencje wałka rozrządu 10 Referencje zestawu krzywek rozrządu | <ul style="list-style-type: none"> 11 Referencje dźwigniłek zaworowych (wymagane ilości na silnik w nawiasach) 12 Referencje popychaczy i płytek oporowych (wymagane ilości na silnik w nawiasach) 13 Referencje zaworów 14 Pozycja montażu 15 Wymiary zaworu 16 Referencje OE zaworu 17 Kod materiału | <ul style="list-style-type: none"> 18 Powłoka trzpienia zaworu 19 Typ klina poprzecznego 20 Kąt gniazda 21 Obróbka gniazda 22 Obróbka końcówki 23 Referencje przewodnicy zaworu 24 Kształt przewodnicy zaworu 25 Wymiary przewodnicy zaworu 26 Zobacz sekcja przypisów |
|--|--|--|

KOD MATERIAŁU	TYP	GŁOWICA	TRZPIEŃ	ZASTOSOWANIE
MB	Monometal	Martensytyczna stal chromowokorzeniowa	nd	Zawory dolotowe w silnikach benzynowych i wysokoprężnych oraz do trzpieni w bimetalicznych zaworach wylotowych
MD	Monometal	Austenityczna stal chromowo-niklowo-manganowa	nd	Zawory wydechowe pracujące w temperaturze do 750°C
ME	Bimetal	Austenityczna stal chromowo-niklowo-manganowa z dodatkiem niobu, wolframu i azotu	MB	Bardzo trwałe zawory wydechowe, pracujące w temperaturze do 780°C
MF	Bimetal	Nimonic™, superstop na bazie niklu z dodatkiem chromu, kobaltu i tytanu	MB	Zawory wydechowe, dobra wytrzymałość mechaniczna, odporność na zmęczenie, erozję i korozję. Praca w temperaturze do 820°C
MG	Bimetal	MD	MB	Zawory wydechowe pracujące w temperaturze do 750°C

KOD CECHY	OPIS
cr	Warstwa chromu na trzpieniu zaworu
tu	Zawór węglazotowany (w procesie Tufftride)/azotowany
ss	Spawane stellite gniazdo
Y	Utwardzone gniazdo zaworu
st	Spawana końcówka stellite
H	Hartowana końcówka zaworu

JAK UŻYWAĆ TEGO KATALOGU



VW GROUP						
1 179	2 76.50	Petrol				
3 AEE	4 Cyl.	9.8:1	1598cc	55kW (75)PS	5 TD13394	6 75
4 FELICIA	08/95 → 04/02	OCTAVIA	09/96 → 09/04			
7	8	9	10	11	12	13
BZ180 (MLS), 0.500mm	DZ181		15 HBS075 M11x1.50x110.00mm (x10)	JD597 JD601	JP074 HM5062	HR599
						14 NA5001 32.00x47.00x10.00mm FPM
BZ180						

1 Numer

2 Średnica cylindra

3 Dane silnika

4 Model samochodu

5 Nr silnika F-M/TecDoc

6 Odpowiadający numer dotu silnika

7 **USZCZELKA POD GŁOWICĘ**

= Lewa

= Prawa

= Występ tłoka

0,50 mm = grubość

1 otwór = oznaczenie identyfikacyjne

8 **ZESTAW GŁOWICY**

= Bez uszczelki głowicy cylindra

= Bez uszczelnień

= Bez uszczelki pokrywy zaworów

= Bez uszczelniaczy zaworowych

9 **PEŁNY ZESTAW**

= Bez uszczelki głowicy cylindra

= Bez uszczelnień

= Bez uszczelki pokrywy zaworów

= Bez uszczelniaczy zaworowych

10 **ZESTAW ŚRUB DO GŁOWICY**

Kształt śruby do głowicy



Sześciokątna wypustowa



Sześciokątna gniazdowa



Gwiazdowa wypustowa



Gwiazdowa gniazdowa



Torx wypustowa



Torx gniazdowa



Sześciokątna kotnierkowa



Wieloklinowa gniazdowa (Ribe-CV®)*

* Ribe-CV® jest zastrzeżonym znakiem handlowym firmy Richard Bergner GmbH & Co.

11 **USZCZELKA KOLEKTORA**

Lewa =

Prawa =

Zestaw =

Dolotowe =

Wydechowe =

Górne =

Dolne =

12 **USZCZELKA POKRYWY ZAWORÓW**

Lewa =

Prawa =

Dolotowe =

Wydechowe =

Zestaw =

13 **USZCZELNIACZ ZAWORU**

Zestaw =

Dolotowe =

Wydechowe =

14 **USZCZELNIENIA OLEJOWE**

WAŁKA ROZRZĄDU

Przód =

Tył =

15 Zobacz sekcja przypisów



JAK UŻYWAĆ TEGO KATALOGU



VW GROUP	
1 99	2 76.50 2 Diesel
3 CY	4 Cyl. 23/23.5:1 1588cc 51kW (70)PS 5 TD4052 45 6
4 GOLF	03/82→07/83 JETTA 03/82→02/84 PASSAT 04/82→03/88
SANTANA	12/81→12/84
7	8
87-109800-10 STD 87-109807-10 [2] 0.50mm 87-109811-10 [2] 1.00mm A 41.70 B- 1.60 D 71.70 24x64 11 AK HA RT TP 12	08-109800-00 STD 08-109807-00 0.50mm 08-109811-00 1.00mm 1.75 CR P 2.00 CR P 3.00 CR P
[1] With recesses on crankshaft side [2] A = 41.450	[1] Mit kurbelwellenseitigen Aussparungen [2] A = 41.450
	9
14-021571-00 D B 79.56 C 142.00 D 82.50 E 4.50 14-028360-00 D [1] B 79.50 C 145.00 D 81.50 E 4.70 10	[1] Con nicchie sul lato albero motore [2] A = 41.450
[1] Avec évidements côté vilebrequin [2] A = 41.450	[1] Con escotaduras en la cara del cigüeñal [2] A = 41.450

- 1** Numer
- 2** Średnica cylindra
- 3** Dane silnika
- 4** Model samochodu
- 5** Nr silnika F-M/TecDoc
- 6** Odpowiadający numer góry silnika
- 7** Dane tłoka
 - A = Wysokość kompresji
 - B = Głębokość czaszy/Wysokość korony
 - BØ = Średnica czaszy
 - C = Głębokość kieszeni zaworu
 - D = Długość
 - RT = Wkładka alfinowa
 - KK = Kanat chłodzenia oleju
 - AK = Wycięcie głowicy olejowej
 - HA = Twarda powłoka anodowana na koronie
 - NB = Tuleja sworznia z brązu
 - TP = Korbwódt trapezowy
- 8** Referencja zestawu pierścieni
 - Szerokość pierścienia
 - Typ pierścienia
 - Obrobka powierzchni pierścienia
- 9** Referencja tulei
 - B = Średnica zewnętrzna
 - C = Długość całkowita
 - D = Średnica kotnierza
 - E = Szerokość kotnierza
 - F = Wysokość krawędzi termicznej
- 10** Typ tulei
 - D = Sucha
 - WH = Honowana na mokro
 - DH = Honowana na sucho
- 11** Obraz tłoka i numer odlewu (jeśli dotyczy)
- 12** Przypis

JAK UŻYWAĆ TEGO KATALOGU



VW GROUP											
1	99	76.50	Diesel								
3	CY	4 Cyl.	23/23.5:1	1588cc	51kW (70)PS			5	TD4052	45	6
4	GOLF	03/82→07/83	JETTA		03/82→02/84		PASSAT		04/82→03/88		
	SANTANA	12/81→12/84									
7	8	9	10	11	12	13	14	15	16		
BE/PL	4	47.758/47.778	50.600/50.619	19.000	1.406	0.020/0.074	EC	71-3442	71-3442/4 STD 0.25 0.50 0.75		
MB/HL 1,2,4,5	8	53.958/53.978	59.000/59.019	18.500	2.502	0.020/0.082	AL-LF	02-3085U	H024/5 STD 0.25		
MB/HL 3	2	53.958/53.978	59.000/59.019	24.930	2.502	0.020/0.082	AL-LF	02-3086HU			
TW/A	2	59.500	73.200		1.975		AL-LF	04-3527	A123/4 STD		
TW/A	2	59.500	73.200		1.975		AL-LF	04-3528			
SE/PB	1	24.000/24.012	27.000/27.021	25.000			BC	55-3443	55-3443 SEMI		
CB/NWB 1-5	5	25.939/25.960	28.250/28.271	17.000	1.138		AL-LF	03-3317	N118/5 STD		

- 1** Numer
- 2** Średnica cylindra
- 3** Dane silnika
- 4** Model samochodu
- 5** Nr silnika F-M/TecDoc
- 6** Odpowiadający numer góry silnika
- 7** Typ i pozycja łożyska
BE/PL = Łożysko stopy korbowodu
MB/HL = Łożysko główne
TW/A = Podkładka oporowa
SE/PB = Panewka sworznia korbowodu
CB/NWB = Panewka wałka rozrządu
BU = Inne panewki
- 8** Skład zestawu
- 9** Minimalna i maksymalna standardowa średnica czopu
- 10** Minimalna i maksymalna średnica otworu obudowy
- 11** Maksymalna szerokość łożyska
- 12** Maksymalna standardowa grubość ścianki
- 13** Szczelina olejowa
- 14** Kody materiału łożyska
AL = Stal z aluminium.....Bi-/trimetaliczne
B = Mosiądz
BB = Stal z babbitem.....Bimetaliczne
BC = Stal z odlewem z brązu – bez pokrycia.....Bimetaliczne
BS = Stal z brązem spiekany – bez pokrycia.....Bi-/trimetaliczne
EC = Stal z brązem – powłokowanie galwaniczne.....Trimetallic
SP = Stal z brązem – Sputer.....Trimetallic
IX = Stal z aluminium - polimer
-LF= Bezotowiove
- 15** Referencje składników
- 16** Referencje zestawu Glyco i dostępne podwymiary
H = Łożysko główne
N = Panewka wałka rozrządu
A = Podkładka oporowa
.../4 = Liczba par (łożysk) lub elementów (podkładek/panewek) na zestaw
...H = Łożysko oporowe (kotnierzowe)
- 17** Zobacz sekcja przypisów

КАК ПОЛЬЗОВАТЬСЯ КАТАЛОГОМ



1		2		3		4		5		6	
92		76.50		Petrol		LEON		TD15531		150	
3		4 Cyl.		11.5:1		1598cc		77kW (105)PS			
7		8		9		10		11		12	
TB634 58x17 TB658 26 130x20		TBK246				KIT		FOL179 (x16)		FOL167 (x16)	
13		OE		MAT.		19		20		21	
V94116 14 29.50 x 6.00 x 100.90		036 109 601S		MB		45°		Y		H	
V94117 14 26.00 x 6.00 x 100.50		036 109 611K		MG		45°		20		22	
15		16		17		18		23		24	
								VAG96073B 14 36.00 x 6.02 x 11.06		25	

- | | | |
|---|--|--|
| 1 № секции | 9 Номер распределительного вала | 17 Код материала |
| 2 Диаметр цилиндра | 10 Номер комплекта распределительного вала | 18 Покрытие штока клапана |
| 3 Информация о двигателе | 11 Номер клапанного коромысла (в скобках - требуемое количество на двигатель) | 19 Конструкция сухаря клапана |
| 4 Информация о модели | 12 Номер толкателя клапана и упорной шайбы (в скобках - требуемое количество на двигатель) | 20 Угол седла |
| 5 TecDoc / FM номер двигателя | 13 Номер клапана | 21 Обработка седла |
| 6 Соответствующий номер информационной секции для нижней части двигателя | 14 Положение установки | 22 Обработка конца штока клапана |
| 7 Номер ремня привода газораспределительного механизма Кол-во зубцов x ширина ремня | 15 Размеры клапана | 23 Номер направляющей втулки клапана |
| 8 Номер комплекта ремня привода газораспределительного механизма | 16 Оригинальный номер клапана | 24 Форма направляющей втулки клапана |
| | | 25 Размеры направляющей втулки клапана |
| | | 26 См. раздел примечаний |

КОД МАТЕРИАЛА	ТИП	ГОЛОВКА	ШТОК	ПОДХОДИТ ДЛЯ
MB	Монометаллический	Мартенситная хромо-кремнистая сталь	нет	Впускные клапаны бензиновых и дизельных двигателей, штоки в биметаллических выпускных клапанах
MD	Монометаллический	Аустенитная хромо-марганцево-никелевая сталь	нет	Выпускные клапаны, функционирующие при температуре до 750°C
ME	Биметаллический	Аустенитная хромо-марганцево-никелевая сталь с добавлением ниобия, вольфрама и азота	MB	Выпускные клапаны для двигателей высокой мощности, функционирующие при температуре до 780°C
MF	Биметаллический	Nimonic™, жаропрочный сплав на основе никеля с добавлением хрома, кобальта и титана	MB	Выпускные клапаны; высокая механическая прочность, сопротивление усталости, эрозии и коррозии. Функционирование при температуре до 820°C
MG	Биметаллический	MD	MB	Выпускные клапаны, функционирующие при температуре до 750°C

ИДЕНТИФИЦИРУЮЩИЙ КОД	ОПИСАНИЕ
cr	Хромовое покрытие штока клапана
tu	Клапан, обработанный газовым нитрированием / азотированием
ss	Стеллитовое седло
Y	Закаленное седло клапана
st	Стеллитовый наконечник
H	Закаленный наконечник клапана

КАК ПОЛЬЗОВАТЬСЯ КАТАЛОГОМ



VW GROUP						
1 179	76.50	Petrol		8		
AEE 3	4 Cyl.	9.8:1	1598cc	55kW (75)PS	5 TD13394	75 6
FELICIA 4	08/95 → 04/02	OCTAVIA	09/96 → 09/04			
7	8	9	10	11	12	13
BZ180 (MLS), 0.500mm	DZ181		HBS075 M11x1.50x110.00mm (x10)	JD597 JD601	JP074 HM5062	HR599
						NA5001 32.00x47.00x10.00mm FPM
BZ180						

1 № секции

2 Диаметр цилиндра

3 Информация о двигателе

4 Информация о модели

5 ТесДос / FM номер двигателя

6 Соответствующий номер информационной секции для нижней части двигателя

7 ПРОКЛАДКА ГОЛОВКИ БЛОКА ЦИЛИНДРОВ

☐ = Левый

☒ = Правый

☒ = Выступ поршня

0,50 мм = толщина

1 отверстие = идентификационная метка

8 КОМПЛЕКТ ГОЛОВКИ БЛОКА ЦИЛИНДРОВ

▲ = Без прокладки головки блока цилиндров

■ = Без сальников

☒ = Без прокладки крышки клапанного механизма

● = Без сальников клапанов

9 ПОЛНЫЙ КОМПЛЕКТ

▲ = Без прокладки головки блока цилиндров

■ = Без сальников

☒ = Без прокладки крышки клапанного механизма

● = Без сальников клапанов

10 КОМПЛЕКТ БОЛТОВ ГОЛОВКИ БЛОКА ЦИЛИНДРОВ

☒ Форма болта головки



☒ Шестигранный с наружной резьбой



☒ Шестигранный с внутренней резьбой



☒ Наружная головка-звездочка



☒ Внутренняя головка-звездочка



☒ Наружная головка torx



☒ Внутренняя головка torx



☒ Шестигранная головка с цилиндрическим буртом



☒ Головка с шлицевым углублением (Ribe-CV)*

*Ribe-CV® является зарегистрированной торговой маркой Richard Bergner GmbH & Co.

11 ПРОКЛАДКА КОЛЛЕКТОРА

Левый = ☐

Правый = ☒

Комплект = ☒

Впуск = ☐

Выпуск = ☒

Верхний = ☐

Нижний = ☒

12 ПРОКЛАДКА КРЫШКИ КЛАПАННОГО МЕХАНИЗМА

Левый = ☐

Правый = ☒

Впуск = ☐

Выпуск = ☒

Комплект = ☒

13 САЛЬНИКИ КЛАПАНОВ

Комплект = ☒

Впуск = ☐

Выпуск = ☒

14 САЛЬНИКИ РАСПРЕДЕЛИТЕЛЬНОГО ВАЛА

Передний = ☐

Задний = ☒

15 См. раздел примечаний



КАК ПОЛЬЗОВАТЬСЯ КАТАЛОГОМ



VW GROUP

1	99	76.50	Diesel				
3	CY	4 Cyl.	23/23.5:1	1588cc	51kW (70)PS	5	TD4052 45 6
4	GOLF SANTANA	03/82→07/83 12/81→12/84	JETTA	03/82→02/84	PASSAT	04/82→03/88	

<p>7</p> <p>87-109800-10 STD 87-109807-10 [2] 0.50mm 87-109811-10 [2] 1.00mm</p> <p>A 41.70 B- 1.60 D 71.70 24x64</p> <p>AK HA RT TP</p> <p>11</p> <p>12</p>	<p>8</p> <p>08-109800-00 STD 08-109807-00 0.50mm 08-109811-00 1.00mm</p> <p>1.75 CR P 2.00 CR P 3.00 CR P</p>	<p>9</p> <p>14-021571-00 D B 79.56 C 142.00 D 82.50 E 4.50 14-028360-00 D [1] B 79.50 C 145.00 D 81.50 E 4.70</p> <p>10</p>
---	--	---

[1] With recesses on crankshaft side [1] Mit kurbelwellenseitigen Aussparungen [1] Avec évidements côté vilebrequin [1] Con nicchie sul lato albero motore [1] Con escotaduras en la cara del cigüeñal
[2] A = 41.450 [2] A = 41.450 [2] A = 41.450 [2] A = 41.450 [2] A = 41.450

- 1** № секции
- 2** Диаметр цилиндра
- 3** Информация о двигателе
- 4** Информация о модели
- 5** TecDoc / FM номер двигателя
- 6** Соответствующий номер информационной секции для верхней части двигателя
- 7** Артикул и спецификация поршня
 - A = высота сжатия
 - B = глубина выемки / высота головки
 - \varnothing = диаметр выемки
 - C = глубина выемки под клапан
 - D = длина
 - RT = с усилителем канавки верхнего поршневого кольца Alfin
 - KK = с каналом масляного охлаждения
 - AK = с пазом/фаской для масляной форсунки
 - HA = головка с твердым анодированным покрытием
 - NB = с бронзовой втулкой поршневого пальца
 - TP = трапециевидный шатун
- 8** Информация о комплекте колец
 - Ширина кольца
 - Конструкция кольца
 - Обработка поверхности кольца
- 9** Информация о гильзе
 - B = внешний диаметр
 - C = общая длина
 - D = диаметр фланца
 - E = ширина фланца
 - F = высота огнезащитного уплотнения
- 10** Тип гильзы
 - D = "сухая"
 - WH = "мокрая" с хонинговкой
 - DH = "сухая" с хонинговкой
- 11** Изображение поршня и номер отливки (если есть)
- 12** Примечание

КАК ПОЛЬЗОВАТЬСЯ КАТАЛОГОМ



VW GROUP											
1	99	2	Diesel								
3	CY	4 Cyl.	23/23.5:1	1588cc	51kW (70)PS		5 TD4052 45 6				
4	GOLF	03/82→07/83	JETTA		03/82→02/84	PASSAT		04/82→03/88			
	SANTANA	12/81→12/84									
7	8	9	10	11	12	13	14	15	16		
BE/PL	4	47.758/47.778	50.600/50.619	19.000	1.406	0.020/0.074	EC	71-3442	71-3442/4 STD 0.25 0.50 0.75		
MB/HL 1,2,4,5	8	53.958/53.978	59.000/59.019	18.500	2.502	0.020/0.082	AL-LF	02-3085U	H024/5 STD 0.25		
MB/HL 3	2	53.958/53.978	59.000/59.019	24.930	2.502	0.020/0.082	AL-LF	02-3086HU			
TW/A	2	59.500	73.200		1.975		AL-LF	04-3527	A123/4 STD		
TW/A	2	59.500	73.200		1.975		AL-LF	04-3528			
SE/PB	1	24.000/24.012	27.000/27.021	25.000			BC	55-3443	55-3443 SEMI		
CB/NWB 1-5	5	25.939/25.960	28.250/28.271	17.000	1.138		AL-LF	03-3317	N118/5 STD		

- 1** № секции
- 2** Диаметр цилиндра
- 3** Информация о двигателе
- 4** Информация о модели
- 5** TecDoc / FM номер двигателя
- 6** Соответствующий номер информационной секции для верхней части двигателя
- 7** Тип подшипника скольжения и его положение
BE/PL = Шатунный вкладыш (большая головка шатуна)
MB/HL = Коренной вкладыш
TW/A = Упорная шайба
SE/PB = Втулка поршневого пальца (малая головка шатуна)
CB/NWB = Втулка распределительного вала
BU = Другие втулки
- 8** Состав комплекта
- 9** Диаметр шейки вала (стандартный): приведены размеры минимального и максимального диаметра шейки вала
- 10** Диаметр постели подшипника: приведены размеры минимального и максимального диаметра постели подшипника
- 11** Максимальная ширина подшипника
- 12** Максимальное значение стандартной толщины стенки
- 13** Масляный зазор
- 14** Коды материала подшипников скольжения
AL = Алюминий на стальной подложке.....Би-/триметаллический
B = Латунь
BB = Баббит на стальной подложке.....Биметаллический
BC = Литая бронза на стальной подложке - без покрытия.....Биметаллический
BS = Спеченная бронза на стальной подложке - без покрытия.....Би-/триметаллический
EC = Бронза на стальной подложке - покрытие методом электроосаждения.....Триметаллический
SP = Бронза на стальной подложке со спаттерным напылением.....Триметаллический
IX = Алюминий на стальной подложке - с полимерным покрытием
-LF= Не содержит свинец
- 15** Номер детали
- 16** Номер комплекта Glyco и доступные ремонтные размеры
H = Коренной вкладыш
N = Втулка распределительного вала
A = Упорная шайба
.../4 = Количество пар (подшипников скольжения) или штук (шайб/втулок) в комплекте
...H = Упорный (фланцевый) подшипник скольжения
- 17** См. раздел примечаний

كيفية استخدام هذا الكتالوج



1 92		2 76.50		Petrol		VW GROUP	
3 ATN	4 Cyl.	11.5:1	1598cc	77kW (105)PS	5 TD15531	150	6
4 LEON		09/00→06/06					
7	8	9	10	11	12		
TB634 58x17 TB658 26 130x20	TBK246		KIT	FOL179 (x16)	FOL167 (x16)		
13 B x C x D	OE	MAT.	19	20	21	22	23
V94116 14 29.50 x 6.00 x 100.90	036 109 601S	MB	45°	Y	H		24
V94117 14 26.00 x 6.00 x 100.50	036 109 611K	MG	45°				25
15	16	17	18	E x F x G		VAG96073B 14 36.00 x 6.02 x 11.06	

- 18 تغطية ساق الصمام
- تصميم الإسفين
- 20 زاوية المقعد
- 21 معالجة المقعد
- 22 معالجة الرأس
- 23 مرجع موجه الصمام
- 24 شكل موجه الصمام
- 25 أبعاد موجه الصمام
- 26 انظر قسم الهوامش

- 10 مراجع طاقم الكامات
- 11 مراجع ذراع مترجحة
- (حجم المحرك المطلوب في الدعامات)
- مراجعة مخدة الصمام والغمازة
- (حجم المحرك المطلوب في الدعامات)
- مراجع الصمام
- 14 وضع التثبيت
- 15 أبعاد الصمام
- مرجع صمام المعدات الأصلية
- كود المادة

- 1 رقم اللوحة
- 2 حجم التجوي
- 3 تفاصيل المح
- 4 تفاصيل الطر
- 5 مستند المواصفات / رقم محرك FM
- رقم لوحة المحركة السفلية المطاب
- 7 مراجع حزام التنوي
- عدد الأسنان x عرض الحزام
- 8 مراجع طاقم حزام التنوي
- 9 مراجع عمود الكامات

الوصف	كود الخاصية
طبقة الكروم في ساق الصمام	cr
صمامات التروجين / الطف البركاني	tu
مقعد ملحوم بالإستيللايت	ss
مقعد صمام مقوى	Y
رأس ملحوم بالإستيللايت	st
رأس صمام مقوى	H

كود المواد	نوع	الرأس	الساق	مناسب من أجل
MB	المعدن الأحادي	سبيكة فولاذية من الكروم مارتينيسي	غير مطبق	صمامات سحب الديزل والبنترول وسيفان صمامات العادم ثنائية المعدن
MD	المعدن الأحادي	صمامات سحب الديزل والبنترول وسيفان صمامات العادم ثنائية المعدن	غير مطبق	صمامات العادم التي تعمل عند درجة حرارة 750 درجة مئوية
ME	المعدن الثنائي	سبيكة فولاذية من الكروم والنيكل والمنجنيز الأوستيني مع النيوبيوم والتنجستن والتروجين الإضاف	MB	صمامات عوادم الخدمة الشاقة التي تعمل عند درجة حرارة 780 درجة مئوية
MF	المعدن الثنائي	هي سبيكة ممتازة من Nimonic™ سبيكة النيكل مع الكروم والكوبالت والتيتانيوم	MB	صمامات العوادم، القوة الميكانيكية الجيدة، مقاومة الكلال والتآكل والصدأ، تعمل عند درجة حرارة 820 درجة مئوية
MG	المعدن الثنائي		MB	صمامات العادم التي تعمل عند درجة حرارة 750 درجة مئوية

كيفية استخدام هذا الكتالوج



VW GROUP

1	179	76.50	2	Petrol	6			
3	AEE	4 Cyl.	9.8:1	1598cc	55kW (75)PS	5	TD13394	75
4	FELICIA	08/95→04/02	OCTAVIA	09/96→09/04				
7	8	9	10	11	12	13	14	
BZ180 (MLS), 0.500mm	DZ181		HBS075 M11x1.50x110.00mm (x10)	JD597 JD601	JP074 HM5062	HR599	NA5001 32.00x47.00x10.00mm FPM	
BZ180								

- 11 جوان المجمع
 = □ أيسر
 = □ أيمن
 = □ مجموعة
 = □ السحب
 العادم
 = □ العلوي
 = □ السفلي
 12 حشية غطاء الصمام
 = □ أيسر
 = □ أيمن
 = □ السحب
 = □ العادم
 = □ مجموعة
 13 سداة ساق الصمام
 = □ مجموعة
 = □ السحب
 = □ العادم
 14 سدادات زيت عمود الكامات
 = □ الأمامية
 = □ الخلفية
 15 انظر قسم الجوان

- 10 مجموعة مسمار ذو ر
 = □ شكل مسمار الرأس



*Ribe-CV®

هي علامة تجارية مسجلة لصالح شركة
 Richard Bergner GmbH & Co.

- 1 رقم اللوحة
 2 حجم التجويف
 3 تفاصيل المحرك
 4 تفاصيل الطراز
 5 F-M مستند المواصفات / رقم محرك
 رقم لوحة المحرك السفلية المطابقة
 7 حشية رأس الأسطوانة
 = □ أيسر
 = □ أيمن
 = □ بروز الكباس
 سمك = (A) مم
 علامة التعريف 1 = فتحة
 8 مجموعة الرأس
 = ▲ بدون حشية رأس الأسطوانة
 = ■ بدون السدادات
 = □ بدون حشية غطاء الصمام
 = ● بدون سدادات ساق الصمام
 مجموعة كاملة
 9 = ▲ بدون حشية رأس الأسطوانة
 = ■ بدون السدادات
 = □ بدون حشية غطاء الصمام
 = ● بدون سدادات ساق الصمام



كيفية استخدام هذا الكتالوج



99		76.50		Diesel		VW GROUP	
3	CY	4 Cyl.	23/23.5:1	1588cc	51kW (70)PS	5	TD4052 45 6
4	GOLF	03/82→07/83	JETTA	03/82→02/84	PASSAT	04/82→03/88	
	SANTANA	12/81→12/84					
<p>87-109800-10 STD</p> <p>87-109807-10 [2] 0.50mm</p> <p>87-109811-10 [2] 1.00mm</p> <p>A 41.70</p> <p>B- 1.60</p> <p>D 71.70</p> <p>24x64</p> <p>AK HA RT TP</p>		<p>08-109800-00 STD</p> <p>08-109807-00 0.50mm</p> <p>08-109811-00 1.00mm</p> <p>1.75 CR P</p> <p>2.00 CR P</p> <p>3.00 CR P</p>		<p>14-021571-00 D B 79.56 C 142.00 D 82.50 E 4.50</p> <p>14-028360-00 D [1] B 79.50 C 145.00 D 81.50 E 4.70</p>		<p>[1] With recesses on crankshaft side</p> <p>[2] A = 41.450</p> <p>[1] Mit kurbelwellenseitigen Aussparungen</p> <p>[2] A = 41.450</p> <p>[1] Avec évidements côté vilebrequin</p> <p>[2] A = 41.450</p> <p>[1] Con nicchie sul lato albero motore</p> <p>[2] A = 41.450</p> <p>[1] Con escotaduras en la cara del cigüeñal</p> <p>[2] A = 41.450</p>	

8 مرجع مجموعة الحلقة

عرض الحلقة

تصميم الحلقة

معالجة سطح الحلقة

مرجع البطانة

B=القطر الخارجي

C=الطول الكلي

D=قطر الشفة

E=عرض الشفة

F=طول شفة الحماية من النيران

10 نوع البطانة

D=جاف

WH=حجر شحذ رطب

DH=حجر شحذ جاف

11 (صورة الكباس ورقم السبيكة) إن وجد

12 الهوامش

1 رقم اللوحة

2 حجم التجوي

3 تفاصيل المح

4 تفاصيل الطر

5 مستند المواصفات / رقم محرك FM

رقم لوحة المحرك السفلية المطاب

7 مراجع حزام التوقي

A=ارتفاع الضغط

B=عمق الغرفة/ارتفاع التاج

BØ=قطر الغرفة

C=عمق جيب الصمام

D=الطول

RT=إدراج ألفين

KK=منصة تبريد الزيت

AK=قطع نفت الزيت

HA=بطانة مؤكسدة قوية على التاج

NB=جلبة بنز برونزي

TP=أبعاد شبه المنحرف

كيفية استخدام هذا الكتالوج



VW GROUP

1	99	76.50	2 Diesel	3	4	5	6			
	CY	4 Cyl.	23/23.5:1	1588cc	51kW (70)PS	TD4052	45			
4	GOLF	03/82→07/83	JETTA	03/82→02/84	PASSAT	04/82→03/88				
	SANTANA	12/81→12/84								
7	8	9	10	11	12	13	14	15	16	17
BE/PL	4	47.758/47.778	50.600/50.619	19.000	1.406	0.020/0.074	EC	71-3442	71-3442/4 STD 0.25 0.50 0.75	
MB/HL 1,2,4,5	8	53.958/53.978	59.000/59.019	18.500	2.502	0.020/0.082	AL-LF	02-3085U	H024/5 STD 0.25	
MB/HL 3	2	53.958/53.978	59.000/59.019	24.930	2.502	0.020/0.082	AL-LF	02-3086HU		
TW/A	2	59.500	73.200		1.975		AL-LF	04-3527	A123/4 STD	
TW/A	2	59.500	73.200		1.975		AL-LF	04-3528		
SE/PB	1	24.000/24.012	27.000/27.021	25.000			BC	55-3443	55-3443 SEMI	
CB/NWB 1-5	5	25.939/25.960	28.250/28.271	17.000	1.138		AL-LF	03-3317	N118/5 STD	11

- 14 رموز مواد المحم
 =AL =ثنائي/ثلاثي المعدن ألومنيوم مظهر بالصلب
 =B =نحاس حاس
 =BB =ثنائي المعدن بابت مظهر بالصلب
 =BC =ثنائي المعدن برونز مصبوب مظهر بالصلب - غير مطلي
 =BS =ثنائي المعدن برونز مصبوب مظهر بالصلب - غير مطلي
 =EC =ثنائي/ثلاثي المعدن برونز مظهر بالصلب - مطلي بالكهرباء
 =SP =ثنائي المعدن بابت مظهر بالصلب
 =IX =ألومنيوم مظهر بالصلب - بوليمر
 =-LF =خالية من الرصاص
 15 مرجع المركب
 والأحجام الأقل المتوفرة Glyco مرجع مجموعة
 =H =محمل رئيسي
 =N =جلبة عمود الكومات
 =A =حلقة دفع
 /...= عدد الأزواج (المحامل) أو القطع (الحلقات/الجلب) لكل مجموعة
 =...H =محمل (شفة) الدفع
 17 انظر قسم الهوامش

- 1 رقم اللوحة
 2 حجم التجويف
 3 تفاصيل المحرك
 4 تفاصيل الطراز
 5 مستند المواصفات / رقم محرك FM
 رقم لوحة المحرك السفلية المطاب
 7 نوع المحمل وموضعه
 =BE/PL =محمل (ذو طرف كبير) قضيب التوصيل
 MB/HL =MB/HL =محمل الرئيسي
 =TW/A =حلقة دفع
 =SE/PB =جلبة (ذات طرف صغير) مسامير الكباس
 =CB/NWB =جلبة عمود الكومات
 =BU =الجلب الأخرى
 8 مجموعة التركيب
 الحد الأدنى والأقصى لقطر المرتكز القياسي
 الحد الأدنى والأقصى للقطر الداخلي لتجويف الحو
 الحد الأقصى لعرض المح
 الحد الأقصى لسماك الحائط القيا
 13 خلوص الزيت



TERMS OF BUSINESS

IMPORTANT



Reproduction of this catalogue or parts thereof is only allowed with our explicit permission in writing. Pictorial representations and design are copyrighted. Claims for damages, of any form whatsoever, resulting from details made in this catalogue or from incorrect use, application, storage or handling, are explicitly excluded. Contractual rights and any resulting or related claims based thereon, irrespective of form, initially come into being on the basis of a separate written agreement, in particular on the basis of our general terms of sale and delivery.

All former statements lose their validity with the publication of this catalogue.

The catalogue is not an operating manual for the use and installation of the engine and sealing parts. It does not contain any advice in a legal sense. The catalogue neither replaces the constantly applicable technical regulations - particularly for tolerances - nor the installation and maintenance stipulations of the individual engine manufacturer.

Also, it is not possible to forego the expertise of those carrying out the installation and application. The individual references made in this catalogue for the installation and the application of the engine and sealing parts are instructions solely for the technically qualified specialist and are to be checked and verified by them for their suitability in each case. Federal-Mogul accepts no responsibility for application decisions.

The contents of the catalogue are not intended to create or substitute any contractual agreement which has to be reserved exclusively to a separate agreement between 2 identified parties, whereby seller can be only one of our Federal-Mogul entities as mentioned on the back cover page.

The right is retained to correct errors and alterations, particularly with regard to amendments in the engine manufacturers details and stipulations.

GESCHÄFTSBEDINGUNGEN – WICHTIGE HINWEISE



Nachdruck, auch auszugsweise, ist nur mit unserer ausdrücklichen schriftlichen Zustimmung gestattet. Die bildlichen Darstellungen und Ausstattungen sind geschützt. Ersatzansprüche, gleich welcher Art, aufgrund der Angaben in diesem Katalog oder auf Grund unsachgemäßem Umgang, unsachgemäßer Verwendung, Lagerung oder Handhabung der angebotenen Produkte, sind ausdrücklich ausgeschlossen. Vertragliche Ansprüche und daraus abgeleitete oder darauf beruhende Ansprüche, gleich welcher Art, kommen erst auf Grund einer besonderen schriftlichen Vereinbarung, insbesondere auf der Grundlage unserer allgemeinen Verkaufs- und Lieferbedingungen, zustande.

Der Katalog ist keine Einbauanleitung für Motorenteile und Dichtungen.

Er enthält keine Beratung im Rechtssinne. Der Katalog ersetzt weder die immer vorrangigen technischen Vorschriften, insbesondere für Toleranzen, sowie die Einbau- und Wartungsvorschriften des jeweiligen Motorenherstellers, noch kann auf das notwendige Fachwissen des die Montage und die Verwendung Durchführenden verzichtet werden. Die in diesem Katalog jeweils gegebenen Hinweise für Einbau und Verwendung der Motorenteile und Dichtungen sind Hinweise ausschließlich für den technisch ausgebildeten und versierten Fachmann, die von ihm im jeweiligen Anwendungsfall auf ihre Eignung geprüft und entschieden werden müssen. Eine Haftung wird von Federal-Mogul für Anwendungsentscheidungen nicht übernommen.

Die Inhalte dieses Katalogs sind nicht dazu bestimmt eine vertragliche Verpflichtung zu begründen oder zu ersetzen, was ausschliesslich einer gesonderten Vereinbarung zwischen 2 konkret bezeichneten Parteien vorbehalten bleibt, wobei der Verkäufer eine unserer Federal-Mogul Gesellschaften sein wird, wie auf der Rückseite des Kataloges.

Die Korrektur von Irrtümern und Änderungen, in besondere auf Grund von geänderten Angaben und Vorschriften der Motorenhersteller, bleibt vorbehalten.

CONDIZIONI GENERALI – IMPORTANTE



La riproduzione di questo catalogo, anche parziale, è permessa soltanto in seguito ad una autorizzazione scritta. I grafici ed i disegni sono marchio depositato. Reclami per difetti, di qualsiasi natura essi siano, relativi al contenuto di questo catalogo, o all'uso improprio di esso, verranno respinti. Le pretese avanzate od i reclami dovranno essere in conformità con le nostre condizioni generali di vendita.

Il presente catalogo annulla e sostituisce tutte le edizioni precedenti.

Il catalogo non è un manuale per l'utilizzo ed il montaggio delle ricambi motore e tenute. Non contiene indicazioni in questo senso. Esso non sostituisce le descrizioni tecniche, sempre prioritarie, in particolare per le tolleranze, ne le istruzioni relative al montaggio ed alla manutenzione date dai costruttori dei rispettivi motori. Non può in nessun caso essere paragonato alla conoscenza professionale necessaria per il montaggio e l'utilizzo. Le considerazioni sul montaggio delle ricambi motore e tenute, fatte su questo catalogo, sono destinate esclusivamente a professionisti con formazione tecnica i quali verificheranno l'esattezza delle informazioni, in ogni caso.

Le responsabilità derivanti dall'utilizzo improprio dello stesso non potranno essere addebitate alla Federal-Mogul.

I contenuti del catalogo non sostituiscono in alcun modo gli accordi contrattuali che sono riservati esclusivamente a due contraenti definiti; come venditore si intende una delle società Federal Mogul menzionate sul retro del catalogo.

Ci riserviamo di apportare correzioni e modifiche, relative, in particolare, a dati o istruzioni ricevute dal costruttore del motore.

CONDITIONS GÉNÉRALES DE VENTE – IMPORTANT



La reproduction de ce catalogue, même partielle, n'est autorisée qu'avec notre accord préalable et par écrit. Les illustrations graphiques et la présentation font l'objet d'un copyright. Nous excluons toutes réclamations ayant pour objet ce catalogue ou pouvant résulter de son incompréhension, portant sur de mauvaises utilisations, manipulations, manutentions ou mauvais stockage. Des droits contractuels et des droits dérivés, de quelque nature qu'ils soient, ne peuvent résulter que d'un accord écrit, particulièrement sur la base de nos conditions générales de ventes et de livraisons.

Ce catalogue annule et remplace toute édition antérieure.

Le catalogue n'est pas une notice d'utilisation et de montage des pièces moteur et joints. Il ne contient pas de directives en tant que telles. Le catalogue ne remplace ni les prescriptions techniques, toujours prioritaires, particulièrement pour les tolérances, ni les prescriptions de montage et d'entretien des constructeurs des moteurs figurant dans ce catalogue. Il ne peut en aucun cas remplacer les connaissances professionnelles nécessaires pour le montage et l'utilisation. Les remarques données pour le montage et l'utilisation des pièces moteur et joints sont exclusivement destinées au professionnel averti et de formation technique, à qui il appartiendra de vérifier la conformité des indications pour chaque cas. La responsabilité des décisions d'utilisation ne peut être prise en charge par Federal-Mogul.

Le contenu de ce catalogue ne peut constituer ou remplacer un contrat qui doit faire l'objet d'un document séparé établi entre 2 parties, dont l'une doit être une entité légale de Federal-Mogul dont la liste figure sur la couverture arrière.

Nous nous réservons le droit d'apporter toutes corrections d'erreurs et modifications, suite notamment à de nouvelles données fournies par les constructeurs.

CONDICIONES DE VENTA – IMPORTANTE



Queda totalmente prohibida la reproducción, total o parcial, del contenido de este catálogo, salvo previa autorización nuestra, realizada por escrito. Están, asimismo, reservados todos los derechos sobre el diseño y presentación del catálogo. No se aceptará ningún tipo de reclamación que esté basada en la interpretación de los datos contenidos en este catálogo, así como en el incorrecto uso, manipulación o almacenaje de nuestras piezas. Únicamente se aceptarán reclamaciones que estén basadas en derechos contractuales o en los motivos arriba indicados, siempre que exista un acuerdo especial y por escrito basado en nuestras condiciones generales de venta y suministro.

Con la edición de este catálogo queda anulada toda la información contenida en catálogos anteriores.

El catálogo no es un manual para el uso e instalación de los piezas de motor y sellado, y no representa una asesoría técnica, en el sentido legal. Los datos del catálogo no sustituyen, en ningún caso, a las especificaciones técnicas, tanto en lo que se refiere a tolerancias como a las instrucciones de instalación y mantenimiento, indicadas por los fabricantes de los motores, especificaciones que serán siempre prioritarias. Se entiende que el uso y montaje de estas piezas está encomendado a personal debidamente cualificado. Las indicaciones sobre uso y montaje de los piezas de motor y sellado contenidas en este catálogo, están exclusivamente dirigidas a profesionales con la debida capacitación y formación técnica, que deben decidir en cada caso sobre la exactitud de las mismas. La responsabilidad de estas decisiones no puede ser, en ningún caso, achacada a Federal-Mogul.

La información facilitada en el catálogo no representa o sustituye ningún tipo de acuerdo, quedando a tal efecto, el acuerdo por separado entre dos partes donde sólo entidades de Federal-Mogul, pueden ser identificadas como la parte vendedora como se menciona en la contraportada.

Los datos e instrucciones contenidos en este catálogo podrán ser corregidos o modificados sin previo aviso.

WARUNKI PROWADZENIA BIZNESU – WAŻNE



Reprodukcja tego katalogu lub jego części jest możliwa tylko za wyraźną zgodą na piśmie. Ilustracje i grafika są chronione prawem autorskim. Roszczenia dotyczące szkód, niezależnie od formy, wynikających z przedstawionych w tym katalogu treści lub z nieprawidłowego użycia, zastosowania, przechowywania lub obsługi są w sposób wyraźny wyłączone. Prawa umowne i inne wynikające lub związane z roszczeniami na nimi opartymi, niezależnie od formy, są tworzone na podstawie oddzielnej umowy pisemnej, w szczególności na podstawie naszych ogólnych warunków sprzedaży i dostawy. Wszystkie wcześniejsze oświadczenia tracą ważność wraz z opublikowaniem tego katalogu.

Katalog nie jest instrukcją użytkowania i montażu części silnikowych i uszczelnień. Nie zawiera porad w sensie prawnym. Katalog nie zastępuje obowiązujących uregulowań technicznych – zwłaszcza w zakresie tolerancji – ani opisów montażu i konserwacji poszczególnych producentów silników. Nie jest również możliwe pominięcie doświadczenia osob dokonujących doboru i przeprowadzających montaż części. Poszczególne odniesienia zawarte w tym katalogu, a dotyczące doboru, montażu i stosowania części silnikowych i uszczelnień, są instrukcjami wyłącznie dla wykwalifikowanego technicznie specjalisty, który w każdym przypadku musi je sprawdzić i zweryfikować ich przydatność. Federal-Mogul nie przyjmuje odpowiedzialności za decyzje dotyczące zastosowania.

Zawartość tego katalogu nie stanowi ani nie zastępuje umowy, która może być zawarta jedynie jako oddzielny dokument podpisany przez dwie strony, przy czym sprzedawcą może być tylko jedna z jednostek koncernu Federal-Mogul, zgodnie z opisem na wewnętrznej stronie tylnej okładki.

Zachowane zostaje prawo korygowania błędów i wprowadzania zmian, zwłaszcza odnośnie zmian dotyczących parametrów i warunków pracy określonych przez producentów silników.

УСЛОВИЯ ДЕЛОВОГО СОТРУДНИЧЕСТВА – ВАЖНО



Копирование данного каталога или его частей допускается исключительно при получении нашего разрешения в письменной форме. Иллюстрации и дизайн защищены авторским правом. Требования о возмещении ущерба любой формы, исходя из содержания каталога или из-за неправильного использования, хранения или обращения, абсолютно исключены. Договорные права и любые результаты или связанные с этим требования, независимо от их формы, должны являться частью отдельного письменного соглашения и основываться на наших общих условиях продаж и поставок.

Все прежние утверждения теряют свою юридическую силу с момента публикации данного каталога.

Каталог не является руководством пользователя и инструкцией по установке деталей двигателя и уплотнения. Он не содержит советов в юридическом понимании этого слова. Каталог не является заменой для издаваемых производителями двигателей технических инструкций по ремонту, в особенности для допусков технических величин, а также инструкций по монтажу и регламентному обслуживанию. Отдельные ссылки для установки и замены деталей двигателя и уплотнения, приведенные в этом каталоге, являются инструкциями исключительно для технических компетентного специалиста и в каждом случае должны быть проверены им на предмет их пригодности. Federal-Mogul не несет ответственность за ремонтные работы.

Содержимое каталога не предназначено для создания или замены любого контрактного соглашения, которое может быть оформлено только в виде отдельного соглашения между двумя установленными сторонами, где продавцом может являться только одно из юридических лиц Federal-Mogul, как упомянуто на внутренней стороне обложки каталога. Federal-Mogul оставляет за собой право вносить исправления и изменения в частности в отношении поправок по деталям изготовителей двигателей и их условиям.



هام

يحظر نسخ أي جزء من هذا الكatalog دون موافقة صريحة كتابية منا. جميع حقوق التصوير والتصميم محفوظة. إن المطالبات بالتعويض عن أي تلفيات من أي نوع مهما كانت، والتي تنتج عن التفاصيل المقدمة بهذا الكatalog أو عن الاستخدام غير الصحيح، أو التطبيق غير السليم أو التخزين أو التعامل مستعبدة هنا بوضوح. تأتي حقوق التعاقد أو أي متطلبات ناتجة أو ذات صلة بالاعتماد على ذلك - بغض النظر عن النموذج - أولاً كي تكون على أساس اتفاق مكتوب منفصل، وعلى وجه الخصوص، على أساس الشروط العامة للبيع والتوصيل

تصبح جميع البيانات السابقة لافية في حالة نشر هذا الكatalog ولا يعد هذا الكatalog دليل تشغيل لاستخدام وتركيب المحرك وقطع غيار الحشية. ولا ينطوي على أي نصيحة ذات معنى قانوني. كما أن هذا الكatalog لا يحل محل التنظيمات الفنية سارية المفعول بصفة دائمة - وبصفة خاصة قدرات التحمل - ولا اشتراطات التركيب والصيانة المحددة من قبل جهة تصنيع المحرك

كما أنه ليس ممكناً الامتناع عن تقديم الخبرة للقائمين بعملية التركيب والتطبيق. إن الإشارات الفردية المقدمة في هذا الكatalog بشأن التركيب والتطبيق المحرك وقطع غيار الحشية وهي إرشادات فقط للمتخصصين المؤهلين فنياً وبنبغي أي مسؤولية تتعلق بمسائل الاستعمال Federal-Mogul عليه مراجعتها والتحقق منها لمناسبتها لكل حالة. لا تتحمل شركة







كما هو مدون على صفحة الغلاف Federal-Mogul لا تستهدف محتويات الكatalog إبرام أي اتفاق تعاقدي يجب الاحتفاظ به أو تبديله باستثناء الاتفاق المنفصل بين الطرفين المحددين، وبناءً عليه لا يكون البائع إلا أحد كيانات شركة الخلفية







الحقوق محفوظة لتصحيح الأخطاء وعمليات التغيير، خاصة فيما يتعلق بالتعديلات الطارئة على تفاصيل واشتراطات جهات تصنيع المحركات







© Federal-Mogul Corporation 2013







The contents of this publication are the copyright of Federal-Mogul Corporation. Unauthorised reproduction in whole or in part is expressly forbidden.













		ccm	X 				9
1B	81.00	2226	5	Petrol	486	971	
1C	76.50	1600	4	Diesel	126	777	
1E	76.50	2382	6	Petrol	135	781	
1F	81.00	1595	4	Petrol	293	867	
1G	76.50	2383	6	Diesel	140	782	
1H	81.00	1781	4	Petrol	334	891	
1V	76.50	1588	4	Diesel	101	759	
1X	79.50	1896	4	Diesel	201	805	
1P	81.00	1781	4	Petrol	335	892	
1S	76.50	2383	6	Diesel	141	783	
1T	81.00	2461	5	Diesel	511	986	
1W	75.00	1398	4	Diesel	45	726	
1Y	79.50	1896	4	Diesel	202	806	
1Z	79.50	1896	4	Diesel	203	807	
2B	81.00	2226	5	Petrol	487	971	
2E	82.50	1984	4	Petrol	573	1007	
2G	75.00	1272	4	Petrol	23	717	
2H	81.00	1781	4	Petrol	336	893	
3A	82.50	1984	4	Petrol	574	1008	
3B	81.00	2226	5	Petrol	488	972	
3D	79.50	2370	5	Diesel	285	865	
3F	75.00	1272	4	Petrol	24	718	
4B	81.00	1781	4	Petrol	337	894	
6A	82.50	1984	4	Petrol	575	1009	
7A	82.50	2309	5	Petrol	631	1030	
9A	82.50	1984	4	Petrol	576	1009	
28B	79.50	1896	4	Diesel	290		
68A	76.50	1588	4	Diesel	130	760	
68C	76.50	1588	4	Diesel	131	760	
122	77.00	1192	4	Petrol		785	
262	81.00	1781	4	Petrol	289		
496	79.50	1588	4	Petrol	291	795	
682	76.50	1471	4	Diesel	127		
685	76.50	1588	4	Diesel	128	760	
686	76.50	1588	4	Diesel	129	760	
AAA	81.00	2792	6	Petrol	553	997	
AAB	79.50	2370	5	Diesel	286	865	
AAC	81.00	1968	4	Petrol	434	947	
AAD	82.50	1984	4	Petrol	577	1010	
AAE	82.50	1984	4	Petrol	578	1011	
AAF	81.00	2459	5	Petrol	503	980	
AAH	82.50	2771	6	Petrol	638	1034	
AAK	75.00	1043	4	Petrol	16	712	
AAM	81.00	1781	4	Petrol	338	895	
AAN	81.00	2226	5	Petrol	489	972	
AAR	82.50	2309	5	Petrol	632	1031	
AAS	79.50	2370	5	Diesel	287	865	
AAT	81.00	2461	5	Diesel	512	986	
AAU	75.00	1043	4	Petrol	17	713	
AAV	75.00	1272	4	Petrol	25	719	
AAZ	79.50	1896	4	Diesel	204	808	
AB	77.00	1285	4	Petrol	149	786	
ABB	81.00	1595	4	Petrol	294	868	
ABC	82.50	2598	6	Petrol	636	1033	
ABD	75.00	1390	4	Petrol	44	714	
ABF	82.50	1984	4	Petrol	579	1012	
ABH	84.50	4172	8	Petrol	675		
ABK	82.50	1984	4	Petrol	580	1007	
ABL	79.50	1896	4	Diesel	205	808	
ABM	81.00	1595	4	Petrol	295	867	
ABN	81.00	1595	4	Petrol	296	867	
ABP	81.00	2461	5	Diesel	513	986	
ABS	81.00	1781	4	Petrol	339	896	
ABT	82.50	1984	4	Petrol	581	1013	
ABU	76.50	1598	4	Petrol	112	769	
ABV	82.00	2861	6	Petrol	568	1005	
ABY	81.00	2226	5	Petrol	490	972	
ABZ	84.50	4172	8	Petrol	676		
AC	77.00	1285	4	Petrol	147	785	
ACC	81.00	1781	4	Petrol	340	897	
ACD	85.50	1584	4	Petrol		1056	
ACE	82.50	1984	4	Petrol	582	1014	
ACK	82.50	2771	6	Petrol	639	1035	
ACL	76.50	2384	6	Diesel	145	782	
ACM	75.00	1043	4	Petrol	18	712	
ACT	76.50	2384	6	Diesel	146	783	
ACU	81.00	2459	5	Petrol	504	980	
ACV	81.00	2461	5	Diesel	514	981	







		ccm	X 			9	
ACZ	82.50	2598	6	Petrol	637		1033
AD	84.00	1584	4	Petrol	661		1043
ADA	81.00	1595	4	Petrol	297		867
ADC	82.50	1984	4	Petrol	583		
ADD	81.00	1781	4	Petrol	341		898
ADE	79.50	1896	4	Diesel	207		809
ADE	79.50	1896	4	Diesel	206		809
ADF	81.00	1781	4	Petrol	298		898
ADG	79.50	1896	4	Diesel	208		810
ADK	76.50	1588	4	Diesel			761
ADL	81.00	1781	4	Petrol	342		898
ADP	81.00	1595	4	Petrol	299		869
ADR	81.00	1781	4	Petrol	343		899
ADU	81.00	2226	5	Petrol	491		972
ADW	82.50	1985	4	Petrol	630		1029
ADX	76.50	1296	4	Petrol	64		731
ADY	82.50	1984	4	Petrol	584		1007
ADZ	81.00	1781	4	Petrol	344		896
AE	85.50	1584	4	Petrol	680		1054
AEA	76.50	1598	4	Petrol	113		770
AEB	81.00	1781	4	Petrol	345		900
AEC	84.50	4172	8	Petrol	677		
AEE	76.50	1598	4	Petrol	114		771
AEF	79.50	1896	4	Diesel	209		806
AEG	82.50	1984	4	Petrol	585		1015
AEH	81.00	1595	4	Petrol	300		870
AEJ	82.50	2771	6	Petrol	640		1035
AEK	81.00	1595	4	Petrol	301		871
AEL	81.00	2461	5	Diesel	515		986
AEM	84.50	4172	8	Petrol	673		
AEN	81.00	2461	5	Petrol	508		985
AEP	82.50	1984	4	Petrol	586		1016
AER	67.10	999	4	Petrol	1		705
AES	81.00	2792	6	Petrol	554		998
AET	81.00	2461	5	Petrol	509		980
AEU	81.00	2459	5	Petrol	505		980
AEV	75.00	1043	4	Petrol	19		714
AEW	84.50	3697	8	Petrol	673		1049
AEX	76.50	1390	4	Petrol	65		732
AEY	79.50	1896	4	Diesel	210		811
AFB	78.30	2496	6	Diesel	150		787
AFC	82.50	2771	6	Petrol	641		1035
AFD	79.50	1896	4	Diesel	196		812
AFF	79.50	1896	4	Diesel	211		807
AFH	76.50	1390	4	Petrol	66		733
AFK	76.50	1390	4	Petrol	67		734
AFM	81.00	2393	6	Petrol	536		995
AFN	79.50	1896	4	Diesel	212		813
AFP	81.00	2792	6	Petrol	537		
AFT	81.00	1595	4	Petrol	292		872
AFX	81.00	1595	4	Petrol	302		
AFY	81.00	1781	4	Petrol	346		901
AGA	81.00	2393	6	Petrol	538		996
AGB	81.00	2671	6	Petrol	547		
AGD	79.50	1896	4	Diesel	213		811
AGE	82.50	2771	6	Petrol	642		1036
AGG	82.50	1984	4	Petrol	587		1017
AGK	93.00	2799	4	Diesel			1060
AGL	90.90	2295	4	Petrol	691		
AGN	81.00	1781	4	Petrol	347		902
AGP	79.50	1896	4	Diesel	214		814
AGR	79.50	1896	4	Diesel	215		815
AGU	81.00	1781	4	Petrol	348		903
AGX	81.00	2459	5	Diesel	506		982
AGZ	81.00	2324	5	Petrol	533		993
AH	85.50	1584	4	Petrol			1054
AHA	82.50	2771	6	Petrol	643		
AHB	79.50	1716	4	Diesel	197		804
AHC	84.50	4172	8	Petrol	673		
AHD	81.00	2459	5	Diesel	506		981
AHF	79.50	1896	4	Diesel	216		816
AHG	79.50	1716	4	Diesel	198		804
AHH	79.50	1896	4	Diesel	217		807
AHL	81.00	1595	4	Petrol	303		873
AHS	76.50	1588	4	Petrol	100		758
AHT	67.10	999	4	Petrol	2		706
AHU	79.50	1896	4	Diesel	218		817
AHW	76.50	1390	4	Petrol	67		735







		ccm					9
AHY	81.00	2461	5	Diesel	516	981	
AJ	85.50	1584	4	Petrol		1054	
AJA	79.50	2370	5	Diesel	288	865	
AJG	81.00	2393	6	Petrol	539	996	
AJH	81.00	1781	4	Petrol	349	904	
AJK	81.00	2671	6	Petrol	548		
AJL	81.00	1781	4	Petrol	350	905	
AJM	79.50	1896	4	Diesel	219	818	
AJP	81.00	1781	4	Petrol	351	906	
AJQ	81.00	1781	4	Petrol	352	905	
AJS	81.00	4921	10	Diesel	564	1002	
AJT	81.00	2461	5	Diesel	517	981	
AJV	76.50	1598	4	Petrol	115	772	
AK	85.50	1584	4	Petrol		1054	
AKC	84.50	3697	8	Petrol		1050	
AKE	78.30	2496	6	Diesel	150	788	
AKF	78.30	3328	8	Diesel	157		
AKG	84.50	4172	8	Petrol	678		
AKK	76.50	1390	4	Petrol	68	736	
AKL	81.00	1595	4	Petrol	304	870	
AKN	78.30	2496	6	Diesel	150	787	
AKP	76.50	1390	4	Petrol	69	737	
AKQ	76.50	1390	4	Petrol	70	734	
AKR	82.50	1984	4	Petrol	588	1018	
AKS	81.00	1588	4	Petrol	292	866	
AKU	79.50	1716	4	Diesel	199	804	
AKV	76.50	1390	4	Petrol	71	738	
AKW	79.50	1716	4	Diesel	200	804	
AL	85.50	1584	4	Petrol		1054	
ALD	67.10	999	4	Petrol	3	707	
ALE	79.50	1896	4	Diesel	220	819	
ALF	81.00	2393	6	Petrol	540	996	
ALG	82.50	2771	6	Petrol	642	1035	
ALH	79.50	1896	4	Diesel	221	807	
ALL	67.10	999	4	Petrol	4	705	
ALM	76.50	1598	4	Petrol	116	773	
ALT	82.50	1984	4	Petrol	589	1019	
ALW	81.00	2393	6	Petrol	541	996	
ALZ	81.00	1595	4	Petrol	305	874	
AM	85.50	1584	4	Petrol		1054	
AMB	81.00	1781	4	Petrol	353		
AMD	75.50	1397	4	Petrol	51		
AME	75.50	1397	4	Petrol	52		
AMF	79.50	1422	3	Diesel	159	792	
AMG	75.50	1289	4	Petrol	46	727	
AMH	75.50	1289	4	Petrol	47	728	
AMJ	75.50	1289	4	Petrol	48	728	
AMK	81.00	1781	4	Petrol	354	907	
AML	81.00	2393	6	Petrol	539	996	
AMM	81.00	2393	6	Petrol	542	996	
AMU	81.00	1781	4	Petrol	355	907	
AMV	81.00	2792	6	Petrol	555	999	
AMX	82.50	2771	6	Petrol	644	1035	
AMY	81.00	2792	6	Petrol	556	998	
AN	93.00	1795	4	Petrol		1059	
ANA	81.00	1595	4	Petrol	306	875	
ANB	81.00	1781	4	Petrol	356	908	
ANC	79.50	1896	4	Diesel	222	820	
ANF	81.00	2461	5	Diesel		987	
ANG	81.00	2461	5	Diesel		987	
ANH	81.00	2461	5	Diesel		987	
ANJ	81.00	2461	5	Diesel	518	981	
ANK	84.50	4172	8	Petrol		1051	
ANM	76.50	1390	4	Petrol	72	739	
ANN	81.00	1781	4	Petrol	357	909	
ANP	81.00	1781	4	Petrol	358	909	
ANQ	81.00	1781	4	Petrol	307		
ANQ	81.00	1781	4	Petrol	359		
ANU	79.50	1896	4	Diesel	223	821	
ANV	67.10	999	4	Petrol	3	707	
ANW	76.50	1390	4	Petrol	73	740	
ANX	76.50	1390	4	Petrol	74	738	
ANY	76.50	1191	3	Diesel	54	730	
AP	93.00	1795	4	Petrol	692	1059	
APA	81.00	2461	5	Diesel	519	981	
APB	81.00	2671	6	Petrol	549		
APC	81.00	2393	6	Petrol	541	996	
APE	76.50	1390	4	Petrol	67	735	







		ccm	X 			9	
APF	81.00	1595	4	Petrol	308		870
APG	81.00	1781	4	Petrol	360		910
APH	81.00	1781	4	Petrol	361		911
APK	82.50	1984	4	Petrol	590		1015
APL	81.00	2461	5	Petrol	509		980
APP	81.00	1781	4	Petrol	352		905
APQ	76.50	1390	4	Petrol	75		738
APR	82.50	2771	6	Petrol	642		1035
APS	81.00	2393	6	Petrol	540		996
APT	81.00	1781	4	Petrol	362		902
APU	81.00	1781	4	Petrol	356		908
APX	81.00	1781	4	Petrol	361		907
APY	81.00	1781	4	Petrol	363		907
APZ	81.00	2393	6	Petrol	543		996
AQA	81.00	1781	4	Petrol	364		905
AQD	82.50	2771	6	Petrol	642		1035
AQE	81.00	1781	4	Petrol	365		906
AQF	84.50	4172	8	Petrol			1051
AQG	84.50	3697	8	Petrol			1050
AQJ	84.50	4172	8	Petrol			1051
AQM	79.50	1896	4	Diesel	224		822
AQN	81.00	2324	5	Petrol	534		994
AQP	81.00	2792	6	Petrol	557		999
AQQ	76.50	1390	4	Petrol	67		735
AQV	72.00	997	4	Petrol	15		711
AQW	75.50	1397	4	Petrol	52		
AQX	81.00	1781	4	Petrol	366		912
AQY	82.50	1984	4	Petrol	590		1015
AQZ	67.10	999	4	Petrol	5		
AR	77.00	1285	4	Petrol	147		785
ARC	76.50	1598	4	Petrol	117		774
ARD	79.50	1896	4	Diesel	225		812
ARE	81.00	2671	6	Petrol	550		
ARG	81.00	1781	4	Petrol	367		902
ARH	81.00	1781	4	Petrol	368		906
ARJ	81.00	2393	6	Petrol	539		996
ARK	81.00	1781	4	Petrol	369		913
ARL	79.50	1896	4	Diesel	226		823
ARM	81.00	1595	4	Petrol	306		876
ARN	81.00	2393	6	Petrol	541		996
ARR	76.50	1390	4	Petrol	76		741
ARS	84.50	4172	8	Petrol			1051
ARV	72.00	997	4	Petrol	15		711
ARX	81.00	1781	4	Petrol	352		914
ARY	81.00	1781	4	Petrol	370		915
ARZ	81.00	1781	4	Petrol	371		903
AS	85.50	1584	4	Petrol	681		1054
ASB	83.00	2967	6	Diesel	656		1038
ASE	81.00	3936	8	Diesel	563		
ASG	84.50	4172	8	Petrol			1051
ASJ	81.00	2671	6	Petrol	549		
ASK	79.50	1896	4	Diesel	227		824
ASM	81.00	2393	6	Petrol	541		996
ASN	82.50	2976	6	Petrol	648		1036
ASV	79.50	1896	4	Diesel	228		816
ASX	79.50	1896	4	Diesel	229		825
ASY	79.50	1896	4	Diesel	230		822
ASZ	79.50	1896	4	Diesel	231		826
AT	93.00	1795	4	Petrol			1059
ATA	93.00	2799	4	Diesel			1060
ATC	81.00	1781	4	Petrol	355		
ATD	79.50	1896	4	Diesel	232		827
ATE	67.10	999	4	Petrol	6		708
ATF	82.50	1984	4	Petrol	591		
ATJ	79.50	1896	4	Diesel	219		828
ATL	79.50	1422	3	Diesel	160		793
ATM	82.50	1984	4	Petrol	592		1020
ATN	76.50	1598	4	Petrol	111		775
ATQ	82.50	2771	6	Petrol	645		1036
ATU	82.50	1984	4	Petrol	593		1021
ATX	82.50	2771	6	Petrol	646		1036
ATZ	75.50	1397	4	Petrol	52		
AUA	76.50	1390	4	Petrol	77		735
AUB	76.50	1390	4	Petrol	67		735
AUC	67.10	999	4	Petrol	3		709
AUD	76.50	1390	4	Petrol	78		736
AUE	81.00	2792	6	Petrol	558		999
AUF	81.00	2461	5	Diesel	520		981







		ccm					9
AUH	93.00	2799	4	Diesel			1060
AUK	84.50	3123	6	Petrol	672		1048
AUL	81.00	1781	4	Petrol	372		907
AUM	81.00	1781	4	Petrol	373		916
AUQ	81.00	1781	4	Petrol	361		916
AUR	81.00	1595	4	Petrol	309		877
AUS	76.50	1598	4	Petrol	111		768
AUW	84.50	4172	8	Petrol			1051
AUX	84.50	4172	8	Petrol			1051
AUY	79.50	1896	4	Diesel	226		829
AUZ	82.50	1984	4	Petrol			1021
AVB	79.50	1896	4	Diesel	233		830
AVC	81.00	1781	4	Petrol	361		917
AVF	79.50	1896	4	Diesel	234		831
AVG	79.50	1896	4	Diesel	235		813
AVH	82.50	1984	4	Petrol	594		
AVJ	81.00	1781	4	Petrol	374		918
AVK	82.50	2976	6	Petrol	649		
AVM	79.50	1896	4	Diesel	236		
AVP	84.50	4172	8	Petrol			1051
AVQ	79.50	1896	4	Diesel	237		832
AVR	81.00	2461	5	Diesel	521		988
AVT	81.00	2461	5	Petrol	510		980
AVU	81.00	1595	4	Petrol	310		875
AVV	81.00	1781	4	Petrol	375		919
AVY	76.50	1598	4	Petrol	118		774
AWA	82.50	1984	4	Petrol	595		1022
AWC	81.00	1781	4	Petrol	349		903
AWD	81.00	1781	4	Petrol			920
AWF	82.50	1984	4	Petrol	596		1021
AWG	82.50	1984	4	Petrol	596		1021
AWH	81.00	1595	4	Petrol	308		878
AWL	81.00	1781	4	Petrol	376		921
AWM	81.00	1781	4	Petrol	377		
AWN	84.50	4172	8	Petrol			1051
AWP	81.00	1781	4	Petrol	378		921
AWT	81.00	1781	4	Petrol	379		916
AWU	81.00	1781	4	Petrol	378		922
AWV	81.00	1781	4	Petrol	380		923
AWX	79.50	1896	4	Diesel	232		831
AWY	76.50	1198	3	Petrol	56		
AXA	82.50	1984	4	Petrol	597		1023
AXB	79.50	1896	4	Diesel	238		833
AXC	79.50	1896	4	Diesel	238		833
AXD	81.00	2461	5	Diesel	522		989
AXE	81.00	2461	5	Diesel	522		989
AXG	81.00	2461	5	Diesel	516		981
AXJ	84.00	3189	6	Petrol	665		1044
AXL	81.00	2461	5	Diesel	523		981
AXP	76.50	1390	4	Petrol	79		734
AXQ	84.50	4172	8	Petrol			1052
AXR	79.50	1896	4	Diesel	239		832
AXU	76.50	1390	4	Petrol	80		742
AXW	82.50	1984	4	Petrol	598		1022
AXX	82.50	1984	4	Petrol	599		
AXZ	86.00	3168	6	Petrol	684		
AYC	81.00	2461	5	Diesel	520		981
AYD	81.00	1595	4	Petrol	311		
AYH	81.00	4921	10	Diesel	564		1002
AYL	81.00	2792	6	Petrol	559		999
AYM	78.30	2496	6	Diesel	151		788
AYP	81.00	1781	4	Petrol	366		912
AYQ	79.50	1896	4	Diesel	240		834
AYS	84.50	4172	8	Petrol	669		
AYT	84.00	3189	6	Petrol	664		1044
AYY	81.00	2461	5	Diesel	517		981
AYZ	76.50	1191	3	Diesel	55		730
AZA	81.00	2671	6	Petrol	548		
AZB	81.00	2671	6	Petrol	551		
AZD	76.50	1598	4	Petrol	119		768
AZE	75.50	1397	4	Petrol	53		
AZF	75.50	1397	4	Petrol	53		
AZG	82.50	1984	4	Petrol	600		
AZH	82.50	1984	4	Petrol	601		1024
AZJ	82.50	1984	4	Petrol	602		1025
AZL	82.50	1984	4	Petrol	603		1026
AZM	82.50	1984	4	Petrol	604		1025
AZN	67.10	999	4	Petrol	5		







		ccm	X 			9	
AZQ	76.50	1198	3	Petrol		57	
AZR	81.00	2671	6	Petrol		549	
AZV	81.00	1968	4	Diesel		435	948
AZX	81.00	2324	5	Petrol		535	994
AZZ	84.00	3189	6	Petrol		664	1044
B	85.50	1584	4	Petrol			1054
BAA	84.00	3189	6	Petrol		664	1044
BAC	81.00	2461	5	Diesel		522	989
BAD	76.50	1598	4	Petrol		120	774
BAE	81.00	1781	4	Petrol		381	
BAF	81.00	1781	4	Petrol		382	
BAG	76.50	1598	4	Petrol		80	774
BAH	76.50	1599	4	Petrol		121	
BAH	76.50	1598	4	Petrol		81	
BAH	76.50	1598	4	Petrol		121	
BAM	81.00	1781	4	Petrol		383	907
BAN	84.00	5998	12	Petrol		668	
BAR	84.50	4163	8	Petrol		671	
BAS	84.50	4172	8	Petrol			1051
BAU	78.30	2496	6	Diesel		152	788
BAY	79.50	1422	3	Diesel		161	792
BBE	81.00	2461	5	Diesel		518	981
BBF	81.00	2461	5	Diesel		518	981
BBG	82.50	2771	6	Petrol		647	1036
BBJ	82.50	2976	6	Petrol		650	
BBM	76.50	1198	3	Petrol		58	
BBR	81.00	2461	5	Diesel		524	988
BBU	81.00	1781	4	Petrol		384	
BBX	82.50	1984	4	Petrol		605	1027
BBY	76.50	1390	4	Petrol		77	735
BBZ	76.50	1390	4	Petrol		67	735
BCA	76.50	1390	4	Petrol		79	743
BCB	76.50	1598	4	Petrol		122	776
BCD	81.00	1595	4	Petrol		385	
BCQ	93.00	2798	4	Diesel			1060
BCS	84.50	4172	8	Petrol		670	
BCT	81.00	2461	5	Diesel			987
BCU	81.00	2461	5	Diesel			987
BCV	81.00	2461	5	Diesel			987
BCZ	78.30	2496	6	Diesel		153	788
BDB	84.00	3189	6	Petrol		664	1044
BDC	82.50	1984	4	Petrol		606	
BDE	81.00	2792	6	Petrol		560	1000
BDF	81.00	2792	6	Petrol		544	
BDG	78.30	2496	6	Diesel		154	789
BDH	78.30	2496	6	Diesel		154	789
BDJ	81.00	1968	4	Diesel		436	949
BDK	81.00	1968	4	Diesel		437	950
BDL	84.00	3189	6	Petrol		664	1044
BDV	81.00	2393	6	Petrol		545	996
BDW	81.00	2393	6	Petrol		546	
BDX	84.50	2773	6	Petrol			1047
BEE	81.00	1968	4	Diesel		438	951
BEF	82.50	1984	4	Gas		607	
BEH	82.50	1984	4	Petrol		608	1027
BEJ	82.50	1984	4	Petrol		609	1027
BEL	81.00	2671	6	Petrol		552	
BEQ	79.50	1896	4	Diesel		241	835
BER	82.50	1984	4	Petrol		609	1027
BES	81.00	2671	6	Petrol		550	
BEU	79.50	1896	4	Diesel		242	836
BEV	82.50	1984	4	Petrol		610	
BEW	79.50	1896	4	Diesel		243	837
BEX	81.00	1781	4	Petrol		386	918
BFB	81.00	1781	4	Petrol		386	918
BFC	78.30	2496	6	Diesel		155	788
BFF	82.50	1984	4	Petrol		611	
BFH	84.00	3189	6	Petrol		664	1044
BFL	84.50	3697	8	Petrol			1051
BFM	84.50	4172	8	Petrol			1051
BFQ	81.00	1595	4	Petrol		312	874
BFS	81.00	1595	4	Petrol		312	879
BFV	81.00	1781	4	Petrol		387	
BGB	82.50	1984	4	Petrol		612	
BGD	82.50	1984	4	Petrol		606	
BGG	79.50	1896	4	Diesel		244	838
BGH	84.50	4172	8	Petrol			1053
BGJ	84.50	4172	8	Petrol			1053







		ccm	X 				9
BGL	79.50	1896	4	Diesel	245	838	
BGM	79.50	1896	4	Diesel	246	838	
BGP	83.60	2480	5	Petrol	660		
BGU	81.00	1595	4	Petrol	313	874	
BGW	81.00	1968	4	Diesel	439	952	
BHC	79.50	1422	3	Diesel	162	792	
BHE	84.00	3189	6	Petrol	664	1044	
BHG	81.00	1781	4	Petrol	388		
BHK	89.00	3597	6	Petrol	689		
BHP	82.50	1984	4	Petrol	609	1027	
BHT	84.00	5998	12	Petrol	667		
BHW	81.00	1968	4	Diesel	439		
BHX	84.50	4172	8	Petrol		1053	
BHZ	82.50	1984	4	Petrol	613		
BJB	79.50	1896	4	Diesel	247	839	
BJC	79.50	1896	4	Diesel	248	835	
BJE	67.10	999	4	Petrol	5		
BJF	81.00	1595	4	Petrol	393		
BJH	81.00	1595	4	Petrol	314		
BJJ	81.00	2461	5	Diesel	525	990	
BJK	81.00	2461	5	Diesel	525	990	
BJL	81.00	2461	5	Diesel	526	991	
BJM	81.00	2461	5	Diesel	527	991	
BJN	84.00	5998	12	Petrol	667		
BJR	67.10	999	4	Petrol	5		
BJS	84.00	3189	6	Petrol		1045	
BJX	81.00	1781	4	Petrol	384		
BJY	81.00	1595	4	Petrol	389		
BKB	81.00	1781	4	Petrol	390	921	
BKC	79.50	1896	4	Diesel	247	840	
BKD	81.00	1968	4	Diesel	440	948	
BKE	79.50	1896	4	Diesel	249	841	
BKF	81.00	1781	4	Petrol	378		
BKG	76.50	1390	4	Petrol	82		
BKH	84.50	3123	6	Petrol	672		
BKJ	84.00	3189	6	Petrol	664	1044	
BKK	84.00	3189	6	Petrol	664	1044	
BKL	84.00	3189	6	Petrol	664	1044	
BKN	83.00	2967	6	Diesel	654	1038	
BKP	81.00	1968	4	Diesel	441	948	
BKR	76.50	1390	4	Petrol	83	744	
BKS	83.00	2967	6	Diesel	654	1041	
BKU	81.00	1781	4	Petrol	391		
BKV	81.00	1781	4	Petrol	392		
BKY	76.50	1390	4	Petrol	79	745	
BLB	81.00	1968	4	Diesel	442	948	
BLE	81.00	4921	10	Diesel	565		
BLF	76.50	1598	4	Petrol	123	774	
BLG	76.50	1390	4	Petrol	84	746	
BLJ	81.00	2461	5	Diesel	528	989	
BLK	81.00	2461	5	Diesel	528	989	
BLM	76.50	1390	4	Petrol		747	
BLN	76.50	1390	4	Petrol	85	746	
BLP	76.50	1598	4	Petrol	85	774	
BLR	82.50	1984	4	Petrol	614	1022	
BLS	79.50	1896	4	Diesel	250	842	
BLT	79.50	1896	4	Diesel	238	843	
BLV	89.00	3597	6	Petrol	689		
BLX	82.50	1984	4	Petrol	614	1022	
BLY	82.50	1984	4	Petrol	614	1022	
BLZ	81.00	1781	4	Petrol	394	922	
BMA	81.00	1968	4	Diesel	435	948	
BMB	82.50	1984	4	Petrol	615	1022	
BMD	76.50	1198	3	Petrol	59		
BME	76.50	1198	3	Petrol	57		
BMJ	84.00	3189	6	Petrol	664	1044	
BMK	83.00	2967	6	Diesel	656	1038	
BML	84.00	3189	6	Petrol	664	1046	
BMM	81.00	1968	4	Diesel	443	954	
BMN	81.00	1968	4	Diesel	444	948	
BMP	81.00	1968	4	Diesel	445	954	
BMR	81.00	1968	4	Diesel	446	948	
BMS	79.50	1422	3	Diesel	163	794	
BMT	79.50	1896	4	Diesel	250	840	
BMV	84.00	3189	6	Petrol	664	1044	
BMX	84.00	3189	6	Petrol	664	1044	
BMY	76.50	1390	4	Petrol	84	746	
BNA	81.00	1968	4	Diesel	447	948	







		ccm	X 			9	
BND	78.30	2496	6	Diesel	156		
BNG	83.00	2967	6	Diesel	656		1041
BNL	82.50	1984	4	Petrol	616		
BNM	79.50	1422	3	Diesel	162		794
BNU	81.00	1781	4	Petrol	395		
BNV	79.50	1422	3	Diesel	162		794
BNX	67.10	999	4	Petrol	5		
BNY	81.00	1781	4	Petrol	315		
BNZ	81.00	2460	5	Diesel	507		983
BPC	81.00	2460	5	Diesel	507		984
BPD	81.00	2461	5	Diesel	529		984
BPE	81.00	2461	5	Diesel	530		984
BPF	84.00	3189	6	Petrol	664		1044
BPG	82.50	1984	4	Petrol	617		
BPJ	82.50	1984	4	Petrol	613		
BPP	83.00	2698	6	Diesel	567		1003
BPW	81.00	1968	4	Diesel	448		954
BPX	79.50	1896	4	Diesel	252		844
BPY	82.50	1984	4	Petrol	613		
BPZ	79.50	1896	4	Diesel	253		845
BRB	79.50	1896	4	Diesel	254		846
BRC	81.00	1968	4	Diesel	449		955
BRD	81.00	1968	4	Diesel	450		956
BRE	81.00	1968	4	Diesel	451		948
BRF	81.00	1968	4	Diesel	447		948
BRJ	84.00	3189	6	Petrol	664		1045
BRK	84.00	3189	6	Petrol	664		1044
BRM	79.50	1896	4	Diesel	255		847
BRN	84.00	5998	12	Petrol	667		
BRR	79.50	1896	4	Diesel	256		848
BRS	79.50	1896	4	Diesel	256		848
BRT	81.00	1968	4	Diesel	452		954
BRU	79.50	1896	4	Diesel	247		849
BRY	81.00	1595	4	Petrol	316		
BSA	81.00	1781	4	Petrol	453		
BSB	84.00	5998	12	Petrol	667		
BSE	81.00	1595	4	Petrol	312		874
BSF	81.00	1595	4	Petrol	312		874
BSG	83.00	2698	6	Diesel	567		1004
BSL	81.00	1781	4	Petrol	396		
BSP	83.00	2967	6	Diesel	657		
BSS	81.00	1968	4	Diesel	454		957
BST	81.00	1968	4	Diesel	436		958
BSU	79.50	1896	4	Diesel	257		849
BSV	79.50	1896	4	Diesel	258		845
BSW	79.50	1896	4	Diesel	259		849
BSX	82.50	1984	4	CNG	627		
BTB	79.50	1896	4	Diesel	238		845
BTE	84.00	5998	12	Petrol	667		
BTL	82.50	1984	4	Petrol	618		
BTS	76.50	1598	4	Petrol	124		774
BTT	84.00	5998	12	Petrol	667		
BUB	84.00	3189	6	Petrol	664		1044
BUD	76.50	1390	4	Petrol	86		748
BUG	83.00	2967	6	Diesel	658		1038
BUJ	84.50	5204	10	Petrol	679		
BUK	79.50	1896	4	Diesel	260		850
BUL	82.50	1984	4	Petrol	619		
BUN	83.00	2967	6	Diesel	654		1041
BUY	81.00	1968	4	Diesel	455		956
BUZ	81.00	1968	4	Diesel	456		956
BVA	81.00	1968	4	Diesel	457		948
BVD	81.00	1968	4	Diesel	562		948
BVE	81.00	1968	4	Diesel	446		948
BVF	81.00	1968	4	Diesel			956
BVG	81.00	1968	4	Diesel	458		956
BVH	81.00	1968	4	Diesel	459		955
BVJ	84.50	4163	8	Petrol	671		
BVK	79.50	1896	4	Diesel	261		851
BVP	81.00	1781	4	Petrol	397		
BVR	81.00	1781	4	Petrol	397		
BVX	82.50	1984	4	Petrol	614		1022
BVY	82.50	1984	4	Petrol	614		1022
BVZ	82.50	1984	4	Petrol	614		1022
BWA	82.50	1984	4	Petrol	620		
BWA1	82.50	1984	4	Petrol	621		
BWB	79.50	1422	3	Diesel	164		794
BWE	82.50	1984	4	Petrol	612		







		ccm					9
BWJ	82.50	1984	4	Petrol	612		
BWK	76.50	1390	4	Petrol	87	749	
BWS	89.00	3597	6	Petrol	689		
BWT	82.50	1984	4	Petrol	612		
BWV	81.00	1968	4	Diesel	460	956	
BWW	82.50	1984	4	Diesel	251		
BWX	81.00	1595	4	Petrol	315		
BXA	84.50	5204	10	Petrol	671		
BXE	79.50	1896	4	Diesel	247	840	
BXF	79.50	1896	4	Diesel	247	840	
BJX	79.50	1896	4	Diesel	250	840	
BXT	79.50	1896	4	Diesel	262	838	
BXV	76.50	1198	3	Petrol	60		
BXW	76.50	1390	4	Petrol	79	750	
BYD	82.50	1984	4	Petrol	613		
BYH	84.50	4163	8	Petrol	674		
BYK	82.50	1984	4	Petrol	622		
BYT	82.50	1798	4	Petrol	569		
BZB	81.00	1798	4	Petrol	433		
BZC	82.50	1984	4	Petrol	613		
BZG	76.50	1198	3	Petrol	57		
CA	90.00	1679	4	Petrol	690		
CAAA	81.00	1968	4	Diesel	461	959	
CAAB	81.00	1968	4	Diesel	462	959	
CAAC	81.00	1968	4	Diesel	462	959	
CAAE	81.00	1968	4	Diesel	462	959	
CABA	82.50	1798	4	Petrol	569		
CABB	82.50	1798	4	Petrol	569		
CABD	82.50	1798	4	Petrol	569		
CADA	82.50	1984	4	Petrol	570		
CAEA	82.50	1984	4	Petrol	569		
CAEB	82.50	1984	4	Petrol	569		
CAGA	81.00	1968	4	Diesel	463	960	
CAGB	81.00	1968	4	Diesel	464	960	
CAGC	81.00	1968	4	Diesel	463	955	
CAHA	81.00	1968	4	Diesel	463	960	
CAHB	81.00	1968	4	Diesel	462	960	
CAJA	84.50	2995	6	Petrol	671		
CAKA	84.50	2995	6	Petrol	671		
CAL	85.50	3197	6	Petrol	683		
CAMA	83.00	2698	6	Diesel	655	1039	
CAMB	83.00	2698	6	Diesel	655	1039	
CANB	83.00	2698	6	Diesel	655		
CANC	83.00	2698	6	Diesel	655		
CAND	83.00	2698	6	Diesel	655	1040	
CAP	83.00	2967	6	Diesel	655	1039	
CARA	83.00	2967	6	Diesel	655		
CARB	83.00	2967	6	Diesel		1039	
CASA	83.00	2967	6	Diesel	655	1039	
CASB	83.00	2967	6	Diesel	655	1041	
CASC	83.00	2967	6	Diesel	655	1039	
CASD	83.00	2967	6	Diesel	655	1042	
CATA	83.00	2967	6	Diesel	655	1041	
CAVA	76.50	1390	4	Petrol	87	749	
CAVB	76.50	1390	4	Petrol	88	749	
CAVC	76.50	1390	4	Petrol	84	749	
CAVD	76.50	1390	4	Petrol	88	749	
CAVE	76.50	1390	4	Petrol	87	751	
CAVF	76.50	1390	4	Petrol	89	751	
CAWA	82.50	1984	4	Petrol	569		
CAWB	82.50	1984	4	Petrol	569		
CAXA	76.50	1390	4	Petrol	87	752	
CAXC	76.50	1390	4	Petrol	84	752	
CAYA	79.50	1598	4	Diesel		801	
CAYB	79.50	1598	4	Diesel		801	
CAYC	79.50	1598	4	Diesel		801	
CAYD	79.50	1598	4	Diesel		801	
CAYE	79.50	1598	4	Diesel		801	
CB	90.00	1679	4	Petrol	690		
CBAA	81.00	1968	4	Diesel	465	960	
CBAB	81.00	1968	4	Diesel	462	960	
CBAC	81.00	1968	4	Diesel	466	960	
CBBA	81.00	1968	4	Diesel	462	955	
CBBB	81.00	1968	4	Diesel	462	961	
CBDA	81.00	1968	4	Diesel	467	960	
CBDB	81.00	1968	4	Diesel	463	961	
CBDC	81.00	1968	4	Diesel	462	960	
CBEA	81.00	1968	4	Diesel	468	955	

		ccm				
					9	
CBFA	82.50	1984	4	Petrol	569	
CBHA	81.00	1968	4	Diesel	470	962
CBJB	81.00	1968	4	Diesel	469	962
CBKA	81.00	1968	4	Diesel	471	962
CBPA	82.50	1984	4	Petrol	623	1027
CBR	84.00	3189	6	Petrol	663	1044
CBRA	84.00	3189	6	Petrol	664	1044
CBSA	82.50	1984	4	Petrol	624	
CBTA	83.60	2480	5	Petrol	660	
CBUA	82.50	2480	5	Petrol	635	
CBWA	81.00	4921	10	Diesel	566	
CBZA	71.00	1197	4	Petrol	14	
CBZB	71.00	1197	4	Petrol	14	
CCAA	82.50	2976	6	Petrol	651	
CCBA	84.50	2995	6	Petrol	671	
CCCA	82.50	2480	5	Petrol	635	
CCDA	84.50	2773	6	Petrol	671	1047
CCEA	84.50	2773	6	Petrol	671	1047
CCHA	81.00	1968	4	Diesel	462	959
CCHB	81.00	1968	4	Diesel	462	959
CCMA	83.00	2967	6	Diesel	655	1042
CCNA	67.10	999	4	Petrol	5	
CCSA	81.00	1595	4	Petrol	312	874
CCTA	82.50	1984	4	Petrol	569	
CCTB	82.50	1984	4	Petrol	569	
CCWA	83.00	2967	6	Diesel	655	1039
CCWB	83.00	2967	6	Diesel	655	1039
CCZA	82.50	1984	4	Petrol	571	
CCZB	82.50	1984	4	Petrol	569	
CCZC	82.50	1984	4	Petrol	625	
CDAA	82.50	1798	4	Petrol	571	
CDAB	82.50	1798	4	Petrol	570	
CDBA	81.00	1968	4	Diesel		959
CDCA	81.00	1968	4	Diesel		959
CDDA	76.50	1390	4	Petrol	90	753
CDGA	75.50	1390	4	Petrol	50	729
CDHA	82.50	1798	4	Petrol	571	
CDHB	82.50	1798	4	Petrol	571	
CDLA	82.50	1984	4	Petrol	626	
CDLB	82.50	1984	4	Petrol	570	
CDLC	82.50	1984	4	Petrol	613	
CDLD	82.50	1984	4	Petrol	612	
CDLF	82.50	1984	4	Petrol	613	
CDMA	82.50	1984	4	Petrol	570	
CDNB	82.50	1984	4	Petrol	569	
CDNC	82.50	1984	4	Petrol	569	
CDXA	79.50	1896	4	Diesel	263	838
CDXB	79.50	1896	4	Diesel	264	838
CDYA	83.00	2967	6	Diesel	655	1039
CDYB	83.00	2967	6	Diesel	655	1041
CDYC	83.00	2967	6	Diesel	655	1039
CE	90.00	1679	4	Petrol	685	
CEBA	81.00	2461	5	Diesel	531	990
CEBB	81.00	2461	5	Diesel	531	990
CECA	81.00	2461	5	Diesel	531	991
CECB	81.00	2461	5	Diesel	532	992
CEGA	81.00	1968	4	Diesel	463	961
CEKA	82.50	1984	4	Petrol		1028
CEVA	76.50	1198	3	Petrol	61	
CEXA	83.00	2967	6	Diesel	655	1039
CEZA	83.00	2967	6	Diesel	659	
CFCA	81.00	1968	4	Diesel	462	959
CFFA	81.00	1968	4	Diesel	472	963
CFFB	81.00	1968	4	Diesel	463	963
CFFD	81.00	1968	4	Diesel	461	963
CFFE	81.00	1968	4	Diesel		964
CFGB	81.00	1968	4	Diesel	463	963
CFGC	81.00	1968	4	Diesel		965
CFHA	81.00	1968	4	Diesel	466	962
CFHB	81.00	1968	4	Diesel		963
CFHC	81.00	1968	4	Diesel	463	963
CFHD	81.00	1968	4	Diesel	473	955
CFHE	81.00	1968	4	Diesel		959
CFHF	81.00	1968	4	Diesel	462	963
CFJA	81.00	1968	4	Diesel	463	963
CFKA	82.50	1984	4	Flexfuel	628	
CFLA	84.00	3189	6	Petrol	666	1044
CFMA	81.00	1781	4	Petrol	398	

		ccm					9
CFNA	76.50	1598	4	Petrol			774
CFWA	79.50	1199	3	Diesel			791
CGGA	76.50	1390	4	Petrol	91		750
CGGB	76.50	1390	4	Petrol	79		750
CGKA	83.00	2698	6	Diesel	655		1039
CGKB	83.00	2698	6	Diesel	655		1039
CGLA	81.00	1968	4	Diesel			955
CGLB	81.00	1968	4	Diesel			955
CGLC	81.00	1968	4	Diesel			955
CGLD	81.00	1968	4	Diesel			955
CGPA	76.50	1198	3	Petrol	57		
CGPB	76.50	1198	3	Petrol	62		
CGYA	82.50	1798	4	Petrol	570		
CGZ	82.50	1984	4	Petrol	629		
CH	86.50	1984	4	Petrol	686		1058
CHFA	76.50	1198	3	Petrol	58		
CHFB	76.50	1198	3	Petrol	63		
CHGA	81.00	1595	4	Petrol	317		
CHTA	76.50	1198	3	Petrol	61		
CJ	94.00	1970	4	Petrol	701		1061
CJAA	81.00	1968	4	Diesel	474		959
CJCA	81.00	1968	4	Diesel	475		955
CJCB	81.00	1968	4	Diesel			955
CJGA	83.00	2967	6	Diesel			1039
CJMA	83.00	2967	6	Diesel			1039
CK	76.50	1471	4	Diesel	99		757
CKTB	81.00	1968	4	Diesel			966
CKTC	81.00	1968	4	Diesel			966
CKUB	81.00	1968	4	Diesel			966
CKUC	81.00	1968	4	Diesel			966
CLCA	81.00	1968	4	Diesel			963
CLCB	81.00	1968	4	Diesel	463		963
CLJA	81.00	1968	4	Diesel	462		963
CLLA	81.00	1968	4	Diesel			959
CLNA	79.50	1598	4	Diesel			801
CLPA	76.50	1390	4	Petrol	92		753
CLSA	76.50	1598	4	Petrol	125		
CMEA	81.00	1968	4	Diesel	462		955
CMGB	81.00	1968	4	Diesel			955
CMR	81.00	1595	4	Petrol	399		
CMSA	76.50	1390	4	Petrol	84		754
CMXA	81.00	1595	4	Petrol	318		
CN	76.50	1986	5	Diesel	132		778
CNVA	76.50	1390	4	Petrol			751
CNWA	76.50	1390	4	Petrol			751
CP	76.50	2383	6	Diesel	142		784
CR	76.50	1588	4	Diesel	102		762
CS	76.50	1588	4	Diesel	103		763
CT	84.00	1584	4	Petrol	662		
CU	94.00	1970	4	Petrol	702		1061
CV	94.00	1970	4	Petrol	702		1061
CY	76.50	1588	4	Diesel	104		764
CZ	85.50	1584	4	Petrol	682		1055
D	77.00	1192	4	Petrol	148		786
DD	81.00	1781	4	Petrol	400		924
DE	76.50	1986	5	Diesel	133		779
DF	94.00	1915	4	Petrol	693		1062
DG	94.00	1888	4	Petrol	699		1061
DH	94.00	1913	4	Petrol	700		1062
DH	94.00	1913	4	Petrol	694		1062
DJ	94.00	2109	4	Petrol	696		1063
DL	76.50	2383	6	Petrol	136		781
DR	81.00	1781	4	Petrol	401		925
DS	81.00	1781	4	Petrol	402		926
DT	81.00	1595	4	Petrol	319		880
DTA	81.00	1595	4	Petrol	320		881
DTA	81.00	1595	4	Petrol	403		881
DV	76.50	2383	6	Diesel	143		780
DW	76.50	2383	6	Diesel	144		784
DX	81.00	1781	4	Petrol	404		927
DZ	81.00	1781	4	Petrol	405		928
E	77.00	1285	4	Petrol	147		786
EA111	81.00	1598	4		333		
EE	79.50	1588	4	Petrol	137		797
EF	79.50	1588	4	Petrol	138		795
EG	79.50	1588	4	Petrol	166		798
EH	79.50	1457	4	Petrol	167		795
EM	79.50	1588	4	Petrol	168		795

			ccm				9	
EN		79.50	1716	4	Petrol	169		803
EP		75.00	1297	4	Petrol	41		724
EU		75.00	1272	4	Petrol	26		720
EV		81.00	1781	4	Petrol	406		929
EW		81.00	1595	4	Petrol	321		882
EWA		81.00	1595	4	Petrol	322		
EX		81.00	1781	4	Petrol	407		930
EY		94.00	1915	4	Petrol	695		
EZ		81.00	1595	4	Petrol	323		883
EZA		81.00	1595	4	Petrol	324		884
F		77.00	1285	4	Petrol	149		786
FA		69.50	1093	4	Petrol	7		710
FB		76.50	1470	4	Petrol	93		755
FD		76.50	1470	4	Petrol	94		755
FF		76.50	1471	4	Petrol	95		755
FH		76.50	1471	4	Petrol	96		755
FJ		69.50	1093	4	Petrol	8		710
FK		76.50	1471	4	Petrol			755
FN		79.50	1588	4	Petrol	170		799
FP		79.50	1588	4	Petrol	171		795
FR		79.50	1588	4	Petrol	172		795
FS		79.50	1588	4	Petrol	173		795
FT		79.50	1588	4	Petrol	174		800
FV		79.50	1588	4	Petrol	175		795
FY		75.00	1272	4	Petrol	27		721
FZ		75.00	1272	4	Petrol	28		721
GD		94.00	1970	4	Petrol	703		
GE		94.00	1970	4	Petrol	704		1061
GF		75.00	1272	4	Petrol	28		721
GG		69.50	1093	4	Petrol	9		710
GH		79.50	1457	4	Petrol	176		795
GK		75.00	1272	4	Petrol	29		719
GL		75.00	1043	4	Petrol	20		715
GN		75.00	1043	4	Petrol	21		715
GS		75.00	1272	4	Petrol	30		722
GT		75.00	1272	4	Petrol	31		721
GU		81.00	1781	4	Petrol	296		930
GV		79.50	2144	5	Petrol	269		854
GW		94.00	1913	4	Petrol	700		1062
GX		81.00	1781	4	Petrol	408		929
GZ		81.00	1781	4	Petrol	409		893
H		83.00	1493	4	Petrol	653		1037
HA		69.50	895	4	Petrol	13		710
HB		69.50	1093	4	Petrol	10		710
HC		69.50	1093	4	Petrol	11		710
HD		69.50	1093	4	Petrol	12		710
HH		75.00	1272	4	Petrol	32		721
HJ		75.00	1272	4	Petrol	33		721
HK		75.00	1272	4	Petrol	34		719
HM		81.00	1595	4	Petrol	325		884
HN		81.00	1595	4	Petrol	326		885
HP		81.00	1994	5	Petrol	477		967
HS		76.50	2383	6	Petrol	139		781
HT		81.00	1781	4	Petrol	410		893
HV		81.00	1781	4	Petrol	411		893
HW		75.00	1272	4	Petrol	35		717
HX		81.00	2226	5	Petrol	492		973
HY		81.00	2226	5	Petrol	493		973
HZ		75.00	1043	4	Petrol	22		716
JB		79.50	1457	4	Petrol	165		796
JH		81.00	1781	4	Petrol	412		930
JJ		81.00	1781	4	Petrol	413		
JK		76.50	1588	4	Diesel	105		765
JL		81.00	1994	5	Petrol	478		
JN		81.00	1781	4	Petrol	414		925
JP		76.50	1588	4	Diesel	106		766
JR		76.50	1588	4	Diesel	107		759
JS		81.00	1994	5	Petrol	479		967
JT		81.00	2226	5	Petrol	494		974
JU		81.00	1595	4	Petrol	327		885
JV		81.00	1781	4	Petrol	415		926
JW		81.00	1781	4	Petrol	416		931
JX		76.50	1588	4	Diesel	108		759
JY		79.50	2144	5	Petrol	270		854
K		83.00	1493	4	Petrol	653		
KE		79.50	2144	5	Petrol	271		855
KF		79.50	2144	5	Petrol	272		855
KG		79.50	2144	5	Petrol	273		856

			ccm					9
KH		79.50	2144	5	Petrol	274	854	
KJ		79.50	2144	5	Petrol	276	857	
KK		79.50	2144	5	Petrol	275	855	
KL		79.50	2144	5	Petrol	277	855	
KP		81.00	1994	5	Petrol	480	968	
KR		81.00	1781	4	Petrol	417	932	
KT		81.00	1781	4	Petrol	418	929	
KU		81.00	2226	5	Petrol	495	975	
KV		81.00	2226	5	Petrol	496	975	
KW		79.30	2133	5	Petrol	158	790	
KX		81.00	2226	5	Petrol	497	974	
KY		79.50	1715	4	Diesel	194	802	
KZ		81.00	2226	5	Petrol	498	974	
L		83.00	1493	4	Petrol	652		
MB		81.00	2226	5	Petrol	499	976	
MC		81.00	2226	5	Petrol	500	977	
ME		76.50	1588	4	Diesel	109	767	
MF		76.50	1588	4	Diesel	101	759	
MH		75.00	1272	4	Petrol	36	717	
MN		75.00	1272	4	Diesel	40	723	
MU		81.00	1781	4	Petrol	419	893	
MV		94.00	2109	4	Petrol	696	1063	
NC		76.50	1986	5	Diesel	134	779	
NE		81.00	1781	4	Petrol	420	926	
NF		82.50	2309	5	Petrol	633	1032	
NG		82.50	2309	5	Petrol	634	1032	
NM		81.00	1994	5	Petrol	481	969	
NP		81.00	1781	4	Petrol	416	894	
NU		75.00	1272	4	Petrol	37	717	
NZ		75.00	1272	4	Petrol	38	719	
OHC		75.50	1289	4	Petrol	49	728	
P		85.50	1584	4	Petrol		1055	
PB		81.00	1781	4	Petrol	421	933	
PD		81.00	1781	4	Petrol	422	934	
PF		81.00	1781	4	Petrol	423	935	
PG		81.00	1781	4	Petrol	424	936	
PH		81.00	1781	4	Petrol	425	937	
PL		81.00	1781	4	Petrol	417	938	
PM		81.00	1781	4	Petrol	414	939	
PN		81.00	1595	4	Petrol	328	886	
PP		81.00	1595	4	Petrol	329	887	
PS		81.00	1994	5	Petrol	482	970	
PT		81.00	3562	8	Petrol	561	1001	
PV		81.00	1781	4	Petrol	426	926	
PX		81.00	2226	5	Petrol	501	978	
PY		75.00	1272	4	Petrol	39	717	
RA		76.50	1588	4	Diesel	110	759	
RD		81.00	1781	4	Petrol	427	940	
RE		81.00	1595	4	Petrol	328	888	
RF		81.00	1595	4	Petrol	328	886	
RG		81.00	1781	4	Petrol	428	928	
RH		81.00	1781	4	Petrol	429	941	
RL		81.00	1595	4	Petrol	330	889	
RM		81.00	1781	4	Petrol	430	942	
RN		81.00	1595	4	Petrol	331	887	
RNA		81.00	1595	4	Petrol	431		
RP		81.00	1781	4	Petrol	296	943	
RR		81.00	2226	5	Petrol	502	979	
RS		81.00	1781	4	Petrol	432	944	
RT		81.00	1994	5	Petrol	483	967	
RU		81.00	1781	4	Petrol	420	945	
RV		81.00	1781	4	Petrol	423	946	
SA		81.00	1595	4	Petrol	332	890	
SB		76.50	1588	4	Diesel	110	759	
SD		82.50	1847	4	Petrol	572	1006	
SF		81.00	1781	4	Petrol	420	945	
SH		81.00	1781	4	Petrol	416	939	
SK		81.00	1994	5	Petrol	484	967	
SL		81.00	1994	5	Petrol	485	967	
SP		94.00	1915	4	Petrol	697	1061	
SR		94.00	2109	4	Petrol	696	1063	
SS		94.00	2109	4	Petrol	698	1063	
T		85.50	1584	4	Petrol		1057	
U		85.50	1584	4	Petrol		1054	
UDH		81.00	1781	4	Petrol	315		
WA		86.50	1984	4	Petrol	687		
WB		79.50	2144	5	Petrol	278	858	
WC		79.50	2144	5	Petrol	279	859	

			ccm	X 			9	
WD		79.50	2144	5	Petrol			860
WE		79.50	2144	5	Petrol	280		861
WF		86.50	1984	4	Petrol	688		
WG		79.50	2144	5	Petrol	281		862
WH		79.50	1921	5	Petrol	265		852
WJ		79.50	2144	5	Petrol	282		863
WK		79.50	2144	5	Petrol	266		854
WL		79.50	1714	4	Petrol	190		
WN		79.50	1921	5	Petrol	268		853
WP		79.50	1588	4	Petrol	177		795
WR		79.50	2144	5	Petrol	283		856
WS		79.50	2144	5	Petrol	284		864
WT		79.50	1716	4	Petrol	195		795
WU		79.50	2144	5	Petrol	272		855
WV		79.50	1588	4	Petrol	178		795
WX		79.50	2144	5	Petrol	270		856
WY		79.50	1588	4	Petrol	179		796
WY		79.50	1588	4	Petrol	191		796
WZ		79.50	1588	4	Petrol	180		795
XW		76.50	1471	4	Petrol			755
XX		79.50	1588	4	Petrol	181		795
YG		79.50	1588	4	Petrol	192		795
YH		79.50	1588	4	Petrol	193		795
YH		79.50	1588	4	Petrol	182		795
YJ		76.50	1471	4	Petrol	93		756
YK		79.50	1588	4	Petrol			795
YM		79.50	1588	4	Petrol			795
YN		79.50	1588	4	Petrol	183		796
YP		79.50	1588	4	Petrol	184		796
YS		79.50	1588	4	Petrol	185		798
YT		79.50	1588	4	Petrol	186		795
YU		79.50	1588	4	Petrol			795
YV		79.50	1588	4	Petrol	187		796
YX		79.50	1714	4	Petrol	190		
YY		79.50	1588	4	Petrol	188		796
YZ		79.50	1588	4	Petrol	189		798
ZA		75.00	1297	4	Petrol	42		725
ZB		76.50	1471	4	Petrol	97		756
ZC		76.50	1471	4	Petrol	98		756
ZF		75.00	1297	4	Petrol	43		725
ZV		79.50	1716	4	Petrol			795

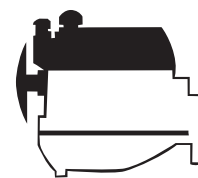

TOP ENGINE APPLICATIONS

ZYLINDERKOPFANWENDUNGEN

APPLICAZIONI PARTE ALTA DEL MOTORE

APPLICATIONS HAUT MOTEUR

APLICACIONES PARA LA PARTE SUPERIOR DEL MOTOR

GÓRA SILNIKA

ДЕТАЛИ ВЕРХНЕЙ ЧАСТИ ДВИГАТЕЛЯ

تطبيقات المحرك العلوية





1	67.10	Petrol			
AER	4 Cyl.	10.5:1	999cc	37kW (50)PS	TD5533 705
AER	4 Cyl.	10.5:1	999cc	37kW (50)PS	TD9519 705
AROSA	05/97→06/04	CORDOBA	09/96→06/99	IBIZA	09/96→08/99
LUPU	09/98→07/05	POLO	09/96→10/99		

TB466 135x19	TBK087 Eng.→037979 TBK320 Eng.037980→		KIT		FOL143 (x8)

V94149 ■ 31.00 x 7.00 x 94.70	V94197 ■ 26.00 x 7.00 x 94.40	MAT. MB MD	45°	H	VAG96041B ■ ■ ■ 36.50 x 7.00 x 12.08	VAG96062B ■ ■ ■ 33.00 x 7.02 x 15.00

AA5410 MLS, 0.600mm	CA5410 [14]	HBS249 ⊕ M9x1.25x138mm (x10)	JD597 ■ ■ ■ JD601 ■	JP074 HM5062 ■	HR816 ■	NA5001 32.00x47.00x10.00mm FPM		

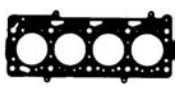











AA5410





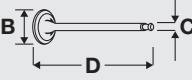
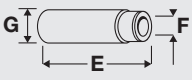







[14] With shaft oil seal

[14] Mit Wellendichtring

AHT	4 Cyl.	10.5:1	999cc	37kW (50)PS	TD11467	706
AHT	4 Cyl.	10.5:1	999cc	37kW (50)PS	TD13889	706
AROSA	10/98→02/00		LUPO	10/98→05/00		

					
TB466 135x19	TBK087 →03/00 TBK320 03/00→		KIT		

	
B x C x D	E x F x G
V94418 	VAG96041B 
047 198 601D	36.50 x 7.00 x 12.08
34.00 x 7.00 x 101.40	VAG96062B 
V94419 	33.00 x 7.02 x 15.00
047 109 611D	
30.00 x 7.00 x 101.40	

							
				JD5818 	JM5285	HR646 	
				MLS			
				JD5849 			
				MLS			
				JD5817 			
				MLS			

3

67.10

Petrol



ALD	4 Cyl.	10.7:1	999cc	37kW (50)PS	TD11468	707
ALD	4 Cyl.	10.7:1	999cc	37kW (50)PS	TD13890	707
ANV	4 Cyl.	10.7:1	999cc	37kW (50)PS	TD11469	707
ANV	4 Cyl.	10.7:1	999cc	37kW (50)PS	TD13888	707
AUC	4 Cyl.	10.7:1	999cc	37kW (50)PS	TD15491	709
AUC	4 Cyl.	10.7:1	999cc	37kW (50)PS	TD16138	709

AROSA	05/97→06/04	CORDOBA	06/99→10/02	IBIZA	08/99→02/02
LUPO	09/98→07/05	POLO	10/99→09/01		



TB466 135x19	TBK087 →03/00 TBK320 03/00→				FOL167 (x8)







B x C x D	OE	MAT.
V94644 ■ 31.00 x 6.00 x 99.00	030 109 601AK	45° H
V94645 ■ 26.00 x 6.00 x 98.90	030 109 611S	45° ss H
		VAG96073B ■ ■ 36.00 x 6.02 x 11.06









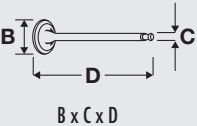

AD5630 MLS, 0.500mm	CD5630	HBS362 Ⓞ M9x1.25x162mm (x10)	JD5318 ■ ⓄJE5076	HR397	PA5041 (x8) 6.00x8.8/12.20x10.00 866N W (FPM) HR817 ■	NA5185 32.00x42.00x7.00mm FPM















AD5630

4	 67.10	Petrol				
ALL	4 Cyl.	10.5:1	999cc	37kW (50)PS	TD10609	705
ALL	4 Cyl.	10.5:1	999cc	37kW (50)PS	TD13891	705
AROSA	05/97→06/04	LUPO	09/98→07/05	POLO	09/96→10/99	

					
TB466 135x19	TBK087 →03/00 TBK320 03/00→				

					
B x C x D	OE	MAT.	45°	H	E x F x G
V94149 	030 109 601AG		45°	H	VAG96041B 
31.00 x 7.00 x 94.70		MB			36.50 x 7.00 x 12.08
V94197 	030 109 611N		45°		VAG96062B 
26.00 x 7.00 x 94.40		MD			33.00 x 7.02 x 15.00



							
AA5410 MLS, 0.600mm	CA5410 [14]		HBS249 	JD597 	JP074	HR816 	NA5001 32.00x47.00x10.00mm FPM
			M9x1.25x138mm (x10)	JD601 			













AA5410









[14] With shaft oil seal

[14] Mit Wellendichtring

5	 67.10	Petrol			
AQZ	4 Cyl.		999cc	53kW (72)PS	TD20806
AZN	4 Cyl.	10.5:1	999cc	48kW (65)PS	TD25771
BJE	4 Cyl.		999cc	53kW (72)PS	TD20808
BJR	4 Cyl.	11.5:1	999cc	48kW (65)PS	TD25199
BNX	4 Cyl.		999cc	53kW (72)PS	TD20807
CCNA	4 Cyl.		999cc	54kW (73)PS	TD20809

							
						PA5041 (x8) 6.00x8.8/12.20x10.00 866N W (FPM)	

6	 67.10	Petrol				
ATE	4 Cyl.	10.7:1	999cc	37kW (50)PS	TD22625	708

							
AD5630 MLS, 0.500mm						PA5041 (x8) 6.00x8.8/12.20x10.00 866N W (FPM)	



AD5630

7	69.50	Petrol			
FA	4 Cyl.	8.2:1	1093cc	37kW (50)PS	TD5001 710
GOLF	04/74→07/83	JETTA	08/78→02/84	SCIROCCO	04/74→07/79

TB107					
108x19					

B x C x D	OE	MAT.	45°	Y	H
V90323 ■	036 109 601		45°		H
34.00 x 7.97 x 104.00		MB			
V90324 ■	036 109 601B		45°		H
34.10 x 7.96 x 104.15		MB			
V90325 ■	052 109 611A		45°	ss	
28.14 x 7.95 x 104.29		ME			

BL560 Fibre Composite, 1.700mm	DL560 →06/76 DL561 06/76→		HBS043 ⊕ M11x1.50x95mm (x10)	JD246 ■ JC259 ■ (x2) ⊕ JE154 (x2) [8] →06/76	JM154	HR569 ■	NA5001 32.00x47.00x10.00mm FPM



BL560

[8] Equipment Variant: GT, Equipment Variant: 60 PS/hp

[8] Ausstattungsvariante: GT, Ausstattungsvariante: 60 PS/hp

8	69.50	Petrol			
FJ	4 Cyl.	8.2:1	1093cc	38kW (52)PS	TD4082 710
GOLF	01/81→07/83				

TB107					
108x19					

BL560 Fibre Composite, 1.700mm	DL560 →06/76 DL561 06/76→		HBS043 ⊕ M11x1.50x95mm (x10)	JD246 ■ JC259 ■ (x2) ⊕ JE154 (x2) [8] →06/76	JM154	HR569 ■	NA5001 32.00x47.00x10.00mm FPM



BL560

[8] Equipment Variant: GT, Equipment Variant: 60 PS/hp

[8] Ausstattungsvariante: GT, Ausstattungsvariante: 60 PS/hp

9

69.50

Petrol



GG 4 Cyl. 8.2:1 1093cc 37kW (50)PS TD4093 710

GOLF 04/74→07/83 JETTA 08/78→02/84

TB107 108x19					

 B x C x D	OE	MAT.				 E x F x G
V90323 ■ 34.00 x 7.97 x 104.00	036 109 601		45°	Y	H	VAG92061B ■ ■ ■ 36.70 x 8.00 x 12.08
V90324 ■ 34.10 x 7.96 x 104.15	036 109 601B		45°		H	
V90325 ■ 28.14 x 7.95 x 104.29	052 109 611A		45°	ss		

BL560 Fibre Composite, 1.700mm	DL560 DL561		HBS043 ⊕ M11x1.50x95mm (x10)	JD246 ■ JC259 ■ (x2) ⊕ JE154 (x2) [2] →06/76	JM154	HR569 ■	NA5001 32.00x47.00x10.00mm FPM

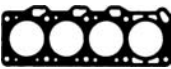

BL560
[2] Equipment Variant: GT [2] Ausstattungsvariante: GT

10

69.50

Petrol



HB 4 Cyl. 8/8.2:1 1093cc 37kW (50)PS TD4207 710

HB 4 Cyl. 8/8.2:1 1093cc 37kW (50)PS TD5008 710



50 08/74→07/78 DERBY 02/77→07/83 POLO 03/75→09/89







 B x C x D	OE	MAT.				 E x F x G
V90323 ■ 34.00 x 7.97 x 104.00	036 109 601		45°	Y	H	VAG92061B ■ ■ ■ 36.70 x 8.00 x 12.08
V90324 ■ 34.10 x 7.96 x 104.15	036 109 601B		45°		H	
V90325 ■ 28.14 x 7.95 x 104.29	052 109 611A		45°	ss		







BL560 Fibre Composite, 1.700mm	DL560 →05/76 DL561 06/76→		HBS043 ⊕ M11x1.50x95mm (x10)	JD246 ■ JC259 ■ (x2) ⊕ JE154 (x2) [8] →06/76	JM154	HR569 ■	NA5001 32.00x47.00x10.00mm FPM



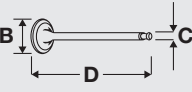
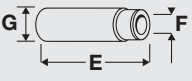



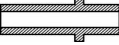







BL560
[8] Equipment Variant: GT, Equipment Variant: 60 PS/hp [8] Ausstattungsvariante: GT, Ausstattungsvariante: 60 PS/hp

11	 69.50	Petrol				
HC	4 Cyl.	9.1/9.5:1	1093cc	44kW (60)PS	TD263	710
HC	4 Cyl.	9.1/9.5:1	1093cc	44kW (60)PS	TD5009	710
50	08/74→07/77	GOLF	01/81→07/83	POLO	03/75→09/81	

					
TB107			KIT		
108x19					

	
B x C x D	E x F x G
OE	
MAT.	
	
V90324 	VAG92061B 
036 109 601B	36.70 x 8.00 x 12.08
34.10 x 7.96 x 104.15	
V90325 	
052 109 611A	
28.14 x 7.95 x 104.29	
	

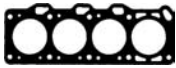

							
BL560 Fibre Composite, 1.700mm	DL560 →05/76 DL561 06/76→		HBS043  M11x1.50x95mm (x10)	JD246  JC259  (x2) JE154 (x2) [8] →06/76	JM154	HR569 	NA5001 32.00x47.00x10.00mm FPM











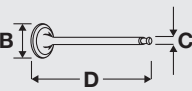
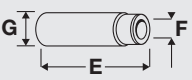









BL560

[8] Equipment Variant: GT, Equipment Variant: 60 PS/hp

[8] Ausstattungsvariante: GT, Ausstattungsvariante: 60 PS/hp

12	 69.50	Petrol				
HD	4 Cyl.	8/8.2:1	1093cc	38kW (52)PS	TD264	710

	
B x C x D	E x F x G
OE	
MAT.	
	
V90324 	VAG92061B 
036 109 601B	36.70 x 8.00 x 12.08
34.10 x 7.96 x 104.15	
V90325 	
052 109 611A	
28.14 x 7.95 x 104.29	
	

							
BL560 Fibre Composite, 1.700mm	DL560 →05/76 DL561 06/76→		HBS043  M11x1.50x95mm (x10) 07/76→	JD246  JC259  (x2) JE154 (x2) [8] →06/76		HR569 	NA5001 32.00x47.00x10.00mm FPM



BL560

[8] Equipment Variant: GT, Equipment Variant: 60 PS/hp

[8] Ausstattungsvariante: GT, Ausstattungsvariante: 60 PS/hp

13	69.50	Petrol				
HA	4 Cyl.	8:1	895cc	29kW (40)PS	TD4104	710
DERBY	02/77→09/81	POLO	09/75→12/81			

B x C x D	OE	MAT.	45°	Y	H	E x F x G
V90323	036 109 601	MB				VAG92061B
34.00 x 7.97 x 104.00						36.70 x 8.00 x 12.08

BL560 Fibre Composite, 1.700mm	DL560 →06/76 DL561 06/76→		HBS043 M11x1.50x95mm (x10)	JD246 JC259 (x2) JE154 (x2) [8] →06/76	JM154	HR569	NA5001 32.00x47.00x10.00mm FPM



BL560
 [8] Equipment Variant: GT, Equipment Variant: 60 PS/hp [8] Ausstattungsvariante: GT, Ausstattungsvariante: 60 PS/hp

14	71.00	Petrol				
CBZA	4 Cyl.	10:1	1197cc	63kW (85)PS	Turbo Intercooled	TD23927
CBZA	4 Cyl.	10:1	1197cc	63kW (85)PS	Turbo Intercooled	TD24312
CBZA	4 Cyl.	10:1	1197cc	63kW (85)PS	Turbo Intercooled	TD24385
CBZB	4 Cyl.	10:1	1197cc	77kW (105)PS	Turbo Intercooled	TD23520
CBZB	4 Cyl.	10:1	1197cc	77kW (105)PS	Turbo Intercooled	TD23583
CBZB	4 Cyl.	10:1	1197cc	77kW (105)PS	Turbo Intercooled	TD23907
CBZB	4 Cyl.	10:1	1197cc	77kW (105)PS	Turbo Intercooled	TD23908

A1	05/10→	A3	03/10→	ALTEA	04/10→
ALTEA XL	04/10→	BEETLE	07/11→	CADDY	09/10→
FABIA	03/10→	GOLF	05/09→	IBIZA	09/10→
JETTA	02/11→	LEON	02/10→	OCTAVIA	02/10→
POLO	11/09→	RAPID	07/12→	ROOMSTER	03/10→
TOLEDO	07/12→	TOURAN	05/10→	YETI	09/09→

					HR397	PA5041 (x8) 6.00x8.8/12.20x10.00 866N W (FPM)









15







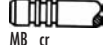

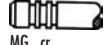



 **72.00**

Petrol



AQV	4 Cyl.	997cc	37kW (50)PS	TD16238	711
ARV	4 Cyl.	997cc	37kW (50)PS	TD15368	711
FABIA 12/99→08/02					

 B x C x D	OE	MAT.				 E x F x G
V94420  34.00 x 7.00 x 103.70	047 109 601F	 MB cr	45°	Y	H	
V94421  27.00 x 7.00 x 103.70	047 109 611B	 MG cr	45°	ss	H	

							
				JD5818  MLS JD5817  MLS JD5849  MLS	JM5285	HR646 	







16









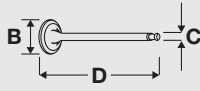

 **75.00**





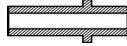

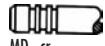





Petrol



AAK	4 Cyl.	1043cc	33kW (45)PS	TD4003	712
POLO 01/85→09/94					

					
TB107 108x19 →09/90					FOL92 (x8)
TB283 128x19 10/90→					

 B x C x D	OE	MAT.				 E x F x G
V91332  36.10 x 7.97 x 99.30	030 109 601F	 MD	45°			VAG92061B  36.70 x 8.00 x 12.08
V94305  32.00 x 8.00 x 99.30	030 109 601E	 MD cr	45°	ss		
V91473  29.00 x 7.95 x 99.10	030 109 611A	 MG	45°	ss	H	

							
BL570 Fibre Composite, 1.730mm	DL572 →Ch.80-PW-000000 DL574 Ch.80-PW-000 001→		HBS043  M11x1.50x95mm (x10)	JD246  JC259  (x2)	JN641	HR569  →Ch.80-NW-500 000 HR816  Ch.80-PW-000 001→	NA5001 32.00x47.00x10.00mm FPM



BL570

17	75.00	Petrol				
AAU	4 Cyl.	10.1:1	1043cc	33kW (45)PS	TD4892	713
AAU	4 Cyl.	10.1:1	1043cc	33kW (45)PS	TD4971	713
IBIZA	03/93→09/96	POLO	01/85→12/99			

TB107 108x19 Eng.→015868					FOL92 (x8)
TB283 128x19 Eng.015869→					

B x C x D	E x F x G
V94715 32.00 x 6.90 x 99.00 08/94→	VAG92061B 36.70 x 8.00 x 12.08
V94305 32.00 x 8.00 x 99.30	VAG96161B 36.50 x 7.00 x 11.80
V91473 29.00 x 7.95 x 99.10	
OE: 030 109 601N	MAT. MB
OE: 030 109 601E	MAT. MD cr
OE: 030 109 611A	MAT. MG
45° Y H	45° ss H

BL570 Fibre Composite, 1.730mm	DL572 →Ch.80-PW-000000 DL574 Ch.80-PW-000 001→		HBS043 M11x1.50x95mm (x10)	JD246 JC259 (x2)	JN641	HR569 →Ch.80-NW-500 000 HR816 Ch.80-PW-000 001→	NA5001 32.00x47.00x10.00mm FPM



BL570

18







 **75.00**







Petrol



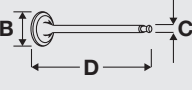



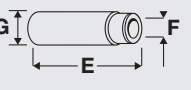



ACM 4 Cyl. 9.5:1 1043cc **33kW (45)PS** TD4013 **712**

POLO 08/89→09/94

					
TB107 108x19 →09/90					FOL92 (x8)
TB283 128x19 10/90→					

						
B x C x D	OE	MAT.	45°	ss	H	E x F x G
V91332 ■ 36.10 x 7.97 x 99.30	030 109 601F		45°			VAG92061B ■ ■ ■ 36.70 x 8.00 x 12.08
V91473 ■ 29.00 x 7.95 x 99.10	030 109 611A		45°	ss	H	

							
BL570 Fibre Composite, 1.730mm	DL572 →Ch.80-PW-000000 DL574 Ch.80-PW-000 001→	HBS043 ⊕ M11x1.50x95mm (x10)	JD246 ■ JC259 ■ (x2)	JN641	HR569 ■ →Ch.80-NW-500 000 HR816 ■ Ch.80-PW-000 001→	NA5001 32.00x47.00x10.00mm FPM	



BL570

19	75.00	Petrol	
AEV	4 Cyl.	1043cc	33kW (45)PS
TD4021	714		
POLO	10/94 → 09/96		

TB465					FOL92 (x8)
132x19					

B x C x D	OE	MAT.	45°	Y	H
V94251 ■	030 109 601L		45°	Y	H
36.00 x 7.00 x 99.40		MB			
V94308 ■	030 109 601G		45°	Y	H
34.00 x 7.00 x 99.10		MB			
V94715 ■	030 109 601N		45°	Y	H
32.00 x 6.90 x 99.00		MB			
V94309 ■	030 109 611D		45°		
29.00 x 7.00 x 99.00		MD			
				E x F x G	
				VAG96161B ■ ■ ■	
				36.50 x 7.00 x 11.80	

BL570 Fibre Composite, 1.730mm	DL573		HBS043 ⊕ M11x1.50x95mm (x10)	JD246 ■ JD488 ■	JP074 HM5062 ■	HR816 ■	NA5001 32.00x47.00x10.00mm FPM

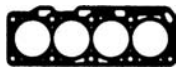

BL570

20	75.00	Petrol	
GL	4 Cyl.	9.5:1	1043cc
29kW (40)PS	TD5006		
715			
DERBY	10/81 → 12/84		POLO
			10/81 → 10/86

B x C x D	OE	MAT.	45°	Y	H
V90326 ■	036 109 601A		45°		
34.10 x 7.97 x 110.80		MB			
V90327 ■	036 109 611		45°		
28.14 x 7.95 x 110.00		MD			
				E x F x G	
				VAG92105B ■ ■ ■	
				42.30 x 7.99 x 12.08	

BL570 Fibre Composite, 1.730mm	DL570		HBS029 ⊕ M11x1.50x98mm (x10)	JD246 ■ JC259 ■ (x2) JE154 (x2) [2] →07/84	JM154	HR569 ■	NA5001 32.00x47.00x10.00mm FPM



BL570

[2] Equipment Variant: GT [2] Ausstattungsvariante: GT

21	75.00	Petrol							
GN	4 Cyl.	9.5:1	1043cc	33kW (45)PS				TD4095	715
GOLF	11/83→08/85								

TB107 108x19									
BL570 Fibre Composite, 1.730mm	DL570		HBS029 M11x1.50x98mm (x10)	JD246 JC259 (x2) JE154 (x2) [2] →07/84	JM154	HR569	NA5001 32.00x47.00x10.00mm FPM		



BL570
[2] Equipment Variant: GT [2] Ausstattungsvariante: GT

22	75.00	Petrol							
HZ	4 Cyl.	9.5:1	1043cc	33/37kW (45/50)PS				TD5012	716
DERBY	08/81→12/84		GOLF	08/85→10/91		POLO	01/85→09/94		

TB107 108x19 Eng.→786022									FOL92 (x8)
TB283 128x19 Eng.786023→									

V91332 36.10 x 7.97 x 99.30	V94580 36.00 x 8.00 x 98.80	V91473 29.00 x 7.95 x 99.10	VAG92061B 36.70 x 8.00 x 12.08
B x C x D	OE	MAT.	E x F x G
	030 109 601F	45°	
	030 109 601C	45° H	
	030 109 611A	45° ss H	

BL570 Fibre Composite, 1.730mm	DL572 →Ch.80-PW-000000	DL574 Ch.80-PW-000 001→	HBS043 M11x1.50x95mm (x10)	JD246 JC259 (x2)	JN641	HR569 →Ch.80-NW-500 000	HR816 Ch.80-PW-000 001→	NA5001 32.00x47.00x10.00mm FPM	



BL570

23



 75.00





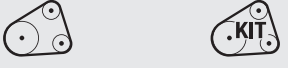
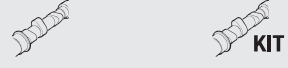

Petrol



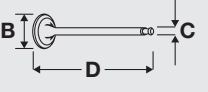

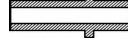







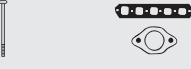

2G	4 Cyl.	1272cc	40kW (54)PS	TD3571	717
2G	4 Cyl.	1272cc	40kW (54)PS	TD4964	717

CORDOBA	02/93→08/94	GOLF	06/86→12/92	IBIZA	03/93→08/99
JETTA	06/87→12/91	POLO	07/87→09/94		

		
TB107 108x19 Eng.→2G 262739 TB283 128x19 Eng.2G 262740→		FOL92 (x8)

	
B x C x D OE MAT. 45° 45° 45° ss H H	E x F x G VAG92061B  36.70 x 8.00 x 12.08
V91332  36.10 x 7.97 x 99.30 030 109 601F MD V94580  36.00 x 8.00 x 98.80 030 109 601C MB V91473  29.00 x 7.95 x 99.10 030 109 611A MG	

						
BL570 Fibre Composite, 1.730mm 	DL572 →Ch.6K-2R-000 100 DL574 Ch.80-PW-000 001→	HBS043  M11x1.50x95mm (x10)	JD246  JC259  (x2)	JN641	HR569  →Ch.80-NW-500 000 HR816  Ch.80-PW-000 001→	NA5001 32.00x47.00x10.00mm FPM

BL570

24







 75.00











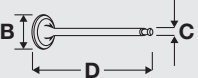

Petrol

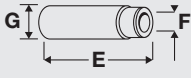















3F 4 Cyl. 9.5:1 1272cc 55/57kW (75/78)PS TD4968 718

POLO 10/89→09/94

					
TB107 108x19 →10/90					FOL92 (x8)
TB283 128x19 10/90→					

					
B x C x D	OE	MAT.			E x F x G
V91332 	030 109 601F	 MD	45°		VAG92061B  36.70 x 8.00 x 12.08
V94305 	030 109 601E	 MD cr	45°	ss	
V91473 	030 109 611A	 MG	45°	ss H	
36.10 x 7.97 x 99.30					
32.00 x 8.00 x 99.30					
29.00 x 7.95 x 99.10					

							
BL570 Fibre Composite, 1.730mm	DL572 →Ch.80-PW-000000 DL574 Ch.80-PW-000001→		HBS043  M11x1.50x95mm (x10)	JD246  JC259  (x2)  JE154 (x2) [2]	JN641	HR569  →Ch.80-NW-500 000 HR816  Ch.80-PW-000 001→	NA5001 32.00x47.00x10.00mm FPM



BL570

[2] Equipment Variant: GT

[2] Ausstattungsvariante: GT

25

75.00

Petrol



AAV	4 Cyl.	9.2:1	1272cc	40kW (54)PS	TD4893	719
AAV	4 Cyl.	9.2:1	1272cc	40kW (54)PS	TD5159	719

CORDOBA	02/93→08/94	IBIZA	03/93→08/99	POLO	07/87→09/94
---------	-------------	-------	-------------	------	-------------

	.KIT		KIT		
TB283 128x19				FOL92 (x8)	

B x C x D	OE	MAT.	45°	E x F x G
V91332	030 109 601F		45°	VAG92061B
36.10 x 7.97 x 99.30		MD		36.70 x 8.00 x 12.08
V91473	030 109 611A		45° ss H	
29.00 x 7.95 x 99.10		MG		

BL570 Fibre Composite, 1.730mm	DL572 →Ch.6K-2R-000100; 80-PW-000000 DL574 Ch.6K-2R-000101; 80-PW-000001 →		HBS043 M11x1.50x95mm (x10)	JD246 JC259 (x2)	JN641	HR569 →Ch.80-NW-500 000 HR816 Ch.80-PW-000 001 →	NA5001 32.00x47.00x10.00mm FPM



BL570

26

75.00

Petrol



EU	4 Cyl.	1272cc	44kW (60)PS	TD16428	720
----	--------	--------	-------------	---------	-----

PASSAT	08/80→07/86
--------	-------------

B x C x D	OE	MAT.	45°	E x F x G
V91415			45° ss H	
34.10 x 7.97 x 98.70		MB		

				JC478 PA459 (NBR) JC152 (x4) JE904	HL457 [9] (Cork) HM5053 [10] (ACM)	HR569	

[9] Centering Diameter [mm]: 8.5

[9] Zentrierdurchmessers [mm]: 8.5

[10] Centering Diameter [mm]: 6.5

[10] Zentrierdurchmessers [mm]: 6.5







27









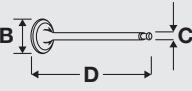

 75.00



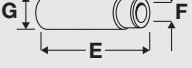

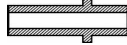







Petrol



FY	4 Cyl.	8.2:1	1272cc	40kW (54)PS	TD259	721
FY	4 Cyl.	8.2:1	1272cc	40kW (54)PS	TD5002	721
80	09/78→07/81		PASSAT	05/73→07/83		

					
TB107 108x19					

 B x C x D	OE	MAT.				 E x F x G
V90323 	036 109 601		45°	Y	H	VAG92061B  36.70 x 8.00 x 12.08
34.00 x 7.97 x 104.00		MB				
V90324 	036 109 601B		45°		H	
34.10 x 7.96 x 104.15		MB				
V90325 	052 109 611A		45°	ss		
28.14 x 7.95 x 104.29		ME				

							
BL570 Fibre Composite, 1.730mm	DL571		HBS043  M11x1.50x95mm (x10) →12/81	JD246  JC259  (x2)	JM154	HR569 	NA5001 (x2) 32.00x47.00x10.00mm FPM



BL570

28



75.00

Petrol



FZ	4 Cyl.	8.2:1	1272cc	44kW (60)PS	TD260	721
FZ	4 Cyl.	8.2:1	1272cc	44kW (60)PS	TD5003	721
GF	4 Cyl.	8.2:1	1272cc	44kW (60)PS	TD4092	721

80	09/78→07/81	GOLF	08/79→07/83	JETTA	08/79→02/84
PASSAT	01/78→07/86	SANTANA	08/81→07/83	SCIROCCO	08/79→12/83

TB107 108x19					

	OE	MAT.				
V90323 ■	036 109 601		45°	Y	H	VAG92061B ■ ■ ■
34.00 x 7.97 x 104.00						36.70 x 8.00 x 12.08
V90324 ■	036 109 601B		45°		H	
34.10 x 7.96 x 104.15						
V90325 ■	052 109 611A		45°	ss		
28.14 x 7.95 x 104.29						

BL570 Fibre Composite, 1.730mm	DL571		HBS043 ⊕ M11x1.50x95mm (x10)	JD246 ■ JC259 ■ (x2)	JM154	HR569 ■	NA5001 (x2) 32.00x47.00x10.00mm FPM



BL570

29



75.00

Petrol



GK	4 Cyl.	9.5:1	1272cc	55kW (75)PS	TD4094	719
----	--------	-------	--------	-------------	--------	-----

DERBY	09/82→12/84	POLO	09/82→09/89			
-------	-------------	------	-------------	--	--	--



TB107 108x19					















	OE	MAT.				
V90326 ■	036 109 601A		45°			VAG92105B ■ ■ ■
34.10 x 7.97 x 110.80						42.30 x 7.99 x 12.08
V90327 ■	036 109 611		45°			
28.14 x 7.95 x 110.00						

BL570 Fibre Composite, 1.730mm	DL570		HBS043 ⊕ M11x1.50x95mm (x10)	JD246 ■ JC259 ■ (x2)	JM154	HR569 ■	NA5001 32.00x47.00x10.00mm FPM





BL570















30	 75.00	Petrol				
GS	4 Cyl.	8.2:1	1272cc	43kW (58)PS	TD4096	722
GOLF	08/82→12/83	JETTA	08/82→02/84			

							
TB107 108x19							
							
BL570 Fibre Composite, 1.730mm	DL571		HBS043 ☉ M11x1.50x95mm (x10)	JD246 ■ JC259 ■ (x2) ☉ JE154 (x2) [2] 08/81→	JM154	HR569 ■	NA5001 (x2) 32.00x47.00x10.00mm FPM



BL570
[2] Equipment Variant: GT [2] Ausstattungsvariante: GT

31	 75.00	Petrol				
GT	4 Cyl.		1272cc	44kW (60)PS	TD4097	721
GOLF	08/83→10/86	JETTA	01/84→10/86	POLO	08/82→07/88	

							
TB107 108x19							
							
BL570 Fibre Composite, 1.730mm	DL570		HBS043 ☉ M11x1.50x95mm (x10)	JD246 ■ JC259 ■ (x2)	JM154	HR569 ■	NA5001 32.00x47.00x10.00mm FPM



BL570

32	75.00	Petrol			
HH	4 Cyl.	8.2:1	1272cc	44kW (60)PS	TD265 721
HH	4 Cyl.	8.2:1	1272cc	44kW (60)PS	TD5010 721
50	08/77→07/78	DERBY	02/77→07/83	POLO	12/76→07/83

B x C x D	OE	MAT.			E x F x G
V90324	036 109 601B		45°	H	VAG92061B
34.10 x 7.96 x 104.15					36.70 x 8.00 x 12.08
V90325	052 109 611A		45°	ss	
28.14 x 7.95 x 104.29					

BL570 Fibre Composite, 1.730mm	DL571	HBS029 M11x1.50x98mm (x10) HBS043 M11x1.50x95mm (x10)	JD246 JC259 (x2)	JM154	HR569	NA5001 (x2) 32.00x47.00x10.00mm FPM



BL570

33	75.00	Petrol			
HJ	4 Cyl.	1272cc	43kW (58)PS	TD16547 721	
HJ	4 Cyl.	1272cc	43kW (58)PS	TD4105 721	
50	01/77→07/78	DERBY	02/77→09/81	POLO	08/82→07/88

BL570 Fibre Composite, 1.730mm	DL571	HBS043 M11x1.50x95mm (x10)	JD246 JC259 (x2)	JM154	HR569	NA5001 32.00x47.00x10.00mm FPM



BL570

34







 75.00





Petrol





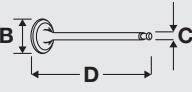





HK 4 Cyl. 9.5:1 1272cc 40kW (54)PS TD5011 719

DERBY 08/83→12/84 GOLF 08/83→06/87 JETTA 01/84→06/87
 POLO 08/83→07/88 SCIROCCO 08/83→07/84

					
TB107 108x19				FOL92 (x8)	

			
B x C x D	OE	MAT.	E x F x G
V90326 ■ 34.10 x 7.97 x 110.80	036 109 601A	MB	VAG92105B ■ ■ 42.30 x 7.99 x 12.08
V90327 ■ 28.14 x 7.95 x 110.00	036 109 611	MD	

							
BL570 Fibre Composite, 1.730mm	DL570		HBS043 ⊕ M11x1.50x95mm (x10)	JD246 ■ JC259 ■ (x2)	JM154	HR569 ■	NA5001 32.00x47.00x10.00mm FPM



BL570

35









 75.00

Petrol



HW 4 Cyl. 9.5:1 1272cc 37kW (50)PS TD4113 717

DERBY 08/83→12/84 POLO 08/83→07/85

							
BL570 Fibre Composite, 1.730mm	DL570		HBS043 ⊕ M11x1.50x95mm (x10)	JD246 ■ JC259 ■ (x2)	JM154	HR569 ■	NA5001 32.00x47.00x10.00mm FPM



BL570

36

75.00

Petrol



MH 4 Cyl. 9.2:1 1272cc 40kW (54)PS TD4131 717

GOLF 08/83→12/92 JETTA 01/84→12/91 POLO 08/83→09/94

TB107 108x19				FOL92 (x8)	

B x C x D	OE	MAT.	45°	ss	H
V91332	030 109 601F		45°		
36.10 x 7.97 x 99.30		MD			
V91473	030 109 611A		45°	ss	H
29.00 x 7.95 x 99.10		MG			
			VAG92061B		
			36.70 x 8.00 x 12.08		

BL570 Fibre Composite, 1.730mm	DL572 →Ch.80-PN-000 000		HBS043 M11x1.50x95mm (x10)	JD246 JC259 (x2)	JN641	HR569	NA5001 32.00x47.00x10.00mm FPM



BL570

37

75.00

Petrol



NU 4 Cyl. 1272cc 37kW (50)PS TD4135 717

GOLF 08/85→12/87

TB107 108x19				FOL92 (x8)	

BL570 Fibre Composite, 1.730mm	DL572		HBS043 M11x1.50x95mm (x10)	JD246 JC259 (x2)	JN641	HR569	NA5001 32.00x47.00x10.00mm FPM



BL570

38







 75.00









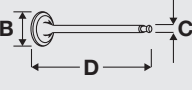

Petrol



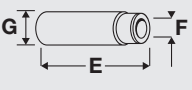

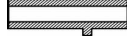





NZ 4 Cyl. 9.5:1 1272cc 40kW (54)PS TD4136 719

GOLF 06/86→12/92 JETTA 06/87→12/91 POLO 07/87→09/94

					
TB107 108x19 →10/90					FOL92 (x8)
TB283 128x19 10/90→					

 B x C x D	OE	MAT.				 E x F x G
V91332 ■ 36.10 x 7.97 x 99.30	030 109 601F	 MD	45°			VAG92061B ■ ■ ■ 36.70 x 8.00 x 12.08 
V94305 ■ 32.00 x 8.00 x 99.30	030 109 601E	 MD cr	45°	ss		
V94580 ■ 36.00 x 8.00 x 98.80	030 109 601C	 MB	45°		H	
V91473 ■ 29.00 x 7.95 x 99.10	030 109 611A	 MG	45°	ss	H	

							
BL570 Fibre Composite, 1.730mm	DL572 →Ch.80-PN-000 000 DL574 Ch.80-PW-000 001→		HBS043 Ⓞ M11x1.50x95mm (x10)	JD246 ■ JC259 ■ (x2)	JN641	HR569 ■ →Ch.80-NW-500 000 HR816 ■ Ch.80-PW-000 001→	NA5001 32.00x47.00x10.00mm FPM



BL570

PY 4 Cyl. 1272cc 85kW (115)PS TD5023 717

POLO 01/87→09/94

TB107 108x19 →10/90					FOL92 (x8)
TB283 128x19 10/90→					

B x C x D	E x F x G
OE	
MAT.	
45°	
V91332 ■	VAG92061B ■ ■ ■
36.10 x 7.97 x 99.30	36.70 x 8.00 x 12.08
V91473 ■	
29.00 x 7.95 x 99.10	
030 109 601F	
MD	
030 109 611A	
MG	
45° ss H	

AY930 Fibre Composite	CY930 [14]		HBS043 © M11x1.50x95mm (x10)	JD246 ■ JC259 ■ (x2)	JP075	HR816 ■	NA5001 32.00x47.00x10.00mm FPM

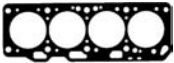

AY930
[14] With shaft oil seal

[14] Mit Wellendichtring

40

75.00

Diesel



MN	4 Cyl.	22:1	1272cc	33kW (45)PS	TD4132	723
MN	4 Cyl.	22:1	1272cc	33kW (45)PS	TD9401	723
POLO	08/86→08/90		TERRA	03/90→12/94		

TB254 71x17.8 Driven unit: injection pump	TB255 107x20 Driven unit: camshaft				FOL92 (x8)

B x C x D	OE	MAT.	45°	Y	H
V91475	030 109 601		45°	Y	H
34.10 x 7.97 x 99.10					
V91473	030 109 611A		45°	ss	H
29.00 x 7.95 x 99.10					
					VAG92061B
					36.70 x 8.00 x 12.08

BV460 Fibre Composite, 1.530mm, 1 Notch	DV460		HBS018	JD246	JN641	HR569	NA5001
BV471 Fibre Composite, 1.570mm, 2 Notches			M12x1.75x115mm (x10)	JC259			32.00x47.00x10.00mm FPM
BV481 Fibre Composite, 1.610mm, 3 Notches							



BV460 BV471 BV481

41

75.00

Petrol



EP	4 Cyl.	8.25/9:1	1297cc	44kW (60)PS	TD257	724
EP	4 Cyl.	8.25/9:1	1297cc	44kW (60)PS	TD5158	724
80	09/78→07/86		PASSAT	08/80→07/86		



TB108 121x18	TBK016				FOL91 (x8)









B x C x D	OE	MAT.	45°	ss	H
V91415	049 109 601K		45°	ss	H
34.10 x 7.97 x 98.70					
					VAG92105B
					42.30 x 7.99 x 12.08

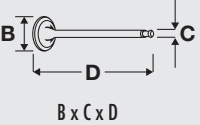



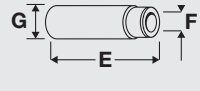



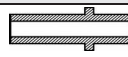



	DL581 →07/83		HBS029	JC478	HL457	HR569	NA5001
			M11x1.50x98mm (x10)	PA459	(Cork)		32.00x47.00x10.00mm FPM
				(NBR)	HM5053		→07/83
				JC152	(ACM)		
				(x4)			
				JE904			

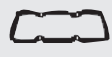

[9] Centering Diameter [mm]: 8.5
[10] Centering Diameter [mm]: 6.5









[9] Zentrierdurchmessers [mm]: 8.5
[10] Zentrierdurchmessers [mm]: 6.5

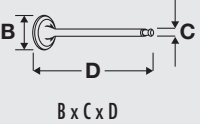



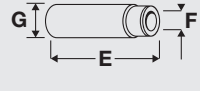



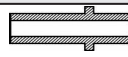



42	 75.00	Petrol				
ZA	4 Cyl.	8.5:1	1297cc	40kW (54)PS	TD4214	725
ZA	4 Cyl.	8.5:1	1297cc	40kW (54)PS	TD5036	725
80	05/72→07/78	PASSAT	05/73→01/78			

 <p>B x C x D</p>	<p>OE</p>  <p>MAT.</p>  <p>45°</p>  <p>ss</p>  <p>H</p>	 <p>E x F x G</p>
<p>V91415 </p> <p>049 109 601K</p> <p>34.10 x 7.97 x 98.70</p> 		<p>VAG92061B </p> <p>36.70 x 8.00 x 12.08</p> 

							
DL580		HBS029 	JC478 	HL456 	HR569 	NA5001	
		M11x1.50x98mm (x10)	JC152 	(Cork)		32.00x47.00x10.00mm FPM	

43	 75.00	Petrol				
ZF	4 Cyl.	8.5:1	1297cc	44kW (60)PS	TD368	725
ZF	4 Cyl.	8.5:1	1297cc	44kW (60)PS	TD5140	725
80	05/72→07/78	PASSAT	05/73→01/78			

 <p>B x C x D</p>	<p>OE</p>  <p>MAT.</p>  <p>45°</p>  <p>ss</p>  <p>H</p>	 <p>E x F x G</p>
<p>V91415 </p> <p>049 109 601K</p> <p>34.10 x 7.97 x 98.70</p> 		<p>VAG92061B </p> <p>36.70 x 8.00 x 12.08</p> 

							
DL580		HBS043 	JC478 	HL456 	HR569 	NA5001	
		M11x1.50x95mm (x10)	JC152 	(Cork)		32.00x47.00x10.00mm FPM	







44











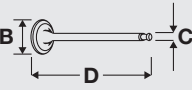

 75.00

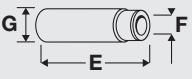

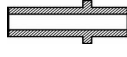





Petrol



ABD	4 Cyl.	9.2:1	1390cc	44kW (60)PS	TD3574	714
ABD	4 Cyl.	9.2:1	1390cc	44kW (60)PS	TD4973	714
CORDOBA	06/94→06/99		GOLF	10/91→04/99	IBIZA	09/93→08/99
VENTO	11/91→09/98					

					
TB283					FOL143 (x8)
128x19					

 B x C x D	OE	MAT.				 E x F x G
V91332 ■	030 109 601F	 MD	45°			VAG92061B ■ ■ E 36.70 x 8.00 x 12.08 
V94305 ■	030 109 601E	 MD cr	45°	ss		VAG96161B ■ ■ E 36.50 x 7.00 x 11.80 
V94308 ■	030 109 601G	 MB	45°	Y	H	
V91473 ■	030 109 611A	 MG	45°	ss	H	
V94309 ■	030 109 611D	 MD	45°			

							
BL570 Fibre Composite, 1.730mm	DL574 →Eng.ABD558154 DL573 Eng.ABD558155→		HBS043 ⊕ M11x1.50x95mm (x10)	JD246 ■ JC259 ■ (x2)	JP074 HM5062 ■	HR569 ■ →07/92 HR816 ■ 08/92→	NA5001 32.00x47.00x10.00mm FPM

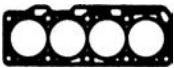

BL570







45









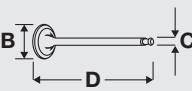
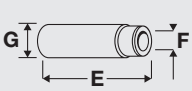

 75.00















Diesel



1W	4 Cyl.	22.5:1	1398cc	35kW (47)PS	TD4959	726
1W	4 Cyl.	22.5:1	1398cc	35kW (47)PS	TD9402	726
POLO	08/90→09/94	TERRA		10/90→12/95		

					
TB254 71x17.8 Driven unit: injection pump					FOL92 (x8)
TB255 107x20 Driven unit: camshaft					

						
B x C x D	OE	MAT.	45°	Y	H	E x F x G
V91475  34.10 x 7.97 x 99.10	030 109 601		45°	Y	H	VAG92061B  36.70 x 8.00 x 12.08
V91473  29.00 x 7.95 x 99.10	030 109 611A		45°	ss	H	

							
BV460 Fibre Composite, 1.530mm, 1 Notch	DV460 		HBS018  M12x1.75x115mm (x10)	JD246  JC259  (x2)	JN641	HR569  HR816  Ch.80-PW-000 001→	NA5001 (x2) 32.00x47.00x10.00mm FPM
BV471 Fibre Composite, 1.570mm, 2 Notches							
BV481 Fibre Composite, 1.610mm, 3 Notches							











46

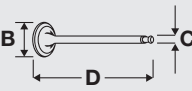
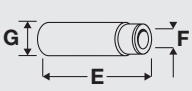



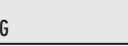







 75.50

Petrol



AMG	4 Cyl.	1289cc	40kW (54)PS	TD13828	727
FELICIA	10/94→06/01				

						
B x C x D	OE	MAT.	45°	Y	H	E x F x G
V94418  34.00 x 7.00 x 101.40	047 198 601D		45°	Y	H	
V94419  30.00 x 7.00 x 101.40	047 109 611D		45°	ss	H	

							
BT580 Fibre Composite	DT580		HBS173  M11x1.50x168mm (x7) M11x1.50x133mm (x1) M11x1.50x182mm (x2)	JD246  JC259  (x2)	JM5285	HR569 	

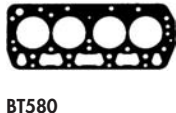

BT580

47

75.50

Petrol



AMH 4 Cyl. 9.7:1 1289cc 50kW (68)PS TD13829 728

FELICIA 10/94 → 06/01

B x C x D	OE	MAT.				E x F x G
V94418	047 198 601D		45°	Y	H	
34.00 x 7.00 x 101.40						
V94419	047 109 611D		45°	ss	H	
30.00 x 7.00 x 101.40						

BT580 Fibre Composite	DT580	HBS173 M11x1.50x168mm (x7) M11x1.50x133mm (x1) M11x1.50x182mm (x2)	JD5766	JM5285	HR569	



BT580

48

75.50

Petrol



AMJ 4 Cyl. 1289cc 43kW (58)PS TD13849 728

FELICIA 10/94 → 06/01

B x C x D	OE	MAT.				E x F x G
V94418	047 198 601D		45°	Y	H	
34.00 x 7.00 x 101.40						

BT580 Fibre Composite		HBS173 M11x1.50x168mm (x7) M11x1.50x133mm (x1) M11x1.50x182mm (x2)		JM5285	HR569	



BT580

49

75.50



Petrol











OHC 4 Cyl. 1289cc 40-45kW (55-61)PS TD4902 728

FAVORIT 08/91 → 06/95



	DT580	HBS173 M11x1.50x168mm (x7) M11x1.50x133mm (x1) M11x1.50x182mm (x2)	JD5766	JM5285		









50	 75.50	Petrol						
CDGA	4 Cyl.	1390cc	110kW (150)PS	Turbo & Supercharged	TD22222	729		
PASSAT	01/09→	TOURAN	05/09→					

							
AH5960 MLS, 0.800mm	CH5960		HBS518 [12]	JD5809 ■■	HR397	PA5041 (x16) 6.00x8.8/12.20x10.00 866N W (FPM)	



AH5960
 [12] Bolt / Nut Version: without plain washer [12] Schrauben-/Mutterausführung: ohne Unterlegscheibe

51	 75.50	Petrol						
AMD	4 Cyl.	10:1	1397cc	44kW (60)PS	TD13868			
OCTAVIA	04/99→03/01							

							
BT580 Fibre Composite	DT581			JD5812 ■■ JD5817 ■■ MLS JD5818 ■■ MLS JD5849 ■■ MLS	JM5285	HR599 ■	



BT580

52









 75.50



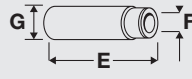

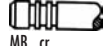

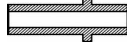

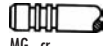



Petrol



AME	4 Cyl.	10:1	1397cc	50kW (68)PS	TD15373
AQW	4 Cyl.	10:1	1397cc	50kW (68)PS	TD16240
ATZ	4 Cyl.	10:1	1397cc	50kW (68)PS	TD15372

FABIA 08/99→05/03

 B x C x D			 OE			 MAT.			 E x F x G		
V94418 	047 198 601D		45°	Y	H	VAG96041B 					
34.00 x 7.00 x 101.40		MB cr				36.50 x 7.00 x 12.08					
V94419 	047 109 611D		45°	ss	H						
30.00 x 7.00 x 101.40		MG cr									

							
BT580 Fibre Composite	DT581			JD5812  JD5817  MLS inner JD5818  MLS JD5849  MLS	JM5285	HR599 	



BT580

53









 75.50

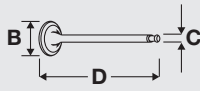

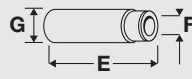

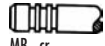

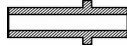

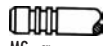



Petrol



AZE	4 Cyl.	10:1	1397cc	44kW (60)PS	TD16049
AZF	4 Cyl.	10:1	1397cc	44kW (60)PS	TD16239

FABIA 04/00→03/03

 B x C x D			 OE			 MAT.			 E x F x G		
V94418 	047 198 601D		45°	Y	H	VAG96062B 					
34.00 x 7.00 x 101.40		MB cr				33.00 x 7.02 x 15.00					
V94419 	047 109 611D		45°	ss	H						
30.00 x 7.00 x 101.40		MG cr									

							
BT580 Fibre Composite	DT581			JD5812  JD5817  MLS inner JD5818  MLS JD5849  MLS	JM5285	HR599 	



BT580



ANY	3 Cyl.	19.5:1	1191cc	45kW (61)PS	Turbo Intercooled	TD12029	730
ANY	3 Cyl.	19.5:1	1191cc	45kW (61)PS		TD17157	730
A2	03/01→08/05	LUPO		07/99→07/05			

TB726 117x30				FOL114 (x6)	

	OE	MAT.				
B x C x D					E x F x G	
V94651 ■ 35.90 x 7.00 x 89.60 →11/00	045 109 601	MB	45°	Y	H	VAG96041B ■ ■ ■ 36.50 x 7.00 x 12.08
V94416 ■ 36.00 x 7.00 x 89.60 12/00→		MB	45°		H	
V94652 ■ 31.40 x 7.00 x 89.60 →11/00	045 109 611	MG	45°	ss	H	
V94417 ■ 31.50 x 7.00 x 89.60 12/00→		MG	45°	ss	H	

AC5190 MLS, 1.450mm, 1 Hole AC5200 MLS, 1.530mm, 2 Holes AC5210 MLS, 1.610mm, 3 Holes	CC5190 ▲ [14]	HBS311 ⊙ M12x1.75x115mm (x8)	JD5278 ■ JD5279 ■ JE5036 ■ MLS	JM7032	HR5068 ■	NA5124 32.00x47.00x10.00mm PTFE/ACM

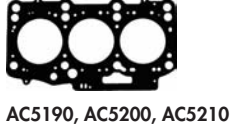

[14] With shaft oil seal [14] Mit Wellendichtring

55

76.50

Diesel



AYZ 3 Cyl. 19.5:1 1191cc 45kW (61)PS Turbo Intercooled TD15494 730

LUPO 07/99→07/05

TB726 117x30					FOL114 (x6)

B x C x D	OE	MAT.	45°	Y	H
V94651 ■ 35.90 x 7.00 x 89.60	045 109 601		45°	Y	H
V94652 ■ 31.40 x 7.00 x 89.60	045 109 611		45°	ss	H
					VAG96041B ■ ■ ■ 36.50 x 7.00 x 12.08

AC5190 MLS, 1.450mm, 1 Hole AC5200 MLS, 1.530mm, 2 Holes AC5210 MLS, 1.610mm, 3 Holes	CC5190 ▲ [14]		HBS311 ⊕ M12x1.75x115mm (x8)	JD5278 ■ JD5279 ■ JE5036 ■ MLS	JM7032	HR5068 ■	NA5124 32.00x47.00x10.00mm PTFE/ACM

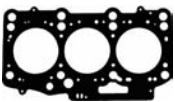

AC5190, AC5200, AC5210

[14] With shaft oil seal

[14] Mit Wellendichtring

56

76.50

Petrol



AWY 3 Cyl. 10.3:1 1198cc 40kW (54)PS TD16334

AWY 3 Cyl. 10.3:1 1198cc 40kW (54)PS TD16524

FABIA 07/01→03/08

POLO

04/01→05/07

					FOL167 (x6)

B x C x D	OE	MAT.	45°	Y	H
V94646 ■ 34.50 x 6.00 x 99.10	032 109 601M		45°	Y	H
V94405 ■ 28.00 x 6.00 x 99.10	030 109 611T		45°	ss	H
					VAG96073B ■ ■ ■ 36.00 x 6.02 x 11.06

AG8840 MLS	CG8840		HBS479 ⊕ M9x1.25x162mm (x8)	JD5807 ■ (x3) JD5819 ■	HR397	PA5041 (x6) 6.00x8.8/12.20x10.00 866N W (FPM) HL5002 ■	

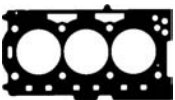

AG8840

57

76.50

Petrol



AZQ	3 Cyl.	10.5:1	1198cc	47kW (64)PS	TD16333
AZQ	3 Cyl.	10.5:1	1198cc	47kW (64)PS	TD16459
AZQ	3 Cyl.	10.5:1	1198cc	47kW (64)PS	TD17070
BME	3 Cyl.	10.5:1	1198cc	47kW (64)PS	TD18156
BME	3 Cyl.	10.5:1	1198cc	47kW (64)PS	TD18836
BME	3 Cyl.	10.5:1	1198cc	47kW (64)PS	TD20510
BZG	3 Cyl.		1198cc	51kW (70)PS	TD20010
BZG	3 Cyl.		1198cc	51kW (70)PS	TD20141
BZG	3 Cyl.		1198cc	51kW (70)PS	TD20839
CGPA	3 Cyl.	10.5:1	1198cc	51kW (70)PS	TD23102
CGPA	3 Cyl.	10.5:1	1198cc	51kW (70)PS	TD23138
CGPA	3 Cyl.	10.5:1	1198cc	51kW (70)PS	TD23524

CORDOBA	10/02 → 06/06	FABIA	01/03 →	IBIZA	02/02 →
POLO	10/01 →	ROOMSTER	05/06 →	ROOMSTER Praktik	03/07 →

				FOL179 (x12)	FOL167 (x12)

<p>V94116 ■</p> <p>29.50 x 6.00 x 100.90</p> <p>V94117 ■</p> <p>26.00 x 6.00 x 100.50</p>	<p>VAG96073B ■ ■ ■</p> <p>36.00 x 6.02 x 11.06</p>
<p>OE: 036 109 601S</p> <p>MAT. MB, MG</p> <p>45° Y H</p>	

AF5990 MLS	CF5990	HBS471 ⊕ M9x1.25x138mm (x8)	JD5811 ■ (x3) JD5816 ■	HR397	PA5041 (x12) 6.00x8.8/12.20x10.00 866N W (FPM) HR280 ■

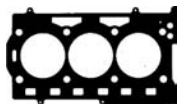

AF5990

58

76.50
Petrol

BBM	3 Cyl.	10.5:1	1198cc	44kW (60)PS	TD20009
BBM	3 Cyl.	10.5:1	1198cc	44kW (60)PS	TD20142
BBM	3 Cyl.	10.5:1	1198cc	44kW (60)PS	TD21594
CHFA	3 Cyl.	10.5:1	1198cc	44kW (60)PS	TD23101
CHFA	3 Cyl.	10.5:1	1198cc	44kW (60)PS	TD23098
CHFA	3 Cyl.	10.5:1	1198cc	44kW (60)PS	TD23439

FABIA	12/06→	FOX	09/10→	IBIZA	06/07→05/08
POLO	05/07→11/09				

 B x C x D OE MAT.			 Ex F x G			
V94646	032 109 601M		45°	Y	H	VAG96073B 36.00 x 6.02 x 11.06
V94405	030 109 611T		45°	ss	H	

AG8840 MLS	CG8840	HBS479 M9x1.25x162mm (x8)	JD5808 (x3) JD5819	HR397	PA5041 (x6) 6.00x8.8/12.20x10.00 866N W (FPM) HL5002	



AG8840

59

76.50
Petrol

BMD	3 Cyl.	10.3:1	1198cc	40kW (54)PS	TD18155
BMD	3 Cyl.	10.3:1	1198cc	40kW (54)PS	TD18835

FABIA	07/01→03/08	FOX	04/05→	POLO	01/02→05/07
-------	-------------	-----	--------	------	-------------

 B x C x D OE MAT.			 Ex F x G			
V94646	032 109 601M		45°	Y	H	VAG96073B 36.00 x 6.02 x 11.06
V94405	030 109 611T		45°	ss	H	

AG8840 MLS	CG8840	HBS479 M9x1.25x162mm (x8)	JD5807 (x3) →Ch.9N 5044100 JD5808 (x3) Ch.9N 5044101→ JD5819	HR397	PA5041 (x6) 6.00x8.8/12.20x10.00 866N W (FPM) HL5002	



AG8840

60

76.50

Petrol



BXV	3 Cyl.	10.5:1	1198cc	51kW (70)PS	TD19426
CORDOBA	05/06 → 11/09	IBIZA	05/06 → 11/09		

				FOL179 (x12)	FOL167 (x12)

B x C x D	OE	MAT.	45°	Y	H
V94116	036 109 601S		45°	Y	H
29.50 x 6.00 x 100.90		MB			
V94117	036 109 611K		45°		
26.00 x 6.00 x 100.50		MG			
				E x F x G	
				VAG96073B	
				36.00 x 6.02 x 11.06	

AF5990 MLS	CF5990	HBS471	JD5811	HR397	PA5041 (x12)	
		M9x1.25x138mm (x8)	(x3) JD5816		6.00x8.8/12.20x10.00	
					866N W (FPM)	
					HR280	

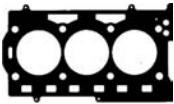

AF5990

61

76.50

Petrol



CEVA	3 Cyl.	10.5:1	1198cc	51kW (70)PS	TD20919
CHTA	3 Cyl.	10.5:1	1198cc	51kW (70)PS	TD24979



FABIA	01/07 →				
--------------	---------	--	--	--	--

B x C x D	OE	MAT.	45°	Y	H
V94116	036 109 601S		45°	Y	H
29.50 x 6.00 x 100.90		MB			
V94117	036 109 611K		45°		
26.00 x 6.00 x 100.50		MG			
				E x F x G	
				VAG96073B	
				36.00 x 6.02 x 11.06	

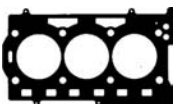





AF5990 MLS	CF5990	HBS471	JD5811	HR397	PA5041 (x12)	
		M9x1.25x138mm (x8)	(x3) JD5816		6.00x8.8/12.20x10.00	
					866N W (FPM)	
					HR280	















AF5990

62	 76.50	Petrol			
CGPB	3 Cyl.	10.5:1	1198cc	44kW (60)PS	TD23097
CGPB	3 Cyl.	10.5:1	1198cc	44kW (60)PS	TD23100
CGPB	3 Cyl.	10.5:1	1198cc	44kW (60)PS	TD24978



FABIA	11/11→	IBIZA	07/09→	POLO	06/09→
--------------	--------	--------------	--------	-------------	--------

					
				FOL179 (x12)	FOL167 (x12)

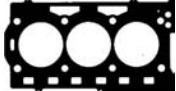











							
AF5990 MLS	CF5990		HBS471  M9x1.25x138mm (x8)	JD5811  (x3) JD5816 	HR397	PA5041 (x12) 6.00x8.8/12.20x10.00 866N W (FPM) HR280 	



AF5990

63	 76.50	Petrol			
CHFB Euro 4	3 Cyl.	10.3:1	1198cc	40kW (54)PS	TD24054

FOX	04/05→				
------------	--------	--	--	--	--

							
AG8840 MLS	CG8840		HBS479  M9x1.25x162mm (x8)	JD5808  (x3) JD5819 	HR397	PA5041 (x6) 6.00x8.8/12.20x10.00 866N W (FPM) HL5002 	



AG8840

64

76.50

Petrol



ADX 4 Cyl. 10:1 1296cc 40kW (54)PS TD4017 731

POLO 10/94→07/95

TB466 135x19	TBK087			FOL143 (x8)

	OE					
V94311 ■ 32.10 x 7.00 x 94.50	030 109 601AA		45°	Y	H	VAG96062B ■ ■ ■ 33.00 x 7.02 x 15.00
V94115 ■ 29.00 x 7.00 x 95.00	032 109 611G		45°		H	

BZ180 MLS, 0.500mm	DZ180 [14]	HBS075 ⊕ M11x1.50x110mm (x10)	JD487 ■ JD488 ■	JP074 HM5062 ■	HR816 ■	NA5001 32.00x47.00x10.00mm FPM

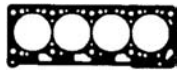

BZ180

[14] With shaft oil seal

[14] Mit Wellendichtring

65

76.50

Petrol



AEX 4 Cyl. 10.2:1 1390cc 44kW (60)PS TD4984 732

AEX 4 Cyl. 10.2:1 1390cc 44kW (60)PS TD5532 732

AROSA 05/97→06/04	CADDY 11/95→01/04	CORDOBA 06/94→06/99
GOLF 10/91→04/99	IBIZA 09/93→08/99	INCA 11/95→06/03
POLO 07/95→09/01	VENTO 11/91→09/98	

TB466 135x19	TBK087	CAM808		FOL143 (x8)

	OE				
V94114 ■ 35.60 x 7.00 x 94.70	030 109 601AH		45°	H	VAG96062B ■ ■ ■ 33.00 x 7.02 x 15.00
V94115 ■ 29.00 x 7.00 x 95.00	032 109 611G		45°	H	

BZ180 MLS, 0.500mm	DZ181	HBS075 ⊕ M11x1.50x110mm (x10)	JD597 ■ ■ ■ JD601 ■	JP074 HM5062 ■	HR816 ■	NA5001 32.00x47.00x10.00mm FPM



BZ180

66

76.50

Petrol



AFH	4 Cyl.	10.5:1	1390cc	74kW (100)PS	TD4986	733
AFH	4 Cyl.	10.5:1	1390cc	74kW (100)PS	TD5534	733
CORDOBA		09/96→06/99		IBIZA	06/97→08/99	
				POLO	04/96→10/99	

TB553					FOL166 (x16)
149x25					

B x C x D	OE	MAT.	45°	Y	H	E x F x G
V94247 ■	036 109 601P					VAG96073B ■ ■ ■
29.50 x 6.00 x 97.90		MB				36.00 x 6.02 x 11.06
V94248 ■	036 109 611L				H	
26.00 x 6.00 x 97.30		MG				

AA5500 MLS	CA5500 [14]		HBS360 ⊕ M11x1.50x142mm (x10)	JD5228 ■ (x4) JD5233 ■ (x1)	HR397	PA5041 (x16) 6.00x8.8/12.20x10.00 866N W (FPM) HR791 ■	NA5001 32.00x47.00x10.00mm FPM

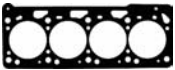

AA5500

[14] With shaft oil seal

[14] Mit Wellendichtring



AFK	4 Cyl.	10.5:1	1390cc	74kW (100)PS	TD12028	734
AFK	4 Cyl.	10.5:1	1390cc	74kW (100)PS	TD13893	734
AHW	4 Cyl.	10.5:1	1390cc	55kW (75)PS	TD15529	735
AHW	4 Cyl.	10.5:1	1390cc	55kW (75)PS	TD9453	735
APE	4 Cyl.	10.5:1	1390cc	55kW (75)PS	TD13268	735
APE	4 Cyl.	10.5:1	1390cc	55kW (75)PS	TD13468	735
AQQ	4 Cyl.	10.5:1	1390cc	74kW (100)PS	TD13469	735
AQQ	4 Cyl.	10.5:1	1390cc	74kW (100)PS	TD15528	735
AUB	4 Cyl.	10.5:1	1390cc	74kW (100)PS	TD13772	735
AUB	4 Cyl.	10.5:1	1390cc	74kW (100)PS	TD15375	735
AUB	4 Cyl.	10.5:1	1390cc	74kW (100)PS	TD16140	735
BBZ	4 Cyl.	10.5:1	1390cc	74kW (100)PS	TD16540	735
BBZ	4 Cyl.	10.5:1	1390cc	74kW (100)PS	TD16541	735
BBZ	4 Cyl.	10.5:1	1390cc	74kW (100)PS	TD17472	735

AROSA	01/00→06/04	BORA	03/00→05/05	CORDOBA	06/99→11/09
FABIA	12/99→03/08	GOLF	08/97→06/06	IBIZA	08/99→11/09
LEON	11/99→06/06	LUPO	09/98→07/05	POLO	10/99→
TOLEDO	07/99→05/06				

TB634 58x17 Driven unit: balance shaft	TBK246 Tensioner 19mm TBK263 Tensioner 18mm			FOL179 (x16)	FOL167 (x16)
TB658 130x20					

V94116 ■ 29.50 x 6.00 x 100.90	036 109 601S	MB	45°	Y	H	VAG96073B ■ ■ ■ 36.00 x 6.02 x 11.06
V94117 ■ 26.00 x 6.00 x 100.50	036 109 611K	MG	45°			

AB5701 MLS	CB5700 ☒	HBS249 ☉ M9x1.25x138mm (x10)	JD5228 ■ (x4) JD5298 ■	HR397	PA5041 (x16) 6.00x8.8/12.20x10.00 866N W (FPM) HR791 ■	NA5180 27.00x42.00x8.00mm FPM



AB5701

68

76.50

Petrol



AKK	4 Cyl.	10.2:1	1390cc	44kW (60)PS	TD13768	736
AKK	4 Cyl.	10.2:1	1390cc	44kW (60)PS	TD13892	736
AROSA	05/97→06/04	CORDOBA		06/99→12/02	IBIZA	08/99→02/02
POLO	12/95→09/01					

TB466 135x19	TBK087 Eng.→127806 TBK320 Eng.127807→				FOL167 (x8)

	OE				
V94404 ■ 33.50 x 6.00 x 99.10	030 109 601AL	MB	45°	H	VAG96073B ■ ■ 36.00 x 6.02 x 11.06
V94405 ■ 28.00 x 6.00 x 99.10	030 109 611T	MG	45°	ss H	

AD5640 MLS, 0.640mm	CD5640 [14]	HBS362 ⊕ M9x1.25x162mm (x10)	JD5318 ■	HR397	PA5041 (x8) 6.00x8.8/12.20x10.00 866N W (FPM) HR817 ■	NA5185 32.00x42.00x7.00mm FPM



AD5640

[14] With shaft oil seal

[14] Mit Wellendichtring



AKP 4 Cyl. 1390cc 40kW (54)PS TD14168 737

POLO 12/98 → 09/01

TB466 135x19	TBK087 →03/00 TBK320 03/00→				FOL167 (x8)

B x C x D	OE	MAT.	45°	H		
V94404 ■ 33.50 x 6.00 x 99.10	030 109 601AL	MB	45°	H	VAG96073B ■ ■ ■ 36.00 x 6.02 x 11.06	
V94405 ■ 28.00 x 6.00 x 99.10	030 109 611T	MG	45°	ss	H	

AD5640 MLS, 0.640mm	CD5640 ☒ [14]		HBS362 Ⓞ M9x1.25x162mm (x10)	JD597 ■ ■ ■ (x4) JD5318 ■	JP074 HM5062 ■	PA5041 (x8) 6.00x8.8/12.20x10.00 866N W (FPM) HR817 ■	NA5185 32.00x42.00x7.00mm FPM



AD5640

[14] With shaft oil seal

[14] Mit Wellendichtring

70

76.50

Petrol



AKQ 4 Cyl. 10.5:1 1390cc 55kW (75)PS TD9454 734

BORA 03/00→05/05 GOLF 08/97→06/06 LUPO 09/98→07/05

TB634 58x17 Driven unit: balance shaft TB658 130x20	TBK246 Tensioner 19mm TBK263 Tensioner 18mm				FOL167 (x16)

	OE	MAT.		Y	H	
V94116 ■ 29.50 x 6.00 x 100.90	036 109 601S		45°			VAG960738 ■ ■ 36.00 x 6.02 x 11.06
V94117 ■ 26.00 x 6.00 x 100.50	036 109 611K		45°			

AB5701 MLS	CB5700 ☒	HBS249 ⊕ M9x1.25x138mm (x10)	JD5228 ■ JD5298 ■		PA5041 (x16) 6.00x8.8/12.20x10.00 866N W (FPM) HR791 ■	NA5180 27.00x42.00x8.00mm FPM

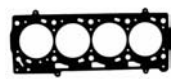

AB5701

71	76.50	Petrol				
AKV	4 Cyl.	10.2:1	1390cc	44kW (60)PS	TD12513	738
AKV	4 Cyl.	10.2:1	1390cc	44kW (60)PS	TD9688	738
AROSA	05/97→06/04	CADDY	11/95→01/04	CORDOBA	06/94→06/99	
IBIZA	09/93→08/99	INCA	11/95→06/03	POLO	07/95→09/01	

TB466 135x19	TBK087	CAM808	FOL143 (x8)

 B x C x D	OE	 MAT.	 45°	 H	 E x F x G
V94114 ■ 35.60 x 7.00 x 94.70	030 109 601AH	 MB cr	45°	H	VAG96062B ■ ■ ■ 33.00 x 7.02 x 15.00
V94115 ■ 29.00 x 7.00 x 95.00	032 109 611G	 MG	45°	H	

BZ180 MLS, 0.500mm	DZ181	HBS075 ⊙ M11x1.50x110mm (x10)	JD597 ■ ■ ■ JD601 ■ (x4)	JP074 HM5062 ■	PA5041 (x8) 6.00x8.8/12.20x10.00 866N W (FPM) HR817 ■	NA5185 32.00x42.00x7.00mm FPM NA5001 32.00x47.00x10.00mm FPM	



BZ180

72	76.50	Petrol				
ANM	4 Cyl.	10.5:1	1390cc	74kW (100)PS	TD13470	739
ANM	4 Cyl.	10.5:1	1390cc	74kW (100)PS	TD13894	739

 B x C x D	OE	 MAT.	 45°	 Y	 H	 E x F x G
V94116 ■ 29.50 x 6.00 x 100.90	036 109 601S	 MB	45°	Y	H	VAG96073B ■ ■ ■ 36.00 x 6.02 x 11.06
V94117 ■ 26.00 x 6.00 x 100.50	036 109 611K	 MG	45°			

AB5701	⊙ JD5228 ■ (x4) JD5298 ■	HR397	PA5041 (x16) 6.00x8.8/12.20x10.00	NA5180 27.00x42.00x8.00mm FPM



AB5701

73

76.50

Petrol



ANW	4 Cyl.	10.2:1	1390cc	44kW (60)PS	TD13274	740
ANW	4 Cyl.	10.2:1	1390cc	44kW (60)PS	TD15568	740
AROSA	05/97→06/04	CORDOBA		06/99→12/02	IBIZA	08/99→02/02
POLO	12/95→09/01					

TB466 135x19	TBK087		KIT		FOL167 (x8)

B x C x D	OE	MAT.
V94404 ■ 33.50 x 6.00 x 99.10	030 109 601AL	 45°
V94405 ■ 28.00 x 6.00 x 99.10	030 109 611T	 45° ss
		 H
		 H
		VAG96073B ■ ■ ■ 36.00 x 6.02 x 11.06

AD5640 MLS, 0.640mm	CD5640 [14]	HBS362 ⊕ M9x1.25x162mm (x10)	JD597 ■ ■ ■ JD5318 ■ ■ ■	HR397	PA5041 (x8) 6.00x8.8/12.20x10.00 866N W (FPM) HR817 ■	NA5185 32.00x42.00x7.00mm FPM	

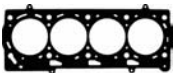

AD5640

[14] With shaft oil seal

[14] Mit Wellendichtring

74

76.50

Petrol



ANX	4 Cyl.	10.2:1	1390cc	44kW (60)PS	TD12514	738
ANX	4 Cyl.	10.2:1	1390cc	44kW (60)PS	TD15613	738
CORDOBA	12/97→04/99	IBIZA	12/97→04/99	POLO	01/98→09/01	

TB466 135x19	TBK087	CAM808			FOL143 (x8)

B x C x D	OE	MAT.	45°	H	E x F x G
V94114 ■ 35.60 x 7.00 x 94.70	030 109 601AH		45°	H	VAG96062B ■ ■ ■ 33.00 x 7.02 x 15.00
V94115 ■ 29.00 x 7.00 x 95.00	032 109 611G		45°	H	

BZ180 MLS, 0.500mm	DZ181		HBS075 ⊙ M11x1.50x110mm (x10)	JD597 ■ ■ ■ JD601 ■	HR397 JP074 HM5062 ■	HR599 ■	NA5001 32.00x47.00x10.00mm FPM

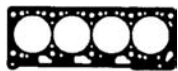

BZ180

75

76.50

Petrol



APQ	4 Cyl.	10.2:1	1390cc	44kW (60)PS	TD12515	738
APQ	4 Cyl.	10.2:1	1390cc	44kW (60)PS	TD15614	738
AROSA	05/97→06/04	CADDY	11/95→01/04	CORDOBA	06/94→06/99	
GOLF	07/93→04/99	IBIZA	09/93→08/99	INCA	11/95→06/03	
POLO	07/95→09/01					

TB466 135x19	TBK087	CAM808			FOL143 (x8)

B x C x D	OE	MAT.	45°	H	E x F x G
V94114 ■ 35.60 x 7.00 x 94.70	030 109 601AH		45°	H	VAG96062B ■ ■ ■ 33.00 x 7.02 x 15.00
V94115 ■ 29.00 x 7.00 x 95.00	032 109 611G		45°	H	

BZ180 MLS, 0.500mm	DZ181		HBS075 ⊙ M11x1.50x110mm (x10)	JD597 ■ ■ ■ JD601 ■	JP074 HM5062 ■	HR817 ■	NA5001 32.00x47.00x10.00mm FPM

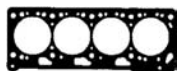

BZ180

76

76.50

Petrol



ARR 4 Cyl. 11.5:1 1390cc 77kW (105)PS TD15492 741

LUPO 02/01 → 07/05

TB634 58x17 Driven unit: balance shaft TB658 130x20	TBK246 Tensioner 19mm		KIT	FOL179 (x16)	FOL167 (x16)

B x C x D	E x F x G
OE	
MAT.	
V94647	VAG96073B
29.55 x 6.00 x 100.90	36.00 x 6.02 x 11.06
V94117	
26.00 x 6.00 x 100.50	
036 109 601AD	
036 109 611K	
45° Y H	
45°	

AB5701 MLS	CB5700		HBS249	JD5809	HR397	PA5041 (x16)	NA5180 (x2)
			M9x1.25x138mm (x10)	JD5298		6.00x8.8/12.20x10.00	27.00x42.00x8.00mm FPM
						866N W (FPM)	
						HR791	

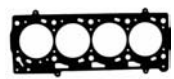

AB5701

77

76.50

Petrol



AUA	4 Cyl.	10.5:1	1390cc	55kW (75)PS	TD13771	735
AUA	4 Cyl.	10.5:1	1390cc	55kW (75)PS	TD15248	735
AUA	4 Cyl.	10.5:1	1390cc	55kW (75)PS	TD15374	735
AUA	4 Cyl.	10.5:1	1390cc	55kW (75)PS	TD16197	735
BBY	4 Cyl.	10.5:1	1390cc	55kW (75)PS	TD16335	735
BBY	4 Cyl.	10.5:1	1390cc	55kW (75)PS	TD16414	735
BBY	4 Cyl.	10.5:1	1390cc	55kW (75)PS	TD16460	735
BBY	4 Cyl.	10.5:1	1390cc	55kW (75)PS	TD17471	735

A2	02/00→08/05	CADDY	08/00→01/04	CORDOBA	06/99→12/07
FABIA	10/99→03/08	IBIZA	05/00→12/07	INCA	04/00→06/03
LEON	11/99→06/06	LUPO	09/98→07/05	POLO	10/99→
TOLEDO	07/99→05/06				

TB634 58x17 Driven unit: balance shaft	TBK246 Tensioner 19mm TBK263 Tensioner 18mm	FOL179 (x16)	FOL167 (x16)
TB658 130x20			

B x C x D	OE	Ex F x G
V94116 ■ 29.50 x 6.00 x 100.90	036 109 601S	VAG96073B ■ ■ ■ 36.00 x 6.02 x 11.06
V94117 ■ 26.00 x 6.00 x 100.50	036 109 611K	
	MAT.	
	45°	
	Y	
	H	
	45°	
	MB	
	MG	

AB5701 MLS	CB5700 ☒	HBS249 ⊕ M9x1.25x138mm (x10)	JD5228 ■ (x4) JD5298 ■	HR397	PA5041 (x16) 6.00x8.8/12.20x10.00 866N W (FPM) HR791 ■	NA5180 27.00x42.00x8.00mm FPM



AB5701

78

76.50

Petrol



AUD	4 Cyl.	10.5:1	1390cc	44kW (60)PS	TD13770	736
AUD	4 Cyl.	10.5:1	1390cc	44kW (60)PS	TD16139	736
AROSA	05/97→06/04				CADDY	11/95→01/04
IBIZA	08/99→02/02				INCA	11/95→06/03
POLO	12/95→09/01				CORDOBA	06/99→12/02
					LUPO	10/00→07/05

TB466 135x19	TBK087				FOL167 (x8)

B x C x D	OE	MAT.	45°	H	E x F x G
V94404	030 109 601AL		45°	H	VAG960738
33.50 x 6.00 x 99.10		MB			36.00 x 6.02 x 11.06
V94405	030 109 611T		45°	ss	
28.00 x 6.00 x 99.10		MG			

AD5640 MLS, 0.640mm	CD5640 [14]	HBS362 (x10)	JD597 (x4) JD5318	HR397	PA5041 (x16) 6.00x8.8/12.20x10.00 866N W (FPM) HR817	NA5185 32.00x42.00x7.00mm FPM

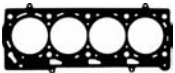

AD5640

[14] With shaft oil seal

[14] Mit Wellendichtring



AXP	4 Cyl.	10.5:1	1390cc	55kW (75)PS	TD15474	734
AXP	4 Cyl.	10.5:1	1390cc	55kW (75)PS	TD16050	734
AXP	4 Cyl.	10.5:1	1390cc	55kW (75)PS	TD16134	734
BCA	4 Cyl.	10.5:1	1390cc	55kW (75)PS	TD16386	743
BCA	4 Cyl.	10.5:1	1390cc	55kW (75)PS	TD16434	743
BCA	4 Cyl.	10.5:1	1390cc	55kW (75)PS	TD17495	743
BKY	4 Cyl.	10.5:1	1390cc	55kW (75)PS	TD18154	745
BKY	4 Cyl.	10.5:1	1390cc	55kW (75)PS	TD18696	745
BKY	4 Cyl.	10.5:1	1390cc	55kW (75)PS	TD18750	745
BXW	4 Cyl.	10.5:1	1390cc	63kW (85)PS	TD19089	750
BXW	4 Cyl.	10.5:1	1390cc	63kW (85)PS	TD19427	750
CGGB	4 Cyl.		1390cc	63kW (85)PS	TD23103	750
CGGB	4 Cyl.		1390cc	63kW (85)PS	TD23136	750
CGGB	4 Cyl.		1390cc	63kW (85)PS	TD24980	750

ALTEA	05/06→	ALTEA XL	10/06→	BORA	03/00→05/05
CADDY	03/04→05/06	CORDOBA	09/02→11/09	FABIA	10/99→
GOLF	08/97→	IBIZA	02/02→	LEON	11/99→
NEW BEETLE	11/01→	OCTAVIA	08/00→12/10	POLO	10/01→
ROOMSTER	09/06→	ROOMSTER Praktik	03/07→	TOLEDO	07/99→05/06

TB634 58x17 Driven unit: balance shaft	TBK246 Tensioner 19mm TBK263 Tensioner 18mm	FOL179 (x16)	FOL167 (x16)
TB658 130x20			

V94116 ■ 29.50 x 6.00 x 100.90	V94117 ■ 26.00 x 6.00 x 100.50	VAG960738 ■ ■ ■ 36.00 x 6.02 x 11.06
OE: 036 109 601S	OE: 036 109 611K	
MAT: MB	MAT: MG	
45°	45°	
Y	H	

AB5701 MLS	CB5700 ☒	HBS249 ☉ M9x1.25x138mm (x10)	JD5228 ■ JD5298 ■	HR397	PA5041 (x16) 6.00x8.8/12.20x10.00 866N W (FPM) HR791 ■	NA5180 27.00x42.00x8.00mm FPM



AB5701

80	76.50	Petrol				
AXU	4 Cyl.	1390cc	63kW (85)PS	TD16430	742	
BAG	4 Cyl.	12:1	1598cc	85kW (115)PS	TD17048	774
BAG	4 Cyl.	12:1	1598cc	85kW (115)PS	TD17069	
A3	08/03→09/07	GOLF	10/03→07/08	POLO	02/02→07/06	
TOURAN	02/03→01/07					

				FOL179 (x16)	FOL167 (x16)

B x C x D	OE	MAT.	45°	Y	H	E x F x G
V94116 ■ 29.50 x 6.00 x 100.90	036 109 601S		45°			VAG96073B ■ ■ ■ 36.00 x 6.02 x 11.06
V94117 ■ 26.00 x 6.00 x 100.50	036 109 611K		45°			

AG8850 MLS	CG8850		HBS249 ⊕ M9x1.25x138mm (x10)	JD5809 ■ JD5814 ■	HR397	PA5041 (x16) 6.00x8.8/12.20x10.00 866N W (FPM) HR791 ■	



AG8850

81	76.50	Petrol					
BAH	4 Cyl.	10.5:1	1598cc	74kW (100)PS	TD26492		
				JD5835 ■ JD5318 ■	HR397	PA5041 6.00x8.8/12.20x10.00 866N W (FPM)	NA5185 32.00x42.00x7.00mm FPM

VW GROUP

82	76.50	Petrol			
BKG	4 Cyl.	12:1	1390cc	66kW (89)PS	TD17181
GOLF	10/03 → 07/06				

				FOL179 (x16)	FOL167 (x16)

B x C x D	OE	MAT.	45°	Y	H
V94116	036 109 601S		45°	Y	H
29.50 x 6.00 x 100.90		MB			
V94117	036 109 611K		45°		
26.00 x 6.00 x 100.50		MG			
				E x F x G	
				VAG96073B	
				36.00 x 6.02 x 11.06	

AG8850 MLS	CG8850		HBS249	JD5809		PA5041 (x16)	
			M9x1.25x138mm (x10)	JD5814		6.00x8.8/12.20x10.00	
						866N W (FPM)	
						HR791	



AG8850

83	76.50	Petrol				
BKR	4 Cyl.	10.5:1	1390cc	55kW (75)PS	TD18271	744
FOX	04/05 →					

			HBS249	JD5318	HR397	PA5041 (x16)	NA5185
			M9x1.25x138mm (x10)			6.00x8.8/12.20x10.00	32.00x42.00x7.00mm FPM
						866N W (FPM)	
						HR791	

84

76.50

Petrol



BLG	4 Cyl.	10:1	1390cc	125kW (170)PS	Turbo & Supercharged	TD18470	746
BMY	4 Cyl.	10:1	1390cc	103kW (140)PS	Turbo & Supercharged	TD18910	746
CAVC	4 Cyl.	10:1	1390cc	103kW (140)PS	Turbo Intercooled	TD22174	749
CAXC	4 Cyl.	9.7:1	1390cc	92kW (125)PS	Turbo	TD20488	752
CAXC	4 Cyl.	9.7:1	1390cc	92kW (125)PS	Turbo	TD20715	752
CAXC	4 Cyl.	9.7:1	1390cc	92kW (125)PS	Turbo	TD22677	752
CMSA	4 Cyl.		1390cc	92kW (125)PS	Turbo Intercooled	TD23936	754

A3	09/07→	ALTEA	11/07→	ALTEA XL	11/07→
GOLF	11/05→	JETTA	07/06→10/10	LEON	11/07→
SUPERB	07/08→	TOURAN	02/06→		

B x C x D	OE	MAT.					E x F x G
V94116	036 109 601S		45°	Y	H		VAG96073B
29.50 x 6.00 x 100.90							36.00 x 6.02 x 11.06
V94117	036 109 611K		45°				
26.00 x 6.00 x 100.50							

AH5960 MLS, 0.800mm	CH5960		HBS518 [12]	JD5809	HR397	PA5041 (x16) 6.00x8.8/12.20x10.00 866N W (FPM) HR791	



AH5960

[12] Bolt / Nut Version: without plain washer

[12] Schrauben-/Mutterausführung: ohne Unterlegscheibe

85

76.50

Petrol



BLN	4 Cyl.	12:1	1390cc	66kW (89)PS		TD18911	746
BLP	4 Cyl.		1598cc	85kW (115)PS		TD17401	774
BLP	4 Cyl.		1598cc	85kW (115)PS		TD18202	774

A3	08/03→	GOLF	10/03→	TOURAN	02/03→01/07
----	--------	------	--------	--------	-------------

B x C x D	OE	MAT.					E x F x G
V94116	036 109 601S		45°	Y	H		VAG96073B
29.50 x 6.00 x 100.90							36.00 x 6.02 x 11.06
V94117	036 109 611K		45°				
26.00 x 6.00 x 100.50							

AG8850 MLS	CG8850		HBS249 M9x1.25x138mm (x10)	JD5809	HR397	PA5041 6.00x8.8/12.20x10.00 866N W (FPM) HR791	



AG8850

86

76.50

Petrol



BUD	4 Cyl.	10.5:1	1390cc	59kW (80)PS	TD18909	748
BUD	4 Cyl.	10.5:1	1390cc	59kW (80)PS	TD20190	748
CADDY	05/06→08/10		FABIA	04/06→12/07	GOLF	05/06→
OCTAVIA	06/04→		POLO	05/06→11/09		

TB634 58x17 Driven unit: balance shaft TB658 130x20	TBK263 Eng.→160000, Tensioner 18mm		KIT	FOL179 (x16)	FOL167 (x16)

B x C x D	E x F x G
V94116 ■ 29.50 x 6.00 x 100.90	VAG96073B ■ ■ ■ 36.00 x 6.02 x 11.06
V94117 ■ 26.00 x 6.00 x 100.50	
OE: 036 109 601S, 036 109 611K	MAT. MB, MG
45°	45°
Y, H	

AB5701 MLS	CB5700 ☒		HBS249 ⊕ M9x1.25x138mm (x10)	JD5228 ■ (x4) JD5298 ■	HR397	PA5041 (x16) 6.00x8.8/12.20x10.00 866N W (FPM) HR791 ■	NA5180 (x2) 27.00x42.00x8.00mm FPM



AB5701

87

76.50

Petrol



BWK	4 Cyl.		1390cc	110kW (150)PS	Turbo Intercooled	TD20734	749
CAVA	4 Cyl.	10:1	1390cc	110kW (150)PS	Turbo & Supercharged	TD22452	749
CAVA	4 Cyl.	10:1	1390cc	110kW (150)PS	Turbo & Supercharged	TD24449	749
CAVE	4 Cyl.	10:1	1390cc	132kW (180)PS	Turbo & Supercharged	TD23095	751
CAVE	4 Cyl.	10:1	1390cc	132kW (180)PS	Turbo & Supercharged	TD24000	751
CAVE	4 Cyl.	10:1	1390cc	132kW (180)PS	Turbo & Supercharged	TD24217	751
CAXA	4 Cyl.	10:1	1390cc	90kW (122)PS	Turbo	TD20606	752
CAXA	4 Cyl.	10:1	1390cc	90kW (122)PS	Turbo	TD21592	752
CAXA	4 Cyl.	10:1	1390cc	90kW (122)PS	Turbo Intercooled	TD24386	752
CAXA	4 Cyl.	10:1	1390cc	90kW (122)PS	Turbo Intercooled	TD27223	752

A1	05/10→	ALHAMBRA	06/10→	EOS	11/07→
FABIA	05/10→	GOLF	05/07→	IBIZA	06/09→
JETTA	05/07→	OCTAVIA	11/08→	PASSAT	05/07→
POLO	05/10→	RAPID	07/12→	SHARAN	05/10→
SCIROCCO	08/08→	TIGUAN	09/07→	TOLEDO	07/12→
YETI	06/10→				

	B x C x D	OE		MAT.					E x F x G
V94116 ■	29.50 x 6.00 x 100.90	036 109 601S		MB	45°	Y	H	VAG96073B ■ ■	36.00 x 6.02 x 11.06
V94117 ■	26.00 x 6.00 x 100.50	036 109 611K		MG	45°				

AH5960 MLS, 0.800mm	CH5960	HBS518 [12]	JD5809 ■ JD5814 ■	HR397	PA5041 (x16) 6.00x8.8/12.20x10.00 866N W (FPM)	HR791 ■

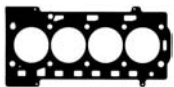

AH5960

[12] Bolt / Nut Version: without plain washer

[12] Schrauben-/Mutterausführung: ohne Unterlegscheibe

88

76.50

Petrol



CAVB	4 Cyl.	10:1	1390cc	125kW (170)PS	Turbo Intercooled	TD22173	749
CAVD	4 Cyl.	10:1	1390cc	118kW (160)PS	Turbo & Supercharged	TD20792	749
BEETLE	04/11→	EOS	05/08→	GOLF	06/08→		
JETTA	07/08→	SCIROCCO	05/08→	TIGUAN	05/11→		
TOURAN	11/06→						

AH5960 MLS, 0.800mm	CH5960	HBS518 [12]	JD5809 ■	PA5041 (x16) 6.00x8.8/12.20x10.00 866N W (FPM)	HR791 ■

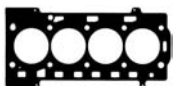

AH5960

[12] Bolt / Nut Version: without plain washer

[12] Schrauben-/Mutterausführung: ohne Unterlegscheibe

89
 **76.50**
Petrol

CAVF	4 Cyl.	1390cc	110kW (150)PS	Turbo & Supercharged	TD23096	751
------	--------	--------	---------------	----------------------	---------	------------

IBIZA 06/09 →

AH5960 MLS, 0.800mm

CH5960
HBS518 [12]

JD5809 ■

HR397
PA5041 (x16)
6.00x8.8/12.20x10.00
866N W (FPM)
HR791 ■

AH5960

[12] Bolt / Nut Version: without plain washer

[12] Schrauben-/Mutterausführung: ohne Unterlegscheibe

90
 **76.50**
Petrol

CDDA	4 Cyl.	1390cc	63kW (85)PS	TD25789	753
------	--------	--------	-------------	---------	------------

CDDA	4 Cyl.	1390cc	63kW (85)PS	TD26495	753
------	--------	--------	-------------	---------	------------

POLO 06/09 →

AB5701 MLS

CB5700 ☒



HBS249 ☉
M9x1.25x138mm (x10)







JD5228 ■ (x4)
JD5298 ■









HR397
PA5041 (x16)
6.00x8.8/12.20x10.00
866N W (FPM)
HR791 ■

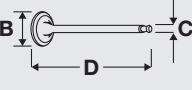
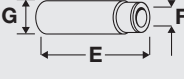











NA5180 (x2)
27.00x42.00x8.00mm FPM

AB5701

91	 76.50	Petrol				
CGGA	4 Cyl.	10.5:1	1390cc	59kW (80)PS	TD20791	750
CGGA	4 Cyl.	10.5:1	1390cc	59kW (80)PS	TD24838	750
GOLF	05/06→	OCTAVIA	06/04→			



					
	.KIT		KIT	FOL179 (x16)	FOL167 (x16)



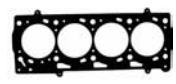





					
B x C x D	OE	MAT.	45°	Y	H
V94116 	036 109 601S		45°	Y	H
29.50 x 6.00 x 100.90		MB			
V94117 	036 109 611K		45°		
26.00 x 6.00 x 100.50		MG			

							
AB5701 MLS	CB5700 		HBS249 	JD5228  (x4) JD5298 	HR397	PA5041 (x16) 6.00x8.8/12.20x10.00 866N W (FPM) HR791 	NA5180 (x2) 27.00x42.00x8.00mm FPM



AB5701

92	 76.50	Petrol			
CLPA	4 Cyl.	1390cc	63kW/85PS	TD25868	753
CLPA	4 Cyl.	1390cc	63kW/85PS	TD26496	753
CLPA	4 Cyl.	1390cc	63kW/85PS	TD26336	753
POLO	06/09→				

							
---	---	---	---	---	---	---	---



AH5960 MLS, 0.800mm	CH5960		HBS518 [12]	HR397	PA5041 (x16) 6.00x8.8/12.20x10.00 866N W (FPM) HR791 	
----------------------------	---------------	--	--------------------	--------------	---	--





AH5960





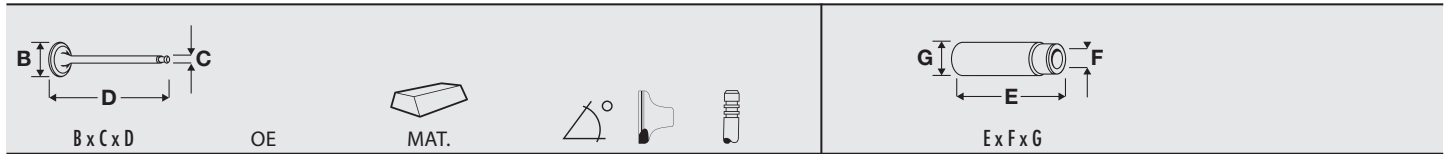





[12] Bolt / Nut Version: without plain washer



[12] Schrauben-/Mutterausführung: ohne Unterlegscheibe

93	 76.50	Petrol				
FB	4 Cyl.	8.2:1	1470cc	55kW (75)PS	TD4077	755
YJ	4 Cyl.	8.2:1	1471cc	55kW (75)PS	TD4213	756
YJ	4 Cyl.	8.2:1	1471cc	55kW (75)PS	TD5033	756
80	05/72→08/75	PASSAT	07/73→12/75	SCIROCCO	02/74→08/75	





V91415 	049 109 601K	VAG92061B 	
34.10 x 7.97 x 98.70		36.70 x 8.00 x 12.08	



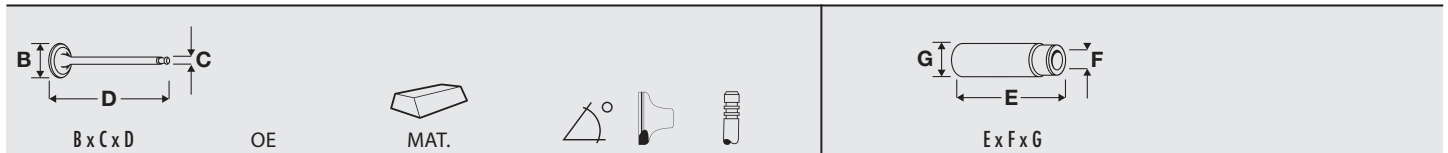







							
	DL580			JC478 	HL456 	(Cork)	
				JC152  (x4)			
				JE904			



94	 76.50	Petrol				
FD	4 Cyl.	9.7:1	1470cc	63kW (85)PS	TD21346	755
FD	4 Cyl.	9.7:1	1470cc	63kW (85)PS	TD3584	755









V91415 	049 109 601K		
34.10 x 7.97 x 98.70			









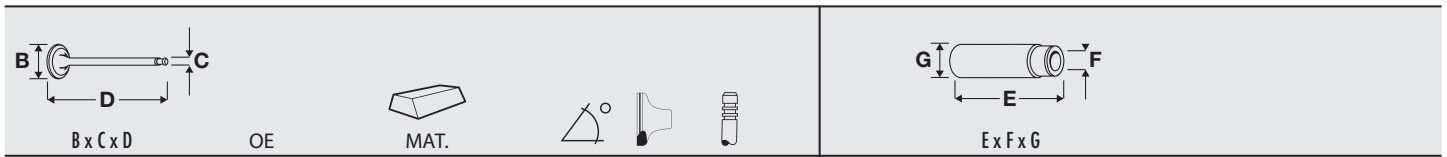

95	 76.50	Petrol				
FF	4 Cyl.	7.5:1	1471cc	48kW (65)PS	TD4078	755

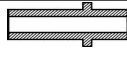

							
	DL580			JC478 	HL456 	(Cork)	
				JC152  (x4)			
				JE904			

96	 76.50	Petrol				
FH	4 Cyl.	9.7:1	1471cc	51kW (70)PS	TD4080	755
GOLF	04/74→12/75	SCIROCCO	02/74→12/75			









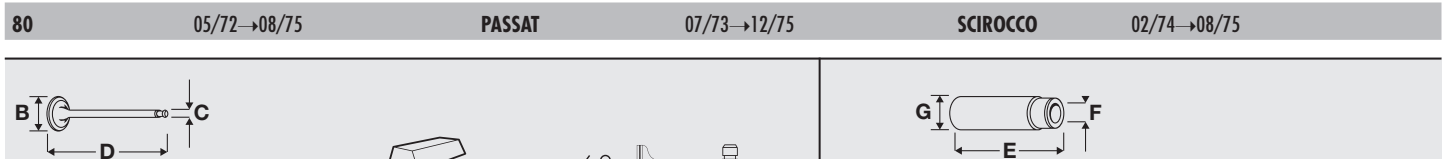

					
TB108 121x18	TBK016		KIT		

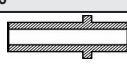



V91415 ■ 34.10 x 7.97 x 98.70	OE 049 109 601K	 MAT.  MB	45° ss H	VAG92061B ■ ■ ■ 36.70 x 8.00 x 12.08			
							
	DL580		HBS043 ⊕ M11x1.50x95mm (x10)	JC478 ■ JC152 ■ (x4) ■ JE904	HL456 ■ (Cork)		









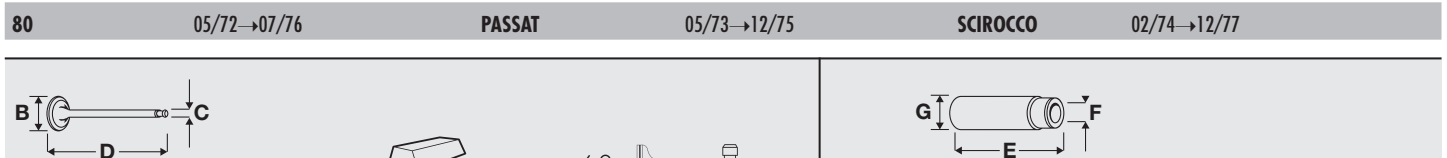

97	 76.50	Petrol				
ZB	4 Cyl.	8.1:1	1471cc	55kW (75)PS	TD366	756
ZB	4 Cyl.	8.1:1	1471cc	55kW (75)PS	TD5037	756
80	05/72→08/75	PASSAT	07/73→12/75	SCIROCCO	02/74→08/75	

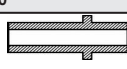

V91415 ■ 34.10 x 7.97 x 98.70	OE 049 109 601K	 MAT.  MB	45° ss H	VAG92061B ■ ■ ■ 36.70 x 8.00 x 12.08			
							
	DL580			JC478 ■ JC152 ■ (x4)	HL456 ■ (Cork)		

98	 76.50	Petrol				
ZC	4 Cyl.	9.7:1	1471cc	63kW (85)PS	TD367	756
ZC	4 Cyl.	9.7:1	1471cc	63kW (85)PS	TD5141	756
80	05/72→07/76	PASSAT	05/73→12/75	SCIROCCO	02/74→12/77	



V91415 ■ 34.10 x 7.97 x 98.70	OE 049 109 601K	 MAT.  MB	45° ss H	VAG92061B ■ ■ ■ 36.70 x 8.00 x 12.08			
							
	DL580		HBS029 ⊕ M11x1.50x98mm (x10)	JC478 ■ JC152 ■ (x4)	HL456 ■ (Cork)		

99







 76.50









Diesel

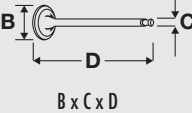



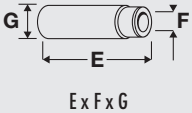











CK 4 Cyl. 23.5:1 1471cc 37kW (50)PS TD4046 757

GOLF 08/76 → 07/80 JETTA 08/78 → 07/80 PASSAT 02/77 → 07/80

					
TB225 135x25.4	TBK018		KIT		

	OE				
V35292 	068 109 601		45°	H	VAG92061B 
34.10 x 7.97 x 105.00					36.70 x 8.00 x 12.08

							
BN070 Fibre Composite, 1.600mm, 5 Notches	DD501 ▲			JC478  JC152  (x4) JE904 	HL456  (Cork) HL457  [9] (Cork) HM5053  [10] (ACM)	HR569  (Cork)	NA5001 (x2) 32.00x47.00x10.00mm FPM



BN070

[9] Centering Diameter [mm]: 8.5

[9] Zentrierdurchmessers [mm]: 8.5

[10] Centering Diameter [mm]: 6.5

[10] Zentrierdurchmessers [mm]: 6.5

100







 76.50









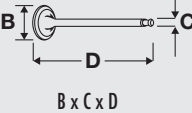

Petrol



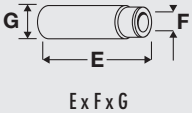











AHS 4 Cyl. 1588cc 55kW (75)PS TD12948 758

POLO 10/94 → 10/99

					
TB467 137x19	TBK088		KIT		

	OE				
V94114 	030 109 601AH		45°	H	VAG96062B 
35.60 x 7.00 x 94.70					33.00 x 7.02 x 15.00
V94115 	032 109 611G		45°	H	
29.00 x 7.00 x 95.00					

						
BZ180 MLS, 0.500mm	DZ181	HBS075  (M11x1.50x110mm (x10))	JD601 	JP074  HM5062 	HR816  (Cork)	NA5001 (x2) 32.00x47.00x10.00mm FPM

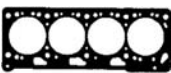

BZ180

101

76.50

Diesel



TV	4 Cyl.	23:1	1588cc	44kW (60)PS	Turbo	TD3996	759
MF	4 Cyl.	23:1	1588cc	51kW (70)PS	Turbo	TD4130	759
GOLF	08/83→10/91		JETTA	01/84→10/91			

TB225 135x25.4	TBK018	CAM393		FOL92 (x8)

 B x C x D	OE	MAT.				 E x F x G
V91367	068 109 601N		45°	ss	H	VAG92061B
34.10 x 7.97 x 95.10		MG				36.70 x 8.00 x 12.08
V91368	068 109 611L		45°		H	
31.30 x 7.95 x 95.00		MG				
V91409	069 109 611		45°		H	
31.30 x 7.95 x 95.10		MG				

BN940 Fibre Composite, 1.530mm, 1 Hole BN950 Fibre Composite, 1.570mm, 2 Holes BN960 Fibre Composite, 1.610mm, 3 Holes	DD502 ▲	HBS018 ⊕ M12x1.75x115mm (x10)	JC243 JC152 (x4)	HL457 [9] (Cork) HM5053 [10] (ACM)	HR569	NA5001 32.00x47.00x10.00mm FPM

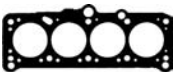

BN940, BN950, BN960

[9] Centering Diameter [mm]: 8.5
[10] Centering Diameter [mm]: 6.5

[9] Zentrierdurchmessers [mm]: 8.5
[10] Zentrierdurchmessers [mm]: 6.5

102

76.50

Diesel



CR	4 Cyl.	23:1	1588cc	40kW (54)PS	TD248	762
CR	4 Cyl.	23:1	1588cc	40kW (54)PS	TD4992	762
80	08/80→08/86	GOLF	08/80→07/83	JETTA	08/80→02/84	
PASSAT	02/79→03/88	SANTANA	08/81→12/84			

TB225 135x25.4	TBK018		KIT		FOL91 (x8)

V90179 ■ 34.00 x 7.97 x 104.80	V90180 ■ 31.32 x 7.94 x 104.60	VAG92061B ■ ■ ■ 36.70 x 8.00 x 12.08
OE: 068 109 601C	MAT. MB MD	
45°	45°	

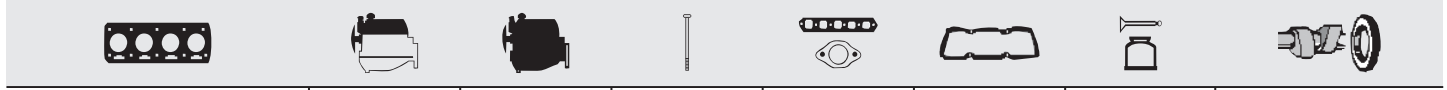

BH720 Fibre Composite, 1.500mm, 2 Holes [4] →03/81 ⊖(0.83)→0.92mm	DD501 ▲	HBS018 ⊕ M12x1.75x115mm (x10)	JC478 ■ JC152 ■ (x4) ⊖JE160	HL457 ■ [9] (Cork) HM5053 ■ [10] (ACM) 08/80→07/85	HR569 ■	NA5001 (x2) 32.00x47.00x10.00mm FPM
BT020 Fibre Composite, 1.530mm, 1 Notch						
BH730 Fibre Composite, 1.600mm, 3 Notches, 3 Holes [4] →03/81 ⊖(0.93) mm→(1.02) mm						
BN080 04/81→07/85 Fibre Composite, 1.400mm, 1 Notch						
BN090 1.500mm, 2 Notches 04/81→						
BN100 Fibre Composite, 1.600mm, 3 Notches 04/81→						
BH710 1.400mm, 1 Notch →03/81						



BH710, BH720, BH730 **BN080** **BT020**

[4] Diameter [mm]: 78.5 [4] Durchmesser [mm]: 78.5
 [9] Centering Diameter [mm]: 8.5 [9] Zentrierdurchmessers [mm]: 8.5
 [10] Centering Diameter [mm]: 6.5 [10] Zentrierdurchmessers [mm]: 6.5

103

76.50

Diesel



CS 4 Cyl. 23:1 1588cc 37kW (50)PS TD4048 763

TRANSPORTER 01/81→07/87

TB225 135x25.4	TBK018		KIT		FOL91 (x8)

B x C x D	E x F x G
V35292 ■ 34.10 x 7.97 x 105.00 Ch.→F24-B-152581	VAG92061B ■ ■ ■ 36.70 x 8.00 x 12.08
OE: 068 109 601	
MAT. MB	
45°	
H	
V90179 ■ 34.00 x 7.97 x 104.80 Ch.F24-B-152582→	
OE: 068 109 601C	
MAT. MB	
45°	
H	
V90180 ■ 31.32 x 7.94 x 104.60 Ch.F24-B-152582→	
OE: 068 109 611C	
MAT. MD	
45°	

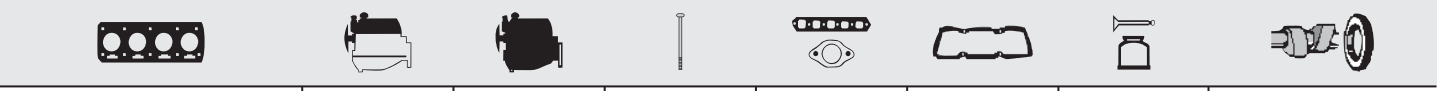

BH720 Fibre Composite, 1.500mm, 2 Holes [4] →04/81 →Eng.CS 000 338 ±0.83→0.92mm	DD501 ▲	HBS018 ⊕ M12x1.75x115mm (x10)	JC478 ■ JC152 ■ (x4) JE160	HL457 ■ [9] (Cork) HM5053 ■ [10] (ACM)	HR569 ■	NA5001 (x2) 32.00x47.00x10.00mm FPM
BH730 Fibre Composite, 1.600mm, 3 Notches, 3 Holes [4] →04/81 ±(0.93) mm→(1.02) mm						
BT020 Eng.CS 000 339→						
BN080 Fibre Composite, 1.400mm, 1 Notch 04/81→07/85						
BN090 Fibre Composite, 1.500mm, 2 Notches 04/81→07/85						
BN100 04/81→07/85						
Fibre Composite, 1.600mm, 3 Notches						
BH710 1.400mm, 1 Notch →04/81						

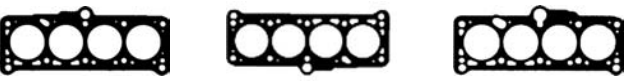

BH710, BH720, BH730 BN080 BT020

[4] Diameter [mm]: 78.5 [4] Durchmesser [mm]: 78.5
 [9] Centering Diameter [mm]: 8.5 [9] Zentrierdurchmessers [mm]: 8.5
 [10] Centering Diameter [mm]: 6.5 [10] Zentrierdurchmessers [mm]: 6.5

104

76.50

Diesel



CY	4 Cyl.	23/23.5:1	1588cc	51kW (70)PS	Turbo	TD4052	764
CY	4 Cyl.	23/23.5:1	1588cc	51kW (70)PS	Turbo	TD4205	764
80	08/81→05/86		90	10/85→01/87	GOLF	03/82→07/83	
JETTA	03/82→02/84		PASSAT	04/82→03/88	SANTANA	12/81→12/84	

TB225 135x25.4	TBK018	CAM393		FOL92 (x8)

 B x C x D	OE	MAT.				 E x F x G
V91173 ■ 34.00 x 7.97 x 104.80	068 109 601D	 MD	45°			VAG92061B ■ ■ ■ 36.70 x 8.00 x 12.08
V91367 ■ 34.10 x 7.97 x 95.10	068 109 601N	 MG	45°	ss	H	
V91174 ■ 31.00 x 7.95 x 104.60	068 109 611D	 MD	45°	ss		
V91409 ■ 31.30 x 7.95 x 95.10	069 109 611	 MG	45°		H	
V94550 ■ 31.15 x 8.00 x 95.05	068 109 611M	 MG cr	45°	ss	H	

BN080 Fibre Composite, 1.400mm, 1 Notch 04/81→07/85	BN090 Fibre Composite, 1.500mm, 2 Notches 04/81→07/85	BN100 1.600mm, 3 Notches 04/81→07/85	BN940 Fibre Composite, 1.530mm, 1 Notch 08/85→	BN950 Fibre Composite, 1.570mm, 2 Notches, 1 Hole 08/85→	BN960 08/85→ Fibre Composite, 1.610mm, 3 Notches, 3 Holes	DD501 ▲	HBS018 ⊙ M12x1.75x115mm (x10)	JC243 ■ JC152 ■ (x4) JE160	HL457 ■ [9] (Cork) HM5053 ■ [10] (ACM)	HR569 ■	NA5001 (x2) 32.00x47.00x10.00mm FPM			

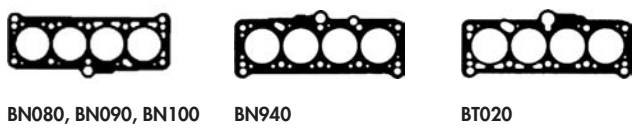

[9] Centering Diameter [mm]: 8.5 [9] Zentrierdurchmessers [mm]: 8.5
 [10] Centering Diameter [mm]: 6.5 [10] Zentrierdurchmessers [mm]: 6.5

105

76.50

Diesel



JK	4 Cyl.	23:1	1588cc	40kW (54)PS	TD5013	765
JK	4 Cyl.	23:1	1588cc	40kW (54)PS	TD269	765
80	08/80→08/91		CADDY	08/82→07/92	GOLF	08/80→07/83
JETTA	08/80→02/84		PASSAT	08/80→03/88	SANTANA	08/81→12/84

TB225	TBK018	CAM393	KIT	FOL92 (x8)
135x25.4				

V91335 ■	V91368 ■	VAG92061B ■ ■ ■
34.10 x 7.97 x 95.00	31.30 x 7.95 x 95.00	36.70 x 8.00 x 12.08
OE: 068 109 601L	OE: 068 109 611L	
MAT. MB	MAT. MG	
45°	45°	
H	H	

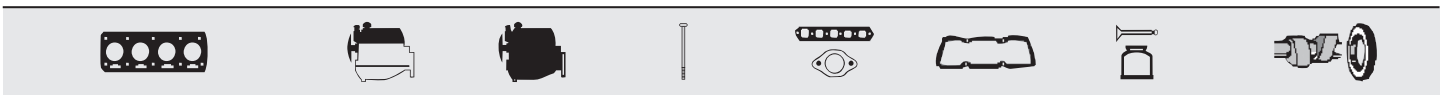

<p>BH720 Fibre Composite, 1.500mm, 2 Holes [4] 08/80→04/81 →Ch.32-B-085 000 ±0.83→0.92mm</p> <p>BH710 1.400mm, 1 Notch 08/80→04/81</p> <p>BH730 Fibre Composite, 1.600mm, 3 Notches, 3 Holes [4] 08/80→04/81 ±(0.93) mm→(1.02) mm</p> <p>BN080 05/81→07/85 Ch.32-B-085 001→Fibre Composite, 1.400mm, 1 Notch</p> <p>BN100 1.600mm, 3 Notches 05/81→07/85</p> <p>BN090 05/81→07/85 Fibre Composite, 1.500mm, 2 Notches</p> <p>BN940 08/85→</p> <p>BN950 Fibre Composite, 1.500mm, 2 Notches 08/85→</p> <p>BN960 08/85→ Fibre Composite, 1.610mm, 3 Notches, 3 Holes</p>	DD501 ▲		<p>HBS018 ⊕ M12x1.75x115mm (x10)</p> <p>HBS246 M10x1.50x120mm (x10)</p>	<p>JC478 ■</p> <p>JC152 ■ (x4)</p> <p>JE160 ●</p>	<p>HL457 ■ [9] (Cork)</p> <p>HM5053 ■ [10] (ACM)</p>	HR569 ■	NA5001 (x2) 32.00x47.00x10.00mm FPM
---	----------------	--	---	--	--	----------------	---

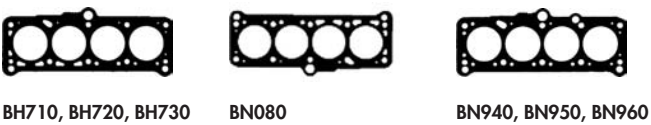

[4] Diameter [mm]: 78.5 [4] Durchmesser [mm]: 78.5
 [9] Centering Diameter [mm]: 8.5 [9] Zentrierdurchmessers [mm]: 8.5
 [10] Centering Diameter [mm]: 6.5 [10] Zentrierdurchmessers [mm]: 6.5



JP	4 Cyl.	1588cc	40kW (54)PS	TD4120	766
GOLF	08/83→10/91	JETTA	01/84→10/91		

TB225 135x25.4	TBK018	CAM393			FOL92 (x8)

B x C x D	E x F x G
V91335 ■ 34.10 x 7.97 x 95.00	VAG92061B ■ ■ ■ 36.70 x 8.00 x 12.08
V91368 ■ 31.30 x 7.95 x 95.00	

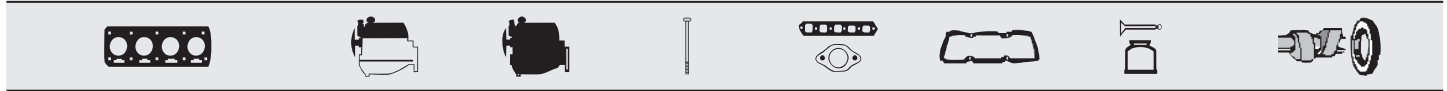

BH720 Fibre Composite, 1.500mm, 2 Holes [4] ±0.83→±0.92mm	DD501 ▲	HBS018 ⊕ M12x1.75x115mm (x10)	JC478 ■ JC152 ■ (x4) ⊕JE160	HL457 ■ [9] (Cork) HM5053 ■ [10] (ACM)	HR569 ■	NA5001 (x2) 32.00x47.00x10.00mm FPM
BH710 1.400mm, 1 Notch						
BH730 Fibre Composite, 1.600mm, 3 Notches, 3 Holes [4] ±(0.93) mm→±(1.02) mm						
BN080 Fibre Composite, 1.400mm, 1 Notch 05/81→07/85						
BN090 Fibre Composite, 1.500mm, 2 Notches 05/81→07/85						
BN100 1.600mm, 3 Notches 05/81→07/85						
BN940 Fibre Composite, 1.530mm, 1 Notch 08/85→07/93						
BN950 Fibre Composite, 1.570mm, 2 Notches, 1 Hole 08/85→07/93						
BN960 08/85→07/93 Fibre Composite, 1.610mm, 3 Notches, 3 Holes						

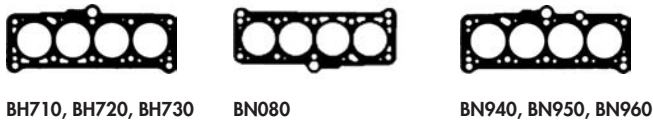

[4] Diameter [mm]: 78.5
 [9] Centering Diameter [mm]: 8.5
 [10] Centering Diameter [mm]: 6.5

[4] Durchmesser [mm]: 78.5
 [9] Zentrierdurchmessers [mm]: 8.5
 [10] Zentrierdurchmessers [mm]: 6.5

107

76.50

Diesel



JR 4 Cyl. 23:1 1588cc 51kW (70)PS Turbo TD4121 759

GOLF 08/83→10/91 JETTA 01/84→10/91

TB225 135x25.4	TBK018	CAM393		FOL92 (x8)

V91367 ■ 34.10 x 7.97 x 95.10	V91409 ■ 31.30 x 7.95 x 95.10	VAG92061B ■ ■ 36.70 x 8.00 x 12.08
OE: 068 109 601N	MG:	
	MAT. 45° ss H	
	45° H	

BN080 Fibre Composite, 1.400mm, 1 Notch →07/85	DD501 ▲	HBS018 ⊕ M12x1.75x115mm (x10)	JC243 ■ JC152 ■ (x4) ⊕ JE160	HL457 ■ [9] (Cork) HM5053 ■ [10] (ACM)	HR569 ■	NA5001 32.00x47.00x10.00mm FPM
BN090 Fibre Composite, 1.500mm, 2 Notches →07/85						
BN100 Fibre Composite, 1.600mm, 3 Notches →07/85						
BN940 Fibre Composite, 1.530mm, 1 Notch 08/85→						
BN950 Fibre Composite, 1.570mm, 2 Notches, 1 Hole 08/85→						
BN960 08/85→ Fibre Composite, 1.610mm, 3 Notches, 3 Holes						



BN080, BN090, BN100 BN940

[9] Centering Diameter [mm]: 8.5

[9] Zentrierdurchmessers [mm]: 8.5

[10] Centering Diameter [mm]: 6.5

[10] Zentrierdurchmessers [mm]: 6.5



JX 4 Cyl. 23.5:1 1588cc 50kW (68)PS Turbo TD5018 759

TRANSPORTER 08/84→07/92

TB225 135x25.4	TBK018				

B x C x D	E x F x G
V91173 ■ 34.00 x 7.97 x 104.80	VAG92061B ■ ■ ■ 36.70 x 8.00 x 12.08
V91174 ■ 31.00 x 7.95 x 104.60	

BT020 Fibre Composite, 1.530mm, 1 Notch	DD502 ▲		HBS018 ⊕ M12x1.75x115mm (x10)	JC243 ■ JC152 ■ (x4)	HL457 ■ [9] (Cork) HM5053 ■ [10] (ACM)	HR569 ■	NA5001 32.00x47.00x10.00mm FPM
BN940 Fibre Composite, 1.530mm, 1 Notch 08/85→							
BN950 Fibre Composite, 1.570mm, 2 Notches, 1 Hole 08/85→							
BN960 Fibre Composite, 1.610mm, 3 Notches, 3 Holes 08/85→							

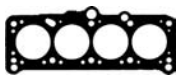

BT020

BN940, BN950, BN960

[9] Centering Diameter [mm]: 8.5

[9] Zentrierdurchmessers [mm]: 8.5

[10] Centering Diameter [mm]: 6.5

[10] Zentrierdurchmessers [mm]: 6.5

109

76.50

Diesel



ME 4 Cyl. 23:1 1588cc 40kW (54)PS TD4129 767

CADDY 08/82→07/92 GOLF 08/83→10/91 JETTA 01/84→10/91

TB225 135x25.4	TBK018	CAM393		FOL92 (x8)

B x C x D	E x F x G
V91335 ■ 34.10 x 7.97 x 95.00	VAG92061B ■ ■ ■ 36.70 x 8.00 x 12.08
V91367 ■ 34.10 x 7.97 x 95.10	
V91368 ■ 31.30 x 7.95 x 95.00	
OE	
MAT.	
45°	
H	
45° ss	
H	
45°	
H	

BH720 Fibre Composite, 1.500mm, 2 Holes [4] →07/85 →Ch.32-B-085 000 ±0.83→0.92mm	DD501 ▲	HBS018 ⊕ M12x1.75x115mm (x10)	JC478 ■ JC152 ■ (x4) JE160	HL457 ■ [9] (Cork) HM5053 ■ [10] (ACM)	HR569 ■	NA5001 (x2) 32.00x47.00x10.00mm FPM
BH730 Fibre Composite, 1.600mm, 3 Notches, 3 Holes [4] →07/85 ±(0.93) mm→(1.02) mm						
BN940 08/85→						
BN950 Fibre Composite, 1.530mm, 1 Hole 08/85→						
BN960 08/85→ Fibre Composite, 1.570mm, 2 Holes Fibre Composite, 1.610mm, 3 Holes						

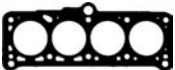

BH720, BH730

BN940

[4] Diameter [mm]: 78.5

[9] Centering Diameter [mm]: 8.5

[10] Centering Diameter [mm]: 6.5

[4] Durchmesser [mm]: 78.5

[9] Zentrierdurchmessers [mm]: 8.5

[10] Zentrierdurchmessers [mm]: 6.5

110

76.50

Diesel



RA	4 Cyl.	23:1	1588cc	59kW (80)PS	Turbo Intercooled	TD313	759
RA	4 Cyl.	23:1	1588cc	59kW (80)PS	Turbo Intercooled	TD5024	759
SB	4 Cyl.	23:1	1588cc	59kW (80)PS	Turbo Intercooled	TD4211	759
SB	4 Cyl.	23:1	1588cc	59kW (80)PS	Turbo Intercooled	TD5028	759

80	09/86→08/91	90	04/87→09/91	GOLF	04/89→10/91
JETTA	04/89→10/91	PASSAT	05/86→09/93		

TB225 135x25.4	TBK018	CAM393		FOL92 (x8)

V91367 ■ 34.10 x 7.97 x 95.10	V91409 ■ 31.30 x 7.95 x 95.10	VAG92061B ■ ■ ■ 36.70 x 8.00 x 12.08
OE: 068 109 601N	OE: 069 109 611	
MAT. MG	MAT. MG	
45° ss H	45° H	

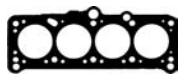

BN940 Fibre Composite, 1.530mm, 1 Hole BN950 Fibre Composite, 1.570mm, 2 Holes BN960 Fibre Composite, 1.610mm, 3 Holes	DD502 ▲	HBS018 ⊕ M12x1.75x115mm (x10)	JC243 ■ JC152 ■ (x4)	HL457 ■ [9] (Cork) HM5053 ■ [10] (ACM)	HR569 ■	NA5001 32.00x47.00x10.00mm FPM		













BN940, BN950, BN960





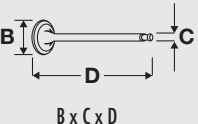

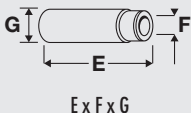

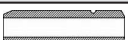
[9] Centering Diameter [mm]: 8.5
[10] Centering Diameter [mm]: 6.5

[9] Zentrierdurchmessers [mm]: 8.5
[10] Zentrierdurchmessers [mm]: 6.5

111	 76.50	Petrol				
ATN	4 Cyl.	11.5:1	1598cc	77kW (105)PS	TD15476	775
ATN	4 Cyl.	11.5:1	1598cc	77kW (105)PS	TD15531	775
AUS	4 Cyl.	12:1	1597cc	77kW (105)PS	TD15477	768
AUS	4 Cyl.	11.5:1	1598cc	77kW (105)PS	TD15788	768
BORA	02/00→05/05	GOLF	02/00→06/06	LEON	09/00→06/06	
TOLEDO	09/00→05/06					

					
TB634 58x17 Driven unit: balance shaft TB658 130x20	TBK246 Tensioner 19mm TBK263 Tensioner 18mm		KIT	FOL179 (x16)	FOL167 (x16)

						
B x C x D	OE	MAT.	45°	Y	H	E x F x G
V94116 ■ 29.50 x 6.00 x 100.90	036 109 601S		45°	Y	H	VAG96073B ■ ■ ■ 36.00 x 6.02 x 11.06
V94117 ■ 26.00 x 6.00 x 100.50	036 109 611K		45°			

							
AC5280 MLS	CC5280 [14]		HBS316 ⊕ M9x1.25x97mm (x10)	JD5373 ■ JD5298 ■ JE5076	HR397	PA5041 (x16) 6.00x8.8/12.20x10.00 866N W (FPM) HR791 ■	NA5180 27.00x42.00x8.00mm FPM



AC5280

[14] With shaft oil seal

[14] Mit Wellendichtring





112









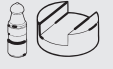

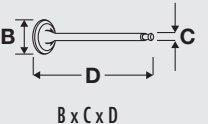
 76.50



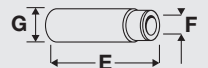

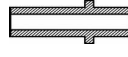

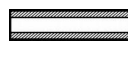





Petrol



ABU	4 Cyl.	9.3:1	1598cc	55kW (75)PS	TD4897	769
ABU	4 Cyl.	9.3:1	1598cc	55kW (75)PS	TD4976	769
CORDOBA	02/93→06/99		GOLF	09/92→12/97	IBIZA	03/93→08/99
VENTO	09/92→09/98					

	 .KIT		 KIT		
TB442 133x19				FOL92 (x8)	

					
B x C x D	OE	MAT.			E x F x G
V94114 	030 109 601AH	 MB cr	45°	H	VAG96041B 
35.60 x 7.00 x 94.70					36.50 x 7.00 x 12.08
V94212 	032 109 601G	 MB	45°	Y	VAG96161B 
34.60 x 7.00 x 94.70					36.50 x 7.00 x 11.80
V94115 	032 109 611G	 MG	45°	H	
29.00 x 7.00 x 95.00					

							
BY620 Fibre Composite	DY620 [14]		HBS075  M11x1.50x110mm (x10)	JD487  JD488   JE154 (x2) [2]	HM5062 		NA5001 32.00x47.00x10.00mm FPM



BY620







[2] Equipment Variant: GT
[14] With shaft oil seal









[2] Ausstattungsvariante: GT
[14] Mit Wellendichtring

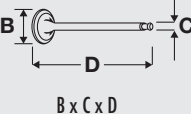



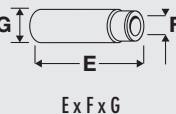

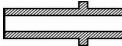





113 76.50 Petrol

AEA	4 Cyl.	9.8:1	1598cc	55kW (75)PS	TD4019	770
-----	--------	-------	--------	-------------	--------	-----

GOLF	09/92→12/97	POLO	10/94→10/99	VENTO	09/92→09/98
------	-------------	------	-------------	-------	-------------

					
TB467 137x19	TBK088 →12/95				FOL143 (x8)

	OE				
V94114  35.60 x 7.00 x 94.70	030 109 601AH	MAT.	45°	H	VAG96041B  36.50 x 7.00 x 12.08
V94115  29.00 x 7.00 x 95.00	032 109 611G	MAT.	45°	H	

						
BZ180 MLS, 0.500mm	DZ180 [14]	HBS075  M11x1.50x110mm (x10)	JD487  JD488 	JP074 HM5062 	HR816 	NA5001 32.00x47.00x10.00mm FPM



BZ180







[14] With shaft oil seal









[14] Mit Wellendichtring

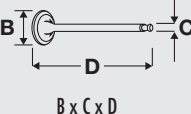



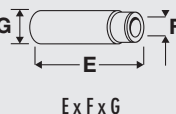







114 76.50 Petrol

AEE	4 Cyl.	9.8:1	1598cc	55kW (75)PS	TD10867	771
AEE	4 Cyl.	9.8:1	1598cc	55kW (75)PS	TD13394	771
AEE	4 Cyl.	9.8:1	1598cc	55kW (75)PS	TD4981	771

CADDY	11/95→12/00	CORDOBA	02/93→06/99	FELICIA	08/95→04/02
GOLF	09/92→12/97	IBIZA	03/93→08/99	INCA	06/97→09/00
OCTAVIA	09/96→09/04	POLO	10/94→09/01	VENTO	09/92→09/98

					
TB467 137x19	TBK088				FOL143 (x8)

	OE				
V94114  35.60 x 7.00 x 94.70	030 109 601AH	MAT.	45°	H	VAG96062B  33.00 x 7.02 x 15.00
V94115  29.00 x 7.00 x 95.00	032 109 611G	MAT.	45°	H	

						
BZ180 MLS, 0.500mm	DZ181	HBS075  M11x1.50x110mm (x10)	JC478  JD597  JD601 	JP074 HM5062 	HR816 	NA5001 32.00x47.00x10.00mm FPM



BZ180



AJV 4 Cyl. 1598cc 88kW (120)PS TD11247 772

POLO 09/98 → 10/99

TB634 58x17 Driven unit: balance shaft TB658 130x20	TBK246 Tensioner 19mm TBK263 Tensioner 18mm		KIT	FOL179 (x16)	FOL167 (x16)

	OE	MAT.				
V94116 ■ 29.50 x 6.00 x 100.90	036 109 601S		45°	Y	H	VAG96073B ■ ■ ■ 36.00 x 6.02 x 11.06
V94647 ■ 29.55 x 6.00 x 100.90	036 109 601AD		45°	Y	H	
V94117 ■ 26.00 x 6.00 x 100.50	036 109 611K		45°			

AC5280 MLS	CC5280 [14]	HBS316 ⊕ M9x1.25x97mm (x10)	JD5373 ■ JD5298 ■ ⊕ JE5076	HR397	PA5041 (x16) 6.00x8.8/12.20x10.00 866N W (FPM) HR791 ■	NA5180 (x2) 27.00x42.00x8.00mm FPM



AC5280

[14] With shaft oil seal

[14] Mit Wellendichtring

116

76.50

Petrol



ALM	4 Cyl.	9.8:1	1598cc	55kW (75)PS	TD12949	773
ALM	4 Cyl.	9.8:1	1598cc	55kW (75)PS	TD15610	773
CORDOBA	02/93→12/02	IBIZA	03/93→02/02	INCA	06/97→09/00	
POLO	11/95→09/01					

TB467 137x19	TBK088		KIT		FOL143 (x8)

B x C x D	OE	MAT.
V94114 ■ 35.60 x 7.00 x 94.70	030 109 601AH	45° H
V94115 ■ 29.00 x 7.00 x 95.00	032 109 611G	45° H
		VAG96062B ■ ■ ■ 33.00 x 7.02 x 15.00

BZ180 MLS, 0.500mm	DZ181	HBS075 ⊕ M11x1.50x110mm (x10)	JD597 ■ ■ ■ JD601 ■	JP074 HM5062 ■	HR816 ■	NA5001 32.00x47.00x10.00mm FPM →Eng.ALM 000 706 NA5185 32.00x42.00x7.00mm FPM Eng.000 707 →

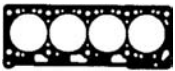

BZ180

117

76.50

Petrol



ARC 4 Cyl. 10.6:1 1598cc 92kW (125)PS TD14169 774

POLO 10/99→09/01

TB634 58x17 Driven unit: balance shaft TB658 130x20	TBK246 Tensioner 19mm TBK263 Tensioner 18mm			FOL179 (x16)	FOL167 (x16)

B x C x D	E x F x G
<p>V94116 ■ 036 109 601S 29.50 x 6.00 x 100.90</p> <p>V94117 ■ 036 109 611K 26.00 x 6.00 x 100.50</p>	<p>VAG96073B ■ ■ ■ 36.00 x 6.02 x 11.06</p>
<p>OE</p> <p>MAT.</p> <p>45° Y H</p> <p>45°</p>	

AC5280 MLS			HBS316 ⊕ M9x1.25x97mm (x10)	JD5373 ■ JD5298 ■ ⊕ JE5076	HR397	PA5041 (x16) 6.00x8.8/12.20x10.00 866N W (FPM) HR791 ■	NA5180 27.00x42.00x8.00mm FPM



AC5280

118

76.50

Petrol



AVY 4 Cyl. 11.5:1 1598cc 92kW (125)PS TD15493 774

Lupo 09/00→07/05 POLO 10/99→09/01

TB634 58x17 Driven unit: balance shaft TB658 130x20	TBK246 Tensioner 19mm TBK263 Tensioner 18mm		KIT	FOL179 (x16)	FOL167 (x16)

V94116 ■ 29.50 x 6.00 x 100.90	V94117 ■ 26.00 x 6.00 x 100.50	OE 036 109 601S 036 109 611K	MAT. MB MG	45°	Y H	VAG96073B ■ ■ 36.00 x 6.02 x 11.06

AC5280 MLS	HBS316 ⊕ M9x1.25x97mm (x10)	JD5373 ■ JD5298 ■ JE5076	HR397	PA5041 (x16) 6.00x8.8/12.20x10.00 866N W (FPM) HR791 ■	NA5180 27.00x42.00x8.00mm FPM	

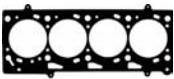

AC5280







119









 76.50

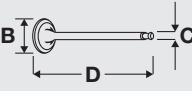





Petrol

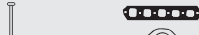

AZD	4 Cyl.	11.5:1	1598cc	77kW (105)PS	TD16131	768
AZD	4 Cyl.	11.5:1	1598cc	77kW (105)PS	TD15478	768
BORA	02/00→05/05		GOLF	02/00→06/06	LEON	09/00→06/06
TOLEDO	09/00→05/06					

					
TB634 58x17 Driven unit: balance shaft TB658 130x20	TBK246 Tensioner 19mm TBK263 Tensioner 18mm			FOL179 (x16)	FOL167 (x16)

						
B x C x D	OE	MAT.	45°	Y	H	E x F x G
V94116 ■ 29.50 x 6.00 x 100.90	036 109 601S		45°			VAG96073B ■ ■ ■ 36.00 x 6.02 x 11.06
V94117 ■ 26.00 x 6.00 x 100.50	036 109 611K		45°			



						
AC5280 MLS	CC5281 [14]	HBS316 ⊕ M9x1.25x97mm (x10)	JD5228 ■ (x4) JD5298 ■ ⊕ JE5076	HR397	PA5041 (x16) 6.00x8.8/12.20x10.00 866N W (FPM) HR791 ■	NA5180 27.00x42.00x8.00mm FPM













AC5280





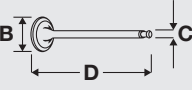

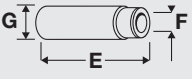

[14] With shaft oil seal

[14] Mit Wellendichtring

120	 76.50	Petrol				
BAD	4 Cyl.	12:1	1598cc	81kW (110)PS	TD16388	774
BAD	4 Cyl.	12:1	1598cc	81kW (110)PS	TD16415	774
A2	05/02→08/05	BORA	01/02→05/05	GOLF	01/02→06/06	



					
TB634 58x17 Driven unit: balance shaft TB658 130x20	TBK246 Tensioner 19mm			FOL179 (x16)	FOL167 (x16)



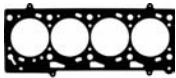

						
B x C x D	OE	MAT.	45°	Y	H	E x F x G
V94116 ■ 29.50 x 6.00 x 100.90	036 109 601S		45°			VAG96073B ■ ■ ■ 36.00 x 6.02 x 11.06
V94117 ■ 26.00 x 6.00 x 100.50	036 109 611K		45°			





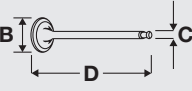

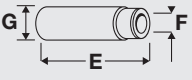

							
AC5280 MLS	CC5282	HBS316 ⊕ M9x1.25x97mm (x10)	JD5809 ■ JD5298 ■	HR397	PA5041 (x16) 6.00x8.8/12.20x10.00 866N W (FPM) HR791 ■	NA5180 27.00x42.00x8.00mm FPM	



AC5280

121	 76.50	Petrol			
BAH	4 Cyl.	10.5:1	1598cc	74kW (100)PS	TD17340
BAH	4 Cyl.	10.5:1	1599cc	74kW (100)PS	TD20801
CORDOBA	04/03→11/09	FOX	10/03→	GOLF	02/01→06/01
IBIZA	02/03→11/09	POLO	08/02→		

						
B x C x D	OE	MAT.	45°	Y	H	E x F x G
V94646 ■ 34.50 x 6.00 x 99.10	032 109 601M		45°			

							
				JD5835 ■ (FPM) JD5318 ■	HR397	PA5041 (x8) 6.00x8.8/12.20x10.00 866N W (FPM) HR817 ■	NA5185 32.00x42.00x7.00mm FPM





122



 76.50





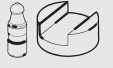

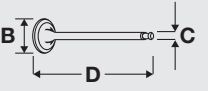
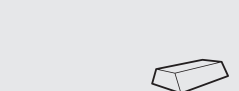
Petrol



BCB	4 Cyl.	11.5:1	1598cc	77kW (105)PS	TD16387	776
BCB	4 Cyl.	11.5:1	1598cc	77kW (105)PS	TD16435	776
BORA	02/00→05/05	GOLF	02/00→06/06	LEON	09/00→06/06	
TOLEDO	09/00→05/06					

					
TB634 58x17 Driven unit: balance shaft	TBK246 Tensioner 19mm TBK263 Tensioner 18mm		KIT		
TB658 130x20					

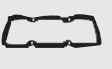
		
B x C x D	OE	MAT.
V94116 ■ 29.50 x 6.00 x 100.90	036 109 601S	45° Y H
V94117 ■ 26.00 x 6.00 x 100.50	036 109 611K	45°
	MB MG	VAG96073B ■ ■ 36.00 x 6.02 x 11.06

						
AC5280 MLS	CC5281 [14]	HBS316 ⊕ M9x1.25x97mm (x10)	JD5228 ■ (x4) JD5298 ■ JE5076	HR397	PA5041 (x16) 6.00x8.8/12.20x10.00 866N W (FPM) HR791 ■	NA5180 27.00x42.00x8.00mm FPM



AC5280

[14] With shaft oil seal

[14] Mit Wellendichtring

123







 **76.50**









Petrol

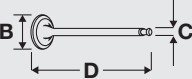
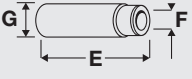













BLF	4 Cyl.	12:1	1598cc	85kW (115)PS	TD17501	774
BLF	4 Cyl.	12:1	1598cc	85kW (115)PS	TD18100	774
BLF	4 Cyl.	12:1	1598cc	85kW (115)PS	TD20713	774

A3	08/03→	EOS	06/06→05/08	GOLF	10/03→07/08
JETTA	09/05→10/10	OCTAVIA	02/04→10/08	PASSAT	03/05→06/08
TOURAN	02/03→01/07				

					
					FOL167 (x16)

						
B x C x D	OE	MAT.				E x F x G
V94116 	036 109 601S		45°	Y	H	VAG96073B 
29.50 x 6.00 x 100.90		MB				36.00 x 6.02 x 11.06
V94117 	036 109 611K		45°			
26.00 x 6.00 x 100.50		MG				

							
AG8850 MLS	CG8850	HBS249  M9x1.25x138mm (x10)	JD5809  JD5814 	HR397	PA5041 (x16) 6.00x8.8/12.20x10.00 866N W (FPM) HR791 		

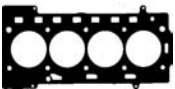

AG8850

124

76.50

Petrol



BTS	4 Cyl.	10.5:1	1598cc	77kW (105)PS	TD19090	774
BTS	4 Cyl.	10.5:1	1598cc	77kW (105)PS	TD19093	774
BTS	4 Cyl.	10.5:1	1598cc	77kW (105)PS	TD19428	774

CORDOBA	11/06→11/09	FABIA	04/07→	IBIZA	11/06→
POLO	05/06→11/09	ROOMSTER	09/06→		

	KIT		KIT		
				FOL179 (x16)	FOL167 (x16)

B x C x D	OE	MAT.	45°	Y	H	E x F x G
V94116 ■ 29.50 x 6.00 x 100.90	036 109 601S		45°	Y	H	VAG96073B ■ ■ ■ 36.00 x 6.02 x 11.06
V94117 ■ 26.00 x 6.00 x 100.50	036 109 611K		45°			

AG8850 MLS			HBS249 Ⓢ M9x1.25x138mm (x10)	JD5228 ■ JD5814 ■	HR397	PA5041 (x16) 6.00x8.8/12.20x10.00 866N W (FPM)	



AG8850

125

76.50

Petrol





CLSA	4 Cyl.	10.5:1	1598cc	77kW (105)PS	TD25749	
CLSA	4 Cyl.	10.5:1	1598cc	77kW (105)PS	TD25763	















POLO	05/10→					
------	--------	--	--	--	--	--

AH5960 MLS, 0.800mm				JD5228 ■ (x4)	HR397	PA5041 (x16) 6.00x8.8/12.20x10.00 866N W (FPM)	



AH5960



126	 76.50	Diesel					
TC	4 Cyl.	23:1	1600cc	51kW (70)PS	Turbo	TD13489	777
ILTIS 08/87→12/88							

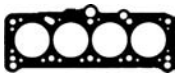







							
TB225 135x25.4	TBK018		KIT				
							
BN940 Fibre Composite, 1.530mm, 1 Hole BN950 Fibre Composite, 1.570mm, 2 Holes BN960 Fibre Composite, 1.610mm, 3 Holes	DD502 ▲		HBS018 ⊕ M12x1.75x115mm (x10)	JC243 ■ JC152 ■ (x4)	HL457 ■ [9] (Cork) HM5053 ■ [10] (ACM)	HR569 ■	NA5001 32.00x47.00x10.00mm FPM





BN940, BN950, BN960









[9] Centering Diameter [mm]: 8.5 [9] Zentrierdurchmessers [mm]: 8.5
[10] Centering Diameter [mm]: 6.5 [10] Zentrierdurchmessers [mm]: 6.5

127	 76.50	Diesel			
682	4 Cyl.	23.5:1	1471cc	33kW (45)PS	TD22612

							
				JC478 ■ JC152 ■ (x4)	HL457 ■ [9] (Cork)		

[9] Centering Diameter [mm]: 8.5 [9] Zentrierdurchmessers [mm]: 8.5



128	 76.50	Diesel				
685	4 Cyl.	23:1	1588cc	36kW (49)PS	TD22613	760

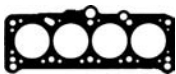







							
BN940 Fibre Composite, 1.530mm, 1 Hole BN950 Fibre Composite, 1.570mm, 2 Holes BN960 Fibre Composite, 1.610mm, 3 Holes				JC478 ■ JC152 ■ (x4)	HL457 ■ [9] (Cork)		



BN940, BN950, BN960

[9] Centering Diameter [mm]: 8.5 [9] Zentrierdurchmessers [mm]: 8.5

129	 76.50	Diesel				
686	4 Cyl.	23:1	1588cc	45kW (61)PS	TD22614	760

							
BN940 Fibre Composite, 1.530mm, 1 Hole BN950 Fibre Composite, 1.570mm, 2 Holes BN960 Fibre Composite, 1.610mm, 3 Holes	DD501 ▲			JC152 ■ (x4)	HL457 ■ [9] (Cork)		

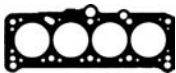

BN940, BN950, BN960

[9] Centering Diameter [mm]: 8.5 [9] Zentrierdurchmessers [mm]: 8.5

130

76.50

Diesel



68A 4 Cyl. 23:1 1588cc 45kW (61)PS TD22615 760



BN940 Fibre Composite, 1.530mm, 1 Hole
 BN950 Fibre Composite, 1.570mm, 2 Holes
 BN960 Fibre Composite, 1.610mm, 3 Holes

JC243
 JC152 (x4)

HL457 [9]
 (Cork)



BN940

131

76.50

Diesel



68C 4 Cyl. 23:1 1588cc 50kW (68)PS TD22616 760

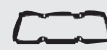

BN940 Fibre Composite, 1.530mm, 1 Hole
 BN950 Fibre Composite, 1.570mm, 2 Holes
 BN960 Fibre Composite, 1.610mm, 3 Holes

JC243
 JC152 (x4)

HL457 [9]
 (Cork)



BN940, BN950, BN960

[9] Centering Diameter [mm]: 8.5

[9] Zentrierdurchmessers [mm]: 8.5

132

76.50

Diesel



CN 5 Cyl. 23:1 1986cc 51kW (70)PS TD247 778

100 08/78 → 11/90



TB131
 119x25.4
 TB136
 75x20
 Driven unit: injection pump

TBK044

CAM630

FOL92 (x10)

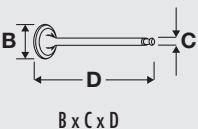

OE



MAT.



45°



H

V90321
 36.13 x 7.96 x 104.63
 V90180
 31.32 x 7.94 x 104.60

069 109 601C

068 109 611C

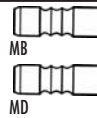

MB

MD

45°

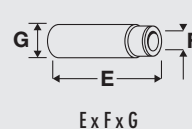

VAG92061B
 36.70 x 8.00 x 12.08

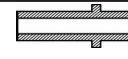

BT470 Fibre Composite, 1.610mm, 3 Holes
 08/85 →
 BL510
 → 07/85

DL491

HBS021
 M12x1.75x115mm (x12)

JC261
 JC152 (x5)

HL462
 → 08/81
 HL463
 09/81 →

HR615

NA5001 (x2)
 32.00x47.00x10.00mm FPM



BT470

BL510

133

76.50

Diesel



DE 5 Cyl. 23:1 1986cc 64kW (87)PS Turbo TD251 779

100 08/82→02/88

TB131 119x25.4 TB136 75x20 Driven unit: injection pump	TBK044	CAM630			FOL92 (x10)

	OE	MAT.			
V91343	069 109 601D		45°	H	VAG92061B
36.10 x 7.97 x 104.90					36.70 x 8.00 x 12.08
V91174	068 109 611D		45°	ss	
31.00 x 7.95 x 104.60					

BT470 Fibre Composite, 1.610mm, 3 Holes BL510 →07/85	DL491	HBS021	JC261	HL463	HR615	NA5001 32.00x47.00x10.00mm FPM
		M12x1.75x115mm (x12)	JC152	(x5)		



BT470

BL510

134

76.50

Diesel



NC 5 Cyl. 23:1 1986cc 74kW (100)PS Turbo Intercooled TD299 779

100 03/88→11/90

TB131 119x25.4 TB136 75x20 Driven unit: injection pump	TBK044	CAM630			FOL92 (x10)

	OE	MAT.			
V91336	069 109 601H		45°		VAG92061B
36.10 x 7.97 x 95.00					36.70 x 8.00 x 12.08
V91409	069 109 611		45°	H	
31.30 x 7.95 x 95.10					

BT470 Fibre Composite, 1.610mm, 3 Holes	DL491	HBS021	JC261	HL463	HR615	NA5001 32.00x47.00x10.00mm FPM
		M12x1.75x115mm (x12)	JC152	(x5)		



BT470

135

76.50

Petrol



1E 6 Cyl. 2382cc 70kW (95)PS TD4956 781

LT 28-35 08/89→06/96 LT 40-55 08/88→06/96

TB101 119x19 08/84→ TB603 112x19 →08/84					FOL92 (x12)

B x C x D	OE	MAT.	45°	H	E x F x G
V91337 ■ 36.10 x 7.97 x 95.10	069 109 601F		45°	H	VAG92061B ■ ■ ■ ■ ■ ■ 36.70 x 8.00 x 12.08
V91334 ■ 31.30 x 7.95 x 95.10	074 109 611		45°	ss H	

	DM700		HBS022 ⊙ M12x1.75x115mm (x14)	JC146 ■ JC152 ■ (x6) ⊙ JE138 [61]	JN849	HR805 ■	NA5001 (x2) 32.00x47.00x10.00mm FPM

[61] To cylinder 4 - 6

[61] zum Zylinder 4 - 6

136

76.50

Petrol



DL 6 Cyl. 8:1 2383cc 66kW (89)PS TD4995 781

LT 28-35 12/82→07/92 LT 40-55 12/82→07/92

TB101 119x19 08/84→ TB603 112x19 →08/84					

B x C x D	OE	MAT.	45°	H	E x F x G
V91337 ■ 36.10 x 7.97 x 95.10	069 109 601F		45°	H	VAG92061B ■ ■ ■ ■ ■ ■ 36.70 x 8.00 x 12.08

	DM700		HBS022 ⊙ M12x1.75x115mm (x14)	JC146 ■ JC152 ■ (x6) ⊙ JE138 [61]	JN849	HR805 ■	NA5001 (x2) 32.00x47.00x10.00mm FPM

[61] To cylinder 4 - 6

[61] zum Zylinder 4 - 6

137	79.50	Petrol	
EE	4 Cyl.	1588cc	60kW (81)PS
			TD4065 797

BG870 Fibre Composite	DG871			JC478 JC152 (x4)	HL456 (Cork) HL457 [9] (Cork) HM5053 [10] (ACM)	HR569	NA5001 32.00x47.00x10.00mm FPM NB446



BG870

[9] Centering Diameter [mm]: 8.5 [9] Zentrierdurchmessers [mm]: 8.5
 [10] Centering Diameter [mm]: 6.5 [10] Zentrierdurchmessers [mm]: 6.5

138	79.50	Petrol	
EF	4 Cyl.	8.2:1	1588cc
			60kW (81)PS
			TD4066 795

BG870 Fibre Composite	DG871			JC478 JC152 (x4)	HL456 (Cork) HL457 [9] (Cork)		



BG870

[9] Centering Diameter [mm]: 8.5 [9] Zentrierdurchmessers [mm]: 8.5

139	76.50	Petrol	
HS	6 Cyl.	8:1	2383cc
			62kW (84)PS
			TD4108 781

 B x C x D OE V91332 36.10 x 7.97 x 99.30 V94580 36.00 x 8.00 x 98.80	MAT. MD MB	 45° 45°	 H	 E x F x G VAG92061B 36.70 x 8.00 x 12.08			

				JC152 (x4) JE138 [61]	JN849	HR663	NA5001 32.00x47.00x10.00mm FPM NB446

[61] To cylinder 4 - 6 [61] zum Zylinder 4 - 6

140

76.50

Diesel



1G 6 Cyl. 23:1 2383cc 68kW (92)PS Turbo TD3993 782

LT 28-35 08/88 → 08/92 LT 40-55 08/88 → 08/92

TB131 119x25.4	TBK044	CAM447			FOL92 (x12)
TB136 75x20					
Driven unit: injection pump					

B x C x D	E x F x G
OE	
MAT.	
V91336 ■	VAG92061B ■ ■ ■
36.10 x 7.97 x 95.00	36.70 x 8.00 x 12.08
08/89 →	
V91368 ■	
31.30 x 7.95 x 95.00	
08/89 →	
V91409 ■	
31.30 x 7.95 x 95.10	

BW680 Fibre Composite, 1.530mm, 1 Notch	DM660 ▲ [14]	HBS022 ⊕	JC146 ■	JC152 ■ (x6)	HL728	NA5001 (x2)
BW690 Fibre Composite, 1.570mm, 2 Notches		M12x1.75x115mm (x14)				32.00x47.00x10.00mm FPM
BW700 Fibre Composite, 1.610mm, 3 Notches						



BW680, BW690, BW700

[14] With shaft oil seal

[14] Mit Wellendichtring

141

76.50

Diesel



1S 6 Cyl. 23.5:1 2383cc 51kW (70)PS TD4958 783

LT 28-35 08/89→06/96 LT 40-55 07/90→06/96

TB131 119x25.4 TB136 75x20 Driven unit: injection pump	TBK044	CAM447		FOL92 (x12)

B x C x D	OE	MAT.	45°	H	E x F x G
V91337 ■ 36.10 x 7.97 x 95.10	069 109 601F		45°	H	VAG92061B ■ ■ ■ 36.70 x 8.00 x 12.08
V91368 ■ 31.30 x 7.95 x 95.00	068 109 611L		45°	H	

BW680 Fibre Composite, 1.530mm, 1 Notch BW690 Fibre Composite, 1.570mm, 2 Notches BW700 Fibre Composite, 1.610mm, 3 Notches	DM660 ▲ [14]	HBS022 ⊕ M12x1.75x115mm (x14)	JC146 ■ JC152 ■ (x6) JE138 [61]	HL728	HR805 ■	NA5001 (x2) 32.00x47.00x10.00mm FPM



BW680, BW690, BW700

[61] To cylinder 4 - 6

[61] zum Zylinder 4 - 6

[14] With shaft oil seal

[14] Mit Wellendichtring



CP	6 Cyl.	23:1	2383cc	55kW (75)PS	TD4047	784
LT 28-35	12/78 → 07/92	LT 40-55	12/78 → 07/92			

TB131 119x25.4	TBK044	CAM447 01/90 → [11]			FOL92 (x12) 01/90 → FOL91 (x12) → 12/89
TB136 75x20					
Driven unit: injection pump					
[11] Mechanical		[11] Mechanical			

B x C x D	OE	MAT.	E x F x G
V90321 ■	069 109 601C	 MB	VAG92061B ■ ■ ■ 36.70 x 8.00 x 12.08
36.13 x 7.96 x 104.63			
V94772 ■	069 109 601	 MB	
35.95 x 8.00 x 104.75			
V90180 ■	068 109 611C	 MD	
31.32 x 7.94 x 104.60			
V91174 ■	068 109 611D	 MD	
31.00 x 7.95 x 104.60			

BW680 Fibre Composite, 1.530mm, 1 Notch	DM660 ▲ [14]		HBS022 ⊕ M12x1.75x115mm (x14)	JC146 ■ JC152 ■ (x6) JE138 [61]	HL728 HL469 ■		NA5001 (x2) 32.00x47.00x10.00mm FPM
BW690 Fibre Composite, 1.570mm, 2 Notches							
BG940 Fibre Composite, 1.600mm, 3 Notches							
BW700 Fibre Composite, 1.610mm, 3 Notches							



BG940 [61] To cylinder 4 - 6
[14] With shaft oil seal

BW680 [61] zum Zylinder 4 - 6
[14] Mit Wellendichtring

143

76.50

Diesel



DV 6 Cyl. 23:1 2383cc 75/80kW (102/109)PS Turbo TD4061 780

LT 28-35 12/82→09/93 LT 40-55 08/78→09/93

TB131 119x25.4 TB136 75x20 Driven unit: injection pump	TBK044	CAM447 01/90→ [11]	KIT	FOL92 (x12) 01/90→ FOL91 (x12) →12/89

[11] Mechanical [11] Mechanical

	OE	MAT.		
B x C x D				E x F x G
V91336 ■ 36.10 x 7.97 x 95.00	069 109 601H		45°	VAG92061B ■ ■ ■ 36.70 x 8.00 x 12.08
V91343 ■ 36.10 x 7.97 x 104.90	069 109 601D		45° H	
V91174 ■ 31.00 x 7.95 x 104.60	068 109 611D		45° ss	
V91409 ■ 31.30 x 7.95 x 95.10	069 109 611		45° H	

BW680 Fibre Composite, 1.530mm, 1 Notch BW690 Fibre Composite, 1.570mm, 2 Notches BW700 Fibre Composite, 1.610mm, 3 Notches	DM660 ▲ [14]	HBS022 ⊕ M12x1.75x115mm (x14)	JC146 ■ JC152 ■ (x6)	HL728	HR805 ■	NA5001 (x2) 32.00x47.00x10.00mm FPM



BW680, BW690, BW700

[14] With shaft oil seal [14] Mit Wellendichtring



DW 6 Cyl. 23:1 2383cc 55/57kW (75/78)PS TD4062 784

LT 28-35 12/78 → 07/92 LT 40-55 12/78 → 07/92

TB131 119x25.4	TBK044	CAM447 01/90 → [11]			FOL92 (x12) 01/90 → FOL91 (x12) → 12/89
TB136 75x20					
Driven unit: injection pump					
[11] Mechanical		[11] Mechanical			

	OE	MAT.			
B x C x D					E x F x G
V90321 ■ 36.13 x 7.96 x 104.63 08/81 → 07/89	069 109 601C		45°	H	VAG92061B ■ ■ ■ 36.70 x 8.00 x 12.08
V91337 ■ 36.10 x 7.97 x 95.10 08/89 →	069 109 601F		45°	H	
V90180 ■ 31.32 x 7.94 x 104.60 08/81 → 07/89	068 109 611C		45°		
V91174 ■ 31.00 x 7.95 x 104.60 08/81 → 07/89	068 109 611D		45°	ss	
V91368 ■ 31.30 x 7.95 x 95.00 08/89 →	068 109 611L		45°	H	

BW680 Fibre Composite, 1.530mm, 1 Notch	DM660 ▲ [14]		HBS022 ⊙ M12x1.75x115mm (x14)	JC146 ■ JC152 ■ (x6) JE138 [61]	HL728	HR805 ■	NA5001 (x2) 32.00x47.00x10.00mm FPM
BW690 Fibre Composite, 1.570mm, 2 Notches							
BG940 Fibre Composite, 1.600mm, 3 Notches							
BW700 Fibre Composite, 1.610mm, 3 Notches							



BG940

[61] To cylinder 4 - 6

[14] With shaft oil seal



BW680

[61] zum Zylinder 4 - 6

[14] Mit Wellendichtring

145

76.50

Diesel



ACL 6 Cyl. 22:1 2384cc 70kW (95)PS Turbo TD4012 782

LT 28-35 06/92→06/96 LT 40-55 06/92→06/96

TB136 75x20 Driven unit: injection pump TB440 120x25.4		CAM447			FOL92 (x12)

B x C x D	OE	MAT.		E x F x G
V91336 ■ 36.10 x 7.97 x 95.00	069 109 601H		45°	VAG92061B ■ ■ ■ 36.70 x 8.00 x 12.08
V91409 ■ 31.30 x 7.95 x 95.10	069 109 611		45° H	

BW680 Fibre Composite, 1.530mm, 1 Notch →Eng.ACL041031			HBS022 ⊕ M12x1.75x115mm (x14)	JC146 ■ JC152 ■ (x6)	HL728	HR805 ■	NA5001 32.00x47.00x10.00mm FPM
BW690 Fibre Composite, 1.570mm, 2 Notches →Eng.ACL041031							
BW700 1.610mm, 3 Notches →Eng.ACL041031							
BZ930 Fibre Composite, 1.610mm, 3 Notches Eng.ACL041032→ MLS, 1.570mm, 2 Holes							

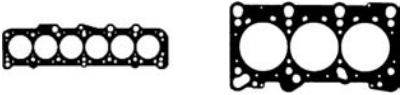

BW680, BW690, BW700 BZ930

VW GROUP

146

76.50

Diesel



ACT	6 Cyl.	22:1	2384cc	51kW (70)PS	TD4014	783
LT 28-35	08/89→06/96	LT 40-55	07/90→06/96			

TB131 119x25.4 →07/92 TB136 75x20 Driven unit: injection pump TB440 120x25.4 08/92→	TBK044 →07/92	CAM447	KIT		FOL92 (x12)

V91337 36.10 x 7.97 x 95.10	VAG92061B 36.70 x 8.00 x 12.08
V91368 31.30 x 7.95 x 95.00	

BW680 Fibre Composite, 1.530mm, 1 Notch →Eng.ACT011319			HBS022 M12x1.75x115mm (x14)	JC146 JC152 (x6)	HL728	HR805	NA5001 (x2) 32.00x47.00x10.00mm FPM
BW690 Fibre Composite, 1.570mm, 2 Notches →Eng.ACT011319							
BW700 1.610mm, 3 Notches, →Eng.ACT011319							
BZ930 Fibre Composite, 1.610mm, 3 Notches Eng.ACT011320→ MLS, 1.570mm, 2 Holes							

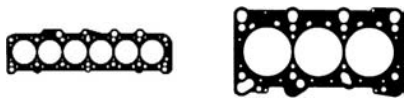

BW680, BW690, BW700 BZ930

147

77.00

Petrol



AC	4 Cyl.		1285cc	29kW (40)PS	TD5135	785
AR	Boxer4 Cyl.		1285cc	32kW (44)PS	TD4029	785
E	Boxer4 Cyl.		1285cc	27kW (37)PS	TD5132	786

KAEFER	08/65→07/75					
---------------	-------------	--	--	--	--	--

	CV480 [15]	FV500 [15]		JB373	JM986		

[15] Without shaft seal [15] Ohne Wellendichtring

148

77.00



Petrol











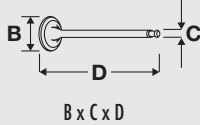



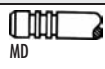

D	Boxer4 Cyl.	7.3:1	1192cc	25kW (34)PS	TD4054	786
KAEFER	01/60→12/85	KARMANN GHIA	09/57→12/64			

	CV480 [15]	FV480		JB373	JM986		



[15] Without shaft seal [15] Ohne Wellendichtring











149		77.00	Petrol			
AB	Boxer4 Cyl.	7.5:1	1285cc	32kW (44)PS	TD4005	786
F	Boxer4 Cyl.		1285cc	29kW (40)PS	TD4076	786
KAEFER	07/64→03/81		KARMANN GHIA	07/64→07/74		

					
B x C x D	OE	MAT.	45°		E x F x G
V33818 	113 109 612				
30.00 x 7.92 x 111.90		MD			









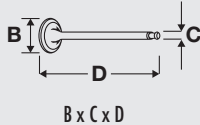

							
	CV480 ▲○ [15]	FV500 ▲○ [15]			JB373	JM986	



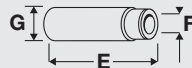

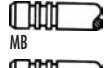

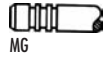





[15] Without shaft seal [15] Ohne Wellendichtring

150		78.30	Diesel				
AFB	V6 Cyl.		2496cc	110kW (150)PS	Turbo Intercooled	TD11499	787
AFB	V6 Cyl.		2496cc	110kW (150)PS	Turbo Intercooled	TD9517	787
AKE	V6 Cyl.	18.5:1	2496cc	132kW (180)PS	Turbo Intercooled	TD15312	788
AKN	V6 Cyl.	19.5:1	2496cc	110kW (150)PS	Turbo Intercooled	TD11356	787
AKN	V6 Cyl.	19.5:1	2496cc	110kW (150)PS	Turbo Intercooled	TD11498	787
A4	09/97→12/04		A6	07/97→01/05	A8	01/97→09/02	
ALLROAD	05/00→08/05		PASSAT	07/98→05/05			

					
TB641 87x25 Driven unit: injection pump TB738 207x30	TBK348 without tensioner pulley damper TBK354 with tensioner pulley damper	CAM700  [54] CAM703  [54] CAM701  [61] CAM702  [61]	KIT	FOL159 (x24)	FOL158 (x24) TTP4 (x24)

[54] To cylinder 1 - 3 [54] zum Zylinder 1 - 3
[61] To cylinder 4-6 [61] Zu Motorzylinder 4-6

					
B x C x D	OE	MAT.	45°	H	E x F x G
V94653 	059 109 601B		45°	H	VAG96237B 
27.10 x 6.00 x 100.50		MB			42.00 x 6.02 x 10.07
V94423 	059 109 611B		45°	ss	VAG96265B 
24.10 x 6.00 x 100.50		MG			42.00 x 5.98 x 10.21

							
AC5960 MLS, 1.100mm, 1 Hole (x2) AC5970 MLS, 1.150mm, 2 Holes (x2) AC5980 MLS, 1.200mm, 3 Holes (x2)	CC5960 ▲ [3]		HBS265  M12x1.50x155mm (x16)	JD5810  (x2) JD5851  (x6) Fibre Composite	HM5223  (x2) (ACM)	PA5041 (x24) 6.00x8.8/12.20x10.00 866N W (FPM) HR5062 	NA5001 (x2) 32.00x47.00x10.00mm FPM

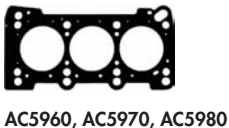

[3] Fitting Position: Left and right [3] Einbauort: beidseitig



AYM	V6 Cyl.	18.5:1	2496cc	114kW (155)PS	Turbo Intercooled	TD16384	788
AYM	V6 Cyl.	18.5:1	2496cc	114kW (155)PS	Turbo Intercooled	TD16404	788
A4	08/01→07/02	A6	08/01→01/05	SUPERB	12/01→08/03		

TB641 87x25 Driven unit: injection pump TB738 207x30	TBK348 without tensioner pulley damper TBK354 with tensioner pulley damper	CAM700 ■ [54] CAM703 ■ [54] CAM701 ■ [61] CAM702 ■ [61]	FOL159 (x24)	FOL158 (x24) TTP4 (x24)	

[54] To cylinder 1 - 3

[54] zum Zylinder 1 - 3

[61] To cylinder 4-6

[61] Zu Motorzylinder 4-6

V94653 ■ 27.10 x 6.00 x 100.50	V94423 ■ 24.10 x 6.00 x 100.50	OE 059 109 601B MAT. MB MG	45° 45° ss	H H	E x F x G

AC5960 MLS, 1.100mm, 1 Hole (x2) AC5970 MLS, 1.150mm, 2 Holes (x2) AC5980 MLS, 1.200mm, 3 Holes (x2)	CC5960 ▲ [3]	HBS265 ⊕ M12x1.50x155mm (x16)	JD5810 ■ (x2) JD5851 ■ (x6) Fibre Composite	HM5223 ■ (x2) (ACM)	PA5041 (x24) 6.00x8.8/12.20x10.00 866N W (FPM) HR5062 ■	NA5001 32.00x47.00x10.00mm FPM	

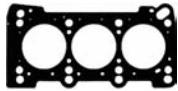

AC5960, AC5970, AC5980

[3] Fitting Position: Left and right

[3] Einbauort: beidseitig

152

78.30

Diesel



BAU	V6 Cyl.	18.5:1	2496cc	132kW (180)PS	Turbo Intercooled	TD17033	788
BAU	V6 Cyl.	18.5:1	2496cc	132kW (180)PS	Turbo Intercooled	TD17046	788
A4	11/00→12/04		A6	02/00→01/05	ALLROAD	05/00→08/05	
PASSAT	01/03→05/05						

TB641 87x25 Driven unit: injection pump TB738 207x30	TBK348 without tensioner pulley damper TBK354 with tensioner pulley damper				FOL158 (x24)

B x C x D	E x F x G
OE	
MAT.	
V98008 ■ 27.20 x 6.00 x 100.60	VAG96237B ■ ■ ■ 42.00 x 6.02 x 10.07
V98009 ■ 24.10 x 6.00 x 100.70	VAG96265B ■ ■ ■ 42.00 x 5.98 x 10.21
059 109 601F MB cr	45°
059 109 611G MG cr	45° ss

AC5960 MLS, 1.100mm, 1 Hole (x2) AC5970 MLS, 1.150mm, 2 Holes (x2) AC5980 MLS, 1.200mm, 3 Holes (x2)	CC5960 ▲ [3]	HBS265 ⊙ M12x1.50x155mm (x16)	JD5810 ■ (x2) JD5851 ■ (x6) Fibre Composite	HM5223 ■ (x2) (ACM)	PA5041 (x24) 6.00x8.8/12.20x10.00 866N W (FPM) HR5062 ■	NA5001 32.00x47.00x10.00mm FPM

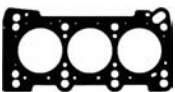

AC5960, AC5970, AC5980

[3] Fitting Position: Left and right

[3] Einbauort: beidseitig



BCZ	V6 Cyl.	19.5:1	2496cc	120kW (163)PS	Turbo Intercooled	TD16859	788
A4	07/02→12/05	A6	07/02→01/05	ALLROAD	05/03→08/05		

TB641 87x25 Driven unit: injection pump TB738 207x30	TBK348 without tensioner pulley damper TBK354 with tensioner pulley damper	CAM700 ■ [54] CAM703 ■ [54] CAM701 ■ [61] CAM702 ■ [61]		FOL159 (x24)	FOL158 (x24) TTP4 (x24)

[54] To cylinder 1 - 3
[61] To cylinder 4-6

[54] zum Zylinder 1 - 3
[61] Zu Motorzylinder 4-6

B x C x D	E x F x G
OE	
MAT.	
V98008 ■ 27.20 x 6.00 x 100.60	VAG96237B ■ ■ ■ 42.00 x 6.02 x 10.07
V98009 ■ 24.10 x 6.00 x 100.70	VAG96265B ■ ■ ■ 42.00 x 5.98 x 10.21

AC5960 MLS, 1.100mm, 1 Hole (x2) AC5970 MLS, 1.150mm, 2 Holes (x2) AC5980 MLS, 1.200mm, 3 Holes (x2)	CC5960 ▲ [3]	HBS361 ⊕ M12x1.50x159mm (x16)	JD5810 ■ (x2) JD5851 ■ (x6) Fibre Composite	HM5223 ■ (x2) (ACM)	PA5041 (x24) 6.00x8.8/12.20x10.00 866N W (FPM) HR5062 ■	NA5001 32.00x47.00x10.00mm FPM

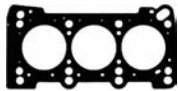

AC5960, AC5970, AC5980

[3] Fitting Position: Left and right

[3] Einbauort: beidseitig

154

78.30

Diesel



BDG	V6 Cyl.	18.5:1	2496cc	120kW (163)PS	Turbo Intercooled	TD16860	789
BDG	V6 Cyl.	18.5:1	2496cc	120kW (163)PS	Turbo Intercooled	TD16985	789
BDG	V6 Cyl.	18.5:1	2496cc	120kW (163)PS	Turbo Intercooled	TD17350	789
BDH	V6 Cyl.	18.5:1	2496cc	132kW (180)PS	Turbo Intercooled	TD17034	789
BDH	V6 Cyl.	18.5:1	2496cc	132kW (180)PS	Turbo Intercooled	TD17047	789

A4	11/00→05/06	A6	02/00→01/05	PASSAT	01/03→05/05
SUPERB	06/03→03/08				

TB641 87x25 Driven unit: injection pump TB738 207x30	TBK348 without tensioner pulley damper TBK354 with tensioner pulley damper				FOL158 (x24)

B x C x D	E x F x G
V98008 ■ 27.20 x 6.00 x 100.60	VAG96237B ■ ■ ■ 42.00 x 6.02 x 10.07
V98009 ■ 24.10 x 6.00 x 100.70	VAG96265B ■ ■ ■ 42.00 x 5.98 x 10.21

AC5960 MLS, 1.100mm, 1 Hole (x2) AC5970 MLS, 1.150mm, 2 Holes (x2) AC5980 MLS, 1.200mm, 3 Holes (x2)	CC5960 ▲ [3]	HBS361 ⊕ M12x1.50x159mm (x16)	JD5810 ■ (x2) JD5851 ■ (x6) Fibre Composite	HM5223 ■ (x2) (ACM)	PA5041 (x24) 6.00x8.8/12.20x10.00 866N W (FPM) HR5062 ■	NA5001 32.00x47.00x10.00mm FPM

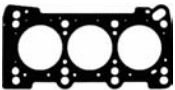

AC5960, AC5970, AC5980

[3] Fitting Position: Left and right

[3] Einbauort: beidseitig



BFC	V6 Cyl.	19.5:1	2496cc	120kW (163)PS	Turbo Intercooled	TD16858	788
A4	07/02→12/05		A6	07/02→01/05			

TB641 87x25 Driven unit: injection pump TB738 207x30	TBK348 without tensioner pulley damper TBK354 with tensioner pulley damper	CAM700 [54] CAM703 [54] CAM701 [61] CAM702 [61]		FOL159 (x24)	FOL158 (x24) TTP4 (x24)

[54] To cylinder 1 - 3
[61] To cylinder 4-6

[54] zum Zylinder 1 - 3
[61] Zu Motorzylinder 4-6

B x C x D	E x F x G
V98008 [E] 27.20 x 6.00 x 100.60	VAG96237B [E] 42.00 x 6.02 x 10.07
V98009 [E] 24.10 x 6.00 x 100.70	VAG96265B [E] 42.00 x 5.98 x 10.21

AC5960 MLS, 1.100mm, 1 Hole (x2) AC5970 MLS, 1.150mm, 2 Holes (x2) AC5980 MLS, 1.200mm, 3 Holes (x2)	CC5960 ▲ [3]	HBS265 [E] M12x1.50x155mm (x16)	JD5810 [E] (x2) JD5851 [E] (x6) Fibre Composite	HM5223 [E] (x2) (ACM)	PA5041 (x24) 6.00x8.8/12.20x10.00 866N W (FPM) HR5062 [E]	NA5001 32.00x47.00x10.00mm FPM

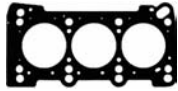

AC5960, AC5970, AC5980

[3] Fitting Position: Left and right

[3] Einbauort: beidseitig



BND	V6 Cyl.	2496cc	132kW (180)PS	Bi-Turbo Intercooled	TD19131
A6	02/00→01/05				

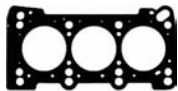

AC5960 MLS, 1.100mm, 1 Hole (x2) AC5970 MLS, 1.150mm, 2 Holes (x2) AC5980 MLS, 1.200mm, 3 Holes (x2)	CC5960 ▲ [3]	HBS265 [E] M12x1.50x155mm (x16)	JD5810 [E] (x2) JD5851 [E] (x6) Fibre Composite	HM5223 [E] (x2) (ACM)	PA5041 (x24) 6.00x8.8/12.20x10.00 866N W (FPM) HR5062 [E]	NA5001 32.00x47.00x10.00mm FPM





AC5960, AC5970, AC5980





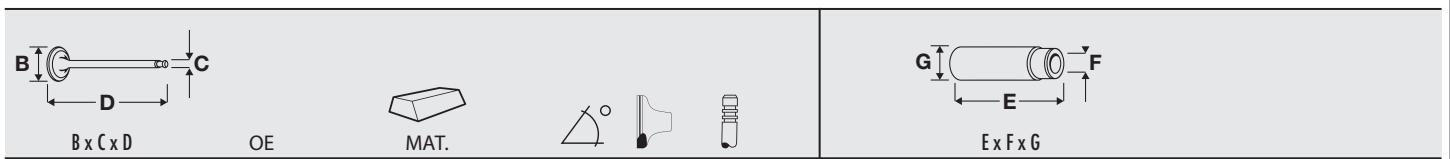





[3] Fitting Position: Left and right



[3] Einbauort: beidseitig

157	 78.30	Diesel			
AKF	V8 Cyl.	3328cc	165kW (224)PS	Turbo Intercooled	TD15344
A8	06/00 → 09/02				









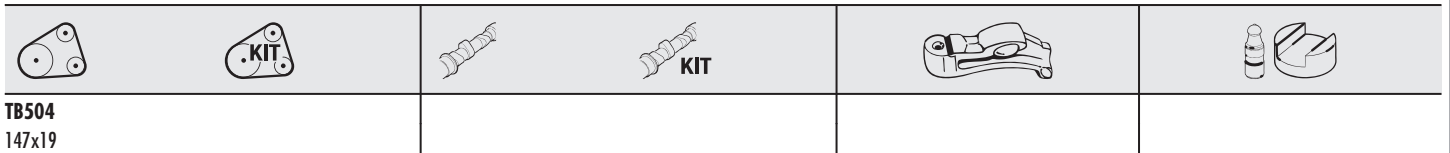



VAG96265B  
42.00 x 5.98 x 10.21

							
			HBS470  M12x1.50x159mm (x20)	JD5851  Fibre Composite		PA5041 6.00x8.8/12.20x10.00 866N W (FPM) HR791  (x2)	NA5001 (x2) 32.00x47.00x10.00mm FPM

158	 79.30	Petrol				
KW	5 Cyl.	2133cc	235kW (320)PS	Turbo Intercooled	TD292	790
QUATTRO	05/84 → 07/87					









							
						HR599  HR816 	NA5001 32.00x47.00x10.00mm FPM









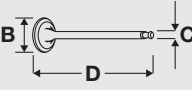

159





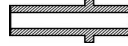



79.50
Diesel

AMF	3 Cyl.	19.5:1	1422cc	55kW (75)PS	Turbo Intercooled	TD12589	792
AMF	3 Cyl.	19.5:1	1422cc	55kW (75)PS	Turbo Intercooled	TD13895	792
AMF	3 Cyl.	19.5:1	1422cc	55kW (75)PS	Turbo Intercooled	TD17156	792
AMF	3 Cyl.	19.5:1	1422cc	55kW (75)PS	Turbo Intercooled	TD17348	792

A2	02/00→08/05	AROSA	01/00→06/04	CORDOBA	10/02→12/05
FABIA	04/03→03/08	IBIZA	05/02→12/05	LUPO	01/99→07/05
POLO	10/99→06/05				

					
TB680 120x30	TBK225 →10/01, without tensioner pulley damper TBK269 →10/01, with tensioner pulley damper TBK270 10/01→	CAM673			FOL114 (x6)

					
B x C x D	OE	MAT.			E x F x G
V94147 ■ 35.90 x 7.00 x 89.90	038 109 601B	 MB	45°	H	VAG96041B ■ ■ ■ 36.50 x 7.00 x 12.08 
V94649 ■ 36.00 x 7.00 x 89.40	038 109 601E	 MB	45°	Y	
V94148 ■ 31.50 x 7.00 x 90.00	038 109 611B	 MG	45°	ss	
V94650 ■ 31.40 x 7.00 x 89.00	038 109 611E	 MG	45°	ss	

							
AD5650 MLS, 1.450mm, 1 Hole AD5660 MLS, 1.530mm, 2 Holes AD5670 MLS, 1.610mm, 3 Holes	CD5650 ▲		HBS264 ⊕ M12x1.75x166mm (x8)	JD5278 ■ JD5279 ■	JM7032	HR5068 ■	NA5124 32.00x47.00x10.00mm PTFE/ACM



AD5650, AD5660, AD5670

160

79.50

Diesel



ATL	3 Cyl.	19.5:1	1422cc	66kW (89)PS	Turbo	TD17071	793
ATL	3 Cyl.	19.5:1	1422cc	66kW (89)PS	Turbo Intercooled	TD21352	793
A2	11/03→08/05		POLO	01/00→10/00			

TB680 120x30	TBK225 →10/01, without tensioner pulley damper TBK269 →10/01, with tensioner pulley damper TBK270 10/01→	CAM673			FOL114 (x6)

B x C x D	E x F x G
OE	
MAT.	
V94649 ■ 36.00 x 7.00 x 89.40	VAG96041B ■ ■ ■ 36.50 x 7.00 x 12.08
V94650 ■ 31.40 x 7.00 x 89.00	
038 109 601E MB	
038 109 611E MG	

AD5650 MLS, 1.450mm, 1 Hole AD5660 MLS, 1.530mm, 2 Holes AD5670 MLS, 1.610mm, 3 Holes	CD5650 ▲		HBS264 ⊕ M12x1.75x166mm (x8)	JD5278 ■ JD5279 ■	JM7032	HR5068 ■	NA5124 32.00x47.00x10.00mm PTFE/ACM



AD5650, AD5660, AD5670



BAY 3 Cyl. 1422cc 55kW (75)PS Turbo Intercooled TD16336 792

POLO 10/01→

TB680 120x30	TBK225 →10/01, without tensioner pulley damper TBK269 →10/01, with tensioner pulley damper TBK270 10/01→	CAM673			FOL114 (x6)

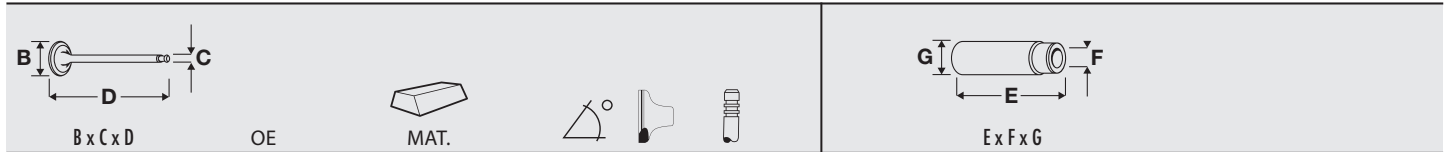

V94649 ■ 36.00 x 7.00 x 89.40	038 109 601E		45°	Y	H	VAG96041B ■ ■ ■ 36.50 x 7.00 x 12.08
V94650 ■ 31.40 x 7.00 x 89.00	038 109 611E		45°	ss	H	

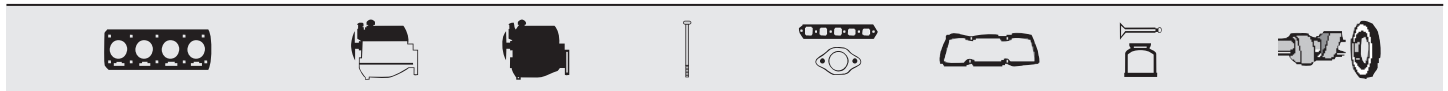

AD5650 MLS, 1.450mm, 1 Hole AD5660 MLS, 1.530mm, 2 Holes AD5670 MLS, 1.610mm, 3 Holes	CD5650 ▲		HBS264 ⊕ M12x1.75x166mm (x8)	JD5278 ■ JD5279 ■	JM7032	HR5068 ■	NA5124 32.00x47.00x10.00mm PTFE/ACM
--	-----------------	--	--	------------------------------------	---------------	-----------------	---

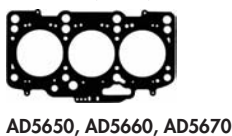

162	79.50	Diesel					
BHC	3 Cyl.	19.5:1	1422cc	55kW (75)PS	Turbo	TD18133	792
BNM	3 Cyl.	19.5:1	1422cc	51kW (70)PS	Turbo Intercooled	TD18159	794
BNM	3 Cyl.	19.5:1	1422cc	51kW (70)PS	Turbo Intercooled	TD18726	794
BNM	3 Cyl.	19.5:1	1422cc	51kW (70)PS	Turbo Intercooled	TD18740	794
BNV	3 Cyl.	19.5:1	1422cc	59kW (80)PS	Turbo Intercooled	TD18158	794
BNV	3 Cyl.	19.5:1	1422cc	59kW (80)PS	Turbo Intercooled	TD18738	794
BNV	3 Cyl.	19.5:1	1422cc	59kW (80)PS	Turbo Intercooled	TD18741	794
A2	02/00→08/05	CORDOBA	05/05→11/09	FABIA	10/05→		
FOX	04/05→	IBIZA	05/05→11/09	POLO	04/05→11/09		
ROOMSTER	07/06→03/10	ROOMSTER Praktik	03/07→03/10				

TB680 120x30	TBK270	CAM673			FOL114 (x6)

	OE	MAT.	
V94649 ■ 36.00 x 7.00 x 89.40	038 109 601E	 MB	VAG96041B ■ ■ ■ 36.50 x 7.00 x 12.08
V94650 ■ 31.40 x 7.00 x 89.00	038 109 611E	 MG	

AD5650 MLS, 1.450mm, 1 Hole AD5660 MLS, 1.530mm, 2 Holes AD5670 MLS, 1.610mm, 3 Holes	CD5650 ▲	HBS264 ⊙ M12x1.75x166mm (x8)	JD5278 ■ JD5279 ■	JM7032	HR5068 ■	NA5124 32.00x47.00x10.00mm PTFE/ACM



AD5650, AD5660, AD5670

163	79.50	Diesel					
BMS	3 Cyl.	19.5:1	1422cc	59kW (80)PS	Turbo Intercooled	TD18157	794
BMS	3 Cyl.	19.5:1	1422cc	59kW (80)PS	Turbo Intercooled	TD18727	794
BMS	3 Cyl.	19.5:1	1422cc	59kW (80)PS	Turbo Intercooled	TD19092	794
CORDOBA	06/05→11/09	FABIA	01/07→	IBIZA	06/05→06/10		
POLO	04/05→11/09	ROOMSTER	09/06→03/10	ROOMSTER Praktik	03/07→03/10		

TB680 120x30	TBK270				FOL114 (x6)

AD5650 MLS, 1.450mm, 1 Hole AD5660 MLS, 1.530mm, 2 Holes AD5670 MLS, 1.610mm, 3 Holes		HBS264 ⊙ M12x1.75x166mm (x8)	JD5278 ■		HR5068 ■	NA5124 32.00x47.00x10.00mm PTFE/ACM



AD5650, AD5660, AD5670

164

79.50

Diesel



BWB 3 Cyl. 19.5:1 1422cc 51kW (70)PS Turbo Intercooled TD20514 794

POLO 04/05→11/09

TB680 120x30	TBK270				

<p>V94649 ■ 038 109 601E 36.00 x 7.00 x 89.40</p> <p>V94650 ■ 038 109 611E 31.40 x 7.00 x 89.00</p>	<p>VAG96041B ■ ■ ■ 36.50 x 7.00 x 12.08</p>

<p>AD5650 MLS, 1.450mm, 1 Hole</p> <p>AD5660 MLS, 1.530mm, 2 Holes</p> <p>AD5670 MLS, 1.610mm, 3 Holes</p>			<p>HBS264 ⊕ M12x1.75x166mm (x8)</p>	<p>JD5278 ■ JD5279 ■</p>	JM7032	HR5068 ■	NA5124 32.00x47.00x10.00mm PTFE/ACM



AD5650, AD5660, AD5670

165

79.50

Petrol



JB 4 Cyl. 8.2:1 1457cc 51kW (70)PS TD4115 796

CADDY 08/82→07/83 GOLF 08/77→11/83 JETTA 08/78→02/84
SCIROCCO 08/77→12/83

TB108 121x18	TBK016				

<p>V91415 ■ 049 109 601K 34.10 x 7.97 x 98.70</p>	<p>VAG92105B ■ 42.30 x 7.99 x 12.08</p> <p>VAG92061B ■ ■ ■ 36.70 x 8.00 x 12.08</p>

BG870 Fibre Composite	DG871		<p>HBS029 ⊕ M11x1.50x98mm (x10)</p>	<p>JC478 ■ JC152 ■ (x4) ⊕ JE904 (x4)</p>	<p>HL456 ■ (Cork)</p> <p>HL457 ■ [9] (Cork)</p>	HR569 ■	NA5001 (x2) 32.00x47.00x10.00mm FPM



BG870

[9] Centering Diameter [mm]: 8.5

[9] Zentrierdurchmessers [mm]: 8.5

166	79.50	Petrol			
EG	4 Cyl.	9.5:1	1588cc	81kW (110)PS	TD4999 798
GOLF	08/76→07/82	JETTA	08/78→07/82	SCIROCCO	06/76→07/82
TB108 121x18	TBK016				

	OE					
B x C x D		MAT.				E x F x G
						VAG92105B 42.30 x 7.99 x 12.08 VAG92061B 36.70 x 8.00 x 12.08

BG870 Fibre Composite	DG871	HBS043 M11x1.50x95mm (x10)	JC478 JC152 (x4) JE117	HL456 (Cork) HL457 [9] (Cork) HM5053 [10] (ACM)	HR569	NA5001 (x2) 32.00x47.00x10.00mm FPM			



BG870
 [9] Centering Diameter [mm]: 8.5 [9] Zentrierdurchmessers [mm]: 8.5
 [10] Centering Diameter [mm]: 6.5 [10] Zentrierdurchmessers [mm]: 6.5

167	79.50	Petrol				
EH	4 Cyl.	8.20:1	1457cc	57kW (77)PS	TD21347 795	
BG870 Fibre Composite	DG871		JC478 JC152 (x4)	HL456 (Cork) HL457 [9] (Cork)		



BG870
 [9] Centering Diameter [mm]: 8.5 [9] Zentrierdurchmessers [mm]: 8.5

VW GROUP

168

79.50

Petrol



EM 4 Cyl. 8.2:1 1588cc 55kW (75)PS TD4068 795

CADDY 10/82→10/83 GOLF 08/75→02/84 JETTA 08/81→07/83
 SCIROCCO 08/82→07/83

TB108 121x18	TBK016		KIT		

	OE						
V91415 ■ 34.10 x 7.97 x 98.70	049 109 601K	MAT. MB	45°	ss	H	VAG92105B ■ 42.30 x 7.99 x 12.08	VAG92061B ■ ■ 36.70 x 8.00 x 12.08

BG870 Fibre Composite	DG871			HBS043 ⊕ M11x1.50x95mm (x10)	JC478 ■ JC152 ■ (x4) ⊕ JE904	HL456 ■ (Cork) HL457 ■ [9] (Cork)	HR569 ■	NA5001 (x2) 32.00x47.00x10.00mm FPM



BG870
 [9] Centering Diameter [mm]: 8.5 [9] Zentrierdurchmessers [mm]: 8.5

169

79.50

Petrol



EN 4 Cyl. 8.2:1 1716cc 57kW (77)PS TD22652 803

BG870 Fibre Composite	DG871				JC152 ■ (x4)			



BG870

170	79.50	Petrol						
FN	4 Cyl.	1588cc	51kW (70)PS				TD4085	799
GOLF	08/75→02/84	SCIROCCO	08/75→07/79					

TB108 121x18	TBK016		KIT					
BG870 Fibre Composite	DG871	HBS043 Ⓞ M11x1.50x95mm (x10)	JC478 ■ JC152 ■ (x4) Ⓞ JE904	HL456 ■ (Cork) HL457 ■ [9] (Cork)	HR569 ■	NA5001 (x2) 32.00x47.00x10.00mm FPM		



BG870

[9] Centering Diameter [mm]: 8.5

[9] Zentrierdurchmessers [mm]: 8.5

171	79.50	Petrol						
FP	4 Cyl.	8.2:1	1588cc	55kW (75)PS			TD4086	795
GOLF	08/75→02/84	SCIROCCO	08/75→07/79					

TB108 121x18	TBK016		KIT					
V91415 ■ 34.10 x 7.97 x 98.70	VAG92061B ■ ■ ■ 36.70 x 8.00 x 12.08	HBS043 Ⓞ M11x1.50x95mm (x10)	JC478 ■ JC152 ■ (x4) Ⓞ JE904	HL456 ■ (Cork) HL457 ■ [9] (Cork)	HR569 ■	NA5001 (x2) 32.00x47.00x10.00mm FPM		



BG870

[9] Centering Diameter [mm]: 8.5

[9] Zentrierdurchmessers [mm]: 8.5

VW GROUP

172







 **79.50**







Petrol



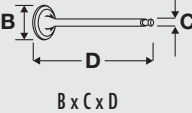



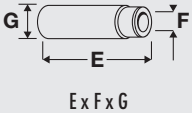

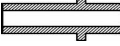









FR 4 Cyl. 8.2:1 1588cc **63kW (85)PS** TD4088 **795**

JETTA 08/78 → 02/84 SCIROCCO 08/75 → 04/84

					
TB108 121x18	TBK016		KIT		

					
B x C x D	OE	MAT.	45°	ss	H
V91415 	049 109 601K				
34.10 x 7.97 x 98.70		MB			
					VAG92061B 
					36.70 x 8.00 x 12.08

							
BG870 Fibre Composite	DG871		HB5043 	JC478  JC152  (x4)  JE904	HL456  (Cork) HL457  [9] (Cork) HM5053  [10] (ACM)	HR569 	NA5001 (x2) 32.00x47.00x10.00mm FPM



BG870

[9] Centering Diameter [mm]: 8.5

[9] Zentrierdurchmessers [mm]: 8.5

[10] Centering Diameter [mm]: 6.5

[10] Zentrierdurchmessers [mm]: 6.5

173

 **79.50**

















Petrol



FS 4 Cyl. 1588cc **53kW (72)PS** TD16536 **795**

FS 4 Cyl. 1588cc **53kW (72)PS** TD258 **795**

80 01/76 → 07/78 PASSAT 08/75 → 07/80

							
BG870 Fibre Composite	DG871		HB5043 	JC478  JC152  (x4)  JE904	HL456  (Cork) HL457  [9] (Cork) HM5053  [10] (ACM)	HR569 	NA5001



BG870















[9] Centering Diameter [mm]: 8.5

[9] Zentrierdurchmessers [mm]: 8.5

[10] Centering Diameter [mm]: 6.5

[10] Zentrierdurchmessers [mm]: 6.5

174	 79.50	Petrol						
FT	4 Cyl.	1588cc	51kW (70)PS					TD4089 800
GOLF	08/75→07/77	SCIROCCO	08/75→07/77					



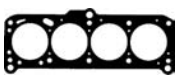







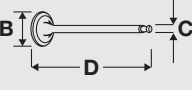

							
TB108 121x18	TBK016						
							
BG870 Fibre Composite	DG871	HBS029 Ⓣ M11x1.50x98mm (x10)	JC478 ■ JC152 ■ (x4) Ⓞ JE904	HL456 ■ (Cork) HL457 ■ [9] (Cork) HM5053 ■ [10] (ACM)	HR569 ■	NA5001 (x2) 32.00x47.00x10.00mm FPM	

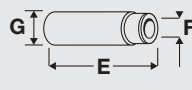

BG870

[9] Centering Diameter [mm]: 8.5 [9] Zentrierdurchmessers [mm]: 8.5
 [10] Centering Diameter [mm]: 6.5 [10] Zentrierdurchmessers [mm]: 6.5

175	 79.50	Petrol						
FV	4 Cyl.	8.2:1	1588cc	51kW (70)PS				TD4090 795

							
V91415 ■ 34.10 x 7.97 x 98.70	OE 049 109 601K MB	45°	ss	H	VAG92061B ■ ■ ■ 36.70 x 8.00 x 12.08		
							
BG870 Fibre Composite	DG871	HBS029 Ⓣ →12/78 M11x1.50x98mm (x10) HBS043 Ⓣ M11x1.50x95mm (x10) 01/78→	JC478 ■ JC152 ■ (x4) JE904	HL456 ■ (Cork) HL457 ■ [9] (Cork)	HR569 ■	NA5001 32.00x47.00x10.00mm FPM NB446	

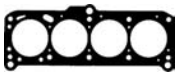

BG870

[9] Centering Diameter [mm]: 8.5 [9] Zentrierdurchmessers [mm]: 8.5

VW GROUP

176

 **79.50**

Petrol





GH 4 Cyl. 8.2:1 1457cc 48kW (65)PS TD22653 **795**



BG870 Fibre Composite

DG871

JC478 
JC152  (x4)

HL456 
(Cork)
HL457  [9]
(Cork)



BG870

[9] Centering Diameter [mm]: 8.5

[9] Zentrierdurchmessers [mm]: 8.5

177

 **79.50**

Petrol



WP 4 Cyl. 8.2:1 1588cc 48kW (65)PS TD17200 **795**

WP 4 Cyl. 8.2:1 1588cc 48kW (65)PS TD340 **795**

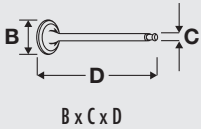

OE

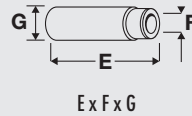

V91415 
34.10 x 7.97 x 98.70

049 109 601K





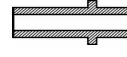





VAG92105B 
42.30 x 7.99 x 12.08









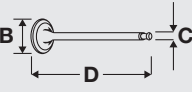
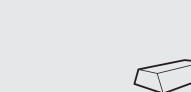
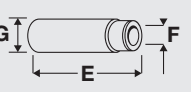

JC152  (x4)

HL456 
(Cork)

178	 79.50	Petrol			
WV	4 Cyl.	8.2:1	1588cc	55kW (75)PS	TD345 795
WV	4 Cyl.	8.2:1	1588cc	55kW (75)PS	TD5032 795
80	08/78→07/86	PASSAT	08/80→03/88	SANTANA	08/81→12/84

					
TB108 121x18	TBK016		KIT		FOL91 (x8)



		
B x C x D	OE	MAT.
V91415 ■ 34.10 x 7.97 x 98.70	049 109 601K	45° ss H
V34700 ■ 31.29 x 7.95 x 98.45	056 109 611A	45°
		VAG92061B ■ ■ ■ 36.70 x 8.00 x 12.08









							
BG870 Fibre Composite	DG871	HBS043 ⊕ M11x1.50x95mm (x10)	JC478 ■ JC152 ■ (x4) ⊕ JE904	HL456 ■ (Cork) HL457 ■ [9] (Cork) HM5053 ■ [10] (ACM)	HR569 ■	NA5001 (x2) 32.00x47.00x10.00mm FPM	



BG870

[9] Centering Diameter [mm]: 8.5 [9] Zentrierdurchmessers [mm]: 8.5
 [10] Centering Diameter [mm]: 6.5 [10] Zentrierdurchmessers [mm]: 6.5



179	 79.50	Petrol			
WY	4 Cyl.	8.2:1	1588cc	55kW (75)PS	TD21343 796
PASSAT	09/79→07/80				









							
BG870 Fibre Composite	DG871			JC478 ■ JC152 ■ (x4) ⊕ JE904	HL456 ■ (Cork) HL457 ■ [9] (Cork)		











BG870







[9] Centering Diameter [mm]: 8.5 [9] Zentrierdurchmessers [mm]: 8.5



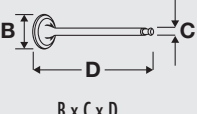
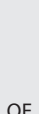



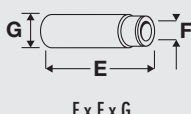
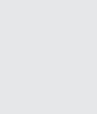









180	 79.50	Petrol			
WZ	4 Cyl.	8.2:1	1588cc	55kW (75)PS	TD17147 795
WZ	4 Cyl.	8.2:1	1588cc	55kW (75)PS	TD4171 795
PASSAT 09/79 → 07/80					

							
					HL456  (Cork)		

181	 79.50	Petrol			
XX	4 Cyl.		1588cc	74kW (100)PS	TD351 795
80 09/73 → 07/76					



					
TB108 121x18	TBK016		KIT		















						
B x C x D	OE	MAT.			E x F x G	
					VAG92061B  36.70 x 8.00 x 12.08	

							
BG870 Fibre Composite	DG871		HB5043  M11x1.50x95mm (x10)	JC478  JC152  (x4)  JE904	HL456  (Cork) HL457  [9] (Cork) HM5053  [10] (ACM)	HR569 	NA5001 32.00x47.00x10.00mm FPM





BG870
 [9] Centering Diameter [mm]: 8.5 [9] Zentrierdurchmessers [mm]: 8.5
 [10] Centering Diameter [mm]: 6.5 [10] Zentrierdurchmessers [mm]: 6.5







182	 79.50	Petrol			
YH	4 Cyl.	8.2:1	1588cc	61kW (82)PS	TD4175 795
PASSAT 09/75 → 07/80					







							
BG870 Fibre Composite	DG871			JC478  JC152  (x4)	HL456  (Cork) HL457  [9] (Cork) HM5053  [10] (ACM)	HR569 	NA5001 (x2) 32.00x47.00x10.00mm FPM



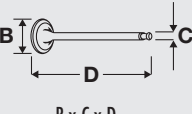



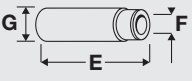











BG870
 [9] Centering Diameter [mm]: 8.5 [9] Zentrierdurchmessers [mm]: 8.5
 [10] Centering Diameter [mm]: 6.5 [10] Zentrierdurchmessers [mm]: 6.5

183	 79.50	Petrol			
YN	4 Cyl.	8.2:1	1588cc	55kW (75)PS	TD358 796
YN	4 Cyl.	8.2:1	1588cc	55kW (75)PS	TD5034 796
80	09/75→07/86	COUPE	07/80→08/81	PASSAT	02/76→03/88

					
TB108 121x18	TBK016				FOL91 (x8)

					
V34700  31.29 x 7.95 x 98.45 01/75→12/81	OE 056 109 611A	MAT.  MD	45°		E x F x G

							
BG870 Fibre Composite	DG871	HBS043  M11x1.50x95mm (x10)	JC478  JC152  (x4)  JE904	HL456  (Cork) HL457  [9] (Cork) HM5053  [10] (ACM)	HR569 	NA5001 32.00x47.00x10.00mm FPM	

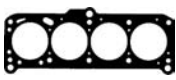

BG870

[9] Centering Diameter [mm]: 8.5 [9] Zentrierdurchmessers [mm]: 8.5
 [10] Centering Diameter [mm]: 6.5 [10] Zentrierdurchmessers [mm]: 6.5

184



79.50

Petrol



YP	4 Cyl.	8.2:1	1588cc	63kW (85)PS	TD359	796
YP	4 Cyl.	8.2:1	1588cc	63kW (85)PS	TD5035	796

80	09/75→02/83	PASSAT	08/75→02/83	SANTANA	08/81→12/82
----	-------------	--------	-------------	---------	-------------

TB108	TBK016		KIT		
121x18					

B x C x D	OE	MAT.	45°	ss	H
		MB			

V91415 ■	049 109 601K			VAG92105B ■	
34.10 x 7.97 x 98.70				42.30 x 7.99 x 12.08	

--	--	--	--	--	--	--	--

BG870 Fibre Composite	DG871		HBS043 ⊕ M11x1.50x95mm (x10)	JC478 ■ JC152 ■ (x4) JE904	HL456 ■ (Cork) HL457 ■ [9] (Cork) HM5053 ■ [10] (ACM)	HR569 ■	NA5001 32.00x47.00x10.00mm FPM
-----------------------	-------	--	---------------------------------	----------------------------------	--	---------	-----------------------------------



BG870

[9] Centering Diameter [mm]: 8.5

[9] Zentrierdurchmessers [mm]: 8.5

[10] Centering Diameter [mm]: 6.5

[10] Zentrierdurchmessers [mm]: 6.5

185



79.50

Petrol



YS	4 Cyl.	9.5:1	1588cc	81kW (110)PS	TD360	798
YS	4 Cyl.	9.5:1	1588cc	81kW (110)PS	TD9378	798

80	01/76→07/78	PASSAT	08/77→07/80
----	-------------	--------	-------------

B x C x D	OE	MAT.			

				VAG92105B ■	
				42.30 x 7.99 x 12.08	
				VAG92061B ■ ■	
				36.70 x 8.00 x 12.08	

--	--	--	--	--	--	--	--

BG870 Fibre Composite	DG871		HBS043 ⊕ M11x1.50x95mm (x10)	JC478 ■ JC152 ■ (x4) JE117	HL456 ■ (Cork) HL457 ■ [9] (Cork) HM5053 ■ [10] (ACM)	HR569 ■	NA5001 (x2) 32.00x47.00x10.00mm FPM
-----------------------	-------	--	---------------------------------	----------------------------------	--	---------	--



BG870

[9] Centering Diameter [mm]: 8.5

[9] Zentrierdurchmessers [mm]: 8.5

[10] Centering Diameter [mm]: 6.5

[10] Zentrierdurchmessers [mm]: 6.5

186	79.50	Petrol	
YT	4 Cyl.	1588cc	51kW (70)PS
80		08/78→07/81	
TD361		795	

TB108 121x18	TBK016				

BG870 Fibre Composite	DG871	HBS043 M11x1.50x95mm (x10)	JC478 JC152 (x4) JE117	HL456 (Cork) HL457 [9] (Cork) HM5053 [10] (ACM)	HR569	NA5001 32.00x47.00x10.00mm FPM	

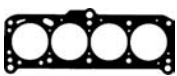

BG870

[9] Centering Diameter [mm]: 8.5 [9] Zentrierdurchmessers [mm]: 8.5
 [10] Centering Diameter [mm]: 6.5 [10] Zentrierdurchmessers [mm]: 6.5

187	79.50	Petrol	
YV	4 Cyl.	1588cc	63kW (85)PS
100		08/76→02/83	
TD362		796	

TB108 121x18	TBK016				

V91415 34.10 x 7.97 x 98.70	OE 049 109 601K 	45°	ss	H	VAG92105B 42.30 x 7.99 x 12.08	VAG92061B 36.70 x 8.00 x 12.08

BG870 Fibre Composite	DG871	HBS043 M11x1.50x95mm (x10)	JC478 JC152 (x4) JE904	HL456 (Cork) HL457 [9] (Cork) HM5053 [10] (ACM)	HR569	NA5001 (x2) 32.00x47.00x10.00mm FPM	



BG870

[9] Centering Diameter [mm]: 8.5 [9] Zentrierdurchmessers [mm]: 8.5
 [10] Centering Diameter [mm]: 6.5 [10] Zentrierdurchmessers [mm]: 6.5

188







 **79.50**









Petrol



YY	4 Cyl.	9:1	1588cc	51kW (70)PS	TD363	796
YY	4 Cyl.	9:1	1588cc	51kW (70)PS	TD22655	796

80 08/78 → 07/81

					
TB108 121x18	TBK016		KIT		

							
BG870 Fibre Composite	DG871		HB5043 ☉ M11x1.50x95mm (x10)	JC478 ■ JC152 ■ (x4)	HL456 ■ (Cork) HL457 ■ [9] (Cork) HM5053 ■ [10] (ACM)	HR569 ■	NA5001 32.00x47.00x10.00mm FPM



BG870

[9] Centering Diameter [mm]: 8.5

[9] Zentrierdurchmesser [mm]: 8.5

[10] Centering Diameter [mm]: 6.5

[10] Zentrierdurchmesser [mm]: 6.5

189	79.50	Petrol				
YZ	4 Cyl.	9.5:1	1588cc	81kW (110)PS	TD364	798
80	01/79→12/86					

TB108 121x18	TBK016				

	OE				
B x C x D		MAT.			E x F x G
					VAG92105B 42.30 x 7.99 x 12.08 VAG92061B 36.70 x 8.00 x 12.08

BG870 Fibre Composite	DG871		HBS043 M11x1.50x95mm (x10)	JC478 JC152 (x4)	HL456 (Cork) HL457 [9] (Cork) HM5053 [10] (ACM)	HR569	NA5001 (x2) 32.00x47.00x10.00mm FPM



BG870
 [9] Centering Diameter [mm]: 8.5 [9] Zentrierdurchmessers [mm]: 8.5
 [10] Centering Diameter [mm]: 6.5 [10] Zentrierdurchmessers [mm]: 6.5

190	79.50	Petrol			
WL	4 Cyl.		1714cc	55kW (75)PS	TD13488
YX	4 Cyl.	8.2:1	1714cc	55kW (75)PS	TD4178
ILTS	03/79→12/88				

TB108 121x18	TBK016				

BG870 Fibre Composite	DG871		HBS043 M11x1.50x95mm (x10)	JC478 JC152 (x4) JE904	HL456 (Cork) HL457 [9] (Cork) HM5053 [10] (ACM)	HR569	NA5001 (x2) 32.00x47.00x10.00mm FPM



BG870
 [9] Centering Diameter [mm]: 8.5 [9] Zentrierdurchmessers [mm]: 8.5
 [10] Centering Diameter [mm]: 6.5 [10] Zentrierdurchmessers [mm]: 6.5

191

 79.50

Petrol







WY 4 Cyl. 8.2:1 1588cc 55kW (75)PS TD348 796



BG870 Fibre Composite

DG871

JC478 
 JC152  (x4)
 JE904

HL456 
 (Cork)
 HL457  [9]
 (Cork)



BG870

[9] Centering Diameter [mm]: 8.5

[9] Zentrierdurchmessers [mm]: 8.5

192

 79.50

Petrol







YG 4 Cyl. 8.2:1 1588cc 61kW (82)PS TD353 795



BG870 Fibre Composite

DG871

JC478 
 JC152  (x4)

HL456 
 (Cork)
 HL457  [9]
 (Cork)
 HM5053  [10]
 (ACM)

HR569 

NA5001
 32.00x47.00x10.00mm FPM
 NB446



BG870

[9] Centering Diameter [mm]: 8.5

[9] Zentrierdurchmessers [mm]: 8.5

[10] Centering Diameter [mm]: 6.5

[10] Zentrierdurchmessers [mm]: 6.5

193

 79.50

Petrol







YH 4 Cyl. 8.2:1 1588cc 61kW (82)PS TD354 795



BG870 Fibre Composite

DG871

JC478 
 JC152  (x4)

HL456 
 (Cork)
 HL457  [9]
 (Cork)
 HM5053  [10]
 (ACM)

HR569 

NA5001
 32.00x47.00x10.00mm FPM
 NB446



BG870

[9] Centering Diameter [mm]: 8.5

[9] Zentrierdurchmessers [mm]: 8.5

[10] Centering Diameter [mm]: 6.5

[10] Zentrierdurchmessers [mm]: 6.5

194	79.50	Diesel			
KY	4 Cyl.	23:1	1715cc	42kW (57)PS	TD4126 802
TRANSPORTER 08/85→07/92					

TB225 135x25.4	TBK018				

	OE	MAT.			
V90179 34.00 x 7.97 x 104.80 →12/87	068 109 601C		45°	H	VAG92061B 36.70 x 8.00 x 12.08
V91343 36.10 x 7.97 x 104.90 01/88→	069 109 601D		45°	H	VAG92105B 42.30 x 7.99 x 12.08
V91174 31.00 x 7.95 x 104.60	068 109 611D		45° ss		

	DT590		HBS018 M12x1.75x115mm (x10)	JD278 JC152 (x4)	HL457 [9] (Cork) HM5053 [10] (ACM)	HR569	NA5001 32.00x47.00x10.00mm FPM

[9] Centering Diameter [mm]: 8.5 [9] Zentrierdurchmessers [mm]: 8.5
 [10] Centering Diameter [mm]: 6.5 [10] Zentrierdurchmessers [mm]: 6.5

195	79.50	Petrol			
WT	4 Cyl.	8.2:1	1716cc	58kW (79)PS	TD343 795

	OE	MAT.				
V91415 34.10 x 7.97 x 98.70	049 109 601K		45°	ss	H	VAG92061B 36.70 x 8.00 x 12.08

BG870 Fibre Composite	DG871		HBS043 M11x1.50x95mm (x10)	JC478 JC152 (x4) JE904	HL456 (Cork) HL457 [9] (Cork) HM5053 [10] (ACM)	HR569	NA5001 32.00x47.00x10.00mm FPM



BG870

[9] Centering Diameter [mm]: 8.5 [9] Zentrierdurchmessers [mm]: 8.5
 [10] Centering Diameter [mm]: 6.5 [10] Zentrierdurchmessers [mm]: 6.5

196

 79.50

Diesel



AFD 4 Cyl. 20:1 1896cc 58kW (79)PS TD16184 812



BX800 MLS, 1.450mm, 1 Hole
BX820 MLS, 1.610mm, 3 Holes

DX801 ▲
Eng.002 001 →

JD170 ■
JC152 ■ (x4)

HM5367 ■



BC800, BX820

197

 79.50

Diesel



AHB 4 Cyl. 19.5:1 1716cc 42kW (57)PS TD15028 804

AHB 4 Cyl. 19.5:1 1716cc 42kW (57)PS TD9403 804

CADDY 07/96 → 09/00 INCA 09/96 → 06/03



TB384
137x25.4

TBK305

CAM668

FOL92 (x8)

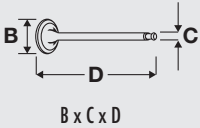

OE



MAT.



45°



Y



H

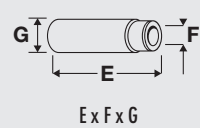

V94112 ■
36.00 x 7.00 x 96.50

028 109 601J

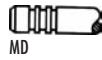
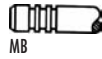

V94113 ■
31.50 x 7.00 x 96.30

028 109 611K

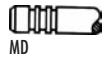

VAG96041B ■ ■ ■
36.50 x 7.00 x 12.08

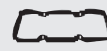
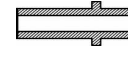

BX800 MLS, 1.450mm, 1 Hole
BX810 MLS, 1.530mm, 2 Holes
BX820 MLS, 1.610mm, 3 Holes

DX801 ▲

HBS018 ⊕
M12x1.75x115mm (x10)

JD170 ■
JC152 ■ (x4)
JE5076



JP003
HM5367 ■







HR816 ■





NA5001
32.00x47.00x10.00mm FPM





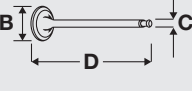
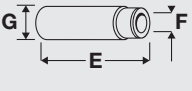









BX800, BX810, BX820



198	 79.50	Diesel				
AHG	4 Cyl.	19.5:1	1716cc	42kW (57)PS	TD11207	804
POLO	04/97→10/99					





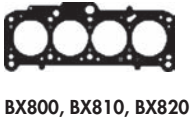

					
TB657 137x23	TBK112	CAM668			FOL92 (x8)





	
B x C x D	E x F x G
V94112  36.00 x 7.00 x 96.50	VAG96041B  36.50 x 7.00 x 12.08
OE: 028 109 601J	
MAT. MB	
45° Y H	
V94113  31.50 x 7.00 x 96.30	
OE: 028 109 611K	
MAT. MD	
45°	





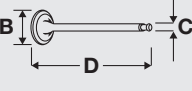
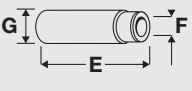







						
BX800 MLS, 1.450mm, 1 Hole	DX801 ▲	HBS018  M12x1.75x115mm (x10)	JD170  JC152  (x4) 	JP003 HM5367 	HR816 	NA5001 32.00x47.00x10.00mm FPM
BX810 MLS, 1.530mm, 2 Holes						
BX820 MLS, 1.610mm, 3 Holes						



199	 79.50	Diesel				
AKU	4 Cyl.	19.5:1	1716cc	44kW (60)PS	TD13896	804
AKU	4 Cyl.	19.5:1	1716cc	44kW (60)PS	TD9513	804
AROSA	08/97→06/04		CORDOBA	07/97→06/99	LUPO	09/98→07/05
POLO	08/97→09/01					

					
TB657 137x23	TBK112	CAM668			FOL92 (x8)

	
B x C x D	E x F x G
V94112  36.00 x 7.00 x 96.50	VAG96041B  36.50 x 7.00 x 12.08
OE: 028 109 601J	
MAT. MB	
45° Y H	
V94113  31.50 x 7.00 x 96.30	
OE: 028 109 611K	
MAT. MD	
45°	

						
BX800 MLS, 1.450mm, 1 Hole	DX801 ▲	HBS018  M12x1.75x115mm (x10)	JD170  JC152  (x4)	JP003 HM5367 	HR816 	NA5001 32.00x47.00x10.00mm FPM
BX810 MLS, 1.530mm, 2 Holes						
BX820 MLS, 1.610mm, 3 Holes						

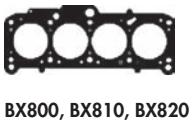

VW GROUP

200

79.50

Diesel



AKW 4 Cyl. 19.5:1 1716cc 42kW (57)PS TD9687 804

POLO 07/97→09/01

TB384 137x25.4	TBK026	CAM668			FOL92 (x8)

B x C x D	OE	MAT.	45° Y H	E x F x G	
V94112 ■ 36.00 x 7.00 x 96.50	028 109 601J		45° Y H	VAG96041B ■ ■ ■ 36.50 x 7.00 x 12.08	
V94113 ■ 31.50 x 7.00 x 96.30	028 109 611K		45°		

BX800 MLS, 1.450mm, 1 Hole BX810 MLS, 1.530mm, 2 Holes BX820 MLS, 1.610mm, 3 Holes	DX801 ▲		HBS018 ⊙ M12x1.75x115mm (x10)	JD170 ■ JC152 ■ (x4)	JP003 HM5367 ■	HR816 ■	NA5001 32.00x47.00x10.00mm FPM



BX800, BX810, BX820

201

79.50

Diesel



1X 4 Cyl. 22.5:1 1896cc 44kW (60)PS TD3997 805

TRANSPORTER 07/90→12/95

TB384 137x25.4	TBK024 Eng.→1X120077 TBK025 Eng.1X120078→	CAM440			FOL92 (x8)

B x C x D	OE	MAT.	45° H	E x F x G	
V91337 ■ 36.10 x 7.97 x 95.10	069 109 601F		45° H	VAG92061B ■ ■ ■ 36.70 x 8.00 x 12.08	
V91334 ■ 31.30 x 7.95 x 95.10	074 109 611		45° ss H		

BV850 MLS, 1.530mm, 1 Hole BV860 MLS, 1.570mm, 2 Holes BV870 MLS, 1.610mm, 3 Holes	DV850 ▲		HBS018 ⊙ M12x1.75x115mm (x10)	JD170 ■ JC152 ■ (x4) ■ JE160	JN914 HM5058 ■	HR569 ■	NA5001 32.00x47.00x10.00mm FPM

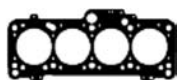

BV850, BV860, BV870

202

79.50

Diesel



1Y	4 Cyl.	22.5:1	1896cc	47kW (64)PS	TD213	806
1Y	4 Cyl.	22.5:1	1896cc	47kW (64)PS	TD4891	806
1Y	4 Cyl.	22.5:1	1896cc	47kW (64)PS	TD4960	806

80	08/89→08/91	CADDY	11/95→01/04	CORDOBA	02/93→08/96
GOLF	11/91→04/99	IBIZA	04/93→08/96	INCA	11/95→06/03
PASSAT	05/89→10/93	TOLEDO	05/91→03/99	VENTO	11/91→09/98
VOYAGE	06/96→09/01				

TB384 137x25.4	TBK024 Eng.→1Y378364 TBK025 Eng.1Y378365→	CAM440		FOL92 (x8)

	OE	MAT.			
B x C x D					E x F x G
V91337 36.10 x 7.97 x 95.10 Eng.→580.000	069 109 601F	 MB	45°	H	VAG92061B 36.70 x 8.00 x 12.08 Eng.→580.000
V94108 36.00 x 7.00 x 95.50 Eng.580.001→	028 109 601B	 MB	45°	Y H	VAG96041B 36.50 x 7.00 x 12.08 Eng.580.001→
V91334 31.30 x 7.95 x 95.10 Eng.→580.000	074 109 611	 ME	45°	ss H	
V94109 31.10 x 7.00 x 95.60 Eng.580.001→	028 109 611E	 MG	45°	H	

BV850 MLS, 1.530mm, 1 Hole BV860 MLS, 1.570mm, 2 Holes BV870 MLS, 1.610mm, 3 Holes	DV850 ▲ →Eng.580.000 DV851 ▲ Eng.580.001→	HBS018 ⊕ M12x1.75x115mm (x10)	JD170 JC152 (x4) JE138 [61] JE5076	JN914 HM5058	HR569 →Eng.580.000 HR816 Eng.580.001→	NA5001 32.00x47.00x10.00mm FPM

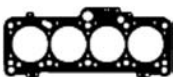

BV850, BV860, BV870

[61] To cylinder 4 - 6







[61] zum Zylinder 4 - 6



203







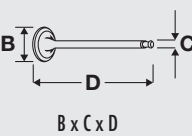
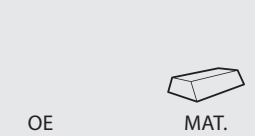
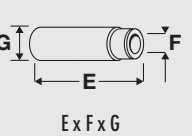

 **79.50**
Diesel

1Z	4 Cyl.	19.5:1	1896cc	66kW (89)PS	Turbo Intercooled	TD214	807
1Z	4 Cyl.	19.5:1	1896cc	66kW (89)PS	Turbo Intercooled	TD4961	807
1Z	4 Cyl.	19.5:1	1896cc	66kW (89)PS	Turbo Intercooled	TD5527	807

80	09/91→01/96	A4	01/95→09/01	A6	06/94→12/97
ALHAMBRA	04/96→03/10	CABRIOLET	06/95→08/00	CADDY	09/96→01/04
CORDOBA	08/96→06/99	GOLF	09/93→04/99	IBIZA	08/96→08/99
PASSAT	10/93→05/97	SHARAN	09/95→03/10	TOLEDO	08/95→03/99
VENTO	09/93→09/98	VOYAGE	09/99→09/01		

					
TB384 137x25.4	TBK026 Eng.1Z-289575→ TBK119 Eng.→1Z-289575	CAM668 →12/93 CAM441 01/94→	KIT		FOL92 (x8)

		
B x C x D	OE	MAT.
V94010 ■ 36.00 x 8.00 x 96.80	028 109 601H	 MB
V94011 ■ 31.50 x 7.95 x 96.85	046 109 611F	 MG
	45°	Y
	45°	ss
	H	
		VAG92061B ■ ■ ■ 36.70 x 8.00 x 12.08

							
BX800 MLS, 1.450mm, 1 Hole BX810 MLS, 1.530mm, 2 Holes BX820 MLS, 1.610mm, 3 Holes	DX800 ▲ →Eng.1Z-720 000 DX801 ▲ Eng.1Z-720 001→	HBS018 ⊕ M12x1.75x115mm (x10)	JD170 ■ JC152 ■ (x4)	JP003 HM5367 ■	HR569 ■ →Eng.1Z-720 000 HR816 ■ Eng.1Z-720 001→	NA5001 32.00x47.00x10.00mm FPM	

BX800, BX810, BX820

204

79.50

Diesel



AAZ	4 Cyl.	22.5:1	1896cc	55kW (75)PS	Turbo	TD229	808
AAZ	4 Cyl.	22.5:1	1896cc	55kW (75)PS	Turbo	TD4894	808
AAZ	4 Cyl.	22.5:1	1896cc	55kW (75)PS	Turbo	TD4972	808

80	09/91→12/94	CORDOBA	02/93→08/96	GOLF	11/91→09/99
IBIZA	03/93→08/96	PASSAT	03/91→05/97	TOLEDO	05/91→03/99
VENTO	11/91→09/98				

TB384 137x25.4	TBK024 Eng.→1Z-552765 TBK025 Eng.1Z-552766→	CAM440	KIT	FOL92 (x8)

 B x C x D	OE	MAT.			 E x F x G
V91336 36.10 x 7.97 x 95.00 Eng.→678000	069 109 601H	 MD	45°		VAG92061B 36.70 x 8.00 x 12.08 Eng.→678000
V94727 36.00 x 6.97 x 95.55 Eng.678001→	028 109 601B	 MB	45°	H	VAG96041B 36.50 x 7.00 x 12.08 Eng.678001→
V91334 31.30 x 7.95 x 95.10 Eng.→678000	074 109 611	 ME	45°	ss H	
V94109 31.10 x 7.00 x 95.60 Eng.678001→	028 109 611E	 MG	45°	H	

BV850 MLS, 1.530mm, 1 Hole BV860 MLS, 1.570mm, 2 Holes BV870 MLS, 1.610mm, 3 Holes	DV850 ▲	HBS018 ⊙ M12x1.75x115mm (x10)	JD170 JC152 (x4) ⊙JE5076	JN914 HM5058	HR569	NA5001 32.00x47.00x10.00mm FPM

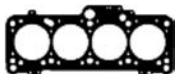

BV850, BV860, BV870

VW GROUP

205

79.50

Diesel



ABL 4 Cyl. 22.5:1 1896cc 50kW (68)PS Turbo TD4009 808

TRANSPORTER 10/92→04/03

TB384 137x25.4	TBK024 →07/94 TBK025 07/94→	CAM440		FOL92 (x8)	

B x C x D	OE	MAT.	45°	ss	H
V91336 ■ 36.10 x 7.97 x 95.00	069 109 601H		45°		
V91334 ■ 31.30 x 7.95 x 95.10	074 109 611		45°	ss	H

BV850 MLS, 1.530mm, 1 Hole	DV851 ▲ →Eng.076 000	HBS018 ⊕ M12x1.75x115mm (x10)	JD170 ■	JN914	HR569 ■ →Eng.076 000	NA5001 32.00x47.00x10.00mm FPM	
BV860 MLS, 1.570mm, 2 Holes	DV850 ▲ Eng.076 001→		JC152 ■ (x4)	HM5058 ■	HR816 ■ Eng.076 001→		
BV870 MLS, 1.610mm, 3 Holes							



BV850, BV860, BV870

206

79.50

Diesel



ADE 4 Cyl. 22.5:1 1896cc 55kW (75)PS TD20097 809

BV850 MLS, 1.530mm, 1 Hole	DV850 ▲			JD170 ■		HR646 ■	
BV860 MLS, 1.570mm, 2 Holes	DV851 ▲						
BV870 MLS, 1.610mm, 3 Holes							

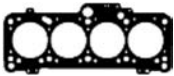

BV850, BV860, BV870

207

79.50

Diesel







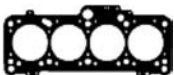





ADE 4 Cyl. 22.5:1 1896cc 55kW (75)PS TD22656 809

BV850 MLS, 1.530mm, 1 Hole	DV850 ▲			JD170 ■		HR646 ■	
BV860 MLS, 1.570mm, 2 Holes	DV851 ▲						
BV870 MLS, 1.610mm, 3 Holes							





BV850, BV860, BV870



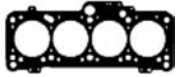



208	 79.50	Diesel					
ADG	4 Cyl.	22.5:1	1896cc	48kW (65)PS	TD20098	810	
							









BV850 MLS, 1.530mm, 1 Hole
 BV860 MLS, 1.570mm, 2 Holes
 BV870 MLS, 1.610mm, 3 Holes











BV850, BV860, BV870

209	 79.50	Diesel				
AEF	4 Cyl.	22.5:1	1896cc	47kW (64)PS	TD13395	806
AEF	4 Cyl.	22.5:1	1896cc	47kW (64)PS	TD4020	806
AEF	4 Cyl.	22.5:1	1896cc	47kW (64)PS	TD9373	806
CADDY	06/96→12/00	FELICIA	10/95→04/02	POLO	10/94→09/01	

					
TB657 137x23	TBK093	CAM440	KIT		FOL92 (x8)

						
B x C x D	OE	MAT.				E x F x G
V91337 ■	069 109 601F		45°		H	VAG92061B ■ ■ ■
36.10 x 7.97 x 95.10		MB				36.70 x 8.00 x 12.08
V94108 ■	028 109 601B		45°	Y	H	VAG96041B ■ ■ ■
36.00 x 7.00 x 95.50		MB				36.50 x 7.00 x 12.08
V91334 ■	074 109 611		45°	ss	H	
31.30 x 7.95 x 95.10		ME				
V94109 ■	028 109 611E		45°		H	
31.10 x 7.00 x 95.60		MG				

							
BV850 MLS, 1.530mm, 1 Hole BV860 MLS, 1.570mm, 2 Holes BV870 MLS, 1.610mm, 3 Holes	DV850 ▲ →Eng.007 000 DV851 ▲ Eng.007 001→		HBS018 ⊕ M12x1.75x115mm (x10)	JD170 ■ JC152 ■ (x4) JE5076	JN914 HM5058 ■	HR569 ■ →Eng.007 000 HR816 ■ Eng.007 001→	NA5001 32.00x47.00x10.00mm FPM

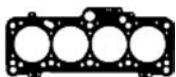

BV850, BV860, BV870

210	79.50	Diesel				
AEY	4 Cyl.	19.5:1	1896cc	47kW (64)PS	TD18729	811
AEY	4 Cyl.	19.5:1	1896cc	47kW (64)PS	TD4985	811
AEY	4 Cyl.	19.5:1	1896cc	47kW (64)PS	TD5535	811
CADDY	11/95→01/04	CORDOBA	08/96→06/99	GOLF	07/95→04/99	
IBIZA	08/96→08/99	INCA	11/95→06/03	POLO	12/95→09/01	
VENTO	04/97→09/98					

TB384 137x25.4	TBK026	CAM668		FOL92 (x8)

	OE	MAT.				
B x C x D						E x F x G
V94409 36.00 x 8.00 x 96.30 Eng.→002000	028 109 601G	 MG	45°		H	VAG92061B 36.70 x 8.00 x 12.08 Eng.→002000
V94112 36.00 x 7.00 x 96.50 Eng.002001→	028 109 601J	 MB	45°	Y	H	VAG96041B 36.50 x 7.00 x 12.08 Eng.002001→
V94410 31.50 x 8.00 x 96.40 Eng.→002000	028 109 611J	 MG	45°	ss	H	
V94113 31.50 x 7.00 x 96.30 Eng.002001→	028 109 611K	 MD	45°			

BX800 MLS, 1.450mm, 1 Hole BX810 MLS, 1.530mm, 2 Holes BX820 MLS, 1.610mm, 3 Holes	DX801 Eng.002 001→	HBS018 M12x1.75x115mm (x10)	JD170 JC152 (x4) JE5076	JP003 HM5367	HR816	NA5001 32.00x47.00x10.00mm FPM



BX800, BX810, BX820

211

79.50

Diesel



AFF 4 Cyl. 1896cc 55kW (75)PS Turbo Intercooled TD11597 807

A4 12/95→09/01

TB384 137x25.4	TBK026	CAM441		FOL92 (x8)

V94084 ■ 35.90 x 7.00 x 96.80 Eng.002001→	028 109 601D		45°	Y	H	VAG96041B ■ ■ ■ 36.50 x 7.00 x 12.08
V94085 ■ 31.40 x 7.00 x 96.90 Eng.002001→	028 109 611G		45°		H	

BX800 MLS, 1.450mm, 1 Hole BX810 MLS, 1.530mm, 2 Holes BX820 MLS, 1.610mm, 3 Holes	DX800 ▲ →Eng.002 000 DX801 ▲ Eng.002 001→	HBS018 ⊕ M12x1.75x115mm (x10)	JD170 ■ JC152 ■ (x4)	JP003 HM5367 ■	HR569 ■ →Eng.002 000 AFF HR816 ■ Eng.002 001→	NA5001 32.00x47.00x10.00mm FPM

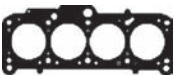







BX800, BX810, BX820







212



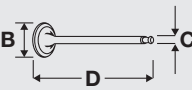



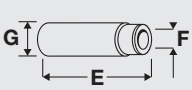

 **79.50**
Diesel

AFN	4 Cyl.	19.5:1	1896cc	81kW (110)PS	Turbo Intercooled	TD4202	813
AFN	4 Cyl.	19.5:1	1896cc	81kW (110)PS	Turbo Intercooled	TD4987	813
AFN	4 Cyl.	19.5:1	1896cc	81kW (110)PS	Turbo Intercooled	TD5531	813

A4	10/95→09/01	A6	04/97→04/01	ALHAMBRA	08/96→06/00
CORDOBA	03/97→06/99	GOLF	04/96→06/02	IBIZA	02/97→08/99
PASSAT	03/96→11/00	POLO	06/98→09/01	SHARAN	09/96→04/00
TOLEDO	11/96→03/99	VENTO	04/96→09/98		

					
TB384 137x25.4	TBK026	CAM441			FOL92 (x8)

					
B x C x D	OE	MAT.	45°	Y	H
V94084 ■ 35.90 x 7.00 x 96.80	028 109 601D		45°	Y	H
V94085 ■ 31.40 x 7.00 x 96.90	028 109 611G		45°		H
					VAG96041B ■ ■ ■ 36.50 x 7.00 x 12.08

							
BX810 MLS, 1.530mm, 2 Holes	DX800 ▲ →Eng.002 000	HBS018 ⊕ M12x1.75x115mm (x10)	JD170 ■ JC152 ■ (x4)	JP003 HM5367 ■	HR569 ■ →Eng.002 000	HR816 ■ Eng.002 001 →	NA5001 32.00x47.00x10.00mm FPM
BX820 MLS, 1.610mm, 3 Holes	DX801 ▲ Eng.002 001 →						
BX800							

BX800, BX810, BX820

213







 79.50











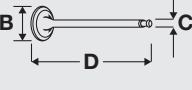

Diesel

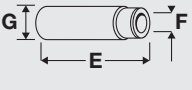













AGD 4 Cyl. 22.5:1 1896cc 47kW (64)PS TD9372 811

POLO 07/96→09/01

					
TB657 137x23	TBK112	CAM668			FOL92 (x8)

					
B x C x D	OE	MAT.			E x F x G
V91337 	069 109 601F		45°	H	VAG92061B  
36.10 x 7.97 x 95.10		MB			36.70 x 8.00 x 12.08
V91334 	074 109 611		45°	ss H	
31.30 x 7.95 x 95.10		ME			
V91368 	068 109 611L		45°	H	
31.30 x 7.95 x 95.00		MG			

							
BX800 MLS, 1.450mm, 1 Hole BX810 MLS, 1.530mm, 2 Holes BX820 MLS, 1.610mm, 3 Holes	DX801 ▲	HBS018  M12x1.75x115mm (x10)	JD170  JC152  (x4)	JP003 HM5367 	HR816 	NA5001 32.00x47.00x10.00mm FPM	

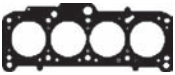

BX800, BX810, BX820

214







 79.50





Diesel





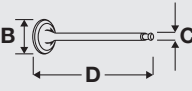
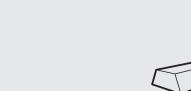



AGP	4 Cyl.	19.5:1	1896cc	50kW (68)PS	TD14808	814
AGP	4 Cyl.	19.5:1	1896cc	50kW (68)PS	TD16424	814
AGP	4 Cyl.	19.5:1	1896cc	50kW (68)PS	TD9452	814

BORA	10/98→05/05	CORDOBA	06/99→12/02	GOLF	08/97→06/06
IBIZA	08/99→02/02	OCTAVIA	06/97→12/03	POLO	08/99→09/01

					
TB533 141x25 Eng.→400 000 TB659 Eng.400 001→	TBK107 Eng.→400 000 TBK272 Eng.400 001→	CAM670	KIT		FOL143 (x8)

		
B x C x D	OE	MAT.
V94112 ■ 36.00 x 7.00 x 96.50	028 109 601J	 MB
V94113 ■ 31.50 x 7.00 x 96.30	028 109 611K	 MD
		VAG96041B ■ ■ ■ 36.50 x 7.00 x 12.08

						
BZO10 MLS, 1.450mm, 1 Hole →Eng.028 000	DZO10 ▲ ⊠	HBS018 ⊙ M12x1.75x115mm (x10)	JD170 ■ JC152 ■ (x4) ⊙ JE5076	HR397	HR816 ■	NA5001 32.00x47.00x10.00mm FPM
BZO20 MLS, 1.530mm, 2 Holes →Eng.028 000						
BZO30 1.610mm, 3 Notches →Eng.028 000						
BZO40 MLS, 1.470mm, 1 Notch, 3 Holes Eng.028 001→						
BZO50 MLS, 1.570mm, 2 Notches, 1 Hole Eng.028 001→						
BZO60 MLS, 1.670mm, 3 Notches, 3 Holes Eng.028 001→						

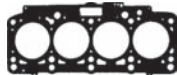

BZO10, BZO20, BZO30







BZO40







215



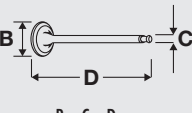



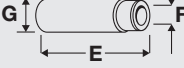

79.50
Diesel

AGR	4 Cyl.	19.5:1	1896cc	66kW (89)PS	Turbo Intercooled	TD13278	815
AGR	4 Cyl.	19.5:1	1896cc	66kW (89)PS	Turbo Intercooled	TD17905	815
AGR	4 Cyl.	19.5:1	1896cc	66kW (89)PS	Turbo Intercooled	TD5076	815
AGR	4 Cyl.	19.5:1	1896cc	66kW (89)PS	Turbo Intercooled	TD9364	815

A3	09/96→07/01	BORA	10/98→05/05	CORDOBA	06/99→12/02
GOLF	10/97→05/06	IBIZA	08/99→02/02	LEON	11/99→06/06
OCTAVIA	09/96→03/10	POLO	09/96→09/01	TOLEDO	04/99→05/06

					
TB533 141x25 Eng.→44441;565000	TBK107 Eng.→44441;565000 TBK272 Eng.44442;565001→	CAM671 Eng: 034859→			FOL143 (x8)
TB659 Eng.44442;565001→					

				
B x C x D	OE	MAT.		E x F x G
V94084 ■ 35.90 x 7.00 x 96.80	028 109 601D	 MB	45° Y H	VAG96041B ■ ■ ■ 36.50 x 7.00 x 12.08
V94085 ■ 31.40 x 7.00 x 96.90	028 109 611G	 MG	45° H	

							
BZ010 MLS, 1.450mm, 1 Hole →Eng.151 000	DZO10 ▲☒		HBS018 ⊙ M12x1.75x115mm (x10)	JD170 ■ JC152 ■ (x4)		HR816 ■	NA5001 32.00x47.00x10.00mm FPM
BZ020 MLS, 1.530mm, 2 Holes →Eng.151 000							
BZ030 1.610mm, 3 Notches →Eng.151 000							
BZ040 MLS, 1.470mm, 1 Notch, 3 Holes Eng.151 001→							
BZ050 MLS, 1.570mm, 2 Notches, 1 Hole Eng.151 001→							
BZ060 MLS, 1.670mm, 3 Notches, 3 Holes Eng.151 001→							

BZ010, BZ020, BZ030

BZ040

216







 79.50



Diesel







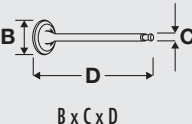

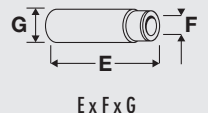
AHF	4 Cyl.	19.5:1	1896cc	81kW (110)PS	Turbo Intercooled	TD12512	816
AHF	4 Cyl.	19.5:1	1896cc	81kW (110)PS	Turbo Intercooled	TD17910	816
AHF	4 Cyl.	19.5:1	1896cc	81kW (110)PS	Turbo Intercooled	TD9371	816
AHF	4 Cyl.	19.5:1	1896cc	81kW (110)PS	Turbo Intercooled	TD9788	816

A3	08/97→07/01	BORA	10/98→06/01	GOLF	08/97→05/04
LEON	11/99→06/06	OCTAVIA	08/97→01/06	TOLEDO	04/99→05/06

					
TB533 141x25 Eng.→150000 TB659 Eng.150001→	TBK107 Eng.→150000 TBK272 Eng.150001→	CAM671	KIT		FOL143 (x8)

		
V94084 ■ 35.90 x 7.00 x 96.80 V94085 ■ 31.40 x 7.00 x 96.90	OE 028 109 601D 028 109 611G MAT. MB MG 45° 45° Y H H	VAG96041B ■ ■ ■ 36.50 x 7.00 x 12.08

						
BZ010 MLS, 1.450mm, 1 Hole →Eng.140 000 BZ020 MLS, 1.530mm, 2 Holes →Eng.140 000 BZ030 1.610mm, 3 Notches →Eng.140 000 BZ040 MLS, 1.470mm, 1 Notch, 3 Holes Eng.140 001→ BZ050 MLS, 1.570mm, 2 Notches, 1 Hole Eng.140 001→ BZ060 MLS, 1.670mm, 3 Notches, 3 Holes Eng.140 001→	DZ010 ▲ ⊗	HBS018 ⊙ M12x1.75x115mm (x10)	JD170 ■ JC152 ■ (x4)		HR816 ■	NA5001 32.00x47.00x10.00mm FPM



BZ010, BZ020, BZ030

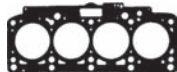

BZ040

217

79.50

Diesel



AHH	4 Cyl.	19.5:1	1896cc	66kW (89)PS	Turbo Intercooled	TD10927	807
AHH	4 Cyl.	19.5:1	1896cc	66kW (89)PS	Turbo Intercooled	TD16413	807
A4	01/95→09/01		PASSAT	10/96→11/00			

TBK335		CAM441			FOL92 (x8)

B x C x D	OE	MAT.	45°	Y	H	E x F x G
V94084 ■	028 109 601D		45°	Y	H	VAG96041B ■ ■ ■
35.90 x 7.00 x 96.80		MB				36.50 x 7.00 x 12.08
V94085 ■	028 109 611G		45°		H	
31.40 x 7.00 x 96.90		MG				

BX800 MLS, 1.450mm, 1 Hole	DX801 ▲	HBS018 ⊕	JD170 ■	JP003	HR816 ■	NA5001
BX810 MLS, 1.530mm, 2 Holes		M12x1.75x115mm (x10)	JC152 ■ (x4)	HM5367 ■		32.00x47.00x10.00mm FPM
BX820 MLS, 1.610mm, 3 Holes						



BX800, BX810, BX820



AHU	4 Cyl.	19.5:1	1896cc	66kW (89)PS	Turbo Intercooled	TD10814	817
AHU	4 Cyl.	19.5:1	1896cc	66kW (89)PS	Turbo Intercooled	TD4990	817
AHU	4 Cyl.	19.5:1	1896cc	66kW (89)PS	Turbo Intercooled	TD5528	817

A4	01/95→09/01	A6	06/94→12/97	ALHAMBRA	04/96→03/10
CABRIOLET	06/95→08/00	CADDY	09/96→01/04	CORDOBA	08/96→10/02
GOLF	09/93→06/02	IBIZA	08/96→08/99	PASSAT	10/93→11/00
POLO	09/96→09/01	SHARAN	09/95→03/10	TOLEDO	08/95→03/99
VENTO	09/93→09/98				

TB384 137x25.4	TBK026	CAM441	KIT	FOL92 (x8)

V94084 ■ 35.90 x 7.00 x 96.80	V94085 ■ 31.40 x 7.00 x 96.90	MAT. MB MG	45°	Y	H	VAG96041B ■ ■ ■ 36.50 x 7.00 x 12.08
028 109 601D	028 109 611G					

BX800 MLS, 1.450mm, 1 Hole BX810 MLS, 1.530mm, 2 Holes BX820 MLS, 1.610mm, 3 Holes	DX800 ▲ →Eng.720 000 DX801 ▲ Eng.720 001→	HBS018 ⊙ M12x1.75x115mm (x10)	JD170 ■ JC152 ■ (x4)	JP003 HM5367 ■	HR569 ■ →Eng.720 000 HR816 ■ Eng.720 001→	NA5001 32.00x47.00x10.00mm FPM



BX800, BX810, BX820

219







 79.50

Diesel



AJM	4 Cyl.	19.5:1	1896cc	85kW (115)PS	Turbo Intercooled	TD11527	818
AJM	4 Cyl.	19.5:1	1896cc	85kW (115)PS	Turbo Intercooled	TD12588	818
ATJ	4 Cyl.		1896cc	85kW (115)PS	Turbo Intercooled	TD15989	828
ATJ	4 Cyl.		1896cc	85kW (115)PS	Turbo Intercooled	TD16258	828

A4	03/00→09/01	A6	07/00→01/05	BORA	12/98→06/01
GOLF	12/98→06/01	PASSAT	08/98→11/00		

					
TB680 120x30	TBK225 without tensioner pulley damper TBK269 with tensioner pulley damper	CAM672 [16] CAM914 [17] CAM928 [52]	KIT		FOL175 (x8)

[16] Chilled Cast Iron





[16] Schalenhartguss





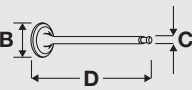

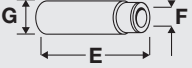

[17] Induction Hardened Cast Iron



[17] Induktionsgehärtetes Gusseisen

[52] Steel

[52] Stahl

						
B x C x D	OE	MAT.	45°	ss	H	E x F x G
V94147 ■ 35.90 x 7.00 x 89.90	038 109 601B	MB	45°	ss	H	VAG96041B ■ ■ ■ 36.50 x 7.00 x 12.08
V94148 ■ 31.50 x 7.00 x 90.00	038 109 611B	MG	45°	ss	H	

							
AF5381 MLS, 1.490mm, 1 Hole AF5391 MLS, 1.530mm, 2 Holes AF5401 MLS, 1.650mm, 3 Holes	CC5231 ▲		HBS300 ⊙ M12x1.75x166mm (x10)	JD170 ■ JC152 ■ (x4)	JM5120	HR816 ■	NA5124 32.00x47.00x10.00mm PTFE/ACM

		
AF5381	AF5391	AF5401







220



 **79.50**







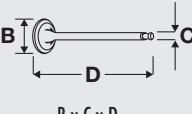
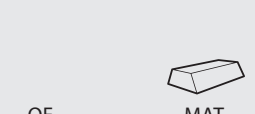
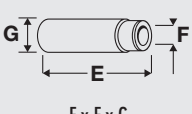

Diesel



ALE	4 Cyl.	1896cc	66kW (89)PS	Turbo Intercooled	TD9512	819
CADDY	10/96 → 01/04	GOLF	09/93 → 06/02	POLO	09/96 → 09/01	
VENTO	09/93 → 09/98					

					
TB384 137x25.4	TBK026	CAM441			FOL92 (x8)

		
B x C x D	OE	MAT.
V94084 ■	028 109 601D	
35.90 x 7.00 x 96.80		45° Y H
V94085 ■	028 109 611G	
31.40 x 7.00 x 96.90		45° H
		VAG96041B ■ ■ ■
		36.50 x 7.00 x 12.08

							
BX800 MLS, 1.450mm, 1 Hole	DX801 ▲	HBS018 ⊕	JD170 ■	JP003	JM5367 ■	HR816 ■	NA5001
BX810 MLS, 1.530mm, 2 Holes		M12x1.75x115mm (x10)	JC152 ■ (x4)				32.00x47.00x10.00mm FPM
BX820 MLS, 1.610mm, 3 Holes							



BX800, BX810, BX820

221

79.50

Diesel



ALH	4 Cyl.	19.5:1	1896cc	66kW (89)PS	Turbo Intercooled	TD11595	807
ALH	4 Cyl.	19.5:1	1896cc	66kW (89)PS	Turbo Intercooled	TD13272	807
ALH	4 Cyl.	19.5:1	1896cc	66kW (89)PS	Turbo Intercooled	TD16090	807
ALH	4 Cyl.	19.5:1	1896cc	66kW (89)PS	Turbo Intercooled	TD9455	807

A3	09/96→07/01	BORA	10/98→06/01	CADDY	09/96→01/04
CORDOBA	06/99→12/02	GOLF	10/97→05/06	IBIZA	08/99→02/02
INCA	09/96→06/03	LEON	11/99→06/06	NEW BEETLE	01/98→06/04
OCTAVIA	09/96→03/10	POLO	09/96→09/01	TOLEDO	04/99→05/06

TB533 141x25 Eng.→500000 TB659 Eng.500001→	TBK107 Eng.→500000 TBK272 Eng.500001→	CAM671			FOL143 (x8)

B x C x D	OE	MAT.	45°	Y	H
V94084 ■ 35.90 x 7.00 x 96.80 V94085 ■ 31.40 x 7.00 x 96.90	028 109 601D 028 109 611G	MB MG	45°		H
					VAG96041B ■ ■ ■ 36.50 x 7.00 x 12.08

BZ010 MLS, 1.450mm, 1 Hole →Eng.085 000 BZ020 MLS, 1.530mm, 2 Holes →Eng.085 000 BZ030 1.610mm, 3 Notches →Eng.085 000 BZ040 MLS, 1.470mm, 1 Notch, 3 Holes Eng.085 001→ BZ050 MLS, 1.570mm, 2 Notches, 1 Hole Eng.085 001→ BZ060 MLS, 1.670mm, 3 Notches, 3 Holes Eng.085 001→	DZ010 ▲☒		HBS018 ⊕ M12x1.75x115mm (x10)	JD170 ■ JC152 ■ (x4) JD606 ■		HR816 ■	NA5001 32.00x47.00x10.00mm FPM



BZ010, BZ020, BZ030 BZ040

222

79.50

Diesel



ANC	4 Cyl.	22:1	1896cc	44kW (60)PS	TD20491	820
-----	--------	------	--------	-------------	---------	-----





						HR646 ■	

223

 **79.50**
Diesel

ANU	4 Cyl.	18:1	1896cc	66kW (89)PS	Turbo Intercooled	TD11596	821
ANU	4 Cyl.	18:1	1896cc	66kW (89)PS	Turbo Intercooled	TD13443	821
ANU	4 Cyl.	18:1	1896cc	66kW (89)PS	Turbo Intercooled	TD14911	821

ALHAMBRA	04/96→03/10	SHARAN	09/95→03/10
-----------------	-------------	---------------	-------------

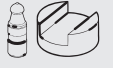
					
TB680 120x30	TBK225 →02/02, without tensioner pulley damper TBK269 →02/02, with tensioner pulley damper TBK270 02/02→	CAM672 [16] CAM914 [17] CAM928 [52]	KIT		FOL175 (x8)

[16] Chilled Cast Iron

[16] Schalenhartguss







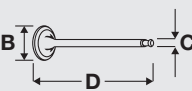
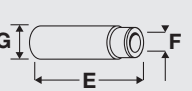

[17] Induction Hardened Cast Iron



[17] Induktionsgehärtetes Gusseisen







[52] Steel









[52] Stahl

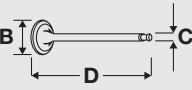





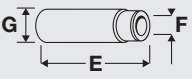

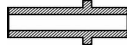
	
V94147 ■ 35.90 x 7.00 x 89.90	VAG96041B ■ ■ ■ ■ ■ 36.50 x 7.00 x 12.08
V94148 ■ 31.50 x 7.00 x 90.00	
OE: 038 109 601B MAT: MB, MG Angle: 45° Material: ss Hardness: H	

							
AF5381 MLS, 1.490mm, 1 Hole AF5391 MLS, 1.530mm, 2 Holes AF5401 MLS, 1.650mm, 3 Holes	CC5230 ▲	HBS300 ⊙ M12x1.75x166mm (x10)	JD170 ■ JD600 ■	JM5203	HR816 ■	NA5124 32.00x47.00x10.00mm PTFE/ACM	

224	 79.50	Diesel					
AQM	4 Cyl.	19.5:1	1896cc	50kW (68)PS	Turbo Intercooled	TD11351	822
AQM	4 Cyl.	19.5:1	1896cc	50kW (68)PS	Turbo Intercooled	TD13271	822
AQM	4 Cyl.	19.5:1	1896cc	50kW (68)PS	Turbo Intercooled	TD16089	822
BORA	10/98→05/05	CORDOBA	06/99→12/02	GOLF	08/97→06/06		
IBIZA	08/99→02/02	LEON	11/99→06/06	OCTAVIA	06/97→12/03		
POLO	08/99→09/01	TOLEDO	11/99→06/04				



					
TB533 141x25 Eng.→45000 TB659 Eng.45001→	TBK107 Eng.→45000 TBK272 Eng.45001→	CAM670	KIT		FOL143 (x8)

						
B x C x D	OE	MAT.	45°	Y	H	E x F x G
V94112 ■ 36.00 x 7.00 x 96.50	028 109 601J		45°			VAG96041B ■ ■ ■ 36.50 x 7.00 x 12.08
V94113 ■ 31.50 x 7.00 x 96.30	028 109 611K		45°			

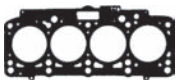
							
BZ040 MLS, 1.470mm, 1 Hole BZ050 MLS, 1.570mm, 2 Holes BZ060 MLS, 1.670mm, 3 Holes	DZ010 ▲ ☒		HBS018 ⊕ M12x1.75x115mm (x10)	JD170 ■ JD606 ■ ☉ JE5076		HR816 ■	NA5001 32.00x47.00x10.00mm FPM



BZ040, BZ050, BZ060

225	 79.50	Diesel			
ARD	4 Cyl.	1896cc	44kW (60)PS	TD20099	812
BZ040 MLS, 1.470mm, 1 Hole BZ050 MLS, 1.570mm, 2 Hole BZ060 MLS, 1.670mm, 3 Holes				JD170 ■	HR646 ■

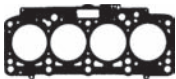

BZ040, BZ050, BZ060

226







 79.50

Diesel



ARL	4 Cyl.	19.5:1	1896cc	110kW (150)PS	Turbo Intercooled	TD15484	823
ARL	4 Cyl.	19.5:1	1896cc	110kW (150)PS	Turbo Intercooled	TD15768	823
AUY	4 Cyl.	18:1	1896cc	85kW (115)PS	Turbo Intercooled	TD14912	829
AUY	4 Cyl.	18:1	1896cc	85kW (115)PS	Turbo Intercooled	TD14915	829

ALHAMBRA	06/00→03/10	BORA	12/98→05/05	GOLF	12/98→06/05
LEON	02/01→06/06	SHARAN	04/00→03/10	TOLEDO	10/00→05/06

					
TB680 120x30	TBK225 →02/02, without tensioner pulley damper TBK269 →02/02, with tensioner pulley damper TBK270 02/02→	CAM672 [16] CAM914 [17] CAM928 [52]	KIT		FOL175 (x8)

[16] Chilled Cast Iron



[16] Schalenhartguss

[17] Induction Hardened Cast Iron

[17] Induktionsgehärtetes Gusseisen

[52] Steel

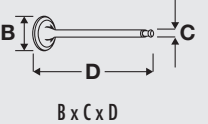
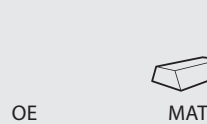
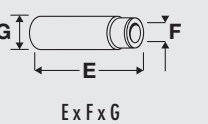
[52] Stahl

		
B x C x D	OE	MAT.
V94147 ■ 35.90 x 7.00 x 89.90	038 109 601B	 MB
V94148 ■ 31.50 x 7.00 x 90.00	038 109 611B	 MG
		45°
		45° ss
		H
		H
		VAG96041B ■ ■ ■ 36.50 x 7.00 x 12.08

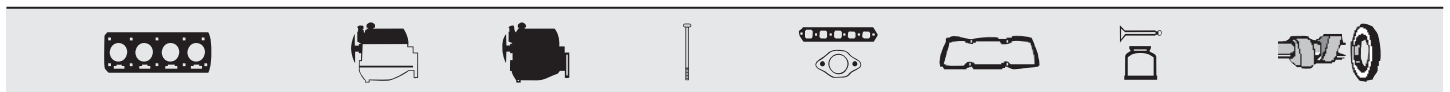

AF5381 MLS, 1.490mm, 1 Hole	CC5231 ▲	HBS300 ⊕ M12x1.75x166mm (x10)	JD170 ■ JC152 ■ (x4)	JM5203	HR816 ■	NA5124 32.00x47.00x10.00mm PTFE/ACM
AF5391 MLS, 1.530mm, 2 Holes						
AF5401 MLS, 1.650mm, 3 Holes						

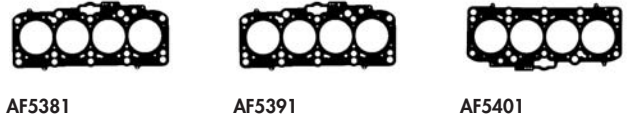

AF5381

AF5391

AF5401

227

 **79.50**

Diesel







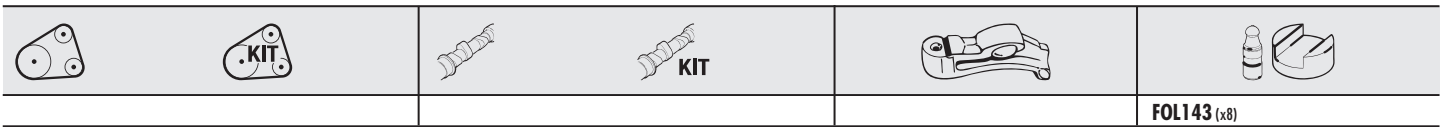



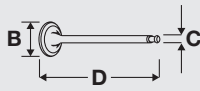



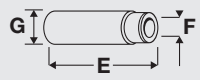

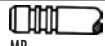

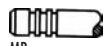

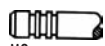



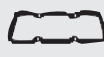

ASK 4 Cyl. 1896cc 81kW (110)PS Turbo Intercooled TD13277 **824**

CORDOBA 06/99→12/02 IBIZA 08/99→02/02



FOL143 (x8)

 B x C x D	OE	MAT.				 E x F x G
V94084 	028 109 601D	 MB	45°	Y	H	VAG96041B  36.50 x 7.00 x 12.08
35.90 x 7.00 x 96.80						
V94112 	028 109 601J	 MB	45°	Y	H	
36.00 x 7.00 x 96.50						
V94085 	028 109 611G	 MG	45°		H	
31.40 x 7.00 x 96.90						

							
BZ040 MLS, 1.470mm, 1 Hole	DZ010 		HBS018  M12x1.75x115mm (x10)	JD170 		HR816 	NA5001 32.00x47.00x10.00mm FPM
BZ050 MLS, 1.570mm, 2 Holes				JC152  (x4)			
BZ060 MLS, 1.670mm, 3 Holes							

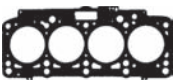

BZ040, BZ050, BZ060

228







 79.50







Diesel



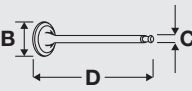





ASV	4 Cyl.	19.5:1	1896cc	81kW (110)PS	Turbo Intercooled	TD13273	816
ASV	4 Cyl.	19.5:1	1896cc	81kW (110)PS	Turbo Intercooled	TD13773	816
ASV	4 Cyl.	19.5:1	1896cc	81kW (110)PS	Turbo Intercooled	TD15354	816
ASV	4 Cyl.	19.5:1	1896cc	81kW (110)PS	Turbo Intercooled	TD16091	816

A3	08/97→07/01	BORA	10/98→06/01	CORDOBA	06/99→12/02
GOLF	08/97→05/04	IBIZA	08/99→02/02	LEON	11/99→
OCTAVIA	08/97→01/06	POLO	06/98→09/01	TOLEDO	04/99→05/06

					
TB533 141x25 Eng.→150000 TB659 Eng.150001→	TBK107 Eng.→150000 TBK272 Eng.150001→	CAM671	KIT		FOL143 (x8)

					
B x C x D	OE	MAT.	45°	Y	H
V94084 ■ 35.90 x 7.00 x 96.80	028 109 601D		45°	Y	H
V94085 ■ 31.40 x 7.00 x 96.90	028 109 611G		45°		H
					VAG96041B ■ ■ ■ 36.50 x 7.00 x 12.08

						
BZ040 MLS, 1.470mm, 1 Hole BZ050 MLS, 1.570mm, 2 Holes BZ060 MLS, 1.670mm, 3 Holes	DZO10 ▲☒	HBS018 ◎ M12x1.75x115mm (x10)	JD170 ■ JC152 ■ (x4)		HR816 ■	NA5001 32.00x47.00x10.00mm FPM

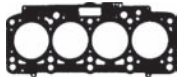

BZ040, BZ050, BZ060

229

79.50

Diesel



ASX 4 Cyl. 1896cc 47kW (64)PS TD15495 825

POLO 10/99→09/01

TB657 137x23	TBK112				

B x C x D	OE	MAT.	45°	Y	H	E x F x G	
V94112 ■ 36.00 x 7.00 x 96.50	028 109 601J		45°			VAG96041B ■ ■ ■ 36.50 x 7.00 x 12.08	
V94113 ■ 31.50 x 7.00 x 96.30	028 109 611K		45°				

BX800 MLS, 1.450mm, 1 Hole BX810 MLS, 1.530mm, 2 Holes BX820 MLS, 1.610mm, 3 Holes	DX801 ▲	HBS018 ⊕ M12x1.75x115mm (x10)	JD170 ■ JC152 ■ (x4)	JP003 HM5367 ■	HR816 ■	NA5001 32.00x47.00x10.00mm FPM



BX800, BX810, BX820

230







 **79.50**







Diesel



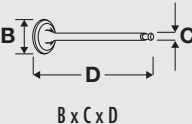



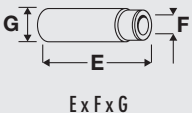



ASY	4 Cyl.	19.5:1	1896cc	47kW (64)PS	TD15376	822
ASY	4 Cyl.	19.5:1	1896cc	47kW (64)PS	TD16338	822
ASY	4 Cyl.	19.5:1	1896cc	47kW (64)PS	TD16461	822

CORDOBA	09/02→11/09	FABIA	11/99→03/08	IBIZA	02/02→12/05
POLO	10/01→				

					
TB533 141x25 Eng.→021000 TB659 Eng.021001→	TBK107 Eng.→021000 TBK272 Eng.021001→	CAM670	KIT		FOL143 (x8)

					
B x C x D	OE	MAT.	45°	Y	H
V94112 ■ 36.00 x 7.00 x 96.50	028 109 601J		45°		
V94113 ■ 31.50 x 7.00 x 96.30	028 109 611K		45°		
					VAG96041B ■ ■ ■ 36.50 x 7.00 x 12.08

							
BZ040 MLS, 1.470mm, 1 Hole BZ050 MLS, 1.570mm, 2 Holes BZ060 MLS, 1.670mm, 3 Holes	CC5231 ▲		HBS018 ⊙ M12x1.75x115mm (x10)	JD170 ■ JC152 ■ (x4)	JM5203	HR816 ■	NA5001 32.00x47.00x10.00mm FPM NA5124 32.00x47.00x10.00mm PTFE/ACM

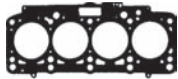

BZ040, BZ050, BZ060

231

79.50

Diesel



ASZ	4 Cyl.	19.5:1	1896cc	96kW (131)PS	Turbo Intercooled	TD15351	826
ASZ	4 Cyl.	19.5:1	1896cc	96kW (131)PS	Turbo Intercooled	TD16231	826
ASZ	4 Cyl.	19.5:1	1896cc	96kW (131)PS	Turbo Intercooled	TD16463	826
ASZ	4 Cyl.	19.5:1	1896cc	96kW (131)PS	Turbo Intercooled	TD17036	826

A3	08/00→05/03	ALHAMBRA	11/02→11/08	BORA	11/00→05/05
CORDOBA	10/02→11/09	FABIA	06/03→03/08	GOLF	11/00→06/06
IBIZA	02/02→11/09	LEON	05/03→06/06	OCTAVIA	09/02→09/04
POLO	11/03→11/09	SHARAN	11/02→03/10	TOLEDO	05/03→05/06

TB680 120x30	TBK225 →02/02, without tensioner pulley damper TBK269 →02/02, with tensioner pulley damper TBK270 02/02→	CAM672 [16] CAM914 [17] CAM928 [52]			FOL175 (x8)

[16] Chilled Cast Iron

[16] Schalenhartguss

[17] Induction Hardened Cast Iron

[17] Induktionsgehärtetes Gusseisen

[52] Steel

[52] Stahl

V94147 ■ 35.90 x 7.00 x 89.90	V94148 ■ 31.50 x 7.00 x 90.00 Eng.→FM.070.000	VAG96041B ■ ■ ■ 36.50 x 7.00 x 12.08
038 109 601B	038 109 611B	
MB	MG	
45°	45° ss	
H	H	

AF5381 MLS, 1.490mm, 1 Hole AF5391 MLS, 1.530mm, 2 Holes AF5401 MLS, 1.650mm, 3 Holes	CC5230 ▲	HBS300 ⊕ M12x1.75x166mm (x10)	JD170 ■ JC152 ■ (x4)	JMS203	HR816 ■	NA5124 32.00x47.00x10.00mm PTFE/ACM



AF5381



AF5391









AF5401

232

79.50
Diesel

ATD	4 Cyl.	19:1	1896cc	74kW (100)PS	Turbo Intercooled	TD15377	827
ATD	4 Cyl.	19:1	1896cc	74kW (100)PS	Turbo Intercooled	TD15473	827
ATD	4 Cyl.	19:1	1896cc	74kW (100)PS	Turbo Intercooled	TD16028	827
ATD	4 Cyl.	19:1	1896cc	74kW (100)PS	Turbo Intercooled	TD16462	827
AWX	4 Cyl.	19:1	1896cc	96kW (131)PS	Turbo	TD15154	831
AWX	4 Cyl.	19:1	1896cc	96kW (131)PS	Turbo Intercooled	TD16133	831
AWX	4 Cyl.	19:1	1896cc	96kW (131)PS	Turbo Intercooled	TD16403	831

A3	10/00→05/03	A4	11/00→12/04	A6	08/01→01/05
BORA	09/00→05/05	CORDOBA	09/02→11/09	FABIA	01/00→03/08
GOLF	09/00→06/06	IBIZA	02/02→11/09	NEW BEETLE	02/01→
OCTAVIA	08/00→12/10	PASSAT	11/00→05/05	POLO	10/01→
SUPERB	12/01→03/08				

					
TB680 120x30	TBK225 →02/02, without tensioner pulley damper TBK269 →02/02, with tensioner pulley damper TBK270 02/02→	CAM672 [16] CAM914 [17] CAM928 [52]	KIT		FOL175 (x8)

[16] Chilled Cast Iron

[16] Schalenhartguss

[17] Induction Hardened Cast Iron

[17] Induktionsgehärtetes Gusseisen

[52] Steel

[52] Stahl

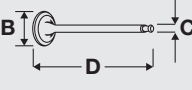
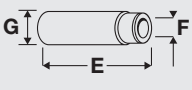
	
V94147 ■ 35.90 x 7.00 x 89.90	VAG96041B ■ ■ ■ 36.50 x 7.00 x 12.08
V94148 ■ 31.50 x 7.00 x 90.00	
OE	MAT.
038 109 601B	45° H
038 109 611B	45° ss H

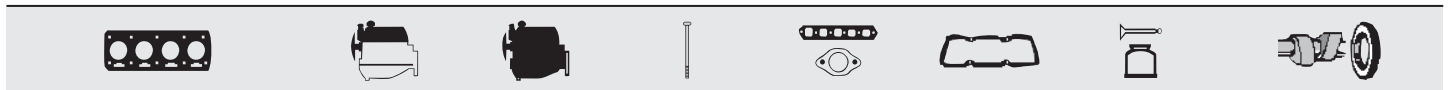

AF5381 MLS, 1.490mm, 1 Hole AF5391 MLS, 1.530mm, 2 Holes AF5401 MLS, 1.650mm, 3 Holes	CC5230 ▲	HBS300 ⊕ M12x1.75x166mm (x10)	JD170 ■ JD600 ■	JM5203	HR816 ■	NA5124 32.00x47.00x10.00mm PTFE/ACM
--	-----------------	---	----------------------------------	---------------	----------------	---

AF5381

AF5391

AF5401

233

79.50

Diesel



AVB	4 Cyl.	19:1	1896cc	74kW (100)PS	Turbo Intercooled	TD15152	830
AVB	4 Cyl.	19:1	1896cc	74kW (100)PS	Turbo Intercooled	TD16518	830
AVB	4 Cyl.	19:1	1896cc	74kW (100)PS	Turbo Intercooled	TD17037	830

A4	05/01→12/04	PASSAT	02/00→05/05	SUPERB	08/02→10/05
----	-------------	--------	-------------	--------	-------------

TB680 120x30	TBK225 →10/01, without tensioner pulley damper TBK269 →10/01, with tensioner pulley damper TBK270 10/01→	CAM672 [16] CAM914 [17] CAM928 [52]	KIT		FOL175 (x8)

[16] Chilled Cast Iron

[16] Schalenhartguss

[17] Induction Hardened Cast Iron

[17] Induktionsgehärtetes Gusseisen

[52] Steel

[52] Stahl

B x C x D	E x F x G
OE	
MAT.	
V94147 ■ 35.90 x 7.00 x 89.90	VAG96041B ■ ■ ■ 36.50 x 7.00 x 12.08
V94148 ■ 31.50 x 7.00 x 90.00	
038 109 601B	
038 109 611B	
MB	
MG	
45°	
45° ss	
H	
H	

AF5381 MLS, 1.490mm, 1 Hole	CC5230 ▲	HBS300 ⊙ M12x1.75x166mm (x10)	JD170 ■ JD600 ■	JMS203	HR816 ■	NA5124 32.00x47.00x10.00mm PTFE/ACM	
AF5391 MLS, 1.530mm, 2 Holes							
AF5401 MLS, 1.650mm, 3 Holes							

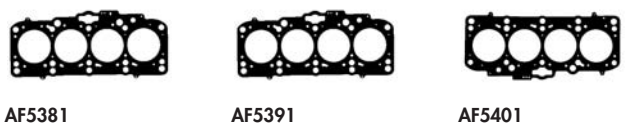

AF5381

AF5391

AF5401

234







 79.50

Diesel











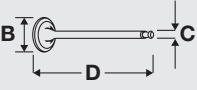

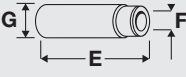

AVF	4 Cyl.	19:1	1896cc	96kW (131)PS	Turbo Intercooled	TD15153	831
AVF	4 Cyl.	19:1	1896cc	96kW (131)PS	Turbo Intercooled	TD15348	831
AVF	4 Cyl.	19:1	1896cc	96kW (131)PS	Turbo Intercooled	TD18239	831

A4	11/00→12/04	A6	08/01→01/05	PASSAT	11/00→05/05
SUPERB	12/01→03/08				

					
TB680 120x30	TBK225 →8E-2297100, without tensioner pulley damper TBK270 8E-2297101→	CAM672 [16] CAM914 [17] CAM928 [52]	KIT		FOL175 (x8)

[16] Chilled Cast Iron [16] Schalenhartguss
 [17] Induction Hardened Cast Iron [17] Induktionsgehärtetes Gusseisen
 [52] Steel [52] Stahl

					
B x C x D	OE	MAT.	45°	H	E x F x G
V94147 ■ 35.90 x 7.00 x 89.90	038 109 601B	 MB	45°	H	VAG96041B ■ ■ ■ 36.50 x 7.00 x 12.08
V94148 ■ 31.50 x 7.00 x 90.00	038 109 611B	 MG	45° ss	H	

						
AF5381 MLS, 1.490mm, 1 Hole AF5391 MLS, 1.530mm, 2 Holes AF5401 MLS, 1.650mm, 3 Holes	CC5230 ▲	HBS300 ⊙ M12x1.75x166mm (x10)	JD170 ■ JD600 ■	JM5203	HR816 ■	NA5124 32.00x47.00x10.00mm PTFE/ACM

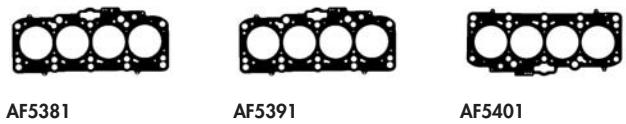

AF5381 **AF5391** **AF5401**

235	79.50	Diesel					
AVG	4 Cyl.	19.5:1	1896cc	81kW (110)PS	Turbo Intercooled	TD13774	813
AVG	4 Cyl.	19.5:1	1896cc	81kW (110)PS	Turbo Intercooled	TD14988	813
AVG	4 Cyl.	19.5:1	1896cc	81kW (110)PS	Turbo Intercooled	TD23884	813
A4	10/95→09/01	A6	04/97→10/00	ALHAMBRA	08/96→06/00		
GOLF	06/98→06/02	PASSAT	10/96→11/00	SHARAN	09/96→04/00		

TB384 137x25.4	TBK026	CAM441	KIT	FOL92 (x8)

V94084 ■ 35.90 x 7.00 x 96.80	V94085 ■ 31.40 x 7.00 x 96.90	VAG96041B ■ ■ ■ 36.50 x 7.00 x 12.08
OE: 028 109 601D	OE: 028 109 611G	OE: 028 109 611G
MAT: MB	MAT: MG	MAT: MB
45°	45°	45°
Y		H
H	H	H

BX800 MLS, 1.450mm, 1 Hole BX810 MLS, 1.530mm, 2 Holes BX820 MLS, 1.610mm, 3 Holes	DX801 ▲	HBS018 ⊕ M12x1.75x115mm (x10)	JD170 ■ JC152 ■ (x4) JE5075	JP003 HM5367 ■	HR816 ■	NA5001 32.00x47.00x10.00mm FPM	

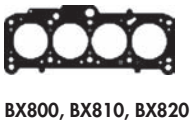

236	79.50	Diesel			
AVM	4 Cyl.	19:1	1896cc	63kW (85)PS	TD18705
BZ040 MLS, 1.470mm, 1 Hole BZ050 MLS, 1.570mm, 2 Hole		JD170 ■			

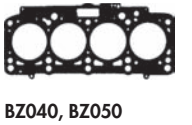



AVQ 4 Cyl. 19:1 1896cc 74kW (100)PS Turbo Intercooled TD16861 832

TOURAN 02/03 → 05/04

TB680 120x30	TBK270	CAM672 [16] CAM914 [17] CAM928 [52]			FOL175 (x8)

[16] Chilled Cast Iron [16] Schalenhartguss
 [17] Induction Hardened Cast Iron [17] Induktionsgehärtetes Gusseisen
 [52] Steel [52] Stahl

B x C x D	OE	E x F x G
V94649 ■	038 109 601E	VAG96041B ■ ■ ■
36.00 x 7.00 x 89.40		36.50 x 7.00 x 12.08
V94650 ■	038 109 611E	
31.40 x 7.00 x 89.00		
	MAT.	
	45° Y H	
	45° ss H	

AF5381 MLS, 1.490mm, 1 Hole	CC5230 ▲		HB5300 ©	JD170 ■	JM5203	HR816 ■	NA5124
AF5391 MLS, 1.530mm, 2 Holes			M12x1.75x166mm (x10)	JD600 ■			32.00x47.00x10.00mm PTFE/ACM
AF5401 MLS, 1.650mm, 3 Holes							

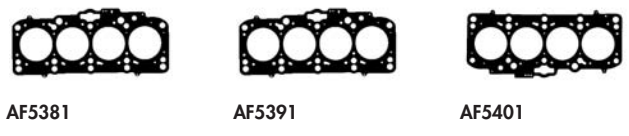







238

79.50
Diesel

AXB	4 Cyl.	18.5:1	1896cc	77kW (105)PS	Turbo Intercooled	TD16867	833
AXC	4 Cyl.	18.5:1	1896cc	63kW (85)PS	Turbo Intercooled	TD16881	833
BLT	4 Cyl.	19:1	1896cc	96kW (131)PS	Turbo Intercooled	TD17467	843
BLT	4 Cyl.	19:1	1896cc	96kW (131)PS	Turbo Intercooled	TD20516	843
BLT	4 Cyl.	19:1	1896cc	96kW (131)PS	Turbo Intercooled	TD20517	843
BTB	4 Cyl.		1896cc	110kW (150)PS	Turbo Intercooled	TD18232	845
BTB	4 Cyl.		1896cc	110kW (150)PS	Turbo Intercooled	TD20625	845

ALHAMBRA	05/05→05/07	CORDOBA	10/02→11/09	FABIA	06/03→03/08
IBIZA	02/02→11/09	MULTIVAN	04/03→11/09	POLO	11/03→11/09
SHARAN	06/05→03/10	TRANSPORTER	04/03→11/09		

					
TB680 120x30	TBK270	CAM672 [16] CAM914 [17] CAM928 [52]	KIT		FOL175 (x8)

[16] Chilled Cast Iron

[16] Schalenhartguss







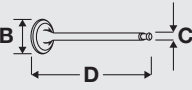
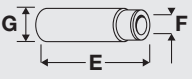

[17] Induction Hardened Cast Iron

[17] Induktionsgehärtetes Gusseisen

[52] Steel

[52] Stahl

	
B x C x D	E x F x G
V94147 ■ 35.90 x 7.00 x 89.90	VAG96041B ■ ■ ■ 36.50 x 7.00 x 12.08
V94148 ■ 31.50 x 7.00 x 90.00	
OE: 038 109 601B	
MAT.: MB	
45°	
H	
038 109 611B	
MG	
45°	
ss	
H	

							
AF5381 MLS, 1.490mm, 1 Hole AF5391 MLS, 1.530mm, 2 Holes AF5401 MLS, 1.650mm, 3 Holes	CC5230 ▲		HBS300 ⊕ M12x1.75x166mm (x10)	JD170 ■ JD600 ■	JM5203	HR816 ■	NA5124 32.00x47.00x10.00mm PTFE/ACM

AF5381

AF5391







AF5401

239

79.50
Diesel

AXR	4 Cyl.	19:1	1896cc	74kW (100)PS	Turbo Intercooled	TD16337	832
AXR	4 Cyl.	19:1	1896cc	74kW (100)PS	Turbo Intercooled	TD16416	832
AXR	4 Cyl.	19:1	1896cc	74kW (100)PS	Turbo Intercooled	TD18739	832
AXR	4 Cyl.	19:1	1896cc	74kW (100)PS	Turbo Intercooled	TD20195	832

A3	10/00→05/03	BORA	09/00→05/05	CORDOBA	09/02→11/09
FABIA	01/00→03/08	GOLF	09/00→06/06	IBIZA	02/02→11/09
LEON	10/05→06/06	NEW BEETLE	06/03→09/10	OCTAVIA	08/00→12/10
POLO	10/01→11/09	ROOMSTER	03/06→05/06		

					
TB680 120x30	TBK225 →02/02, without tensioner pulley damper TBK269 →02/02, with tensioner pulley damper TBK270 02/02→	CAM672 [16] CAM914 [17] CAM928 [52]			FOL175 (x8)

[16] Chilled Cast Iron

[16] Schalenhartguss







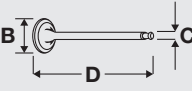
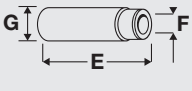

[17] Induction Hardened Cast Iron

[17] Induktionsgehärtetes Gusseisen

[52] Steel

[52] Stahl



		
B x C x D	OE	Ex F x G
V94649 ■	038 109 601E	VAG96041B ■ ■ ■
36.00 x 7.00 x 89.40		36.50 x 7.00 x 12.08
V94650 ■	038 109 611E	
31.40 x 7.00 x 89.00		







							
AF5381 MLS, 1.490mm, 1 Hole AF5391 MLS, 1.530mm, 2 Holes AF5401 MLS, 1.650mm, 3 Holes	CC5230 ▲		HBS300 ⊕ M12x1.75x166mm (x10)	JD170 ■ JD600 ■	JM5203	HR816 ■	NA5124 32.00x47.00x10.00mm PTFE/ACM









AF5381

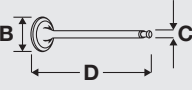



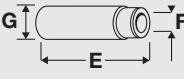



AF5391

AF5401

240	 79.50	Diesel	
AYQ	4 Cyl.	1896cc	47kW (64)PS
AYQ	4 Cyl.	1896cc	47kW (64)PS
CADDY	11/95→01/04	INCA	11/95→06/03



					
TB533 141x25 Eng.→50000 TB659 Eng.50001→	TBK107 Eng.→50000 TBK272 Eng.50001→	CAM670			FOL143 (x8)



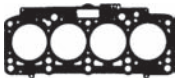





					
B x C x D	OE	MAT.	45°	Y	H
V94112 ■ 36.00 x 7.00 x 96.50	028 109 601J		45°		
V94113 ■ 31.50 x 7.00 x 96.30	028 109 611K		45°		
					VAG96041B ■ ■ ■ 36.50 x 7.00 x 12.08

							
BZ040 MLS, 1.470mm, 1 Hole BZ050 MLS, 1.570mm, 2 Holes BZ060 MLS, 1.670mm, 3 Holes			HBS018 ⊕ M12x1.75x115mm (x10)	JD170 ■ JD600 ■ JE5076		HR816 ■	NA5001 32.00x47.00x10.00mm FPM



BZ040, BZ050, BZ060

241	 79.50	Diesel	
BEQ	4 Cyl.	1896cc	33kW (45)PS
			TD20100 835

							
BZ040 MLS, 1.470mm, 1 Hole BZ050 MLS, 1.570mm, 2 Hole BZ060 MLS, 1.670mm, 3 Holes				JD170 ■		HR646 ■	

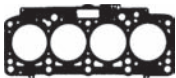

BZ040, BZ050, BZ060

242

 79.50

Diesel



BEU 4 Cyl. 1896cc 33kW (45)PS TD20101 836



BZ040 MLS, 1.470mm, 1 Hole
BZ050 MLS, 1.570mm, 2 Hole
BZ060 MLS, 1.670mm, 3 Holes

JD170 

HR646 



BZ040, BZ050, BZ060

243

 79.50

Diesel



BEW 4 Cyl. 19:1 1896cc 74kW (100)PS Turbo Intercooled TD19255 837

NEW BEETLE 02/01 →



TB680
120x30

TBK270

CAM672 [16]
CAM914 [17]
CAM928 [52]

FOL175 (x8)

[16] Chilled Cast Iron

[16] Schalenhartguss

[17] Induction Hardened Cast Iron

[17] Induktionsgehärtetes Gusseisen

[52] Steel

[52] Stahl

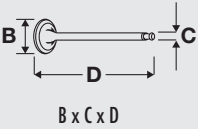

B x C x D

OE



MAT.



45°



H

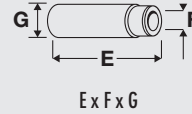

E x F x G

V95087 
35.50 x 6.98 x 88.80

038109601F



MB

V95088 
31.45 x 6.96 x 88.40

038109611G



MG



AF5381 MLS, 1.490mm, 1 Hole
AF5391 MLS, 1.530mm, 2 Holes
Ch.F1C-6-406 663 →
AF5401 MLS, 1.650mm, 3 Holes

CC5230 

HBS300 
M12x1.75x166mm (x10)

JD170 
JD600 

JM5203

HR816 

NA5124
32.00x47.00x10.00mm PTFE/ACM



AF5381

AF5391

AF5401

244	79.50	Diesel				
BGG	4 Cyl.	22.50:1	1896cc	47kW (64)PS	TD21349	838
PARATI	08/02→					

 B x C x D			 E x F x G			
OE	MAT.					
V94108	028 109 601B		45°	Y	H	VAG96041B 36.50 x 7.00 x 12.08
36.00 x 7.00 x 95.50						
V94727	028 109 601B		45°		H	
36.00 x 6.97 x 95.55						
V94109	028 109 611E		45°		H	
31.10 x 7.00 x 95.60						

BV850 MLS, 1.530mm, 1 Hole BV860 MLS, 1.570mm, 2 Holes BV870 MLS, 1.610mm, 3 Holes	DV851 ▲	HBS018 M12x1.75x115mm (x10)	JD170 JD606	HM5058	HR816	NA5124 32.00x47.00x10.00mm PTFE/ACM

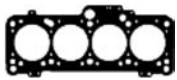

BV850, BV860, BV870

245	79.50	Diesel				
BGL	4 Cyl.	19:1	1896cc	37kW (50)PS	TD25870	838
					HR646	

246	79.50	Diesel				
BGM	4 Cyl.	19:1	1896cc	29kW (40)PS	TD25871	838
					HR646	



BJB	4 Cyl.	19:1	1896cc	77kW (105)PS	Turbo Intercooled	TD17078	839
BJB	4 Cyl.	19:1	1896cc	77kW (105)PS	Turbo Intercooled	TD17356	839
BJB	4 Cyl.	19:1	1896cc	77kW (105)PS	Turbo Intercooled	TD17499	839
BKC	4 Cyl.	19:1	1896cc	77kW (105)PS	Turbo Intercooled	TD17026	840
BKC	4 Cyl.	19:1	1896cc	77kW (105)PS	Turbo Intercooled	TD17079	840
BKC	4 Cyl.	19:1	1896cc	77kW (105)PS	Turbo Intercooled	TD17355	840
BKC	4 Cyl.	19:1	1896cc	77kW (105)PS	Turbo Intercooled	TD17497	840
BRU	4 Cyl.	19:1	1896cc	66kW (89)PS	Turbo Intercooled	TD17468	849
BXE	4 Cyl.	19:1	1896cc	77kW (105)PS	Turbo Intercooled	TD18908	840
BXE	4 Cyl.	19:1	1896cc	77kW (105)PS	Turbo Intercooled	TD19819	840
BXE	4 Cyl.	19:1	1896cc	77kW (105)PS	Turbo Intercooled	TD20513	840
BXE	4 Cyl.	19:1	1896cc	77kW (105)PS	Turbo Intercooled	TD22657	840
BXF	4 Cyl.	19:1	1896cc	66kW (89)PS	Turbo Intercooled	TD18907	840
BXF	4 Cyl.	19:1	1896cc	66kW (89)PS	Turbo Intercooled	TD20866	840

A3	05/03→05/10	ALTEA	04/04→	ALTEA XL	10/06→
CADDY	04/04→08/10	GOLF	10/03→	JETTA	08/05→10/10
LEON	07/05→	OCTAVIA	06/04→12/10	PASSAT	03/05→11/08
SUPERB	03/08→	TOLEDO	10/04→05/09	TOURAN	08/03→05/10

TB680 120x30	TBK270	CAM672 [16] CAM914 [17] CAM928 [52]	KIT	FOL175 (x8)

[16] Chilled Cast Iron

[16] Schalenhartguss

[17] Induction Hardened Cast Iron

[17] Induktionsgehärtetes Gusseisen

[52] Steel

[52] Stahl

V94649 ■ 36.00 x 7.00 x 89.40	V94650 ■ 31.40 x 7.00 x 89.00	VAG96041B ■ ■ ■ 36.50 x 7.00 x 12.08
038 109 601E	038 109 611E	
MAT.	MAT.	
45°	45°	
Y	ss	
H	H	

AF5381 MLS, 1.490mm, 1 Hole	CC5230 ▲	HBS300 ⊕ M12x1.75x166mm (x10)	JD170 ■ JD600 ■	JM5203	HR816 ■	NA5124 32.00x47.00x10.00mm PTFE/ACM
AF5391 MLS, 1.530mm, 2 Holes						
AF5401 MLS, 1.650mm, 3 Holes						

AF5381	AF5391	AF5401

248	79.50	Diesel					
BJC	4 Cyl.	19.5:1	1896cc	53kW (72)PS	TD22453	835	

BZ040 MLS, 1.470mm, 1 Hole					JD170 ■		
BZ050 MLS, 1.570mm, 2 Hole							
BZ060 MLS, 1.670mm, 3 Holes							



BZ040, BZ050, BZ060

[9] Centering Diameter [mm]: 8.5 [9] Zentrierdurchmessers [mm]: 8.5

249	79.50	Diesel				
BKE	4 Cyl.	1896cc	85kW (115)PS	Turbo Intercooled	TD17596	841
A4	06/04 → 06/08					

TB680 120x30	TBK225 →10/01, without tensioner pulley damper TBK269 →10/01, with tensioner pulley damper TBK270 10/01→				

B x C x D	OE	MAT.	45°	Y	H	E x F x G
V94649 ■ 36.00 x 7.00 x 89.40	038 109 601E	 MB	45°	Y	H	VAG96041B ■ ■ ■ 36.50 x 7.00 x 12.08
V94650 ■ 31.40 x 7.00 x 89.00	038 109 611E	 MG	45°	ss	H	

AF5381 MLS, 1.490mm, 1 Hole	CC5230 ▲		HBS300 ⊙ M12x1.75x166mm (x10)	JD170 ■ JD600 ■	JM5203	HR816 ■	NA5124 32.00x47.00x10.00mm PTFE/ACM
AF5391 MLS, 1.530mm, 2 Holes							
AF5401 MLS, 1.650mm, 3 Holes							

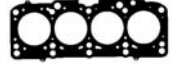

AF5381



AF5391



AF5401

VW GROUP

250		79.50		Diesel			
BLS	4 Cyl.	19:1	1896cc	77kW (105)PS	Turbo Intercooled	TD18224	842
BLS	4 Cyl.	19:1	1896cc	77kW (105)PS	Turbo Intercooled	TD18268	842
BLS	4 Cyl.	19:1	1896cc	77kW (105)PS	Turbo Intercooled	TD19091	842
BLS	4 Cyl.	19:1	1896cc	77kW (105)PS	Turbo Intercooled	TD20823	842
BMT	4 Cyl.		1896cc	74kW (100)PS	Turbo Intercooled	TD20494	840
BMT	4 Cyl.		1896cc	74kW (100)PS	Turbo Intercooled	TD20495	840
BXJ	4 Cyl.	19.5:1	1896cc	66kW (89)PS	Turbo Intercooled	TD20493	840
BXJ	4 Cyl.	19.5:1	1896cc	66kW (89)PS	Turbo Intercooled	TD20840	840

A3	05/03→	ALTEA	04/04→	ALTEA XL	10/06→
CADDY	04/04→08/10	CORDOBA	09/02→11/09	FABIA	04/07→
GOLF	10/03→	IBIZA	02/02→06/10	JETTA	08/05→10/10
LEON	07/05→	OCTAVIA	06/04→12/10	PASSAT	03/05→11/08
POLO	10/01→11/09	ROOMSTER	09/06→03/10	SUPERB	03/08→
TOLEDO	10/04→05/09	TOURAN	08/03→05/10		

TB680 120x30	TBK270	CAM904	KIT	FOL175 (x8)

V94649 ■ 36.00 x 7.00 x 89.40	V94650 ■ 31.40 x 7.00 x 89.00	VAG96041B ■ ■ ■ 36.50 x 7.00 x 12.08
OE: 038 109 601E	OE: 038 109 611E	
MAT. MB	MAT. MG	
45° Y H	45° ss H	

AF5381 MLS, 1.490mm, 1 Hole	AF5391 MLS, 1.530mm, 2 Holes	AF5401 MLS, 1.650mm, 3 Holes	HBS300 ⊕ M12x1.75x166mm (x10)	JD170 ■ JD5992 ■ [1] (Steel)	JM7107 (ACM)	HR816 ■	NA5124 32.00x47.00x10.00mm PTFE/ACM
AF5381	AF5391	AF5401					
[1] With Heat Shield	[1] Mit Hitzeschild						

251		82.50		Diesel			
BWW	4 Cyl.	1984cc	91kW (124)PS			TD20500	

AG9630 MLS, 1.450mm, 1 Holes	AG9640 MLS, 1.530mm, 2 Holes	AG9650 MLS, 1.610mm, 3 Hole	CC5231 ▲	JM5203	HR646 ■

252	79.50	Diesel						
BPX	4 Cyl.	19:1	1896cc	118kW (160)PS	Turbo Intercooled	TD17640	844	
IBIZA	03/04 → 02/08							

TB680 120x30	TBK270	CAM672 [16] CAM914 [17] CAM928 [52]		FOL175 (x8)

[16] Chilled Cast Iron
[17] Induction Hardened Cast Iron
[52] Steel

[16] Schalenhartguss
[17] Induktionsgehärtetes Gusseisen
[52] Stahl

V94147 ■ 35.90 x 7.00 x 89.90	V94148 ■ 31.50 x 7.00 x 90.00	VAG96041B ■ ■ ■ 36.50 x 7.00 x 12.08
OE: 038 109 601B MAT: MB	OE: 038 109 611B MAT: MG	
45°	45° ss	
H	H	

AF5381 MLS, 1.490mm, 1 Hole	AF5391 MLS, 1.530mm, 2 Holes	AF5401 MLS, 1.650mm, 3 Holes	CC5231 ▲	HBS300 ⊕ M12x1.75x166mm (x10)	JD170 ■ JD600 ■	JM5203	HR816 ■	NA5124 32.00x47.00x10.00mm PTFE/ACM
AF5381	AF5391	AF5401						

253	79.50	Diesel						
BPZ	4 Cyl.	19:1	1896cc	85kW (115)PS	Turbo Intercooled	TD20205	845	
BPZ	4 Cyl.	19:1	1896cc	85kW (115)PS	Turbo Intercooled	TD25766	845	

SUPERB 01/07 → 03/08

TB680 120x30	TBK270	CAM904	FOL175 (x8)

AF5381 MLS, 1.490mm, 1 Hole	AF5391 MLS, 1.530mm, 2 Holes	AF5401 MLS, 1.650mm, 3 Holes	CC5231 ▲	HBS300 ⊕ M12x1.75x166mm (x10)	JD170 ■ JD600 ■	JM5203	HR816 ■	NA5124 32.00x47.00x10.00mm PTFE/ACM
AF5381	AF5391	AF5401						

254

79.50

Diesel



BRB 4 Cyl. 19:1 1896cc 85kW (115)PS Turbo Intercooled TD20492 846

A4 11/04→06/08

TB680 120x30	TBK270				FOL114 (x8)

<p>V94649 ■ 038 109 601E 36.00 x 7.00 x 89.40</p> <p>V94650 ■ 038 109 611E 31.40 x 7.00 x 89.00</p>	<p>MAT.</p> <p>45° Y H</p> <p>45° ss H</p>

<p>AF5381 MLS, 1.490mm, 1 Hole</p> <p>AF5391 MLS, 1.530mm, 2 Holes</p> <p>AF5401 MLS, 1.650mm, 3 Holes</p>	CC5230 ▲	<p>HBS300 ⊕</p> <p>M12x1.75x166mm (x10)</p>	<p>JD170 ■</p> <p>JD600 ■</p>	JM5203	HR816 ■	<p>NA5124</p> <p>32.00x47.00x10.00mm PTFE/ACM</p>
AF5381	AF5391	AF5401				

255

79.50

Diesel



BRM 4 Cyl. 1896cc 74kW (100)PS TD20629 847

			<p>JD170 ■</p> <p>JD5992 ■ [1]</p> <p>(Steel)</p>	<p>JM7107</p> <p>(ACM)</p>	HR646 ■

[1] With Heat Shield

[1] Mit Hitzeschild

256	79.50	Diesel				
BRR	4 Cyl.	1896cc	62kW (84)PS	Turbo Intercooled	TD20159	848
BRS	4 Cyl.	1896cc	75kW (102)PS	Turbo Intercooled	TD18994	848
MULTIVAN	01/06→11/09	TRANSPORTER	01/06→11/09			

TB680 120x30	TBK270	CAM904	FOL175 (x8)

B x C x D	E x F x G
V94649 ■ 36.00 x 7.00 x 89.40	V94650 ■ 31.40 x 7.00 x 89.00
OE: 038 109 601E	OE: 038 109 611E
MAT. MB	MAT. MG
45° Y H	45° ss H

AF5381 MLS, 1.490mm, 1 Hole	AF5391 MLS, 1.530mm, 2 Holes	AF5401 MLS, 1.650mm, 3 Holes	HBS300 ⊕ M12x1.75x166mm (x10)	JD170 ■ JD600 ■	JM7113 (Elastomer)	HR816 ■	NA5124 32.00x47.00x10.00mm PTFE/ACM
AF5381	AF5391	AF5401					

257	79.50	Diesel				
BSU	4 Cyl.	1896cc	55kW (75)PS	Turbo Intercooled	TD18755	849
CADDY	09/05→08/10					

TB680 120x30	TBK270	CAM904	FOL175 (x8)

B x C x D	E x F x G
V94649 ■ 36.00 x 7.00 x 89.40	V94650 ■ 31.40 x 7.00 x 89.00
OE: 038 109 601E	OE: 038 109 611E
MAT. MB	MAT. MG
45° Y H	45° ss H

AF5381 MLS, 1.490mm, 1 Hole	AF5391 MLS, 1.530mm, 2 Holes	AF5401 MLS, 1.650mm, 3 Holes	HBS300 ⊕ M12x1.75x166mm (x10)	JD170 ■ JD5992 ■ [1]	JM7107 (ACM)	HR816 ■	NA5124 32.00x47.00x10.00mm PTFE/ACM
AF5381	AF5391	AF5401					

[1] With Heat Shield [1] Mit Hitzeschild



BSV 4 Cyl. 1896cc 77kW (105)PS Turbo Intercooled TD20206 845

SUPERB 10/05→05/07

TB680 120x30	TBK270	CAM904			FOL175 (x8)

V94649 ■ 36.00 x 7.00 x 89.40	038 109 601E		45°	Y	H	VAG96041B ■ ■ ■ 36.50 x 7.00 x 12.08
V94650 ■ 31.40 x 7.00 x 89.00	038 109 611E		45°	ss	H	

AF5381 MLS, 1.490mm, 1 Hole AF5391 MLS, 1.530mm, 2 Holes AF5401 MLS, 1.650mm, 3 Holes	CC5231 ▲	HBS300 ⊕ M12x1.75x166mm (x10)	JD170 ■ JD600 ■	JM5203	HR816 ■	NA5124 32.00x47.00x10.00mm PTFE/ACM
AF5381	AF5391	AF5401				

259

79.50

Diesel



BSW	4 Cyl.	18.5:1	1896cc	77kW (105)PS	Turbo Intercooled	TD18771	849
BSW	4 Cyl.	18.5:1	1896cc	77kW (105)PS	Turbo Intercooled	TD20004	849

FABIA	04/07→	NEW BEETLE	07/05→	ROOMSTER	09/06→03/10
--------------	--------	-------------------	--------	-----------------	-------------

TB680 120x30	TBK270	CAM672 [16] CAM914 [17] CAM928 [52]		FOL175 (x8)

[16] Chilled Cast Iron

[16] Schalenhartguss

[17] Induction Hardened Cast Iron

[17] Induktionsgehärtetes Gusseisen

[52] Steel

[52] Stahl

V94147 ■ 35.90 x 7.00 x 89.90	V94650 ■ 31.40 x 7.00 x 89.00	VAG96041B ■ ■ ■ 36.50 x 7.00 x 12.08
OE: 038 109 601B	MAT: MB, MG	
	45°	
	45° ss	
	H	H

AF5381 MLS, 1.490mm, 1 Hole AF5391 MLS, 1.530mm, 2 Holes AF5401 MLS, 1.650mm, 3 Holes	CC5230 ▲	HBS300 ⊕ M12x1.75x166mm (x10)	JD170 ■ JD600 ■	JM5203	HR816 ■	NA5124 32.00x47.00x10.00mm PTFE/ACM



AF5381



AF5391

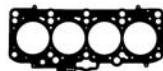

AF5401

260

79.50

Diesel



BUK 4 Cyl. 19:1 1896cc 118kW (160)PS Turbo Intercooled TD22667 850

IBIZA 03/04 → 02/08



TB680 120x30		CAM672 [16] CAM914 [17] CAM928 [52]			FOL175 (x8)





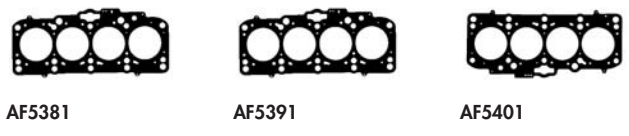

[16] Chilled Cast Iron [16] Schalenhartguss
 [17] Induction Hardened Cast Iron [17] Induktionsgehärtetes Gusseisen
 [52] Steel [52] Stahl







B x C x D	OE	MAT.			E x F x G
V94147 ■ 35.90 x 7.00 x 89.90	038 109 601B	 MB	45°	H	VAG96041B ■ ■ ■ ■ 36.50 x 7.00 x 12.08
V94148 ■ 31.50 x 7.00 x 90.00	038 109 611B	 MG	45° ss	H	



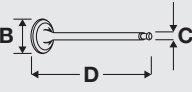







AF5381 MLS, 1.490mm, 1 Hole AF5391 MLS, 1.530mm, 2 Holes AF5401 MLS, 1.650mm, 3 Holes	CC5231 ▲		HB5300 ◎ M12x1.75x166mm (x10)	JD170 ■ JD600 ■	JM5203	HR816 ■	NA5124 32.00x47.00x10.00mm PTFE/ACM











261	 79.50	Diesel					
BVK	4 Cyl.	18:1	1896cc	85kW (115)PS	Turbo Intercooled	TD20489	851
BVK	4 Cyl.	18:1	1896cc	85kW (115)PS	Turbo Intercooled	TD20515	851
ALHAMBRA	06/00→03/10	SHARAN		04/00→03/10			









					
TB680 120x30	TBK270	CAM904	KIT		FOL175 (x8)

					
B x C x D	OE	MAT.			E x F x G
V94147 ■ 35.90 x 7.00 x 89.90	038 109 601B	 MB	45°	H	VAG96041B ■ ■ ■ 36.50 x 7.00 x 12.08
V94148 ■ 31.50 x 7.00 x 90.00	038 109 611B	 MG	45°	ss	H

						
AF5381 MLS, 1.490mm, 1 Hole AF5391 MLS, 1.530mm, 2 Holes AF5401 MLS, 1.650mm, 3 Holes	CC5231 ▲	HBS300 ⊕ M12x1.75x166mm (x10)	JD170 ■ JC152 ■ (x4)	JM5203	HR816 ■	NA5124 32.00x47.00x10.00mm PTFE/ACM
						
AF5381	AF5391	AF5401				

262	 79.50	Diesel				
BXT	4 Cyl.	19:1	1896cc	30kW (41)PS	TD25869	838
						
BZ040 MLS, 1.470mm, 1 Hole BZ050 MLS, 1.570mm, 2 Hole BZ060 MLS, 1.670mm, 3 Holes			JD170 ■	HR646 ■		
						
BZ040, BZ050, BZ060						

263	 79.50	Diesel				
CDXA	4 Cyl.	23:1	1896cc	55kW (75)PS	TD23291	838
						
					HR646 ■	

264	 79.50	Diesel				
CDXB	4 Cyl.	23:1	1896cc	29kW (40)PS	TD23292	838
						
					HR646 ■	

VW GROUP

265

79.50

Petrol



WH 5 Cyl. 10:1 1921cc 74kW (100)PS TD336 852

100 08/80 → 07/84

TB602 113x19				FOL91 (x10)	

B x C x D	OE	MAT.	45°	H	E x F x G
V91034	035 109 601C		45°	H	VAG92061B
38.10 x 7.97 x 99.06		MB			36.70 x 8.00 x 12.08
V91030	035 109 611F		45° ss	H	VAG92105B
33.30 x 7.95 x 98.60		MG			42.30 x 7.99 x 12.08

BD620 Fibre Composite	DD621		HBS024 M11x1.50x95mm (x12)	JC261 JC152 (x5) JE689	JN438 (Elastomer) HL460 (Cork) HM5277 (Elastomer)	HR615	NA5001 32.00x47.00x10.00mm FPM



BD620

266

79.50

Petrol



WK 5 Cyl. 9.3:1 2144cc 100kW (136)PS TD338 854

				JC261			

267

79.50

Diesel



GH 4 Cyl. 1919cc 82kW (111)PS TD3588



BG870 Fibre Composite	DG871			JC478 JC152 (x4)	HL456 (Cork) HL457 [9] (Cork)		













BG870





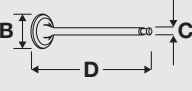
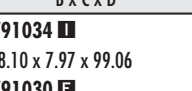

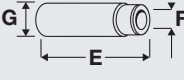
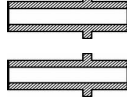

[9] Centering Diameter [mm]: 8.5

[9] Zentrierdurchmessers [mm]: 8.5

268	 79.50	Petrol			
WN	5 Cyl.	9.5/10:1	1921cc	85kW (115)PS	TD339 853
WN	5 Cyl.	9.5/10:1	1921cc	85kW (115)PS	TD5031 853
80	09/81→07/83	COUPE		08/80→07/83	PASSAT 01/81→07/83
SANTANA	08/81→07/83				

					
TB207 120x18 08/84→	TBK048 08/84→				FOL91 (x10)
TB602 113x19 →07/84					



						
V91034 ■ 38.10 x 7.97 x 99.06	V91030 ■ 33.30 x 7.95 x 98.60	MAT. MB MG	45°	H	VAG92061B ■ ■ ■ 36.70 x 8.00 x 12.08	VAG92105B ■ ■ ■ 42.30 x 7.99 x 12.08
OE: 035 109 601C	OE: 035 109 611F		45° ss	H		

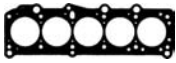





							
BD620 Fibre Composite	DD621	HBS024 ⊕ M11x1.50x95mm (x12)	JC261 ■ JC152 ■ (x5) JE689	JN438 (Elastomer) HL460 ■ (Cork) HM5277 ■ (Elastomer)	HR615 ■	NA5001 32.00x47.00x10.00mm FPM	















BD620

VW GROUP



269	 79.50	Petrol	
GV	5 Cyl.	2144cc	147kW (200)PS
			Turbo
			TD261 854
QUATTRO	07/80 → 07/87		













					
TB207 120x18 85E900001 → 85J900643					
TB318 142x19 85J900644 →					
TB602 113x19 → 85D902500					

							
BD620 Fibre Composite	DD622			JC261  JC152  (x5)	JN438 (Elastomer) HL460  (Cork) 08/80 → HM5277  (Elastomer) 08/80 →	HR615 	NA5001 32.00x47.00x10.00mm FPM



BD620

270	 79.50	Petrol	
JY	5 Cyl.	2144cc	134kW (182)PS
WX	5 Cyl.	2144cc	119kW (162)PS
			Turbo
			TD280 854
200	09/83 → 01/88	QUATTRO	02/82 → 07/89

							
BD620 Fibre Composite	DD622		HBS030	JC261  JC152  (x5)	JN438 (Elastomer) HL460  (Cork) 08/80 → HM5277  (Elastomer) 08/80 →	HR615 	NA5001 32.00x47.00x10.00mm FPM



BD620

271







 **79.50**







Petrol



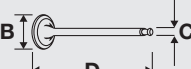



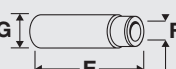

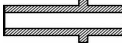
KE 5 Cyl. 2144cc **96kW (131)PS** **TD281** **855**

COUPE 09/82→08/84

					
TB207 120x18 85-E-000 001 → TB602 113x19 →85-D-250 000	TBK048 85-E-000 001 →				FOL91 (x10)

							
V91034 ■ 38.10 x 7.97 x 99.06	OE 035 109 601C	MAT. MB	45°		H	VAG92061B ■ ■ ■ 36.70 x 8.00 x 12.08	
V91030 ■ 33.30 x 7.95 x 98.60	035 109 611F	MG	45°	ss	H	VAG92105B ■ ■ ■ 42.30 x 7.99 x 12.08	

						
BD620 Fibre Composite	DD621	HBS024 ⊕ M11x1.50x95mm (x12)	JC261 ■ JC152 ■ (x5) ■ JE689	JN438 (Elastomer) HL460 ■ (Cork) HM5277 ■ (Elastomer)	HR615 ■	NA5001 32.00x47.00x10.00mm FPM



BD620

272



79.50

Petrol



KF	5 Cyl.	2144cc	96kW (131)PS	TD282	855
WU	5 Cyl.	2144cc	79kW (107)PS	TD344	855

100 08/82→07/84

TB207 120x18 44-E-000001 →					
TB602 113x19 →44-D-200000					

BD620 Fibre Composite	DD620 DD621		HBS030	JC152 (x5) JE689 JC260	JN438 (Elastomer) HL460 (Cork) HM5277 (Elastomer)	HR615	



BD620

273	79.50	Petrol	
KG	5 Cyl.	2144cc	134kW (182)PS
			Turbo Intercooled
			TD283 856
200	08/83→01/88		

TB207 120x18 07/87→	TBK048 07/87→				FOL91 (x10)
TB602 113x19 →07/87					

V91034 ■ 38.10 x 7.97 x 99.06	V91030 ■ 33.30 x 7.95 x 98.60	VAG92061B ■ ■ ■ 36.70 x 8.00 x 12.08	VAG92105B ■ ■ ■ 42.30 x 7.99 x 12.08
B x C x D	OE	MAT.	Ex F x G
	035 109 601C	45°	
	035 109 611F	45° ss	

BD620 Fibre Composite	DD622	HBS024 ⊕ M11x1.50x95mm (x12)	JC261 ■ JC152 ■ (x5)	JN438 (Elastomer) HL460 ■ (Cork) 08/80→ HM5277 ■ (Elastomer) 08/80→	HR615 ■	NA5001 32.00x47.00x10.00mm FPM			



BD620

274	79.50	Petrol	
KH	5 Cyl.	10:1	2144cc
			100kW (136)PS
			TD284 854

BD620 Fibre Composite	DD622	JC261 ■ JC152 ■ (x4)	JN438 (Elastomer) HL460 ■ (Cork) HM5277 ■ (Elastomer)	HR615 ■	NA5001 32.00x47.00x10.00mm FPM NB446			

VW GROUP

275







 79.50





Petrol





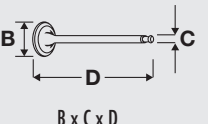

KK 5 Cyl. 2144cc 100kW (136)PS TD286 855

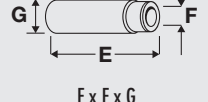



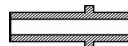

80 08/82→07/84

					
					FOL91 (x10)

					
B x C x D	OE	MAT.			E x F x G

V91034  38.10 x 7.97 x 99.06	035 109 601C	 MB	45°	H	VAG92061B  36.70 x 8.00 x 12.08
V91030  33.30 x 7.95 x 98.60	035 109 611F	 MG	45° ss	H	VAG92105B  42.30 x 7.99 x 12.08

							
---	---	---	---	---	--	---	---

BD620 Fibre Composite	DD621		HBS024  M11x1.50x95mm (x12)	JC261  JC152  (x5)  JE689	JN438 (Elastomer) HL460  (Cork) HM5277  (Elastomer)	HR615 	NA5001 32.00x47.00x10.00mm FPM
-----------------------	-------	--	--	--	---	--	--



BD620









276





 79.50

Petrol



KJ 5 Cyl. 2144cc 125kW (170)PS TD285 857

							
---	---	---	---	---	--	---	---

BD620 Fibre Composite	DD622			JC261  JC152  (x4)	JN438 (Elastomer) HL460  (Cork) 08/80→ HM5277  (Elastomer) 08/80→	HR615 	NA5001 32.00x47.00x10.00mm FPM NB446
-----------------------	-------	--	--	---	---	--	--







277







 **79.50**



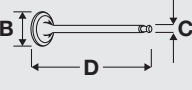



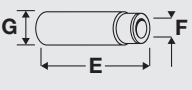

Petrol



KL	5 Cyl.	2144cc	96kW (131)PS	TD288	855
80	08/82→07/84	COUPE	09/82→08/84		

					
TB207 120x18 85-D-250001→	TBK048 85-D-250001→				FOL91 (x10)
TB602 113x19 →85-D-250000					

						
V91034 ■ 38.10 x 7.97 x 99.06	V91030 ■ 33.30 x 7.95 x 98.60	MAT. MB MG	45°	ss	H	VAG92061B ■ ■ ■ ■ ■ 36.70 x 8.00 x 12.08
OE: 035 109 601C	OE: 035 109 611F					

							
BD620 Fibre Composite	DD621	HBS024 ⊕ M11x1.50x95mm (x12)	JC261 ■ JC152 ■ (x5) JE689	JN438 (Elastomer) HL460 ■ (Cork) HM5277 ■ (Elastomer)	HR615 ■	NA5001 32.00x47.00x10.00mm FPM	



BD620

278







 79.50







Petrol



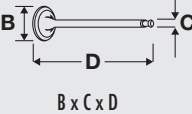



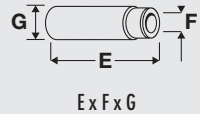



WB 5 Cyl. 8.2:1 2144cc 85kW (115)PS TD330 858

100 07/77→02/83

					
TB602 113x19				FOL91 (x10)	

				
B x C x D	OE	MAT.	45°	E x F x G
V91034 ■ 38.10 x 7.97 x 99.06	035 109 601C		45°	VAG92061B ■ ■ ■ 36.70 x 8.00 x 12.08
V91030 ■ 33.30 x 7.95 x 98.60	035 109 611F		45° ss	VAG92105B ■ ■ ■ 42.30 x 7.99 x 12.08

							
BD620 Fibre Composite	DD621		HBS024 Ⓞ M11x1.50x95mm (x12)	JC261 ■ JC152 ■ (x5) Ⓞ JE689	JN438 (Elastomer) HL460 ■ (Cork) HM5277 ■ (Elastomer)	HR615 ■	NA5001 32.00x47.00x10.00mm FPM



BD620

279	79.50	Petrol			
WC	5 Cyl.	9.3:1	2144cc	100kW (136)PS	TD331 859
100	03/77→07/84		200	10/79→07/84	

	.KIT		KIT		
TB602 113x19					FOL91 (x10)

B x C x D	OE				E x F x G
V91034 38.10 x 7.97 x 99.06	035 109 601C		45°	H	VAG92061B 36.70 x 8.00 x 12.08
V91030 33.30 x 7.95 x 98.60	035 109 611F		45° ss	H	VAG92105B 42.30 x 7.99 x 12.08

BD620 Fibre Composite	DD620 →Eng.139 411 DD621 Eng.139 412→	HBS024 M11x1.50x95mm (x12) Eng.139 412→	JC261 08/80→ JC152 (x5) JE689 Eng.139 412→	JN438 (Elastomer) Eng.139 412→ HM5277 (Elastomer) HL460 (Cork) Eng.139 412→	HR615	NA5001 32.00x47.00x10.00mm FPM



BD620

280	79.50	Petrol			
WE	5 Cyl.	2144cc	85kW (115)PS	TD16427	861
WE	5 Cyl.	2144cc	85kW (115)PS	TD333	861

100	07/77→02/83	80	10/80→07/83	COUPE	01/81→07/83
PASSAT	01/81→07/83	SANTANA	08/82→12/83		

	.KIT		KIT		
TB207 120x18 85E000001→ TB602 113x19 →85D250000	TBK048 85E000001→				

BD620 Fibre Composite	DD621	HBS024 M11x1.50x95mm (x12)	JC261 JC152 (x5) JE689	JN438 (Elastomer) HL460 (Cork) HM5277 (Elastomer)	HR615	NA5001 (x2) 32.00x47.00x10.00mm FPM



BD620

281

79.50

Petrol



WG 5 Cyl. 2144cc 100kW (136)PS TD335 862

100 03/77→02/83

TB602 113x19							
BD620 Fibre Composite	DD620		HBS024 M11x1.50x95mm (x12)	JC261 JC152 (x5)		HR615	NA5001 32.00x47.00x10.00mm FPM



BD620

282

79.50

Petrol



WJ 5 Cyl. 7.1:1 2144cc 125kW (170)PS Turbo TD337 863

200 10/79→08/82

TB207 120x18 44E012001→	TBK048 44E012001→				FOL91 (x10)
TB602 113x19 →44E012000					

B x C x D	OE	MAT.			E x F x G
V91034 38.10 x 7.97 x 99.06	035 109 601C	 MB	45°	H	VAG92061B E 36.70 x 8.00 x 12.08
V91030 33.30 x 7.95 x 98.60	035 109 611F	 MG	45° ss	H	VAG92105B E 42.30 x 7.99 x 12.08

BD620 Fibre Composite	DD622		HBS024 M11x1.50x95mm (x12) Ch.438 000 001→ HBS030 →Ch.438 020 000	JC261 JC152 (x5)	JN438 (Elastomer) Ch.438 000 001→ HL460 (Cork) 08/80→ Ch.438 000 001→ HM5277 (Elastomer) 08/80→ Ch.438 000 001→	HR615	NA5001 32.00x47.00x10.00mm FPM



BD620

283	79.50	Petrol					
WR	5 Cyl.	7.1:1	2144cc	147kW (200)PS	Turbo Intercooled	TD341	856
QUATTRO 07/80→07/87							

TB207 120x18 85-E-000 001→85-J-900 643	TB318 142x19 85-J-900 644→	TB602 113x19 →85-D-250 000			

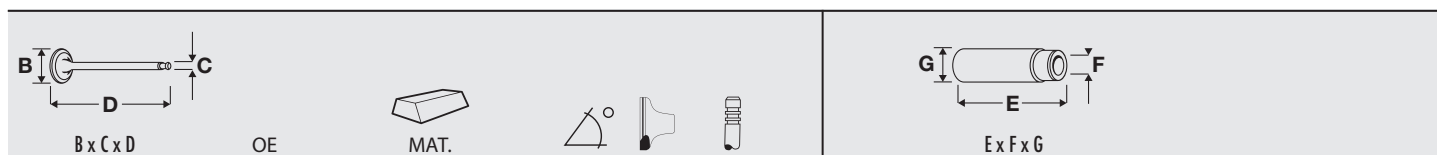

OE MAT.

VAG92105B
42.30 x 7.99 x 12.08

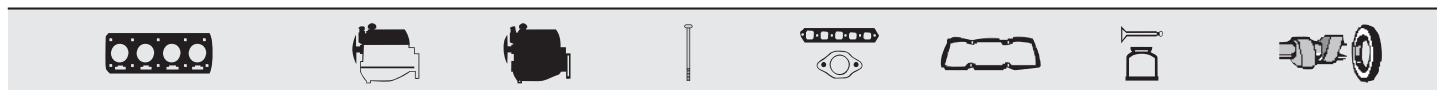

BD620 Fibre Composite	DD622		HBS024 M11x1.50x95mm (x12) Ch.85-B-900 159→ HBS030 →Ch.85-B-900 158	JC261 JC152 (x5)	JN438 (Elastomer) Ch.85-B-900 159→ HL460 (Cork) 08/80→ Ch.85-B-900 159→ HM5277 (Elastomer) 08/80→ Ch.85-B-900 159→	HR615	NA5001 32.00x47.00x10.00mm FPM
------------------------------	--------------	--	---	-----------------------------------	--	--------------	--



BD620

284	79.50	Petrol			
WS	5 Cyl.	2144cc	125kW (170)PS	TD342	864

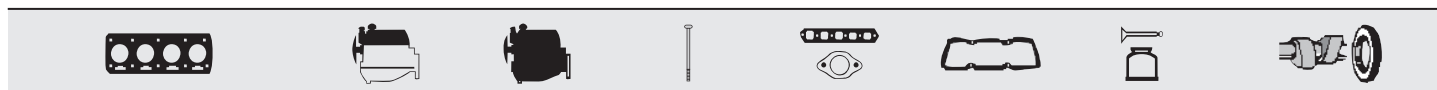

BD620 Fibre Composite	DD622			JC261 JC152 (x5)	JN438 (Elastomer) HL460 (Cork) 08/80→ HM5277 (Elastomer) 08/80→	HR615	NA5001 32.00x47.00x10.00mm FPM NB446
------------------------------	--------------	--	--	-----------------------------------	---	--------------	--

285







 79.50











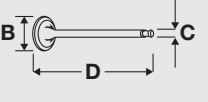

Diesel

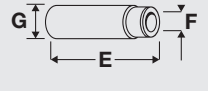









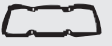

3D 5 Cyl. 2370cc 60kW (81)PS TD218 **865**

100 08/89→07/91

					
TB293 77x21 Driven unit: injection pump		CAM630			FOL92 (x10)
TB785 122x26.5					

					
B x C x D	OE	MAT.	45°	H	E x F x G
V91337 	069 109 601F		45°	H	VAG92061B 
36.10 x 7.97 x 95.10		MB			36.70 x 8.00 x 12.08
V94547 	046 109 601J		45°	ss	
35.95 x 8.00 x 96.85		MD			
V91334 	074 109 611		45°	ss	H
31.30 x 7.95 x 95.10		ME			

							
AF5340 MLS, 1.530mm, 1 Hole	DW830 ▲	HBS021 ⊕		JD312 	JN915	HR615 	NA5001
AF5350 MLS, 1.570mm, 2 Holes		M12x1.75x115mm (x12)		JC152  (x5)			32.00x47.00x10.00mm FPM
AF5360 MLS, 1.610mm, 3 Holes				 JE138 [61]			

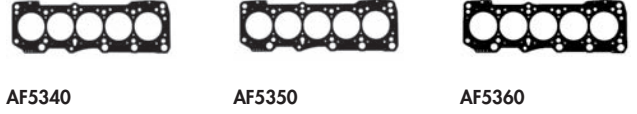

AF5340 **AF5350** **AF5360**

[61] To cylinder 4 - 6 [61] zum Zylinder 4 - 6

286

79.50

Diesel



AAB 5 Cyl. 22.5:1 2370cc 57kW (77)PS TD4000 865

TRANSPORTER 07/90→09/98

TB293 77x21 Driven unit: injection pump TB785 122x26.5	CAM630	FOL92 (x10)

B x C x D OE MAT. 45° H 45° ss H	E x F x G VAG92061B 36.70 x 8.00 x 12.08
V91337 36.10 x 7.97 x 95.10 V91334 31.30 x 7.95 x 95.10	

AF5340 MLS, 1.530mm, 1 Hole AF5350 MLS, 1.570mm, 2 Holes AF5360 MLS, 1.610mm, 3 Holes	DW830 ▲ →Ch.70-R-160000 CA5470 ▲ [14] Ch.70-R-160001→	HBS021 M12x1.75x115mm (x12)	JD312 JC152 (x5) JE160	JN915	HR615	NA5001 32.00x47.00x10.00mm FPM

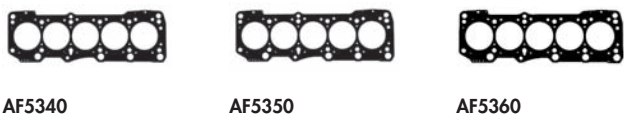

[14] With shaft oil seal [14] Mit Wellendichtring



AAS 5 Cyl. 2370cc 60kW (81)PS TD227 865

100 12/90 → 06/94

TB293 77x21 Driven unit: injection pump TB375 124x26.5		CAM630			FOL92 (x10)



B x C x D	OE	MAT.	E x F x G
V91337 ■ 36.10 x 7.97 x 95.10	069 109 601F	 MB	VAG92061B ■ ■ ■ 36.70 x 8.00 x 12.08
V94547 ■ 35.95 x 8.00 x 96.85	046 109 601J	 MD	
V91334 ■ 31.30 x 7.95 x 95.10	074 109 611	 ME	







AF5340 MLS, 1.530mm, 1 Hole	DW830 ▲		HBS021 ⊕ M12x1.75x115mm (x12)	JD312 ■ JC152 ■ (x5) ⊕ JE138 [61]	JN915	HR615 ■	NA5001 32.00x47.00x10.00mm FPM
AF5350 MLS, 1.570mm, 2 Holes							
AF5360 MLS, 1.610mm, 3 Holes							











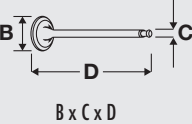

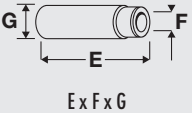







AF5340 **AF5350** **AF5360**

[61] To cylinder 4 - 6 [61] zum Zylinder 4 - 6



288	 79.50	Diesel	
AJA	5 Cyl.	2370cc	55kW (75)PS
TRANSPORTER			08/97→04/03
			TD11049 865





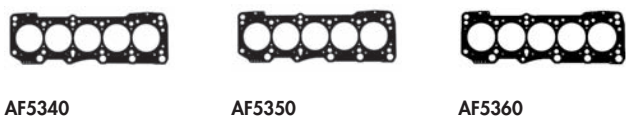





					
TB293 77x21 Driven unit: injection pump		CAM630			FOL92 (x10)
TB785 122x26.5					

		
B x C x D	OE	Ex F x G
V91337 	069 109 601F	VAG92061B 
36.10 x 7.97 x 95.10		36.70 x 8.00 x 12.08
V91334 	074 109 611	
31.30 x 7.95 x 95.10		

							
AF5340 MLS, 1.530mm, 1 Hole			HBS021 	JD312 		HR615 	NA5001
AF5350 MLS, 1.570mm, 2 Holes			M12x1.75x115mm (x12)	JC152 	(x5)		32.00x47.00x10.00mm FPM
AF5360 MLS, 1.610mm, 3 Holes							



289	 81.00	Petrol	
262	4 Cyl.	1781cc	50kW (68)PS
			TD22608

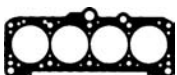

							
BM360 Fibre Composite				JC478 	HL457 	[9]	
				JC152 	(x4)	(Cork)	













BM360

[9] Centering Diameter [mm]: 8.5

[9] Zentrierdurchmessers [mm]: 8.5

290	 79.50	Diesel	
28B	4 Cyl.	22.5:1	1896cc
			48kW (65)PS
			TD22609

							
BV850 MLS, 1.530mm, 1 Hole	DV850 			JD170 			
BV860 MLS, 1.570mm, 2 Holes				JC152 	(x4)		
BV870 MLS, 1.610mm, 3 Holes							

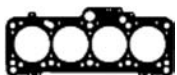

BV850, BV860, BV870

291	79.50	Petrol			
496	4 Cyl.	8:1	1588cc	48kW (65)PS	TD22610 795

				JC478	(Cork) HL457		
				JC152 (x4)			

292	81.00	Petrol			
AFT	4 Cyl.	10.3:1	1595cc	74kW (100)PS	TD4988 872
AFT	4 Cyl.	10.3:1	1595cc	74kW (100)PS	TD5536 872
AKS	4 Cyl.		1588cc	74kW (100)PS	TD9991 866

CORDOBA	07/96→10/99	GOLF	07/94→06/02	IBIZA	04/96→08/99
PASSAT	07/94→08/96	POLO	12/95→09/01	TOLEDO	11/96→03/99
VENTO	10/94→09/98				

TB463	TBK086	CAM913	KIT		FOL143 (x8)
121x18					

B x C x D	OE	MAT.	45°	H	E x F x G
V94079	078 109 601B		45°	H	VAG96041B
39.40 x 7.00 x 92.10		MB			36.50 x 7.00 x 12.08
V94080	048 109 611B		45°	H	
32.80 x 7.00 x 91.20		MG			

AY940 MLS	CY941 [14]		HBS043	JD599	JP024	HR816	NA5001
			M11x1.50x95mm (x10)	JD600			32.00x47.00x10.00mm FPM

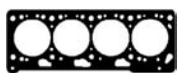

AY940

[14] With shaft oil seal

[14] Mit Wellendichtring

293







 81.00









Petrol

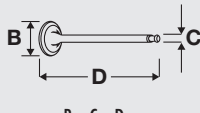



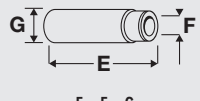

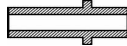











TF	4 Cyl.	9.5:1	1595cc	53/55kW (72/75)PS	TD4890	867
TF	4 Cyl.	9.5:1	1595cc	53/55kW (72/75)PS	TD4957	867

CADDY	11/95→05/97	CORDOBA	05/94→06/99	IBIZA	09/94→06/99
INCA	11/95→05/98	PASSAT	02/88→09/91	POLO	11/95→09/97
TOLEDO	05/91→03/99				

					
TB108 121x18	TBK016				FOL143 (x8)

					
B x C x D	OE	MAT.	45°	H	E x F x G
V91338  38.10 x 7.97 x 91.90	035 109 601K		45°		VAG92061B  36.70 x 8.00 x 12.08
V91340  33.30 x 7.95 x 91.20	053 109 611		45°	H	

							
BM360 Fibre Composite	DM368 [14]	HBS043  M11x1.50x95mm (x10)	JC478  PA459  (NBR) JC152  (x4) 	HL457  [9] (Cork) HM5053  [10] (ACM) HM5062 	HR569 	NA5001 32.00x47.00x10.00mm FPM	

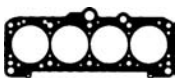

BM360

[9] Centering Diameter [mm]: 8.5
[10] Centering Diameter [mm]: 6.5
[14] With shaft oil seal

[9] Zentrierdurchmessers [mm]: 8.5
[10] Zentrierdurchmesser [mm]: 6.5
[14] Mit Wellendichtring

294



81.00

Petrol



ABB 4 Cyl. 10:1 1595cc 75kW (102)PS TD230 868

80 08/90 → 10/91

TB108 121x18	TBK016		KIT		FOL92 (x8)

B x C x D	E x F x G
V91407 ■ 39.60 x 7.97 x 91.90	VAG92061B ■ ■ ■ 36.70 x 8.00 x 12.08
OE 048 109 601A	
MAT. MD	
45°	
V91340 ■ 33.30 x 7.95 x 91.20	
OE 048 109 611A	
MAT. MG	
45°	H

BM360 Fibre Composite	DM361		HBS043 ⊕ M11x1.50x95mm (x10)	JC478 ■ JC152 ■ (x4) ⊕ JE689	JP024 Ch.8C-P-185 001 → HL457 ■ [9] (Cork) → Ch.8C-P-185 000 HM5053 ■ [10] (ACM) → Ch.8C-P-185 000	HR569 ■	NA5001 32.00x47.00x10.00mm FPM

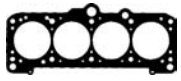

BM360

[9] Centering Diameter [mm]: 8.5
[10] Centering Diameter [mm]: 6.5

[9] Zentrierdurchmessers [mm]: 8.5
[10] Zentrierdurchmessers [mm]: 6.5

295







 **81.00**







Petrol



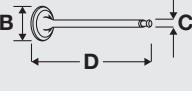



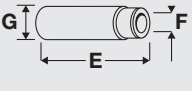



ABM 4 Cyl. 1595cc 52kW (71)PS **TD234** **867**

80 09/91 → 12/94

					
TB108 121x18	TBK016				FOL92 (x8)

					
V91338 ■ 38.10 x 7.97 x 91.90	035 109 601K		45°		VAG92061B ■ ■ ■ 36.70 x 8.00 x 12.08
V91340 ■ 33.30 x 7.95 x 91.20	048 109 611A		45°	H	

						
BM360 Fibre Composite	DM361 →Ch.8C-P-185 000 DM367 Ch.8C-P-185 001 →	HBS043 ⊕ M11x1.50x95mm (x10)	JC478 ■ PA459 ■ (NBR) JC152 ■ (x4) 	JP024 Ch.8C-P-185 001 → HL457 ■ [9] (Cork) →Ch.8C-P-185 000	HR569 ■	NA5001 32.00x47.00x10.00mm FPM

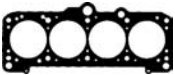

BM360

[9] Centering Diameter [mm]: 8.5

[9] Zentrierdurchmessers [mm]: 8.5

296

81.00

Petrol



ABN	4 Cyl.	9:1	1595cc	55kW (75)PS	TD17897	867
ABN	4 Cyl.	9:1	1595cc	55kW (75)PS	TD4974	867
GU	4 Cyl.	9/10:1	1781cc	66kW (89)PS	TD5007	930
RP	4 Cyl.	9:1	1781cc	66kW (89)PS	TD3596	943
RP	4 Cyl.	9:1	1781cc	66kW (89)PS	TD5027	943

GOLF	08/83 → 07/92	JETTA	01/84 → 07/92	PASSAT	02/88 → 05/97
TOLEDO	05/91 → 03/99				

TB108 121x18	TBK016				FOL92 (x8)

V91338 ■ 38.10 x 7.97 x 91.90	V91340 ■ 33.30 x 7.95 x 91.20	OE 035 109 601K	MAT. MD MG	45°	H	VAG92061B ■ ■ ■ 36.70 x 8.00 x 12.08

BM360 Fibre Composite	DM368 [14]	HBS043 ⊕ M11x1.50x95mm (x10)	JC478 ■ PA459 ■ (NBR)	JC152 ■ (x4)	JE160	HL457 ■ [9] (Cork)	HM5053 ■ [10] (ACM)	HR569 ■	NA5001 32.00x47.00x10.00mm FPM	

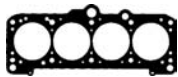

BM360

[9] Centering Diameter [mm]: 8.5

[10] Centering Diameter [mm]: 6.5

[14] With shaft oil seal

[9] Zentrierdurchmessers [mm]: 8.5

[10] Zentrierdurchmessers [mm]: 6.5

[14] Mit Wellendichtring

297	81.00	Petrol			
ADA	4 Cyl.	1595cc	74kW (100)PS	TD240	867
80	06/93→01/96				

TB108 121x18	TBK016				FOL92 (x8)

	OE				
V91407 ■ 39.60 x 7.97 x 91.90	048 109 601A	MAT. MD	45°		VAG92061B ■ ■ ■ 36.70 x 8.00 x 12.08
V91340 ■ 33.30 x 7.95 x 91.20	048 109 611A	MG	45°	H	

BM360 Fibre Composite	DM361 →Ch.8C-P-185 000 DM367 Ch.8C-P-185 001→	HBS043 ⊕ M11x1.50x95mm (x10)	JC478 ■ PA459 ■ (NBR) JC152 ■ (x4) ⊕ JE689	JP024 Ch.8C-P-185 001→ HL457 ■ [9] (Cork) →Ch.8C-P-185 000	HR569 ■ →Eng.034 669 HR816 ■ Eng.034 670→	NA5001 32.00x47.00x10.00mm FPM

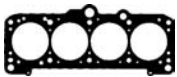

BM360

[9] Centering Diameter [mm]: 8.5

[9] Zentrierdurchmesser [mm]: 8.5

298	81.00	Petrol			
ADF	4 Cyl.	9:1	1781cc	55kW (75)PS	TD21353
898					

BM360 Fibre Composite	BZ910 MLS	JC478 ■ JC152 ■ (x4)	HL457 ■ [9] (Cork)	HR646 ■

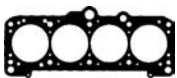

BM360



BZ910

299



81.00

Petrol



ADP	4 Cyl.	10.3:1	1595cc	74kW (100)PS	TD16253	869
ADP	4 Cyl.	10.3:1	1595cc	74kW (100)PS	TD4198	869
A4	11/94→09/01	PASSAT	10/96→11/00			

TB463 121x18	TBK309	CAM913	KIT	FOL143 (x8)

B x C x D	OE	MAT.	45°	H	E x F x G
V94079 ■ 39.40 x 7.00 x 92.10	078 109 601B	 MB	45°	H	VAG96041B ■ ■ ■ 36.50 x 7.00 x 12.08
V94080 ■ 32.80 x 7.00 x 91.20	048 109 611B	 MG	45°	H	

AY940 MLS	CY942	HBS043 ⊕ M11x1.50x95mm (x10)	JD5341 ■ ■ JC152 (x4)	JP024	HR816 ■	NA5001 32.00x47.00x10.00mm FPM

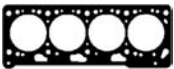







AY940







300



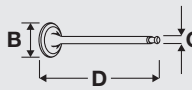











81.00
Petrol

AEH	4 Cyl.	10.2:1	1595cc	74kW (100)PS	TD12488	870
AEH	4 Cyl.	10.2:1	1595cc	74kW (100)PS	TD12950	870
AEH	4 Cyl.	10.2:1	1595cc	74kW (100)PS	TD5074	870
AEH	4 Cyl.	10.2:1	1595cc	74kW (100)PS	TD9450	870

A3	09/96→05/03	BORA	10/98→05/05	CORDOBA	06/99→12/02
GOLF	08/97→05/04	IBIZA	08/99→02/02	LEON	11/99→06/06
OCTAVIA	02/97→12/07	POLO	12/95→09/01	TOLEDO	04/99→09/00

					
TB552 138x23	TBK100	CAM913			FOL143 (x8)

	
B x C x D	E x F x G
OE	
MAT.	
	
45°	45°
H	H
V94079 	VAG96041B 
39.40 x 7.00 x 92.10	36.50 x 7.00 x 12.08
V94080 	
32.80 x 7.00 x 91.20	
MB	
MG	

							
AY980	CY980		HBS246  M10x1.50x120mm (x10)	JD607  (x4) JD600  JF211 	JP024	HR816 	NA5124 32.00x47.00x10.00mm PTFE/ACM

AY980

VW GROUP

301



81.00

Petrol



AEK	4 Cyl.	10.2:1	1595cc	74kW (100)PS	TD4982	871
GOLF	07/94→04/99	PASSAT	07/94→08/96	VENTO	10/94→09/98	

TB463 121x18	TBK086			FOL143 (x8)	

B x C x D	E x F x G
V91407	VAG92061B
048 109 601A 39.60 x 7.97 x 91.90 Eng.→000813	36.70 x 8.00 x 12.08 Eng.→000813
V94079	VAG96041B
078 109 601B 39.40 x 7.00 x 92.10 Eng.000814→	36.50 x 7.00 x 12.08 Eng.000814→
V91340	
053 109 611 33.30 x 7.95 x 91.20 Eng.→000813	
V94080	
048 109 611B 32.80 x 7.00 x 91.20 Eng.000814→	

AY940 MLS	CY940	HBS043 M11x1.50x95mm (x10)	JD599 JD600 JF205	JP024	HR569	NA5001 32.00x47.00x10.00mm FPM

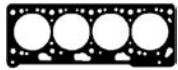

AY940

302



81.00

Petrol











AFX	4 Cyl.	1595cc	74kW (100)PS	TD19870
-----	--------	--------	--------------	---------





BZ910 MLS	JD483 JD599 JD606	JP024	HR646	NB446





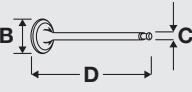





BZ910

303	 81.00	Petrol	
AHL	4 Cyl.	1595cc	74kW (100)PS
AHL	4 Cyl.	1595cc	74kW (100)PS
A4	11/94→09/01	PASSAT	10/96→11/00

					
TB552 138x23	TBK100	CAM913			FOL143 (x8)

		
B x C x D	OE	MAT.
V94079 ■	078 109 601B	
39.40 x 7.00 x 92.10		45°
V94080 ■	048 109 611B	
32.80 x 7.00 x 91.20		45°
		H
		H
		VAG96041B ■ ■ ■
		36.50 x 7.00 x 12.08

							
AC5220 MLS	CC5220 [14]	HBS246 ⊗ M10x1.50x120mm (x10)	JD5341 ■ JC152 ■ (x4) ⊗ JE689	JP024	HR816 ■	NA5124 32.00x47.00x10.00mm PTFE/ACM	











AC5220









[14] With shaft oil seal

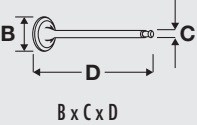
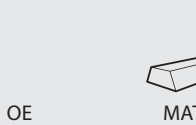
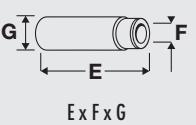











[14] Mit Wellendichtring

VW GROUP

304	 81.00	Petrol				
AKL	4 Cyl.	10.3:1	1595cc	74kW (100)PS	TD12509	870
AKL	4 Cyl.	10.3:1	1595cc	74kW (100)PS	TD12951	870
AKL	4 Cyl.	10.3:1	1595cc	74kW (100)PS	TD9451	870
AKL	4 Cyl.	10.3:1	1595cc	74kW (100)PS	TD9990	870
A3	09/96→05/03	BORA	10/98→05/05	CORDOBA	07/96→12/02	
GOLF	08/97→05/04	IBIZA	08/99→02/02	LEON	11/99→06/06	
OCTAVIA	02/97→12/07	POLO	12/95→09/01	TOLEDO	04/99→09/00	

					
TB552 138x23	TBK100	CAM913			FOL143 (x8)

						
B x C x D	OE	MAT.				E x F x G
V94079 	078 109 601B		45°	H		VAG96041B 
39.40 x 7.00 x 92.10		MB				36.50 x 7.00 x 12.08
V94080 	048 109 611B		45°	H		
32.80 x 7.00 x 91.20		MG				

							
AY980	CY980	HBS246 	JD607  (x4)	JD600 	JP024	HR816 	NA5124 32.00x47.00x10.00mm PTFE/ACM
		M10x1.50x120mm (x10)					











AY980







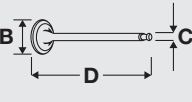
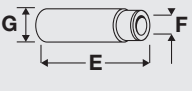

305  **81.00** **Petrol** 

ALZ	4 Cyl.	10.3:1	1595cc	75kW (102)PS	TD15148	874
ALZ	4 Cyl.	10.3:1	1595cc	75kW (102)PS	TD15748	874
ALZ	4 Cyl.	10.3:1	1595cc	75kW (102)PS	TD22242	874

A4 07/00→06/08 EXEO 03/09→09/10 PASSAT 11/00→05/05

					
TB552 138x23	TBK100	CAM745			FOL154 (x8)

			
B x C x D	OE	MAT.	
V94424 ■ 39.50 x 6.00 x 94.00	06B 109 601D	 MB	45° Y H
V94425 ■ 32.90 x 6.00 x 93.90	06B 109 611C	 MG	45° ss H
			VAG96073B ■ ■ ■ 36.00 x 6.02 x 11.06

							
AC5220 MLS	CC5223		HBS246 ☼ M10x1.50x120mm (x10)	JD5341 ■ (x4) JC152 ■ (x4)	JM5205 (Elastomer)	PA5041 (x8) 6.00x8.8/12.20x10.00 866N W (FPM) HR817 ■	NA5124 32.00x47.00x10.00mm PTFE/ACM



AC5220

VW GROUP

306	81.00	Petrol				
ANA	4 Cyl.	1595cc	74kW (100)PS	TD14128	875	
ANA	4 Cyl.	1595cc	74kW (100)PS	TD16254	875	
ARM	4 Cyl.	10.3:1	1595cc	74kW (100)PS	TD14148	876
ARM	4 Cyl.	10.3:1	1595cc	74kW (100)PS	TD16255	876
A4	11/94→09/01	PASSAT	10/96→11/00			

TB552 138x23	TBK100	CAM913		FOL143 (x8)

V94079 ■ 39.40 x 7.00 x 92.10	V94080 ■ 32.80 x 7.00 x 91.20	MAT. MB MG	45°	H	VAG96041B ■ ■ ■ ■ ■ 36.50 x 7.00 x 12.08
OE: 078 109 601B	OE: 048 109 611B				

AC5220 MLS	CC5220 [14]	HBS246 ☒ M10x1.50x120mm (x10)	JD5341 ■ (x4) JC152 ■ (x4)	JE689	JP024	HR816 ■	NA5124 32.00x47.00x10.00mm PTFE/ACM	



AC5220

[14] With shaft oil seal

[14] Mit Wellendichtring

307	81.00	Petrol						
ANQ	4 Cyl.	10.3:1	1781cc	92kW (125)PS	TD26500			
								PA5041 (x16) 6.00x8.8/12.20x10.00 866N W (FPM)

308



81.00

Petrol



APF	4 Cyl.	10.3:1	1595cc	74kW (100)PS	TD11588	870
APF	4 Cyl.	10.3:1	1595cc	74kW (100)PS	TD12848	870
APF	4 Cyl.	10.3:1	1595cc	74kW (100)PS	TD13269	870
AWH	4 Cyl.		1595cc	74kW (100)PS	TD15465	878

A3	09/96→05/03	BORA	10/98→05/05	CORDOBA	06/99→12/02
GOLF	08/97→05/04	IBIZA	08/99→02/02	LEON	11/99→06/06
NEW BEETLE	10/99→09/00	POLO	12/95→09/01	TOLEDO	04/99→09/00

TB552 138x23	TBK100	CAM913			FOL143 (x8)

B x C x D	E x F x G
OE	
MAT.	
45°	
H	
V94079	VAG96041B
39.40 x 7.00 x 92.10	36.50 x 7.00 x 12.08
V94080	
32.80 x 7.00 x 91.20	
MB	
MG	

AC5220 MLS	CC5221 [14]		HBS246	JD5340	JP024	HR816	NA5124
			M10x1.50x120mm (x10)	JD5293			32.00x47.00x10.00mm PTFE/ACM



AC5220

[14] With shaft oil seal

[14] Mit Wellendichtring

309

81.00
Petrol

AUR	4 Cyl.	10.3:1	1595cc	74kW (100)PS	TD15611	877
AUR	4 Cyl.	10.3:1	1595cc	74kW (100)PS	TD16200	877
CORDOBA	06/99→12/02	IBIZA	08/99→02/02	POLO	12/95→09/01	

TB552 138x23	TBK100	CAM913	KIT	FOL143 (x8)



V94079 ■ 39.40 x 7.00 x 92.10	V94080 ■ 32.80 x 7.00 x 91.20	V94303 ■ 32.90 x 7.00 x 91.20	VAG96041B ■ ■ ■ 36.50 x 7.00 x 12.08
OE	MAT.		
078 109 601B	MB	45°	H
048 109 611B	MG	45°	H
078 109 611C	MG	45° ss	H







AC5220 MLS	CC5221 [14]	HBS246 ☒ M10x1.50x120mm (x10)	JD5340 ■ (x4) JD5293 ■	JP024	HR816 ■	NA5124 32.00x47.00x10.00mm PTFE/ACM









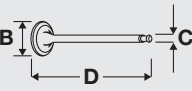

AC5220



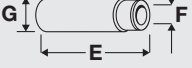









[14] With shaft oil seal

[14] Mit Wellendichtring

310	 81.00	Petrol				
AVU	4 Cyl.	10.3:1	1595cc	75kW (102)PS	TD15350	875
AVU	4 Cyl.	10.3:1	1595cc	75kW (102)PS	TD15475	875
AVU	4 Cyl.	10.3:1	1595cc	75kW (102)PS	TD16068	875
A3	08/00→05/03	BORA	08/00→05/05	GOLF	08/00→06/06	
OCTAVIA	09/00→12/10					

					
TB552 138x23	TBK100	CAM745			FOL154 (x8)

						
B x C x D	OE	MAT.	45°	Y	H	E x F x G
V94424 	06B 109 601D		45°	Y	H	VAG96073B 
39.50 x 6.00 x 94.00		MB				36.00 x 6.02 x 11.06
V94425 	06B 109 611C		45°	ss	H	
32.90 x 6.00 x 93.90		MG				

							
AC5220 MLS	CC5222 [14]	HBS246  M10x1.50x120mm (x10)	JD5340  (x4) JD5293 	JM5205 (Elastomer)	PA5041 (x8) 6.00x8.8/12.20x10.00 866N W (FPM) HR817 	NA5124 32.00x47.00x10.00mm PTFE/ACM	



AC5220







[14] With shaft oil seal







[14] Mit Wellendichtring



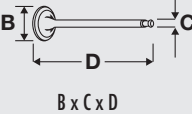



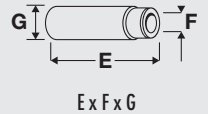



AYD 4 Cyl. 1595cc 75kW (102)PS TD15466

NEW BEETLE 06/00 →

					
TB552 138x23	TBK100		KIT		FOL154 (x8)

 B x C x D	OE	 MAT.	 45°	 Y	 H	 E x F x G
V94424 ■ 39.50 x 6.00 x 94.00	06B 109 601D	 MB	45°	Y	H	VAG96073B ■ ■ ■ 36.00 x 6.02 x 11.06
V94425 ■ 32.90 x 6.00 x 93.90	06B 109 611C	 MG	45°	ss	H	

							
AC5220 MLS	CC5222 [14]	HBS246 ☒ M10x1.50x120mm (x10)	JD5340 ■ (x4) JD5293 ■	JM5205 (Elastomer)	PA5041 (x8) 6.00x8.8/12.20x10.00 866N W (FPM) HR817 ■	NA5124 32.00x47.00x10.00mm PTFE/ACM	

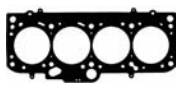

AC5220

[14] With shaft oil seal







[14] Mit Wellendichtring







312







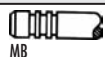
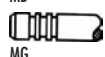

81.00
Petrol

BFQ	4 Cyl.	10.2:1	1595cc	75kW (102)PS	TD17166	874
BFQ	4 Cyl.	10.2:1	1595cc	75kW (102)PS	TD17912	874
BFQ	4 Cyl.	10.2:1	1595cc	75kW (102)PS	TD18137	874
BFQ	4 Cyl.	10.2:1	1595cc	75kW (102)PS	TD20621	874
BFS	4 Cyl.		1595cc	75kW (102)PS	TD16743	879
BSE	4 Cyl.		1595cc	75kW (102)PS	TD18222	874
BSE	4 Cyl.		1595cc	75kW (102)PS	TD18245	874
BSE	4 Cyl.		1595cc	75kW (102)PS	TD20711	874
BSE	4 Cyl.		1595cc	75kW (102)PS	TD20898	874
BSF	4 Cyl.		1595cc	75kW (102)PS	TD18223	874
BSF	4 Cyl.		1595cc	75kW (102)PS	TD18246	874
BSF	4 Cyl.		1595cc	75kW (102)PS	TD20712	874
BSF	4 Cyl.		1595cc	75kW (102)PS	TD20899	874
CCSA	4 Cyl.	10.5:1	1595cc	75kW (102)PS	TD20710	874
CCSA	4 Cyl.	10.5:1	1595cc	75kW (102)PS	TD20780	874
CCSA	4 Cyl.	10.5:1	1595cc	75kW (102)PS	TD20900	874
CCSA	4 Cyl.	10.5:1	1595cc	75kW (102)PS	TD22665	874

A3	08/00→	ALTEA	03/04→	ALTEA XL	10/06→
BORA	08/00→05/05	CADDY	04/04→	GOLF	08/00→
JETTA	10/05→10/10	LEON	07/05→	NEW BEETLE	06/00→
OCTAVIA	09/00→	PASSAT	05/05→11/10	TOLEDO	10/04→05/09
TOURAN	07/03→05/10				

					
TB552 138x23	TBK100		KIT		

					
B x C x D	OE	MAT.			E x F x G
V94424 ■ 39.50 x 6.00 x 94.00	06B 109 601D		45°	Y	H
V94425 ■ 32.90 x 6.00 x 93.90	06B 109 611C		45°	ss	H

							
AC5220 MLS	CC5222 [14]	HB5246 ☼ M10x1.50x120mm (x10)	JD5340 ■ (x4) JD5293 ■	JM5205 (Elastomer)	PA5041 (x8) 6.00x8.8/12.20x10.00 866N W (FPM) HR817 ■	NA5124 32.00x47.00x10.00mm PTFE/ACM	

AC5220

[14] With shaft oil seal

[14] Mit Wellendichtring

313	81.00	Petrol				
BGU	4 Cyl.	10.3:1	1595cc	75kW (102)PS	TD16871	874
BGU	4 Cyl.	10.3:1	1595cc	75kW (102)PS	TD17067	874
BGU	4 Cyl.	10.3:1	1595cc	75kW (102)PS	TD17352	874
BGU	4 Cyl.	10.3:1	1595cc	75kW (102)PS	TD17496	874
A3	05/03 →	ALTEA	03/04 →	CADDY	04/04 →	
OCTAVIA	06/04 →	TOURAN	07/03 →05/10	TOLEDO	10/04 →05/09	
GOLF	01/04 →11/08	JETTA	10/05 →10/10	LEON	10/05 →06/06	

	.KIT		KIT		
TB552 138x23	TBK100				FOL154 (x8)

 B x C x D	OE	 MAT.	45°	Y	H	 E x F x G
V94424 ■ 39.50 x 6.00 x 94.00	06B 109 601D	MB	45°	Y	H	VAG96073B ■ ■ ■ 36.00 x 6.02 x 11.06
V94425 ■ 32.90 x 6.00 x 93.90	06B 109 611C	MG	45°	ss	H	

AC5220 MLS	CC5222 [14]		HBS246 ☒ M10x1.50x120mm (x10)	JD5340 ■ (x4) JD5293 ■	JM5205 (Elastomer)	PA5041 (x8) 6.00x8.8/12.20x10.00 866N W (FPM) HR817 ■	NA5124 32.00x47.00x10.00mm PTFE/ACM



AC5220

[14] With shaft oil seal

[14] Mit Wellendichtring

314	81.00	Petrol		
BJH	4 Cyl.	1595cc	75kW (102)PS	TD19138
BORA	08/00 →05/05	GOLF	08/00 →06/05	

	.KIT		KIT		
TB552 138x23	TBK100				



AC5220 MLS	CC5222 [14]		HBS246 ☒ M10x1.50x120mm (x10)	JD5340 ■ (x4) JD5293 ■	JM5205 (Elastomer)	PA5041 (x8) 6.00x8.8/12.20x10.00 866N W (FPM) HR817 ■	NA5124 32.00x47.00x10.00mm PTFE/ACM



AC5220

[14] With shaft oil seal

[14] Mit Wellendichtring

315		81.00	Petrol		
BNY	4 Cyl.		1781cc	73kW (99)PS	TD25774
BWX	4 Cyl.	10.1:1	1595cc	73kW (99)PS	TD25788
UDH	4 Cyl.		1781cc	73kW (99)PS	TD20405
GOL	12/98→05/08		PARATI	08/02→	

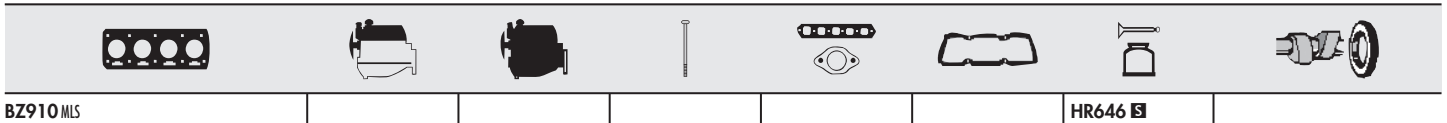

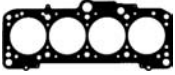

BZ910 MLS

HR646 



BZ910

316		81.00	Petrol		
BRY	4 Cyl.		1595cc	74kW (100)PS	TD19139
BRY	4 Cyl.		1595cc	74kW (100)PS	TD22897
CADDY	03/05→				

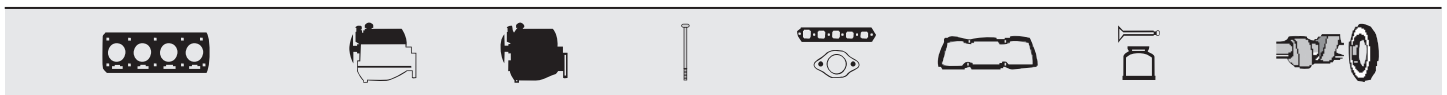



HBS246 
M10x1.50x120mm (x10)

JD5340  (x4)
JD600 

JM5205
(Elastomer)

PA5041 (x8)
6.00x8.8/12.20x10.00
866N W (FPM)
HR817 

NA5124
32.00x47.00x10.00mm PTFE/ACM

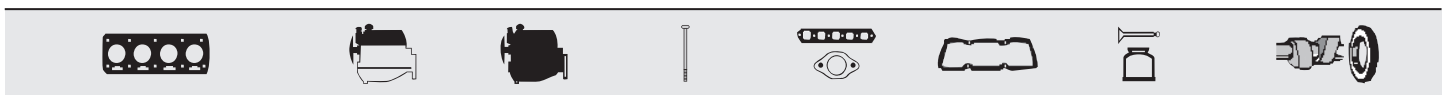

317		81.00	Petrol		
CHGA	4 Cyl.		1595cc	75kW (102)PS	TD22180
CHGA	4 Cyl.		1595cc	75kW (102)PS	TD22676
CHGA	4 Cyl.		1595cc	75kW (102)PS	TD22691
ALTEA	09/09→		ALTEA XL	09/09→	CADDY 05/11→
GOLF	03/09→		LEON	12/09→	OCTAVIA 08/09→



AC5220 MLS

CC5222 [14]

HBS246 
M10x1.50x120mm (x10)

JD5340  (x4)
JD5293 

JM5205
(Elastomer)

PA5041 (x8)
6.00x8.8/12.20x10.00
866N W (FPM)
HR817 

NA5124
32.00x47.00x10.00mm PTFE/ACM



AC5220

[14] With shaft oil seal

[14] Mit Wellendichtring

318	81.00	Petrol			
CMXA	4 Cyl.	10.5:1	1595cc	75kW (102)PS	TD23937
CMXA	4 Cyl.	10.5:1	1595cc	75kW (102)PS	TD24313
CMXA	4 Cyl.	10.5:1	1595cc	75kW (102)PS	TD24325
CMXA	4 Cyl.	10.5:1	1595cc	75kW (102)PS	TD24599

A3	05/03→	ALTEA	03/04→	ALTEA XL	10/06→
GOLF	05/05→	LEON	07/05→	OCTAVIA	06/04→

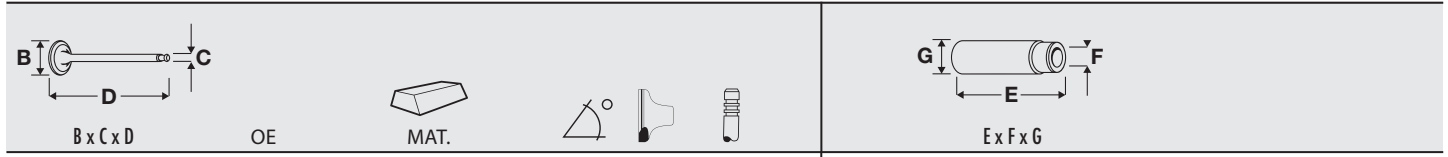

V94424 ■	06B 109 601D		45°	Y	H
39.50 x 6.00 x 94.00		MB			
V94425 ■	06B 109 611C		45°	ss	H
32.90 x 6.00 x 93.90		MG			

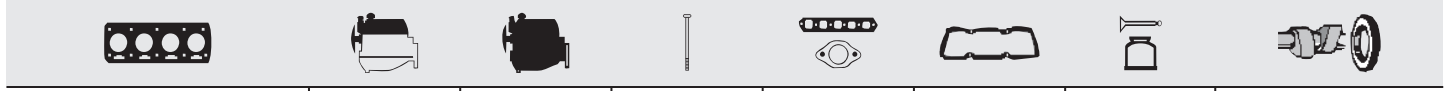

AC5220 MLS	CC5222 [14]	HBS246 ☒	JD5340 ■ (x4)	JM5205	PA5041 (x8)	NA5124
		M10x1.50x120mm (x10)	JD5293 ■	(Elastomer)	6.00x8.8/12.20x10.00 866N W (FPM) HR817 ■	32.00x47.00x10.00mm PTFE/ACM



AC5220
 [14] With shaft oil seal [14] Mit Wellendichtring

319	81.00	Petrol			
DT	4 Cyl.	1595cc	55kW (75)PS	TD4206	880
DT	4 Cyl.	1595cc	55kW (75)PS	TD4997	880
80	08/78→07/86	PASSAT	08/80→03/88	SANTANA	08/81→12/84





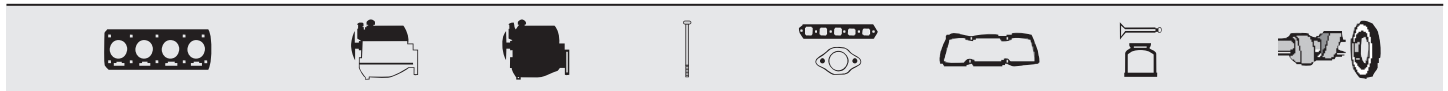



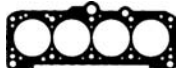





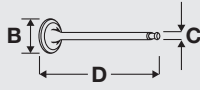
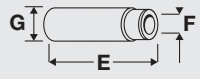

TB108	TBK016	FOL92 (x8)
121x18		











BM360 Fibre Composite	DM360	HBS043 ☒	JC478 ■	HL457 ■ [9]	HR569 ■	NA5001
		M11x1.50x95mm (x10)	PA459 ■	(Cork)		32.00x47.00x10.00mm FPM
			(NBR)	HM5053 ■ [10]		
			JC152 ■ (x4)	(ACM)		
			JE138 [61]			











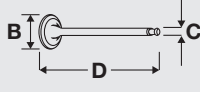





















BM360
 [61] To cylinder 4 - 6 [61] zum Zylinder 4 - 6
 [9] Centering Diameter [mm]: 8.5 [9] Zentrierdurchmessers [mm]: 8.5
 [10] Centering Diameter [mm]: 6.5 [10] Zentrierdurchmessers [mm]: 6.5

320	 81.00	Petrol								
DTA	4 Cyl.	9:1	1595cc	55kW (75)PS					TD255	881
 B x C x D					 E x F x G					
V91338 	035 109 601K	 MAT.	 45°			VAG92061B 		VAG92105B 		
38.10 x 7.97 x 91.90		MD				36.70 x 8.00 x 12.08		42.30 x 7.99 x 12.08		
V91340 	048 109 611A	 MG	45°		H					
33.30 x 7.95 x 91.20										

321	 81.00	Petrol								
EW	4 Cyl.	9:1	1595cc	55kW (75)PS					TD4070	882
CADDY	01/83→07/92	GOLF	01/83→04/92	JETTA	08/82→07/83					
SCIROCCO	01/83→12/89									

	 .KIT		 KIT		
TB108	TBK016				FOL92 (x8)
121x18					

 B x C x D					 E x F x G					
V91338 	035 109 601K	 MAT.	 45°			VAG92061B 		VAG92105B 		
38.10 x 7.97 x 91.90		MD				36.70 x 8.00 x 12.08		42.30 x 7.99 x 12.08		
V91030 	035 109 611F	 MG	45°	ss	H					
33.30 x 7.95 x 98.60										
V91340 	053 109 611	 MG	45°		H					
33.30 x 7.95 x 91.20										

							
BM360 Fibre Composite	DM368 [14]		HBS043  M11x1.50x95mm (x10)	JC478  PA459  (NBR) JC152  (x4)  JE160	HL457  [9] (Cork) HM5053  [10] (ACM)	HR569 	NA5001 32.00x47.00x10.00mm FPM

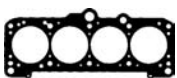

BM360

[9] Centering Diameter [mm]: 8.5

[9] Zentrierdurchmessers [mm]: 8.5

[10] Centering Diameter [mm]: 6.5

[10] Zentrierdurchmessers [mm]: 6.5

[14] With shaft oil seal

[14] Mit Wellendichtring

322



81.00

Petrol



EWA	4 Cyl.	8.2:1	1595cc	51-55kW (70-75)PS	TD4072
SCIROCCO 08/83→07/84					

TB108 121x18	TBK016				

BM360 Fibre Composite	DM368 [14]		HBS043 Ⓣ M11x1.50x95mm (x10)	JC478 ■ PA459 ■ (NBR) JC152 ■ (x4) ⓄJE160	HL457 ■ [9] (Cork) HM5053 ■ [10] (ACM)	HR569 ■	NA5001 32.00x47.00x10.00mm FPM

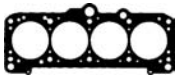

BM360

[9] Centering Diameter [mm]: 8.5 [9] Zentrierdurchmessers [mm]: 8.5
 [10] Centering Diameter [mm]: 6.5 [10] Zentrierdurchmessers [mm]: 6.5
 [14] With shaft oil seal [14] Mit Wellendichtring

323



81.00

Petrol



EZ	4 Cyl.	9:1	1595cc	55kW (75)PS	TD4074	883
EZ	4 Cyl.	9:1	1595cc	55kW (75)PS	TD4899	883
GOLF	08/83→07/92	JETTA	01/84→07/92	PASSAT	02/88→09/91	
TOLEDO	05/91→03/99					

TB108 121x18	TBK016				FOL92 (x8)



B x C x D	E x F x G
V91338 ■ 38.10 x 7.97 x 91.90	VAG92061B ■ ■ ■ 36.70 x 8.00 x 12.08
V91030 ■ 33.30 x 7.95 x 98.60	VAG92105B ■ ■ ■ 42.30 x 7.99 x 12.08
V91340 ■ 33.30 x 7.95 x 91.20	
OE: 035 109 601K, 035 109 611F, 053 109 611	MAT.: MD, MG, MG
45°, 45° ss, 45°	H, H

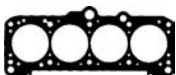







BM360 Fibre Composite	DM368 [14]		HBS043 Ⓣ M11x1.50x95mm (x10)	JC478 ■ PA459 ■ (NBR) JC152 ■ (x4) ⓄJE160	HL457 ■ [9] (Cork) HM5053 ■ [10] (ACM)	HR569 ■	NA5001 32.00x47.00x10.00mm FPM



BM360

[9] Centering Diameter [mm]: 8.5 [9] Zentrierdurchmessers [mm]: 8.5
 [10] Centering Diameter [mm]: 6.5 [10] Zentrierdurchmessers [mm]: 6.5
 [14] With shaft oil seal [14] Mit Wellendichtring



324	 81.00	Petrol	
EZA	4 Cyl.	1595cc	51kW (70)PS
			TD4075 884

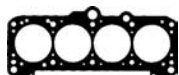







							
BM360 Fibre Composite	DM360 DM368 [14]		HBS043 Ⓞ M11x1.50x95mm (x10)	JC478 ■ PA459 ■ (NBR) JC152 ■ (x4) JE160	HL457 ■ [9] (Cork) HM5053 ■ [10] (ACM)	HR569 ■ HR627	NA5001 32.00x47.00x10.00mm FPM NB446



BM360

- [9] Centering Diameter [mm]: 8.5
- [10] Centering Diameter [mm]: 6.5
- [14] With shaft oil seal
- [9] Zentrierdurchmessers [mm]: 8.5
- [10] Zentrierdurchmessers [mm]: 6.5
- [14] Mit Wellendichtring

325	 81.00	Petrol	
HM	4 Cyl.	9:1	1595cc
			55kW (75)PS
			TD3590 884
HM	4 Cyl.	9:1	1595cc
			55kW (75)PS
			TD9523 884
GOLF	08/83→07/92	JETTA	01/84→07/92

							
BM360 Fibre Composite	DM368 [14]		HBS043 Ⓞ M11x1.50x95mm (x10)	JC478 ■ PA459 ■ (NBR) JC152 ■ (x4) JE160	HL457 ■ [9] (Cork) HM5053 ■ [10] (ACM)	HR569 ■	NA5001 32.00x47.00x10.00mm FPM



BM360

- [9] Centering Diameter [mm]: 8.5
- [10] Centering Diameter [mm]: 6.5
- [14] With shaft oil seal
- [9] Zentrierdurchmessers [mm]: 8.5
- [10] Zentrierdurchmessers [mm]: 6.5
- [14] Mit Wellendichtring

VW GROUP

326

81.00

Petrol



HN 4 Cyl. 1595cc 55kW (75)PS TD4107 885

GOLF 01/83→04/92

TB108 121x18	TBK016				

B x C x D	OE	MAT.			E x F x G
V91034 ■ 38.10 x 7.97 x 99.06	035 109 601C	MB	45°	H	VAG92061B ■ ■ ■ 36.70 x 8.00 x 12.08
V91030 ■ 33.30 x 7.95 x 98.60	035 109 611F	MG	45° ss	H	VAG92105B ■ ■ ■ 42.30 x 7.99 x 12.08

BM360 Fibre Composite	DM368 [14]		HBS043 ⊕ M11x1.50x95mm (x10)	JC478 ■ PA459 ■ (NBR) JC152 ■ (x4) ⊕ JE160	HL457 ■ [9] (Cork) HM5053 ■ [10] (ACM)	HR569 ■	NA5001 32.00x47.00x10.00mm FPM

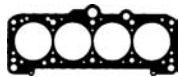

BM360

[9] Centering Diameter [mm]: 8.5

[9] Zentrierdurchmessers [mm]: 8.5

[10] Centering Diameter [mm]: 6.5

[10] Zentrierdurchmessers [mm]: 6.5

[14] With shaft oil seal

[14] Mit Wellendichtring

327

81.00



Petrol











JU 4 Cyl. 9:1 1595cc 55kW (75)PS TD12532 885







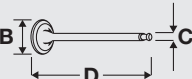
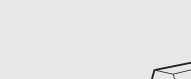
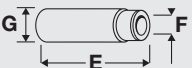

JU 4 Cyl. 9:1 1595cc 55kW (75)PS TD277 885

B x C x D	OE	MAT.			E x F x G
V91034 ■ 38.10 x 7.97 x 99.06	035 109 601C	MB	45°	H	VAG92105B ■ ■ ■ 42.30 x 7.99 x 12.08
V91338 ■ 38.10 x 7.97 x 91.90	035 109 601K	MD	45°		
V91030 ■ 33.30 x 7.95 x 98.60	035 109 611F	MG	45° ss	H	
V91340 ■ 33.30 x 7.95 x 91.20	053 109 611	MG	45°	H	

328	 81.00	Petrol			
PN	4 Cyl.	9:1	1595cc	51kW (70)PS	TD4141 886
RE	4 Cyl.	9:1	1595cc	53kW (72)PS	TD4145 888
RF	4 Cyl.	9:1	1595cc	53kW (72)PS	TD5025 886
GOLF	02/86→12/92	JETTA	03/86→10/91	SCIROCCO	04/86→07/90

					
TB108 121x18	TBK016		KIT		FOL92 (x8)

					
B x C x D	OE	MAT.	45°	H	E x F x G
V91338 ■ 38.10 x 7.97 x 91.90	035 109 601K		45°		VAG92061B ■ ■ ■ 36.70 x 8.00 x 12.08
V91340 ■ 33.30 x 7.95 x 91.20	053 109 611		45°	H	

								
BM360 Fibre Composite	DM368 [14]	HBS043 ⊕ M11x1.50x95mm (x10)	JC478 ■ PA459 ■ (NBR) JC152 ■ (x4) ⊕ JE160	HL457 ■ [9] (Cork) HM5053 ■ [10] (ACM)	HR569 ■	NA5001 32.00x47.00x10.00mm FPM		

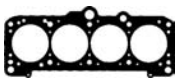

BM360

- [9] Centering Diameter [mm]: 8.5
- [10] Centering Diameter [mm]: 6.5
- [14] With shaft oil seal
- [9] Zentrierdurchmessers [mm]: 8.5
- [10] Zentrierdurchmessers [mm]: 6.5
- [14] Mit Wellendichtring

329	81.00	Petrol			
PP	4 Cyl.	9:1	1595cc	51kW (70)PS	TD307 887
PP	4 Cyl.	9:1	1595cc	51kW (70)PS	TD5022 887
80	08/87→09/91	PASSAT	08/87→03/88		

TB108 121x18	TBK016		KIT		FOL92 (x8)

V91338	035 109 601K		45°		VAG92061B
38.10 x 7.97 x 91.90		MD			36.70 x 8.00 x 12.08
V91340	048 109 611A		45°	H	VAG92105B
33.30 x 7.95 x 91.20		MG			42.30 x 7.99 x 12.08

BM360 Fibre Composite	DM360	HBS043 M11x1.50x95mm (x10)	JC478 PA459 (NBR) JC152 (x4) JE138 [61]	HL457 [9] (Cork) HM5053 [10] (ACM)	HR569	NA5001 32.00x47.00x10.00mm FPM

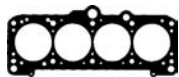

BM360

[61] To cylinder 4 - 6



[9] Centering Diameter [mm]: 8.5







[10] Centering Diameter [mm]: 6.5



[61] zum Zylinder 4 - 6







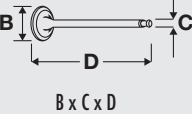

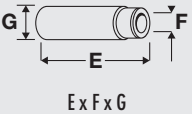
[9] Zentrierdurchmessers [mm]: 8.5

[10] Zentrierdurchmessers [mm]: 6.5

330	 81.00	Petrol	
RL	4 Cyl.	9:1	1595cc
			53kW (72)PS
			TD4148 889
PASSAT 01/85→03/88			

					
TB108 121x18	TBK016				FOL92 (x8)

		
B x C x D	OE	MAT.
V91338 ■ 38.10 x 7.97 x 91.90	035 109 601K	45°
V91340 ■ 33.30 x 7.95 x 91.20	053 109 611	45° H
	MD	
	MG	
		VAG92061B ■ ■ 36.70 x 8.00 x 12.08

							
BM360 Fibre Composite	DM360	HBS043 ⊕ M11x1.50x95mm (x10)	JC478 ■ PA459 ■ (NBR)	JC152 ■ (x4) ⊕ JE138 [61]	HL457 ■ [9] (Cork) HM5053 ■ [10] (ACM)	HR569 ■	NA5001 32.00x47.00x10.00mm FPM

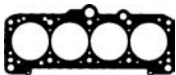

BM360

- [61] To cylinder 4 - 6
- [9] Centering Diameter [mm]: 8.5
- [10] Centering Diameter [mm]: 6.5
- [14] With shaft oil seal
- [61] zum Zylinder 4 - 6
- [9] Zentrierdurchmessers [mm]: 8.5
- [10] Zentrierdurchmessers [mm]: 6.5
- [14] Mit Wellendichtring

331



81.00

Petrol



RN 4 Cyl. 1595cc 55kW (75)PS TD314 887

80 09/86 → 08/91

TB108 121x18	TBK016				FOL92 (x8)

B x C x D	OE	MAT.	45°	H	E x F x G
V91338 ■ 38.10 x 7.97 x 91.90	035 109 601K	MD	45°		VAG92061B ■ ■ ■ 36.70 x 8.00 x 12.08
V91340 ■ 33.30 x 7.95 x 91.20	048 109 611A	MG	45°	H	VAG92105B ■ ■ ■ 42.30 x 7.99 x 12.08

BM360 Fibre Composite	DM363		HBS043 ⊕ M11x1.50x95mm (x10)	JC478 ■ PA459 ■ (NBR) JC152 ■ (x4) ■ JE689	HL457 ■ [9] (Cork) HM5053 ■ [10] (ACM)	HR569 ■	NA5001 32.00x47.00x10.00mm FPM

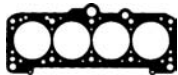

BM360

[9] Centering Diameter [mm]: 8.5

[9] Zentrierdurchmessers [mm]: 8.5

[10] Centering Diameter [mm]: 6.5

[10] Zentrierdurchmessers [mm]: 6.5

332



81.00

Petrol



SA 4 Cyl. 9:1 1595cc 54kW (73)PS TD321 890

80 02/86 → 07/86

TB108 121x18	TBK016				FOL92 (x8)

B x C x D	OE	MAT.	45°	H	E x F x G
V91340 ■ 33.30 x 7.95 x 91.20	048 109 611A	MG	45°	H	VAG92061B ■ ■ ■ 36.70 x 8.00 x 12.08

BM360 Fibre Composite	DM360		HBS043 ⊕ M11x1.50x95mm (x10)	JC478 ■ PA459 ■ (NBR) JC152 ■ (x4)	HL457 ■ [9] (Cork) HM5053 ■ [10] (ACM)	HR569 ■	NA5001 32.00x47.00x10.00mm FPM

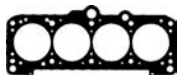

BM360

[9] Centering Diameter [mm]: 8.5

[9] Zentrierdurchmessers [mm]: 8.5

[10] Centering Diameter [mm]: 6.5

[10] Zentrierdurchmessers [mm]: 6.5

333	81.00	Petrol	
EA111	4 Cyl.	1598cc	55kW (75)PS
TD4901			
FELICIA 08/95→03/98			

TB467 137x19	TBK088		KIT		

BZ180 MLS, 0.500mm	DZ181		HBS075 Ⓞ M11x1.50x110mm (x10)	JD597 ■ ■ ■ JD601 ■	JP074 HM5062 ■	HR816 ■	NA5001 32.00x47.00x10.00mm FPM

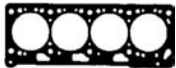

BZ180

334	81.00	Petrol	
TH	4 Cyl.	1781cc	118kW (160)PS
Supercharged TD3994 891			
GOLF 08/88→07/91			

TB108 121x18	TBK016		KIT		FOL92 (x8)

$B \times C \times D$	OE	MAT.	45°	H	$E \times F \times G$
V91407 ■ 39.60 x 7.97 x 91.90	048 109 601A		45°		
V91340 ■ 33.30 x 7.95 x 91.20	053 109 611		45°	H	

BY630 MLS	DT819		HBS043 Ⓞ M11x1.50x95mm (x10)	JC478 ■ JC152 ■ (x4)	JN964	HR569 ■	NA5001 32.00x47.00x10.00mm FPM



BY630

335







 81.00



Petrol







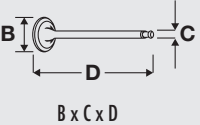
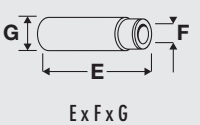



1P 4 Cyl. 1781cc 72kW (98)PS TD3995 892

GOLF 08/88 → 07/91 JETTA 08/88 → 07/91

					
TB108 121x18	TBK016	CAM411			FOL92 (x8)

			
B x C x D	E x F x G	OE MAT. 45° MD MG	H
V91407 ■ 39.60 x 7.97 x 91.90		048 109 601A	
V91340 ■ 33.30 x 7.95 x 91.20		053 109 611	

							
BM360 Fibre Composite	DM368 [14]		HBS043 ⊕ M11x1.50x95mm (x10)	JC478 ■ PA459 ■ (NBR) JC152 ■ (x4) ⊕ JE160	HL457 ■ [9] (Cork) HM5053 ■ [10] (ACM)	HR569 ■	NA5001 32.00x47.00x10.00mm FPM

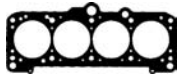

BM360

[9] Centering Diameter [mm]: 8.5

[9] Zentrierdurchmessers [mm]: 8.5

[10] Centering Diameter [mm]: 6.5

[10] Zentrierdurchmessers [mm]: 6.5

[14] With shaft oil seal

[14] Mit Wellendichtring

336







 **81.00**







Petrol



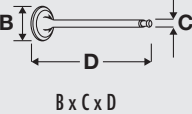



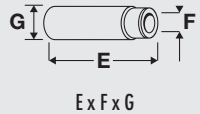



2H 4 Cyl. 9:1 1781cc 72kW (98)PS TD4965 893

GOLF 08/89→03/93

					
TB108 121x18	TBK016				FOL92 (x8)

					
B x C x D	OE	MAT.	45°	H	E x F x G
V91407 ■ 39.60 x 7.97 x 91.90	048 109 601A		45°		VAG92061B ■ ■ ■ 36.70 x 8.00 x 12.08
V91340 ■ 33.30 x 7.95 x 91.20	053 109 611		45°	H	

							
BM360 Fibre Composite	DM368 [14]	HBS043 ⊕ M11x1.50x95mm (x10)	JC478 ■ PA459 ■ (NBR)	JC152 ■ (x4) ⊕ JE160	HL457 ■ [9] (Cork) HM5053 ■ [10] (ACM)	HR569 ■	NA5001 32.00x47.00x10.00mm FPM

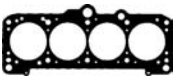

BM360

[9] Centering Diameter [mm]: 8.5
[10] Centering Diameter [mm]: 6.5
[14] With shaft oil seal

[9] Zentrierdurchmessers [mm]: 8.5
[10] Zentrierdurchmessers [mm]: 6.5
[14] Mit Wellendichtring

337



81.00

Petrol



4B

4 Cyl.

1781cc

66kW (89)PS

TD219

894

100

03/85→11/90

TB108 121x18	TBK016		KIT		FOL92 (x8)

B x C x D	E x F x G
V91338 ■ 38.10 x 7.97 x 91.90	VAG92061B ■ ■ ■ 36.70 x 8.00 x 12.08
V91340 ■ 33.30 x 7.95 x 91.20	

BM360 Fibre Composite	DM360		HBS043 ⊕ M11x1.50x95mm (x10)	JC478 ■ PA459 ■ (NBR) JC152 ■ (x4) ⊕ JE904	HL457 ■ [9] (Cork) HM5053 ■ [10] (ACM)	HR569 ■	NA5001 32.00x47.00x10.00mm FPM

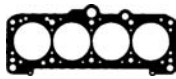

BM360

[9] Centering Diameter [mm]: 8.5
[10] Centering Diameter [mm]: 6.5

[9] Zentrierdurchmesser [mm]: 8.5
[10] Zentrierdurchmesser [mm]: 6.5

338



81.00

Petrol



AAM 4 Cyl. 9:1 1781cc 55kW (75)PS TD4004 895

GOLF 11/91→06/02 PASSAT 08/90→05/97 VENTO 11/91→09/98

TB108 121x18 →07/94 TB463 07/94→	TBK016 →07/94 TBK086 07/94→		FOL143 (x8)

	OE	MAT.				
V91338	035 109 601K		45°			VAG92061B
38.10 x 7.97 x 91.90 Eng.→408197/001108						36.70 x 8.00 x 12.08 Eng.→408198/001108
V94450	048 109 601E		45°	Y	H	VAG96041B
37.80 x 7.00 x 91.80 Eng.408198/001109→						36.50 x 7.00 x 12.08 Eng.408198/001109→
V91340	053 109 611		45°		H	
33.30 x 7.95 x 91.20 Eng.→408197/001108						
V94080	048 109 611B		45°		H	
32.80 x 7.00 x 91.20 Eng.408198/001109→						

BM360 Fibre Composite →Eng.AAM 408 197 BZ910 MLS Eng.AAM 408 198→	DM367 →Eng.AAM 408 197 DZ910 Eng.AAM 408 198→	HBS043 M11x1.50x95mm (x10)	JC478 →Eng.AAM 408 197 PA459 (NBR) →Eng.AAM 408 197 JD5235 Eng.AAM 408 198→ JC152 (x4) 	JP024 Eng.AAM 408 198→ HL457 [9] (Cork) →Eng.AAM 408 197 HM5053 [10] (ACM) →Eng.AAM 408 197	HR363 →Eng.AAM 408 197 HR816 Eng.AAM 408 198→	NA5001 32.00x47.00x10.00mm FPM

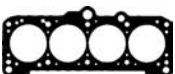

BM360



BZ910

[9] Centering Diameter [mm]: 8.5

[9] Zentrierdurchmessers [mm]: 8.5

[10] Centering Diameter [mm]: 6.5

[10] Zentrierdurchmessers [mm]: 6.5

339



81.00

Petrol



ABS	4 Cyl.	10:1	1781cc	66kW (89)PS		TD3576	896
ABS	4 Cyl.	10:1	1781cc	66kW (89)PS		TD4975	896
CORDOBA	02/93→06/99				GOLF	11/91→04/99	
PASSAT	02/88→05/97				POLO	01/97→09/01	
VENTO	11/91→09/98				IBIZA	03/93→08/99	
					TOLEDO	11/93→12/96	

TB108 121x18 →07/94 TB463 07/94→	TBK016 →07/94 TBK086 07/94→			FOL143 (x8)

V91338 ■ 38.10 x 7.97 x 91.90	V91340 ■ 33.30 x 7.95 x 91.20	VAG92061B ■ ■ ■ 36.70 x 8.00 x 12.08
OE	MAT.	
035 109 601K	45°	
053 109 611	45°	H

BM360 Fibre Composite →Eng.935 645 BZ910 MLS Eng.935 646→	DM367 →Eng.935 645 DZ910 Eng.935 646→	HBS043 ⊕ M11x1.50x95mm (x10)	JC478 ■ →Eng.935 645 PA459 ■ (NBR) →Eng.935 645 JD5232 ■ Eng.935 646→ JC152 ■ (x4) ⊕ JE5076	JP024 Eng.935 646→ HL457 ■ [9] (Cork) →Eng.935 645 HM5053 ■ [10] (ACM) →Eng.935 645	HR569 ■ →Eng.935 645 HR816 ■ Eng.935 646→	NA5001 32.00x47.00x10.00mm FPM

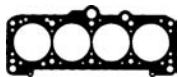

BM360

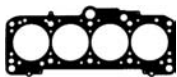

BZ910

[9] Centering Diameter [mm]: 8.5

[9] Zentrierdurchmessers [mm]: 8.5

[10] Centering Diameter [mm]: 6.5

[10] Zentrierdurchmessers [mm]: 6.5

340	81.00	Petrol				
ACC	4 Cyl.	10:1	1781cc	66kW (89)PS	TD18752	897
ACC	4 Cyl.	10:1	1781cc	66kW (89)PS	TD4011	897
CORDOBA	02/93→06/99	GOLF	11/91→09/99	IBIZA	03/93→08/99	
TOLEDO	11/93→12/96					

TB108	TBK016				
121x18					

B x C x D	OE	MAT.	45°	H	Ex F x G
V91338	035 109 601K		45°		VAG92061B
38.10 x 7.97 x 91.90					36.70 x 8.00 x 12.08
V91340	053 109 611		45°	H	
33.30 x 7.95 x 91.20					

BZ910	DZ910		HBS043	JD5235	JP024	HR816	NA5001
			M11x1.50x95mm (x10)	JD600			32.00x47.00x10.00mm FPM
				JE5076			

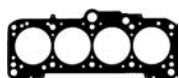

BZ910

341	81.00	Petrol			
ADD	4 Cyl.	1781cc	66kW (89)PS	TD15496	898
POLO	01/97→09/01				

					FOL143 (x8)

B x C x D	OE	MAT.	45°	H	Ex F x G
V91338	035 109 601K		45°		VAG92061B
38.10 x 7.97 x 91.90					36.70 x 8.00 x 12.08
V91340	053 109 611		45°	H	
33.30 x 7.95 x 91.20					

BZ910	DZ910		HBS043	JD5235	JP024	HR599	NA5001
			M11x1.50x95mm (x10)	JC152 (x4)		HR816	32.00x47.00x10.00mm FPM
				JF205			

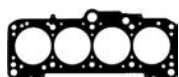

BZ910

342



81.00

Petrol



ADL	4 Cyl.	10.5:1	1781cc	95kW (129)PS	TD3578	898
CORDOBA		10/93→08/96		IBIZA		11/93→08/96

TB505 147x25.4		CAM739 ■ CAM740 ■			FOL143 (x16)

BM360 Fibre Composite	DM365 [14]		HBS028 ⊕ M11x1.50x147mm (x10)	JD281 ■ JD282 ■ (x4)	HL606 ■	HR816 ■ (x2)	NA5001 32.00x47.00x10.00mm FPM	

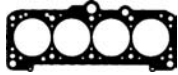

BM360
[14] With shaft oil seal [14] Mit Wellendichtring

343



81.00

Petrol



ADR	4 Cyl.	10.3:1	1781cc	92kW (125)PS	TD20805	899
ADR	4 Cyl.	10.3:1	1781cc	92kW (125)PS	TD241	899
ADR	4 Cyl.	10.3:1	1781cc	92kW (125)PS	TD5557	899
A4	01/95→09/01	A6		12/95→12/97	CABRIOLET	01/97→08/00
PASSAT	10/96→11/00					

TB555 153x25	TBK330 8D-T-155 001→, without tensioner pulley damper TBK331 8D-T-155 001→, with tensioner pulley damper TBK332 →8D-T-155 000, without tensioner pulley damper TBK333 →8D-T-155 000, with tensioner pulley damper				FOL133 ■ (x12) FOL141 ■ (x8)

V94081 ■ 26.90 x 6.00 x 105.10	V94083 ■ 29.90 x 6.00 x 103.90	OE 058 109 601C 058 109 611M	MAT. MB MG cr	45° 45°	Y H	H H	VAG96073B ■ ■ 36.00 x 6.02 x 11.06	

AY970 MLS	CY970		HBS171 ⊕ M11x1.50x101mm (x10) HBS268 ⊕ M10x1.50x120mm (x10)	JD604 ■ JD605 ■ JE689	HL732 ■	PA5041 (x20) 6.00x8.8/12.20x10.00 866N W (FPM)	HR822 ■	NA5001 (x2) 32.00x47.00x10.00mm FPM NA5124 (x2) 32.00x47.00x10.00mm PTFE/ACM



AY970

344







 **81.00**











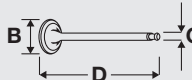

Petrol



















ADZ	4 Cyl.	9:1	1781cc	66kW (89)PS	TD4980	896
ADZ	4 Cyl.	9:1	1781cc	66kW (89)PS	TD9384	896

CORDOBA	02/93→06/99	GOLF	11/91→06/02	IBIZA	03/93→08/99
PASSAT	02/88→05/97	POLO	01/97→09/01	TOLEDO	11/93→12/96
VENTO	11/91→09/98				

					
TB108 121x18 →07/94 TB463 07/94→	TBK016 →07/94 TBK086 07/94→		KIT		FOL92 (x8)

	
B x C x D	E x F x G
OE	
MAT.	
	
	
V91338 	VAG92061B 
38.10 x 7.97 x 91.90 Eng.→408197/001108	36.70 x 8.00 x 12.08 Eng.→408198/001108
V94450 	VAG96041B 
37.80 x 7.00 x 91.80 Eng.408198/001109→	36.50 x 7.00 x 12.08 Eng.408198/001109→
V91340 	
33.30 x 7.95 x 91.20 Eng.→408197/001108	
V94080 	
32.80 x 7.00 x 91.20 Eng.408198/001109→	

							
BM360 Fibre Composite →Eng.011 565 BZ910 MLS Eng.011 566→	DM367 →Eng.011 565 DZ910 Eng.011 566→	HBS043  M11x1.50x95mm (x10)	JC478  →Eng.011 565 PA459  (NBR) →Eng.011 565 JD5235  Eng.011 566→ JD606 	HL457  [9] (Cork) HM5053  [10] (ACM)	HR569  →Eng.011 565 HR816  Eng.011 566→	NA5001 32.00x47.00x10.00mm FPM	

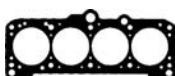

BM360



BZ910

[9] Centering Diameter [mm]: 8.5

[9] Zentrierdurchmessers [mm]: 8.5

[10] Centering Diameter [mm]: 6.5

[10] Zentrierdurchmessers [mm]: 6.5

345



81.00

Petrol



AEB	4 Cyl.	9.5:1	1781cc	110kW (150)PS	Turbo Intercooled	TD4199	900
AEB	4 Cyl.	9.5:1	1781cc	110kW (150)PS	Turbo Intercooled	TD5558	900
A4	01/95→09/01	A6	01/97→01/05	PASSAT	10/96→11/00		

TB464 152x25.4 TB555 153x25	TBK330 8D-T-155 001→, without tensioner pulley damper TBK331 8D-T-155 001→, with tensioner pulley damper TBK332 →8D-T-155 000, without tensioner pulley damper TBK333 →8D-T-155 000, with tensioner pulley damper	CAM743 ■ CAM744 ■			FOL133 ■ (x12) FOL141 ■ (x8)

B x C x D	OE	MAT.	45°	Y	H
V94081 ■ 26.90 x 6.00 x 105.10 V94082 ■ 29.90 x 6.00 x 103.90	058 109 601C 058 109 611E	 MB MG cr	45°	ss	H
					VAG96073B ■ ■ ■ 36.00 x 6.02 x 11.06

AY970 MLS	CY970		HBS171 ⊕ M11x1.50x101mm (x10) HBS268 ⊗ M10x1.50x120mm (x10)	JD604 ■ JD605 ■ ⊕ JE689	HL732 ■	PA5041 (x20) 6.00x8.8/12.20x10.00 866N W (FPM) HR822 ■	NA5001 (x2) 32.00x47.00x10.00mm FPM NA5124 (x2) 32.00x47.00x10.00mm PTFE/ACM



AY970

346

81.00

Petrol



AFY	4 Cyl.	1781cc	85kW (115)PS	TD13948	901
AFY	4 Cyl.	1781cc	85kW (115)PS	TD16244	901
A4	04/95→09/01	A6	05/97→01/05	PASSAT	01/97→11/00

TB464 152x25.4 TB555 153x25	TBK330 8D-T-155 001→, without tensioner pulley damper TBK331 8D-T-155 001→, with tensioner pulley damper TBK332 →8D-T-155 000, without tensioner pulley damper TBK333 →8D-T-155 000, with tensioner pulley damper				FOL133 (x12) FOL141 (x8)

V94081 26.90 x 6.00 x 105.10 V94083 29.90 x 6.00 x 103.90	VAG96073B 36.00 x 6.02 x 11.06
OE: 058 109 601C MAT: MB, MG cr Angle: 45° Material: Y, H	

AY970 MLS	CY970		HBS171 M11x1.50x101mm (x10) HBS268 M10x1.50x120mm (x10)	JD604 JD605 JE689	HL732	PA5041 (x20) 6.00x8.8/12.20x10.00 866N W (FPM) HR822	NA5001 (x2) 32.00x47.00x10.00mm FPM NA5124 (x2) 32.00x47.00x10.00mm PTFE/ACM



AY970

347

81.00
Petrol

AGN	4 Cyl.	10.3:1	1781cc	92kW (125)PS	TD12510	902
AGN	4 Cyl.	10.3:1	1781cc	92kW (125)PS	TD17903	902
AGN	4 Cyl.	10.3:1	1781cc	92kW (125)PS	TD5073	902
AGN	4 Cyl.	10.3:1	1781cc	92kW (125)PS	TD9363	902

A3	09/96→05/03	BORA	10/98→05/05	GOLF	08/97→06/06
LEON	11/99→06/06	OCTAVIA	09/96→07/00	TOLEDO	04/99→05/06

TB554 150x23	TBK101 with tensioner pulley damper, Tens guide 34 TBK115 with tensioner pulley damper, Tens guide 36		KIT		FOL133 ■ (x12) FOL141 ■ (x8)

B x C x D	OE	MAT.
V94081 ■ 26.90 x 6.00 x 105.10	058 109 601C	45° Y H
V94083 ■ 29.90 x 6.00 x 103.90	058 109 611M	45° H
		VAG96073B ■ ■ ■ 36.00 x 6.02 x 11.06

AY970 MLS	CY971	HBS268 ☉ M10x1.50x120mm (x10)	JD607 ■ JD605 ■ ☉ JF205	HL732 ■	PA5041 (x20) 6.00x8.8/12.20x10.00 866N W (FPM) HR822 ■	NA5124 (x2) 32.00x47.00x10.00mm PTFE/ACM







AY970









348

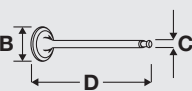







81.00
Petrol

AGU	4 Cyl.	9.5:1	1781cc	110kW (150)PS	Turbo Intercooled	TD13396	903
AGU	4 Cyl.	9.5:1	1781cc	110kW (150)PS	Turbo Intercooled	TD5075	903
AGU	4 Cyl.	9.5:1	1781cc	110kW (150)PS	Turbo Intercooled	TD9456	903

A3	12/96→05/03	BORA	05/00→05/05	GOLF	08/97→06/06
NEW BEETLE	10/99→	OCTAVIA	08/97→12/10		

					
TB554 150x23	TBK101 with tensioner pulley damper, Tens guide 34 TBK115 with tensioner pulley damper, Tens guide 36	CAM743 ■ CAM744 ■			FOL133 ■ (x12) FOL141 ■ (x8)

						
B x C x D	OE	MAT.	45°	Y	H	E x F x G
V94081 ■ 26.90 x 6.00 x 105.10	058 109 601C		45°	Y	H	VAG96073B ■ ■ ■ 36.00 x 6.02 x 11.06
V94082 ■ 29.90 x 6.00 x 103.90	058 109 611E		45°	ss	H	

							
AY970 MLS	CY971		HBS171 ⊕ M11x1.50x101mm (x10) HBS268 ⊕ M10x1.50x120mm (x10)	JD604 ■ JD605 ■ ⊕ JF205	HL732 ■	PA5041 (x20) 6.00x8.8/12.20x10.00 866N W (FPM) HR822 ■	NA5001 32.00x47.00x10.00mm FPM NA5124 (x2) 32.00x47.00x10.00mm PTFE/ACM

AY970

349



81.00

Petrol



AJH	4 Cyl.	9.5:1	1781cc	110kW (150)PS	Turbo Intercooled	TD10887	904
AJH	4 Cyl.	9.5:1	1781cc	110kW (150)PS	Turbo Intercooled	TD17899	904
AWC	4 Cyl.	9.5:1	1781cc	110kW (150)PS	Turbo Intercooled	TD14909	903
AWC	4 Cyl.	9.5:1	1781cc	110kW (150)PS	Turbo Intercooled	TD14914	903

ALHAMBRA	10/97→03/10	SHARAN	09/97→03/10
----------	-------------	--------	-------------



TB554 150x23	TBK101 →02/00, with tensioner pulley damper, Tens guide 34 TBK115 03/00→, with tensioner pulley damper, Tens guide 36	CAM743 ■ CAM744 ■			FOL133 ■ (x12) FOL141 ■ (x8)







B x C x D	OE	MAT.	45°	Y	H
V94081 ■ 26.90 x 6.00 x 105.10	058 109 601C		45°	Y	H
V94082 ■ 29.90 x 6.00 x 103.90	058 109 611E		45°	ss	H
					VAG96073B ■ ■ ■ 36.00 x 6.02 x 11.06







AY970 MLS	CY971		HBS268 ☼ M10x1.50x120mm (x10)	JD604 ■ JD605 ■ JF205	HL732 ■	PA5041 (x20) 6.00x8.8/12.20x10.00 866N W (FPM) HR822 ■	NA5001 32.00x47.00x10.00mm FPM NA5124 32.00x47.00x10.00mm PTFE/ACM



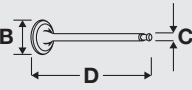



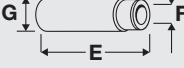



AY970

350	 81.00	Petrol				
AJL	4 Cyl.	1781cc	132kW (180)PS	Turbo Intercooled	TD9470	905
A4	12/97→09/01	A6	12/97→01/05			

					
TB464 152x25.4	TBK330 without tensioner pulley damper	CAM743 ■ CAM744 ■	KIT		FOL133 ■ (x12) FOL141 ■ (x8)
TB555 153x25	TBK331 with tensioner pulley damper				

						
B x C x D	OE	MAT.				E x F x G
V94081 ■ 26.90 x 6.00 x 105.10	058 109 601C	 MB	45°	Y	H	VAG96073B ■ ■ ■ 36.00 x 6.02 x 11.06
V94082 ■ 29.90 x 6.00 x 103.90	058 109 611E	 MG cr	45°	ss	H	

							
AY970 MLS	CY970		HBS171 ⊕ M11x1.50x101mm (x10) HBS268 ⊕ M10x1.50x120mm (x10)	JD604 ■ JD605 ■ ⊕ JE689	HL732 ■	PA5041 (x20) 6.00x8.8/12.20x10.00 866N W (FPM) HR822 ■	NA5001 (x2)

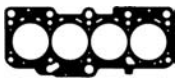

AY970

351



81.00

Petrol



AJP

4 Cyl.

1781cc

92kW (125)PS

TD9518

906

A6

07/97→01/05

TB554 150x23	TBK101 with tensioner pulley damper, Tens guide 34	CAM743 ■ CAM744 ■			FOL133 ■ (x12) FOL141 ■ (x8)

B x C x D	E x F x G
OE	
MAT.	
V94081 ■ 26.90 x 6.00 x 105.10	45° Y H
V94083 ■ 29.90 x 6.00 x 103.90	45° H

AY970 MLS	CY970		HBS268 ☒ M10x1.50x120mm (x10)	JD604 ■ JD6005 ■ Steel 1.00mm JD605 ■ 	HL732 ■	PA5041 (x20) 6.00x8.8/12.20x10.00 866N W (FPM) HR822 ■	NA5124 32.00x47.00x10.00mm PTFE/ACM

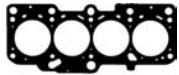











AY970









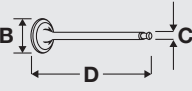

352



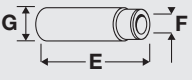

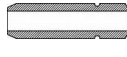











81.00
Petrol

AJQ	4 Cyl.	9.5:1	1781cc	132kW (180)PS	Turbo Intercooled	TD11347	905
AJQ	4 Cyl.	9.5:1	1781cc	132kW (180)PS	Turbo Intercooled	TD16199	905
APP	4 Cyl.	9.5:1	1781cc	132kW (180)PS	Turbo Intercooled	TD11591	905
APP	4 Cyl.	9.5:1	1781cc	132kW (180)PS	Turbo Intercooled	TD13270	905
ARX	4 Cyl.	9.5:1	1781cc	110kW (150)PS	Turbo Intercooled	TD15485	914
ARX	4 Cyl.	9.5:1	1781cc	110kW (150)PS	Turbo Intercooled	TD15988	914
ARX	4 Cyl.	9.5:1	1781cc	110kW (150)PS	Turbo Intercooled	TD16069	914

A3	12/96→05/03	BORA	05/00→05/05	LEON	11/99→06/06
OCTAVIA	08/97→12/10	TOLEDO	05/01→05/06	TT	10/98→06/06

					
TB554 150x23	TBK101 with tensioner pulley damper, Tens guide 34 TBK115 with tensioner pulley damper, Tens guide 36	CAM743  CAM744 			FOL133  (x12) FOL141  (x8)

							
B x C x D	OE	MAT.				E x F x G	
V94081  26.90 x 6.00 x 105.10	058 109 601C	 MB	45°	Y	H	VAG96073B   36.00 x 6.02 x 11.06	
V94082  29.90 x 6.00 x 103.90	058 109 611E	 MG cr	45°	ss	H		

							
AY970  MLS	CY971		HBS268  M10x1.50x120mm (x10)	JD604  JD605  JF205 	HL732 	PA5041 (x20) 6.00x8.8/12.20x10.00 866N W (FPM) HR822 	NA5001 32.00x47.00x10.00mm FPM NA5124 (x2) 32.00x47.00x10.00mm PTFE/ACM

AY970

353

81.00

Petrol



AMB 4 Cyl. 1781cc 125kW (170)PS Turbo Intercooled TD17864

A4 05/00 → 10/05

TB554 150x23	TBK341 with tensioner pulley damper	CAM744	KIT		FOL133 (x12) FOL141 (x8)

AY970 MLS	CY971		HBS268 M10x1.50x120mm (x10)	JD604 → Eng.8E-3-500 000 JD605 JD5813 Eng.8E-4-000 001 →	HL732	PA5041 (x20) 6.00x8.8/12.20x10.00 866N W (FPM) HR822	NA5124 (x2) 32.00x47.00x10.00mm PTFE/ACM

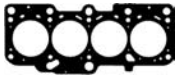

AY970

354

81.00

Petrol



AMK 4 Cyl. 9:1 1781cc 154kW (210)PS Turbo Intercooled TD12648 **907**

AMK 4 Cyl. 9:1 1781cc 154kW (210)PS Turbo Intercooled TD16436 **907**

A3 03/99 → 04/02 LEON 02/02 → 06/06



TB554 150x23	TBK115 with tensioner pulley damper, Tens guide 36	CAM744	KIT		FOL133 (x12) FOL141 (x8)







 B x C x D	OE	MAT.	 45°	 Y	 H	 E x F x G	 VAG96073B 36.00 x 6.02 x 11.06
V94081 26.90 x 6.00 x 105.10	058 109 601C	 MB	45°	Y	H		
V94082 29.90 x 6.00 x 103.90	058 109 611E	 MG cr	45°	ss	H		















AY970 MLS	CY971		HBS268 M10x1.50x120mm (x10)	JD604 JD6005 Steel 1.00mm JD605 JF205	HL732	PA5041 (x20) 6.00x8.8/12.20x10.00 866N W (FPM) HR822	NA5001 32.00x47.00x10.00mm FPM NA5124 (x2) 32.00x47.00x10.00mm PTFE/ACM



AY970



355	 81.00	Petrol					
AMU	4 Cyl.	1781cc	165kW (224)PS	Turbo Intercooled	TD15358	907	
ATC	4 Cyl.	1781cc	132kW (180)PS	Turbo Intercooled	TD15357		
TT	10/98→06/06						



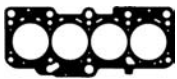







					
TB554 150x23	TBK101 with tensioner pulley damper, Tens guide 34 TBK115 with tensioner pulley damper, Tens guide 36		KIT		









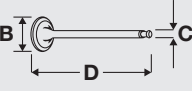

							
AY970 MLS	CY971		HBS268  M10x1.50x120mm (x10)	JD604  JD605  JF205 	HL732 	PA5041 (x20) 6.00x8.8/12.20x10.00 866N W (FPM) HR822 	NA5001 32.00x47.00x10.00mm FPM NA5124 (x2) 32.00x47.00x10.00mm PTFE/ACM



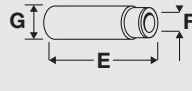

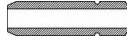











AY970

356	 81.00	Petrol					
ANB	4 Cyl.	9.5:1	1781cc	110kW (150)PS	Turbo Intercooled	TD13949	908
ANB	4 Cyl.	9.5:1	1781cc	110kW (150)PS	Turbo Intercooled	TD16256	908
APU	4 Cyl.	9.5:1	1781cc	110kW (150)PS	Turbo Intercooled	TD13950	908
APU	4 Cyl.	9.5:1	1781cc	110kW (150)PS	Turbo Intercooled	TD16257	908
A4	01/95→09/01		A6	01/97→01/05	PASSAT	10/96→11/00	

					
TB555 153x25	TBK330 153 without tensioner pulley damper TBK331 with tensioner pulley damper	CAM743  CAM744 			FOL133  (x12) FOL141  (x8)

				
B x C x D	OE	MAT.		E x F x G
V94081  26.90 x 6.00 x 105.10	058 109 601C	 MB	45° Y H	VAG96073B   36.00 x 6.02 x 11.06
V94082  29.90 x 6.00 x 103.90	058 109 611E	 MG cr	45° ss H	

							
AY970 MLS	CY970		HBS171  M11x1.50x101mm (x10) HBS268  M10x1.50x120mm (x10)	JD604  JD605  JE689 	HL732 	PA5041 (x20) 6.00x8.8/12.20x10.00 866N W (FPM) HR822 	NA5124 (x2) 32.00x47.00x10.00mm PTFE/ACM



AY970

VW GROUP

357



81.00

Petrol



ANN 4 Cyl. 9:1 1781cc 55kW (75)PS TD10847 909

GOLF 07/93→06/02

TB108 121x18	TBK016				

B x C x D	OE	MAT.	45°	Y	H
V94450 ■ 37.80 x 7.00 x 91.80	048 109 601E		45°	Y	H
V94080 ■ 32.80 x 7.00 x 91.20	048 109 611B		45°		H
		MG			

BZ910 MLS	DZ910			JD5235 ■ JD600 ■ JE5076	JP024	HR816 ■	NA5001 32.00x47.00x10.00mm FPM



BZ910

358



81.00

Petrol



ANP 4 Cyl. 9:1 1781cc 66kW (89)PS TD10848 909

GOLF 07/93→06/02

TB108 121x18	TBK016				

B x C x D	OE	MAT.	45°	Y	H
V94450 ■ 37.80 x 7.00 x 91.80	048 109 601E		45°	Y	H
V94080 ■ 32.80 x 7.00 x 91.20	048 109 611B		45°		H
		MG			

BZ910 MLS	DZ910		HBS043 ⊙ M11x1.50x95mm (x10)	JC478 ■ JD5235 ■ JC152 ■ (x4) JE5076	JP024	HR816 ■	NA5001 32.00x47.00x10.00mm FPM

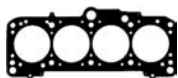

BZ910

359	81.00	Petrol			
ANQ	4 Cyl.	10.3:1	1781cc	92kW (125)PS	TD19190
A6	07/97→01/05				

TB554 150x23	TBK101 with tensioner pulley damper, Tens guide 34						
AY970 MLS	CY971		HBS268 M10x1.50x120mm (x10)	JD604 JD605 JE689	HL732	PA5041 (x20) 6.00x8.8/12.20x10.00 866N W (FPM) HR822	NA5001 (x2) 32.00x47.00x10.00mm FPM NA5124 (x2) 32.00x47.00x10.00mm PTFE/ACM



360	81.00	Petrol				
APG	4 Cyl.	10.3:1	1781cc	92kW (125)PS	TD11589	910
APG	4 Cyl.	10.3:1	1781cc	92kW (125)PS	TD15530	910
A3	09/96→05/03		LEON	11/99→06/06	TOLEDO	04/99→05/06

TB554 150x23	TBK101 with tensioner pulley damper, Tens guide 34 TBK115 with tensioner pulley damper, Tens guide 36						FOL133 (x12) FOL141 (x8)
V94081 26.90 x 6.00 x 105.10	OE 058 109 601C	MAT. MB	45°	Y	H	VAG96073B 36.00 x 6.02 x 11.06	
V94083 29.90 x 6.00 x 103.90	058 109 611M	MG cr	45°		H		

AY970 MLS			HBS268 M10x1.50x120mm (x10)	JD607 JD605 JF205	HL732	PA5041 (x20) 6.00x8.8/12.20x10.00 866N W (FPM) HR822	NA5124 (x2) 32.00x47.00x10.00mm PTFE/ACM



AY970

361

81.00

Petrol



APH	4 Cyl.		1781cc	110kW (150)PS	Turbo Intercooled	TD13441	911
APX	4 Cyl.	8.9:1	1781cc	121/162kW (165/221)PS	Turbo Intercooled	TD11349	907
AUQ	4 Cyl.	9.5:1	1781cc	132kW (180)PS	Turbo Intercooled	TD15353	916
AUQ	4 Cyl.	9.5:1	1781cc	132kW (180)PS	Turbo Intercooled	TD16135	916
AUQ	4 Cyl.	9.5:1	1781cc	132kW (180)PS	Turbo Intercooled	TD16279	916
AUQ	4 Cyl.	9.5:1	1781cc	132kW (180)PS	Turbo Intercooled	TD16420	916
AVC	4 Cyl.	9.5:1	1781cc	110kW (150)PS	Turbo Intercooled	TD15467	917

A3	12/98→05/03	BORA	03/02→05/05	GOLF	08/01→06/05
LEON	11/99→06/06	NEW BEETLE	10/99→	OCTAVIA	05/01→01/06
TOLEDO	05/01→05/06	TT	10/98→06/06		

TB554 150x23	TBK101 with tensioner pulley damper, Tens guide 34 TBK115 with tensioner pulley damper, Tens guide 36	CAM743 ■ CAM744 ■	KIT		FOL133 ■ (x12) FOL141 ■ (x8)









V94081 ■ 26.90 x 6.00 x 105.10	V94082 ■ 29.90 x 6.00 x 103.90	VAG96073B ■ ■ ■ 36.00 x 6.02 x 11.06
OE	MAT.	
058 109 601C	MB	45° Y H
058 109 611E	MG cr	45° ss H





AY970 MLS	CY971		HBS268 ☉ M10x1.50x120mm (x10)	JD604 ■ JD605 ■	HL732 ■	PA5041 (x20) 6.00x8.8/12.20x10.00 866N W (FPM) HR822 ■	NA5001 32.00x47.00x10.00mm FPM NA5124 (x2) 32.00x47.00x10.00mm PTFE/ACM





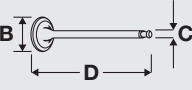
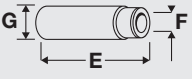

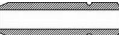











AY970

362	 81.00	Petrol				
APT	4 Cyl.	10.3:1	1781cc	92kW (125)PS	TD11497	902
APT	4 Cyl.	10.3:1	1781cc	92kW (125)PS	TD13775	902
A4	01/95→09/01	PASSAT		10/96→03/05		

					
TB555 153x25	TBK330 153 without tensioner pulley damper TBK331 with tensioner pulley damper		KIT		FOL133  (x12) FOL141  (x8)

	
B x C x D	E x F x G
V94081  26.90 x 6.00 x 105.10	VAG96073B  36.00 x 6.02 x 11.06
V94083  29.90 x 6.00 x 103.90	
OE	MAT.
058 109 601C	45° Y H
058 109 611M	45° H
MB	
MG cr	

							
AY970  MLS	CY970		HBS171  M11x1.50x101mm (x10) HBS268  M10x1.50x120mm (x10)	JD604  JD605  JE689 	HL732 	PA5041 (x20) 6.00x8.8/12.20x10.00 866N W (FPM) HR822 	NA5124 (x2) 32.00x47.00x10.00mm PTFE/ACM

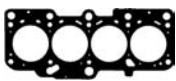

AY970



APY 4 Cyl. 1781cc 154kW (210)PS Turbo Intercooled TD11594 907

A3 03/99 → 04/02



TB554 150x23	TBK101 with tensioner pulley damper, Tens guide 34 TBK115 with tensioner pulley damper, Tens guide 36	CAM743 ■ CAM744 ■			FOL133 ■ (x12) FOL141 ■ (x8)



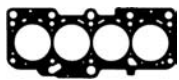



B x C x D	E x F x G
OE	
MAT.	
V94081 ■ 26.90 x 6.00 x 105.10	VAG96073B ■ ■ ■ 36.00 x 6.02 x 11.06
V94082 ■ 29.90 x 6.00 x 103.90	



AY970 MLS	CY971		HBS268 ☼ M10x1.50x120mm (x10)	JD604 ■ JD6005 ■ Steel 1.00mm JD605 ■	HL732 ■	PA5041 (x20) 6.00x8.8/12.20x10.00 866N W (FPM) HR822 ■	NA5001 32.00x47.00x10.00mm FPM NA5124 (x2) 32.00x47.00x10.00mm PTFE/ACM







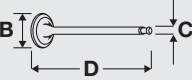
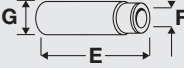



AY970

364	 81.00	Petrol					
AQA	4 Cyl.	9.5:1	1781cc	110kW (150)PS	Turbo Intercooled	TD11592	905
AQA	4 Cyl.	9.5:1	1781cc	110kW (150)PS	Turbo Intercooled	TD22620	905
A3	12/96→05/03		GOLF	08/97→06/06			

					
TB554 150x23	TBK101 with tensioner pulley damper, Tens guide 34 TBK115 with tensioner pulley damper, Tens guide 36	CAM743 ■ CAM744 ■	KIT		FOL133 ■ (x12) FOL141 ■ (x8)

	
B x C x D	E x F x G
OE	
MAT.	
	
V94081 ■ 26.90 x 6.00 x 105.10	VAG96073B ■ ■ 36.00 x 6.02 x 11.06
058 109 601C	
V94082 ■ 29.90 x 6.00 x 103.90	
058 109 611E	
MB	
MG cr	
45° Y H	
45° ss H	

							
AY970 MLS	CY971		HBS268 ⊗ M10x1.50x120mm (x10)	JD604 ■ JD6005 ■ Steel 1.00mm JD605 ■ ⊙ JF205	HL732 ■	PA5041 (x20) 6.00x8.8/12.20x10.00 866N W (FPM) HR822 ■	NA5001 32.00x47.00x10.00mm FPM NA5124 (x2) 32.00x47.00x10.00mm PTFE/ACM



AY970

365



81.00

Petrol



AQE

4 Cyl.

1781cc

92kW (125)PS

TD14029

906

A6

07/97→01/05

TB554 150x23	TBK101 with tensioner pulley damper, Tens guide 34				

B x C x D	E x F x G
OE	
MAT.	
V94081 ■	45° Y H
26.90 x 6.00 x 105.10	
V94083 ■	45° H
29.90 x 6.00 x 103.90	

AY970 MLS	CY970			JD604 ■ JD6005 ■ Steel 1.00mm JD605 ■ JE689	HL732 ■	PA5041 (x20) 6.00x8.8/12.20x10.00 866N W (FPM) HR822 ■	NA5124 32.00x47.00x10.00mm PTFE/ACM

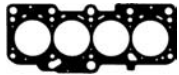

AY970

366

81.00

Petrol



AQX	4 Cyl.	9.5:1	1781cc	115kW (156)PS	Turbo Intercooled	TD13275	912
AYP	4 Cyl.		1781cc	115kW (156)PS	Turbo Intercooled	TD16201	912
CORDOBA	07/00→10/02		IBIZA	07/00→02/02			

TB554 150x23	TBK115 with tensioner pulley damper, Tens guide 36	CAM743 ■ CAM744 ■	KIT		FOL133 ■ (x12) FOL141 ■ (x8)

V94081 ■ 26.90 x 6.00 x 105.10	V94082 ■ 29.90 x 6.00 x 103.90	OE 058 109 601C 058 109 611E	MAT. MB MG cr	45° 45°	Y ss	H H
			VAG96073B ■ ■ ■ 36.00 x 6.02 x 11.06			

AY970 MLS	CY971		HBS268 ⊗ M10x1.50x120mm (x10)	JD604 ■ JD605 ■	HL732 ■	PA5041 (x20) 6.00x8.8/12.20x10.00 866N W (FPM) HR822 ■	NA5001 (x2) 32.00x47.00x10.00mm FPM NA5124 (x2) 32.00x47.00x10.00mm PTFE/ACM



AY970

367



81.00

Petrol



ARG	4 Cyl.	1781cc	92kW (125)PS	TD13776	902
ARG	4 Cyl.	1781cc	92kW (125)PS	TD16237	902
A4	01/95→09/01	PASSAT	10/96→11/00		

TB555 153x25	TBK330 without tensioner pulley damper TBK331 with tensioner pulley damper				FOL133 ■ (x12) FOL141 ■ (x8)

B x C x D	E x F x G
V94081 ■ 26.90 x 6.00 x 105.10	VAG96073B ■ ■ ■ 36.00 x 6.02 x 11.06
V94083 ■ 29.90 x 6.00 x 103.90	
OE: 058 109 601C	
MAT. MB	
MAT. MG cr	
45° Y H	
45° H	

AY970 MLS	CY970		HBS171 ⊕ M11x1.50x101mm (x10) HBS268 ⊗ M10x1.50x120mm (x10)	JD604 ■ JD605 ■ ⊕ JE689	HL732 ■	PA5041 (x20) 6.00x8.8/12.20x10.00 866N W (FPM) HR822 ■	NA5124 (x2) 32.00x47.00x10.00mm PTFE/ACM

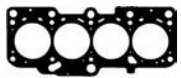

AY970

368









 **81.00**









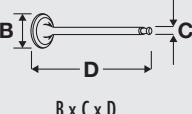
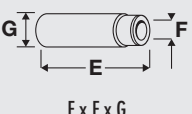

Petrol

















ARH 4 Cyl. 1781cc 92kW (125)PS **TD15329** **906**

A6 07/97→01/05

					
TB554 150x23	TBK101 with tensioner pulley damper, Tens guide 34		KIT		FOL133  (x12) FOL141  (x8)

	
B x C x D	E x F x G
<p>V94081  058 109 601C  MAT.  45°  Y  H</p> <p>V94083  058 109 611M  MG cr 45° H</p> <p>26.90 x 6.00 x 105.10</p> <p>29.90 x 6.00 x 103.90</p>	<p>VAG96073B   </p>

							
AY970 <small>MLS</small>	CY970		HBS268  M10x1.50x120mm (x10)	JD604  JD6005  Steel 1.00mm JD605   JE689	HL732 	PA5041 (x20) 6.00x8.8/12.20x10.00 866N W (FPM) HR822 	NA5124 32.00x47.00x10.00mm PTFE/ACM



AY970



ARK	4 Cyl.	1781cc	110kW (150)PS	Turbo Intercooled	TD13929	913
A4	01/95→09/01	A6	01/97→01/05			



TB555 153x25	TBK330 153 without tensioner pulley damper TBK331 with tensioner pulley damper	CAM743 ■ CAM744 ■			FOL133 ■ (x12) FOL141 ■ (x8)







B x C x D	OE	MAT.	45°	Y	H
V94081 ■ 26.90 x 6.00 x 105.10	058 109 601C	 MB	45°	Y	H
V94082 ■ 29.90 x 6.00 x 103.90	058 109 611E	 MG cr	45°	ss	H
				VAG96073B ■ ■ 36.00 x 6.02 x 11.06	









AY970 MLS	CY970		HBS268 ☒ M10x1.50x120mm (x10)	JD604 ■ JD605 ■ JE5075	HL732 ■	PA5041 (x20) 6.00x8.8/12.20x10.00 866N W (FPM) HR822 ■	NA5001 32.00x47.00x10.00mm FPM

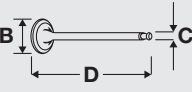







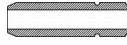

AY970

370	 81.00	Petrol					
ARY	4 Cyl.	9.5:1	1781cc	132kW (180)PS	Turbo Intercooled	TD15352	915
ARY	4 Cyl.	9.5:1	1781cc	132kW (180)PS	Turbo Intercooled	TD16136	915
A3	10/98→05/03	LEON	11/99→06/06	TT	10/98→06/06		

					
TB554 150x23		CAM743 ■ CAM744 ■	KIT		FOL133 ■ (x12) FOL141 ■ (x8)

						
B x C x D	OE	MAT.	45°	Y	H	E x F x G
V94081 ■ 26.90 x 6.00 x 105.10	058 109 601C	 MB	45°	Y	H	VAG96073B ■ ■ ■ 36.00 x 6.02 x 11.06
V94082 ■ 29.90 x 6.00 x 103.90	058 109 611E	 MG cr	45°	ss	H	

							
AY970 MLS	CY971		HBS268 ☒ M10x1.50x120mm (x10)	JD604 ■ JD605 ■ JF205	HL732 ■	PA5041 (x20) 6.00x8.8/12.20x10.00 866N W (FPM) HR822 ■	NA5001 32.00x47.00x10.00mm FPM NA5124 (x2) 32.00x47.00x10.00mm PTFE/ACM



AY970

371



81.00

Petrol



ARZ	4 Cyl.	9.5:1	1781cc	110kW (150)PS	Turbo Intercooled	TD11593	903
ARZ	4 Cyl.	9.5:1	1781cc	110kW (150)PS	Turbo Intercooled	TD16030	903
ARZ	4 Cyl.	9.5:1	1781cc	110kW (150)PS	Turbo Intercooled	TD16385	903

A3	12/96→05/03	GOLF	08/97→06/06	OCTAVIA	08/97→12/10
----	-------------	------	-------------	---------	-------------

TB554 150x23	TBK101 with tensioner pulley damper, Tens guide 34 TBK115 with tensioner pulley damper, Tens guide 36	CAM743 ■ CAM744 ■			FOL133 ■ (x12) FOL141 ■ (x8)

B x C x D	E x F x G
V94081 ■ 26.90 x 6.00 x 105.10	VAG96073B ■ ■ ■ 36.00 x 6.02 x 11.06
V94082 ■ 29.90 x 6.00 x 103.90	
OE: 058 109 601C	MAT.:
058 109 611E	45° Y H
	45° ss H

AY970 MLS	CY971		HBS268 ☒ M10x1.50x120mm (x10)	JD604 ■ JD6005 ■ Steel 1.00mm JD605 ■ ☒ JF205	HL732 ■	PA5041 (x20) 6.00x8.8/12.20x10.00 866N W (FPM) HR822 ■	NA5001 32.00x47.00x10.00mm FPM NA5124 (x2) 32.00x47.00x10.00mm PTFE/ACM

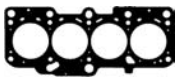

AY970

372







 81.00







Petrol



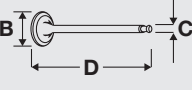



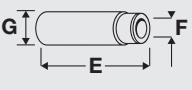



AUL 4 Cyl. 1781cc 154kW (210)PS Turbo Intercooled TD15355 907

A3 03/99→04/02

					
TB554 150x23	TBK101 with tensioner pulley damper, Tens guide 34 TBK115 with tensioner pulley damper, Tens guide 36	CAM743 ■ CAM744 ■			FOL133 ■ (x12) FOL141 ■ (x8)

						
B x C x D	OE	MAT.				E x F x G
V94081 ■ 26.90 x 6.00 x 105.10	058 109 601C	 MB	45°	Y	H	VAG96073B ■ ■ ■ 36.00 x 6.02 x 11.06
V94082 ■ 29.90 x 6.00 x 103.90	058 109 611E	 MG cr	45°	ss	H	

							
AY970 MLS	CY971		HBS268 ☼ M10x1.50x120mm (x10)	JD604 ■ JD605 ■	HL732 ■	PA5041 (x20) 6.00x8.8/12.20x10.00 866N W (FPM) HR822 ■	NA5124 (x2) 32.00x47.00x10.00mm PTFE/ACM



AY970

373



81.00

Petrol



AUM	4 Cyl.	9.5:1	1781cc	110kW (150)PS	Turbo Intercooled	TD15486	916
AUM	4 Cyl.	9.5:1	1781cc	110kW (150)PS	Turbo Intercooled	TD15629	916
AUM	4 Cyl.	9.5:1	1781cc	110kW (150)PS	Turbo Intercooled	TD16070	916

A3	12/96→05/03	BORA	05/00→05/05	GOLF	08/97→06/06
OCTAVIA	08/97→12/10	TT	01/01→06/06		

TB554 150x23	TBK101 with tensioner pulley damper, Tens guide 34 TBK115 with tensioner pulley damper, Tens guide 36	CAM744			FOL133 (x12) FOL141 (x8)

B x C x D	E x F x G
V94081 26.90 x 6.00 x 105.10	VAG96073B 36.00 x 6.02 x 11.06
V94082 29.90 x 6.00 x 103.90	

AY970 MLS	CY971		HBS268 M10x1.50x120mm (x10)	JD604 JD605 JF205	HL732	PA5041 (x20) 6.00x8.8/12.20x10.00 866N W (FPM) HR822	NA5001 32.00x47.00x10.00mm FPM NA5124 32.00x47.00x10.00mm PTFE/ACM



AY970

374	81.00	Petrol						
AVJ	4 Cyl.	9.3:1	1781cc	110kW (150)PS	Turbo Intercooled	TD15349	918	
A4 11/00→07/02								

TB554 150x23	TBK341 with tensioner pulley damper	CAM744			FOL133 (x12) FOL141 (x8)

B x C x D	OE	MAT.	45° Y H	E x F x G	
V94081 26.90 x 6.00 x 105.10	058 109 601C	 MB	45° Y H	VAG96073B 36.00 x 6.02 x 11.06	
V94083 29.90 x 6.00 x 103.90	058 109 611M	 MG cr	45° H		

AY970 MLS	CY971		HBS268 M10x1.50x120mm (x10)	JD604 JD605 JE689	HL732	PA5041 (x20) 6.00x8.8/12.20x10.00 866N W (FPM) HR822	NA5001 32.00x47.00x10.00mm FPM NA5124 (x2) 32.00x47.00x10.00mm PTFE/ACM



AY970

375	81.00	Petrol						
AVV	4 Cyl.		1781cc	92kW (125)PS				TD16412 919
A4 01/95→09/01								

					FOL133 (x12) FOL141 (x8)



B x C x D	OE	MAT.	45° Y H	E x F x G	
V94081 26.90 x 6.00 x 105.10	058 109 601C	 MB	45° Y H	VAG96073B 36.00 x 6.02 x 11.06	
V94083 29.90 x 6.00 x 103.90	058 109 611M	 MG cr	45° H		

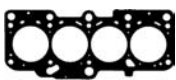





AY970 MLS	CY970		HBS268 M10x1.50x120mm (x10)	JD605 JE689	HL732	PA5041 (x20) 6.00x8.8/12.20x10.00 866N W (FPM)	NA5124 (x2) 32.00x47.00x10.00mm PTFE/ACM











AY970

VW GROUP



376	 81.00	Petrol				
AWL	4 Cyl.	9.5:1	1781cc	110kW (150)PS	Turbo Intercooled	TD19134
AWL	4 Cyl.	9.5:1	1781cc	110kW (150)PS	Turbo Intercooled	TD19192 921
A6	01/97→01/05	PASSAT		11/00→05/05		



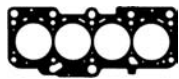



					
TB554 150x23	TBK101 →05/01, with tensioner pulley damper, Tens guide 34 TBK341 06/01→, with tensioner pulley damper		KIT		









							
AY970 MLS	CY971		HBS268 ☒ M10x1.50x120mm (x10)	JD604 ■ JD605 ■  JF205	HL732 ■	PA5041 (x20) 6.00x8.8/12.20x10.00 866N W (FPM) HR822 ■	NA5001 32.00x47.00x10.00mm FPM NA5124 (x2) 32.00x47.00x10.00mm PTFE/ACM



AY970

377	 81.00	Petrol			
AWM	4 Cyl.	1781cc	125kW (170)PS	Turbo Intercooled	TD16423
PASSAT	02/01→08/05				

					
TB554 150x23	TBK341 with tensioner pulley damper	CAM744 ■			FOL133 ■ (x12) FOL141 ■ (x8)

							
AY970 MLS	CY971		HBS268 ☒ M10x1.50x120mm (x10)	JD604 ■ JD605 ■	HL732 ■	PA5041 (x20) 6.00x8.8/12.20x10.00 866N W (FPM) HR822 ■	NA5124 (x2) 32.00x47.00x10.00mm PTFE/ACM

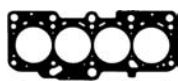

AY970

378









 81.00







Petrol



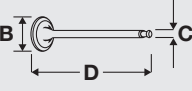
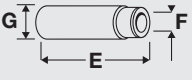

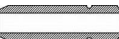









AWP	4 Cyl.	9.5:1	1781cc	132kW (180)PS	Turbo Intercooled	TD15356	921
AWP	4 Cyl.	9.5:1	1781cc	132kW (180)PS	Turbo Intercooled	TD19253	
AWU	4 Cyl.		1781cc	110kW (150)PS	Turbo Intercooled	TD15468	922
BKF	4 Cyl.	9.5:1	1781cc	110kW (150)PS	Turbo Intercooled	TD21071	

NEW BEETLE 10/99→ TT 10/98→06/06

					
TB554 150x23	TBK115 with tensioner pulley damper, Tens guide 36	CAM744 			FOL133  (x12) FOL141  (x8)

			
B x C x D	OE	MAT.	E x F x G
V94081 	058 109 601C	 MB	VAG96073B  
26.90 x 6.00 x 105.10		45° Y H	36.00 x 6.02 x 11.06
V94082 	058 109 611E	 MG cr	
29.90 x 6.00 x 103.90		45° ss H	

							
AY970  MLS	CY971		HBS268 M10x1.50x120mm (x10)	JD604  JD605 	HL732 	PA5041 (x20) 6.00x8.8/12.20x10.00 866N W (FPM) HR822 	NA5001 32.00x47.00x10.00mm FPM NA5124 (x2) 32.00x47.00x10.00mm PTFE/ACM

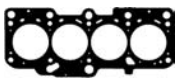

AY970

[13] Engine Block Material: Cast Steel

[13] Motorblockmaterial: Stahlguß

379

81.00
Petrol

AWT	4 Cyl.	9.5:1	1781cc	110kW (150)PS	Turbo Intercooled	TD15149	916
AWT	4 Cyl.	9.5:1	1781cc	110kW (150)PS	Turbo Intercooled	TD15335	916
AWT	4 Cyl.	9.5:1	1781cc	110kW (150)PS	Turbo Intercooled	TD16365	916

A4	01/95→09/01	A6	01/97→01/05	PASSAT	11/00→05/05
SUPERB	12/01→03/08				

TB554 150x23	TBK101 →05/01, with tensioner pulley damper, Tens guide 34 TBK341 06/01→, with tensioner pulley damper	CAM744			FOL133 (x12) FOL141 (x8)

B x C x D	E x F x G
V94081 26.90 x 6.00 x 105.10	VAG96073B 36.00 x 6.02 x 11.06
V94082 29.90 x 6.00 x 103.90	

AY970 MLS	CY971		HBS268 M10x1.50x120mm (x10)	JD604 JD605 JE5075	HL732	PA5041 (x20) 6.00x8.8/12.20x10.00 866N W (FPM) HR822	NA5001 32.00x47.00x10.00mm FPM NA5124 (x2) 32.00x47.00x10.00mm PTFE/ACM

AY970

380	81.00	Petrol				
AWV	4 Cyl.	1781cc	110kW (150)PS	Turbo Intercooled	TD15469	923
NEW BEETLE 10/99→						

TB554 150x23	TBK115 with tensioner pulley damper, Tens guide 36	CAM744	KIT		FOL133 (x12) FOL141 (x8)

B x C x D	OE	MAT.	45°	Y	H
V94081 26.90 x 6.00 x 105.10	058 109 601C		45°	Y	H
V94082 29.90 x 6.00 x 103.90	058 109 611E		45°	ss	H
		MB			
		MG cr			
					VAG96073B 36.00 x 6.02 x 11.06

AY970 <small>MLS</small>	CY971		HBS268 M10x1.50x120mm (x10)	JD604 JD605	HL732	PA5041 (x20) 6.00x8.8/12.20x10.00 866N W (FPM) HR822	NA5001 32.00x47.00x10.00mm FPM NA5124 (x2) 32.00x47.00x10.00mm PTFE/ACM



AY970

381	81.00	Petrol				
BAE	4 Cyl.	1781cc	110kW (150)PS	Turbo Intercooled	TD19140	
BORA 05/00→05/05						

TB554 150x23	TBK101 with tensioner pulley damper, Tens guide 34 TBK115 with tensioner pulley damper, Tens guide 36		KIT		

VW GROUP

382



81.00

Petrol



BAF	4 Cyl.	1781cc	92kW (125)PS	TD19143
BORA	10/98→05/05	GOLF	08/97→06/05	

<p>B x C x D</p>	OE	MAT.		<p>E x F x G</p>
V94081 ■ 26.90 x 6.00 x 105.10 V94082 ■ 29.90 x 6.00 x 103.90	058 109 601C 058 109 611E	MB MG cr	45° Y H 45° ss H	VAG96073B ■ ■ ■ 36.00 x 6.02 x 11.06

AY970 MLS			HBS268 ☒ M10x1.50x120mm (x10)	JD607 ■ (x4) JD605 ■ JF205	HL732 ■	PA5041 (x20) 6.00x8.8/12.20x10.00 866N W (FPM) HR822 ■	NA5124 (x2) 32.00x47.00x10.00mm PTFE/ACM



AY970

383



81.00

Petrol



BAM	4 Cyl.	9:1	1781cc	165kW (224)PS	Turbo Intercooled	TD16331	907
BAM	4 Cyl.	9:1	1781cc	165kW (224)PS	Turbo Intercooled	TD17347	907
A3	10/01→05/03	LEON	07/03→06/06	TT	10/98→06/06		



TB554 150x23	TBK115 with tensioner pulley damper, Tens guide 36	CAM744 ■			FOL133 ■ (x12) FOL141 ■ (x8)	

<p>B x C x D</p>	OE	MAT.		<p>E x F x G</p>
V94081 ■ 26.90 x 6.00 x 105.10 V94082 ■ 29.90 x 6.00 x 103.90	058 109 601C 058 109 611E	MB MG cr	45° Y H 45° ss H	VAG96073B ■ ■ ■ 36.00 x 6.02 x 11.06









AY970 MLS	CY971		HBS268 ☒ M10x1.50x120mm (x10)	JD604 ■ JD605 ■	HL732 ■	PA5041 (x20) 6.00x8.8/12.20x10.00 866N W (FPM) HR822 ■	NA5001 (x2) 32.00x47.00x10.00mm FPM











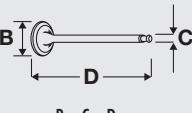



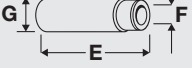











AY970

384	 81.00	Petrol				
BBU	4 Cyl.		1781cc	132kW (180)PS	Turbo Intercooled	TD17365
BBU	4 Cyl.		1781cc	132kW (180)PS	Turbo Intercooled	TD20512
BJX	4 Cyl.	9.5:1	1781cc	110kW (150)PS	Turbo Intercooled	TD17320
BJX	4 Cyl.	9.5:1	1781cc	110kW (150)PS	Turbo Intercooled	TD18799

IBIZA	12/03→05/08	POLO	09/05→11/09
--------------	-------------	-------------	-------------



	 KIT		 KIT		
TB554 150x23		CAM744 			FOL133  (x12) FOL141  (x8)











 B x C x D	OE	MAT.				 E x F x G
V94081  26.90 x 6.00 x 105.10	058 109 601C	 MB	45°	Y	H	VAG96073B   36.00 x 6.02 x 11.06
V94082  29.90 x 6.00 x 103.90	058 109 611E	 MG cr	45°	ss	H	

							
AY970 MLS	CY971		HBS268  M10x1.50x120mm (x10)	JD604  JD605 	HL732 	PA5041 (x20) 6.00x8.8/12.20x10.00 866N W (FPM) HR822 	NA5124 (x2) 32.00x47.00x10.00mm PTFE/ACM



AY970

385	 81.00	Petrol			
BCD	4 Cyl.	10.3:1	1595cc	74kW (100)PS	TD22629

							
				JD5340  (x4) JD5293 	JM5205 (Elastomer)	PA5041 (x8) 6.00x8.8/12.20x10.00 866N W (FPM)	

VW GROUP

386



81.00

Petrol



BEX	4 Cyl.	1781cc	140kW (190)PS	Turbo Intercooled	TD16730	918
BFB	4 Cyl.	1781cc	120kW (163)PS	Turbo Intercooled	TD16728	918

A4 07/02→03/09

TB554 150x23	TBK341 with tensioner pulley damper	CAM744	KIT		FOL133 (x12) FOL141 (x8)
	OE				
V94081 26.90 x 6.00 x 105.10	058 109 601C		45° Y H	VAG96073B 36.00 x 6.02 x 11.06	
V94082 29.90 x 6.00 x 103.90	058 109 611E		45° ss H		

AY970 MLS	CY971 →Ch.8E-3-500 000		HBS268 M10x1.50x120mm (x10)	JD604 →Ch.8E-3-500 000 JD6005 Steel 1.00mm →Ch.8E-3-500 000 JD605 →Ch.8E-3-500 000	HL732	PA5041 (x20) 6.00x8.8/12.20x10.00 866N W (FPM) HR822	NA5124 (x2) 32.00x47.00x10.00mm PTFE/ACM

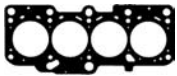

AY970

387



81.00

Petrol





BVF	4 Cyl.	9:1	1781cc	176kW (239)PS	Turbo Intercooled	TD20399
TT 03/05→06/06						

TB554 150x23	TBK115 with tensioner pulley damper, Tens guide 36		KIT				
	OE						
AY970 MLS	CY971		HBS268 M10x1.50x120mm (x10)	JD604 JD605	HL732	PA5041 (x20) 6.00x8.8/12.20x10.00 866N W (FPM) HR822	NA5001 32.00x47.00x10.00mm FPM NA5124 (x2) 32.00x47.00x10.00mm PTFE/ACM



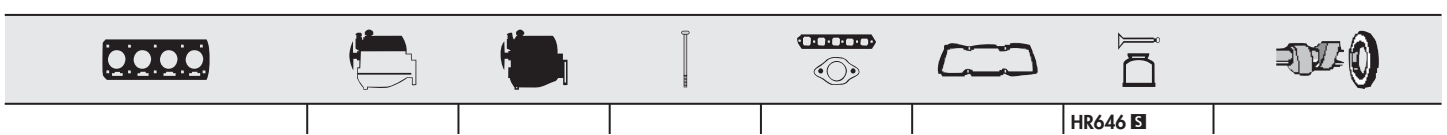

AY970

388	 81.00	Petrol	
BHG	4 Cyl.	1781cc	67kW (91)PS TD25772



HR646 

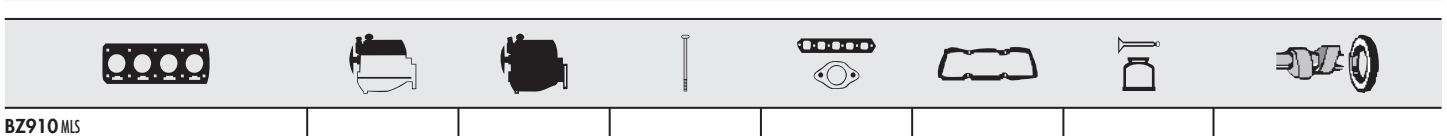

389	 81.00	Petrol	
BJY	4 Cyl.	10.3:1 1595cc	73kW (99)PS TD25785

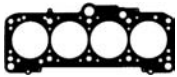

BZ910 



BZ910



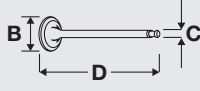

390	 81.00	Petrol	
BKB	4 Cyl.	1781cc	120kW (163)PS Turbo Intercooled TD19135 921





B x C x D

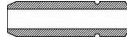



E x F x G

	OE	MAT.					
V94081 	058 109 601C		45°	Y	H	VAG96073B 	
26.90 x 6.00 x 105.10		MB				36.00 x 6.02 x 11.06	
V94082 	058 109 611E	MG cr	45°	ss	H		
29.90 x 6.00 x 103.90							

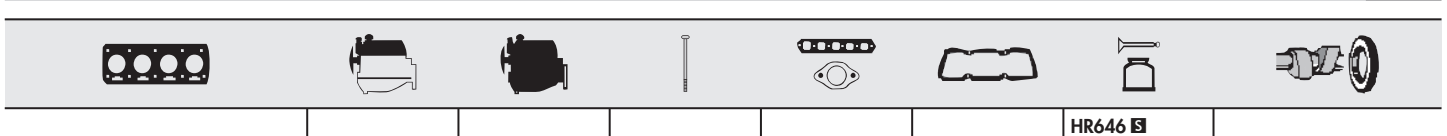





391	 81.00	Petrol	
BKU	4 Cyl.	1781cc	74kW (100)PS TD25890







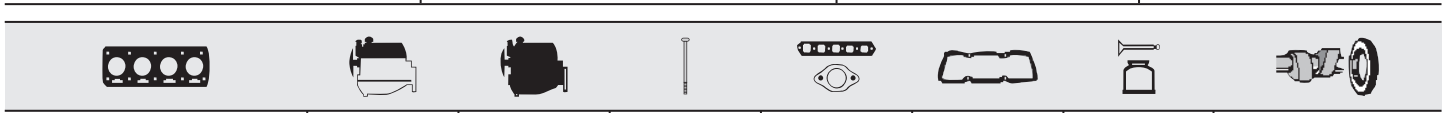

HR646 

392	 81.00	Petrol	
BKV	4 Cyl.	9.5:1 1781cc	110kW (150)PS Turbo Intercooled TD17321

IBIZA 12/03→05/08

			
TB554 150x23		CAM744 	FOL133  (x12) FOL141  (x8)



AY970 	CY971	HBS268  M10x1.50x120mm (x10)	JD604  JD605 	HL732 	PA5041 (x20) 6.00x8.8/12.20x10.00 866N W (FPM) HR822 	NA5001 32.00x47.00x10.00mm FPM NA5124 (x2) 32.00x47.00x10.00mm PTFE/ACM
--	--------------	---	--	--	---	--



AY970

VW GROUP

393



81.00

Petrol



BJF 4 Cyl. 10.1:1 1595cc 67-68kW (91-92)PS TD25198



BZ910 MLS HR646



BZ910

394



81.00

Petrol



BLZ 4 Cyl. 1781cc 132kW (180)PS Turbo Intercooled TD18751 922

IBIZA 01/04→02/08



AY970 MLS CY971 HBS268 M10x1.50x120mm (x10) JD604 JD6005 Steel 1.00mm JD605 HL732 PA5041 (x20) 6.00x8.8/12.20x10.00 866N W (FPM) HR822 NA5124 (x2) 32.00x47.00x10.00mm PTFE/ACM

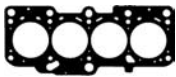

AY970

395



81.00

Petrol



BNU 4 Cyl. 9.5:1 1781cc 132kW (180)PS Turbo Intercooled TD21072

NEW BEETLE 11/01→06/05



TB554 150x23 TBK115 with tensioner pulley damper, Tens guide 36 CAM744 FOL133 (x12) FOL141 (x8)

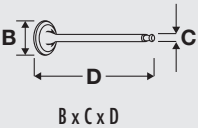

OE



MAT.



45°



Y



H

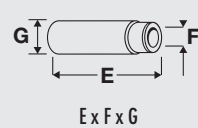



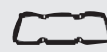



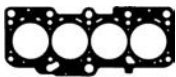



V94081 058 109 601C MB 45° Y H VAG96073B 36.00 x 6.02 x 11.06 V94082 058 109 611E MG cr 45° ss H





























AY970 MLS CY971 HBS268 M10x1.50x120mm (x10) JD604 JD605 HL732 PA5041 (x20) 6.00x8.8/12.20x10.00 866N W (FPM) HR822 NA5124 (x2) 32.00x47.00x10.00mm PTFE/ACM





AY970





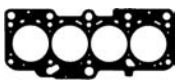

















396	 81.00	Petrol		
BSL	4 Cyl.	1781cc	73kW (99)PS	TD25786
       				
HR646 				











397	 81.00	Petrol			
BVP	4 Cyl.	1781cc	120kW (163)PS	Turbo Intercooled	TD18490
BVR	4 Cyl.	1781cc	140kW (190)PS	Turbo Intercooled	TD18493
TT	09/05 → 06/06				

							
TB554 150x23	TBK115 with tensioner pulley damper, Tens guide 36	CAM744 					FOL133  (x12) FOL141  (x8)
       							
AY970 MLS	CY971		HBS268  M10x1.50x120mm (x10)	JD604  JD605 	HL732 	PA5041 (x20) 6.00x8.8/12.20x10.00 866N W (FPM) HR822 	NA5001 32.00x47.00x10.00mm FPM NA5124 (x2) 32.00x47.00x10.00mm PTFE/ACM



398	 81.00	Petrol				
CFMA	4 Cyl.	10.3:1	1781cc	110kW (150)PS	Turbo Intercooled	TD22245
EXEO	12/08 → 05/10					

							
		CAM744 					FOL133  (x12) FOL141  (x8)
       							
			HBS268  M10x1.50x120mm (x10)	JD6005  Steel 1.00mm JD605 		PA5041 (x20) 6.00x8.8/12.20x10.00 866N W (FPM) HR822 	NA5124 32.00x47.00x10.00mm PTFE/ACM

399	 81.00	Petrol		
CMR	4 Cyl.	1595cc	72kW (98)PS	TD25901
       				
HR646 				

400







 81.00









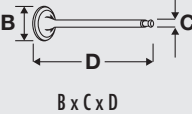

Petrol



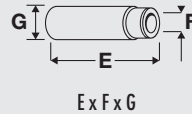















DD 4 Cyl. 1781cc 55kW (75)PS TD250 924

COUPE 08/81→07/83

					
TB108 121x18	TBK016		KIT		

 B x C x D	OE	 MAT.	 45°	 H	 E x F x G
V91034  38.10 x 7.97 x 99.06	035 109 601C	 MB	45°	H	VAG92105B  42.30 x 7.99 x 12.08
V91030  33.30 x 7.95 x 98.60	035 109 611F	 MG	45° ss	H	

							
BM360 Fibre Composite	DM360		HBS043  M11x1.50x95mm (x10)	JC478  PA459  (NBR) JC152  (x4)  JE904	HL457  [9] (Cork) HM5053  [10] (ACM)	HR569 	NA5001 32.00x47.00x10.00mm FPM

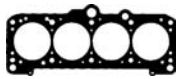

BM360

[9] Centering Diameter [mm]: 8.5

[9] Zentrierdurchmesser [mm]: 8.5

[10] Centering Diameter [mm]: 6.5

[10] Zentrierdurchmesser [mm]: 6.5

401

81.00

Petrol



DR 4 Cyl. 1781cc 55kW (75)PS TD252 925

100 08/82→12/87

TB108 121x18	TBK016				FOL92 (x8)

B x C x D	OE	MAT.
V91034 ■ 38.10 x 7.97 x 99.06	035 109 601C	45° H
V91030 ■ 33.30 x 7.95 x 98.60	035 109 611F	45° ss H
		VAG92105B ■ ■ 42.30 x 7.99 x 12.08

BM360 Fibre Composite	DM360	HBS043 ⊕ M11x1.50x95mm (x10)	JC478 ■ PA459 ■ (NBR) JC152 ■ (x4) ⊕JE904	HL457 ■ [9] (Cork) HM5053 ■ [10] (ACM)	HR569 ■	NA5001 32.00x47.00x10.00mm FPM

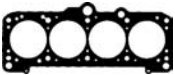

BM360

[9] Centering Diameter [mm]: 8.5
[10] Centering Diameter [mm]: 6.5

[9] Zentrierdurchmessers [mm]: 8.5
[10] Zentrierdurchmessers [mm]: 6.5

VW GROUP

402	81.00	Petrol			
DS	4 Cyl.	10:1	1781cc	66kW (89)PS	TD253 926
DS	4 Cyl.	10:1	1781cc	66kW (89)PS	TD4996 926
100	08/83→07/89		80	01/83→08/86	COUPE 09/82→10/88
PASSAT	01/83→03/88		SANTANA	01/83→12/84	

TB108 121x18	TBK016		KIT		FOL92 (x8)

B x C x D	E x F x G
V91338 ■ 38.10 x 7.97 x 91.90	VAG92061B ■ ■ ■ 36.70 x 8.00 x 12.08
V91340 ■ 33.30 x 7.95 x 91.20	VAG92105B ■ ■ ■ 42.30 x 7.99 x 12.08

BM360 Fibre Composite	DM360	HB5043 ☉ M11x1.50x95mm (x10)	JC478 ■ PA459 ■ (x4) (NBR) JC152 ■ (x4) ● JE138 [61] ● JE904	HL457 ■ [9] (Cork) HM5053 ■ [10] (ACM)	HR569 ■	NA5001 32.00x47.00x10.00mm FPM

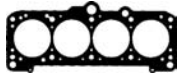

BM360

[61] To cylinder 4 - 6 [61] zum Zylinder 4 - 6
 [9] Centering Diameter [mm]: 8.5 [9] Zentrierdurchmessers [mm]: 8.5
 [10] Centering Diameter [mm]: 6.5 [10] Zentrierdurchmessers [mm]: 6.5

403	81.00	Petrol			
DTA	4 Cyl.	9:1	1595cc	55kW (75)PS	TD22646 881

BM360 Fibre Composite	DM360	JC478 ■ PA459 ■ (NBR) JC152 ■ (x4) JE138 [61]	HL457 ■ [9] (Cork) HM5053 ■ [10] (ACM)	HR569 ■	NA5001 32.00x47.00x10.00mm FPM

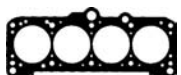

BM360

[9] Centering Diameter [mm]: 8.5 [9] Zentrierdurchmessers [mm]: 8.5
 [10] Centering Diameter [mm]: 6.5 [10] Zentrierdurchmessers [mm]: 6.5

404

81.00

Petrol



DX 4 Cyl. 10:1 1781cc **82kW (111)PS** **TD4063** **927**

GOLF 08/82→12/92 **JETTA** 08/82→02/84 **SCIROCCO** 08/82→12/89

TB108 121x18	TBK016	CAM411			FOL92 (x8)

 B x C x D	OE	MAT.				 E x F x G
V91407 ■ 39.60 x 7.97 x 91.90	048 109 601A	 MD	45°			VAG92061B ■ ■ ■ 36.70 x 8.00 x 12.08
V94304 ■ 40.00 x 8.00 x 98.70	026 109 601	 MB	45°	Y	H	VAG92105B ■ ■ ■ 42.30 x 7.99 x 12.08
V91030 ■ 33.30 x 7.95 x 98.60	035 109 611F	 MG	45°	ss	H	
V91340 ■ 33.30 x 7.95 x 91.20	053 109 611	 MG	45°		H	

BM360 Fibre Composite	DM368 [14]		HBS043 ⊕ M11x1.50x95mm (x10)	JC478 ■ PA459 ■ (NBR) JC152 ■ (x4) JE117 →07/83 JE160 08/83→	HL457 ■ [9] (Cork) HM5053 ■ [10] (ACM)	HR569 ■	NA5001 32.00x47.00x10.00mm FPM

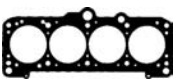

BM360

[9] Centering Diameter [mm]: 8.5



[10] Centering Diameter [mm]: 6.5







[14] With shaft oil seal









[9] Zentrierdurchmessers [mm]: 8.5

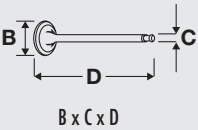





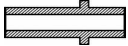









[10] Zentrierdurchmessers [mm]: 6.5

[14] Mit Wellendichtring

405	 81.00	Petrol				
DZ	4 Cyl.	10:1	1781cc	82kW (111)PS	TD256	928
DZ	4 Cyl.	10:1	1781cc	82kW (111)PS	TD4998	928
80	08/84→08/91	COUPE	12/84→07/91	PASSAT	12/83→03/88	

					
TB108 121x18	TBK016	CAM411			FOL92 (x8)

				
B x C x D	OE	MAT.		E x F x G
V91338 	035 109 601K		45°	VAG92061B 
38.10 x 7.97 x 91.90		MD		36.70 x 8.00 x 12.08
V91340 	048 109 611A	MG	45° H	
33.30 x 7.95 x 91.20				

							
BM360 Fibre Composite	DM360		HBS043 	JC478  PA459  (NBR) JC152  (x4)  JE689	HL457  [9] (Cork) HM5053  [10] (ACM)	HR569 	NA5001 32.00x47.00x10.00mm FPM

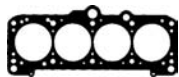

BM360

[9] Centering Diameter [mm]: 8.5

[9] Zentrierdurchmessers [mm]: 8.5

[10] Centering Diameter [mm]: 6.5

[10] Zentrierdurchmessers [mm]: 6.5

406







 **81.00**







Petrol



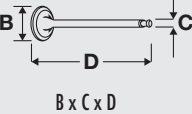

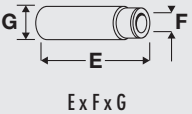













EV 4 Cyl. 10:1 1781cc **82kW (111)PS** **TD4069** **929**

GOLF 08/82→10/91 **JETTA** 01/84→10/91 **SCIROCCO** 08/82→12/89

					
TB108 121x18	TBK016	CAM411			FOL92 (x8)

		
B x C x D	OE	E x F x G
V91407 	048 109 601A	VAG92061B 
39.60 x 7.97 x 91.90		36.70 x 8.00 x 12.08
V91340 	053 109 611	
33.30 x 7.95 x 91.20		

							
BM360 Fibre Composite	DM368 [14]	HBS043 	JC478 	JC152  (x4)	HL457  [9]	HR569  	NA5001
		M11x1.50x95mm (x10)		 JE117 →07/83  JE160 08/83→	(Cork) HM5053  [10] (ACM)		32.00x47.00x10.00mm FPM

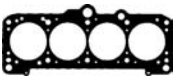

BM360

[9] Centering Diameter [mm]: 8.5

[9] Zentrierdurchmessers [mm]: 8.5

[10] Centering Diameter [mm]: 6.5

[10] Zentrierdurchmessers [mm]: 6.5

[14] With shaft oil seal

[14] Mit Wellendichtring

407

81.00
Petrol



EX	4 Cyl.	10:1	1781cc	66kW (89)PS	TD5000	930
-----------	--------	------	--------	--------------------	---------------	------------

GOLF	08/83→09/92	SCIROCCO	08/83→07/92
-------------	-------------	-----------------	-------------

TB108 121x18	TBK016				FOL92 (x8)

V91034 ■ 38.10 x 7.97 x 99.06	V91030 ■ 33.30 x 7.95 x 98.60	MAT. MB MG	45°	H	VAG92061B ■ ■ ■ 36.70 x 8.00 x 12.08	VAG92105B ■ ■ ■ 42.30 x 7.99 x 12.08
OE: 035 109 601C	035 109 611F		45° ss	H		

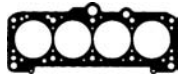
BM360 Fibre Composite	DM368 [14]	HBS043 ⊕ M11x1.50x95mm (x10)	JC478 ■ PA459 ■ (NBR)	JC152 ■ (x4)	JE160	HL457 ■ [9] (Cork)	HM5053 ■ [10] (ACM)	HR569 ■	NA5001 32.00x47.00x10.00mm FPM	

BM360

[9] Centering Diameter [mm]: 8.5

[9] Zentrierdurchmessers [mm]: 8.5

[10] Centering Diameter [mm]: 6.5

[10] Zentrierdurchmessers [mm]: 6.5

[14] With shaft oil seal

[14] Mit Wellendichtring

408	81.00	Petrol			
GX	4 Cyl.	10:1	1781cc	66kW (89)PS	TD4100 929
GOLF	08/84→10/91	JETTA		08/84→10/91	

TB108 121x18	TBK016	CAM411		FOL92 (x8)

	OE				
V91338 ■ 38.10 x 7.97 x 91.90	035 109 601K		45°		VAG92061B ■ ■ ■ 36.70 x 8.00 x 12.08
V91340 ■ 33.30 x 7.95 x 91.20	053 109 611		45°	H	

BM360 Fibre Composite	DM368 [14]	HBS043 ⊕ M11x1.50x95mm (x10)	JC478 ■ PA459 ■ (NBR)	JC152 ■ (x4)		HL457 ■ [9] (Cork)	HM5053 ■ [10] (ACM)	HR569 ■	NA5001 32.00x47.00x10.00mm FPM	

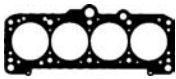

BM360

[9] Centering Diameter [mm]: 8.5 [9] Zentrierdurchmessers [mm]: 8.5
 [10] Centering Diameter [mm]: 6.5 [10] Zentrierdurchmessers [mm]: 6.5
 [14] With shaft oil seal [14] Mit Wellendichtring

409	81.00	Petrol			
GZ	4 Cyl.	10:1	1781cc	66kW (89)PS	TD4102 893
GOLF	08/83→10/91	JETTA		01/84→10/91	

	OE				
V91338 ■ 38.10 x 7.97 x 91.90	035 109 601K		45°		VAG92061B ■ ■ ■ 36.70 x 8.00 x 12.08
V91340 ■ 33.30 x 7.95 x 91.20	053 109 611		45°	H	

BM360 Fibre Composite	DM368 [14]	HBS043 ⊕ M11x1.50x95mm (x10)	JC478 ■ PA459 ■ (NBR)	JC152 ■ (x4)		HL457 ■ [9] (Cork)	HM5053 ■ [10] (ACM)	HR569 ■	NA5001 32.00x47.00x10.00mm FPM	

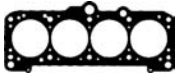

BM360

[9] Centering Diameter [mm]: 8.5 [9] Zentrierdurchmessers [mm]: 8.5
 [10] Centering Diameter [mm]: 6.5 [10] Zentrierdurchmessers [mm]: 6.5
 [14] With shaft oil seal [14] Mit Wellendichtring

410



81.00

Petrol



HT 4 Cyl. 10:1 1781cc 74-77kW (100-104)PS

TD4109 893

GOLF 01/85→07/85

TB108 121x18	TBK016				

B x C x D	E x F x G
V91407 ■ 39.60 x 7.97 x 91.90	V91340 ■ 33.30 x 7.95 x 91.20
OE 048 109 601A	053 109 611
MAT. MD	MG
45°	45° H

BM360 Fibre Composite	DM368 [14]		HBS043 ⊕ M11x1.50x95mm (x10)	JC478 ■ PA459 ■ (NBR) JC152 ■ (x4) ⊕ JE160	HL457 ■ [9] (Cork) HM5053 ■ [10] (ACM)	HR569 ■	NA5001 32.00x47.00x10.00mm FPM

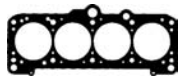

BM360

[9] Centering Diameter [mm]: 8.5

[9] Zentrierdurchmessers [mm]: 8.5

[10] Centering Diameter [mm]: 6.5

[10] Zentrierdurchmessers [mm]: 6.5

[14] With shaft oil seal

[14] Mit Wellendichtring

411

81.00
Petrol



HV	4 Cyl.	10:1	1781cc	66kW (89)PS	TD4111	893
-----------	--------	------	--------	--------------------	---------------	------------

GOLF	08/84→10/91	JETTA	08/84→10/91
-------------	-------------	--------------	-------------

TB108 121x18	TBK016				

V91338 ■ 38.10 x 7.97 x 91.90	V91340 ■ 33.30 x 7.95 x 91.20	VAG92061B ■ ■ ■ 36.70 x 8.00 x 12.08
OE: 035 109 601K	OE: 053 109 611	
MAT. MD	MAT. MG	
45°	45° H	

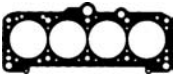
BM360 Fibre Composite	DM368 [14]	HBS043 ⊕ M11x1.50x95mm (x10)	JC478 ■ PA459 ■ (NBR)	JC152 ■ (x4)	JE160	HL457 ■ [9] (Cork)	HM5053 ■ [10] (ACM)	HR569 ■	NA5001 32.00x47.00x10.00mm FPM	

BM360

[9] Centering Diameter [mm]: 8.5

[10] Centering Diameter [mm]: 6.5

[14] With shaft oil seal

[9] Zentrierdurchmessers [mm]: 8.5

[10] Zentrierdurchmessers [mm]: 6.5

[14] Mit Wellendichtring

412



81.00

Petrol



JH	4 Cyl.	8.5:1	1781cc	70kW (95)PS	TD4117	930
CADDY	08/85→07/92	GOLF	08/83→04/93	SCIROCCO	11/85→07/92	

TB108 121x18	TBK016	CAM411	KIT	FOL92 (x8)

V91338 ■ 38.10 x 7.97 x 91.90	V91340 ■ 33.30 x 7.95 x 91.20	VAG92105B ■ ■ ■ 42.30 x 7.99 x 12.08
OE: 035 109 601K	OE: 053 109 611	
MAT. MD	MAT. MG	
45°	45° H	

BM360 Fibre Composite	DM368 [14]	HBS043 ⊕ M11x1.50x95mm (x10)	JC478 ■ PA459 ■ (NBR) JC152 ■ (x4) ⊕ JE160	HL457 ■ [9] (Cork) HM5053 ■ [10] (ACM)	HR569 ■	NA5001 32.00x47.00x10.00mm FPM

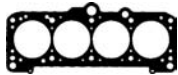

BM360

[9] Centering Diameter [mm]: 8.5
[10] Centering Diameter [mm]: 6.5
[14] With shaft oil seal

[9] Zentrierdurchmessers [mm]: 8.5
[10] Zentrierdurchmessers [mm]: 6.5
[14] Mit Wellendichtring







413







 **81.00**



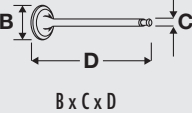



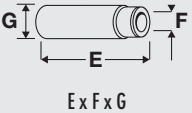

Petrol



JJ	4 Cyl.	10:1	1781cc	82kW (111)PS	TD4118
GOLF	08/82→12/83	JETTA	08/82→02/84	SCIROCCO	08/82→12/89

					
TB108 121x18	TBK016				

						
V94304 ■ 40.00 x 8.00 x 98.70	OE 026 109 601	MAT. MB	45°	Y	H	VAG92105B ■ ■ 42.30 x 7.99 x 12.08

							
BM360 Fibre Composite	DM368 [14] 08/83→	HBS043 ⊕ M11x1.50x95mm (x10)	JC478 ■ PA459 ■ (NBR) JC152 ■ (x4) ⊕ JE117 →07/83 ⊕ JE160 08/83→	HL457 ■ [9] (Cork) HM5053 ■ [10] (ACM)	HR569 ■	NA5001 32.00x47.00x10.00mm FPM	

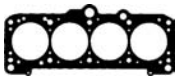

BM360

[9] Centering Diameter [mm]: 8.5

[10] Centering Diameter [mm]: 6.5

[14] With shaft oil seal

[9] Zentrierdurchmessers [mm]: 8.5

[10] Zentrierdurchmessers [mm]: 6.5

[14] Mit Wellendichtring

414	81.00	Petrol			
JN	4 Cyl.	8.75/9:1	1781cc	66kW (89)PS	TD4208 925
JN	4 Cyl.	8.75/9:1	1781cc	66kW (89)PS	TD5014 925
PM	4 Cyl.		1781cc	66kW (89)PS	TD306 939
80	08/83→10/91	COUPE	01/85→10/88	PASSAT	01/83→03/88

TB108 121x18	TBK016		KIT		FOL92 (x8)

B x C x D	E x F x G
V91338 ■ 38.10 x 7.97 x 91.90	VAG92061B ■ ■ ■ 36.70 x 8.00 x 12.08
V91340 ■ 33.30 x 7.95 x 91.20	VAG92105B ■ ■ ■ 42.30 x 7.99 x 12.08

BM360 Fibre Composite	DM361	HB5043 ☉ M11x1.50x95mm (x10)	JC478 ■ PA459 ■ (NBR) JC152 ■ (x4) JE138 [61]	HL457 ■ [9] (Cork) HM5053 ■ [10] (ACM)	HR569 ■	NA5001 32.00x47.00x10.00mm FPM

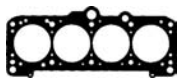

BM360

[61] To cylinder 4 - 6 [61] zum Zylinder 4 - 6
 [9] Centering Diameter [mm]: 8.5 [9] Zentrierdurchmessers [mm]: 8.5
 [10] Centering Diameter [mm]: 6.5 [10] Zentrierdurchmessers [mm]: 6.5

415

81.00

Petrol



JV	4 Cyl.	10:1	1781cc	66kW (89)PS	TD278	926
JV	4 Cyl.	10:1	1781cc	66kW (89)PS	TD5017	926

80	01/83→08/86	COUPE	09/82→10/88	PASSAT	01/83→03/88
----	-------------	-------	-------------	--------	-------------

TB108 121x18	TBK016		KIT		

	OE	MAT.				
B x C x D						E x F x G
V91034	035 109 601C		45°		H	VAG92061B
38.10 x 7.97 x 99.06		MB				36.70 x 8.00 x 12.08
V91338	035 109 601K		45°			VAG92105B
38.10 x 7.97 x 91.90		MD				42.30 x 7.99 x 12.08
V91407	048 109 601A		45°			
39.60 x 7.97 x 91.90		MD				
V91030	035 109 611F		45°	ss	H	
33.30 x 7.95 x 98.60		MG				
V91340	048 109 611A		45°		H	
33.30 x 7.95 x 91.20		MG				

BM360 Fibre Composite	DM360	HBS043 M11x1.50x95mm (x10)	JC478 PA459 (NBR) JC152 (x4) JE904	HL457 [9] (Cork) HM5053 [10] (ACM)	HR569	NA5001 (x2) 32.00x47.00x10.00mm FPM

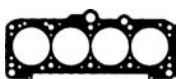

BM360

[9] Centering Diameter [mm]: 8.5
[10] Centering Diameter [mm]: 6.5

[9] Zentrierdurchmessers [mm]: 8.5
[10] Zentrierdurchmessers [mm]: 6.5

416



81.00

Petrol



JW	4 Cyl.	1781cc	66kW (89)PS	TD279	931
NP	4 Cyl.	1781cc	66kW (89)PS	TD304	894
SH	4 Cyl.	1781cc	65kW (88)PS	TD326	939

100 08/83→07/90

TB108 121x18	TBK016		KIT		FOL92 (x8)

B x C x D	OE	MAT.	45°	H	E x F x G
V91338 ■ 38.10 x 7.97 x 91.90	035 109 601K		45°		VAG92061B ■ ■ ■ 36.70 x 8.00 x 12.08
V91340 ■ 33.30 x 7.95 x 91.20	048 109 611A		45°	H	VAG92105B ■ ■ ■ 42.30 x 7.99 x 12.08

BM360 Fibre Composite	DM360	HB5043 ☉ M11x1.50x95mm (x10)	JC478 ■ PA459 ■ (NBR) JC152 ■ (x4) ☉JE904	HL457 ■ [9] (Cork) HM5053 ■ [10] (ACM)	HR569 ■	NA5001 32.00x47.00x10.00mm FPM

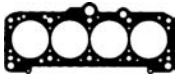

BM360

[9] Centering Diameter [mm]: 8.5

[9] Zentrierdurchmessers [mm]: 8.5

[10] Centering Diameter [mm]: 6.5

[10] Zentrierdurchmessers [mm]: 6.5

417

81.00
Petrol



KR	4 Cyl.	10:1	1781cc	98kW (133)PS	TD3591	932
KR	4 Cyl.	10:1	1781cc	98kW (133)PS	TD5019	932
PL	4 Cyl.	10:1	1781cc	95kW (129)PS	TD3595	938
PL	4 Cyl.	10:1	1781cc	95kW (129)PS	TD5021	938

CORRADO	04/89→07/92	GOLF	02/86→10/91	JETTA	08/86→10/91
PASSAT	04/88→09/93	SCIROCCO	10/85→07/92	TOLEDO	05/91→03/99

TB505 147x25.4	TBK066		KIT		FOL92 (x16)

B x C x D	E x F x G
V91416 ■ 32.10 x 6.97 x 95.50	VAG92382B ■ ■ ■ 38.00 x 7.00 x 12.05
OE: 027 109 601C	
MAT. MB	
45°	
H	
V91372 ■ 28.10 x 6.95 x 98.20	
OE: 027 109 611D	
MAT. MG cr	
45°	
H	

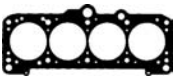
BM360 Fibre Composite	DM365 [14]		HBS028 ⊕ M11x1.50x147mm (x10)	JD281 ■ JD282 ■ (x4) JF205	HL606 ■	HR599 ■ (x2) HR816 ■ (x2)	NA5001 32.00x47.00x10.00mm FPM

BM360

[14] With shaft oil seal

[14] Mit Wellendichtring

418



81.00

Petrol



KT 4 Cyl. 10:1 1781cc 82kW (111)PS TD4124 929

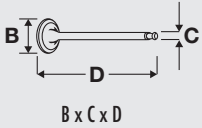

V91407 ■
39.60 x 7.97 x 91.90
V91340 ■
33.30 x 7.95 x 91.20

OE
048 109 601A
053 109 611

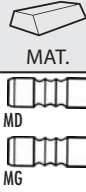

45°
45°

H

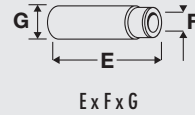

VAG92105B ■ ■ ■
42.30 x 7.99 x 12.08



BM360 Fibre Composite

DM360
DM368 [14]
08/83→ [14]

JF205
JC478 ■
JC152 ■ (x4)
JE117
→07/83
JE160
08/83→
→Ch.19-G-038 275

HL457 ■ [9]
(Cork)
HM5053 ■ [10]
(ACM)

HR569 ■

NA5001
32.00x47.00x10.00mm FPM
NB446

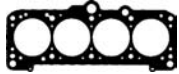

BM360

[14] With shaft oil seal

[14] Mit Wellendichtring

[9] Centering Diameter [mm]: 8.5

[9] Zentrierdurchmessers [mm]: 8.5

[10] Centering Diameter [mm]: 6.5

[10] Zentrierdurchmessers [mm]: 6.5

419



81.00

Petrol



MU 4 Cyl. 10:1 1781cc 82kW (111)PS TD298 893



BM360 Fibre Composite

DM363

HBS043 ⊕
M11x1.50x95mm (x10)

JC478 ■
→07/88
Audi 80/Quattro
JC152 ■ (x4)
JE689

HL457 ■ [9]
(Cork)
HM5053 ■ [10]
(ACM)

HR569 ■

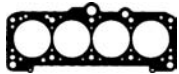

BM360

[9] Centering Diameter [mm]: 8.5

[9] Zentrierdurchmessers [mm]: 8.5

[10] Centering Diameter [mm]: 6.5

[10] Zentrierdurchmessers [mm]: 6.5

420







 **81.00**









Petrol

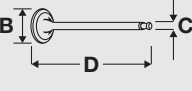



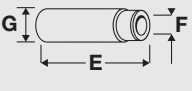

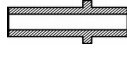

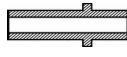

NE	4 Cyl.	1781cc	66kW (89)PS	TD4210	926
RU	4 Cyl.	1781cc	55kW (75)PS	TD320	945
SF	4 Cyl.	1781cc	64kW (87)PS	TD325	945

80 08/84→10/91 **COUPE** 09/85→10/88

			 KIT		
TB108 121x18	TBK016				FOL92 (x8)

							
B x C x D	OE	MAT.	45°			E x F x G	
V91338 ■ 38.10 x 7.97 x 91.90	035 109 601K		45°			VAG92061B ■ ■ ■ 36.70 x 8.00 x 12.08	
V91340 ■ 33.30 x 7.95 x 91.20	048 109 611A		45°	H		VAG92105B ■ ■ ■ 42.30 x 7.99 x 12.08	

							
BM360 Fibre Composite	DM360	HBS043 ⊕ M11x1.50x95mm (x10)	JC478 ■ PA459 ■ (NBR) JC152 ■ (x4) ⊕ JE689	HL457 ■ [9] (Cork) HM5053 ■ [10] (ACM)	HR569 ■	NA5001 32.00x47.00x10.00mm FPM	

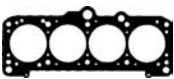

BM360

[9] Centering Diameter [mm]: 8.5 [9] Zentrierdurchmessers [mm]: 8.5
 [10] Centering Diameter [mm]: 6.5 [10] Zentrierdurchmessers [mm]: 6.5

421

81.00
Petrol

PB 4 Cyl. 10:1 1781cc **82kW (111)PS** **TD9367** **933**
GOLF 08/82→10/91 **JETTA** 01/84→10/91 **PASSAT** 04/88→07/92
SCIROCCO 08/82→12/89

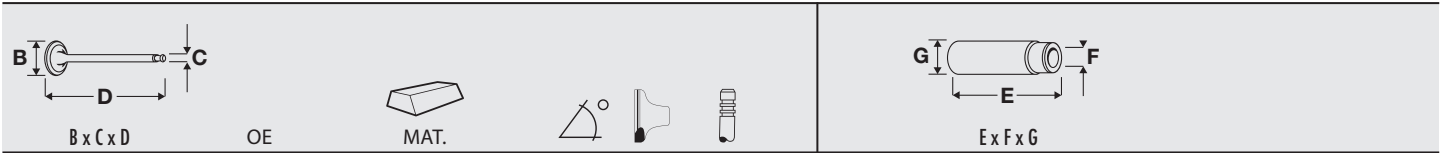
TB108 **TBK016** **CAM411** **FOL92 (x8)**

B x C x D	OE	MAT.	Angle	Height	E x F x G
V91407 ■ 39.60 x 7.97 x 91.90	048 109 601A	MD	45°		VAG92061B ■ ■ ■ 36.70 x 8.00 x 12.08
V91340 ■ 33.30 x 7.95 x 91.20	053 109 611	MG	45°	H	VAG92105B ■ ■ ■ 42.30 x 7.99 x 12.08

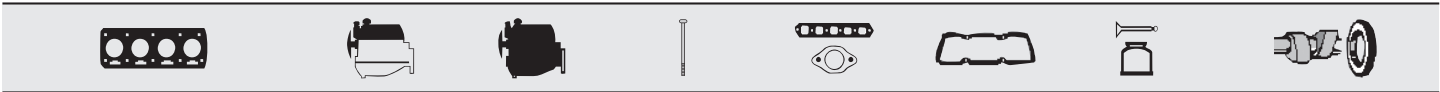

BM360 Fibre Composite	DM368 [14] 08/83→		HBS043 ⊕ M11x1.50x95mm (x10)	JC478 ■ PA459 ■ (NBR) JC152 ■ (x4) ⊙ JE117 →07/83 ⊙ JE160 08/83→	HL457 ■ [9] (Cork) HM5053 ■ [10] (ACM)	HR569 ■	NA5001 32.00x47.00x10.00mm FPM
------------------------------	-----------------------------	--	--	--	---	----------------	--

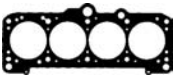
BM360

[9] Centering Diameter [mm]: 8.5
 [10] Centering Diameter [mm]: 6.5
 [14] With shaft oil seal

[9] Zentrierdurchmessers [mm]: 8.5
 [10] Zentrierdurchmessers [mm]: 6.5
 [14] Mit Wellendichtring

422

81.00
Petrol

PD 4 Cyl. 9/10:1 1781cc 49kW (67)PS TD4138 934

TRANSPORTER 12/90→07/92

TB108 121x18	TBK016				FOL92 (x8)

V91338 ■ 38.10 x 7.97 x 91.90	V91340 ■ 33.30 x 7.95 x 91.20	OE 035 109 601K MD 053 109 611 MG	45°	H	VAG92061B ■ ■ ■ 36.70 x 8.00 x 12.08

BW790 Fibre Composite	DW790	HBS043 ⊕ M11x1.50x95mm (x10)	JC478 ■ PA459 ■ (NBR)	JC152 ■ (x4)	JE160	HL457 ■ [9] (Cork)	HM5053 ■ [10] (ACM)	HR569 ■	NA5001 32.00x47.00x10.00mm FPM	



BW790

[9] Centering Diameter [mm]: 8.5

[9] Zentrierdurchmessers [mm]: 8.5

[10] Centering Diameter [mm]: 6.5

[10] Zentrierdurchmessers [mm]: 6.5

423	81.00	Petrol			
PF	4 Cyl.	9/10:1	1781cc	79kW (107)PS	TD4139 935
RV	4 Cyl.	10:1	1781cc	77kW (105)PS	TD4151 946
GOLF	01/85→10/91	JETTA	01/87→10/91	PASSAT	04/88→07/93

TB108 121x18	TBK016	CAM411			FOL92 (x8)

B x C x D	OE	MAT.	45°	E x F x G	
V91407 ■ 39.60 x 7.97 x 91.90	048 109 601A		45°	VAG92061B ■ ■ ■ 36.70 x 8.00 x 12.08	
V91340 ■ 33.30 x 7.95 x 91.20	053 109 611		45° H	VAG92105B ■ ■ ■ 42.30 x 7.99 x 12.08	

BM360 Fibre Composite	DM368 [14]		HBS043 ⊕ M11x1.50x95mm (x10)	JC478 ■ PA459 ■ (NBR) JC152 ■ (x4) ⊕ JE160	HL457 ■ [9] (Cork) HM5053 ■ [10] (ACM)	HR569 ■	NA5001 32.00x47.00x10.00mm FPM

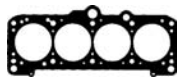

BM360

[9] Centering Diameter [mm]: 8.5
 [10] Centering Diameter [mm]: 6.5
 [14] With shaft oil seal

[9] Zentrierdurchmessers [mm]: 8.5
 [10] Zentrierdurchmessers [mm]: 6.5
 [14] Mit Wellendichtring

424	81.00	Petrol				
PG	4 Cyl.	1781cc	118kW (160)PS	Supercharged	TD4140	936
CORRADO	09/88→09/93	GOLF	08/88→07/91	PASSAT	08/88→05/97	

TB108 121x18	TBK016				FOL92 (x8)

V91407 39.60 x 7.97 x 91.90	VAG92061B 36.70 x 8.00 x 12.08
V91340 33.30 x 7.95 x 91.20	

BY630 MLS	DT819	HBS043 M11x1.50x95mm (x10)	JC478 JC152 (x4) JF205	JN964	HR569	NA5001 32.00x47.00x10.00mm FPM



BY630

425	81.00	Petrol			
PH	4 Cyl.	1781cc	66kW (89)PS	TD305	937
100	03/85→11/90				

TB108 121x18	TBK016				

V91338 38.10 x 7.97 x 91.90	VAG92061B 36.70 x 8.00 x 12.08
V91340 33.30 x 7.95 x 91.20	VAG92105B 42.30 x 7.99 x 12.08

BM360 Fibre Composite	DM361	HBS043 M11x1.50x95mm (x10)	JC478 JC152 (x4) JE138 [61]	HL457 [9] (Cork) HM5053 [10] (ACM)	HR569	NA5001 32.00x47.00x10.00mm FPM

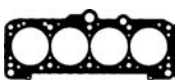

BM360

[61] To cylinder 4 - 6
[9] Centering Diameter [mm]: 8.5
[10] Centering Diameter [mm]: 6.5

[61] zum Zylinder 4 - 6
[9] Zentrierdurchmessers [mm]: 8.5
[10] Zentrierdurchmessers [mm]: 6.5







426









 81.00

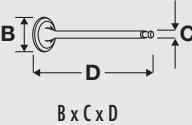

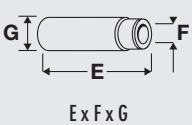











Petrol



PV	4 Cyl.	1781cc	82kW (111)PS	TD311	926
80	03/85→08/86	COUPE	08/86→10/87		

					
TB108 121x18	TBK016	CAM411			FOL92 (x8)

		
B x C x D	OE	E x F x G
V91407 	048 109 601A	VAG92061B 
39.60 x 7.97 x 91.90		36.70 x 8.00 x 12.08
V91340 	048 109 611A	VAG92105B 
33.30 x 7.95 x 91.20		42.30 x 7.99 x 12.08
	45°	
	45°	H

							
BM360 Fibre Composite	DM361		HBS043 	JC478 	HL457  [9]	HR569 	NA5001
			M11x1.50x95mm (x10)	JC152  (x4)	(Cork)		32.00x47.00x10.00mm FPM
				 JE138 [61]	HM5053  [10]		
					(ACM)		

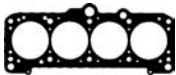

BM360

[61] To cylinder 4 - 6

[9] Centering Diameter [mm]: 8.5

[10] Centering Diameter [mm]: 6.5

[61] zum Zylinder 4 - 6

[9] Zentrierdurchmessers [mm]: 8.5

[10] Zentrierdurchmessers [mm]: 6.5

427	81.00	Petrol			
RD	4 Cyl.	10:1	1781cc	79kW (107)PS	TD4143 940
GOLF	08/85→10/87	JETTA		08/85→10/87	

TB108 121x18	TBK016	CAM411	KIT		FOL92 (x8)

B x C x D	OE	MAT.	45°	H	E x F x G
V91407 ■ 39.60 x 7.97 x 91.90	048 109 601A		45°		VAG92061B ■ ■ ■ 36.70 x 8.00 x 12.08
V91340 ■ 33.30 x 7.95 x 91.20	053 109 611		45°	H	

BM360 Fibre Composite	DM368 [14]		HBS043 ⊕ M11x1.50x95mm (x10)	JC478 ■ PA459 ■ (NBR) JC152 ■ (x4) ⊕ JE160	HL457 ■ [9] (Cork) HM5053 ■ [10] (ACM)	HR569 ■	NA5001 32.00x47.00x10.00mm FPM

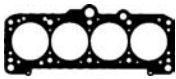

BM360

[9] Centering Diameter [mm]: 8.5 [9] Zentrierdurchmessers [mm]: 8.5
 [10] Centering Diameter [mm]: 6.5 [10] Zentrierdurchmessers [mm]: 6.5
 [14] With shaft oil seal [14] Mit Wellendichtring

428	81.00	Petrol			
RG	4 Cyl.	10:1	1781cc	79kW (107)PS	TD4146 928

B x C x D	OE	MAT.	45°	H	E x F x G
V91407 ■ 39.60 x 7.97 x 91.90	048 109 601A		45°		VAG92061B ■ ■ ■ 36.70 x 8.00 x 12.08
V91340 ■ 33.30 x 7.95 x 91.20	053 109 611		45°	H	

BM360 Fibre Composite	DM360 DM368 [14]			JF205 JC478 ■ JC152 ■ (x4) JE160	HL457 ■ [9] (Cork)	HR569 ■	NA5001 32.00x47.00x10.00mm FPM NB446

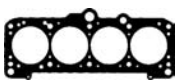

BM360

[9] Centering Diameter [mm]: 8.5 [9] Zentrierdurchmessers [mm]: 8.5
 [14] With shaft oil seal [14] Mit Wellendichtring

429



81.00

Petrol



RH	4 Cyl.	9/10:1	1781cc	62kW (84)PS	TD5026	941
GOLF		08/86 → 01/90		JETTA	08/86 → 01/90	

TB108 121x18	TBK016				FOL92 (x8)

B x C x D	OE	MAT.	45°	H	E x F x G
V91338 ■ 38.10 x 7.97 x 91.90	035 109 601K		45°		VAG92061B ■ ■ ■ 36.70 x 8.00 x 12.08
V91340 ■ 33.30 x 7.95 x 91.20	053 109 611		45°	H	VAG92105B ■ ■ ■ 42.30 x 7.99 x 12.08

BM360 Fibre Composite	DM368 [14]		HBS043 ⊕ M11x1.50x95mm (x10)	JC478 ■ PA459 ■ (NBR) JC152 ■ (x4) ⊕ JE160	HL457 ■ [9] (Cork) HM5053 ■ [10] (ACM)	HR569 ■	NA5001 32.00x47.00x10.00mm FPM

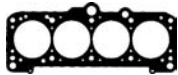

BM360

[9] Centering Diameter [mm]: 8.5
[10] Centering Diameter [mm]: 6.5
[14] With shaft oil seal

[9] Zentrierdurchmessers [mm]: 8.5
[10] Zentrierdurchmessers [mm]: 6.5
[14] Mit Wellendichtring

430	81.00	Petrol			
RM	4 Cyl.	10:1	1781cc	64kW (87)PS	TD4149 942
GOL	05/84→09/94	PASSAT		05/86→03/88	

TB108 121x18	TBK016				FOL92 (x8)

B x C x D	OE	MAT.	45°	H	E x F x G
V91338 ■ 38.10 x 7.97 x 91.90	035 109 601K		45°		VAG92061B ■ ■ ■ 36.70 x 8.00 x 12.08
V91340 ■ 33.30 x 7.95 x 91.20	053 109 611		45°	H	

BM360 Fibre Composite	DM360		HBS043 ⊕ M11x1.50x95mm (x10)	JC478 ■ PA459 ■ (NBR) JC152 ■ (x4) JE689	HL457 ■ [9] (Cork) HM5053 ■ [10] (ACM)	HR569 ■	NA5001 32.00x47.00x10.00mm FPM

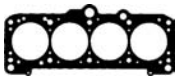

BM360

[9] Centering Diameter [mm]: 8.5 [9] Zentrierdurchmessers [mm]: 8.5
 [10] Centering Diameter [mm]: 6.5 [10] Zentrierdurchmessers [mm]: 6.5

431	81.00	Petrol			
RNA	4 Cyl.	9:1	1595cc	51kW (70)PS	TD315

BM360 Fibre Composite	DM363			JC478 ■ PA459 ■ (NBR) JC152 ■ (x4) JE689	HL457 ■ [9] (Cork) HM5053 ■ [10] (ACM)	HR569 ■	NA5001 32.00x47.00x10.00mm FPM NB446

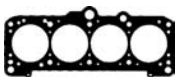

BM360

[9] Centering Diameter [mm]: 8.5 [9] Zentrierdurchmessers [mm]: 8.5
 [10] Centering Diameter [mm]: 6.5 [10] Zentrierdurchmessers [mm]: 6.5



RS 4 Cyl. 1781cc 55kW (75)PS

TD317 944

100 08/82→12/87

TB108 121x18	TBK016				

B x C x D	OE	MAT.	45°	H	E x F x G
V91338 ■ 38.10 x 7.97 x 91.90	035 109 601K	MD	45°		VAG92061B ■ ■ ■ 36.70 x 8.00 x 12.08
V91340 ■ 33.30 x 7.95 x 91.20	048 109 611A	MG	45°	H	VAG92105B ■ ■ ■ 42.30 x 7.99 x 12.08

BM360 Fibre Composite	DM361		HBS043 ⊕ M11x1.50x95mm (x10)	JC478 ■ PA459 ■ (NBR) JC152 ■ (x4) ⊕ JE138 [61]	HL457 ■ [9] (Cork) HM5053 ■ [10] (ACM)	HR569 ■	NA5001 32.00x47.00x10.00mm FPM

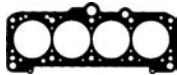

BM360

[61] To cylinder 4 - 6

[9] Centering Diameter [mm]: 8.5

[10] Centering Diameter [mm]: 6.5

[61] zum Zylinder 4 - 6

[9] Zentrierdurchmessers [mm]: 8.5

[10] Zentrierdurchmessers [mm]: 6.5

433



81.00

Petrol



BZB	4 Cyl.	1798cc	118kW (160)PS	Turbo Intercooled	TD19902
BZB	4 Cyl.	1798cc	118kW (160)PS	Turbo Intercooled	TD20090
BZB	4 Cyl.	1798cc	118kW (160)PS	Turbo Intercooled	TD20793
BZB	4 Cyl.	1798cc	118kW (160)PS	Turbo Intercooled	TD20902

A3	11/06→	ALTEA	01/07→	ALTEA XL	01/07→
LEON	06/07→	OCTAVIA	06/07→	PASSAT	05/07→10/11
PASSAT CC	06/08→11/10	SUPERB	03/08→	TOLEDO	01/07→05/09

 B x C x D	OE	 MAT.	 45°	 H	 E x F x G
V94692	06D 109 611L	 MG cr	45°	H	
V94704	06D 109 611K	 MG	45°	H	

AH5380 MLS			HBS476		HR397	PA5041 (x16)	HR791
			M10x1.50x117mm (x10)			6.00x8.8/12.20x10.00	866N W (FPM)



AH5380

434



81.00

Petrol



AAC 4 Cyl. 8.5:1 1968cc 62kW (84)PS TD4001 947

TRANSPORTER 07/90→04/03 VENTO 11/91→07/98

TB506 124x18	TBK076				FOL143 (x8)

B x C x D	OE	MAT.	45°	H	E x F x G
V91407 ■ 39.60 x 7.97 x 91.90	048 109 601A		45°		VAG92061B ■ ■ ■ 36.70 x 8.00 x 12.08
V91340 ■ 33.30 x 7.95 x 91.20	053 109 611		45°	H	

BW790 Fibre Composite	DW790		HBS018 ⊕ M12x1.75x115mm (x10)	JD483 ■ JC152 ■ (x4)	JP024 Eng.049 001→ HL457 ■ [9] (Cork) →Eng.049 000 HM5053 ■ [10] (ACM)	HR569 ■	NA5001 32.00x47.00x10.00mm FPM

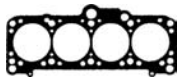

BW790

[9] Centering Diameter [mm]: 8.5
[10] Centering Diameter [mm]: 6.5

[9] Zentrierdurchmessers [mm]: 8.5
[10] Zentrierdurchmessers [mm]: 6.5

435

81.00
Diesel



AZV	4 Cyl.	18:1	1968cc	100kW (136)PS	Turbo Intercooled	TD16862	948
AZV	4 Cyl.	18:1	1968cc	100kW (136)PS	Turbo Intercooled	TD17027	948
AZV	4 Cyl.	18:1	1968cc	100kW (136)PS	Turbo Intercooled	TD18247	948
AZV	4 Cyl.	18:1	1968cc	100kW (136)PS	Turbo Intercooled	TD20909	948
BMA	4 Cyl.		1968cc	100kW (136)PS	Turbo Intercooled	TD18225	948

A3	05/03→	ALTEA	03/04→05/09	ALTEA XL	11/06→03/09
GOLF	10/03→	JETTA	09/05→10/10	LEON	07/05→05/10
OCTAVIA	02/04→05/10	PASSAT	03/05→11/10	TOLEDO	09/04→05/09
TOURAN	02/03→05/10				

TB743 141x30	TBK262 Ten bolt hole 10				

B x C x D	E x F x G
OE	
MAT.	
V94697	VAG96237B
03G 109 601B 29.20 x 6.00 x 87.80	42.00 x 6.02 x 10.07
V98007	
03G 109 601A 29.20 x 6.00 x 88.45	
V94698	
03G 109 611B 25.50 x 6.00 x 88.10	
V98097	
03G 109 611D 25.40 x 6.00 x 87.50	

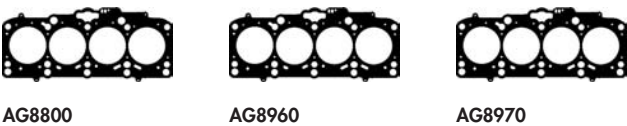
AG8970 MLS, 1.550mm, 1 Hole	CG8410		HBS364 M12x1.75x149mm (x10)	JD5805 JD5806 JD5815	JM7031 (Elastomer)	PA5041 (x16) 6.00x8.8/12.20x10.00 866N W (FPM) HR791	NA5124 (x2) 32.00x47.00x10.00mm PTFE/ACM

AG8800
AG8960
AG8970

VW GROUP

436



81.00

Diesel



BDJ	4 Cyl.	1968cc	51kW (70)PS	TD17358	949	
BST	4 Cyl.	19:1	1968cc	51kW (70)PS	TD20501	958

CADDY 03/04→08/10

TB680 120x30	TBK270		KIT		

<p>V94649 ■ 038 109 601E 36.00 x 7.00 x 89.40</p> <p>V94650 ■ 038 109 611E 31.40 x 7.00 x 89.00</p>	<p>VAG96041B ■ ■ ■ 36.50 x 7.00 x 12.08</p>

AG8830 AG8830 MLS, 1.510mm, 2 Holes AG8950 MLS, 1.610mm, 3 Holes	AG8940 AG8940 MLS, 1.410mm, 1 Hole	AG8950 AG8950 MLS, 1.610mm, 3 Holes	CC5231 ▲	HBS300 ⊕ M12x1.75x166mm (x10)	JD170 ■ JD600 ■	JM5203	HR599 ■ HR646 ■ HR816 ■	NA5124 32.00x47.00x10.00mm PTFE/ACM			

437



81.00

Diesel



BDK	4 Cyl.	1968cc	55kW (75)PS	TD17359	950
------------	--------	--------	-------------	----------------	------------

GOLF 01/04→11/08

TB680 120x30	TBK270		KIT		

<p>V94649 ■ 038 109 601E 36.00 x 7.00 x 89.40</p> <p>V94650 ■ 038 109 611E 31.40 x 7.00 x 89.00</p>	<p>VAG96041B ■ ■ ■ 36.50 x 7.00 x 12.08</p>

AG8830 AG8830 MLS, 1.510mm, 2 Holes AG8950 MLS, 1.610mm, 3 Holes	AG8940 AG8940 MLS, 1.410mm, 1 Hole	AG8950 AG8950 MLS, 1.610mm, 3 Holes	CC5231 ▲	HBS300 ⊕ M12x1.75x166mm (x10)	JD170 ■ JD600 ■	JM5203	HR599 ■ HR646 ■ HR816 ■			

438	81.00	Diesel					
BEE	4 Cyl.	18:1	1968cc	96kW (131)PS	Turbo Intercooled	TD24836	951
GOLF	05/05→05/07						

	.KIT		KIT		
TB743					
141x30					

439	81.00	Diesel					
BGW	4 Cyl.	18.5:1	1968cc	100kW (136)PS	Turbo Intercooled	TD18539	952
BHW	4 Cyl.	18.5:1	1968cc	100kW (136)PS		TD22177	953
PASSAT	12/03→05/05						

	.KIT		KIT		
TB680	TBK270				
120x30					

 B x C x D	OE	MAT.				 E x F x G
V94649	038 109 601E		45°	Y	H	VAG96041B
36.00 x 7.00 x 89.40		MB				36.50 x 7.00 x 12.08
V94650	038 109 611E		45°	ss	H	
31.40 x 7.00 x 89.00		MG				

AG9630 MLS, 1.450mm, 1 Hole	CC5231 ▲	HBS300 ⊕	JD170 ■	JM5203	HR599 ■	NA5124
AG9640 MLS, 1.530mm, 2 Holes		M12x1.75x166mm (x10)	JD600 ■		HR646 ■	32.00x47.00x10.00mm PTFE/ACM
AG9650 MLS, 1.610mm, 3 Holes					HR816 ■	

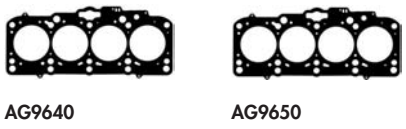

440



81.00

Diesel



BKD	4 Cyl.	18:1	1968cc	103kW (140)PS	Turbo Intercooled	TD17025	948
BKD	4 Cyl.	18:1	1968cc	103kW (140)PS	Turbo Intercooled	TD17080	948
BKD	4 Cyl.	18:1	1968cc	103kW (140)PS	Turbo Intercooled	TD17357	948
BKD	4 Cyl.	18:1	1968cc	103kW (140)PS	Turbo Intercooled	TD17500	948

A3	05/03 →	ALTEA	03/04 →	ALTEA XL	10/06 →
GOLF	10/03 →	JETTA	08/05 →10/10	LEON	07/05 →
OCTAVIA	02/04 →	SUPERB	01/09 →	TOLEDO	04/04 →05/09
TOURAN	08/03 →05/10				

TB743 141x30	TBK262 Ten bolt hole 10		KIT		

B x C x D	E x F x G
OE	MAT.
V94697 ■ 29.20 x 6.00 x 87.80	03G 109 601B MB 45° Y H
V98007 ■ 29.20 x 6.00 x 88.45	03G 109 601A MB 45°
V94698 ■ 25.50 x 6.00 x 88.10	03G 109 611B MG 45° ss H
V98097 ■ 25.40 x 6.00 x 87.50	03G 109 611D MG 45°
	VAG96237B ■ ■ ■ 42.00 x 6.02 x 10.07

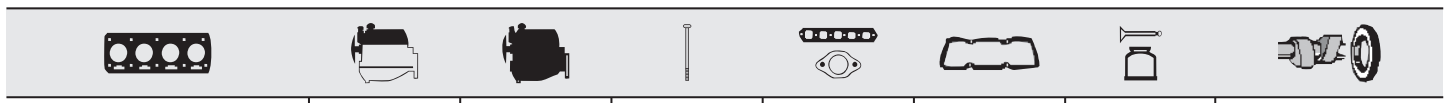

AG8970 MLS, 1.550mm, 1 Hole	CG8410 ▲	HBS364 ⊙ M12x1.75x149mm (x10)	JD5806 ■ →11/06	JM7031 (Elastomer)	PA5041 (x16) 6.00x8.8/12.20x10.00 866N W (FPM) HR791 ■	NA5124 (x2) 32.00x47.00x10.00mm PTFE/ACM
AG8800 MLS, 1.630mm, 2 Holes			JD5805 ■ 12/06 →			
AG8960 MLS, 1.710mm, 3 Holes			JD5815 ■			
			JD600 ■			

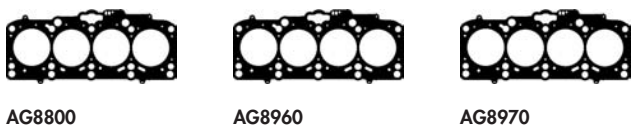

AG8800 AG8960 AG8970

441







 **81.00**











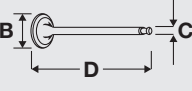

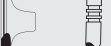
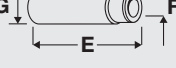
Diesel







BKP 4 Cyl. 18.5:1 1968cc **103kW (140)PS** **Turbo Intercooled** **TD18135** **948**

PASSAT 03/05→

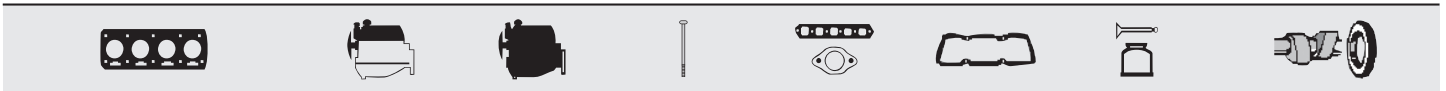
					
TB743 141x30	TBK262 Ten bolt hole →3C-6-300000				

	OE	MAT.			
B x C x D					E x F x G
V94697 	03G 109 601B		45°	Y H	VAG96237B 
29.20 x 6.00 x 87.80		MB			
V98007 	03G 109 601A		45°		
29.20 x 6.00 x 88.45		MB			
V94698 	03G 109 611B		45°	ss H	
25.50 x 6.00 x 88.10		MG			
V98097 	03G 109 611D		45°		
25.40 x 6.00 x 87.50		MG			



AG8970 MLS, 1.550mm, 1 Hole	CG8410 ▲	HBS364 ⊕ M12x1.75x149mm (x10)	JD5806  →11/06 Metal	JM7031 (Elastomer)	PA5041 (x16) 6.00x8.8/12.20x10.00 866N W (FPM) HR791 	NA5124
AG8800 MLS, 1.630mm, 2 Holes			JD5805  12/06 → Elastomer			
AG8960 MLS, 1.710mm, 3 Holes			JD5815 			

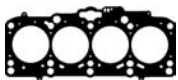

AG8800

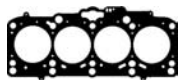

AG8960

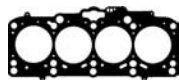

AG8970

442



81.00

Diesel



BLB	4 Cyl.	1968cc	103kW (140)PS	Turbo Intercooled	TD17377	948
A4	11/04→06/08	A6	07/04→10/08			

TB743 141x30	TBK262 Ten bolt hole 10				

	OE	MAT.		Y	H	
V94697 ■ 29.20 x 6.00 x 87.80	03G 109 601B		45°			VAG96237B ■ ■ ■ 42.00 x 6.02 x 10.07
V98097 ■ 25.40 x 6.00 x 87.50	03G 109 611D		45°			







AG8970 MLS, 1.550mm, 1 Hole AG8800 MLS, 1.630mm, 2 Holes AG8960 MLS, 1.710mm, 3 Holes	CG8410 ▲	HBS364 ⊕ M12x1.75x149mm (x10)	JD5806 ■ JD5815 ■	JM7029	PA5041 (x16) 6.00x8.8/12.20x10.00 866N W (FPM) HR791 ■	NA5124
AG8800	AG8960	AG8970				







443



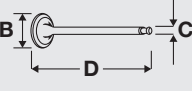







81.00
Diesel



BMM	4 Cyl.	18:1	1968cc	103kW (140)PS	Turbo Intercooled	TD18203	954
BMM	4 Cyl.	18:1	1968cc	103kW (140)PS	Turbo Intercooled	TD18269	954
BMM	4 Cyl.	18:1	1968cc	103kW (140)PS	Turbo Intercooled	TD18482	954
BMM	4 Cyl.	18:1	1968cc	103kW (140)PS	Turbo Intercooled	TD19315	954

A3	06/05→06/08	ALTEA	11/05→	ALTEA XL	10/06→
CADDY	09/07→08/10	EOS	06/06→05/08	GOLF	08/04→
JETTA	10/05→10/10	LEON	10/05→	OCTAVIA	11/05→
TOLEDO	11/05→05/09	TOURAN	12/05→05/10		

					
TB680 120x30	TBK270	CAM904			FOL175 (x8)

	
B x C x D	E x F x G
	
	
V94649 ■ 36.00 x 7.00 x 89.40	VAG96041B ■ ■ ■ 36.50 x 7.00 x 12.08
038 109 601E	45° Y H
V94650 ■ 31.40 x 7.00 x 89.00	45° ss H
038 109 611E	

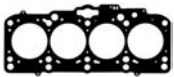
								
AG9630 MLS, 1.450mm, 1 Hole	CG8410 ▲	HBS300 ⊕ M12x1.75x166mm (x10)	JD170 ■ JD5992 ■ [1] (Steel)	JM7031 (Elastomer) JM7107 (ACM)	HR599 ■ HR816 ■	NA5124 32.00x47.00x10.00mm PTFE/ACM		
AG9640 MLS, 1.530mm, 2 Holes								
AG9650 MLS, 1.610mm, 3 Holes								

AG9640

[1] With Heat Shield

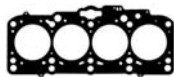
AG9650

[1] Mit Hitzeschild

444



81.00

Diesel



BMN	4 Cyl.	18.5:1	1968cc	125kW (170)PS	Turbo Intercooled	TD18471	948
BMN	4 Cyl.	18.5:1	1968cc	125kW (170)PS	Turbo Intercooled	TD18991	948
BMN	4 Cyl.	18.5:1	1968cc	125kW (170)PS	Turbo Intercooled	TD18977	948
BMN	4 Cyl.	18.5:1	1968cc	125kW (170)PS	Turbo Intercooled	TD20735	948

A3	03/06 →	ALTEA	03/06 →	ALTEA XL	06/07 →
GOLF	11/05 → 11/08	JETTA	10/06 → 10/10	LEON	05/06 →
OCTAVIA	04/06 →	TOLEDO	01/06 → 05/09	TOURAN	12/05 → 05/10

TB743					
141x30					

	OE	MAT.			
B x C x D					E x F x G
V94697	03G 109 601B		45°	Y H	VAG96237B
29.20 x 6.00 x 87.80		MB			
V98007	03G 109 601A		45°		
29.20 x 6.00 x 88.45		MB			
V94698	03G 109 611B		45°	ss H	
25.50 x 6.00 x 88.10		MG			
V98097	03G 109 611D		45°		
25.40 x 6.00 x 87.50		MG			

AG8970 MLS, 1.550mm, 1 Hole	CG8410 ▲		HBS364	JD5806	JM7031 (Elastomer)	PA5041 (x16) 6.00x8.8/12.20x10.00 866N W (FPM) HR791	NA5124 (x2) 32.00x47.00x10.00mm PTFE/ACM
AG8800 MLS, 1.630mm, 2 Holes			M12x1.75x149mm (x10)	→11/06 Metal JD5805			
AG8960 MLS, 1.710mm, 3 Holes				12/06 → Elastomer JD5815			

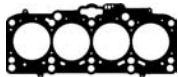

AG8800

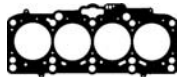

AG8960

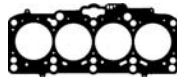

AG8970

445

81.00

Diesel



BMP	4 Cyl.	18.5:1	1968cc	103kW (140)PS	Turbo Intercooled	TD18136	954
BMP	4 Cyl.	18.5:1	1968cc	103kW (140)PS	Turbo Intercooled	TD20945	954

PASSAT	03/05→	SUPERB	03/08→
---------------	--------	---------------	--------

TB680 120x30	TBK270	CAM904	FOL175 (x8)

V94649 ■ 36.00 x 7.00 x 89.40	V94650 ■ 31.40 x 7.00 x 89.00	VAG96041B ■ ■ ■ 36.50 x 7.00 x 12.08
OE: 038 109 601E	OE: 038 109 611E	
MAT. MB	MAT. MG	
45° Y H	45° ss H	

AG9630 MLS, 1.450mm, 1 Hole	AG9640 MLS, 1.530mm, 2 Holes	AG9650 MLS, 1.610mm, 3 Holes	HBS300 ⊕ M12x1.75x166mm (x10)	JD170 ■ JD5992 ■ [1] (Steel)	JM7107 (ACM)	HR599 ■ HR816 ■	NA5124 32.00x47.00x10.00mm PTFE/ACM



AG9640

AG9650

[1] With Heat Shield

[1] Mit Hitzeschild

446

 81.00

Diesel











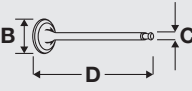
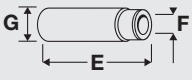

BMR	4 Cyl.	1968cc	125kW (170)PS	Turbo Intercooled	TD18188	948
BVE	4 Cyl.	1968cc	90kW (122)PS	Turbo Intercooled	TD18543	948

PASSAT 08/05→





					
--	---	---	---	--	---

TB743 141x30	TBK262 Ten bolt hole 10				
------------------------	-----------------------------------	--	--	--	--

	
B x C x D	E x F x G

B x C x D	OE	MAT.	45°	Y	H	VAG96237B 
V94697 	03G 109 601B		45°	Y	H	VAG96237B  42.00 x 6.02 x 10.07
29.20 x 6.00 x 87.80		MB				
V98007 	03G 109 601A		45°			
29.20 x 6.00 x 88.45		MB				
V94698 	03G 109 611B		45°	ss	H	
25.50 x 6.00 x 88.10		MG				
V98097 	03G 109 611D		45°			
25.40 x 6.00 x 87.50		MG				

							
---	---	---	---	---	--	---	---

AG8970 MLS, 1.550mm, 1 Hole	CG8410 ▲	HBS364 ⊙ M12x1.75x149mm (x10)	JD5806  →11/06 Metal	JM7031 (Elastomer)	PA5041 (x16) 6.00x8.8/12.20x10.00 866N W (FPM) HR791 	NA5124 (x2) 32.00x47.00x10.00mm PTFE/ACM
AG8800 MLS, 1.630mm, 2 Holes			JD5805  12/06→ Elastomer			
AG8960 MLS, 1.710mm, 3 Holes			JD5815 			

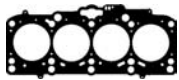

AG8800

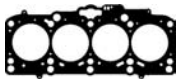

AG8960

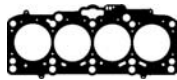

AG8970

447



81.00

Diesel



BNA	4 Cyl.	1968cc	100kW (136)PS	Turbo Intercooled	TD18009	948
BRF	4 Cyl.	1968cc	100kW (136)PS	Turbo Intercooled	TD18748	948
A4	11/04→06/08	A6	07/04→08/11			

TB743 141x30	TBK262 Ten bolt hole 10				

B x C x D	OE	MAT.	45°	Y	H
V94697 ■ 29.20 x 6.00 x 87.80	03G 109 601B	 MB	45°		
V98097 ■ 25.40 x 6.00 x 87.50	03G 109 611D	 MG	45°		
					VAG96237B ■ ■ ■ 42.00 x 6.02 x 10.07

AG8970 MLS, 1.550mm, 1 Hole AG8800 MLS, 1.630mm, 2 Holes AG8960 MLS, 1.710mm, 3 Holes	CG8410 ▲		HBS364 ⊕ M12x1.75x149mm (x10)	JD5805 ■ Elastomer JD5806 ■ Metal JD5815 ■	JM7029	PA5041 (x16) 6.00x8.8/12.20x10.00 866N W (FPM) HR791 ■	NA5124 32.00x47.00x10.00mm PTFE/ACM
AG8800	AG8960	AG8970					

448



81.00

Diesel



BPW	4 Cyl.	1968cc	103kW (140)PS	Turbo Intercooled	TD18010	954
A4	11/04→03/09					

TB680 120x30	TBK270	CAM904			FOL175 (x8)

B x C x D	OE	MAT.	45°		H
V95087 ■ 35.50 x 6.98 x 88.80	038 109 601F	 MB	45°		H
V95088 ■ 31.45 x 6.96 x 88.40	038 109 611G	 MG	45°	ss	H

AG9630 MLS, 1.450mm, 1 Hole AG9640 MLS, 1.530mm, 2 Holes AG9650 MLS, 1.610mm, 3 Holes	CC5231 ▲		HBS300 ⊕ M12x1.75x166mm (x10)	JD170 ■ JD600 ■	JM5203	HR599 ■ HR646 ■ HR816 ■	NA5124 32.00x47.00x10.00mm PTFE/ACM
AG9640	AG9650						

449



81.00

Diesel



BRC 4 Cyl. 18:1 1968cc 100kW (136)PS Turbo Intercooled TD20672 955

A4 01/06 → 03/09

TB680 120x30	TBK270	CAM904			FOL175 (x8)

B x C x D	E x F x G
V95087 ■ 35.50 x 6.98 x 88.80	V95088 ■ 31.45 x 6.96 x 88.40
OE 038 109 601F	OE 038 109 611G
MAT. MB	MAT. MG
45°	45° ss
H	H

AG9630 MLS, 1.450mm, 1 Hole AG9640 MLS, 1.530mm, 2 Holes AG9650 MLS, 1.610mm, 3 Holes	CC5231 ▲		HBS300 ⊕ M12x1.75x166mm (x10)	JD170 ■ JD600 ■ ⊕JE5075	JM5203	HR599 ■ HR646 ■ HR816 ■	NA5124 32.00x47.00x10.00mm PTFE/ACM
AG9640	AG9650						

450



81.00

Diesel



BRD 4 Cyl. 1968cc 125kW (170)PS Turbo Intercooled TD20402 956

A4 06/06 → 06/08

TB743 141x30	TBK262 Ten bolt hole 10				

B x C x D	E x F x G
V94697 ■ 29.20 x 6.00 x 87.80	V98007 ■ 29.20 x 6.00 x 88.45
V94698 ■ 25.50 x 6.00 x 88.10	V98097 ■ 25.40 x 6.00 x 87.50
OE 03G 109 601B	OE 03G 109 601A
OE 03G 109 611B	OE 03G 109 611D
MAT. MB	MAT. MB
MAT. MG	MAT. MG
45°	45°
45°	45° ss
45°	45°
H	H
	VAG96237B ■ ■ 42.00 x 6.02 x 10.07

AG8970 MLS, 1.550mm, 1 Hole AG8800 MLS, 1.630mm, 2 Holes AG8960 MLS, 1.710mm, 3 Holes	CG8410 ▲		HBS364 ⊕ M12x1.75x149mm (x10)	JD5806 ■ JD5815 ■	JM7029	PA5041 (x16) 6.00x8.8/12.20x10.00 866N W (FPM) HR791 ■	NA5124 32.00x47.00x10.00mm PTFE/ACM
AG8800	AG8960	AG8970					

451	81.00	Diesel				
BRE	4 Cyl.	1968cc	103kW (140)PS	Turbo Intercooled	TD18029	948
A4	11/04→06/08	A6	07/04→10/08			

TB743 141x30	TBK262 Ten bolt hole 10				

B x C x D	E x F x G
V94697 29.20 x 6.00 x 87.80	VAG96237B 42.00 x 6.02 x 10.07
V98097 25.40 x 6.00 x 87.50	

AG8970 MLS, 1.550mm, 1 Hole AG8800 MLS, 1.630mm, 2 Holes AG8960 MLS, 1.710mm, 3 Holes	CG8410 ▲	HBS364 ⊕ M12x1.75x149mm (x10)	JD5806 JD5815	JM7029	PA5041 (x16) 6.00x8.8/12.20x10.00 866N W (FPM) HR791	NA5124 32.00x47.00x10.00mm PTFE/ACM
AG8800	AG8960	AG8970				

452	81.00	Diesel					
BRT	4 Cyl.	18.5:1	1968cc	103kW (140)PS	Turbo Intercooled	TD19105	954
BRT	4 Cyl.	18.5:1	1968cc	103kW (140)PS	Turbo Intercooled	TD19388	954

ALHAMBRA	11/05→03/10	SHARAN	11/05→03/10
-----------------	-------------	---------------	-------------

TB680 120x30	TBK270	CAM904	FOL175 (x8)

B x C x D	E x F x G
V94649 36.00 x 7.00 x 89.40	VAG96041B 36.50 x 7.00 x 12.08
V94650 31.40 x 7.00 x 89.00	

AG9630 MLS, 1.450mm, 1 Hole AG9640 MLS, 1.530mm, 2 Holes AG9650 MLS, 1.610mm, 3 Holes			HBS300 ⊕ M12x1.75x166mm (x10)	JD170 JD600	JM7113 (Elastomer)	HR599 HR816	NA5124 32.00x47.00x10.00mm PTFE/ACM
AG9640	AG9650						

453	81.00	Petrol	
BSA	4 Cyl.	1781cc	74kW (100)PS
TD25894			
HR646			

454	81.00	Diesel	
BSS	4 Cyl.	18.5:1	1968cc
		103kW (140)PS	Turbo Intercooled
TD19317 957			
SUPERB 10/05→03/08			

TB680 120x30	TBK270	CAM904			FOL175 (x8)



<p>B x C x D</p>	<p>OE</p>	<p>MAT.</p>	<p>45° Y H</p>	<p>45° ss H</p>	<p>Ex F x G</p>
V94649 ■ 36.00 x 7.00 x 89.40	038 109 601E				VAG96041B ■ ■ ■ 36.50 x 7.00 x 12.08
V94650 ■ 31.40 x 7.00 x 89.00	038 109 611E				







AG9630 MLS, 1.450mm, 1 Hole	CC5231 ▲		HBS300 ⊕ M12x1.75x166mm (x10)	JD170 ■ JD600 ■ JE5075	JM5203	HR599 ■ HR816 ■	NA5124 32.00x47.00x10.00mm PTFE/ACM
AG9640 MLS, 1.530mm, 2 Holes							
AG9650 MLS, 1.610mm, 3 Holes							
AG9640	AG9650						









455	81.00	Diesel	
BUY	4 Cyl.	1968cc	120kW (163)PS
			Turbo Intercooled
TD20403 956			
A3 06/06→06/08			



TB743 141x30	TBK262 Ten bolt hole 10				





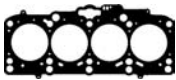
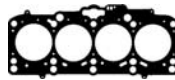
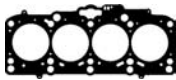

AG8970 MLS, 1.550mm, 1 Hole	CG8410 ▲			JD5806 ■ →11/06 →Ch.8P.7.120 000 JD5805 ■ Ch.8P.7.120 000 →	JM7031 (Elastomer)	PA5041 6.00x8.8/12.20x10.00 866N W (FPM) HR791 ■	NA5124 (x2) 32.00x47.00x10.00mm PTFE/ACM
AG8800 MLS, 1.630mm, 2 Holes							
AG8960 MLS, 1.710mm, 3 Holes							
AG8800	AG8960	AG8970					









456	 81.00	Diesel					
BUZ	4 Cyl.	18.5:1	1968cc	120kW (163)PS	Turbo Intercooled	TD20499	956
PASSAT 08/05→							

					
TB743 141x30	TBK262 Ten bolt hole 10		KIT		

							
AG8970 MLS, 1.550mm, 1 Hole AG8800 MLS, 1.630mm, 2 Holes AG8960 MLS, 1.710mm, 3 Holes				JD5806 ■ →11/06 →Ch.3C-7-120 000 JD5805 ■ 12/06→ Ch.3C-7-120 001→		PA5041 (x16) 6.00x8.8/12.20x10.00 866N W (FPM) HR791 ■	NA5124 32.00x47.00x10.00mm PTFE/ACM
							
AG8800	AG8960	AG8970					

457	 81.00	Diesel					
BVA	4 Cyl.	18:1	1968cc	120kW (163)PS	Turbo Intercooled	TD20529	948
A4 06/06→06/08							

					
TB743 141x30	TBK262 Ten bolt hole 10		KIT		

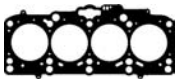
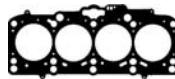
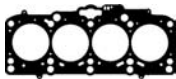
							
AG8970 MLS, 1.550mm, 1 Hole AG8800 MLS, 1.630mm, 2 Holes AG8960 MLS, 1.710mm, 3 Holes	CG8410 ▲			JD5806 ■ JD5815 ■ JE5075	JM7029	PA5041 (x16) 6.00x8.8/12.20x10.00 866N W (FPM) HR791 ■	NA5124 (x2) 32.00x47.00x10.00mm PTFE/ACM
							
AG8800	AG8960	AG8970					

VW GROUP

458



81.00

Diesel



BVG 4 Cyl. 18:1 1968cc 89kW (121)PS Turbo Intercooled TD20496 956

A4 09/05→09/06 A6 09/05→06/06

TB680 120x30	TBK270				



AG8970 MLS, 1.550mm, 1 Hole AG8800 MLS, 1.630mm, 2 Holes AG8960 MLS, 1.710mm, 3 Holes	CG8410 ▲			JD5806 ■ JD5815 ■ JE5075	JM7029	PA5041 (x16) 6.00x8.8/12.20x10.00 866N W (FPM) HR791 ■	NA5124 32.00x47.00x10.00mm PTFE/ACM
---	----------	--	--	--------------------------------	--------	---	--

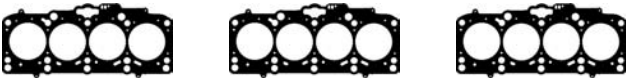

AG8800 AG8960 AG8970

459



81.00

Diesel



BVH 4 Cyl. 1968cc 100kW (136)PS Turbo Intercooled TD20520 955

SHARAN 11/05→03/10

TB680 120x30	TBK270				

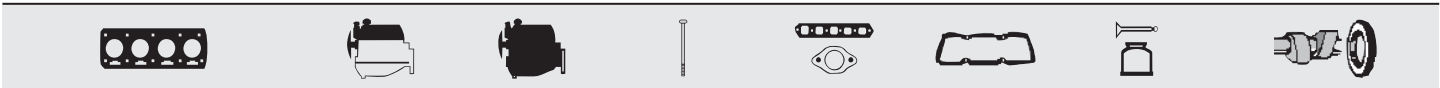

AG9630 MLS, 1.450mm, 1 Hole AG9640 MLS, 1.530mm, 2 Holes AG9650 MLS, 1.610mm, 3 Holes			HBS300 ⊙ M12x1.75x166mm (x10)	JD170 ■ JD600 ■	JM7113 (Elastomer)	HR599 ■ HR816 ■	NA5124 32.00x47.00x10.00mm PTFE/ACM
---	--	--	----------------------------------	--------------------	-----------------------	--------------------	--



AG9640 AG9650

460	81.00	Diesel					
BWV	4 Cyl.	18.5:1	1968cc	88kW (120)PS	Turbo Intercooled	TD20498	956
PASSAT	11/05→05/07						

TB743 141x30	TBK262 Ten bolt hole 10				

AG8970 MLS, 1.550mm, 1 Hole AG8800 MLS, 1.630mm, 2 Holes AG8960 MLS, 1.710mm, 3 Holes				JD5806 ■ →11/06 JD5805 ■ 12/06→	JM7031 (Elastomer)	PA5041 (x16) 6.00x8.8/12.20x10.00 866N W (FPM) HR791 ■	NA5124 (x2) 32.00x47.00x10.00mm PTFE/ACM
AG8800	AG8960	AG8970					

461	81.00	Diesel					
CAAA Euro 5	4 Cyl.	1968cc	62kW (84)PS	Turbo Intercooled	TD23411	959	
CFFD	4 Cyl.	16.5:1	1968cc	81kW (110)PS	Turbo Intercooled	TD24215	963

MULTIVAN	09/09→	TIGUAN	05/10→	TRANSPORTER	09/09→
-----------------	--------	---------------	--------	--------------------	--------

V95099 ■ 28.10 x 5.97 x 99.30	03L 109 601		45°		H	
V94645 ■ 26.00 x 6.00 x 98.90	030 109 611S		45°	ss	H	

462





 81.00





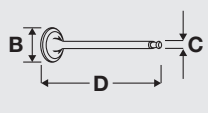
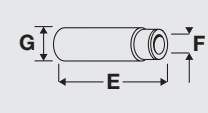



Diesel



CAAB Euro 5	4 Cyl.		1968cc	75kW (102)PS	Turbo Intercooled	TD23412	959
CAAC Euro 5	4 Cyl.		1968cc	103kW (140)PS	Turbo Intercooled	TD23414	959
CAAE	4 Cyl.		1968cc	100kW (136)PS	Turbo Intercooled	TD24473	959
CAHB	4 Cyl.		1968cc	120kW (163)PS	Turbo Intercooled	TD20864	960
CBAB	4 Cyl.	16:1	1968cc	103kW (140)PS	Turbo Intercooled	TD20799	960
CBAB	4 Cyl.	16:1	1968cc	103kW (140)PS	Turbo Intercooled	TD20828	960
CBBA	4 Cyl.		1968cc	120kW (163)PS	Turbo Intercooled	TD21661	955
CBBB	4 Cyl.	16:1	1968cc	125kW (170)PS	Turbo Intercooled	TD20939	961
CBBB	4 Cyl.	16:1	1968cc	125kW (170)PS	Turbo Intercooled	TD20944	961
CBBB	4 Cyl.	16:1	1968cc	125kW (170)PS	Turbo Intercooled	TD20949	961
CBDC	4 Cyl.	16:1	1968cc	81kW (110)PS	Turbo Intercooled	TD21109	960
CCHA	4 Cyl.		1968cc	103kW (140)PS	Turbo Intercooled	TD24471	959
CCHB	4 Cyl.		1968cc	100kW (136)PS	Turbo Intercooled	TD24474	959
CFCA Euro 5	4 Cyl.		1968cc	132kW (180)PS	Bi-Turbo Intercooled	TD23421	959
CFHF	4 Cyl.	16.5:1	1968cc	81kW (110)PS	Turbo Intercooled	TD23585	963
CFHF	4 Cyl.	16.5:1	1968cc	81kW (110)PS	Turbo Intercooled	TD24366	963
CLJA	4 Cyl.	16.5:1	1968cc	103kW (140)PS	Turbo Intercooled	TD23590	963
CLJA	4 Cyl.	16.5:1	1968cc	103kW (140)PS	Turbo Intercooled	TD23938	963
CMEA	4 Cyl.		1968cc	105kW (143)PS	Turbo Intercooled	TD23939	955

A3	05/03 →	A4	11/07 →	A4 Allroad	04/09 →
A5	08/08 →	A6	04/09 → 08/11	CADDY	08/10 →
EOS	05/08 →	GOLF	10/08 →	MULTIVAN	09/09 →
OCTAVIA	03/10 →	PASSAT	03/05 →	PASSAT CC	05/08 →
Q5	11/08 →	SCIROCCO	05/09 →	SUPERB	07/08 →
TIGUAN	09/07 →	TRANSPORTER	09/09 →	TT	06/08 →
YETI	11/09 →				

		
B x C x D	OE	E x F x G
V95099 	03L 109 601	VAG96237B 
28.10 x 5.97 x 99.30		42.00 x 6.02 x 10.07
V94645 	030 109 611S	
26.00 x 6.00 x 98.90		









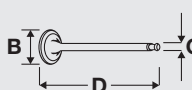

							
						PA5041 (x16) 6.00x8.8/12.20x10.00 866N W (FPM) HR791	NA5124

463

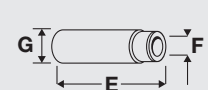
81.00
Diesel

CAGA	4 Cyl.	16.5:1	1968cc	105kW (143)PS	Turbo Intercooled	TD20597	960
CAGA	4 Cyl.	16.5:1	1968cc	105kW (143)PS	Turbo Intercooled	TD22243	960
CAGC	4 Cyl.	16.5:1	1968cc	88kW (120)PS	Turbo Intercooled	TD21118	955
CAGC	4 Cyl.	16.5:1	1968cc	88kW (120)PS	Turbo Intercooled	TD22669	955
CAHA	4 Cyl.	16.5:1	1968cc	125kW (170)PS	Turbo Intercooled	TD20602	960
CAHA	4 Cyl.	16.5:1	1968cc	125kW (170)PS	Turbo Intercooled	TD22244	960
CBDB	4 Cyl.	16:1	1968cc	103kW (140)PS	Turbo Intercooled	TD21070	961
CBDB	4 Cyl.	16:1	1968cc	103kW (140)PS	Turbo Intercooled	TD23586	961
CBDB	4 Cyl.	16:1	1968cc	103kW (140)PS	Turbo Intercooled	TD24327	961
CEGA	4 Cyl.	16:1	1968cc	125kW (170)PS	Turbo Intercooled	TD20905	961
CEGA	4 Cyl.	16:1	1968cc	125kW (170)PS	Turbo Intercooled	TD22674	961
CEGA	4 Cyl.	16:1	1968cc	125kW (170)PS	Turbo Intercooled	TD24125	961
CFFB	4 Cyl.	16.5:1	1968cc	103kW (140)PS	Turbo Intercooled	TD23178	963
CFFB	4 Cyl.	16.5:1	1968cc	103kW (140)PS	Turbo Intercooled	TD23589	963
CFFB	4 Cyl.	16.5:1	1968cc	103kW (140)PS	Turbo Intercooled	TD23859	963
CFFB	4 Cyl.	16.5:1	1968cc	103kW (140)PS	Turbo Intercooled	TD24450	963
CFGB	4 Cyl.	16.5:1	1968cc	125kW (170)PS	Turbo Intercooled	TD23180	963
CFGB	4 Cyl.	16.5:1	1968cc	125kW (170)PS	Turbo Intercooled	TD23591	963
CFGB	4 Cyl.	16.5:1	1968cc	125kW (170)PS	Turbo Intercooled	TD23857	963
CFGB	4 Cyl.	16.5:1	1968cc	125kW (170)PS	Turbo Intercooled	TD24451	963
CFHC	4 Cyl.	16.5:1	1968cc	103kW (140)PS	Turbo Intercooled	TD23587	963
CFHC	4 Cyl.	16.5:1	1968cc	103kW (140)PS	Turbo Intercooled	TD24315	963
CFHC	4 Cyl.	16.5:1	1968cc	103kW (140)PS	Turbo Intercooled	TD24326	963
CFJA	4 Cyl.	16.5:1	1968cc	125kW (170)PS	Turbo Intercooled	TD23588	963
CFJA	4 Cyl.	16.5:1	1968cc	125kW (170)PS	Turbo Intercooled	TD24333	963
CFJA	4 Cyl.	16.5:1	1968cc	125kW (170)PS	Turbo	TD24994	963
CLCB	4 Cyl.	16.5:1	1968cc	103kW (140)PS	Turbo Intercooled	TD24598	963
CLCB	4 Cyl.	16.5:1	1968cc	103kW (140)PS	Turbo Intercooled	TD24600	963
CLCB	4 Cyl.	16.5:1	1968cc	103kW (140)PS	Turbo	TD25102	963

A3	05/03→	A4	11/07→	A4 Allroad	04/09→
A5	08/08→	A6	10/08→08/11	ALHAMBRA	06/10→
ALTEA	03/04→	ALTEA XL	10/06→	BEETLE	04/11→
CADDY	11/10→	CC	11/11→	EOS	05/08→
EXEO	12/08→	GOLF	01/05→	JETTA	08/05→
LEON	07/05→	OCTAVIA	02/04→	PASSAT	08/10→
PASSAT ALLTRACK	01/12→	PASSAT CC	06/08→	Q3	09/11→
Q5	11/08→	SCIROCCO	08/08→	SHARAN	05/10→
SUPERB	07/08→	TIGUAN	09/07→	TOLEDO	01/06→05/09
TOURAN	12/05→	TT	06/08→	YETI	05/09→

 <p>B x C x D</p>	OE	 <p>MAT.</p>	 <p>45°</p>	 <p>H</p>	 <p>E x F x G</p>
V95099  28.10 x 5.97 x 99.30	030 109 611S	 MB	45°	H	VAG96237B  42.00 x 6.02 x 10.07
V94645  26.00 x 6.00 x 98.90		 MG	45°	ss H	

464

81.00
Diesel

CAGB	4 Cyl.	1968cc	100kW (136)PS	Turbo Intercooled	TD20598	960
A4	11/07→	A4 Allroad	09/09→	A5	09/09→	
A6	07/04→08/11	Q5	08/09→			

<p>B x C x D</p>	OE	MAT.	<p>45°</p>	<p>H</p>	<p>E x F x G</p>
V95099 28.10 x 5.97 x 99.30 V94645 26.00 x 6.00 x 98.90	03L 109 601 030 109 611S	 MB MG	45° 45° ss	H H	VAG96237B 42.00 x 6.02 x 10.07

				JD5815		PA5041 (x16) 6.00x8.8/12.20x10.00 866N W (FPM) HR791	NA5124 32.00x47.00x10.00mm PTFE/ACM

465

81.00
Diesel

CBAA	4 Cyl.	16:1	1968cc	100kW (136)PS	Turbo Intercooled	TD20798	960
CBAA	4 Cyl.	16:1	1968cc	100kW (136)PS	Turbo Intercooled	TD20825	960
A3	05/03→	GOLF	10/08→11/12	PASSAT	03/05→11/10		
PASSAT CC	06/08→05/11	TIGUAN	11/07→				

<p>B x C x D</p>	OE	MAT.	<p>45°</p>	<p>H</p>	<p>E x F x G</p>
V95099 28.10 x 5.97 x 99.30 V94645 26.00 x 6.00 x 98.90	03L 109 601 030 109 611S	 MB MG	45° 45° ss	H H	VAG96237B 42.00 x 6.02 x 10.07

AG8970 MLS, 1.550mm, 1 Hole AG8800 MLS, 1.630mm, 2 Holes AG8960 MLS, 1.710mm, 3 Holes	CG8410		HBS364 M12x1.75x149mm (x10)	JD5805 Elastomer JD5806 Metal JD5815	JM7031 (Elastomer)	PA5041 (x16) 6.00x8.8/12.20x10.00 866N W (FPM) HR791	NA5124

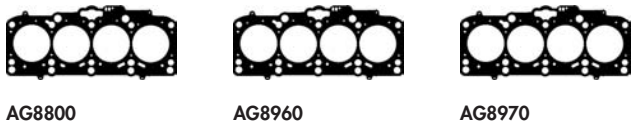

466

81.00
Diesel

CBAC	4 Cyl.	16:1	1968cc	105kW (143)PS	Turbo Intercooled	TD20800	960
CFHA	4 Cyl.	16.5:1	1968cc	81kW (110)PS	Turbo Intercooled	TD23584	962
PASSAT	01/09→	PASSAT CC	05/09→11/10	YETI	11/09→		

<p>B x C x D</p>	OE	MAT.	<p>45°</p>	<p>H</p>	<p>E x F x G</p>
V94645 26.00 x 6.00 x 98.90	030 109 611S	 MG	45° ss	H	VAG96237B 42.00 x 6.02 x 10.07

467		81.00		Diesel			
CBDA	4 Cyl.	16:1	1968cc	100kW (136)PS	Turbo Intercooled	TD22715	960
GOLF	10/03→		JETTA	09/05→10/10			
	B x C x D	OE	MAT.				
	G x E x F						
V95099	03L 109 601		45°	H		VAG96237B	
28.10 x 5.97 x 99.30		MB				42.00 x 6.02 x 10.07	
V94645	030 109 611S		45°	ss	H		
26.00 x 6.00 x 98.90		MG					
			HBS364	JD5815		PA5041 (x16)	NA5124
			M12x1.75x149mm (x10)			6.00x8.8/12.20x10.00	32.00x47.00x10.00mm PTFE/ACM
						866N W (FPM)	
						HR791	

468		81.00		Diesel			
CBEA	4 Cyl.	18:1	1968cc	103kW (140)PS	Turbo Intercooled	TD22176	955
	B x C x D	OE	MAT.				
	G x E x F						
V95099	03L 109 601		45°	H			
28.10 x 5.97 x 99.30		MB					
V94645	030 109 611S		45°	ss	H		
26.00 x 6.00 x 98.90		MG					



469		81.00		Diesel			
CBJB	4 Cyl.		1968cc	55kW (75)PS		TD22525	962
AG9640 MLS, 1.530mm, 2 Holes	CC5231				JM5203	HR646	





470		81.00		Diesel			
CBHA	4 Cyl.		1968cc	47kW (64)PS		TD22527	962
AG9640 MLS, 1.530mm, 2 Holes					JD5992	JM7107	HR646
					(Steel)	(ACM)	



[1] With Heat Shield [1] Mit Hitzschild

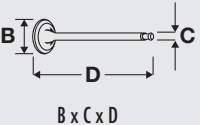
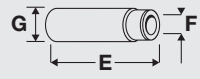



471		81.00		Diesel			
CBKA	4 Cyl.		1968cc	74kW (100)PS		TD22528	962
AG9630 MLS, 1.450mm, 1 Hole					JD170	JM7107	HR646
AG9640 MLS, 1.530mm, 2 Holes					JD5992	(ACM)	
					(Steel)		



[1] With Heat Shield [1] Mit Hitzschild

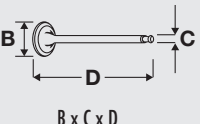

472		81.00	Diesel				
CFFA	4 Cyl.	16.5:1	1968cc	100kW (136)PS	Turbo Intercooled	TD23312	963
CFFA	4 Cyl.	16.5:1	1968cc	100kW (136)PS	Turbo Intercooled	TD23858	963
CFFA	4 Cyl.	16.5:1	1968cc	100kW (136)PS	Turbo Intercooled	TD25404	963
A3	05/03→		ALHAMBRA	06/10→05/11		CC	11/11→
EOS	11/10→		GOLF	10/08→11/12		PASSAT	08/10→
PASSAT CC	06/08→05/11		Q3	09/11→		SHARAN	05/10→
TIGUAN	11/07→						







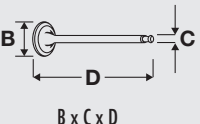

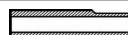

	
B x C x D	E x F x G
V95099 	VAG96237B 
03L 109 601	42.00 x 6.02 x 10.07
28.10 x 5.97 x 99.30	
V94645 	
030 109 611S	
26.00 x 6.00 x 98.90	
MAT. MB	
MAT. MG	
45°	
45° ss	
H	
H	



473		81.00	Diesel				
CFHD	4 Cyl.	16.5:1	1968cc	105kW (143)PS	Turbo Intercooled	TD23582	955
IBIZA	01/10→						







	
B x C x D	E x F x G
V94645 	VAG96237B 
030 109 611S	42.00 x 6.02 x 10.07
26.00 x 6.00 x 98.90	
MAT. MG	
45°	
45° ss	
H	



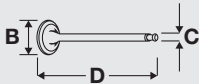



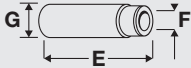

474		81.00	Diesel				
CJAA	4 Cyl.	16.5:1	1968cc	103kW (140)PS	Turbo Intercooled	TD23179	959
BEETLE	04/11→		GOLF	10/08→		JETTA	08/05→

	
B x C x D	E x F x G
V94645 	VAG96237B 
030 109 611S	42.00 x 6.02 x 10.07
26.00 x 6.00 x 98.90	
MAT. MG	
45°	
45° ss	
H	

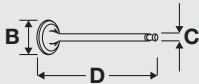
							
				JD5815 		PA5041 (x16) 6.00x8.8/12.20x10.00 866N W (FPM) HR791 	NA5124 32.00x47.00x10.00mm PTFE/ACM

475	 81.00	Diesel				
CJCA	4 Cyl.	1968cc	105kW (143)PS	Turbo	TD24949	955
CJCA	4 Cyl.	1968cc	105kW (143)PS	Turbo Intercooled	TD26497	
A4	11/07→	A4 Allroad	09/09→	A5	09/09→	
EXEO	12/08→	Q5	08/09→			

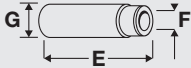
	OE		MAT.				
V94645 	030 109 611S		MG	45°	ss	H	Ex F x G
26.00 x 6.00 x 98.90							

476	 81.00	Diesel					
CMFA	4 Cyl.	1968cc	105kW/143PS	TD26714			
A4	11/07→	A5	09/09→				
	OE		MAT.				
V94645 	030 109 611S		MG	45°	ss	H	Ex F x G
26.00 x 6.00 x 98.90							

VW GROUP

477	81.00	Petrol			
HP	5 Cyl.	10:1	1994cc	85kW (115)PS	TD16429 967
HP	5 Cyl.	10:1	1994cc	85kW (115)PS	TD266 967
80	10/83→09/84	90	10/84→03/87	COUPE	09/83→07/86
PASSAT	08/83→03/88	SANTANA	08/83→12/84		

TB207 120x18 08/84→	TBK048 08/84→		KIT		
TB602 113x19 →07/84					

B x C x D	E x F x G
V91338 ■ 38.10 x 7.97 x 91.90	VAG92061B ■ ■ ■ 36.70 x 8.00 x 12.08
V91340 ■ 33.30 x 7.95 x 91.20	VAG92105B ■ ■ ■ 42.30 x 7.99 x 12.08
OE: 035 109 601K MAT. MD 053 109 611 MG	45° 45° H

BM840 Fibre Composite	DM840	HBS024 ⊕ M11x1.50x95mm (x12)	JC261 ■ JC152 ■ (x5) JE689	JN438 (Elastomer) HL460 ■ (Cork) HM5277 ■ (Elastomer)	HR615 ■	NA5001 (x2) 32.00x47.00x10.00mm FPM



BM840

478	81.00	Petrol			
JL	5 Cyl.	10:1	1994cc	81kW (110)PS	TD271

BM840 Fibre Composite	DM840	JC261 ■ JC152 ■ (x4) JE689	JN438 (Elastomer) HL460 ■ (Cork) HM5277 ■ (Elastomer)	HR615 ■	NA5001 32.00x47.00x10.00mm FPM NB446



BM840







479







 **81.00**



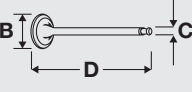



Petrol



JS	5 Cyl.	10:1	1994cc	85kW (115)PS	TD274	967
JS	5 Cyl.	10:1	1994cc	85kW (115)PS	TD5015	967
80	10/83→09/84		90	08/84→03/87	COUPE	09/83→07/86
PASSAT	08/83→03/88		SANTANA	08/83→12/84		

					
TB207 120x18 08/84→	TBK048 08/84→		KIT		FOL92 (x10)
TB602 113x19 →07/84					

					
B x C x D	E x F x G				
OE	MAT.				
V91338 ■	035 109 601K		45°		
38.10 x 7.97 x 91.90		MD			
V91030 ■	035 109 611F		45°	ss	H
33.30 x 7.95 x 98.60		MG			
V91340 ■	048 109 611A		45°		H
33.30 x 7.95 x 91.20		MG			
VAG92061B ■ ■ ■					
36.70 x 8.00 x 12.08					
VAG92105B ■ ■ ■					
42.30 x 7.99 x 12.08					

						
BM840 Fibre Composite	DM840	HBS024 ⊙ M11x1.50x95mm (x12)	JC261 ■ JC152 ■ (x5) ■ JE689	JN438 (Elastomer) HL460 ■ (Cork) HM5277 ■ (Elastomer)	HR615 ■	NA5001 (x2) 32.00x47.00x10.00mm FPM



BM840

VW GROUP

480



81.00

Petrol



KP	5 Cyl.	1994cc	85kW (115)PS	TD289	968
100	08/84→12/87				

TB207 120x18	TBK048				FOL92 (x10)

	OE	MAT.				
V91338 ■ 38.10 x 7.97 x 91.90	035 109 601K	MD	45°			VAG92061B ■ ■ 36.70 x 8.00 x 12.08
V91030 ■ 33.30 x 7.95 x 98.60	035 109 611F	MG	45°	ss	H	VAG92105B ■ ■ 42.30 x 7.99 x 12.08
V91340 ■ 33.30 x 7.95 x 91.20	048 109 611A	MG	45°		H	

BM840 Fibre Composite	DM840		HBS024 ⊕ M11x1.50x95mm (x12)	JC261 ■ JC152 ■ (x5) JE689	JN438 (Elastomer) HL460 ■ (Cork) HM5277 ■ (Elastomer)	HR615 ■	NA5001 32.00x47.00x10.00mm FPM

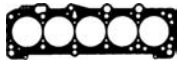

BM840

481



81.00

Petrol



NM	5 Cyl.	1994cc	118kW (160)PS	TD303	969
90	08/88→09/91				
	COUPE				
	08/89→07/91				

TB504 147x19					FOL92 (x20)

	OE	MAT.				
V91416 ■ 32.10 x 6.97 x 95.50	027 109 601C	MB	45°		H	VAG96157B ■ ■ 38.00 x 7.00 x 12.00
V91372 ■ 28.10 x 6.95 x 98.20	027 109 611D	MG cr	45°		H	

AY960 MLS	CY960		HBS269 ⊕ M11x1.50x141.5mm (x12)	JD602 ■ JD282 ■ (x5)	HL730 ■	HR5085 ■ (x5)	NA5001 32.00x47.00x10.00mm FPM



AY960

482







 **81.00**







Petrol



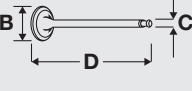



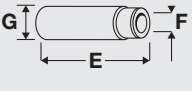



PS 5 Cyl. 10:1 1994cc 85kW (115)PS TD308 970

90 07/88→09/91

					
TB318 142x19					FOL92 (x10)

					
B x C x D	OE	MAT.	45°	H	E x F x G
V91407 ■ 39.60 x 7.97 x 91.90	048 109 601A		45°		VAG92061B ■ ■ ■ 36.70 x 8.00 x 12.08
V91340 ■ 33.30 x 7.95 x 91.20	048 109 611A		45°	H	

							
BM840 Fibre Composite			HBS021 ⊕ M12x1.75x115mm (x12) HBS024 ⊕ M11x1.50x95mm (x12)	JD327 ■ ■ ■ JD171 ■ ■ ■ JC152 ■ (x5) ⊕ JE689	JN438 (Elastomer) HL460 ■ (Cork) →Ch.8A-L-200 000 HM5277 ■ (Elastomer) →Ch.8A-L-200 000	HR615 ■	NA5001 32.00x47.00x10.00mm FPM

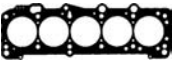

BM840

483



81.00

Petrol



RT 5 Cyl. 10:1 1994cc 85kW (115)PS TD318 967

100 01/88 → 11/90

TB207 120x18 →05/88	TBK048 →05/88		KIT		FOL92 (x10)
TB318 142x19 05/88 →					

V91407 ■ 39.60 x 7.97 x 91.90	V91340 ■ 33.30 x 7.95 x 91.20	VAG92061B ■ ■ ■ 36.70 x 8.00 x 12.08
OE: 048 109 601A	OE: 048 109 611A	
MAT. MD	MAT. MG	
45°	45°	H

BM840 Fibre Composite	DM840	HB5024 © M11x1.50x95mm (x12)	JC261 ■ JD327 ■ ■ ■ JD171 ■ ■ ■ JC152 ■ (x5) ⊙ JE689	JN438 (Elastomer) HL460 ■ (Cork) →Ch.44-L-072 000 HM5277 ■ (Elastomer) →Ch.44-L-072 000	HR615 ■	NA5001 32.00x47.00x10.00mm FPM



BM840

484







 **81.00**











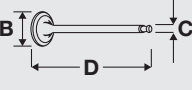

Petrol

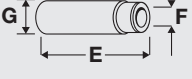







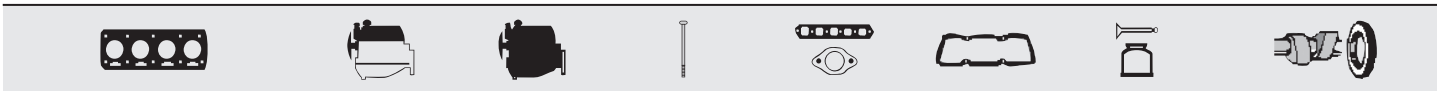

SK 5 Cyl. 1994cc **85kW (115)PS** **TD327** **967**

90 03/86→03/87 **COUPE** 03/86→04/88

					
TB207 120x18 85E000001 → TB602 113x19 →85D250000	TBK048 85E000001 →				FOL92 (x10)

						
B x C x D	OE	MAT.				E x F x G
V91338 	035 109 601K	 MD	45°			VAG92061B  36.70 x 8.00 x 12.08
V91030 	035 109 611F	 MG	45°	ss	H	VAG92105B  42.30 x 7.99 x 12.08
V91340 	048 109 611A	 MG	45°		H	



BM840 Fibre Composite	DM840		HBS024  M11x1.50x95mm (x12)	JC261  JC152  (x5)  JE689	HL460  (Cork) HM5227  (NBR)	HR615 	NA5001 32.00x47.00x10.00mm FPM
------------------------------	--------------	--	---	---	--	---	--



BM840

485

81.00

Petrol



SL 5 Cyl. 10:1 1994cc 83kW (113)PS TD328 967

100 08/86 → 11/87

TB207 120x18	TBK048				FOL92 (x10)

V91338 ■ 38.10 x 7.97 x 91.90	VAG92061B ■ ■ ■ 36.70 x 8.00 x 12.08
V91340 ■ 33.30 x 7.95 x 91.20	VAG92105B ■ ■ ■ 42.30 x 7.99 x 12.08

BM840 Fibre Composite	DM840		HBS024 ⊕ M11x1.50x95mm (x12)	JC261 ■ JD327 ■ ■ ■ JD171 ■ ■ ■ JC152 ■ (x5) ⊕ JE689	JN438 (Elastomer) HL460 ■ (Cork) → Ch.44-L-072 000 HM5277 ■ (Elastomer) → Ch.44-L-072 000	HR615 ■	NA5001 32.00x47.00x10.00mm FPM



BM840







486









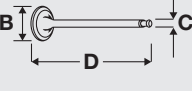

 **81.00**



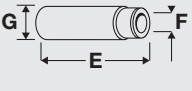











Petrol



1B	5 Cyl.	2226cc	147kW (200)PS	Turbo	TD211	971
200	02/88→12/91	QUATTRO	08/87→07/89			

					
TB504 147x19					FOL92 (x10)

					
B x C x D	OE	MAT.	45°	H	E x F x G
V91416 	027 109 601C		45°	H	VAG96157B  
32.10 x 6.97 x 95.50		MB			38.00 x 7.00 x 12.00
V91372 	027 109 611D		45°	H	
28.10 x 6.95 x 98.20		MG cr			

							
BM840 Fibre Composite	DM840	HBS024  M11x1.50x95mm (x12)	JC261  JC152  (x5)	JN438 (Elastomer) HL460  (Cork) HM5277  (Elastomer)	HR615 	NA5001 32.00x47.00x10.00mm FPM	



BM840

487



81.00

Petrol



2B	5 Cyl.	2226cc	140kW (190)PS	Turbo	TD215	971
200	02/88 → 12/90					

TB504 147x19					FOL92 (x10)
	OE	MAT.			
V91416 ■ 32.10 x 6.97 x 95.50	027 109 601C		45°	H	VAG96157B ■ ■ ■ 38.00 x 7.00 x 12.00
V91372 ■ 28.10 x 6.95 x 98.20	027 109 611D		45°	H	
V94301 ■ 33.15 x 8.00 x 91.50	035 109 611K		45°	ss H	

BM840 Fibre Composite	DM840	HBS024 ⊕ M11x1.50x95mm (x12)	JC261 ■ JC152 ■ (x5)	JN438 (Elastomer) HL460 ■ (Cork) HM5277 ■ (Elastomer)	HR615 ■	NA5001 32.00x47.00x10.00mm FPM



BM840

488



81.00

Petrol



3B	5 Cyl.	2226cc	162kW (220)PS	Turbo Intercooled	TD4192	972
200	03/89 → 12/90					

TB504 147x19					FOL92 (x20)
	OE	MAT.			
V91416 ■ 32.10 x 6.97 x 95.50	027 109 601C		45°	H	VAG96157B ■ ■ ■ 38.00 x 7.00 x 12.00
V91372 ■ 28.10 x 6.95 x 98.20	027 109 611D		45°	H	
AY960 MLS	CY960	HBS269 ⊕ M11x1.50x141.5mm (x12)	JD602 ■ JD282 ■ (x5) JD603 ■	HL730 ■	NA5001 32.00x47.00x10.00mm FPM



AY960

489	81.00	Petrol				
AAN	5 Cyl.	2226cc	169kW (230)PS	Turbo Intercooled	TD225	972
100	08/91→06/94	A6	06/94→12/97			

TB333				FOL92 (x20)
151x19				

B x C x D	E x F x G
V91416	VAG96157B
027 109 601C	38.00 x 7.00 x 12.00
32.10 x 6.97 x 95.50	
V91372	
027 109 611D	
28.10 x 6.95 x 98.20	

AY960 MLS	CY960	HBS269	JD602 JD603	HL730	NA5001
		M11x1.50x141.5mm (x12)			32.00x47.00x10.00mm FPM



AY960

490	81.00	Petrol				
ABY	5 Cyl.	2226cc	169kW (230)PS	Turbo Intercooled	TD237	972
80	02/93→07/95	COUPE	10/92→12/96			

TB333				FOL92 (x20)
151x19				

B x C x D	E x F x G
V91416	VAG92382B
027 109 601C	38.00 x 7.00 x 12.05
32.10 x 6.97 x 95.50	
V91372	
027 109 611D	
28.10 x 6.95 x 98.20	

AY960 MLS	CY960	HBS269	JD602 JD282 (x5) JD603	HL730	HR816	NA5001
		M11x1.50x141.5mm (x12)				32.00x47.00x10.00mm FPM



AY960

VW GROUP

491



81.00

Petrol



ADU 5 Cyl. 2226cc 232kW (316)PS Turbo Intercooled TD242 972

80 03/94→05/95

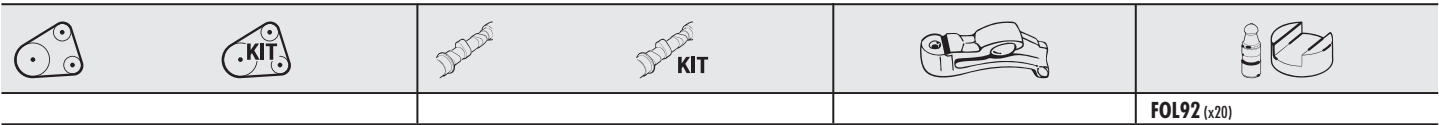

FOL92 (x20)

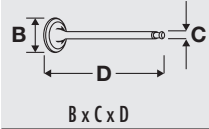

OE

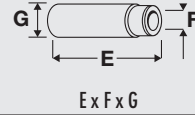

V94110 ■
32.00 x 7.00 x 95.50

051 109 601B

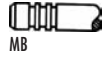

VAG96157B ■ ■ ■
38.00 x 7.00 x 12.00



AY960 MLS

CY960

HBS269 ⊙
M11x1.50x141.5mm (x12)

JD602 ■
JD282 ■ (x5)
JD603 ■

HL730 ■

HR816 ■

NA5001
32.00x47.00x10.00mm FPM



AY960

492



81.00

Petrol



HX 5 Cyl. 2226cc 100kW (136)PS TD267 973

100 06/89→11/90



TB207
120x18
→44J 200 099
TB318
142x19
44J 200 100→

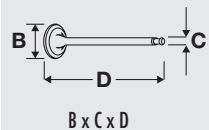

OE

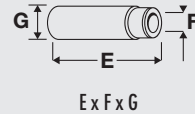

V91338 ■
38.10 x 7.97 x 91.90

035 109 601K

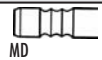

VAG92105B ■ ■ ■
42.30 x 7.99 x 12.08



V91340 ■
33.30 x 7.95 x 91.20

048 109 611A

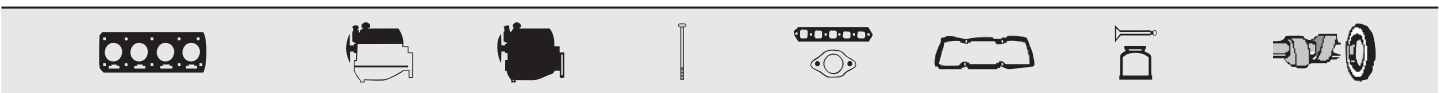
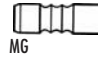

BM840 Fibre Composite

DM840

HBS024 ⊙
M11x1.50x95mm (x12)

JC261 ■
JC152 ■ (x5)
⊙JE689

JN438
(Elastomer)
HL460 ■
(Cork)
HM5277 ■
(Elastomer)

HR615 ■

NA5001
32.00x47.00x10.00mm FPM



BM840

493



81.00

Petrol



HY	5 Cyl.	9.3:1	2226cc	100kW (136)PS	TD21344	973
HY	5 Cyl.	9.3:1	2226cc	100kW (136)PS	TD268	973
90	10/84→03/87		COUPE	09/84→10/88	PASSAT	08/84→07/88
QUATTRO	12/84→07/87					

TB207 120x18 85-E-000 001 →	TBK048 85-E-000 001 →				
TB602 113x19 →85-D-250 000					

BM840 Fibre Composite	DM840 →Ch.8A-L-200 000		HBS024 Ⓞ M11x1.50x95mm (x12)	JC261 ■ JC152 ■ (x5) ⓄJE689	JN438 (Elastomer) HL460 ■ (Cork) →Ch.8A-L-200 000 HM5277 ■ (Elastomer) →Ch.8A-L-200 000	HR615 ■	NA5001 (x2) 32.00x47.00x10.00mm FPM



BM840

494



81.00
Petrol

JT	5 Cyl.	10:1	2226cc	88kW (120)PS	TD276	974
JT	5 Cyl.	10:1	2226cc	88kW (120)PS	TD5016	974
90	08/85→03/87		COUPE	08/85→10/88	PASSAT	08/85→03/88
QUATTRO	12/84→07/87					

TB207 120x18	TBK048				FOL92 (x10)

B x C x D	OE	MAT.
V91338 ■ 38.10 x 7.97 x 91.90	035 109 601K	45°
V91340 ■ 33.30 x 7.95 x 91.20	048 109 611A	45° H
		VAG92061B ■ ■ ■ 36.70 x 8.00 x 12.08

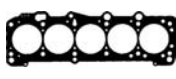
BM840 Fibre Composite	DM840 →Ch.8A-L-200 000	HBS024 ⊕ M11x1.50x95mm (x12)	JC261 ■ JC152 ■ (x5) ■ JE689	JN438 (Elastomer) HL460 ■ (Cork) →Ch.8A-L-200 000 HM5277 ■ (Elastomer) →Ch.8A-L-200 000	HR615 ■	NA5001 32.00x47.00x10.00mm FPM				

BM840

495	81.00	Petrol	
KU	5 Cyl.	10:1	2226cc
			101-103kW (137-140)PS
			TD9375 975
100	08/84→11/90	200	08/84→07/85



TB207 120x18 05/88→	TBK048 05/88→		KIT		FOL92 (x10)
TB602 113x19 →05/88					







B x C x D	E x F x G
V91338 ■ 38.10 x 7.97 x 91.90	VAG92105B ■ ■ ■ ■ ■ 42.30 x 7.99 x 12.08
V91340 ■ 33.30 x 7.95 x 91.20	
OE: 035 109 601K 048 109 611A	MAT. MD MG
45°	45° H





BM840 Fibre Composite	DM840	HBS024 ⊕ M11x1.50x95mm (x12)	JC261 ■ JC152 ■ (x5) ■ JE689	JN438 (Elastomer) HL460 ■ (Cork) HM5277 ■ (Elastomer)	HR615 ■	NA5001 32.00x47.00x10.00mm FPM





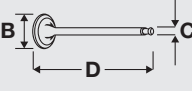
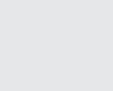





BM840

496	 81.00	Petrol				
KV	5 Cyl.	10:1	2226cc	100kW (136)PS	TD4125	975
KV	5 Cyl.	10:1	2226cc	100kW (136)PS	TD4209	975
90	10/84→09/91	COUPE	09/84→07/91	PASSAT	01/85→03/88	
QUATTRO	12/84→07/87					

					
TB207 120x18 85-E-000 001 →	TBK048 85-E-000 001 →		KIT		FOL92 (x10)
TB602 113x19 →85-D-250 000					

					
V91338 ■ 38.10 x 7.97 x 91.90	V91340 ■ 33.30 x 7.95 x 91.20	MAT.	45°	H	VAG92061B ■ ■ ■ 36.70 x 8.00 x 12.08
OE: 035 109 601K	053 109 611	MD			
		MG			

							
BM840 Fibre Composite	DM840 →Ch.8A-L-200 000	HBS024 ⊕ M11x1.50x95mm (x12)	JC261 ■ JC152 ■ (x5) ⊕ JE689	JN438 (Elastomer) HL460 ■ (Cork) →Ch.8A-L-200 000 HM5277 ■ (Elastomer) →Ch.8A-L-200 000	HR615 ■	NA5001 32.00x47.00x10.00mm FPM	



BM840

497

81.00

Petrol



KX	5 Cyl.	10:1	2226cc	85kW (115)PS	TD293	974
KX	5 Cyl.	10:1	2226cc	85kW (115)PS	TD5020	974
90	01/85→03/87	COUPE	07/81→10/87	PASSAT	01/85→03/88	

TB207 120x18 85-E-000 001 →	TBK048 85-E-000 001 →				FOL92 (x10)
TB602 113x19 →85-D-250 000					

	OE	MAT.			
V91338 ■ 38.10 x 7.97 x 91.90	035 109 601K	MD	45°		VAG92061B ■ ■ ■ 36.70 x 8.00 x 12.08
V91340 ■ 33.30 x 7.95 x 91.20	048 109 611A	MG	45°	H	VAG92105B ■ ■ ■ 42.30 x 7.99 x 12.08

BM840 Fibre Composite	DM840	HBS024 ⊕ M11x1.50x95mm (x12)	JC261 ■ JC152 ■ (x5) ■ JE689	JN438 (Elastomer) HL460 ■ (Cork) HM5277 ■ (Elastomer)	HR615 ■	NA5001 (x2) 32.00x47.00x10.00mm FPM



BM840

498



81.00

Petrol



KZ 5 Cyl. 2226cc 85kW (115)PS TD294 974

100 10/84→09/86

TB207 120x18	TBK048				FOL92 (x10)

B x C x D	OE	MAT.	45°	H	E x F x G
V91338 ■ 38.10 x 7.97 x 91.90	035 109 601K		45°		VAG92061B ■ ■ ■ 36.70 x 8.00 x 12.08
V91340 ■ 33.30 x 7.95 x 91.20	048 109 611A		45°	H	

BM840 Fibre Composite	DM840		HBS024 ⊕ M11x1.50x95mm (x12)	JC261 ■ JC152 ■ (x5) ⊕ JE689	JN438 (Elastomer) HL460 ■ (Cork) HM5277 ■ (Elastomer)	HR615 ■	NA5001 (x2) 32.00x47.00x10.00mm FPM



BM840

499







 **81.00**









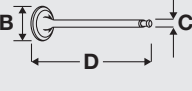

Petrol



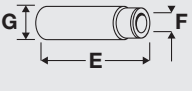













MB 5 Cyl. 2226cc 147kW (200)PS Turbo Intercooled **TD295** **976**

QUATTRO 08/87→07/89

					
TB318 142x19			KIT		

					
B x C x D	OE	MAT.	45°	H	E x F x G
V91338  38.10 x 7.97 x 91.90	035 109 601K	 MD	45°		VAG92061B  36.70 x 8.00 x 12.08
V91340  33.30 x 7.95 x 91.20	048 109 611A	 MG	45°	H	

							
BM840 Fibre Composite	DM840	HBS024  M11x1.50x95mm (x12)	JC261  JC152  (x5)	JN438 (Elastomer) HL460  (Cork) HM5277  (Elastomer)	HR615 	NA5001 32.00x47.00x10.00mm FPM	



BM840







500





 **81.00**





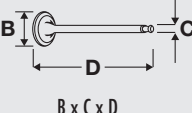
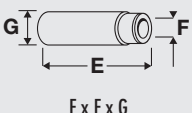









Petrol



MC	5 Cyl.	2226cc	121kW (165)PS	Turbo Intercooled	TD296	977
100	08/86 → 11/90	200	09/83 → 12/91			

					
TB207 120x18 05/88 →	TBK048 05/88 →	CAM442			FOL92 (x10)
TB602 113x19 →05/88					

	
B x C x D	E x F x G
OE	
MAT.	
	
	
	VAG92061B 
	36.70 x 8.00 x 12.08

							
BM840 Fibre Composite	DM840	HBS024  M11x1.50x95mm (x12)	JC261  JC152  (x5)	JN438 (Elastomer) HL460  (Cork) HM5277  (Elastomer)	HR615 	NA5001 32.00x47.00x10.00mm FPM	

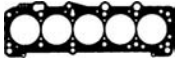

BM840

501	81.00	Petrol			
PX	5 Cyl.	2226cc	88kW (120)PS	TD312	978
100	08/85→07/86				

TB207 120x18	TBK048		KIT		FOL92 (x10)

B x C x D	OE	MAT.	45°	H	E x F x G
V91338 ■ 38.10 x 7.97 x 91.90	035 109 601K		45°		VAG92105B ■ ■ ■ 42.30 x 7.99 x 12.08
V91340 ■ 33.30 x 7.95 x 91.20	048 109 611A		45°	H	

BM840 Fibre Composite	DM840		HBS024 ⊕ M11x1.50x95mm (x12)	JC261 ■ JC152 ■ (x5) ⊕JE689	JN438 (Elastomer) HL460 ■ (Cork) HM5277 ■ (Elastomer)	HR615 ■	NA5001 (x2) 32.00x47.00x10.00mm FPM



BM840

502	81.00	Petrol			
RR	5 Cyl.	2226cc	162kW (220)PS	Turbo	TD316 979
QUATTRO	08/89→07/91				

TB504 147x19			KIT		FOL92 (x20)

B x C x D	OE	MAT.	45°	H	E x F x G
V91416 ■ 32.10 x 6.97 x 95.50	027 109 601C		45°	H	VAG96157B ■ ■ ■ 38.00 x 7.00 x 12.00

AY960 MLS	CY960		HBS269 ⊕ M11x1.50x141.5mm (x12)	JD602 ■ JD282 ■ (x5) JD603 ■	HL730 ■		NA5001 32.00x47.00x10.00mm FPM



AY960

503



81.00

Petrol



AAF

5 Cyl.

8.5:1

2459cc

81kW (110)PS

TD4002

980

TRANSPORTER

11/90 → 04/03



TB375 124x26.5 Eng. → 019149					FOL143 (x10)
TB785 122x26.5 Eng. 019150 →					







B x C x D	E x F x G
OE	
MAT.	
V91407 ■ 39.60 x 7.97 x 91.90	VAG92061B ■ ■ ■ 36.70 x 8.00 x 12.08
V91340 ■ 33.30 x 7.95 x 91.20	
048 109 601A	
053 109 611	
MD	
MG	
45°	H
45°	









BV880 Fibre Composite	DV880		HBS021 ⊙ M12x1.75x115mm (x12)	JD171 ■ JC152 ■ (x5)	JN915	HR615 ■	NA5001 (x2) 32.00x47.00x10.00mm FPM

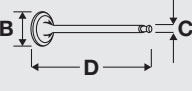
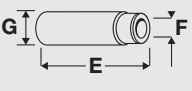









BV880

504	 81.00	Petrol				
ACU	5 Cyl.	10:1	2459cc	81kW (110)PS	TD4015	980
TRANSPORTER 11/90→04/03						



					
TB375 124x26.5 Eng.→019149			KIT		FOL143 (x10)
TB785 122x26.5 Eng.019150→					







						
B x C x D	OE	MAT.	45°			E x F x G
V91407 ■ 39.60 x 7.97 x 91.90	048 109 601A		45°			VAG92061B ■ ■ ■ ■ ■ 36.70 x 8.00 x 12.08
V91340 ■ 33.30 x 7.95 x 91.20	053 109 611		45°		H	









							
BV880 Fibre Composite	DV880		HBS021 ⊕ M12x1.75x115mm (x12)	JD171 ■ JC152 ■ (x5)	JN915	HR615 ■	NA5001 (x2) 32.00x47.00x10.00mm FPM

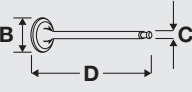









BV880

505	 81.00	Petrol				
AEU	5 Cyl.		2459cc	81kW (110)PS	TD9344	980
TRANSPORTER 11/90→04/03						

					
TB785 122x26.5			KIT		FOL143 (x10)

						
B x C x D	OE	MAT.	45°			E x F x G
V91407 ■ 39.60 x 7.97 x 91.90	048 109 601A		45°			VAG92061B ■ ■ ■ ■ ■ 36.70 x 8.00 x 12.08
V91340 ■ 33.30 x 7.95 x 91.20	053 109 611		45°		H	

							
BV880 Fibre Composite	DV880		HBS021 ⊕ M12x1.75x115mm (x12)	JD171 ■ JC152 ■ (x5)	JN915	HR615 ■	NA5001 (x2) 32.00x47.00x10.00mm FPM

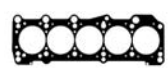

BV880

506



81.00

Diesel



AGX	5 Cyl.	19.5:1	2459cc	55kW (75)PS		TD9295	982
AHD	5 Cyl.	19.5:1	2459cc	75kW (102)PS	Turbo Intercooled	TD9294	981
LT 28-35	05/96→07/06		LT 28-46	05/96→07/06			

TB557 81x21 Driven unit: injection pump TB785 122x26.5		CAM442			FOL92 (x10)

B x C x D	OE	MAT.	45°	Y	H
V94010 ■ 36.00 x 8.00 x 96.80	028 109 601H		45°	Y	H
V94011 ■ 31.50 x 7.95 x 96.85	046 109 611F		45°	ss	H
					VAG92061B ■ ■ ■ 36.70 x 8.00 x 12.08

AF5310 MLS, 1.510mm, 1 Hole AF5320 MLS, 1.570mm, 2 Holes AF5330 MLS, 1.610mm, 3 Holes	CA5470 ▲ [14] Ch.70-R-160001→	HBS021 ⊕ M12x1.75x115mm (x12)	JD312 ■ JC152 ■ (x5)	JM7077 (NBR)	HR615 ■	NA5001 32.00x47.00x10.00mm FPM	

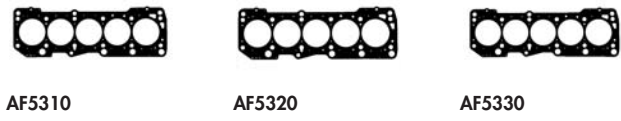

[14] With shaft oil seal [14] Mit Wellendichtring

507



81.00

Diesel



BNZ	5 Cyl.	18:1	2460cc	96kW (131)PS	Turbo Intercooled	TD20398	983
BPC	5 Cyl.	18:1	2460cc	128kW (174)PS	Turbo Intercooled	TD20397	984
MULTIVAN	04/03→11/09		TRANSPORTER	04/03→11/09			

		CAM912			FOL175 (x10)

B x C x D	OE	MAT.	45°	Y	H
V94649 ■ 36.00 x 7.00 x 89.40	038 109 601E		45°	Y	H
V94650 ■ 31.40 x 7.00 x 89.00	038 109 611E		45°	ss	H
					VAG96041B ■ ■ ■ 36.50 x 7.00 x 12.08

AG8930 MLS, 1.430mm, 3 Holes			HBS509				



AG8930

508	81.00	Petrol	
AEN	5 Cyl.	2461cc	81kW (110)PS
TRANSPORTER	11/90→04/03		TD9347 985

TB785					
122x26.5					

B x C x D	OE	MAT.	45°	H	E x F x G
V91407	048 109 601A		45°		VAG92061B
39.60 x 7.97 x 91.90		MD			36.70 x 8.00 x 12.08
V91340	053 109 611		45°	H	
33.30 x 7.95 x 91.20		MG			

BV880 Fibre Composite	DV880		HBS021	JD171	JN915	HR615	NA5001 (x2)
			M12x1.75x115mm (x12)	JC152	(x5)		32.00x47.00x10.00mm FPM

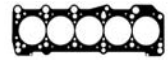

BV880

509	81.00	Petrol	
AET	5 Cyl.	2461cc	81kW (110)PS
APL	5 Cyl.	2461cc	85kW (115)PS
TRANSPORTER	07/96→04/03		TD4983 980

TB785					FOL143 (x10)
122x26.5					

B x C x D	OE	MAT.	45°	H	E x F x G
V91407	048 109 601A		45°		VAG92061B
39.60 x 7.97 x 91.90		MD			36.70 x 8.00 x 12.08
V91340	053 109 611		45°	H	
33.30 x 7.95 x 91.20		MG			

BV880 Fibre Composite	DV880		HBS021	JD171	JN915	HR615	NA5001
			M12x1.75x115mm (x12)	JC152	(x5)		32.00x47.00x10.00mm FPM



BV880

VW GROUP

510







 81.00









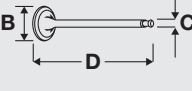

Petrol



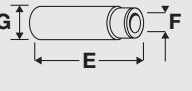









AVT 5 Cyl. 2461cc 85kW (115)PS TD15370 980

TRANSPORTER 07/96 → 04/03

					
TB785 122x26.5					FOL143 (x10)

	OE					
B x C x D		MAT.	45°		H	E x F x G
V91407 	048 109 601A		45°			VAG92061B 
39.60 x 7.97 x 91.90		MD				36.70 x 8.00 x 12.08
V91340 	053 109 611		45°			
33.30 x 7.95 x 91.20		MG				

							
BV880 Fibre Composite	DV880			JD171 	JN915	HR615 	NA5001 32.00x47.00x10.00mm FPM
				JC152  (x5)			

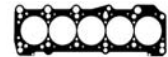

BV880

511







 81.00









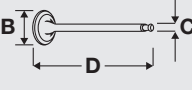

Diesel



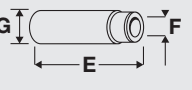

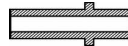











1T 5 Cyl. 2461cc 88kW (120)PS Turbo TD212 986

100 01/90 → 11/90

					
TB374 80x21 Driven unit: injection pump TB785 122x26.5		CAM442			FOL192 (x10)

	OE					
B x C x D		MAT.	45°	ss	H	E x F x G
V94547 	046 109 601J		45°	ss		VAG92061B 
35.95 x 8.00 x 96.85		MD				36.70 x 8.00 x 12.08
V91334 	074 109 611		45°	ss	H	
31.30 x 7.95 x 95.10		ME				
V94011 	046 109 611F		45°	ss		
31.50 x 7.95 x 96.85		MG				



							
AF5310 MLS, 1.510mm, 1 Hole	DW860 		HBS021 	JD312 	JN967	HR615 	NA5001 32.00x47.00x10.00mm FPM
AF5320 MLS, 1.570mm, 2 Holes	DW861 		M12x1.75x115mm (x12)	JC152  (x5)			
AF5330 MLS, 1.610mm, 3 Holes							



















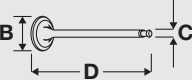

AF5310



















AF5320



AF5330

512	 81.00	Diesel	
AAT	5 Cyl.	2461cc	85kW (115)PS Turbo TD228 986
100	12/90→06/94	A6	06/94→12/97

					
TB374 80x21 Driven unit: injection pump		CAM442			FOL92 (x10)
TB785 122x26.5					

						
B x C x D	OE	MAT.	45°	ss	H	E x F x G
V94547 	046 109 601J		45°	ss		VAG92061B 
35.95 x 8.00 x 96.85		MD				36.70 x 8.00 x 12.08
V91334 	074 109 611		45°	ss	H	
31.30 x 7.95 x 95.10		ME				
V94011 	046 109 611F		45°	ss		
31.50 x 7.95 x 96.85		MG				

						
AF5310  MLS, 1.510mm, 1 Hole	DW860  ▲	HBS021  ⊕	JD312  	JN967	HR615  	NA5001 (x2)
AF5320  MLS, 1.570mm, 2 Holes	DW861  ▲	M12x1.75x115mm (x12)	JC152   (x5)			32.00x47.00x10.00mm FPM
AF5330  MLS, 1.610mm, 3 Holes						

		
AF5310	AF5320	AF5330



ABP 5 Cyl. 2461cc 85kW (115)PS Turbo TD235 986

100 12/90 → 06/94



TB374 80x21 Driven unit: injection pump		CAM442			FOL92 (x10)
TB375 124x26.5					



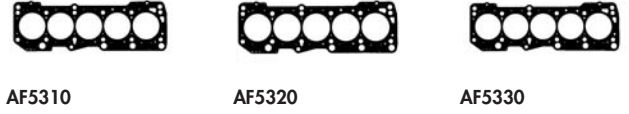



B x C x D	OE	MAT.	
V94547	046 109 601J		45° ss
35.95 x 8.00 x 96.85		MD	
V91334	074 109 611		45° ss H
31.30 x 7.95 x 95.10		ME	
V94011	046 109 611F		45° ss
31.50 x 7.95 x 96.85		MG	
		VAG92061B	
		36.70 x 8.00 x 12.08	







AF5310 MLS, 1.510mm, 1 Hole	DW860 ▲	HBS021	JD312	JN967	HR615	NA5001 (x2)
AF5320 MLS, 1.570mm, 2 Holes	DW861 ▲	M12x1.75x115mm (x12)	JC152 (x5)			32.00x47.00x10.00mm FPM
AF5330 MLS, 1.610mm, 3 Holes						



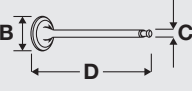



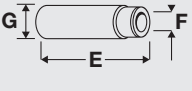



AF5310 AF5320 AF5330

514	 81.00	Diesel					
ACV	5 Cyl.	20.5:1	2461cc	74kW (100)PS	Turbo Intercooled	TD4978	981
TRANSPORTER 09/95→04/03							

					
TB557 81x21 Driven unit: injection pump		CAM442			FOL92 (x10)
TB785 122x26.5					

						
B x C x D	OE	MAT.	45°	Y	H	E x F x G
V94010 ■■ 36.00 x 8.00 x 96.80	028 109 601H		45°	Y	H	VAG92061B ■■ ■■ 36.70 x 8.00 x 12.08
V94011 ■■ 31.50 x 7.95 x 96.85	046 109 611F		45°	ss		

							
AF5310 MLS, 1.510mm, 1 Hole AF5320 MLS, 1.570mm, 2 Holes AF5330 MLS, 1.610mm, 3 Holes	CA5470 ▲ [14] Ch.70-R-160001 →	HBS021 ⊕ M12x1.75x115mm (x12)	JD312 ■■ JC152 ■■ (x5)	JM7077 (NBR)	HR615 ■■	NA5001 (x2) 32.00x47.00x10.00mm FPM NA5124 32.00x47.00x10.00mm PTFE/ACM	

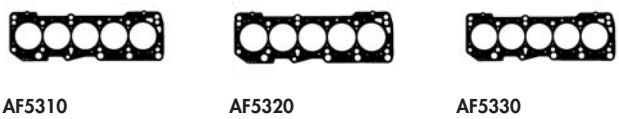

[14] With shaft oil seal

[14] Mit Wellendichtring

515



81.00

Diesel



AEL 5 Cyl. 2461cc 103kW (140)PS Turbo Intercooled TD245 986

A6 08/94→12/97

TB374 80x21 Driven unit: injection pump		CAM442			FOL92 (x10)
TB785 122x26.5					

B x C x D	OE	MAT.
V94010 ■	028 109 601H	45° Y H
36.00 x 8.00 x 96.80		
V94011 ■	046 109 611F	45° ss
31.50 x 7.95 x 96.85		
		VAG92061B ■ ■ ■ 36.70 x 8.00 x 12.08

AF5310 MLS, 1.510mm, 1 Hole	DW860 ▲	HBS021 ⊕ M12x1.75x115mm (x12)	JD312 ■	JN967	HR615 ■	NA5001 (x2) 32.00x47.00x10.00mm FPM
AF5320 MLS, 1.570mm, 2 Holes			JC152 ■ (x5)			
AF5330 MLS, 1.610mm, 3 Holes						

AF5310	AF5320	AF5330

516

81.00

Diesel



AHY	5 Cyl.		2461cc	111kW (151)PS	Turbo Intercooled	TD10748	981
AXG	5 Cyl.	18:1	2461cc	111kW (151)PS	Turbo Intercooled	TD17505	981

TRANSPORTER 05/98→04/03

TB557 81x21 Driven unit: injection pump TB785 122x26.5		CAM442			FOL92 (x10)

B x C x D	OE	MAT.	E x F x G
V94010 ■ 36.00 x 8.00 x 96.80	028 109 601H	 MB	VAG92061B ■ ■ ■ 36.70 x 8.00 x 12.08
V94011 ■ 31.50 x 7.95 x 96.85	046 109 611F	 MG	

AF5310 MLS, 1.510mm, 1 Hole AF5320 MLS, 1.570mm, 2 Holes AF5330 MLS, 1.610mm, 3 Holes	CA5470 ▲ [14] Ch.70-R-160001 →	HBS021 ⊕ M12x1.75x115mm (x12)	JD312 ■ JC152 ■ (x5)	JM7077 (NBR)	HR615 ■	NA5124 32.00x47.00x10.00mm PTFE/ACM

AF5310	AF5320	AF5330

[14] With shaft oil seal [14] Mit Wellendichtring

517



81.00

Diesel



AJT	5 Cyl.		2461cc	65kW (88)PS	Turbo Intercooled	TD10747	981
AYY	5 Cyl.	18:1	2461cc	65kW (88)PS	Turbo Intercooled	TD17503	981

TRANSPORTER 05/98→04/03

TB557 81x21 Driven unit: injection pump TB785 122x26.5		CAM442			FOL92 (x10)



<p>V94010 ■ 028 109 601H 36.00 x 8.00 x 96.80 V94011 ■ 046 109 611F 31.50 x 7.95 x 96.85</p> <p>OE MAT. MB MG</p> <p>45° Y H 45° ss</p>	<p>VAG92061B ■ ■ ■ 36.70 x 8.00 x 12.08</p>

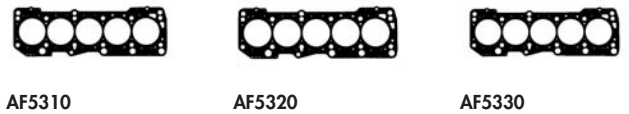





<p>AF5310 MLS, 1.510mm, 1 Hole AF5320 MLS, 1.570mm, 2 Holes AF5330 MLS, 1.610mm, 3 Holes</p>	<p>CA5470 ▲ [14] Ch.70-R-160001→</p>	<p>HBS021 ⊕ M12x1.75x115mm (x12)</p>	<p>JD312 ■ JC152 ■ (x5)</p>	<p>JM7077 (NBR) JN915</p>	<p>HR615 ■</p>	<p>NA5001 (x2) 32.00x47.00x10.00mm FPM NA5124 32.00x47.00x10.00mm PTFE/ACM</p>











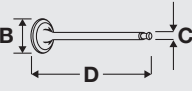

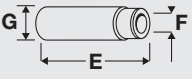
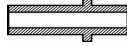

AF5310 **AF5320** **AF5330**

[14] With shaft oil seal [14] Mit Wellendichtring

518	 81.00	Diesel				
ANJ	5 Cyl.	2461cc	80kW (109)PS	Turbo Intercooled	TD13446	981
BBE	5 Cyl.	2461cc	61kW (82)PS	Turbo Intercooled	TD16451	981
BBF	5 Cyl.	2461cc	70kW (95)PS	Turbo Intercooled	TD16452	981
LT 28-35	05/99→07/06	LT 28-46	05/99→07/06			

					
TB557 81x21 Driven unit: injection pump TB785 122x26.5		CAM442			FOL92 (x10)

							
V94010 ■ 36.00 x 8.00 x 96.80	OE 028 109 601H	MAT. MB	45°	Y	H	VAG92061B ■ ■ ■ 36.70 x 8.00 x 12.08	
V94011 ■ 31.50 x 7.95 x 96.85	046 109 611F	MG	45°	ss			

						
AF5310 MLS, 1.510mm, 1 Hole AF5320 MLS, 1.570mm, 2 Holes AF5330 MLS, 1.610mm, 3 Holes	CA5470 ▲ [14] Ch.70-R-160001 →	HBS021 ⊙ M12x1.75x115mm (x12)	JD312 ■ JC152 ■ (x5)	JM7077 (NBR)	HR596 ■	NA5001 (x2) 32.00x47.00x10.00mm FPM NA5124 32.00x47.00x10.00mm PTFE/ACM

		
AF5310	AF5320	AF5330
[14] With shaft oil seal	[14] Mit Wellendichtring	



APA	5 Cyl.	2461cc	66kW (89)PS	Turbo Intercooled	TD13445	981
LT 28-35	05/99→07/06	LT 28-46	05/99→07/06			

TB557 81x21 Driven unit: injection pump TB785 122x26.5		CAM442			FOL92 (x10)

B x C x D	E x F x G
V94010 ■ 36.00 x 8.00 x 96.80	VAG92061B ■ ■ ■ 36.70 x 8.00 x 12.08
V94011 ■ 31.50 x 7.95 x 96.85	
OE: 028 109 601H	
MAT: MB	
45° Y H	
046 109 611F	
MAT: MG	
45° ss	

AF5310 MLS, 1.510mm, 1 Hole AF5320 MLS, 1.570mm, 2 Holes AF5330 MLS, 1.610mm, 3 Holes	CA5470 ▲ [14] Ch.70-R-160001→		HBS021 ⊕ M12x1.75x115mm (x12)	JD312 ■ JC152 ■ (x5)	JM7077 (NBR)	HR615 ■	NA5001 (x2) 32.00x47.00x10.00mm FPM NA5124 32.00x47.00x10.00mm PTFE/ACM

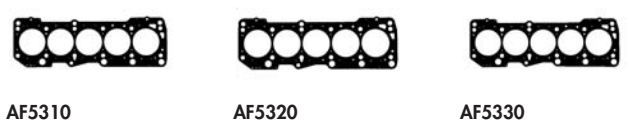

[14] With shaft oil seal [14] Mit Wellendichtring

520

81.00

Diesel



AUF	5 Cyl.	2461cc	75kW (102)PS	Turbo Intercooled	TD16857	981	
AYC	5 Cyl.	19.5:1	2461cc	75kW (102)PS	Turbo Intercooled	TD17504	981

TRANSPORTER 09/95→04/03

TB557 81x21 Driven unit: injection pump TB785 122x26.5	CAM442				FOL92 (x10)

B x C x D	E x F x G
V94010 ■ 36.00 x 8.00 x 96.80	VAG92061B ■ ■ ■ 36.70 x 8.00 x 12.08
V94547 ■ 35.95 x 8.00 x 96.85	
V94011 ■ 31.50 x 7.95 x 96.85	
OE: 028 109 601H, 046 109 601J, 046 109 611F	
MAT.: MB, MD, MG	
45° Y H, 45° ss, 45° ss	

AF5310 MLS, 1.510mm, 1 Hole AF5320 MLS, 1.570mm, 2 Holes AF5330 MLS, 1.610mm, 3 Holes	CA5470 ▲ [14] Ch.70-R-160001→	HBS021 ⊙ M12x1.75x115mm (x12)	JD312 ■ JC152 ■ (x5)	JM707 (NBR)	HR615 ■	NA5001 (x2) 32.00x47.00x10.00mm FPM NA5124 32.00x47.00x10.00mm PTFE/ACM

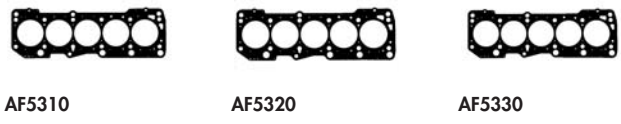

[14] With shaft oil seal [14] Mit Wellendichtring



AVR 5 Cyl. 2461cc 80kW (109)PS Turbo Intercooled TD15497 988

LT 28-35 05/99→07/06 LT 28-46 05/99→07/06

TB557 81x21 Driven unit: injection pump		CAM442			FOL92 (x10)
TB785 122x26.5					

B x C x D	OE	MAT.	
V94010	028 109 601H	 MB	45° Y H
36.00 x 8.00 x 96.80			
V94547	046 109 601J	 MD	45° ss
35.95 x 8.00 x 96.85			
V94011	046 109 611F	 MG	45° ss
31.50 x 7.95 x 96.85			
			VAG92061B 36.70 x 8.00 x 12.08

AF5310 MLS, 1.510mm, 1 Hole			HBS021 M12x1.75x115mm (x12)	JD312 JC152 (x5)	JM7077 (NBR)	HR596	NA5001 (x2) 32.00x47.00x10.00mm FPM NA5124 32.00x47.00x10.00mm PTFE/ACM

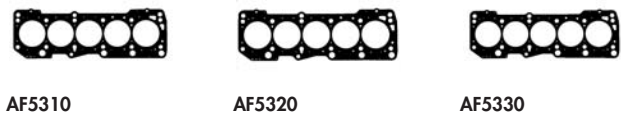

522







 **81.00**

Diesel











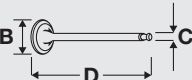

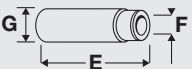

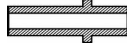









AXD	5 Cyl.		2461cc	96kW (131)PS	Turbo Intercooled	TD16868	989
AXE	5 Cyl.		2461cc	128kW (174)PS	Turbo Intercooled	TD16869	989
BAC	5 Cyl.	18:1	2461cc	128kW (174)PS	Turbo Intercooled	TD16855	989

MULTIVAN	04/03→11/09	TOUAREG	01/03→05/10	TRANSPORTER	04/03→11/09
-----------------	-------------	----------------	-------------	--------------------	-------------

					
CAM916 [52]			FOL175 (x10)		

[52] Steel [52] Stahl

 B x C x D	OE	MAT.			 E x F x G
V94147  35.90 x 7.00 x 89.90	038 109 601B	 MB	45°	H	VAG96041B  36.50 x 7.00 x 12.08
V94148  31.50 x 7.00 x 90.00	038 109 611B	 MG	45°	ss H	
V94415  31.40 x 7.00 x 89.50	038 109 611F	 MG	45°	ss H	

							
AG8920 MLS, 1.270mm, 1 Hole AG8820 MLS, 1.350mm, 2 Holes AG8930 MLS, 1.430mm, 3 Holes			HBS509	JD5955  [53] (Steel Elastomer) JD5956  [5] (Steel) JD5957  [6] (Steel)	HR397	HR5085  (x4) HR599  (x8)	



AG8820

[53] To cylinder 1
[5] To cylinder 2-3
[6] To cylinder 4-5



AG8920

[53] zum Zylinder 1
[5] Zu Motorzylinder 2-3
[6] Zu Motorzylinder 4-5



AG8930

523



81.00

Diesel



AXL 5 Cyl. 19.5:1 2461cc 75kW (102)PS Turbo Intercooled TD18687 981

TRANSPORTER 09/95→04/03

TB557 81x21 Driven unit: injection pump TB785 122x26.5		CAM442			FOL92 (x10)

B x C x D	E x F x G
V94010 ■ 36.00 x 8.00 x 96.80	VAG92061B ■ ■ ■ 36.70 x 8.00 x 12.08
OE: 028 109 601H	
MAT: MB	
45° Y H	
V94011 ■ 31.50 x 7.95 x 96.85	
OE: 046 109 611F	
MAT: MG	
45° ss	

AF5310 MLS, 1.510mm, 1 Hole	CC5231 ▲ CA5470 ▲ [14] Ch.70-R-160001→		HBS021 ⊕ M12x1.75x115mm (x12)	JD312 ■ JC152 ■ (x5)	JM7077 (NBR)	HR615 ■	NA5001 (x2) 32.00x47.00x10.00mm FPM NA5124 32.00x47.00x10.00mm PTFE/ACM
AF5320 MLS, 1.570mm, 2 Holes							
AF5330 MLS, 1.610mm, 3 Holes							

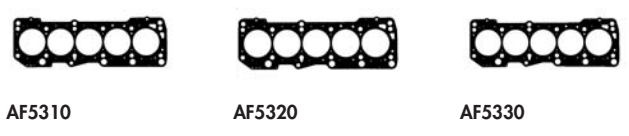

[14] With shaft oil seal [14] Mit Wellendichtring

524



81.00

Diesel



BBR 5 Cyl. 19.5:1 2461cc 80kW (109)PS TD22627 988

AF5310 MLS, 1.510mm, 1 Hole				JD312 ■			
AF5320 MLS, 1.570mm, 2 Holes							
AF5330 MLS, 1.610mm, 3 Holes							

525







 81.00









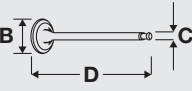

Diesel



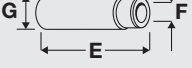

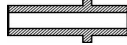













BJJ	5 Cyl.	2461cc	65kW (88)PS	Turbo Intercooled	TD18891	990
BJK	5 Cyl.	2461cc	80kW (109)PS	Turbo Intercooled	TD18892	990

CRAFTER 30-35 04/06→ **CRAFTER 30-50** 04/06→

					
TB797					FOL92 (x10)
141x26					

	OE	MAT.				
B x C x D						E x F x G
V94010 	028 109 601H		45°	Y	H	VAG92061B 
36.00 x 8.00 x 96.80		MB				36.70 x 8.00 x 12.08
V94547 	046 109 601J		45°	ss		
35.95 x 8.00 x 96.85		MD				
V94011 	046 109 611F		45°	ss		
31.50 x 7.95 x 96.85		MG				

							
AH5970 MLS, 1.530mm, 1 Hole			HBS021 	JD312 	JM7077	HR596  (x8)	NA5124
AH5980 MLS, 1.570mm, 2 Holes			M12x1.75x115mm (x12)	JD5948 	(NBR)	HR805 	32.00x47.00x10.00mm PTFE/ACM
AH5990 MLS, 1.610mm, 3 Holes				(Steel)			

		
AH5970	AH5980	AH5990

526







 81.00









Diesel

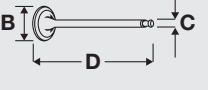











BJL 5 Cyl. 2461cc 100kW (136)PS Turbo Intercooled TD18893 991

CRAFTER 30-35 04/06 → CRAFTER 30-50 04/06 →

					
TB797 141x26				FOL92 (x10)	

					
B x C x D	OE	MAT.	45°	Y	H
V94010 ■	028 109 601H		45°	Y	H
36.00 x 8.00 x 96.80		MB			
V94547 ■	046 109 601J		45°	ss	
35.95 x 8.00 x 96.85		MD			
V94011 ■	046 109 611F		45°	ss	
31.50 x 7.95 x 96.85		MG			
VAG92061B ■ ■ ■ 36.70 x 8.00 x 12.08					

							
AH5970 MLS, 1.530mm, 1 Hole			HBS021 ⊕ M12x1.75x115mm (x12)	JD312 ■ JD5948 ■ (Steel)	JM7077 (NBR)		NA5124 32.00x47.00x10.00mm PTFE/ACM
AH5980 MLS, 1.570mm, 2 Holes							
AH5990 MLS, 1.610mm, 3 Holes							
							
AH5970	AH5980	AH5990					

527





 81.00









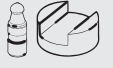

Diesel









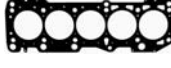

BJM 5 Cyl. 2461cc 120kW (163)PS Turbo Intercooled TD18894 991

CRAFTER 30-35 04/06 → 07/11 CRAFTER 30-50 04/06 → 07/11









					
TB797 141x26				FOL92 (x10)	

							
AH5970 MLS, 1.530mm, 1 Hole			HBS021 ⊕ M12x1.75x115mm (x12)	JD5948 ■ (Steel)	JM7077 (NBR)		
AH5980 MLS, 1.570mm, 2 Holes							
AH5990 MLS, 1.610mm, 3 Holes							
							
AH5970	AH5980	AH5990					

528	 81.00	Diesel					
BLJ	5 Cyl.	18:1	2461cc	120kW (163)PS	Turbo Intercooled	TD20505	989
BLK	5 Cyl.	18:1	2461cc	120kW (163)PS	Turbo Intercooled	TD20506	989
MULTIVAN	11/03→11/09	TOUAREG	08/03→05/10	TRANSPORTER	11/03→11/09		

					
	.KIT		KIT		
		CAM916 [52]			FOL175 (x10)



[52] Steel [52] Stahl









							
AG8920 MLS, 1.270mm, 1 Hole AG8820 MLS, 1.350mm, 2 Holes AG8930 MLS, 1.430mm, 3 Holes			HBS509	JD5955 ■ [53] (Steel Elastomer) JD5956 ■ [5] (Steel) JD5957 ■ [6] (Steel)		HR599 ■	



AG8930

[53] To cylinder 1 [53] zum Zylinder 1
 [5] To cylinder 2-3 [5] Zu Motorzylinder 2-3
 [6] To cylinder 4-5 [6] Zu Motorzylinder 4-5

529	 81.00	Diesel					
BPD	5 Cyl.	18:1	2461cc	120kW (163)PS	Turbo Intercooled	TD20507	984
TOUAREG	08/03→05/10						

							
AG8920 MLS, 1.270mm, 1 Hole AG8820 MLS, 1.350mm, 2 Holes AG8930 MLS, 1.430mm, 3 Holes			HBS509	JD5955 ■ [53] (Steel Elastomer) JD5956 ■ [5] (Steel) JD5957 ■ [6] (Steel)		HR599 ■	

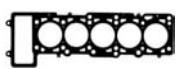

AG8930

[53] To cylinder 1 [53] zum Zylinder 1
 [5] To cylinder 2-3 [5] Zu Motorzylinder 2-3
 [6] To cylinder 4-5 [6] Zu Motorzylinder 4-5

530







 **81.00**







Diesel



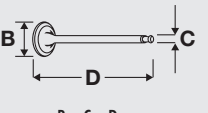



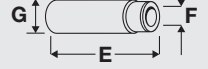

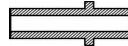

BPE 5 Cyl. 18:1 2461cc 128kW (174)PS Turbo Intercooled TD20508 **984**

TOUAREG 01/03→05/10

					
CAM912			FOL175 (x10)		

				
B x C x D	OE	MAT.		E x F x G
V94649 ■ 36.00 x 7.00 x 89.40	038 109 601E	 MB	45° Y H	VAG96041B ■ ■ ■ 36.50 x 7.00 x 12.08
V94650 ■ 31.40 x 7.00 x 89.00	038 109 611E	 MG	45° ss H	



							
AG8920 MLS, 1.270mm, 1 Hole			HBS509	JD5955 ■ [53] (Steel Elastomer)		HR599 ■	
AG8820 MLS, 1.350mm, 2 Holes				JD5956 ■ [5] (Steel)			
AG8930 MLS, 1.430mm, 3 Holes				JD5957 ■ [6] (Steel)			

















AG8930

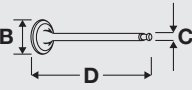

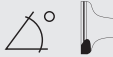

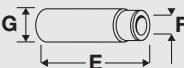





[53] To cylinder 1
[5] To cylinder 2-3
[6] To cylinder 4-5



[53] zum Zylinder 1
[5] Zu Motorzylinder 2-3
[6] Zu Motorzylinder 4-5







531	 81.00	Diesel				
CEBA	5 Cyl.	2461cc	65kW (88)PS	Turbo Intercooled	TD24719	990
CEBB	5 Cyl.	2461cc	80kW (109)PS	Turbo Intercooled	TD24720	990
CECA	5 Cyl.	2461cc	100kW (136)PS	Turbo Intercooled	TD24721	991
CRAFTER 30-35	04/06→	CRAFTER 30-50	04/06→			











					
TB797					
141x26					

				
B x C x D	OE	MAT.		E x F x G
V94010 ■	028 109 601H		45° Y H	VAG92061B ■ ■ ■
36.00 x 8.00 x 96.80		MB		36.70 x 8.00 x 12.08
V94547 ■	046 109 601J		45° ss	
35.95 x 8.00 x 96.85		MD		
V94011 ■	046 109 611F		45° ss	
31.50 x 7.95 x 96.85		MG		

							
AH5970 MLS, 1.530mm, 1 Hole			HBS021 ⊕	JD312 ■		HR615 ■	NA5124
AH5980 MLS, 1.570mm, 2 Holes			M12x1.75x115mm (x12)	JD5948 ■		HR805 ■	32.00x47.00x10.00mm PTFE/ACM
AH5990 MLS, 1.610mm, 3 Holes				(Steel)			
							
AH5970	AH5980	AH5990					

532	 81.00	Diesel				
CECB	5 Cyl.	2461cc	120kW (163)PS	Turbo Intercooled	TD24722	992
CRAFTER 30-35	04/06→07/11	CRAFTER 30-50	04/06→07/11			

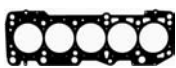
					
TB797					
141x26					

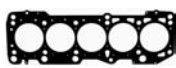
							
AH5970 MLS, 1.530mm, 1 Hole			HBS021 ⊕	JD5948 ■	JM7077		
AH5980 MLS, 1.570mm, 2 Holes			M12x1.75x115mm (x12)	(Steel)	(NBR)		
AH5990 MLS, 1.610mm, 3 Holes							
							
AH5970	AH5980	AH5990					

533



81.00
Petrol

AGZ	V5 Cyl.	10:1	2324cc	110kW (150)PS	TD12511	993
AGZ	V5 Cyl.	10:1	2324cc	110kW (150)PS	TD5559	993
BORA	10/98→10/00		GOLF	08/97→06/06	PASSAT	10/96→11/00
TOLEDO	04/99→05/01					

					FOL92 (x10)

 B x C x D	OE	MAT.				 E x F x G
V94374	021 109 601L		45°		H	VAG96157B
39.00 x 7.00 x 106.00						38.00 x 7.00 x 12.00
V94721	021 109 601K		45°	Y	H	
39.00 x 7.00 x 105.90						
V94306	021 109 611D		45°	ss	H	
34.20 x 7.00 x 107.00						

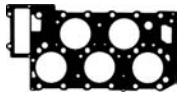
AG7800	CG7800		HBS461		HR397		NA5106 35.00x48.00x10.00mm PTFE/ACM

AG7800

534



81.00
Petrol







AQN	V5 Cyl.	10.8:1	2324cc	125kW (170)PS	TD15472	994
AQN	V5 Cyl.	10.8:1	2324cc	125kW (170)PS	TD16163	994
BORA	10/00→05/05		GOLF	10/00→06/06	NEW BEETLE	10/00→
TOLEDO	05/01→05/06					



					FOL154 (x20)







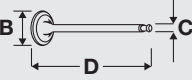
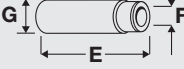

 B x C x D	OE	MAT.				 E x F x G
V94406	022 109 601E		45°	Y	H	
31.00 x 6.00 x 102.10						
V94642	022 109 601F		45°		H	
31.00 x 6.00 x 136.00						
V94407	022 109 611C		45°	ss	H	
27.00 x 6.00 x 136.40						
V94641	022 109 611B		45°	ss	H	
27.00 x 6.00 x 102.50						



	CG9620 MLS		HBS513		JM5234	PA5041 (x20) 6.00x8.8/12.20x10.00 866N W (FPM) HR822	NA5001 32.00x47.00x10.00mm FPM







535	 81.00	Petrol				
AZX	V5 Cyl.	10.8:1	2324cc	125kW (170)PS	TD15151	994
PASSAT 11/00→05/05						









					
					FOL154 (x20)

					
B x C x D	E x F x G				
OE	MAT.				
V94406 ■	022 109 601E		45°	Y	H
31.00 x 6.00 x 102.10					
V94407 ■	022 109 611C		45°	ss	H
27.00 x 6.00 x 136.40					

							
	CG9621		HBS513	JD5927 ■ (FPM)	JM5234	PA5041 (x20) 6.00x8.8/12.20x10.00 866N W (FPM) HR822 ■	



536	 81.00	Petrol				
AFM	V6 Cyl.		2393cc	110kW (150)PS	TD17146	995
A4 07/95→07/97 A6 07/95→12/97						



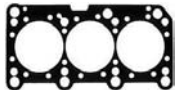





					
TB373					
239x25.4					

							
AY061 Fibre Composite, 2.000mm (x2)	DT660		HBS064 ⊕ M11x1.50x137mm (x16)		JM5166 (ACM)	HR662 ■	



AY061

537	 81.00	Petrol			
AFP	6 Cyl.	10:1	2792cc	130kW (177)PS	TD20532

							
				JA5069 ■ [54] JD5109 ■ [61]			

[54] To cylinder 1 - 3
[61] To cylinder 4 - 6

[54] zum Zylinder 1 - 3
[61] zum Zylinder 4 - 6

538



81.00

Petrol



AGA	V6 Cyl.	2393cc	121kW (165)PS	TD9515	996
A4	03/97→09/01	A6	02/97→01/05		

TB556 253x30	TBK353 with tensioner pulley damper TBK357 without tensioner pulley damper				FOL133 ■ (x18) FOL141 ■ (x12)

B x C x D	E x F x G
V94081 ■ 26.90 x 6.00 x 105.10	VAG96073B ■ ■ ■ 36.00 x 6.02 x 11.06
V94082 ■ 29.90 x 6.00 x 103.90	
OE: 058 109 601C	MAT. MB
OE: 058 109 611E	MAT. MG cr
45° Y H	45° ss H

BZ960 MLS (x2)	DZ960 ○ (x2)	HBS270 ⊗ M11x1.50x133mm (x16)	HM5224 ■	PA5041 (x30) 6.00x8.8/12.20x10.00 866N W (FPM)			

539



81.00

Petrol













AJG	V6 Cyl.	2393cc	120kW (163)PS	TD13928	996
AML	V6 Cyl.	2393cc	121kW (165)PS	TD13951	996
ARJ	V6 Cyl.	2393cc	121kW (165)PS	TD13953	996
A4	03/97→09/01	A6	02/97→01/05		







TB556 253x30	TBK353 with tensioner pulley damper TBK357 without tensioner pulley damper				FOL133 ■ (x18) FOL141 ■ (x12)



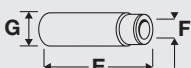
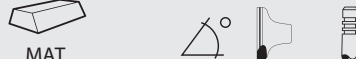







B x C x D	E x F x G
V94081 ■ 26.90 x 6.00 x 105.10	VAG96073B ■ ■ ■ 36.00 x 6.02 x 11.06
V94082 ■ 29.90 x 6.00 x 103.90	
OE: 058 109 601C	MAT. MB
OE: 058 109 611E	MAT. MG cr
45° Y H	45° ss H



BZ960 MLS (x2)	DZ960 ○ (x2)	HBS270 ⊗ M11x1.50x133mm (x16)	HM5224 ■	PA5041 (x30) 6.00x8.8/12.20x10.00 866N W (FPM)	NA5001 32.00x47.00x10.00mm FPM		









540	 81.00	Petrol			
ALF	V6 Cyl.	2393cc	121kW (165)PS	TD11359	996
APS	V6 Cyl.	2393cc	120kW (163)PS	TD13952	996
A4	03/97→09/01	A6	02/97→01/05		





					
TB556 253x30	TBK353 with tensioner pulley damper TBK357 without tensioner pulley damper				FOL133  (x18) FOL141  (x12)





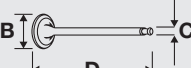
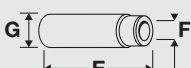





	
B x C x D	E x F x G
OE	
MAT.	
	
V94081  058 109 601C 26.90 x 6.00 x 105.10	VAG96073B    36.00 x 6.02 x 11.06
V94083  058 109 611M 29.90 x 6.00 x 103.90	
MB	
MG cr	
45° Y H	
45° H	

							
BZ960 MLS (x2)	DZ960  (x2)		HBS270  M11x1.50x133mm (x16)		HM5224 	PA5041 (x30) 6.00x8.8/12.20x10.00 866N W (FPM)	

541	 81.00	Petrol			
ALW	V6 Cyl.	2393cc	100kW (136)PS	TD11088	996
APC	V6 Cyl.	2393cc	115kW (156)PS	TD11360	996
ARN	V6 Cyl.	2393cc	100kW (136)PS	TD14028	996
ASM	V6 Cyl.	2393cc	100kW (136)PS	TD15330	996
A6	02/97→01/05				

					
TB556 253x30	TBK353 with tensioner pulley damper TBK357 without tensioner pulley damper				FOL133  (x18) FOL141  (x12)

	
B x C x D	E x F x G
OE	
MAT.	
	
V94081  058 109 601C 26.90 x 6.00 x 105.10	
V94083  058 109 611M 29.90 x 6.00 x 103.90	
MB	
MG cr	
45° Y H	
45° H	

							
BZ960 MLS (x2)	DZ960  (x2)		HBS270  M11x1.50x133mm (x16)		HM5224 	PA5041 (x30) 6.00x8.8/12.20x10.00 866N W (FPM)	

VW GROUP

542



81.00

Petrol



AMM	V6 Cyl.	2393cc	120kW (163)PS	TD15331	996
A4	08/97→12/05	A6	02/97→01/05		

TB556 253x30	TBK353 with tensioner pulley damper TBK357 without tensioner pulley damper		KIT		

	OE	MAT.				
V94081 ■ 26.90 x 6.00 x 105.10	058 109 601C		45°	Y	H	VAG96073B ■ ■ ■ 36.00 x 6.02 x 11.06
V94082 ■ 29.90 x 6.00 x 103.90	058 109 611E		45°	ss	H	

BZ960 MLS (x2)	DZ960 ○ (x2)		HBS270 ⊗ M11x1.50x133mm (x16)		HM5224 ■	PA5041 (x30) 6.00x8.8/12.20x10.00 866N W (FPM)	

543



81.00

Petrol













APZ	V6 Cyl.	2393cc	121kW (165)PS	TD13954	996
A4	08/97→09/01	A6	02/97→01/05		

TB556 253x30	TBK353 with tensioner pulley damper TBK357 without tensioner pulley damper		KIT		FOL133 ■ (x18) FOL141 ■ (x12)









	OE	MAT.				
V94081 ■ 26.90 x 6.00 x 105.10	058 109 601C		45°	Y	H	VAG96073B ■ ■ ■ 36.00 x 6.02 x 11.06
V94083 ■ 29.90 x 6.00 x 103.90	058 109 611M		45°		H	









BZ960 MLS (x2)	DZ960 ○ (x2)		HBS270 ⊗ M11x1.50x133mm (x16)		HM5224 ■	PA5041 (x30) 6.00x8.8/12.20x10.00 866N W (FPM)	

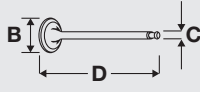







544	 81.00	Petrol					
BDF	6 Cyl.	10.75:1	2792cc	147kW (200)PS	TD20675		
							
AG5000 MLS			HBS526 ⊕ [12]		JM7045 (Elastomer)	PA5041 (x24) 6.00x8.8/12.20x10.00 866N W (FPM) HR5062 ⊕	













[12] Bolt / Nut Version: without plain washer





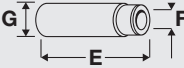

[12] Schrauben-/Mutterausführung: ohne Unterlegscheibe

545	 81.00	Petrol				
BDV	V6 Cyl.		2393cc	125kW (170)PS	TD16410	996
A4	09/01→12/05	A6	08/01→01/05			
						
TB556 253x30	TBK353 with tensioner pulley damper TBK357 without tensioner pulley damper		KIT			FOL133 ⊕ (x18) FOL141 ⊕ (x12)

						
B x C x D	OE	MAT.				E x F x G
V94081 ⊕ 26.90 x 6.00 x 105.10	058 109 601C		45°	Y	H	
V94083 ⊕ 29.90 x 6.00 x 103.90	058 109 611M		45°		H	

							
BZ960 MLS (x2)	DZ960 ○ (x2)		HBS270 ⊕ M11x1.50x133mm (x16)		HM5224 ⊕	PA5041 6.00x8.8/12.20x10.00 866N W (FPM)	

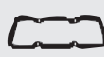
546	 81.00	Petrol				
BDW	V6 Cyl.		2393cc	130kW (177)PS	TD17374	
A6	05/04→10/08					
						
B x C x D	OE	MAT.				E x F x G
V95097 ⊕ 32.35 x 5.98 x 103.90	06E 109 601H		45°		H	VAG96073B ⊕ ⊕ ⊕ 36.00 x 6.02 x 11.06
V95098 ⊕ 33.80 x 5.98 x 103.95	079 109 601B		45°		H	
V94692 ⊕ 28.00 x 6.00 x 101.80	06D 109 611L		45°		H	
V94704 ⊕ 28.00 x 6.00 x 101.80	06D 109 611K		45°		H	

							
			HBS512		HM5224 ⊕	PA5041 (x24) 6.00x8.8/12.20x10.00 866N W (FPM) HR800 ⊕	

VW GROUP

547



81.00

Petrol



AGB	V6 Cyl.	2671cc	195kW (265)PS	TD11888
A4	09/97→09/01			

TB556 253x30	TBK353 with tensioner pulley damper TBK357 without tensioner pulley damper		KIT		FOL133 ■ (x18) FOL141 ■ (x12)

B x C x D	E x F x G
V94081 ■ 26.90 x 6.00 x 105.10	VAG96073B ■ ■ ■ 36.00 x 6.02 x 11.06
V94082 ■ 29.90 x 6.00 x 103.90	
OE: 058 109 601C	MAT. MB
OE: 058 109 611E	MAT. MG cr
45° Y H	45° ss H

BZ960 MLS (x2)			HBS270 ⊗ M11x1.50x133mm (x16)	JC478 ■	HM5224 ■	PA5041 (x30) 6.00x8.8/12.20x10.00 866N W (FPM)	NA5001 32.00x47.00x10.00mm FPM

548



81.00

Petrol











AJK	V6 Cyl.	9.3:1	2671cc	169kW (230)PS	Turbo	TD10813
AZA	V6 Cyl. 2671cc 169kW (230)PS				TD17164	
A4	02/99→09/00		A6		12/97→01/05	











TB556 253x30	TBK353 with tensioner pulley damper TBK357 without tensioner pulley damper		KIT		FOL133 ■ (x18) FOL141 ■ (x12)



B x C x D	E x F x G
V94081 ■ 26.90 x 6.00 x 105.10	VAG96073B ■ ■ ■ 36.00 x 6.02 x 11.06
V94082 ■ 29.90 x 6.00 x 103.90	
OE: 058 109 601C	MAT. MB
OE: 058 109 611E	MAT. MG cr
45° Y H	45° ss H









BZ960 MLS (x2)			HBS270 ⊗ M11x1.50x133mm (x16)		HM5224 ■	PA5041 (x30) 6.00x8.8/12.20x10.00 866N W (FPM)	NA5001 32.00x47.00x10.00mm FPM







549	 81.00	Petrol			
APB	V6 Cyl.	2671cc	187kW (254)PS	Bi-Turbo Intercooled	TD17865
ASJ	V6 Cyl.	2671cc	280kW (380)PS		TD14150
AZR	V6 Cyl.	2671cc	280kW (380)PS		TD16417
A4	08/98→09/01	A6	05/01→07/04	ALLROAD	09/00→08/05



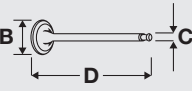
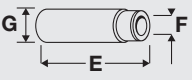







					
TB556 253x30	TBK353 with tensioner pulley damper TBK357 without tensioner pulley damper		KIT		

							
			HBS270  M11x1.50x133mm (x16)		HM5224 	PA5041 (x30) 6.00x8.8/12.20x10.00 866N W (FPM)	NA5001 32.00x47.00x10.00mm FPM

550	 81.00	Petrol			
ARE	V6 Cyl.	2671cc	184kW (250)PS	Turbo Intercooled	TD15328
BES	V6 Cyl.	2671cc	184kW (250)PS	Turbo Intercooled	TD16432
A6	08/01→01/05	ALLROAD	05/00→08/05		

					
TB556 253x30	TBK353 with tensioner pulley damper TBK357 without tensioner pulley damper		KIT		FOL133  (x18) FOL141  (x12)

	
B x C x D	E x F x G
V94081  26.90 x 6.00 x 105.10	VAG96073B  36.00 x 6.02 x 11.06
V94082  29.90 x 6.00 x 103.90	
OE	MAT.
058 109 601C	 MB
058 109 611E	 MG cr
45°	45°
Y	ss
H	H

							
BZ960 MLS (x2)			HBS270  M11x1.50x133mm (x16)		HM5224 	PA5041 (x30) 6.00x8.8/12.20x10.00 866N W (FPM)	NA5001 32.00x47.00x10.00mm FPM

551	81.00	Petrol						
AZB	V6 Cyl.	9.3:1	2671cc	195kW (265)PS				TD20534
A4	09/97→09/01							

B x C x D	OE	MAT.	45°	Y	H	E x F x G	
V94081 ■ 26.90 x 6.00 x 105.10	058 109 601C		45°	Y	H	VAG96073B ■ ■ ■ 36.00 x 6.02 x 11.06	
V94082 ■ 29.90 x 6.00 x 103.90	058 109 611E		45°	ss	H		

BZ960 MLS (x2)			HBS270 ☒ M11x1.50x133mm (x16)	JC478 ■	HM5224 ■	PA5041 6.00x8.8/12.20x10.00 866N W (FPM)	NA5001 32.00x47.00x10.00mm FPM

552	81.00	Petrol						
BEL	V6 Cyl.		2671cc	187-195kW (254-265)PS	Turbo Intercooled			TD20674
A6	05/01→07/04							
	ALLROAD		09/00→08/05					

			HBS270 ☒ M11x1.50x133mm (x16)		HM5224 ■	PA5041 6.00x8.8/12.20x10.00 866N W (FPM)	NA5001 32.00x47.00x10.00mm FPM

553

81.00

Petrol



AAA	V6 Cyl.	10.1:1	2792cc	128kW (174)PS	TD3999	997
GOLF	01/92→09/97	PASSAT	06/91→05/97	SHARAN	09/95→04/00	
VENTO	01/92→09/98					

					FOL92 (x12)

	OE	MAT.			H	
B x C x D						E x F x G
V94145	021 109 601K		45°		H	VAG96157B
39.10 x 7.00 x 106.00		MB				38.00 x 7.00 x 12.00
V94374	021 109 601L		45°		H	
39.00 x 7.00 x 106.00		MB				
V94146	021 109 611F		45°	ss	H	
34.10 x 7.00 x 107.00		MG				

AA5430 Fibre Composite	CA5430 [15]		HBS077	JD5232	JM5030	HR662	
			M11x1.50x85mm (x7)	JA5068	JM5099		
			M11x1.50x144mm (x3)	JA5069	AAA146001		
			M11x1.50x119mm (x10)	JD5109			

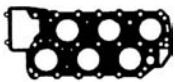

AA5430

[54] To cylinder 1 - 3
 [61] To cylinder 4 - 6
 [15] Without shaft seal

[54] zum Zylinder 1 - 3
 [61] zum Zylinder 4 - 6
 [15] Ohne Wellendichtring

VW GROUP

554







 81.00







Petrol



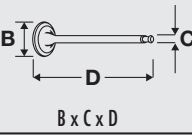



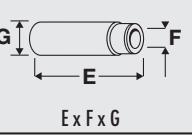

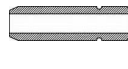

AE5 V6 Cyl. 10:1 2792cc 103kW (140)PS TD9346 998

TRANSPORTER 11/95→05/00

					
					FOL92 (x12)

 B x C x D	OE	MAT. 	45° 	H 	 E x F x G
V94374 ■ 39.00 x 7.00 x 106.00	021 109 601L	MB 			VAG96157B ■ ■ 38.00 x 7.00 x 12.00 

							
AA5430 Fibre Composite	CA5430 [15]		HBS077 ⊕ M11x1.50x85mm (x7) M11x1.50x144mm (x3) M11x1.50x119mm (x10)	JA5068 ■ JA5069 ■ [54] JD5109 ■ [61]	JM5030	HR662 ■	

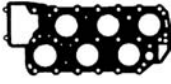

AA5430

[54] To cylinder 1 - 3
[61] To cylinder 4 - 6
[15] Without shaft seal

[54] zum Zylinder 1 - 3
[61] zum Zylinder 4 - 6
[15] Ohne Wellendichtring

555





 81.00



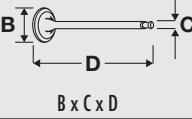

Petrol



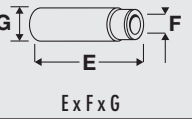





AMV V6 Cyl. 2792cc 150kW (204)PS TD15128 999

TRANSPORTER 04/00→04/03

 B x C x D	OE	MAT. 	45° 	Y 	H 	 E x F x G
---	----	---	--	--	--	---

V94406 ■ 31.00 x 6.00 x 102.10	022 109 601E	MB 	45°	Y	H
V94642 ■ 31.00 x 6.00 x 136.00	022 109 601F	MB 	45°		H
V94407 ■ 27.00 x 6.00 x 136.40	022 109 611C	MG 	45°	ss	H
V94641 ■ 27.00 x 6.00 x 102.50	022 109 611B	MG 	45°	ss	H

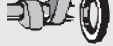
							
---	---	---	---	---	--	---	---

AG5000 MLS	CG5000		HBS526 [12]	JD5928 ■ (Steel Elastomer) JE5077 (x2) (Steel Elastomer)	JM7045 (Elastomer)	PA5041 (x24) 6.00x8.8/12.20x10.00 866N W (FPM)	
------------	--------	--	-------------	---	-----------------------	--	--



AG5000

[12] Bolt / Nut Version: without plain washer

[12] Schrauben-/Mutterausführung: ohne Unterlegscheibe

556	81.00	Petrol				
AMY	V6 Cyl.	10.75:1	2792cc	128kW (174)PS	TD17199	998
SHARAN 09/95→04/00						

B x C x D	OE	MAT.				E x F x G
V94145	021 109 601K	MB	45°		H	VAG96041B E 36.50 x 7.00 x 12.08
39.10 x 7.00 x 106.00						
V94374	021 109 601L	MB	45°		H	
39.00 x 7.00 x 106.00						
V94146	021 109 611F	MG	45°	ss	H	
34.10 x 7.00 x 107.00						

			HBS077 M11x1.50x85mm (x7) M11x1.50x144mm (x3) M11x1.50x119mm (x10)	JA5069 [54] JD5109 [61]	JM5030 JM5099 AAA146001	HR622	

[54] To cylinder 1 - 3 [54] zum Zylinder 1 - 3
 [61] To cylinder 4 - 6 [61] zum Zylinder 4 - 6

557	81.00	Petrol				
AQP	V6 Cyl.	10.75:1	2792cc	150kW (204)PS	TD12849	999
BORA 03/99→05/05 GOLF 03/99→06/06						

			KIT				FOL154 (x24)

B x C x D	OE	MAT.				E x F x G
V94406	022 109 601E	MB	45°	Y	H	VAG96073B E 36.00 x 6.02 x 11.06
31.00 x 6.00 x 102.10						
V94642	022 109 601F	MB	45°		H	
31.00 x 6.00 x 136.00						
V94407	022 109 611C	MG	45°	ss	H	
27.00 x 6.00 x 136.40						
V94641	022 109 611B	MG	45°	ss	H	
27.00 x 6.00 x 102.50						

AG5000 MLS	CG5010		HBS526 [12]		JM7045 (Elastomer)	PA5041 (x24) 6.00x8.8/12.20x10.00 866N W (FPM) HR5062	

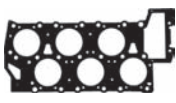

AG5000

[12] Bolt / Nut Version: without plain washer [12] Schrauben-/Mutterausführung: ohne Unterlegscheibe

558

81.00

Petrol



AUE	V6 Cyl.	10.75:1	2792cc	150kW (204)PS	TD15482	999
AUE	V6 Cyl.	10.75:1	2792cc	150kW (204)PS	TD16137	999

ALHAMBRA	06/00→03/10	BORA	03/99→05/05	GOLF	03/99→06/06
LEON	02/01→06/06				

					FOL154 (x24)

	OE	MAT.			
B x C x D					E x F x G
V94642	022 109 601F		45°	H	VAG96073B
31.00 x 6.00 x 136.00 01/02→					
V94406	022 109 601E		45°	Y H	
31.00 x 6.00 x 102.10					
V94641	022 109 611B		45°	ss H	
27.00 x 6.00 x 102.50 01/02→					
V94407	022 109 611C		45°	ss H	
27.00 x 6.00 x 136.40					

AG5000	CG5010		HBS526 [12]	JD5857 (Elastomer)	HR397 JM7045 (Elastomer)	PA5041 (x24) 6.00x8.8/12.20x10.00 866N W (FPM) HR5062	

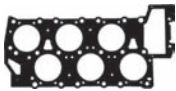

AG5000

[12] Bolt / Nut Version: without plain washer

[12] Schrauben-/Mutterausführung: ohne Unterlegscheibe

559

81.00

Petrol



AYL	V6 Cyl.	10.5:1	2792cc	150kW (204)PS	TD14910	999
AYL	V6 Cyl.	10.5:1	2792cc	150kW (204)PS	TD14916	999

ALHAMBRA	06/00→03/10	SHARAN	04/00→03/10
----------	-------------	--------	-------------

						FOL154 (x24)
--	--	--	--	--	--	---------------------

	OE	MAT.				
B x C x D						E x F x G
V94406 ■	022 109 601E		45°	Y	H	
31.00 x 6.00 x 102.10		MB				
V94642 ■	022 109 601F		45°		H	
31.00 x 6.00 x 136.00		MB				
V94407 ■	022 109 611C		45°	ss	H	
27.00 x 6.00 x 136.40		MG				
V94641 ■	022 109 611B		45°	ss	H	
27.00 x 6.00 x 102.50		MG				

AG5000 MLS	CG5030	HBS526 [12]	JD5857 ■ (Elastomer)	JM7045 (Elastomer)	PA5041 (x24) 6.00x8.8/12.20x10.00 866N W (FPM)	HR5062 ■

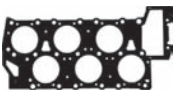

AG5000

[12] Bolt / Nut Version: without plain washer

[12] Schrauben-/Mutterausführung: ohne Unterlegscheibe







560











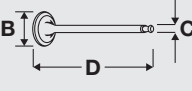

 81.00









Petrol



BDE	V6 Cyl.	10.75:1	2792cc	150kW (204)PS	TD16390	1000
BDE	V6 Cyl.	10.75:1	2792cc	150kW (204)PS	TD18753	1000
BORA	03/99→05/05	GOLF	03/99→06/06	LEON	05/02→06/04	

					
					FOL154 (x24)

 B x C x D	OE	MAT.				 E x F x G
V94406  31.00 x 6.00 x 102.10	022 109 601E	 MB	45°	Y	H	
V94642  31.00 x 6.00 x 136.00	022 109 601F	 MB	45°		H	
V94407  27.00 x 6.00 x 136.40	022 109 611C	 MG	45°	ss	H	
V94641  27.00 x 6.00 x 102.50	022 109 611B	 MG	45°	ss	H	

							
AG5000 MLS			HBS526 [12]		JM7045 (Elastomer)	PA5041 (x24) 6.00x8.8/12.20x10.00 866N W (FPM) HR5062 	

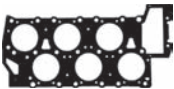

AG5000

[12] Bolt / Nut Version: without plain washer

[12] Schrauben-/Mutterausführung: ohne Unterlegscheibe







561









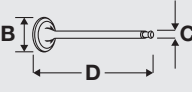

 81.00











Petrol













PT	V8 Cyl.	3562cc	184kW (250)PS	TD310	1001
V8	10/88→02/94				





					
TB604 299x30					FOL141 (x32)

 B x C x D	OE	MAT.				 E x F x G
V91416  32.10 x 6.97 x 95.50	027 109 601C	 MB	45°		H	VAG96157B  38.00 x 7.00 x 12.00
V91372  28.10 x 6.95 x 98.20	027 109 611D	 MG cr	45°		H	

562	 81.00	Diesel					
BVD	4 Cyl.	1968cc	90kW (122)PS			TD18542	948
       							
AG8800 MLS, 1.630mm, 2 Holes AG8960 MLS, 1.710mm, 3 Holes AG8970 MLS, 1.550mm, 1 Hole	CG8410 ▲				JM7031 (Elastomer)	PA5041 (x16) 6.00x8.8/12.20x10.00 866N W (FPM)	

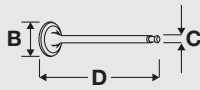
563	 81.00	Diesel					
ASE	V8 Cyl.	3936cc	202kW (275)PS	Turbo			TD17030
A8 05/03→07/05							
     							
TB759 83x30							

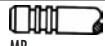
564	 81.00	Diesel					
AJS	V10 Cyl.	18:1	4921cc	230kW (313)PS	Turbo	TD16530	1002
AYH	V10 Cyl.	18.5:1	4921cc	230kW (313)PS	Bi-Turbo Intercooled	TD17043	1002
PHAETON 11/02→							
TOUAREG 10/02→05/10							

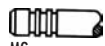
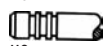
							
B x C x D	OE	MAT.				E x F x G	
V94147 ■	038 109 601B		45°		H	VAG96041B ■ ■ ■	
35.90 x 7.00 x 89.90		MB				36.50 x 7.00 x 12.08	
V94148 ■	038 109 611B		45°	ss	H		
31.50 x 7.00 x 90.00		MG					
V94415 ■	038 109 611F		45°	ss	H		
31.40 x 7.00 x 89.50		MG					

565



81.00

Diesel



BLE V10 Cyl. 18.5:1 4921cc 230kW (313)PS Turbo Intercooled TD20527

TOUAREG 10/02→05/10

 B x C x D		OE	 MAT.	 45°	 Y	 H	 E x F x G	
V94649	038 109 601E		45°	Y	H			
36.00 x 7.00 x 89.40								
V94650	038 109 611E		45°	ss	H			
31.40 x 7.00 x 89.00								

566



81.00

Diesel



CBWA V10 Cyl. 4921cc 230-257kW (313-350)PS Turbo Intercooled TD21348

TOUAREG 08/07→05/10

 B x C x D		OE	 MAT.	 45°	 Y	 H	 E x F x G	
V94649	038 109 601E		45°	Y	H			
36.00 x 7.00 x 89.40								
V94650	038 109 611E		45°	ss	H			
31.40 x 7.00 x 89.00								

567

83.00

Diesel



BPP	V6 Cyl.	2698cc	132kW (180)PS	Turbo Intercooled	TD18926	1003
BSG	V6 Cyl.	2698cc	120kW (163)PS	Turbo Intercooled	TD18030	1004
A4	11/05→03/09	A6	11/04→08/11	A6 Allroad	05/06→08/11	

TB760					
83x24					
Driven unit: injection pump					







B x C x D	E x F x G
OE	
MAT.	
V98010 ■	45°
28.80 x 6.00 x 99.50	
V98011 ■	45° ss
26.80 x 6.00 x 99.50	







AG8880 MLS, 1.100mm, 1 Hole [54]	CG8880 ▲		HBS361 ⊕	JD5872 ■	JM7046 [54]	PA5041 (x24)	NA5001
AG8900 MLS, 1.100mm, 1 Hole [61]			M12x1.50x159mm (x16)	(ACM)	(ACM)	6.00x8.8/12.20x10.00	32.00x47.00x10.00mm FPM
AG8860 MLS, 1.150mm, 2 Holes [54]					JM7047 [61]	866N W (FPM)	
AG8870 MLS, 1.150mm, 2 Holes [61]					(ACM)	HR5062 ■	
AG8890 MLS, 1.200mm, 3 Holes [54]							
AG8910 MLS, 1.200mm, 3 Holes [61]							
AG8860	AG8870	AG8880	AG8890	AG8900	AG8910		
[54] To cylinder 1 - 3	[54] zum Zylinder 1 - 3						
[61] To cylinder 4 - 6	[61] zum Zylinder 4 - 6						



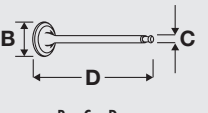
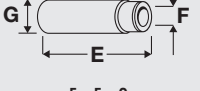





568
 **82.00**
Petrol







ABV	V6 Cyl.	2861cc	140kW (190)PS	TD4977	1005
------------	---------	--------	---------------	---------------	-------------

CORRADO	08/91→12/95	GOLF	10/94→04/99	PASSAT	01/94→05/97
----------------	-------------	-------------	-------------	---------------	-------------

					
					FOL92 (x12)

	
B x C x D	E x F x G
OE	
MAT.	
	
V94145 	VAG96157B 
39.10 x 7.00 x 106.00	38.00 x 7.00 x 12.00
V94306 	
34.20 x 7.00 x 107.00	
021 109 601K	
021 109 611D	
MB	
MG	
45°	45° ss
H	H

							
---	---	---	---	---	--	---	---

AA5430 Fibre Composite	CA5430 [15]	HBS077 	JD5232 	JM5030	HR662 
		M11x1.50x85mm (x7)	JA5068 	JM5099	
		M11x1.50x144mm (x3)	JA5069 	AAA146001	
		M11x1.50x119mm (x10)	JD5109 		

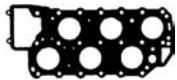
AA5430

[54] To cylinder 1 - 3

[61] To cylinder 4 - 6

[15] Without shaft seal

[54] zum Zylinder 1 - 3

[61] zum Zylinder 4 - 6

[15] Ohne Wellendichtring

569

82.50
Petrol

BYT	4 Cyl.		1798cc	118kW (160)PS	Turbo Intercooled	TD19901
BYT	4 Cyl.		1798cc	118kW (160)PS	Turbo Intercooled	TD20089
CABA	4 Cyl.		1798cc	88kW (120)PS	Turbo	TD20590
CABB	4 Cyl.		1798cc	118kW (160)PS	Turbo	TD20594
CABD	4 Cyl.		1798cc	125kW (170)PS	Turbo	TD20113
CAEA	4 Cyl.		1984cc	132kW (180)PS	Turbo Intercooled	TD21115
CAEB	4 Cyl.		1984cc	155kW (211)PS	Turbo Intercooled	TD21116
CAWA	4 Cyl.		1984cc	125kW (170)PS	Turbo Intercooled	TD20733
CAWB	4 Cyl.		1984cc	147kW (200)PS	Turbo Intercooled	TD20714
CAWB	4 Cyl.		1984cc	147kW (200)PS	Turbo Intercooled	TD20732
CBFA	4 Cyl.	10.5:1	1984cc	147kW (200)PS	Turbo Intercooled	TD20797
CBFA	4 Cyl.	10.5:1	1984cc	147kW (200)PS	Turbo Intercooled	TD22663
CCTA	4 Cyl.	10.5:1	1984cc	147kW (200)PS	Turbo Intercooled	TD20795
CCTA	4 Cyl.	10.5:1	1984cc	147kW (200)PS	Turbo Intercooled	TD22666
CCTB	4 Cyl.		1984cc	125kW (170)PS	Turbo Intercooled	TD20796
CCZB	4 Cyl.		1984cc	155kW (211)PS	Turbo Intercooled	TD22181
CCZB	4 Cyl.		1984cc	155kW (211)PS	Turbo Intercooled	TD22672
CDNB	4 Cyl.		1984cc	132kW (180)PS	Turbo Intercooled	TD20936
CDNC	4 Cyl.		1984cc	155kW (211)PS	Turbo	TD20937

A3	09/04 →	A4	11/07 →	A4 Allroad	04/09 →
A5	10/07 →	A6	03/11 →	ALTEA	01/07 →
ALTEA XL	01/07 →	BEETLE	04/11 →	CC	11/11 →
EOS	03/06 →	GOLF	10/04 →	JETTA	10/05 →
LEON	06/09 →	PASSAT	07/05 →	PASSAT ALLTRACK	01/12 →
PASSAT CC	06/08 →	Q5	11/08 →	SCIROCCO	05/08 →05/11
TIGUAN	09/07 →	TOLEDO	01/07 →05/09	TT	08/06 →06/10

B x C x D	OE	E x F x G
V94692	06D 109 611L	 MG
28.00 x 6.00 x 101.80		45°
V94704	06D 109 611K	 MG
28.00 x 6.00 x 101.80		45°

AH5380 MLS			HBS476			PA5041 (x16)	
			M10x1.50x117mm (x10)			6.00x8.8/12.20x10.00	
						866N W (FPM)	
						HR791	

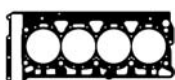
AH5380

VW GROUP

570



82.50

Petrol



CADA Euro 5	4 Cyl.	9.6:1	1984cc	155kW (211)PS	Turbo Intercooled	TD23991
CDAB	4 Cyl.	9.6:1	1798cc	112kW (152)PS	Turbo Intercooled	TD23735
CDAB	4 Cyl.	9.6:1	1798cc	112kW (152)PS	Turbo Intercooled	TD24597
CDLB	4 Cyl.		1984cc	200kW (272)PS		TD21735
CDMA	4 Cyl.		1984cc	195kW (265)PS		TD24962
CGYA	4 Cyl.		1798cc	112kW (152)PS	Turbo Intercooled	TD23736

A4	06/08 →	CC	11/11 →	OCTAVIA	03/09 →
PASSAT	11/09 →	PASSAT ALLTRACK	01/12 →	PASSAT CC	11/08 →05/10
SUPERB	03/09 →	TT	05/08 →	YETI	11/09 →



HBS476 
M10x1.50x117mm (x10)

PA5041 (x16)
6.00x8.8/12.20x10.00
866N W (EPM)
HR791 

571

82.50

Petrol



CCZA	4 Cyl.		1984cc	147kW (200)PS	Turbo Intercooled	TD22170
CCZA	4 Cyl.		1984cc	147kW (200)PS	Turbo Intercooled	TD22171
CCZA	4 Cyl.		1984cc	147kW (200)PS	Turbo Intercooled	TD22172
CCZA	4 Cyl.		1984cc	147kW (200)PS	Turbo Intercooled	TD24656
CDAA	4 Cyl.		1798cc	118kW (160)PS	Turbo	TD20938
CDAA	4 Cyl.		1798cc	118kW (160)PS	Turbo	TD20943
CDAA	4 Cyl.		1798cc	118kW (160)PS	Turbo	TD21590
CDAA	4 Cyl.		1798cc	118kW (160)PS	Turbo	TD22641
CDHA	4 Cyl.	9.6:1	1798cc	88kW (120)PS	Turbo	TD21113
CDHA	4 Cyl.	9.6:1	1798cc	88kW (120)PS	Turbo Intercooled	TD24317
CDHB	4 Cyl.	9.6:1	1798cc	118kW (160)PS	Turbo	TD21114
CDHB	4 Cyl.	9.6:1	1798cc	118kW (160)PS	Turbo Intercooled	TD24319

A3	09/04 →	A4	11/07 →	A5	05/09 →
ALHAMBRA	11/10 →	ALTEA	01/07 →	ALTEA XL	01/07 →
BETLE	04/11 →	CC	11/11 →	EOS	03/06 →
EXEO	05/10 →	GOLF	06/09 →	JETTA	10/05 →
LEON	06/07 →	OCTAVIA	10/05 →	PASSAT	07/05 →
PASSAT ALLTRACK	01/12 →	PASSAT CC	06/08 →	SHARAN	12/10 →
SUPERB	03/08 →	TIGUAN	09/07 →	TOLEDO	01/07 →05/09
TT	06/08 →	YETI	05/09 →		

B x C x D	OE	Ex F x G
V94692	06D 109 611L	
28.00 x 6.00 x 101.80		45°
V94704	06D 109 611K	
28.00 x 6.00 x 101.80		45°

AH5380 MLS			HBS476			PA5041 (x16)	NA5124
			M10x1.50x117mm (x10)			6.00x8.8/12.20x10.00	32.00x47.00x10.00mm PTFE/ACM
						866N W (FPM)	
						HR791	

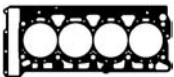

AH5380

572



82.50

Petrol



SD 4 Cyl. 1847cc 83kW (113)PS

TD323 1006

80 09/86 → 08/90

TB108 121x18	TBK016		KIT		FOL92 (x8)

V91407 39.60 x 7.97 x 91.90	VAG92105B 42.30 x 7.99 x 12.08
V91340 33.30 x 7.95 x 91.20	

BT810 Fibre Composite	DT813	HBS043 M11x1.50x95mm (x10)	JC152 (x4) JE689	HL457 [9] (Cork) HM5053 [10] (ACM)	HR363 HR569	NA5001 32.00x47.00x10.00mm FPM	





BT810







[9] Centering Diameter [mm]: 8.5







[9] Zentrierdurchmessers [mm]: 8.5



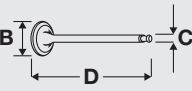



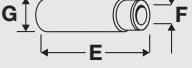

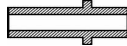
[10] Centering Diameter [mm]: 6.5

[10] Zentrierdurchmessers [mm]: 6.5

573	 82.50	Petrol			
2E	4 Cyl.	10.4:1	1984cc	85kW (115)PS	TD3570 1007
2E	4 Cyl.	10.4:1	1984cc	85kW (115)PS	TD4963 1007
CORDOBA	02/93→06/99	CORRADO	04/93→12/95	GOLF	11/91→04/99
IBIZA	03/93→08/99	PASSAT	02/90→05/97	TOLEDO	05/91→03/99
VENTO	11/91→09/98				

					
TB506 124x18	TBK076				FOL143 (x8)

					
B x C x D	OE	MAT.	45°	H	E x F x G
V91407 ■ 39.60 x 7.97 x 91.90	048 109 601A		45°		VAG92061B ■ ■ ■ 36.70 x 8.00 x 12.08
V91340 ■ 33.30 x 7.95 x 91.20	053 109 611		45°	H	

							
BT810 Fibre Composite	DT811 →Eng.2E 565 664 DT816 Eng.2E 565 665→	HBS043 ⊕ M11x1.50x95mm (x10)	JD483 ■ JC152 ■ (x4) ⊕ JF205	JPO24	HR569 ■ →Eng.2E 565 664 HR816 ■ Eng.2E 565 665→	NA5001 32.00x47.00x10.00mm FPM	



BT810

VW GROUP

574



82.50

Petrol



3A 4 Cyl. 1984cc 83kW (113)PS TD4191 1008

80 08/88→08/91 COUPE 05/89→07/90

TB108 121x18	TBK016				FOL92 (x8)

B x C x D	OE	MAT.	45°	H	E x F x G
V91407 ■ 39.60 x 7.97 x 91.90	048 109 601A		45°		VAG92061B ■ ■ ■ 36.70 x 8.00 x 12.08
V91340 ■ 33.30 x 7.95 x 91.20	048 109 611A		45°	H	

BT810 Fibre Composite	DT813		HBS043 ⊕ M11x1.50x95mm (x10)	JC152 ■ (x4) ■ JE689	HL457 ■ [9] (Cork) HM5053 ■ [10] (ACM)	HR569 ■	NA5001 32.00x47.00x10.00mm FPM



BT810

[9] Centering Diameter [mm]: 8.5

[9] Zentrierdurchmesser [mm]: 8.5

[10] Centering Diameter [mm]: 6.5

[10] Zentrierdurchmesser [mm]: 6.5

575



82.50

Petrol



6A 4 Cyl. 1984cc 101kW (137)PS TD4193 1009

80 03/90→07/92 90 08/89→07/90 COUPE 01/92→07/92

TB505 147x25.4	TBK066	CAM739 ■ CAM740 ■			FOL92 (x16)

B x C x D	OE	MAT.	45°	H	E x F x G
V91416 ■ 32.10 x 6.97 x 95.50	027 109 601C		45°	H	VAG96157B ■ ■ ■ 38.00 x 7.00 x 12.00
V91372 ■ 28.10 x 6.95 x 98.20	027 109 611D		45°	H	

BT810 Fibre Composite	DT813		HBS028 ⊕ M11x1.50x147mm (x10)	JD281 ■ JD282 ■ (x4)	HL606 ■	HR599 ■ HR816 ■ (x2)	NA5001 32.00x47.00x10.00mm FPM



BT810

576	82.50	Petrol				
9A	4 Cyl.	10.5:1	1984cc	100kW (136)PS	TD3998	1009
CORRADO	08/91→12/95	PASSAT	08/88→09/93			

	.KIT		KIT		
TB505 147x25.4	TBK066				FOL92 (x16)

B x C x D	OE	MAT.	E x F x G
V91416 ■ 32.10 x 6.97 x 95.50	027 109 601C	 MB	VAG96157B ■ ■ ■ 38.00 x 7.00 x 12.00
V91372 ■ 28.10 x 6.95 x 98.20	027 109 611D	 MG cr	

BT810 Fibre Composite	DT812	HBS028 ⊕ M11x1.50x147mm (x10)	JD281 ■ JD282 ■ (x4) ⊕ JF205	HL606 ■	HR599 ■ HR816 ■ (x2)	NA5001 32.00x47.00x10.00mm FPM

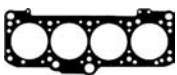

BT810

577	82.50	Petrol			
AAD	4 Cyl.	1984cc	85kW (115)PS	TD222	1010
100	12/90→06/94	80	10/90→08/91	COUPE	05/89→12/96

	.KIT		KIT		
TB506 124x18	TBK109				FOL92 (x8)

B x C x D	OE	MAT.	E x F x G
V91407 ■ 39.60 x 7.97 x 91.90	048 109 601A	 MD	VAG92061B ■ ■ ■ 36.70 x 8.00 x 12.08
V91340 ■ 33.30 x 7.95 x 91.20	048 109 611A	 MG	

BT810 Fibre Composite	DT814	HBS043 ⊕ M11x1.50x95mm (x10)	JD483 ■ JC152 ■ (x4) ⊕ JE689	HL457 ■ [9] (Cork) HM5053 ■ [10] (ACM)	HR569 ■	NA5001 32.00x47.00x10.00mm FPM



BT810

[9] Centering Diameter [mm]: 8.5
[10] Centering Diameter [mm]: 6.5

[9] Zentrierdurchmessers [mm]: 8.5
[10] Zentrierdurchmessers [mm]: 6.5



AAE	4 Cyl.	1984cc	74kW (100)PS	TD223	1011
100	12/90 → 06/94	A6	06/94 → 12/97		

TB506 124x18	TBK109		KIT		FOL143 (x8)

V91407 ■ 39.60 x 7.97 x 91.90	V91340 ■ 33.30 x 7.95 x 91.20	VAG92061B ■ ■ ■ 36.70 x 8.00 x 12.08
OE: 048 109 601A	OE: 048 109 611A	
MAT. MD	MAT. MG	
45°	45°	H

BT810 Fibre Composite BY750 MLS	DT814 →Ch.4A-P-160 000 DY750 DT815 Ch.4A-P-160 001→				HBS043 ⊕ M11x1.50x95mm (x10)	PA459 ■ (NBR) JC152 ■ (x4)		JP024 HL457 ■ [9] (Cork) →Ch.4A-P-160 000 HM5053 ■ [10] (ACM)		HR569 ■ →Eng.032 209 AAF HR816 ■ Eng.032 210 → AAE		NA5001 32.00x47.00x10.00mm FPM	

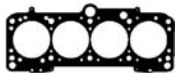

BT810

BY750

[9] Centering Diameter [mm]: 8.5

[9] Zentrierdurchmesser [mm]: 8.5

[10] Centering Diameter [mm]: 6.5

[10] Zentrierdurchmesser [mm]: 6.5

579

82.50

Petrol



ABF	4 Cyl.	10.4:1	1984cc	110kW (150)PS	TD4007	1012
ABF	4 Cyl.	10.4:1	1984cc	110kW (150)PS	TD4895	1012
CORDOBA	08/96→06/99		GOLF	08/92→08/97	IBIZA	08/96→08/99
PASSAT	01/94→05/97		SHARAN	09/95→02/00	TOLEDO	11/93→03/99

TB441		CAM739 ■			FOL92 (x16)
151x25.4		CAM740 ■			

B x C x D	OE	MAT.	45°	Y	H
V94110 ■	051 109 601B		45°	Y	H
32.00 x 7.00 x 95.50		MB			
V94111 ■	051 109 611B		45°		H
27.00 x 7.00 x 97.95		MG			

BT810 Fibre Composite →Ch.4A-S-110 000 BY750 MLS	DT81B [14] Eng.031 252→		HBS028 ⊕ M11x1.50x147mm (x10)	JD281 ■ JD282 ■ (x4) JF205	HL606 ■ HL731 ■	HR599 ■ HR816 ■ (x2)	NA5001 32.00x47.00x10.00mm FPM

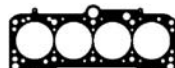

BT810

BY750

[14] With shaft oil seal

[14] Mit Wellendichtring

580

82.50

Petrol



ABK	4 Cyl.	1984cc	85kW (115)PS	TD233	1007
100	12/90→06/94	80	09/91→01/96	A6	06/94→12/97
CABRIOLET	01/93→07/98	COUPE	05/89→12/96		

TB506 124x18	TBK109	FOL143 (x8)

 B x C x D V91407 ■ 39.60 x 7.97 x 91.90 V91340 ■ 33.30 x 7.95 x 91.20	OE 048 109 601A 048 109 611A	MAT. MD MG	45° 45° H	 E x F x G VAG92061B ■ ■ ■ 36.70 x 8.00 x 12.08
---	------------------------------------	--------------------------	-----------------	---

BT810 Fibre Composite	DT814	HBS043 ⊕ M11x1.50x95mm (x10)	JD483 ■ JC152 ■ (x4) ⊕ JE689	JP024 HL457 ■ [9] (Cork) HM5053 ■ [10] (ACM)	HR569 ■	NA5001 32.00x47.00x10.00mm FPM





BT810







[9] Centering Diameter [mm]: 8.5







[9] Zentrierdurchmessers [mm]: 8.5



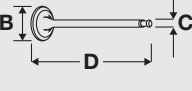

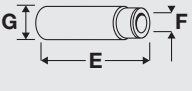



[10] Centering Diameter [mm]: 6.5

[10] Zentrierdurchmessers [mm]: 6.5

581	 82.50	Petrol	
ABT	4 Cyl.	1984cc	66kW (89)PS
80	09/91 → 01/96		
		TD236	1013

					
TB506 124x18	TBK109				FOL143 (x8)

			
B x C x D	OE	MAT.	E x F x G
V91407 ■ 39.60 x 7.97 x 91.90	048 109 601A	 MD	VAG92061B ■ ■ ■ 36.70 x 8.00 x 12.08
V91340 ■ 33.30 x 7.95 x 91.20	048 109 611A	 MG	 H

							
BT810 Fibre Composite	DT815 →Ch.8C-P-185 164 DT81C	HBS043 ⊕ M11x1.50x95mm (x10)	JD482 ■ JC152 ■ (x4)	JP024 HM5053 ■ [10] (ACM) →Ch.8C-P-185 164	HR569 ■ →Eng.246 861 HR816 ■ Eng.246 862 →	NA5001 32.00x47.00x10.00mm FPM	



BT810

[10] Centering Diameter [mm]: 6.5

[10] Zentrierdurchmessers [mm]: 6.5

VW GROUP







582







 82.50



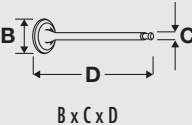



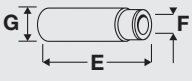

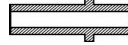
Petrol



ACE	4 Cyl.	1984cc	103kW (140)PS		TD238	1014
100	01/92→06/94	80	04/92→01/96	A6	06/94→12/97	
CABRIOLET	06/95→07/96	COUPE	08/92→12/96			



					
TB505 147x25.4	TBK066	CAM739 ■ CAM740 ■	KIT		FOL92 (x16)



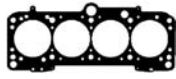





				
B x C x D	OE	MAT.		E x F x G
V94110 ■ 32.00 x 7.00 x 95.50	051 109 601B	 MB	45° Y H	VAG96041B ■ ■ ■ 36.50 x 7.00 x 12.08
V94111 ■ 27.00 x 7.00 x 97.95	051 109 611B	 MG	45° H	

							
BY750 MLS	DY751 →Eng.017 542 DY752 Eng.017 543→		HBS028 ⊕ M11x1.50x147mm (x10) →Eng.017 543	JD282 ■ (x4) ■ JE689	HL606 ■ →Eng.017 542 HL731 ■ Eng.017 543→	HR599 ■ HR816 ■ (x2)	NA5001 32.00x47.00x10.00mm FPM



BY750

583	 82.50	Petrol		
ADC	4 Cyl.	1984cc	85kW (115)PS	TD15609

							
			HBS043 ⊕ M11x1.50x95mm (x10)	JD599 ■ ■ ■ JD600 ■ JF205	JP024	HR816 ■	NA5001 32.00x47.00x10.00mm FPM NB446

584

82.50

Petrol



ADY	4 Cyl.	10.4:1	1984cc	85kW (115)PS	TD4979	1007
ADY	4 Cyl.	10.4:1	1984cc	85kW (115)PS	TD9386	1007
ALHAMBRA	04/96→03/10				GOLF	11/91→04/99
PASSAT	02/90→05/97				SHARAN	09/95→03/10
					VENTO	11/91→09/98

TB506 124x18	TBK076		KIT		FOL143 (x8)

B x C x D	OE	MAT.	45°	H	E x F x G
V94079 ■ 39.40 x 7.00 x 92.10	078 109 601B		45°	H	VAG96041B ■ ■ ■ ■ 36.50 x 7.00 x 12.08
V94080 ■ 32.80 x 7.00 x 91.20	048 109 611B		45°	H	

BY750 MLS	DY753 [14]	HBS043 ⊕ M11x1.50x95mm (x10)	JD483 ■ JD5293 ■ ■ JF205	JP024	HR569 ■ → Eng.000 778 ADY HR816 ■ Eng.000 779 →	NA5001 32.00x47.00x10.00mm FPM NA5124 32.00x47.00x10.00mm PTFE/ACM			

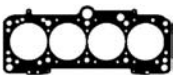

BY750

[14] With shaft oil seal

[14] Mit Wellendichtring

585

82.50

Petrol



AEG	4 Cyl.	10.5:1	1984cc	85kW (115)PS	TD13442	1015
AEG	4 Cyl.	10.5:1	1984cc	85kW (115)PS	TD16280	1015

NEW BEETLE	01/98→	OCTAVIA	04/99→05/07
------------	--------	---------	-------------

TB552 138x23	TBK100	CAM913		FOL92 (x8)

B x C x D	OE	MAT.	45°	H	E x F x G
V94079 ■ 39.40 x 7.00 x 92.10	078 109 601B		45°	H	VAG96041B ■ ■ ■ 36.50 x 7.00 x 12.08
V94080 ■ 32.80 x 7.00 x 91.20	048 109 611B		45°	H	

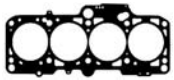

AB5370 MLS	CB5370 [15]	HBS246 ☼ M10x1.50x120mm (x10)	JD5314 ■ (FPM) LA5204 ■ JD5293 ■	JM5103	HR816 ■	NA5124 32.00x47.00x10.00mm PTFE/ACM











AB5370







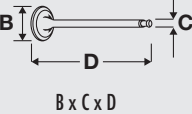

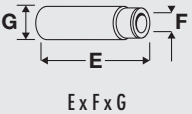
[15] Without shaft seal

[15] Ohne Wellendichtring

586	 82.50	Petrol	
AEP	4 Cyl.	1984cc	79kW (107)PS
GOLF	08/95→09/97	PASSAT	03/95→08/96
		VENTO	05/96→12/97

					
TB506 124x18	TBK076		KIT		FOL143 (x8)

		
B x C x D	OE	MAT.
V91338 ■ 38.10 x 7.97 x 91.90	035 109 601K	45°
V91340 ■ 33.30 x 7.95 x 91.20	053 109 611	45° H
	MD	
	MG	
		VAG92061B ■ ■ 36.70 x 8.00 x 12.08

							
BY750 MLS	DY753 [14]	HBS043 ⊕ M11x1.50x95mm (x10)	JD483 ■ JC152 ■ (x4) ⊕ JF205	JP024	HR569 ■ →Eng.000 778 HR816 ■ Eng.000 779 →	NA5001 32.00x47.00x10.00mm FPM	

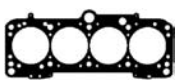

BY750

[14] With shaft oil seal

[14] Mit Wellendichtring

587



82.50
Petrol

AGG	4 Cyl.	10:1	1984cc	85kW (115)PS	TD4989	1017
AGG	4 Cyl.	10:1	1984cc	85kW (115)PS	TD5537	1017
CORDOBA	02/93→06/99		GOLF	11/91→06/02	IBIZA	03/93→08/99
PASSAT	02/90→05/97		TOLEDO	05/91→03/99	VENTO	11/91→09/98

TB506 124x18	TBK076	CAM913	KIT	FOL143 (x8)

V94307 ■ 39.50 x 7.00 x 91.90	V94584 ■ 32.85 x 7.00 x 91.15	VAG96041B ■ ■ ■ 36.50 x 7.00 x 12.08
OE: 037 109 601	OE: 037 109 611B	
MAT. MB	MAT. MG	
45° Y H	45° ss H	

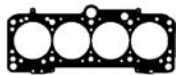
BY750 MLS	DY753 [14]	HB5043 ⊕ M11x1.50x95mm (x10)	JD483 ■ JC152 ■ (x4) ■ JF205	JP024	HR599 ■	NA5001 32.00x47.00x10.00mm FPM		

BY750

[14] With shaft oil seal

[14] Mit Wellendichtring

588







 82.50









Petrol

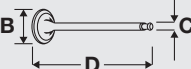



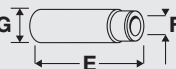





AKR 4 Cyl. 1984cc 85kW (115)PS TD11354 1018

GOLF 11/91→06/02 VENTO 11/91→09/98

					
TB506 124x18	TBK076	CAM913			FOL143 (x8)

					
B x C x D	OE	MAT.	45°	H	E x F x G
V94079 ■ 39.40 x 7.00 x 92.10	078 109 601B	 MB	45°	H	VAG96041B ■ ■ ■ 36.50 x 7.00 x 12.08 
V94080 ■ 32.80 x 7.00 x 91.20	048 109 611B	 MG	45°	H	
V94303 ■ 32.90 x 7.00 x 91.20	078 109 611C	 MG	45° ss	H	

							
BY750 MLS	DY753 [14]	HBS043 ⊕ M11x1.50x95mm (x10)	JD483 ■ JC152 ■ (x4)  JF205	JP024	HR569 ■ →Eng.000 778 HR816 ■ Eng.000 779 →		NA5001 32.00x47.00x10.00mm FPM

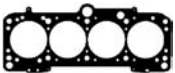

BY750

[14] With shaft oil seal

[14] Mit Wellendichtring

589

82.50

Petrol



ALT	4 Cyl.	10.3:1	1984cc	96kW (131)PS	TD15345	1019
ALT	4 Cyl.	10.3:1	1984cc	96kW (131)PS	TD17040	

A4	11/00→06/08	A6	08/01→01/05	PASSAT	11/01→05/05
----	-------------	----	-------------	--------	-------------

TB554 150x23	TBK341 with tensioner pulley damper				FOL133 ■ (x12) FOL141 ■ (x8)

	OE	MAT.		
V94081 ■ 26.90 x 6.00 x 105.10	058 109 601C		45° Y H	VAG96073B ■ ■ ■ 36.00 x 6.02 x 11.06
V94083 ■ 29.90 x 6.00 x 103.90	058 109 611M		45° H	

AG8810 MLS	CG8420		HB5510	JD5820 ■ JD5813 ■	JM7030 (Steel Elastomer)	PA5041 (x8) 6.00x8.8/12.20x10.00 866N W (FPM) HR817 ■	NA5124



AG8810

590	82.50	Petrol				
APK	4 Cyl.	10.3:1	1984cc	85kW (115)PS	TD11927	1015
APK	4 Cyl.	10.3:1	1984cc	85kW (115)PS	TD16031	1015
AQY	4 Cyl.	10.5:1	1984cc	85kW (115)PS	TD10607	1015
AQY	4 Cyl.	10.5:1	1984cc	85kW (115)PS	TD13869	1015
BORA	10/98→05/05	FABIA	12/99→03/08	GOLF	07/98→06/06	
NEW BEETLE	01/98→	OCTAVIA	04/99→05/07			

TB552 138x23	TBK100				FOL143 (x8)

B x C x D	E x F x G
V94079 ■	VAG96041B ■ ■ ■
39.40 x 7.00 x 92.10	36.50 x 7.00 x 12.08
V94080 ■	
32.80 x 7.00 x 91.20	
OE	
MAT.	
45°	
H	
MB	
MG	

AB5370 MLS	CB5370 [15]		HBS246 ☒ M10x1.50x120mm (x10)	JD5314 ■ (FPM) JD5293 ■	JM5103 JPO24	HR816 ■	NA5124 32.00x47.00x10.00mm PTFE/ACM

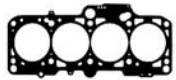

AB5370

[15] Without shaft seal [15] Ohne Wellendichtring

591	82.50	Petrol		
ATF	4 Cyl.	1984cc	85kW (115)PS	TD16048
OCTAVIA	01/00→12/10			

TB552 138x23	TBK100				

VW GROUP

592	82.50	Petrol				
ATM	4 Cyl.	10.5:1	1984cc	85kW (115)PS	TD14908	1020
ATM	4 Cyl.	10.5:1	1984cc	85kW (115)PS	TD14913	1020
ALHAMBRA	04/96→03/10	SHARAN	09/95→03/10			

TB552 138x23	TBK100				FOL143 (x8)

B x C x D	OE	MAT.	45°	H	E x F x G
V94079	078 109 601B		45°	H	VAG96041B
39.40 x 7.00 x 92.10		MB			36.50 x 7.00 x 12.08
V94080	048 109 611B		45°	H	
32.80 x 7.00 x 91.20		MG			

AB5370 MLS			HBS246	JD5292	JM5103	HR816	NA5124
			M10x1.50x120mm (x10)	JD5293			32.00x47.00x10.00mm PTFE/ACM

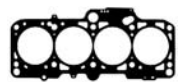



AB5370







593	82.50	Petrol			
ATU	4 Cyl.	1984cc	85kW (115)PS	TD15490	1021
GOLF	06/98→06/02				











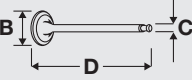

		CAM913			FOL143 (x8)

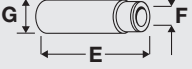







B x C x D	OE	MAT.	45°	H	E x F x G
V94079	078 109 601B		45°	H	VAG96041B
39.40 x 7.00 x 92.10		MB			36.50 x 7.00 x 12.08
V94080	048 109 611B		45°	H	
32.80 x 7.00 x 91.20		MG			
V94303	078 109 611C		45°	ss	H
32.90 x 7.00 x 91.20		MG			

				JD600	JP024		NA5124
				JF205			32.00x47.00x10.00mm PTFE/ACM

594	 82.50	Petrol	
AVH	4 Cyl.	1984cc	85kW (115)PS
TD19258			
NEW BEETLE 01/98 →			



					
FOL92 (x8)					



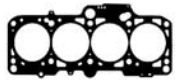



 B x C x D	OE	MAT.				 E x F x G
V94079 	078 109 601B	 MB	45°		H	VAG96041B  36.50 x 7.00 x 12.08
V94080 	048 109 611B	 MG	45°		H	
V94303 	078 109 611C	 MG	45°	ss	H	









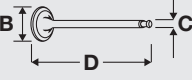

							
AB5370 MLS				JD5293 	JM5103		





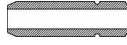









AB5370

595	 82.50	Petrol	
AWA	4 Cyl.	11.5:1	1984cc
110kW (150)PS			
TD17035 1022			
A4 07/02 → 12/04			

					
TB745 145x23 →06/04					FOL154 (x16)
TB753 148x23 06/04 →					

 B x C x D	OE	MAT.				 E x F x G
V94691 	06D 109 601K	 MB	45°	Y	H	VAG96073B  36.00 x 6.02 x 11.06
V94692 	06D 109 611L	 MG cr	45°		H	
V94704 	06D 109 611K	 MG	45°		H	

							
AG9600 MLS	CG9600		HBS363  M10x1.50x122mm (x10)	JD5873  (FPM) JD5813 	JM7048 (Steel Elastomer)	PA5041 (x16) 6.00x8.8/12.20x10.00 866N W (FPM) HR791 	NA5124 32.00x47.00x10.00mm PTFE/ACM

VW GROUP

596







 82.50











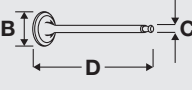



Petrol











AWF	4 Cyl.	1984cc	85kW (115)PS	TD15488	1021
AWG	4 Cyl.	1984cc	85kW (115)PS	TD15489	1021

GOLF 06/98→06/02

					
CAM913			FOL143 (x8)		

 B x C x D	OE	MAT.				 E x F x G
V94079  39.40 x 7.00 x 92.10	078 109 601B	 MB	45°		H	VAG96041B  36.50 x 7.00 x 12.08
V94080  32.80 x 7.00 x 91.20	048 109 611B	 MG	45°		H	
V94303  32.90 x 7.00 x 91.20	078 109 611C	 MG	45°	ss	H	

							
				JD600 	JP024		NA5124 32.00x47.00x10.00mm PTFE/ACM

597







 82.50











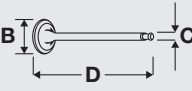

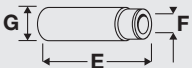

Petrol



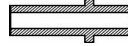











AXA	4 Cyl.	10.3:1	1984cc	85kW (115)PS	TD16866	1023
AXA	4 Cyl.	10.3:1	1984cc	85kW (115)PS	TD16865	1023

MULTIVAN 11/03→ TRANSPORTER 11/03→



					
TB552 138x23	TBK100				FOL143 (x8)







 B x C x D	OE	MAT.				 E x F x G
V94079  39.40 x 7.00 x 92.10	078 109 601B	 MB	45°		H	VAG96041B  36.50 x 7.00 x 12.08
V94080  32.80 x 7.00 x 91.20	048 109 611B	 MG	45°		H	
V94303  32.90 x 7.00 x 91.20	078 109 611C	 MG	45°	ss	H	





							
AB5370 MLS			HBS246  M10x1.50x120mm (x10)	JD5292  JD5293 	JM5103	HR646 	NA5124 32.00x47.00x10.00mm PTFE/ACM





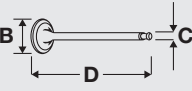
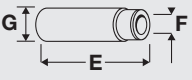











AB5370







598	 82.50	Petrol					
AXW	4 Cyl.	11.5:1	1984cc	110kW (150)PS	TD16872	1022	
AXW	4 Cyl.	11.5:1	1984cc	110kW (150)PS	Turbo Intercooled	TD17081	1022
A3	05/03→06/08	GOLF	01/04→11/08	TOURAN	10/03→11/05		



					
TB745					FOL154 (x16)
145x23					







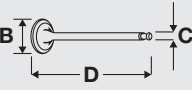
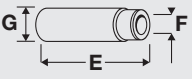



	
B x C x D	E x F x G
V94691 	VAG96073B 
33.85 x 6.00 x 104.00	36.00 x 6.02 x 11.06
V94692 	
28.00 x 6.00 x 101.80	
V94704 	
28.00 x 6.00 x 101.80	

							
AG9600 MLS	CG9600		HBS363  M10x1.50x122mm (x10)	JD5873  (FPM) JD5813 	JM7048 (Steel Elastomer)	PA5041 (x16) 6.00x8.8/12.20x10.00 866N W (FPM) HR791 	NA5124 32.00x47.00x10.00mm PTFE/ACM

599	 82.50	Petrol				
AXX	4 Cyl.	10.3:1	1984cc	147kW (200)PS	Turbo Intercooled	TD17450
AXX	4 Cyl.	10.3:1	1984cc	147kW (200)PS	Turbo Intercooled	TD18540
A3	09/04 →	GOLF	10/04 →02/09	JETTA	10/05 →10/10	
PASSAT	07/05 →11/10					

					
TB753					
148x23					

	
B x C x D	E x F x G
V94692 	
28.00 x 6.00 x 101.80	
V94704 	
28.00 x 6.00 x 101.80	

							
AH5380 MLS			HBS363  M10x1.50x122mm (x10) HBS476  M10x1.50x117mm (x10)			PA5041 (x16) 6.00x8.8/12.20x10.00 866N W (FPM) HR791 	NA5124 32.00x47.00x10.00mm PTFE/ACM

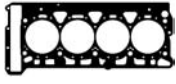

AH5380

VW GROUP

600







 **82.50**









Petrol

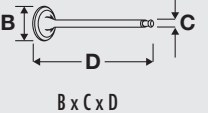



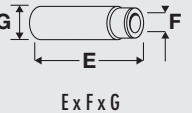





AZG 4 Cyl. 1984cc **85kW (115)PS** **TD15470**

BORA 10/98 → 05/05 **GOLF** 07/98 → 05/04 **NEW BEETLE** 01/98 →

					
TB552 138x23	TBK100		KIT		FOL143 (x8)

				
B x C x D	OE	MAT.		E x F x G
V94079 ■ 39.40 x 7.00 x 92.10	078 109 601B	 MB	45°	VAG96041B ■ ■ ■ 36.50 x 7.00 x 12.08
V94080 ■ 32.80 x 7.00 x 91.20	048 109 611B	 MG	45°	
V94303 ■ 32.90 x 7.00 x 91.20	078 109 611C	 MG	45° ss	

							
AB5370 MLS	CB5370 [15]		HBS246 ⊗ M10x1.50x120mm (x10)	JD5314 ■ (FPM) JD5293 ■	JM5103	HR646 ■	NA5124 32.00x47.00x10.00mm PTFE/ACM

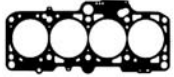

AB5370

[15] Without shaft seal

[15] Ohne Wellendichtring

601

82.50

Petrol



AZH	4 Cyl.	1984cc	85kW (115)PS	TD15479	1024
AZH	4 Cyl.	1984cc	85kW (115)PS	TD16092	1024
BORA	10/98→05/05	GOLF	10/00→06/06	OCTAVIA	04/99→05/07

TB552 138x23	TBK100		KIT		FOL143 (x8)

B x C x D	E x F x G
V94079 ■ 39.40 x 7.00 x 92.10	VAG96041B ■ ■ ■ 36.50 x 7.00 x 12.08
V94080 ■ 32.80 x 7.00 x 91.20	
OE: 078 109 601B (MAT. MB)	45° H
048 109 611B (MAT. MG)	45° H

AB5370 MLS	CB5370 [15]	HBS246 ⊗ M10x1.50x120mm (x10)	JD5314 ■ (FPM) JD5340 ■ (x4) JD5293 ■	JM5103 JPO24	HR816 ■	NA5124 32.00x47.00x10.00mm PTFE/ACM

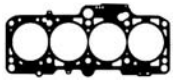

AB5370

[15] Without shaft seal

[15] Ohne Wellendichtring

602

82.50

Petrol



AZJ	4 Cyl.	10.5:1	1984cc	85kW (115)PS	TD16419	1025
AZJ	4 Cyl.	10.5:1	1984cc	85kW (115)PS	TD17466	1025
BORA	10/98→05/05		GOLF	07/98→06/06	NEW BEETLE	01/98→
OCTAVIA	04/99→05/07					

TB552 138x23	TBK100		KIT		FOL143 (x8)

B x C x D	E x F x G																										
<table border="1"> <tr> <th>OE</th> <th>MAT.</th> <th>Angle</th> <th>Coating</th> <th>Height</th> </tr> <tr> <td>V94079 ■ 39.40 x 7.00 x 92.10</td> <td>078 109 601B MB</td> <td>45°</td> <td></td> <td>H</td> </tr> <tr> <td>V94080 ■ 32.80 x 7.00 x 91.20</td> <td>048 109 611B MG</td> <td>45°</td> <td></td> <td>H</td> </tr> <tr> <td>V94303 ■ 32.90 x 7.00 x 91.20</td> <td>078 109 611C MG</td> <td>45°</td> <td>ss</td> <td>H</td> </tr> </table>	OE	MAT.	Angle	Coating	Height	V94079 ■ 39.40 x 7.00 x 92.10	078 109 601B MB	45°		H	V94080 ■ 32.80 x 7.00 x 91.20	048 109 611B MG	45°		H	V94303 ■ 32.90 x 7.00 x 91.20	078 109 611C MG	45°	ss	H	<table border="1"> <tr> <th>Part Number</th> <th>Dimensions</th> <th>Material</th> </tr> <tr> <td>VAG96041B ■ ■ ■</td> <td>36.50 x 7.00 x 12.08</td> <td></td> </tr> </table>	Part Number	Dimensions	Material	VAG96041B ■ ■ ■	36.50 x 7.00 x 12.08	
OE	MAT.	Angle	Coating	Height																							
V94079 ■ 39.40 x 7.00 x 92.10	078 109 601B MB	45°		H																							
V94080 ■ 32.80 x 7.00 x 91.20	048 109 611B MG	45°		H																							
V94303 ■ 32.90 x 7.00 x 91.20	078 109 611C MG	45°	ss	H																							
Part Number	Dimensions	Material																									
VAG96041B ■ ■ ■	36.50 x 7.00 x 12.08																										

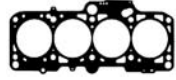

AB5370 MLS	CB5370 [15]		HBS246 ☼ M10x1.50x120mm (x10)	JD5314 ■ (FPM)	JM5103	HR599 ■ HR646 ■ HR816 ■	NA5124 32.00x47.00x10.00mm PTFE/ACM













AB5370





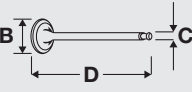
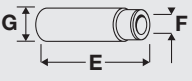







[15] Without shaft seal

[15] Ohne Wellendichtring

603	 82.50	Petrol				
AZL	4 Cyl.	10.5:1	1984cc	85kW (115)PS	TD16241	1026
AZL	4 Cyl.	10.5:1	1984cc	85kW (115)PS	TD17901	1026
CORDOBA	09/02→11/09	FABIA	12/99→03/08	IBIZA	04/02→11/09	

					
TB552 138x23	TBK100				FOL143 (x8)



	
B x C x D	E x F x G
V94079  078 109 601B 39.40 x 7.00 x 92.10 V94080  048 109 611B 32.80 x 7.00 x 91.20	VAG96041B   36.50 x 7.00 x 12.08







							
AB5370 MLS	CB5370 [15]	HBS246  M10x1.50x120mm (x10)	JD5291  JD5293 	JP024	HR816 	NA5124 32.00x47.00x10.00mm PTFE/ACM	











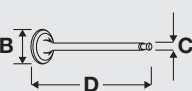
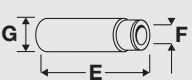











AB5370

[15] Without shaft seal [15] Ohne Wellendichtring

604	 82.50	Petrol				
AZM	4 Cyl.	10.3:1	1984cc	85kW (115)PS	TD15150	1025
AZM	4 Cyl.	10.3:1	1984cc	85kW (115)PS	TD16366	1025
PASSAT	11/00→05/05	SUPERB	12/01→03/08			

					
TB552 138x23	TBK100				FOL143 (x8)

	
B x C x D	E x F x G
V94079  078 109 601B 39.40 x 7.00 x 92.10 V94080  048 109 611B 32.80 x 7.00 x 91.20	VAG96041B   36.50 x 7.00 x 12.08

									
AB5370 MLS	CB5371	HBS246  M10x1.50x120mm (x10)	JD5341  JD600 	JP024	HR599  HR646  HR816 	NA5124 32.00x47.00x10.00mm PTFE/ACM			

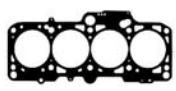

AB5370

605



82.50

Petrol



BBX	4 Cyl.	10.5:1	1984cc	85kW (115)PS	TD18446	1027
BBX	4 Cyl.	10.5:1	1984cc	85kW (115)PS	TD21077	1027
CORDOBA		09/02→11/09		IBIZA		04/02→11/09

TB552 138x23	TBK100		KIT		

B x C x D	E x F x G																								
<table border="1"> <tr> <th>OE</th> <th>MAT.</th> <th>Angle</th> <th>Material</th> </tr> <tr> <td>V94079 ■</td> <td>078 109 601B</td> <td>45°</td> <td>H</td> </tr> <tr> <td>39.40 x 7.00 x 92.10</td> <td>MB</td> <td></td> <td></td> </tr> <tr> <td>V94080 ■</td> <td>048 109 611B</td> <td>45°</td> <td>H</td> </tr> <tr> <td>32.80 x 7.00 x 91.20</td> <td>MG</td> <td></td> <td></td> </tr> </table>	OE	MAT.	Angle	Material	V94079 ■	078 109 601B	45°	H	39.40 x 7.00 x 92.10	MB			V94080 ■	048 109 611B	45°	H	32.80 x 7.00 x 91.20	MG			<table border="1"> <tr> <th>Part</th> <th>Dimensions</th> </tr> <tr> <td>VAG96041B ■ ■</td> <td>36.50 x 7.00 x 12.08</td> </tr> </table>	Part	Dimensions	VAG96041B ■ ■	36.50 x 7.00 x 12.08
OE	MAT.	Angle	Material																						
V94079 ■	078 109 601B	45°	H																						
39.40 x 7.00 x 92.10	MB																								
V94080 ■	048 109 611B	45°	H																						
32.80 x 7.00 x 91.20	MG																								
Part	Dimensions																								
VAG96041B ■ ■	36.50 x 7.00 x 12.08																								

AB5370 MLS			HBS246 ☒ M10x1.50x120mm (x10)	LA5204 ■ JD5293 ■	JM5103	HR642 ■ HR646 ■	NA5124 32.00x47.00x10.00mm PTFE/ACM

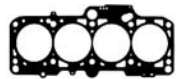

AB5370

606



82.50

Petrol



BDC	4 Cyl.	10.3:1	1984cc	85kW (115)PS	TD16744	
BGD	4 Cyl.	10.3:1	1984cc	85kW (115)PS	TD16745	

NEW BEETLE 09/02→10/10

B x C x D	E x F x G																																
<table border="1"> <tr> <th>OE</th> <th>MAT.</th> <th>Angle</th> <th>Material</th> </tr> <tr> <td>V94079 ■</td> <td>078 109 601B</td> <td>45°</td> <td>H</td> </tr> <tr> <td>39.40 x 7.00 x 92.10</td> <td>MB</td> <td></td> <td></td> </tr> <tr> <td>V94080 ■</td> <td>048 109 611B</td> <td>45°</td> <td>H</td> </tr> <tr> <td>32.80 x 7.00 x 91.20</td> <td>MG</td> <td></td> <td></td> </tr> <tr> <td>V94303 ■</td> <td>078 109 611C</td> <td>45°</td> <td>ss H</td> </tr> <tr> <td>32.90 x 7.00 x 91.20</td> <td>MG</td> <td></td> <td></td> </tr> </table>	OE	MAT.	Angle	Material	V94079 ■	078 109 601B	45°	H	39.40 x 7.00 x 92.10	MB			V94080 ■	048 109 611B	45°	H	32.80 x 7.00 x 91.20	MG			V94303 ■	078 109 611C	45°	ss H	32.90 x 7.00 x 91.20	MG			<table border="1"> <tr> <th>Part</th> <th>Dimensions</th> </tr> <tr> <td>VAG96041B ■ ■</td> <td>36.50 x 7.00 x 12.08</td> </tr> </table>	Part	Dimensions	VAG96041B ■ ■	36.50 x 7.00 x 12.08
OE	MAT.	Angle	Material																														
V94079 ■	078 109 601B	45°	H																														
39.40 x 7.00 x 92.10	MB																																
V94080 ■	048 109 611B	45°	H																														
32.80 x 7.00 x 91.20	MG																																
V94303 ■	078 109 611C	45°	ss H																														
32.90 x 7.00 x 91.20	MG																																
Part	Dimensions																																
VAG96041B ■ ■	36.50 x 7.00 x 12.08																																



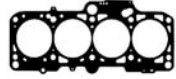







AB5370 MLS	CB5370 [15]		HBS246 ☒ M10x1.50x120mm (x10)	JD5340 ■ (x4) JD5293 ■	JM5103	HR599 ■ HR646 ■	NA5124 32.00x47.00x10.00mm PTFE/ACM























AB5370

[15] Without shaft seal

[15] Ohne Wellendichtung

607		82.50	Petrol				
BEF	4 Cyl.	1984cc	43kW (58)PS	TD25872			
							
				JPO24	HR646 		

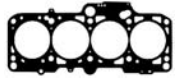

608		82.50	Petrol	
BEH	4 Cyl.	1984cc	85kW (115)PS	TD16527 1027
GOLF 02/02→06/06				

							
TB552 138x23	TBK100		KIT		FOL143 (x8)		
							
AB5370 MLS	CB5370 [15]		HBS246  M10x1.50x120mm (x10)	JD5340  (x4) JD5293 	JM5103	HR599  HR646 	NA5124 32.00x47.00x10.00mm PTFE/ACM















AB5370



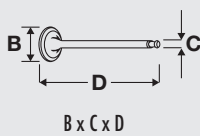
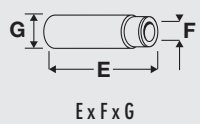





[15] Without shaft seal [15] Ohne Wellendichtring

609		82.50	Petrol		
BEJ	4 Cyl.	10.3:1	1984cc	85kW (115)PS	TD21073 1027
BER	4 Cyl.	10.3:1	1984cc	85kW (115)PS	TD18049 1027
BHP	4 Cyl.		1984cc	85kW (115)PS	TD21074 1027

NEW BEETLE 01/98 →

					
TB552 138x23	TBK100		KIT		

	
B x C x D	E x F x G
OE	
MAT.	
V94079 	VAG96041B   
39.40 x 7.00 x 92.10	36.50 x 7.00 x 12.08
V94080 	
32.80 x 7.00 x 91.20	
V94303 	
32.90 x 7.00 x 91.20	

							
AB5370 MLS				JD5293 	JM5103		



AB5370

610







 82.50







Petrol



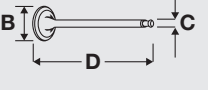
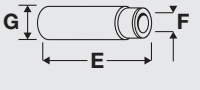





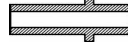

BEV 4 Cyl. 10.3:1 1984cc 85kW (115)PS TD19254

NEW BEETLE 01/98 →

					
TB552 138x23	TBK100				FOL92 (x8)

			
B x C x D	OE	MAT.	Ex F x G
V94079 	078 109 601B	 MB	45° H
39.40 x 7.00 x 92.10			
V94080 	048 109 611B	 MG	45° H
32.80 x 7.00 x 91.20			
V94303 	078 109 611C	 MG	45° ss H
32.90 x 7.00 x 91.20			
			VAG96041B  36.50 x 7.00 x 12.08

							
AB5370.MLS				JD5293 	JM5103		

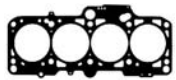

AB5370

611







 82.50



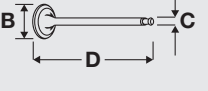
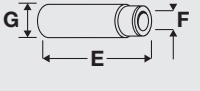





Petrol



BFF 4 Cyl. 1984cc 85kW (115)PS TD19132



PASSAT 11/00 → 05/05

			
B x C x D	OE	MAT.	Ex F x G
V94079 	078 109 601B	 MB	45° H
39.40 x 7.00 x 92.10			
V94080 	048 109 611B	 MG	45° H
32.80 x 7.00 x 91.20			
V94303 	078 109 611C	 MG	45° ss H
32.90 x 7.00 x 91.20			

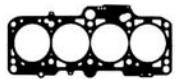





							
AB5370.MLS				JD600 	JP024		















AB5370

612		 82.50	Petrol			
BGB	4 Cyl.		1984cc	147kW (200)PS	Turbo Intercooled	TD18008
BWE	4 Cyl.	10.3:1	1984cc	147kW (200)PS	Turbo Intercooled	TD18968
BWE	4 Cyl.	10.3:1	1984cc	147kW (200)PS	Turbo Intercooled	TD22246
BWJ	4 Cyl.	10.3:1	1984cc	177kW (240)PS	Turbo	TD19425
BWT	4 Cyl.		1984cc	147kW (200)PS	Turbo Intercooled	TD19705
CDLD	4 Cyl.	10.3:1	1984cc	177kW (240)PS	Turbo Intercooled	TD23090







A4	11/04 → 03/09	EXEO	03/09 →	LEON	11/06 →
----	---------------	------	---------	------	---------









					
TB753 148x23					

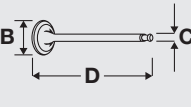



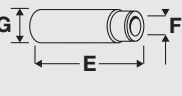





							
			HBS476  M10x1.50x117mm (x10)			PA5041 (x16) 6.00x8.8/12.20x10.00 866N W (FPM) HR791 	

613		 82.50	Petrol			
BHZ	4 Cyl.		1984cc	195kW (265)PS	Turbo	TD19821
BPJ	4 Cyl.	10.3:1	1984cc	125kW (170)PS	Turbo Intercooled	TD18486
BPY	4 Cyl.	10.3:1	1984cc	147kW (200)PS	Turbo Intercooled	TD18883
BPY	4 Cyl.	10.3:1	1984cc	147kW (200)PS	Turbo Intercooled	TD20704
BYD	4 Cyl.	10.3:1	1984cc	169kW (230)PS	Turbo Intercooled	TD19430
BZC	4 Cyl.		1984cc	188kW (256)PS	Turbo	TD20842
CDLC	4 Cyl.		1984cc	188kW (256)PS		TD22469
CDLC	4 Cyl.		1984cc	188kW (256)PS		TD22470
CDLF	4 Cyl.		1984cc	199kW (270)PS	Turbo Intercooled	TD23525

A3	09/04 →	A4	10/06 → 06/08	A6	06/05 → 08/11
EOS	03/06 →	GOLF	10/04 → 11/13	JETTA	10/05 → 10/10
PASSAT	07/05 → 11/10	SCIROCCO	11/09 →	TT	08/06 → 06/10

					
TB753 148x23					

				
B x C x D	OE	MAT.		E x F x G
V94692 	06D 109 611L		45°	H
28.00 x 6.00 x 101.80		MG cr		
V94704 	06D 109 611K		45°	H
28.00 x 6.00 x 101.80		MG		

							
			HBS476  M10x1.50x117mm (x10)			PA5041 (x16) 6.00x8.8/12.20x10.00 866N W (FPM) HR791 	NA5124 32.00x47.00x10.00mm PTFE/ACM

614

82.50

Petrol



BLR	4 Cyl.	11.5:1	1984cc	110kW (150)PS	TD17353	1022
BLR	4 Cyl.	11.5:1	1984cc	110kW (150)PS	TD18102	1022
BLR	4 Cyl.	11.5:1	1984cc	110kW (150)PS	TD18134	1022
BLR	4 Cyl.	11.5:1	1984cc	110kW (150)PS	TD18199	1022
BLX	4 Cyl.	11.5:1	1984cc	110kW (150)PS	TD17404	1022
BLX	4 Cyl.	11.5:1	1984cc	110kW (150)PS	TD17985	1022
BLX	4 Cyl.	11.5:1	1984cc	110kW (150)PS	TD20393	1022
BLY	4 Cyl.	11.5:1	1984cc	110kW (150)PS	TD17354	1022
BLY	4 Cyl.	11.5:1	1984cc	110kW (150)PS	TD17405	1022
BLY	4 Cyl.	11.5:1	1984cc	110kW (150)PS	TD17986	1022
BLY	4 Cyl.	11.5:1	1984cc	110kW (150)PS	TD18101	1022
BVX	4 Cyl.	11.5:1	1984cc	110kW (150)PS	TD18912	1022
BVX	4 Cyl.	11.5:1	1984cc	110kW (150)PS	TD20394	1022
BVY	4 Cyl.	11.5:1	1984cc	110kW (150)PS	TD18200	1022
BVY	4 Cyl.	11.5:1	1984cc	110kW (150)PS	TD18266	1022
BVY	4 Cyl.	11.5:1	1984cc	110kW (150)PS	TD18468	1022
BVY	4 Cyl.	11.5:1	1984cc	110kW (150)PS	TD20518	1022
BVZ	4 Cyl.	11.5:1	1984cc	110kW (150)PS	TD18201	1022
BVZ	4 Cyl.	11.5:1	1984cc	110kW (150)PS	TD18267	1022
BVZ	4 Cyl.	11.5:1	1984cc	110kW (150)PS	TD18469	1022
BVZ	4 Cyl.	11.5:1	1984cc	110kW (150)PS	TD20519	1022

A3	05/03→	ALTEA	05/04→03/09	ALTEA XL	10/06→03/09
EOS	03/06→05/08	GOLF	01/04→11/08	JETTA	08/05→10/10
LEON	07/05→05/10	OCTAVIA	11/04→	PASSAT	03/05→11/10
TOLEDO	10/04→05/09	TOURAN	10/03→11/05		

TB753					
148x23					

B x C x D	OE	MAT.	45°	Y	H	E x F x G	
V94691 ■	06D 109 601K		45°		H	VAG96073B ■ ■ ■	
33.85 x 6.00 x 104.00		MB				36.00 x 6.02 x 11.06	
V94692 ■	06D 109 611L		45°		H		
28.00 x 6.00 x 101.80		MG α					
V94704 ■	06D 109 611K		45°		H		
28.00 x 6.00 x 101.80		MG					

AG9600 MLS	CG9600	HB5363 ⊕ M10x1.50x122mm (x10)	JD5873 ■ (FPM) JD5813 ■	JM7078 (Elastomer)	PA5041 (x16) 6.00x8.8/12.20x10.00 866N W (FPM) HR791 ■	NA5124 32.00x47.00x10.00mm PTFE/ACM

615	82.50	Petrol				
BMB	4 Cyl.	11.5:1	1984cc	110kW (150)PS	TD17406	1022
A3	05/03→					

TB753					
148x23					

B x C x D	OE	MAT.	45°	Y	H	E x F x G
V94691	06D 109 601K		45°			VAG96073B
33.85 x 6.00 x 104.00		MB				36.00 x 6.02 x 11.06
V94692	06D 109 611L		45°			
28.00 x 6.00 x 101.80		MG cr				
V94704	06D 109 611K		45°			
28.00 x 6.00 x 101.80		MG				

AG9600 MLS	CG9600		HBS363	JD5873	JM7048	PA5041 (x16)	NA5124
			M10x1.50x122mm (x10)	(FPM) JD5813	(Steel Elastomer)	6.00x8.8/12.20x10.00 866N W (FPM) HR791	32.00x47.00x10.00mm PTFE/ACM

616	82.50	Petrol					
BNL	4 Cyl.	1984cc	85kW (115)PS	TD25893			
						HR646	

617	82.50	Petrol				
BPG	4 Cyl.	10.5:1	1984cc	147kW (200)PS	Turbo Intercooled	TD20530
A4	11/04→06/08					



TB753					
148x23					







			HBS476		JM7046 [54]	PA5041 (x16)	
			M10x1.50x117mm (x10)		(ACM)	6.00x8.8/12.20x10.00	
					JM7047 [61]	866N W (FPM)	
					(ACM)		





[54] To cylinder 1 - 3 [54] zum Zylinder 1 - 3
 [61] To cylinder 4 - 6 [61] zum Zylinder 4 - 6

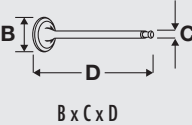
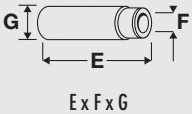

618	82.50	Petrol					
BTL	4 Cyl.	1984cc	85kW (115)PS	TD25895			
						HR646	

VW GROUP







619	 82.50	Petrol				
BUL	4 Cyl.	1984cc	162kW (220)PS	Turbo Intercooled	TD18484	
A4	06/05→06/08					







					
TB753 148x23					



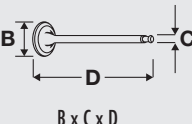
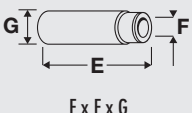







	
V94692  06D 109 611L 28.00 x 6.00 x 101.80	 MAT. MG cr 45°  H



620	 82.50	Petrol				
BWA	4 Cyl.	10.3:1	1984cc	147kW (200)PS	Turbo Intercooled	TD18541
BWA	4 Cyl.	10.3:1	1984cc	147kW (200)PS	Turbo Intercooled	TD19199
BWA	4 Cyl.	10.3:1	1984cc	147kW (200)PS	Turbo Intercooled	TD19424
BWA	4 Cyl.	10.3:1	1984cc	147kW (200)PS	Turbo Intercooled	TD20395







A3	09/04→	ALTEA	04/06→05/09	ALTEA XL	06/07→05/09
EOS	03/06→	GOLF	10/04→	JETTA	10/05→10/10
LEON	05/05→03/09	OCTAVIA	10/05→	PASSAT	07/05→11/10
TOLEDO	11/05→05/09	TT	08/06→06/10		

					
TB753 148x23					

	
V94692  06D 109 611L 28.00 x 6.00 x 101.80	 MAT. MG cr 45°  H
V94704  06D 109 611K 28.00 x 6.00 x 101.80	 MAT. MG 45°  H

							
			HBS476  M10x1.50x117mm (x10)			PA5041 (x16) 6.00x8.8/12.20x10.00 866N W (FPM) HR791 	

621	 82.50	Petrol				
BWA1	4 Cyl.	10.5:1	1984cc	136kW (185)PS	Turbo Intercooled	TD22668
LEON	09/05→05/06					

					
TB753 148x23					

622	82.50	Petrol				
BYK	4 Cyl.	1984cc	125kW (170)PS	Turbo Intercooled	TD20404	
A4	10/06→06/08	A6	06/05→03/11			

TB753					
148x23					

B x C x D	E x F x G
OE	
MAT.	

V94691	06D 109 601K		45°	Y	H	VAG96073B	
33.85 x 6.00 x 104.00						36.00 x 6.02 x 11.06	
V94692	06D 109 611L		45°		H		
28.00 x 6.00 x 101.80							
V94704	06D 109 611K		45°		H		
28.00 x 6.00 x 101.80							

			HBS476			PA5041	NA5124
			M10x1.50x117mm (x10)			6.00x8.8/12.20x10.00 866N W (FPM)	32.00x47.00x10.00mm PTFE/ACM

623	82.50	Petrol			
CBPA	4 Cyl.	1984cc	85kW (115)PS	TD21075	1027
JETTA	06/10→	NEW BEETLE	01/98→		



B x C x D	E x F x G
OE	
MAT.	









V94079	078 109 601B		45°		H	VAG96041B	
39.40 x 7.00 x 92.10						36.50 x 7.00 x 12.08	
V94080	048 109 611B		45°		H		
32.80 x 7.00 x 91.20							
V94303	078 109 611C		45°	ss	H		
32.90 x 7.00 x 91.20							

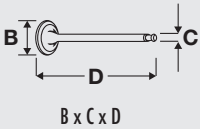

				JD5293	JM5103		

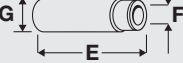





624	82.50	Petrol			
CBSA	4 Cyl.	1984cc	37kW (50)PS	TD23562	









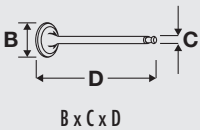

					HR646		











625	 82.50	Petrol			
CCZC	4 Cyl.	1984cc	125kW (170)PS	Turbo Intercooled	TD24964
CCZC	4 Cyl.	1984cc	125kW (170)PS	Turbo Intercooled	TD25726
Q3	06/11→	TIGUAN	09/07→		



	OE	MAT.				
V94692 	06D 109 611L		45°		H	
28.00 x 6.00 x 101.80		MG				
V94704 	06D 109 611K		45°		H	
28.00 x 6.00 x 101.80		MG				







626	 82.50	Petrol				
CDLA	4 Cyl.	9.8:1	1984cc	195kW (265)PS		TD21734
CDLA	4 Cyl.	9.8:1	1984cc	195kW (265)PS	Turbo Intercooled	TD22642
CDLA	4 Cyl.	9.8:1	1984cc	195kW (265)PS	Turbo Intercooled	TD22673
A3	11/06→	GOLF	11/09→	LEON	09/09→	
SCIROCCO	11/09→	TT	05/08→			









					
TB753					
148x23					

	OE	MAT.				
V94692 	06D 109 611L		45°		H	VAG96073B  
28.00 x 6.00 x 101.80		MG				36.00 x 6.02 x 11.06
V94704 	06D 109 611K		45°		H	
28.00 x 6.00 x 101.80		MG				

							
			HBS476 			PA5041 (x16)	NA5124
			M10x1.50x117mm (x10)			6.00x8.8/12.20x10.00	32.00x47.00x10.00mm PTFE/ACM
						866N W (FPM)	
						HR791 	

627	 82.50	CNG		
BSX	4 Cyl.	1984cc	80kW (109)PS	TD19005
CADDY	04/06→	TOURAN	02/06→05/09	

					
TB552	TBK100				FOL143 (x16)
138x23					

							
				JD5293 	JM5103		

628	82.50	Flexfuel				
CFKA	4 Cyl.	9.6:1	1984cc	132kW (180)PS	Turbo Intercooled	TD23856
A4	11/09→					
B x C x D	OE	MAT.				Ex F x G
V94692	06D 109 611L		45°		H	
28.00 x 6.00 x 101.80						
V94704	06D 109 611K		45°		H	
28.00 x 6.00 x 101.80						
			HBS476 M10x1.50x117mm (x10)			PA5041 6.00x8.8/12.20x10.00 866N W (FPM)

629	82.50	Petrol				
CGZ	4 Cyl.	1984cc	88kW (120)PS	TD25900		
						HR646

630	82.50	Petrol				
ADW	4 Cyl.	1985cc	79kW (107)PS	TD243	1029	
80	11/93→01/96	A6	08/95→07/96			
B x C x D	OE	MAT.				Ex F x G
V91407	048 109 601A		45°			VAG92061B 36.70 x 8.00 x 12.08
39.60 x 7.97 x 91.90						
V91340	048 109 611A		45°		H	
33.30 x 7.95 x 91.20						
AF5360 MLS, 1.610mm, 3 Holes			HBS043 M11x1.50x95mm (x10)	JC152 (x4) JE689	JP024	HR363
						NA5001 32.00x47.00x10.00mm FPM



AF5360

631

82.50

Petrol



7A 5 Cyl. 2309cc 125kW (170)PS TD221 1030

90 06/88→09/91 COUPE 11/88→12/96

TB504 147x19					FOL92 (x20)

B x C x D	E x F x G
V91416	VAG96157B
32.10 x 6.97 x 95.50	38.00 x 7.00 x 12.00
V91372	
28.10 x 6.95 x 98.20	
OE: 027 109 601C	
MAT.:	
45°	
H	

			HBS269	JD602	HL730		NA5001
			M11x1.50x141.5mm (x12)	JD282	(x5)		32.00x47.00x10.00mm FPM

632

82.50

Petrol



AAR 5 Cyl. 2309cc 98kW (133)PS TD4194 1031

100 01/90→06/94 A6 06/94→12/95

TB504 147x19	TBK285				FOL92 (x10)

B x C x D	E x F x G
V91407	VAG92061B
39.60 x 7.97 x 91.90	36.70 x 8.00 x 12.08
V91340	
33.30 x 7.95 x 91.20	
OE: 048 109 601A	
048 109 611A	
MAT.:	
45°	
H	

BT820 Fibre Composite	DT820 [14]		HBS024	JD327	HR615		NA5001
			M11x1.50x95mm (x12)	JD171			32.00x47.00x10.00mm FPM
				JC152			(x5)



BT820

[14] With shaft oil seal

[14] Mit Wellendichtring

633	82.50	Petrol	
NF	5 Cyl.	2309cc	100kW (136)PS
100	08/86→11/90	200	11/86→09/91
			TD301 1032

TB207 120x18 05/88→ TB602 113x19 →05/88	TBK048 05/88→				FOL92 (x10)

B x C x D	E x F x G
OE	
MAT.	
V91407 ■ 39.60 x 7.97 x 91.90	VAG92061B ■ ■ ■ 36.70 x 8.00 x 12.08
V91340 ■ 33.30 x 7.95 x 91.20	
048 109 601A MD	
048 109 611A MG	

BT820 Fibre Composite	DT820 [14]	HBS024 ⊕ M11x1.50x95mm (x12)	JC261 ■ JD327 ■ ■ ■ JD171 ■ ■ ■ JC152 ■ (x5)	JN438 (Elastomer) HL460 ■ (Cork) HM5277 ■ (Elastomer)	HR615 ■	NA5001 32.00x47.00x10.00mm FPM



BT820
[14] With shaft oil seal [14] Mit Wellendichtring

634



82.50

Petrol



NG	5 Cyl.	10:1	2309cc	98-100kW (133-136)PS	TD302	1032
80	10/87→01/96		90	04/87→09/91	CABRIOLET	05/91→07/94
COUPE	01/87→12/96					

TB318 142x19 →8BM033000	TBK285 8BM033001→				FOL92 (x10)
TB504 147x19 8BM033001→					

	OE				
B x C x D		MAT.	45°	H	E x F x G
V91407	048 109 601A		45°		VAG92061B
39.60 x 7.97 x 91.90		MD			36.70 x 8.00 x 12.08
V91340	048 109 611A		45°	H	
33.30 x 7.95 x 91.20		MG			

BT820 Fibre Composite	DT820 [14]	HBS024 M11x1.50x95mm (x12)	JD327 JD171 JC152 (x5)	JN438 (Elastomer)	HL460 (Cork)	HM5277 (Elastomer)	HR615	NA5001 32.00x47.00x10.00mm FPM		



BT820

[14] With shaft oil seal

[14] Mit Wellendichtring

635



82.50

Petrol



CBUA	5 Cyl.	9.5:1	2480cc	125kW (170)PS	TD22542
CCCA	5 Cyl.		2480cc	125kW (170)PS	TD22640
BEETLE	04/11→		JETTA	07/08→	

	OE				
B x C x D		MAT.	45°	H	E x F x G
V94692	06D 109 611L		45°	H	
28.00 x 6.00 x 101.80		MG cr			
V94704	06D 109 611K		45°	H	
28.00 x 6.00 x 101.80		MG			

636

82.50

Petrol



ABC	V6 Cyl.	2598cc	110kW (150)PS	TD231	1033
100	03/92→06/94	80	06/92→01/96	A4	01/95→09/01
A6	06/94→12/97	CABRIOLET	06/93→08/00	COUPE	08/92→12/96

TB373 239x25.4					FOL143 (x12)

	OE	MAT.				
B x C x D						E x F x G
V91407	048 109 601A		45°			VAG92061B
39.60 x 7.97 x 91.90 Eng.→8C-S-025820						36.70 x 8.00 x 12.08 Eng.→8C-S-025820
V94079	078 109 601B		45°	H		VAG96041B
39.40 x 7.00 x 92.10 Eng.8C-S-025821→						36.50 x 7.00 x 12.08 Eng.8C-S-025821→
V91340	048 109 611A		45°	H		
33.30 x 7.95 x 91.20 Eng.→8C-S-025820						
V94303	078 109 611C		45°	ss	H	
32.90 x 7.00 x 91.20 Eng.8C-S-025821→						

AY061 Fibre Composite, 2.000mm (x2)			HBS064 M11x1.50x137mm (x16)		JM5166 (ACM)	HR5068 (x2) HR662	NA5001 (x3) 32.00x47.00x10.00mm FPM

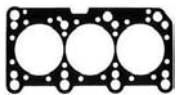

AY061

637



82.50

Petrol



ACZ	V6 Cyl.	2598cc	102kW (139)PS		TD239	1033
100	07/93→07/94	A4	01/96→07/97	A6	06/94→10/97	
CABRIOLET	05/95→08/00					

TB373					FOL143 (x12)
239x25.4					

B x C x D	E x F x G
OE	
MAT.	
V91407	VAG92061B
048 109 601A	36.70 x 8.00 x 12.08
39.60 x 7.97 x 91.90	
V91340	
048 109 611A	
33.30 x 7.95 x 91.20	
MD	
MG	

AY061 Fibre Composite, 2.000mm (x2)	DT660		HBS064		JM5166	HR569	NA5001 (x3)
			M11x1.50x137mm (x16)		(ACM)		32.00x47.00x10.00mm FPM

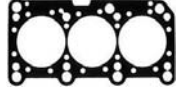

AY061

638



82.50

Petrol



AAH	V6 Cyl.	2771cc	128kW (174)PS		TD224	1034
100	12/90→06/94	80	09/91→01/96	A4	01/95→07/97	
A6	06/94→12/97	A8	03/94→03/96	CABRIOLET	11/92→08/00	
COUPE	08/91→12/96					

TB373					FOL143 (x12)
239x25.4					

B x C x D	E x F x G
OE	
MAT.	
V91407	VAG92061B
048 109 601A	36.70 x 8.00 x 12.08
39.60 x 7.97 x 91.90	
V91340	
048 109 611A	
33.30 x 7.95 x 91.20	
MD	
MG	

AY061 Fibre Composite, 2.000mm (x2)			HBS064		JM5166	HR5068	NA5001 (x3)
			M11x1.50x137mm (x16)		(ACM)	(x2)	32.00x47.00x10.00mm FPM

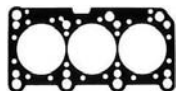

AY061

639		82.50	Petrol			
ACK	V6 Cyl.	10.6:1	2771cc	142kW (193)PS	TD4197	1035
ACK	V6 Cyl.	10.6:1	2771cc	142kW (193)PS	TD5560	1035
A4	10/96→09/01		A6	12/95→01/05	A8	04/96→09/02
PASSAT	08/96→11/00					

TB556 253x30	TBK353 with tensioner pulley damper TBK357 without tensioner pulley damper				FOL133 (x18) FOL141 (x12)

B x C x D	OE	MAT.	45°	Y	H	E x F x G
V94081 ■ 26.90 x 6.00 x 105.10	058 109 601C		45°	Y	H	VAG96073B ■ ■ ■ 36.00 x 6.02 x 11.06
V94083 ■ 29.90 x 6.00 x 103.90	058 109 611M		45°		H	

			HBS270 ⊗ M11x1.50x133mm (x16)		HM5224 ■	PA5041 (x30) 6.00x8.8/12.20x10.00 866N W (FPM)	NA5001 (x4) 32.00x47.00x10.00mm FPM

640		82.50	Petrol			
AEJ	V6 Cyl.		2771cc	120-128kW (163-174)PS	TD9541	1035
A6	06/94→12/97		A8	07/95→03/96		

TB373 239x25.4					FOL143 (x12)

B x C x D	OE	MAT.	45°		H	E x F x G
V91407 ■ 39.60 x 7.97 x 91.90	048 109 601A		45°			VAG92061B ■ ■ ■ 36.70 x 8.00 x 12.08
V91340 ■ 33.30 x 7.95 x 91.20	048 109 611A		45°		H	

AY061 Fibre Composite, 2.000mm (x2)	DY850 →Ch.4A-T029513		HBS064 ⊗ M11x1.50x137mm (x16)		JM5166 (x2) (ACM)	HR602 ■	NA5001 (x3) 32.00x47.00x10.00mm FPM

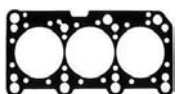

AY061

641



82.50

Petrol



AFC

V6 Cyl.

2771cc

120kW (163)PS

TD246

1035

A6

06/94→10/97

TB373 239x25.4				FOL92 (x12)	

B x C x D	OE	MAT.	45°	H	VAG92061B
V91407	048 109 601A	MD	45°		36.70 x 8.00 x 12.08
V91340	048 109 611A	MG			
39.60 x 7.97 x 91.90					
33.30 x 7.95 x 91.20					

AY061 Fibre Composite, 2.000mm (x2)			HBS064		JM5166 (ACM)	HR662	NA5001 32.00x47.00x10.00mm FPM
			M11x1.50x137mm (x16)				

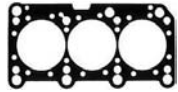

AY061

642		82.50	Petrol			
AGE	V6 Cyl.		2771cc	132kW (180)PS	TD15616	1036
AGE	V6 Cyl.		2771cc	132kW (180)PS	TD16251	1036
ALG	V6 Cyl.		2771cc	142kW (193)PS	TD16260	1035
ALG	V6 Cyl.		2771cc	142kW (193)PS	TD9516	1035
APR	V6 Cyl.	10.6:1	2771cc	142kW (193)PS	TD13931	1035
APR	V6 Cyl.	10.6:1	2771cc	142kW (193)PS	TD15808	1035
AQD	V6 Cyl.	10.6:1	2771cc	142kW (193)PS	TD13932	1035
AQD	V6 Cyl.	10.6:1	2771cc	142kW (193)PS	TD16259	1035
A4	10/96→09/01		A6	02/97→01/05	A8	04/96→09/02
PASSAT	08/96→11/00					

TB556 253x30	TBK353 with tensioner pulley damper TBK357 without tensioner pulley damper		KIT		FOL133 (x18) FOL141 (x12)

V94081 (x3) 26.90 x 6.00 x 105.10	058 109 601C	MB	45°	Y	H	VAG96073B (x3) 36.00 x 6.02 x 11.06
V94083 (x3) 29.90 x 6.00 x 103.90	058 109 611M	MG cr	45°		H	

			HBS270 (x16) M11x1.50x133mm (x16)		HM5224 (x3)	PA5041 (x30) 6.00x8.8/12.20x10.00 866N W (FPM)	NA5001 (x4) 32.00x47.00x10.00mm FPM

643		82.50	Petrol				
AHA	V6 Cyl.	10.3:1	2771cc	142kW (193)PS	TD26491		
A4	10/96→09/01		A6	02/97→01/05			
							NA5001 32.00x47.00x10.00mm FPM

644	82.50	Petrol			
AMX	V6 Cyl.	10.6:1	2771cc	142kW (193)PS	TD13930 1035
AMX	V6 Cyl.	10.6:1	2771cc	142kW (193)PS	TD15155 1035
AMX	V6 Cyl.	10.6:1	2771cc	142kW (193)PS	TD16367 1035
A4	10/96→09/01	A6	02/97→01/05	A8	04/96→09/02
PASSAT	11/00→05/05	SUPERB	12/01→03/08		

TB556 253x30	TBK353 with tensioner pulley damper TBK357 without tensioner pulley damper		KIT		FOL133 ■ (x18) FOL141 ■ (x12)

V94081 ■ 26.90 x 6.00 x 105.10 V94083 ■ 29.90 x 6.00 x 103.90	OE 058 109 601C 058 109 611M	MAT. MB MG cr	45° 45°	Y H	VAG96073B ■ ■ ■ 36.00 x 6.02 x 11.06

HBS270 ☒ M11x1.50x133mm (x16)	HM5224 ■	PA5041 (x30) 6.00x8.8/12.20x10.00 866N W (FPM)	NA5001 32.00x47.00x10.00mm FPM

645	82.50	Petrol			
ATQ	V6 Cyl.	2771cc	142kW (193)PS	TD16422 1036	
PASSAT	11/00→05/05				

TB556 253x30	TBK353 with tensioner pulley damper TBK357 without tensioner pulley damper		KIT		FOL133 ■ (x18) FOL141 ■ (x12)

V94081 ■ 26.90 x 6.00 x 105.10 V94083 ■ 29.90 x 6.00 x 103.90	OE 058 109 601C 058 109 611M	MAT. MB MG cr	45° 45°	Y H	VAG96073B ■ ■ ■ 36.00 x 6.02 x 11.06

HBS270 ☒ M11x1.50x133mm (x16)	HM5224 ■	PA5041 (x30) 6.00x8.8/12.20x10.00 866N W (FPM)	NA5001 32.00x47.00x10.00mm FPM

646	82.50	Petrol			
ATX	V6 Cyl.	2771cc	140kW (190)PS	TD15617	1036
ATX	V6 Cyl.	2771cc	140kW (190)PS	TD16252	1036
A4	03/99→09/00	A6	07/99→01/05	PASSAT	09/99→11/00

TB556 253x30	TBK353 with tensioner pulley damper TBK357 without tensioner pulley damper				FOL133 (x18) FOL141 (x12)

	OE	MAT.				
V94081 26.90 x 6.00 x 105.10	058 109 601C		45°	Y	H	VAG96073B 36.00 x 6.02 x 11.06
V94083 29.90 x 6.00 x 103.90	058 109 611M		45°		H	

			HBS270 M11x1.50x133mm (x16)		HM5224	PA5041 (x30) 6.00x8.8/12.20x10.00 866N W (FPM)	NA5001 32.00x47.00x10.00mm FPM

647	82.50	Petrol				
BBG	V6 Cyl.	10.6:1	2771cc	140kW (190)PS	TD17913	
BBG	V6 Cyl.	10.6:1	2771cc	140kW (190)PS	TD18754	1036
BBG	V6 Cyl.	10.6:1	2771cc	140kW (190)PS	TD19142	1036
A6	07/99→01/05	PASSAT	09/99→11/00	SUPERB	06/02→03/08	

TB556 253x30	TBK353 with tensioner pulley damper TBK357 without tensioner pulley damper				

	OE	MAT.				
V94081 26.90 x 6.00 x 105.10	058 109 601C		45°	Y	H	VAG96073B 36.00 x 6.02 x 11.06
V94083 29.90 x 6.00 x 103.90	058 109 611M		45°		H	

			HBS270 M11x1.50x133mm (x16)		HM5224	PA5041 (x30) 6.00x8.8/12.20x10.00 866N W (FPM)	NA5001 32.00x47.00x10.00mm FPM

648



82.50

Petrol



ASN V6 Cyl. 10.5:1 2976cc 162kW (220)PS TD15346 1036

A4 11/00→12/05 A6 08/01→01/05 A8 07/03→05/05

TB759 83x30					FOL133 (x18) FOL141 (x12)

 B x C x D	OE	 MAT.	 45°	 Y	 H	 E x F x G
V94081 26.90 x 6.00 x 105.10 V94083 29.90 x 6.00 x 103.90	058 109 601C 058 109 611M	 MB MG cr	45°	Y H	H H	VAG96073B 36.00 x 6.02 x 11.06

649



82.50

Petrol



AVK V6 Cyl. 10.5:1 2976cc 162kW (220)PS TD17863

A4 11/00→12/04

TB754 281x30					

 B x C x D	OE	 MAT.	 45°	 Y	 H	 E x F x G
V94081 26.90 x 6.00 x 105.10 V94083 29.90 x 6.00 x 103.90	058 109 601C 058 109 611M	 MB MG cr	45°	Y H	H H	VAG96073B 36.00 x 6.02 x 11.06

650



82.50

Petrol









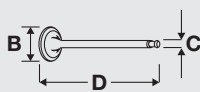
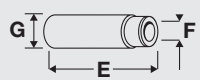

BBJ V6 Cyl. 10.5:1 2976cc 162kW (220)PS TD16516

A4 04/01→07/06 A6 06/01→05/06 A8 07/03→05/06



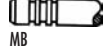

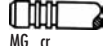

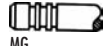

TB754 281x30					

 B x C x D	OE	 MAT.	 45°	 Y	 H	 E x F x G
V94081 26.90 x 6.00 x 105.10 V94083 29.90 x 6.00 x 103.90	058 109 601C 058 109 611M	 MB MG cr	45°	Y H	H H	VAG96073B 36.00 x 6.02 x 11.06

651	 82.50	Petrol					
CCAA	V6 Cyl.	2976cc	220kW (299)PS	Supercharged	TD22664		
A6	10/08→08/11						

						
B x C x D	OE	MAT.				E x F x G
V94691 	06D 109 601K		45°	Y	H	
33.85 x 6.00 x 104.00		MB				
V94692 	06D 109 611L		45°		H	
28.00 x 6.00 x 101.80		MG cr				
V94704 	06D 109 611K		45°		H	
28.00 x 6.00 x 101.80		MG				







652	 83.00	Petrol					
L	4 Cyl.	1493cc	29-32kW (40-44)PS		TD4127		

							
	CV480 ▲○ [15]	FV500 ▲○ [15]		JB373	JM986		

[15] Without shaft seal [15] Ohne Wellendichtring

653	 83.00	Petrol					
H	Boxer4 Cyl.	7.5:1	1493cc	32kW (44)PS	TD4103	1037	
K	Boxer4 Cyl.	7.8:1	1493cc	33kW (45)PS	TD4122		

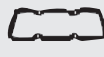
1500,1600	04/61→07/73	181	09/69→07/70	KAEFER	01/66→11/73		
KARMANN GHIA	01/66→12/69						

							
	CV480 ▲○ [15]	FV500 ▲○ [15]		JB373	JM986		

[15] Without shaft seal [15] Ohne Wellendichtring

654

83.00

Diesel



BKN	6 Cyl.		2967cc	150kW (204)PS		TD18027	1038
BKS	V6 Cyl.	17:1	2967cc	165kW (224)PS	Turbo Intercooled	TD18031	1041
BUN	V6 Cyl.		2967cc	155kW (211)PS	Turbo Intercooled	TD19881	1041
BUN	V6 Cyl.		2967cc	155kW (211)PS	Turbo Intercooled	TD21182	1041

A4	11/04→03/09	Q7	03/06→05/10	TOUAREG	11/04→05/10
-----------	-------------	-----------	-------------	----------------	-------------

<p>B x C x D</p>	OE	<p>MAT.</p>	<p>45°</p>	<p>ss</p>	<p>E x F x G</p>
V98010 ■	059 109 601G		45°		
28.80 x 6.00 x 99.50		MB			
V98011 ■	059 109 611M		45°	ss	
26.80 x 6.00 x 99.50		MG			



AG8880 MLS, 1.100mm, 1 Hole [54]	CG8880 ▲	HBS361 ⊕	JD5872 ■	JM7046 [54]	PA5041 (x24)	NA5001
AG8900 MLS, 1.100mm, 1 Hole [61]		M12x1.50x159mm (x16)	(ACM)	(ACM)	6.00x8.8/12.20x10.00	32.00x47.00x10.00mm FPM
AG8860 MLS, 1.150mm, 2 Holes [54]				JM7047 [61]	866N W (FPM)	
AG8870 MLS, 1.150mm, 2 Holes [61]				(ACM)		
AG8890 MLS, 1.200mm, 3 Holes [54]						
AG8910 MLS, 1.200mm, 3 Holes [61]						

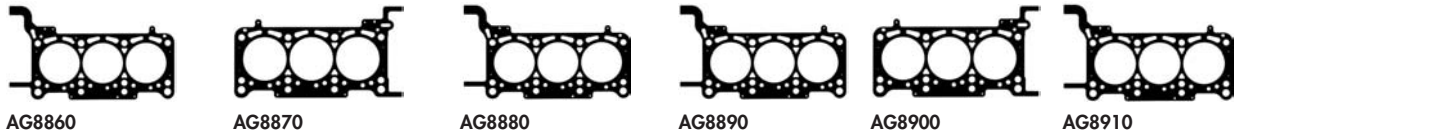

[54] To cylinder 1 - 3 [54] zum Zylinder 1 - 3
 [61] To cylinder 4 - 6 [61] zum Zylinder 4 - 6

655









83.00

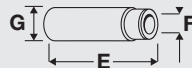



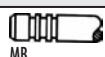

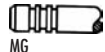

Diesel



CAMA	V6 Cyl.		2698cc	140kW (190)PS	Turbo Intercooled	TD20006	1039
CAMB	V6 Cyl.		2698cc	120kW (163)PS	Turbo Intercooled	TD20599	1039
CANB	V6 Cyl.	16.8:1	2698cc	120kW (163)PS	Turbo Intercooled	TD22658	
CANC	V6 Cyl.	16.8:1	2698cc	140kW (190)PS	Turbo Intercooled	TD22659	
CAND	V6 Cyl.	16.8:1	2698cc	120kW (163)PS	Turbo Intercooled	TD23099	1040
CAP	V6 Cyl.		2967cc	176kW (239)PS	Turbo Intercooled	TD20007	1039
CARA	V6 Cyl.		2967cc	171kW (233)PS	Turbo	TD22390	
CASA	V6 Cyl.		2967cc	176kW (239)PS	Turbo Intercooled	TD20709	1039
CASA	V6 Cyl.		2967cc	176kW (239)PS	Turbo Intercooled	TD20865	1039
CASB	V6 Cyl.	16.8:1	2967cc	155kW (211)PS	Turbo Intercooled	TD21315	1041
CASB	V6 Cyl.	16.8:1	2967cc	155kW (211)PS	Turbo Intercooled	TD22636	1041
CASC	V6 Cyl.		2967cc	176kW (239)PS	Turbo Intercooled	TD22560	1039
CASD	V6 Cyl.		2967cc	150kW (204)PS	Turbo Intercooled	TD24893	1042
CATA	V6 Cyl.	16.8:1	2967cc	165kW (224)PS	Turbo Intercooled	TD22637	1041
CATA	V6 Cyl.	16.8:1	2967cc	165kW (224)PS	Turbo Intercooled	TD22660	1041
CCMA	V6 Cyl.		2967cc	176kW (239)PS	Turbo Intercooled	TD21316	1042
CCWA	V6 Cyl.		2967cc	176kW (239)PS	Turbo Intercooled	TD20600	1039
CCWB	V6 Cyl.		2967cc	155kW (211)PS	Turbo Intercooled	TD21029	1039
CDYA	V6 Cyl.		2967cc	176kW (239)PS	Turbo Intercooled	TD21177	1039
CDYB	V6 Cyl.		2967cc	155kW (211)PS	Turbo Intercooled	TD22955	1041
CDYC	V6 Cyl.		2967cc	176kW (239)PS	Turbo Intercooled	TD22973	1039
CEXA	V6 Cyl.		2967cc	176kW (239)PS	Turbo	TD22389	1039
CGKA	V6 Cyl.		2698cc	140kW (190)PS	Turbo Intercooled	TD21065	1039
CGKB	V6 Cyl.		2698cc	120kW (163)PS	Turbo Intercooled	TD21064	1039

A4	11/07→	A4 Allroad	04/09→	A5	06/07→
A6	05/04→08/11	A6 Allroad	05/06→08/11	PHAETON	06/07→
Q5	11/08→	Q7	03/06→	TOUAREG	11/04→

					
B x C x D	OE	MAT.			E x F x G
V98010 	059 109 601G		45°		
28.80 x 6.00 x 99.50		MB			
V98011 	059 109 611M		45°	ss	
26.80 x 6.00 x 99.50		MG			

							
				JD5872 	JM7046 [54]	PA5041	NA5001
				(ACM)	(ACM)	6.00x8.8/12.20x10.00	32.00x47.00x10.00mm FPM
					JM7047 [61]	866N W (FPM)	
					(ACM)		







[54] To cylinder 1 - 3
[61] To cylinder 4 - 6



[54] zum Zylinder 1 - 3
[61] zum Zylinder 4 - 6

656
 **83.00**
Diesel

ASB	V6 Cyl.		2967cc	171kW (233)PS		TD17336	1038
BMK	V6 Cyl.	17:1	2967cc	165kW (224)PS	Turbo Intercooled	TD17845	1038
BMK	V6 Cyl.	17:1	2967cc	165kW (224)PS	Turbo Intercooled	TD18023	1038
BNG	V6 Cyl.		2967cc	155kW (211)PS	Turbo Intercooled	TD17337	1041

A4	01/06→03/09		A6	05/04→08/11	A6 Allroad	05/06→08/11
A8	08/03→07/10		PHAETON	09/04→		

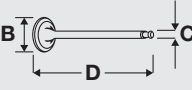
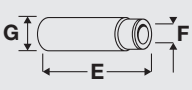
 	 	 
TB760		
83x24		
Driven unit: injection pump		

 <p>B x C x D</p>	 <p>E x F x G</p>
<p>V98010 </p> <p>28.80 x 6.00 x 99.50</p>	<p>V98011 </p> <p>26.80 x 6.00 x 99.50</p>

OE	MAT.	45°	45° ss
059 109 601G			
059 109 611M			



AG8880 MLS, 1.100mm, 1 Hole [54] AG8900 MLS, 1.100mm, 1 Hole [61] AG8860 MLS, 1.150mm, 2 Holes [54] AG8870 MLS, 1.150mm, 2 Holes [61] AG8890 MLS, 1.200mm, 3 Holes [54] AG8910 MLS, 1.200mm, 3 Holes [61]	CG8880 ▲	HBS361 ☉ M12x1.50x159mm (x16)	JD5872 ■ (ACM)	JM7046 [54] (ACM) JM7047 [61] (ACM)	PA5041 (x24) 6.00x8.8/12.20x10.00 866N W (FPM)	NA5001 32.00x47.00x10.00mm FPM
--	-----------------	---	--------------------------	--	---	--

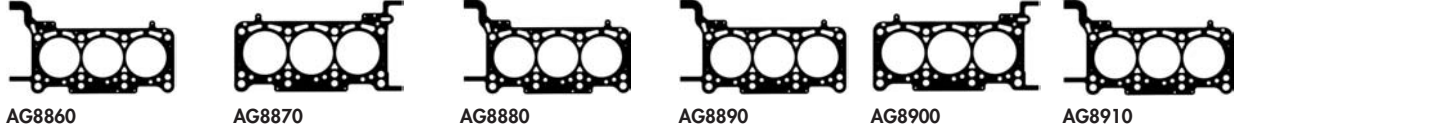

[54] To cylinder 1 - 3 [54] zum Zylinder 1 - 3
 [61] To cylinder 4 - 6 [61] zum Zylinder 4 - 6



657
 **83.00**
Diesel

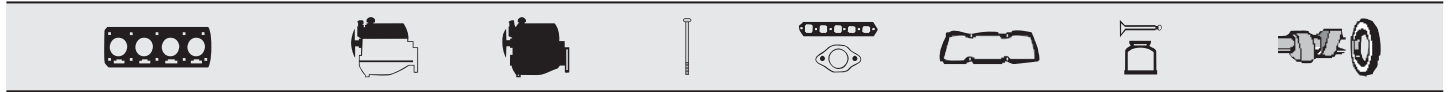





BSP	6 Cyl.	17:1	2967cc	165kW (224)PS		TD20533
------------	--------	------	--------	---------------	--	----------------



















CG8880 ▲	JD5872 ■ (ACM)	JM7046 [54] (ACM) JM7047 [61] (ACM)	PA5041 (x24) 6.00x8.8/12.20x10.00 866N W (FPM)
-----------------	--------------------------	--	---









[54] To cylinder 1 - 3 [54] zum Zylinder 1 - 3
 [61] To cylinder 4 - 6 [61] zum Zylinder 4 - 6



658	 83.00	Diesel	
BUG	V6 Cyl.	2967cc	171kW (233)PS
			Turbo Intercooled
			TD18996 1038
Q7	03/06→05/08		

					
TB760					
83x24					
Driven unit: injection pump					







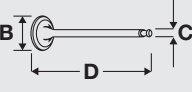

							
AG8880 MLS, 1.100mm, 1 Hole [54] AG8900 MLS, 1.100mm, 1 Hole [61] AG8860 MLS, 1.150mm, 2 Holes [54] AG8870 MLS, 1.150mm, 2 Holes [61] AG8890 MLS, 1.200mm, 3 Holes [54] AG8910 MLS, 1.200mm, 3 Holes [61]	CG8880 ▲		HBS361 ⊕ M12x1.50x159mm (x16)	JD5872 ■ (ACM)	JM7046 [54] (ACM) JM7047 [61] (ACM)	PA5041 (x24) 6.00x8.8/12.20x10.00 866N W (FPM)	NA5001 32.00x47.00x10.00mm FPM
							
AG8860	AG8870	AG8880	AG8890	AG8900	AG8910		
[54] To cylinder 1 - 3 [61] To cylinder 4 - 6	[54] zum Zylinder 1 - 3 [61] zum Zylinder 4 - 6						

659	 83.00	Diesel	
CEZA	6 Cyl.	2967cc	195kW (265)PS
			TD22561

							
				JD5872 ■ (ACM)	JM7046 [54] (ACM) JM7047 [61] (ACM)	PA5041 (x24) 6.00x8.8/12.20x10.00 866N W (FPM)	
[54] To cylinder 1 - 3 [61] To cylinder 4 - 6	[54] zum Zylinder 1 - 3 [61] zum Zylinder 4 - 6						

660	 83.60	Petrol	
BGP	5 Cyl.	2480cc	110kW (150)PS
CBTA	5 Cyl.	2480cc	125kW (170)PS

BEETLE	04/11→	JETTA	01/06→
---------------	--------	--------------	--------

					
B x C x D	OE	MAT.			E x F x G
V94692 	06D 109 611L		45°	H	
28.00 x 6.00 x 101.80		MG cr			
V94704 	06D 109 611K		45°	H	
28.00 x 6.00 x 101.80		MG			

VW GROUP

661



84.00

Petrol



AD Boxer4 Cyl. 1584cc 35-37kW (48-50)PS TD4016 1043

KAEFER 01/70→12/79 KARMANN GHIA 01/70→07/74 TRANSPORTER 08/68→07/79

 B x C x D		OE	MAT.	 45°	 MB	 MG cr	 H	 E x F x G
V33815 ■ 35.61 x 7.95 x 111.96		311 109 601	 MB	45°			H	
V33817 ■ 32.10 x 7.92 x 111.99		311 109 612 A	 MG cr	45°	ss			
V94411 ■ 32.00 x 9.00 x 111.80		043 109 612	 MG cr	45°	ss		H	

662



84.00

Petrol



CT Boxer4 Cyl. 7.5:1 1584cc 37kW (50)PS TD4049

TRANSPORTER 05/79→12/82

 B x C x D		OE	MAT.	 45°	 MB	 MG cr	 H	 E x F x G
V33815 ■ 35.61 x 7.95 x 111.96		311 109 601	 MB	45°			H	
V94411 ■ 32.00 x 9.00 x 111.80		043 109 612	 MG cr	45°	ss		H	

663



84.00

Petrol



CBR 6 Cyl. 3189cc 184kW (250)PS TD20023 1044









 AG9610	 CG9610	 JD5874 ■ (FPM)	 JM7045 (Elastomer)	 PA5041 (x24) 6.00x8.8/12.20x10.00 866N W (FPM)

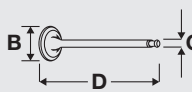







664

84.00
Petrol

AYT	V6 Cyl.		3189cc	177kW (240)PS	TD16481	1044
AZZ	V6 Cyl.	11:1	3189cc	162kW (220)PS	TD17041	1044
BAA	V6 Cyl.	11.3:1	3189cc	162kW (220)PS	TD20531	1044
BDB	V6 Cyl.		3189cc	184kW (250)PS	TD17068	1044
BDL	V6 Cyl.	11.3:1	3189cc	170kW (231)PS	TD16870	1044
BFH	V6 Cyl.		3189cc	177kW (240)PS	TD16526	1044
BHE	V6 Cyl.	11.3:1	3189cc	184kW (250)PS	TD17029	1044
BKJ	V6 Cyl.	11:1	3189cc	162kW (220)PS	TD17042	1044
BKK	6 Cyl.		3189cc	173kW (235)PS	TD17186	1044
BKL	V6 Cyl.	11.3:1	3189cc	177kW (240)PS	TD18024	1044
BMJ	V6 Cyl.		3189cc	184kW (250)PS	TD17407	1044
BML	V6 Cyl.	11.3:1	3189cc	177kW (240)PS	TD20523	1046
BMV	V6 Cyl.	11.3:1	3189cc	162kW (220)PS	TD20525	1044
BMX	V6 Cyl.		3189cc	177kW (240)PS	TD19256	1044
BPF	V6 Cyl.	11.3:1	3189cc	184kW (250)PS	TD20524	1044
BPF	V6 Cyl.	11.3:1	3189cc	184kW (250)PS	TD20705	1044
BRJ	V6 Cyl.	10.8:1	3189cc	162kW (220)PS	TD20526	1045
BRK	V6 Cyl.	11.3:1	3189cc	177kW (240)PS	TD18025	1044
BUB	V6 Cyl.		3189cc	184kW (250)PS	TD18472	1044
BUB	V6 Cyl.		3189cc	184kW (250)PS	TD19200	1044
CBRA	V6 Cyl.	11.3:1	3189cc	184kW (250)PS	TD22178	1044

A3	07/03→05/09	EOS	06/06→05/09	GOLF	09/02→11/08
MULTIVAN	02/04→11/09	PHAETON	04/02→	TOUAREG	10/02→11/06
TRANSPORTER	04/03→11/09	TT	07/03→06/10		

 B x C x D	OE	 MAT.	 45°	 Y	 H	 E x F x G
V95085 ■ 33.20 x 5.98 x 102.40	022 109 601G	 MB	45°	Y	H	
V95086 ■ 30.20 x 5.97 x 102.20	03H 109 611D	 MG cr	45°	ss	H	

							
AG9610 MLS	CG9610			JD5874 ■ (FPM)	JM7045 (Elastomer)	PA5041 (x24) 6.00x8.8/12.20x10.00 866N W (FPM)	

VW GROUP

665



84.00

Petrol



AXJ V6 Cyl. 3189cc 165kW (224)PS TD15471 1044

NEW BEETLE 04/00→05/01

					FOL154 (x24)

 B x C x D	OE	MAT.				 E x F x G
V94406 ■ 31.00 x 6.00 x 102.10	022 109 601E	 MB	45°	Y	H	
V94642 ■ 31.00 x 6.00 x 136.00	022 109 601F	 MB	45°		H	
V94407 ■ 27.00 x 6.00 x 136.40	022 109 611C	 MG	45°	ss	H	
V94641 ■ 27.00 x 6.00 x 102.50	022 109 611B	 MG	45°	ss	H	

AG9610 MLS	CG9610			JD5874 ■ (FPM)		PA5041 (x24) 6.00x8.8/12.20x10.00 866N W (FPM)	

666



84.00

Petrol



CFLA V6 Cyl. 3189cc 173kW (235)PS TD20920 1044

MULTIVAN 02/04→11/09

TRANSPORTER

11/03→11/09

AG9610 MLS	CG9610			JD5874 ■ (FPM)	JM7045 (Elastomer)	PA5041 (x24) 6.00x8.8/12.20x10.00 866N W (FPM)	

667



84.00

Petrol



BHT V12 Cyl. 5998cc 331kW (450)PS TD17284	BJN W12 Cyl. 5998cc 316kW (430)PS TD20528	BRN W12 Cyl. 5998cc 331kW (450)PS TD20279	BSB V12 Cyl. 5998cc 331kW (450)PS TD19709	BTE V12 Cyl. 5998cc 331kW (450)PS TD18242	BTT W12 Cyl. 5998cc 331kW (450)PS TD20280
---	---	---	---	---	---











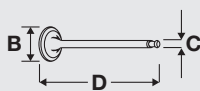

A8 12/03→07/10 PHAETON 05/05→ TOUAREG 08/04→05/10

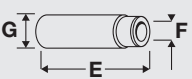
 B x C x D	OE	MAT.				 E x F x G
V94406 ■ 31.00 x 6.00 x 102.10	022 109 601E	 MB	45°	Y	H	
V94642 ■ 31.00 x 6.00 x 136.00	022 109 601F	 MB	45°		H	
V94407 ■ 27.00 x 6.00 x 136.40	022 109 611C	 MG	45°	ss	H	
V94641 ■ 27.00 x 6.00 x 102.50	022 109 611B	 MG	45°	ss	H	

668 84.00 Petrol









BAN W12 Cyl. 5998cc 309kW (420)PS TD16482

PHAETON 04/02→

 B x C x D		OE	MAT.				 E x F x G	
V94406 	31.00 x 6.00 x 102.10	022 109 601E	 MB	45°	Y	H		
V94642 	31.00 x 6.00 x 136.00	022 109 601F	 MB	45°		H		
V94407 	27.00 x 6.00 x 136.40	022 109 611C	 MG	45°	ss	H		
V94641 	27.00 x 6.00 x 102.50	022 109 611B	 MG	45°	ss	H		









669 84.50 Petrol

AYS 8 Cyl. 4172cc 265kW (360)PS TD17163

								PA5041 (x24) 6.00x8.8/12.20x10.00 866N W (FPM)
---	---	---	---	---	---	---	---	---

670 84.50 Petrol









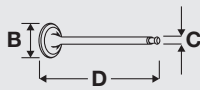

BCS 8 Cyl. 4172cc 265kW (360)PS TD17165

								PA5041 6.00x8.8/12.20x10.00 866N W (FPM)
---	---	---	---	---	---	---	---	---

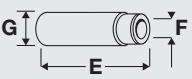
671 84.50 Petrol

BAR	V8 Cyl.	4163cc	257kW (350)PS	TD18995
BAR	V8 Cyl.	4163cc	257kW (350)PS	TD20207
BVJ	V8 Cyl.	4163cc	257kW (350)PS	TD18927
BXA	V10 Cyl.	5204cc	320kW (435)PS	TD18928
CAJA	V6 Cyl.	2995cc	213kW (290)PS	Turbo TD21178
CAKA	V6 Cyl.	2995cc	245kW (333)PS	Supercharged TD21117
CCBA	V6 Cyl.	2995cc	245kW (333)PS	Turbo Intercooled TD23862
CCDA	V6 Cyl.	2773cc	140kW (190)PS	TD21174 1047
CCEA	V6 Cyl.	2773cc	162kW (220)PS	TD21175 1047

A4	11/08→	A5	06/09→	A6	03/06→08/11
A6 Allroad	05/06→08/11	A8	06/06→07/10	Q7	03/06→05/10
TOUAREG	06/06→05/10				

 B x C x D		OE	MAT.				 E x F x G	
V94691 	33.85 x 6.00 x 104.00	06D 109 601K	 MB	45°	Y	H		
V94692 	28.00 x 6.00 x 101.80	06D 109 611L	 MG cr	45°		H		
V94704 	28.00 x 6.00 x 101.80	06D 109 611K	 MG	45°		H		

VW GROUP

672	84.50	Petrol			
AUK	V6 Cyl.	3123cc	188kW (256)PS	TD17376	1048
BKH	V6 Cyl.	3123cc	188kW (255)PS	TD19706	
A4	01/05→03/09	A6	05/04→05/09	A6 Allroad	05/06→10/08

					FOL154 (x24)



<table border="1"> <thead> <tr> <th>B x C x D</th> <th>OE</th> <th>MAT.</th> <th>45°</th> <th>Y</th> <th>H</th> </tr> </thead> <tbody> <tr> <td>V94691 ■ 33.85 x 6.00 x 104.00</td> <td>06D 109 601K</td> <td> MB</td> <td></td> <td></td> <td></td> </tr> <tr> <td>V94692 ■ 28.00 x 6.00 x 101.80</td> <td>06D 109 611L</td> <td> MG cr</td> <td></td> <td></td> <td></td> </tr> <tr> <td>V94704 ■ 28.00 x 6.00 x 101.80</td> <td>06D 109 611K</td> <td> MG</td> <td></td> <td></td> <td></td> </tr> </tbody> </table>	B x C x D	OE	MAT.	45°	Y	H	V94691 ■ 33.85 x 6.00 x 104.00	06D 109 601K	 MB				V94692 ■ 28.00 x 6.00 x 101.80	06D 109 611L	 MG cr				V94704 ■ 28.00 x 6.00 x 101.80	06D 109 611K	 MG				<table border="1"> <thead> <tr> <th>E x F x G</th> </tr> </thead> <tbody> <tr> <td></td> </tr> </tbody> </table>	E x F x G	
B x C x D	OE	MAT.	45°	Y	H																						
V94691 ■ 33.85 x 6.00 x 104.00	06D 109 601K	 MB																									
V94692 ■ 28.00 x 6.00 x 101.80	06D 109 611L	 MG cr																									
V94704 ■ 28.00 x 6.00 x 101.80	06D 109 611K	 MG																									
E x F x G																											







673	84.50	Petrol			
AEM	V8 Cyl.	4172cc	180kW (245)PS	TD4200	
AEW	V8 Cyl.	3697cc	169kW (230)PS	TD4201	1049
AHC	V8 Cyl.	4172cc	250kW (340)PS	TD4203	
A8	03/94→06/99				









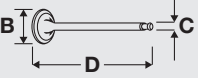

TB604 299x30					FOL141 (x32)

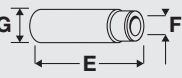

674	84.50	Petrol			
BYH	V8 Cyl.	4163cc	309kW (420)PS	TD19876	
R8	04/07→09/10				





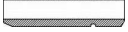

<table border="1"> <thead> <tr> <th>B x C x D</th> <th>OE</th> <th>MAT.</th> <th>45°</th> <th>H</th> </tr> </thead> <tbody> <tr> <td>V94692 ■ 28.00 x 6.00 x 101.80</td> <td>06D 109 611L</td> <td> MG cr</td> <td></td> <td></td> </tr> <tr> <td>V94704 ■ 28.00 x 6.00 x 101.80</td> <td>06D 109 611K</td> <td> MG</td> <td></td> <td></td> </tr> </tbody> </table>	B x C x D	OE	MAT.	45°	H	V94692 ■ 28.00 x 6.00 x 101.80	06D 109 611L	 MG cr			V94704 ■ 28.00 x 6.00 x 101.80	06D 109 611K	 MG			<table border="1"> <thead> <tr> <th>E x F x G</th> </tr> </thead> <tbody> <tr> <td></td> </tr> </tbody> </table>	E x F x G	
B x C x D	OE	MAT.	45°	H														
V94692 ■ 28.00 x 6.00 x 101.80	06D 109 611L	 MG cr																
V94704 ■ 28.00 x 6.00 x 101.80	06D 109 611K	 MG																
E x F x G																		









675	 84.50	Petrol	
ABH	V8 Cyl.	4172cc	206kW (280)PS
100	10/92→06/94	V8	10/91→02/94
			TD4195

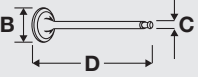

					
TB604 299x30					FOL141 (x32)

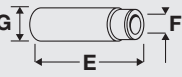





	OE		MAT.				
V91416  32.10 x 6.97 x 95.50	027 109 601C		MB	45°		H	VAG96157B  38.00 x 7.00 x 12.00
V91372  28.10 x 6.95 x 98.20	027 109 611D		MG cr	45°		H	







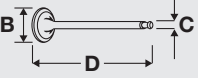

676	 84.50	Petrol	
ABZ	V8 Cyl.	4172cc	220kW (299)PS
A8	03/94→11/98		
			TD4196

					
TB556 253x30 11/98→					FOL141 (x32)
TB604 299x30 →10/98					

	OE		MAT.				
V94110  32.00 x 7.00 x 95.50	051 109 601B		MB	45°	Y	H	
V94111  27.00 x 7.00 x 97.95	051 109 611B		MG	45°		H	

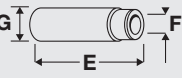
677	 84.50	Petrol	
AEC	V8 Cyl.	4172cc	213kW (290)PS
100	03/94→06/94	A6	06/94→12/97
			TD244

					
TB604 299x30					FOL141 (x32)

	OE		MAT.				
V94110  32.00 x 7.00 x 95.50	051 109 601B		MB	45°	Y	H	
V94111  27.00 x 7.00 x 97.95	051 109 611B		MG	45°		H	

678

84.50
Petrol

AKG

V8 Cyl.

4172cc

220kW (299)PS

TD17152
A8

03/94→11/98

TB604 299x30					

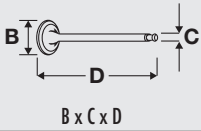

OE

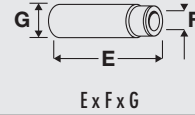
V94110 ■
32.00 x 7.00 x 95.50

051 109 601B

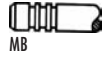

45°

Y

H

V94111 ■
27.00 x 7.00 x 97.95

051 109 611B

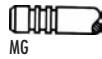

45°

H

679

84.50
Petrol

BUJ

V10 Cyl.

5204cc

386kW (525)PS

TD23311
R8

04/09→

V94692 ■ 28.00 x 6.00 x 101.80	06D 109 611L		45°		H
V94704 ■ 28.00 x 6.00 x 101.80	06D 109 611K		45°		H

V94692 ■
28.00 x 6.00 x 101.80

06D 109 611L

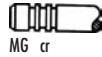

45°

V94704 ■
28.00 x 6.00 x 101.80

06D 109 611K

45°

680

85.50

Petrol

AE

4 Cyl.

7.5:1

1584cc

35-37kW (48-50)PS

TD5133

1054

KAEFER 08/70→07/74

TRANSPORTER

08/70→04/79

V33815 ■ 35.61 x 7.95 x 111.96	311 109 601		45°		H
V94411 ■ 32.00 x 9.00 x 111.80	043 109 612		45°	ss	H

V33815 ■
35.61 x 7.95 x 111.96

311 109 601

45°

V94411 ■
32.00 x 9.00 x 111.80

043 109 612

45°

ss

H

681

85.50

Petrol

AS

4 Cyl.

7.5:1

1584cc

37kW (50)PS

TD4030

1054

KAEFER 08/72→12/79

TRANSPORTER

08/68→07/79

V33815 ■ 35.61 x 7.95 x 111.96	311 109 601		45°		H
V94411 ■ 32.00 x 9.00 x 111.80	043 109 612		45°	ss	H

V33815 ■
35.61 x 7.95 x 111.96

311 109 601

45°

V94411 ■
32.00 x 9.00 x 111.80











043 109 612



45°









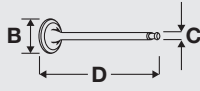

ss



H





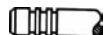



432

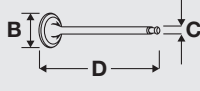



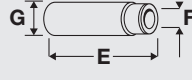



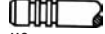

682	 85.50	Petrol				
CZ	4 Cyl.	7.5:1	1584cc	34kW (46)PS	TD4053	1055
       						
				JB373 (x4)	JM986 (x2)	

683	 85.50	Petrol			
CAL	V6 Cyl.		3197cc	195kW (265)PS	TD20005
A4	11/07→	A5	06/07→	A6	05/09→03/11



 B x C x D	OE	MAT.				 E x F x G
V94691  33.85 x 6.00 x 104.00	06D 109 601K	 MB	45°	Y	H	
V94692  28.00 x 6.00 x 101.80	06D 109 611L	 MG cr	45°		H	
V94704  28.00 x 6.00 x 101.80	06D 109 611K	 MG	45°		H	







684	 86.00	Petrol			
AXZ	V6 Cyl.	12:1	3168cc	184kW (250)PS	TD18187
PASSAT	11/05→11/10				











 B x C x D	OE	MAT.				 E x F x G
V95085  33.20 x 5.98 x 102.40	022 109 601G	 MB	45°	Y	H	
V95086  30.20 x 5.97 x 102.20	03H 109 611D	 MG cr	45°	ss	H	

685	 90.00	Petrol			
CE	4 Cyl.		1679cc	46kW (62)PS	TD4041
       					
				JN013	

VW GROUP



686	 86.50	Petrol				
CH	4 Cyl.	8.2/8.3:1	1984cc	55kW (75)PS	TD4044	1058
LT 28-35	04/75→09/83	LT 40-55	04/75→09/83			







					
TB108	TBK016				
121x18					











							
BM540 Fibre Composite	DM541		HBS018 		HL461 	PA096 (x8) 12.30/14.49	NA5001 (x2) 32.00x47.00x10.00mm FPM



BM540



687	 86.50	Petrol			
WA	4 Cyl.	9.3:1	1984cc	85kW (115)PS	TD329
100	06/76→07/80				









					
TB108	TBK016				
121x18					

							
BM540 Fibre Composite				JE689 	HL461 	PA096 (x8) 12.30/14.49	NA5001 (x2) 32.00x47.00x10.00mm FPM





BM540



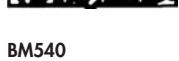



688	 86.50	Petrol			
WF	4 Cyl.		1984cc	77kW (105)PS	TD334

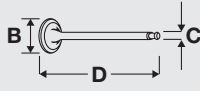

							
BM540 Fibre Composite				JB902 (x4) JE689	HL461 	PA096 (x8) 12.30/14.49	NA5001 32.00x47.00x10.00mm FPM





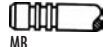
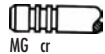



BM540

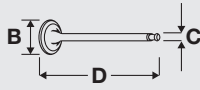



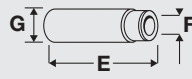
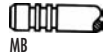



689	 89.00	Petrol			
BHK	V6 Cyl.	12:1	3597cc	206kW (280)PS	TD18998
BHK	V6 Cyl.	12:1	3597cc	206kW (280)PS	TD19880
BLV	V6 Cyl.		3597cc	206kW (280)PS	TD19259
BWS	V6 Cyl.	11.4:1	3597cc	220kW (299)PS	TD19820
CC	11/11→	PASSAT	04/07→	PASSAT CC	06/08→05/10
Q7	08/06→05/10	TOUAREG	10/05→05/10		

						
B x C x D	OE	MAT.				E x F x G
V95085 ■	022 109 601G		45°	Y	H	
33.20 x 5.98 x 102.40						
V95086 ■	03H 109 611D		45°	ss	H	
30.20 x 5.97 x 102.20						

690	 90.00	Petrol			
CA	Boxer4 Cyl.	7.3:1	1679cc	49kW (67)PS	TD4040
CB	Boxer4 Cyl.	7.3:1	1679cc	49kW (67)PS	TD5149
TRANSPORTER	08/71→12/73				



						
B x C x D	OE	MAT.				E x F x G
V94546 ■	021 109 601		30°		H	VAG92220B ■
39.20 x 8.00 x 117.05						66.50 x 8.98 x 13.06



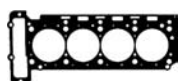



691	 90.90	Petrol			
AGL	4 Cyl.		2295cc	105kW (143)PS	TD9296
LT 28-35	05/96→07/06	LT 28-46	05/96→07/06		

							
BZ900 Fibre Composite	DZ160 ○		HBS150 ⊕ M12x1.75x102mm (x10)	JD160 ■			

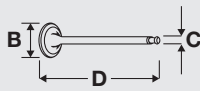

BZ900

692	 93.00	Petrol			
AP	4 Cyl.		1795cc	50-63kW (68-85)PS	TD4991 1059
TRANSPORTER	11/73→07/75				

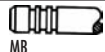
						
B x C x D	OE	MAT.				E x F x G
V94546 ■	021 109 601		30°		H	
39.20 x 8.00 x 117.05						

VW GROUP

693	94.00	Petrol			
DF	4 Cyl.	8.4:1	1915cc	44kW (60)PS	TD4058 1062
TRANSPORTER 08/82→07/92					

	.KIT		KIT				FOL170 (x8)
	DM690 ○	GM690 ○		JD237 ■ (x2) JD236 ■ (x4)	JM986 (x2)		

694	94.00	Petrol					
DH	4 Cyl.	8.5:1	1913cc	60kW (81)PS	TD3580 1062		
TRANSPORTER 08/82→07/92							
	.KIT		KIT				FOL170 (x8)
	DM690 ○	GM690 ○		JD237 ■ (x2) JD236 ■ (x4)	JM986 (x2)		











695	94.00	Petrol					
EY	4 Cyl.		1915cc	42kW (57)PS	TD9322		
TRANSPORTER 08/82→07/92							
	.KIT		KIT				FOL170 (x8)
	DM690 ○	GM690 ○		JD237 ■ (x2) JD236 ■ (x4)	JM986 (x2)		







696	94.00	Petrol			
DJ	Boxer4 Cyl.	10.3:1	2109cc	82kW (111)PS	TD4059 1063
MV	Boxer4 Cyl.	8.7:1	2109cc	70kW (95)PS	TD4133 1063
SR	4 Cyl.		2109cc	64kW (87)PS	TD4153 1063









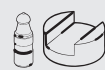

TRANSPORTER 08/85→07/92							
	.KIT		KIT				FOL170 (x8)









B x C x D	E x F x G
OE	MAT.
V94549 ■ 39.90 x 8.00 x 122.40	VAG92220B ■ 66.50 x 8.98 x 13.06
V94548 ■ 33.85 x 9.00 x 122.65	VAG96228B ■ 66.50 x 9.02 x 13.05
025 109 601C	025 109 612A
MB	MG cr
45° Y H	45° ss H



	DM690 ○	GM690 ○		JC478 ■ JD237 ■ (x2) JC152 ■ (x4) JD236 ■ (x4)	JM986 (x2)		







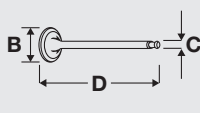
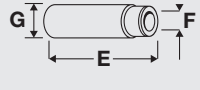

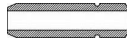

697	 94.00	Petrol	
SP	4 Cyl.	1915cc	54kW (73)PS
TD4152 1061			
			
			
			
	DM690 ○	 GM690 ○	
			JD237 ■ (x2) JD236 ■ (x4)
			JM986 (x2)

698	 94.00	Petrol	
SS	4 Cyl.	2109cc	68kW (92)PS
TD4154 1063			
TRANSPORTER 07/89→07/92			
			
			
			
			FOL170 (x8)

			
			
			
	DM690 ○	 GM690 ○	
			JC478 ■ JD237 ■ (x2) JC152 ■ (x4) JD236 ■ (x4)
			JM986 (x2)

699	 94.00	Petrol	
DG	Boxer4 Cyl.	8.4:1	1888cc
57kW (77)PS			
TD4993 1061			
TRANSPORTER 08/82→07/92			
			
			
			
			FOL170 (x8)

	
B x C x D	E x F x G
OE	MAT.
V94549 ■ 39.90 x 8.00 x 122.40	025 109 601C MB
V94548 ■ 33.85 x 9.00 x 122.65	025 109 612A MG cr
45°	45°
Y	ss
H	H
VAG92220B ■ 66.50 x 8.98 x 13.06	
VAG96228B ■ 66.50 x 9.02 x 13.05	

			
			
			
	DM690 ○	 GM690 ○	
			JD237 ■ (x2) JD236 ■ (x4)
			JM986 (x2)

VW GROUP

700	94.00	Petrol				
DH	Boxer4 Cyl.	8.5:1	1913cc	60kW (81)PS	TD4994	1062
GW	Boxer4 Cyl.		1913cc	66kW (89)PS	TD4099	1062
TRANSPORTER 01/83→02/89						

					FOL170 (x8)

<p>B x C x D</p> <p>OE</p> <p>MAT.</p> <p></p> <p>45° Y H</p> <p>V94549 </p> <p>025 109 601C</p> <p>39.90 x 8.00 x 122.40</p> <p>V94548 </p> <p>025 109 612A</p> <p>33.85 x 9.00 x 122.65</p>	<p>E x F x G</p> <p>VAG96228B </p> <p>66.50 x 9.02 x 13.05</p>

	DM690	GM690		JD237 (x2)	JD236 (x4)	JM986 (x2)	









701	94.00	Petrol				
CJ	Boxer4 Cyl.	7.3:1	1970cc	51kW (70)PS	TD4045	1061
TRANSPORTER 08/75→07/79						







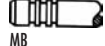
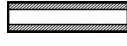





<p>B x C x D</p> <p>OE</p> <p>MAT.</p> <p></p> <p>30° H</p> <p>V94546 </p> <p>021 109 601</p> <p>39.20 x 8.00 x 117.05</p>	<p>E x F x G</p> <p>VAG92220B </p> <p>66.50 x 8.98 x 13.06</p> <p>VAG96228B </p> <p>66.50 x 9.02 x 13.05</p>

702	94.00	Petrol				
CU	Boxer4 Cyl.	7.3:1	1970cc	51kW (70)PS	TD4050	1061
CV	Boxer4 Cyl.		1970cc	51kW (70)PS	TD4051	1061
TRANSPORTER 05/79→04/86						

					FOL170 (x8)

<p>B x C x D</p> <p>OE</p> <p>MAT.</p> <p></p> <p>30° H</p> <p>V94546 </p> <p>021 109 601</p> <p>39.20 x 8.00 x 117.05</p>	<p>E x F x G</p> <p>VAG92220B </p> <p>66.50 x 8.98 x 13.06</p> <p>VAG96228B </p> <p>66.50 x 9.02 x 13.05</p>

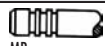
703	 94.00	Petrol	
GD	Boxer4 Cyl.	1970cc	51kW (70)PS
TD4091			
TRANSPORTER 08/75→07/79			
			
B x C x D	OE	MAT.	30° H
V94546 	021 109 601		VAG92220B 
39.20 x 8.00 x 117.05			66.50 x 8.98 x 13.06 66.50 x 9.02 x 13.05

704	 94.00	Petrol	
GE	Boxer4 Cyl.	7.3:1	1970cc
TD5005 1061			
TRANSPORTER 08/75→07/79			
			
			FOL170 (x8)
			
B x C x D	OE	MAT.	30° H
V94546 	021 109 601		VAG92220B 
39.20 x 8.00 x 117.05			66.50 x 8.98 x 13.06 66.50 x 9.02 x 13.05

BOTTOM ENGINE APPLICATIONS

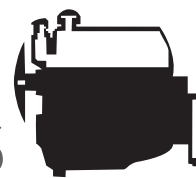

MOTORBLOCKANWENDUNGEN

APPLICAZIONI BASSA INFERIORE DEL MOTORE

APPLICATIONS BAS MOTEUR

APLICACIONES PARA LA PARTE INFERIOR DEL MOTOR

DÓŁ SILNIKA

ДЕТАЛИ НИЖНЕЙ ЧАСТИ ДВИГАТЕЛЯ

تطبيقات المحرك السفلية

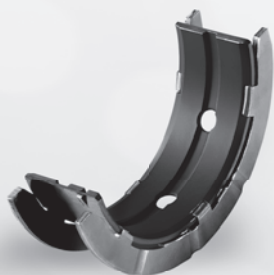



 **GLYCO**[®]











 **GOETZE**[®]

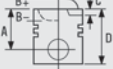



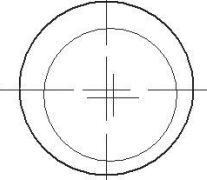





Miral[®]
FITTED WITH  **GOETZE RINGS**

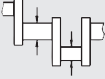

705		 67.10		Petrol			
AER	4 Cyl.	10.5:1	999cc	37kW (50)PS		TD5533	1
AER	4 Cyl.	10.5:1	999cc	37kW (50)PS		TD9519	1
ALL	4 Cyl.	10.5:1	999cc	37kW (50)PS		TD10609	4
ALL	4 Cyl.	10.5:1	999cc	37kW (50)PS		TD13891	4





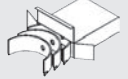



AROSA	05/97 → 06/04	CORDOBA	09/96 → 06/99	IBIZA	09/96 → 08/99
LUPO	09/98 → 07/05	POLO	08/96 → 12/01	VOYAGE	08/96 → 12/01

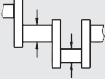
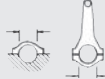

		
87-101300-00 STD 87-101307-00 0.50mm A 31.25 B- 5.65 D 56.27  17x48	 	08-101300-00 STD 08-101307-00 0.50mm 1.00  NT[52] 1.20  P 2.00  P

[52] Steel [52] Stahl



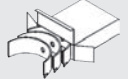



									
BE/PL	4	41.965/41.980	45.000/45.012	18.500	1.505	0.020/0.060	AL-LF	01-3874	01-3874/4 STD 0.25
MB/HL 1-5	5	53.963/53.978	59.007/59.019	17.000	2.512	0.027/0.046	AL-LF	02-4929	H1325/5 STD 0.25 0.50
TW/A	2	59.500	73.200		1.975		AL-LF	04-3527	A123/4 STD
TW/A	2	59.500	73.200		1.975		AL-LF	04-3528	
SE/PB	1	20.000	23.000/23.025	24.000			BC	55-3277	55-3277 SEMI
BU	1	42.959/42.975	46.055/46.095	15.000			AL-LF	07-3088	07-3088 STD SEMI [68]
BU	1	41.959/41.975	45.000/45.025	15.000			AL-LF	07-3089	07-3089 STD SEMI [68]

706		 67.10		Petrol			
AHT	4 Cyl.	10.5:1	999cc	37kW (50)PS		TD11467	2
AHT	4 Cyl.	10.5:1	999cc	37kW (50)PS		TD13889	2
AROSA	10/98 → 02/00	LUPO	10/98 → 05/00				

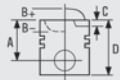
									
BE/PL	4	41.965/41.980	45.000/45.012	18.500	1.505	0.020/0.060	AL-LF	01-3874	01-3874/4 STD 0.25









707		 67.10	Petrol			
ALD	4 Cyl.	10.7:1	999cc	37kW (50)PS	TD11468	3
ALD	4 Cyl.	10.7:1	999cc	37kW (50)PS	TD13890	3
ANV	4 Cyl.	10.7:1	999cc	37kW (50)PS	TD11469	3
ANV	4 Cyl.	10.7:1	999cc	37kW (50)PS	TD13888	3

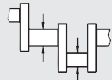
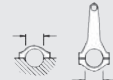

AROSA	05/97→06/04	CORDOBA	06/99→10/02	IBIZA	08/99→02/02
LUPO	09/98→07/05	POLO	10/99→09/01		





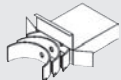



		
	08-101300-00 STD 08-101307-00 0.50mm 1.00  NT[52] 1.20  P 2.00  P	

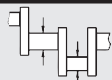

[52] Steel





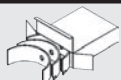

[52] Stahl

									
BE/PL	4	41.965/41.980	45.000/45.012	18.500	1.505	0.020/0.060	AL-LF	01-3874	01-3874/4 STD 0.25
MB/HL 1-5	5	53.963/53.978	59.007/59.019	17.000	2.512	0.027/0.046	AL-LF	02-4929	H1325/5 STD 0.25 0.50
TW/A	2	59.500	73.200		1.975		AL-LF	04-3527	A123/4 STD
TW/A	2	59.500	73.200		1.975		AL-LF	04-3528	
SE/PB	1	20.000	23.000/23.025	24.000			BC	55-3277	55-3277 SEMI
BU	1	42.959/42.975	46.055/46.095	15.000			AL-LF	07-3088	07-3088 STD SEMI [68]
BU	1	41.959/41.975	45.000/45.025	15.000			AL-LF	07-3089	07-3089 STD SEMI [68]

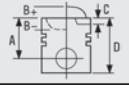







708		 67.10	Petrol			
ATE	4 Cyl.	10.7:1	999cc	37kW (50)PS	TD22625	6

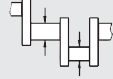
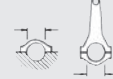

									
BE/PL	4	41.965/41.980	45.000/45.012	18.500	1.505	0.020/0.060	AL-LF	01-3874	01-3874/4 STD 0.25
MB/HL 1-5	5	53.963/53.978	59.007/59.019	17.000	2.512	0.027/0.046	AL-LF	02-4929	H1325/5 STD 0.25 0.50
TW/A	2	59.500	73.200		1.975		AL-LF	04-3527	A123/4 STD
TW/A	2	59.500	73.200		1.975		AL-LF	04-3528	
SE/PB	1	20.000	23.000/23.025	24.000			BC	55-3277	55-3277 SEMI
BU	1	42.959/42.975	46.055/46.095	15.000			AL-LF	07-3088	07-3088 STD SEMI [68]
BU	1	41.959/41.975	45.000/45.025	15.000			AL-LF	07-3089	07-3089 STD SEMI [68]







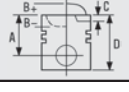

709	 67.10	Petrol				
AUC	4 Cyl.	10.7:1	999cc	37kW (50)PS	TD15491	3
AUC	4 Cyl.	10.7:1	999cc	37kW (50)PS	TD16138	3
AROSA	05/97→06/04	CORDOBA	06/99→10/02	IBIZA	08/99→02/02	
LUPO	09/98→07/05	POLO	10/99→09/01			

		
	08-101300-00 STD 08-101307-00 0.50mm 1.00  NT[52] 1.20  P 2.00  P	

[52] Steel [52] Stahl







									
BE/PL	4	41.965/41.980	45.000/45.012	18.500	1.505	0.020/0.060	AL-LF	01-3874	01-3874/4 STD 0.25
MB/HL 1-5	5	53.963/53.978	59.007/59.019	17.000	2.512	0.027/0.046	AL-LF	02-4929	H1325/5 STD 0.25 0.50

710	 69.50	Petrol				
FA	4 Cyl.	8.2:1	1093cc	37kW (50)PS	TD5001	7
FJ	4 Cyl.	8.2:1	1093cc	38kW (52)PS	TD4082	8
GG	4 Cyl.	8.2:1	1093cc	37kW (50)PS	TD4093	9
HA	4 Cyl.	8:1	895cc	29kW (40)PS	TD4104	13
HB	4 Cyl.	8/8.2:1	1093cc	37kW (50)PS	TD4207	10
HB	4 Cyl.	8/8.2:1	1093cc	37kW (50)PS	TD5008	10
HC	4 Cyl.	9.1/9.5:1	1093cc	44kW (60)PS	TD263	11
HC	4 Cyl.	9.1/9.5:1	1093cc	44kW (60)PS	TD5009	11
HD	4 Cyl.	8.20:1	1093cc	38kW (52)PS	TD21345	
HD	4 Cyl.	8/8.2:1	1093cc	38kW (52)PS	TD264	12
50	08/74→07/78	DERBY	02/77→07/83	GOLF	04/74→07/83	
JETTA	08/78→02/84	POLO	03/75→09/89	SCIROCCO	04/74→07/79	

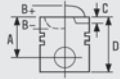
		
	08-108500-00 STD →05/75 2.00  CR P 2.50  P 4.00  CR[52]	
	08-108600-00 STD 05/75→07/78 1.75  CR P 2.50  P 4.00  CR[52]	









...Continued

710  **69.50** **Petrol**

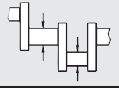
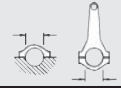
		
	<p>08-108700-00 STD 08-108707-00 0.50mm 08/78 → 07/81</p> <p>1.75  CR P 2.00  P 4.00  CR[52]</p>	

[52] Steel



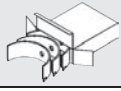



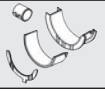

[52] Stahl

									
BE/PL	4	41.965/41.980	45.000/45.016	18.000	1.505	0.020/0.066	EC	71-3276	71-3276/4 STD 0.25 0.50
MB/HL 1,2,4,5	8	53.958/53.978	59.000/59.019	18.500	2.502	0.020/0.082	AL-LF	02-3085U	H024/5 STD 0.25
MB/HL 3	2	53.958/53.978	59.000/59.019	24.930	2.502	0.020/0.082	AL-LF	02-3086HU	
SE/PB	1	20.000	23.000/23.025	24.000			BC	55-3277	55-3277 SEMI
BU	1	42.959/42.975	46.055/46.095	15.000			AL-LF	07-3088	07-3088 STD SEMI [68]
BU	1	41.959/41.975	45.000/45.025	15.000			AL-LF	07-3089	07-3089 STD SEMI [68]

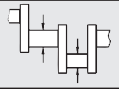
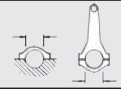
711  **72.00** **Petrol**

AQV	4 Cyl.	997cc	37kW (50)PS	TD16238	15
ARV	4 Cyl.	997cc	37kW (50)PS	TD15368	15



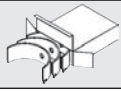





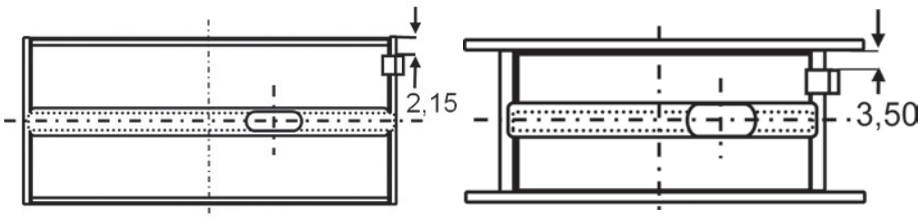

FABIA 12/99 → 08/02

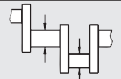

									
BE/PL	4	41.965/41.980	45.000/45.012	18.500	1.505	0.020/0.060	AL-LF	01-3874	01-3874/4 STD 0.25
MB/HL 1,2,4,5	8	53.958/53.978	59.000/59.019	18.500	2.502	0.020/0.082	AL-LF	02-3085U	H024/5 STD 0.25
MB/HL 3	2	53.958/53.978	59.000/59.019	24.930	2.502	0.020/0.082	AL-LF	02-3086HU	
MB/HL 1-5	10	53.958/53.978	59.000/59.019	18.500	2.502	0.020/0.082	AL-LF	02-3085U	H026/5 STD 0.25 0.50

02-3085U







02-3086HU



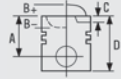







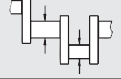

711		 75.00	Petrol							
										
TW/A	2	59.500	73.200		1.975		AL-LF	04-3527	A123/4 STD	
TW/A	2	59.500	73.200		1.975		AL-LF	04-3528		
BU	1	42.959/42.975	46.055/46.095	15.000			AL-LF	07-3088	07-3088 STD SEMI [68]	
BU	1	41.959/41.975	45.000/45.025	15.000			AL-LF	07-3089	07-3089 STD SEMI [68]	



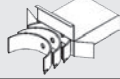

712		 75.00	Petrol				
AAK	4 Cyl.		1043cc		33kW (45)PS	TD4003 16	
ACM	4 Cyl.	9.5:1	1043cc		33kW (45)PS	TD4013 18	





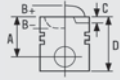
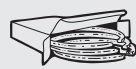



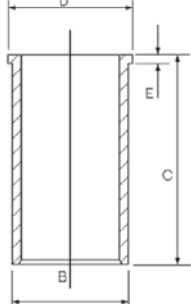

POLO 01/85 → 09/94

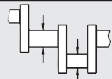

		
	08-406200-00 STD 08-406207-00 0.50mm 08-406211-00 1.00mm	
	1.75  CR P 2.00  P 3.00  CR P	







									
BE/PL	4	41.965/41.980	45.000/45.016	18.000	1.505	0.020/0.066	EC	71-3276	71-3276/4 STD 0.25 0.50
MB/HL 1-5	10	53.958/53.978	59.000/59.019	18.500	2.502	0.020/0.082	AL-LF	02-3085U	H026/5 STD 0.25 0.50
TW/A	2	59.500	73.200		1.975		AL-LF	04-3527	A123/4 STD
TW/A	2	59.500	73.200		1.975		AL-LF	04-3528	
SE/PB	1	20.000	23.000/23.025	24.000			BC	55-3277	55-3277 SEMI
BU	1	42.959/42.975	46.055/46.095	15.000			AL-LF	07-3088	07-3088 STD SEMI [68]
BU	1	41.959/41.975	45.000/45.025	15.000			AL-LF	07-3089	07-3089 STD SEMI [68]



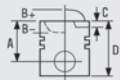



713	 75.00	Petrol				
AAU	4 Cyl.	10.1:1	1043cc	33kW (45)PS	TD4892	17
AAU	4 Cyl.	10.1:1	1043cc	33kW (45)PS	TD4971	17
CORDOBA	02/93→06/96	IBIZA	03/93→09/96	POLO	01/85→12/99	



		
	08-502200-00 STD 08-502207-00 0.50mm 1.50  CR P 1.50  P 2.50  P	14-025070-00 D B 78.00 C 133.00 D 81.00 E 4.50 

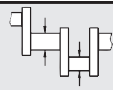
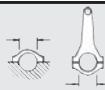

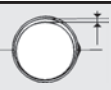

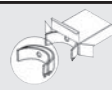
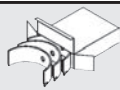

									
BE/PL	4	41.965/41.980	45.000/45.016	18.000	1.505	0.020/0.066	EC	71-3276	71-3276/4 STD 0.25 0.50
MB/HL 1-5	10	53.958/53.978	59.000/59.019	18.500	2.502	0.020/0.082	AL-LF	02-3085U	H026/5 STD 0.25 0.50
TW/A	2	59.500	73.200		1.975		AL-LF	04-3527	A123/4 STD
TW/A	2	59.500	73.200		1.975		AL-LF	04-3528	
SE/PB	1	20.000	23.000/23.025	24.000			BC	55-3277	55-3277 SEMI
BU	1	42.959/42.975	46.055/46.095	15.000			AL-LF	07-3088	07-3088 STD SEMI [68]
BU	1	41.959/41.975	45.000/45.025	15.000			AL-LF	07-3089	07-3089 STD SEMI [68]



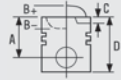





714	 75.00	Petrol				
ABD	4 Cyl.	9.2:1	1390cc	44kW (60)PS	TD3574	44
ABD	4 Cyl.	9.2:1	1390cc	44kW (60)PS	TD4973	44
AEV	4 Cyl.		1043cc	33kW (45)PS	TD4021	19
CORDOBA	06/94→06/99	GOLF	10/91→04/99	IBIZA	09/93→08/99	
POLO	10/94→09/96	VENTO	11/91→09/98			

		
	08-502200-00 STD 08-502207-00 0.50mm 1.50  CR P 1.50  P 2.50  P	

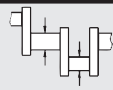
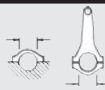
714		 75.00	Petrol						
									
BE/PL	4	41.965/41.980	45.000/45.016	18.000	1.505	0.020/0.066	EC	71-3276	71-3276/4 STD 0.25 0.50
MB/HL 1-5	10	53.958/53.978	59.000/59.019	18.500	2.502	0.020/0.082	AL-LF	02-3085U	H026/5 STD 0.25 0.50
TW/A	2	59.500	73.200		1.975		AL-LF	04-3527	A123/4 STD
TW/A	2	59.500	73.200		1.975		AL-LF	04-3528	
SE/PB	1	20.000	23.000/23.025	24.000			BC	55-3277	55-3277 SEMI
BU	1	42.959/42.975	46.055/46.095	15.000			AL-LF	07-3088	07-3088 STD SEMI [68]
BU	1	41.959/41.975	45.000/45.025	15.000			AL-LF	07-3089	07-3089 STD SEMI [68]

715		 75.00	Petrol							
GL	4 Cyl.	9.5:1	1043cc	29kW (40)PS				TD5006	20	
GN	4 Cyl.	9.5:1	1043cc	33kW (45)PS				TD4095	21	
DERBY	10/81→12/84	GOLF	11/83→08/85	POLO				10/81→10/86		

		
<p>08-406200-00 STD 08-406207-00 0.50mm 08-406211-00 1.00mm</p> <p>1.75  CR P 2.00  P 3.00  CR P</p>		

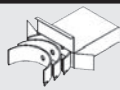
									
BE/PL	4	41.965/41.980	45.000/45.016	18.000	1.505	0.020/0.066	EC	71-3276	71-3276/4 STD 0.25 0.50
MB/HL 1,2,4,5	8	53.958/53.978	59.000/59.019	18.500	2.502	0.020/0.082	AL-LF	02-3085U	H024/5 STD 0.25
MB/HL 3	2	53.958/53.978	59.000/59.019	24.930	2.502	0.020/0.082	AL-LF	02-3086HU	
SE/PB	1	20.000	23.000/23.025	24.000			BC	55-3277	55-3277 SEMI
BU	1	42.959/42.975	46.055/46.095	15.000			AL-LF	07-3088	07-3088 STD SEMI [68]
BU	1	41.959/41.975	45.000/45.025	15.000			AL-LF	07-3089	07-3089 STD SEMI [68]

716	75.00	Petrol				
HZ	4 Cyl.	9.5:1	1043cc	33/37kW (45/50)PS	TD5012	22
DERBY	08/81→12/84	GOLF	08/85→10/91	POLO	01/85→09/94	







	08-406200-00 STD 08-406207-00 0.50mm 08-406211-00 1.00mm 1.75 CR P 2.00 P 3.00 CR P	14-025070-00 D B 78.00 C 133.00 D 81.00 E 4.50

BE/PL	4	41.965/41.980	45.000/45.016	18.000	1.505	0.020/0.066	EC	71-3276	71-3276/4 STD 0.25 0.50
MB/HL 1-5	10	53.958/53.978	59.000/59.019	18.500	2.502	0.020/0.082	AL-LF	02-3085U	H026/5 STD 0.25 0.50
TW/A	2	59.500	73.200		1.975		AL-LF	04-3527	A123/4 STD
TW/A	2	59.500	73.200		1.975		AL-LF	04-3528	
SE/PB	1	20.000	23.000/23.025	24.000			BC	55-3277	55-3277 SEMI
BU	1	42.959/42.975	46.055/46.095	15.000			AL-LF	07-3088	07-3088 STD SEMI [68]
BU	1	41.959/41.975	45.000/45.025	15.000			AL-LF	07-3089	07-3089 STD SEMI [68]

717	75.00	Petrol				
2G	4 Cyl.		1272cc	40kW (54)PS	TD3571	23
2G	4 Cyl.		1272cc	40kW (54)PS	TD4964	23
HW	4 Cyl.	9.5:1	1272cc	37kW (50)PS	TD4113	35
MH	4 Cyl.	9.2:1	1272cc	40kW (54)PS	TD4131	36
NU	4 Cyl.		1272cc	37kW (50)PS	TD4135	37
PY	4 Cyl.		1272cc	85kW (115)PS	TD5023	39
CORDOBA	02/93→08/94	DERBY	08/83→12/84	GOLF	08/83→12/92	
IBIZA	03/93→08/99	JETTA	01/84→12/91	POLO	08/83→09/94	

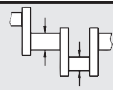
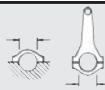
	08-406200-00 STD 08-406207-00 0.50mm 08-406211-00 1.00mm 1.75 CR P 2.00 P 3.00 CR P	

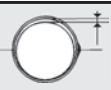
717  **75.00** **Petrol**

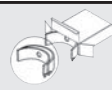
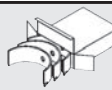
									
BE/PL	4	41.965/41.980	45.000/45.016	18.000	1.505	0.020/0.066	EC	71-3276	71-3276/4 STD 0.25 0.50
MB/HL 1,2,4,5	8	53.958/53.978	59.000/59.019	18.500	2.502	0.020/0.082	AL-LF	02-3085U	H024/5 STD 0.25
MB/HL 3	2	53.958/53.978	59.000/59.019	24.930	2.502	0.020/0.082	AL-LF	02-3086HU	
MB/HL 1-5	10	53.958/53.978	59.000/59.019	18.500	2.502	0.020/0.082	AL-LF	02-3085U	H026/5 STD 0.25 0.50

02-3085U

02-3086HU

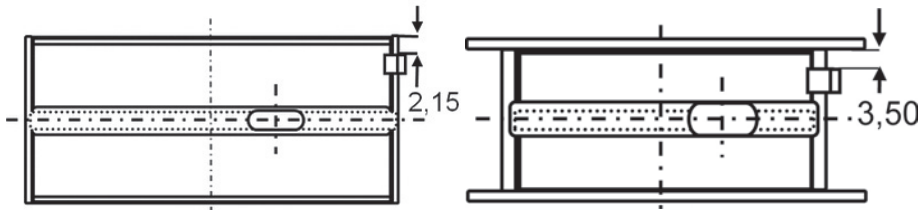





TW/A	2	59.500	73.200		1.975		AL-LF	04-3527	A123/4 STD
TW/A	2	59.500	73.200		1.975		AL-LF	04-3528	
SE/PB	1	20.000	23.000/23.025	24.000			BC	55-3277	55-3277 SEMI
BU	1	42.959/42.975	46.055/46.095	15.000			AL-LF	07-3088	07-3088 STD SEMI [68]
BU	1	41.959/41.975	45.000/45.025	15.000			AL-LF	07-3089	07-3089 STD SEMI [68]

718  **75.00** **Petrol** 

3F 4 Cyl. 9.5:1 1272cc **55/57kW (75/78)PS** **TD4968** **24**





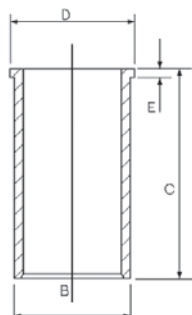

POLO 10/89→09/94

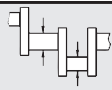
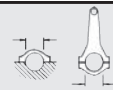

	
<p>08-502200-00 STD</p> <p>08-502207-00 0.50mm</p> <p>1.50  CR P</p> <p>1.50  P</p> <p>2.50  P</p>	<p>14-025070-00 D B 78.00 C 133.00 D 81.00 E 4.50</p> 

...Continued

718  **75.00** **Petrol**

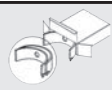
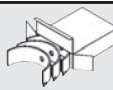
									
BE/PL	4	41.965/41.980	45.000/45.016	18.000	1.505	0.020/0.066	EC	71-3276	71-3276/4 STD 0.25 0.50
MB/HL 1,2,4,5	8	53.958/53.978	59.000/59.019	18.500	2.502	0.020/0.082	AL-LF	02-3085U	H024/5 STD 0.25
MB/HL 3	2	53.958/53.978	59.000/59.019	24.930	2.502	0.020/0.082	AL-LF	02-3086HU	
MB/HL 1-5	10	53.958/53.978	59.000/59.019	18.500	2.502	0.020/0.082	AL-LF	02-3085U	H026/5 STD 0.25 0.50

02-3085U

02-3086HU

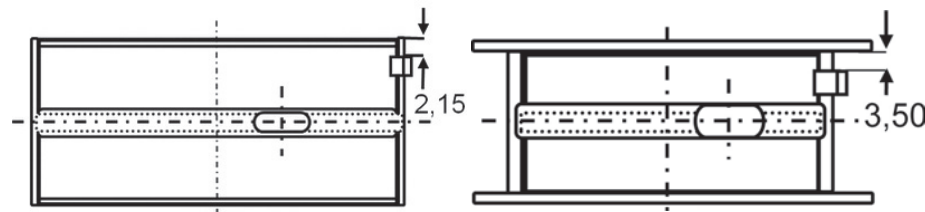





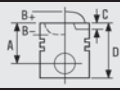

TW/A	2	59.500	73.200		1.975		AL-LF	04-3527	A123/4 STD
TW/A	2	59.500	73.200		1.975		AL-LF	04-3528	
SE/PB	1	20.000	23.000/23.025	24.000			BC	55-3277	55-3277 SEMI
BU	1	42.959/42.975	46.055/46.095	15.000			AL-LF	07-3088	07-3088 STD SEMI [68]
BU	1	41.959/41.975	45.000/45.025	15.000			AL-LF	07-3089	07-3089 STD SEMI [68]

719  **75.00** **Petrol**





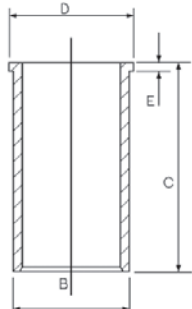

AAV	4 Cyl.	9.2:1	1272cc	40kW (54)PS	TD4893	25
AAV	4 Cyl.	9.2:1	1272cc	40kW (54)PS	TD5159	25
GK	4 Cyl.	9.5:1	1272cc	55kW (75)PS	TD4094	29
HK	4 Cyl.	9.5:1	1272cc	40kW (54)PS	TD5011	34
NZ	4 Cyl.	9.5:1	1272cc	40kW (54)PS	TD4136	38

CORDOBA	02/93→08/94	DERBY	09/82→12/84	GOLF	08/83→12/92
IBIZA	03/93→08/99	JETTA	01/84→12/91	POLO	09/82→09/94

		
	<p>08-406200-00 STD</p> <p>08-406207-00 0.50mm</p> <p>08-406211-00 1.00mm</p> <p>1.75  CR P</p> <p>2.00  P</p> <p>3.00  CR P</p>	<p>14-025070-00 D B 78.00 C 133.00 D 81.00 E 4.50</p> 

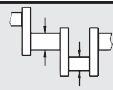
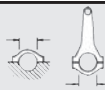
719

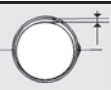
 **75.00**
Petrol

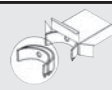
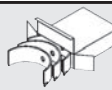
									
BE/PL	4	41.965/41.980	45.000/45.016	18.000	1.505	0.020/0.066	EC	71-3276	71-3276/4 STD 0.25 0.50
MB/HL 1,2,4,5	8	53.958/53.978	59.000/59.019	18.500	2.502	0.020/0.082	AL-LF	02-3085U	H024/5 STD 0.25
MB/HL 3	2	53.958/53.978	59.000/59.019	24.930	2.502	0.020/0.082	AL-LF	02-3086HU	
MB/HL 1-5	10	53.958/53.978	59.000/59.019	18.500	2.502	0.020/0.082	AL-LF	02-3085U	H026/5 STD 0.25 0.50

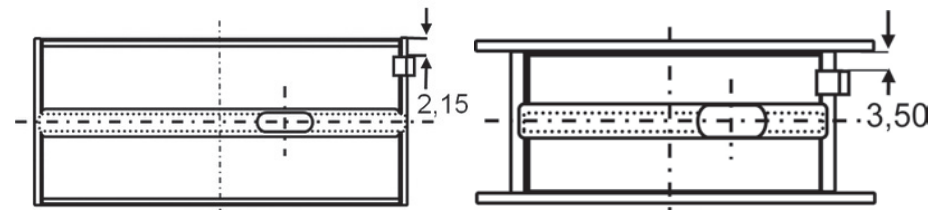
02-3085U
02-3086HU







TW/A	2	59.500	73.200		1.975		AL-LF	04-3527	A123/4 STD
TW/A	2	59.500	73.200		1.975		AL-LF	04-3528	
SE/PB	1	20.000	23.000/23.025	24.000			BC	55-3277	55-3277 SEMI
BU	1	42.959/42.975	46.055/46.095	15.000			AL-LF	07-3088	07-3088 STD SEMI [68]
BU	1	41.959/41.975	45.000/45.025	15.000			AL-LF	07-3089	07-3089 STD SEMI [68]



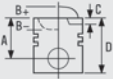



720

 **75.00**
Petrol



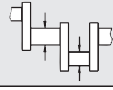
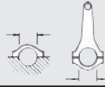

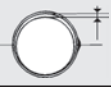

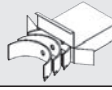



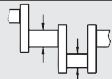

EU 4 Cyl. 1272cc 44kW (60)PS TD16428 26

PASSAT 08/80→07/86







		
	08-408700-00 STD 08-408707-00 0.50mm 1.50  CR P 1.75  P 3.00  CR P	

									
BE/PL	4	47.758/47.778	50.600/50.612	19.000	1.406	0.020/0.067	EC	71-3694	71-3694/4 STD 0.25 0.50
MB/HL	3	53.958/53.978	59.000/59.019	18.500	2.502	0.020/0.082	AL-LF	02-3085L	H025/5 STD 0.25 0.50
MB/HL	5	53.958/53.978	59.000/59.019	18.500	2.502	0.020/0.082	AL-LF	02-3085U	
MB/HL	1	53.958/53.978	59.000/59.019	24.930	2.502	0.020/0.082	AL-LF	02-3086HL	
MB/HL	1	53.958/53.978	59.000/59.019	24.930	2.502	0.020/0.082	AL-LF	02-3086HU	

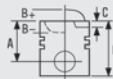
...Continued







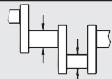

720		 75.00	Petrol							
										
SE/PB	1	20.000	23.000/23.052	25.000			BC	55-3567	55-3567 SEMI	
BU	1	42.959/42.975	46.055/46.095	15.000			AL-LF	07-3088	07-3088 STD SEMI	[68]
BU	1	41.959/41.975	45.000/45.025	15.000			AL-LF	07-3089	07-3089 STD SEMI	[68]

721		 75.00	Petrol							
FY	4 Cyl.	8.2:1	1272cc	40kW (54)PS						TD259 27
FY	4 Cyl.	8.2:1	1272cc	40kW (54)PS						TD5002 27
FZ	4 Cyl.	8.2:1	1272cc	44kW (60)PS						TD260 28
FZ	4 Cyl.	8.2:1	1272cc	44kW (60)PS						TD5003 28
GF	4 Cyl.	8.2:1	1272cc	44kW (60)PS						TD4092 28
GT	4 Cyl.		1272cc	44kW (60)PS						TD4097 31
HH	4 Cyl.	8.2:1	1272cc	44kW (60)PS						TD265 32
HH	4 Cyl.	8.2:1	1272cc	44kW (60)PS						TD5010 32
HJ	4 Cyl.		1272cc	43kW (58)PS						TD4105 33
HJ	4 Cyl.		1272cc	43kW (58)PS						TD16547 33
50	01/77→07/78		80	09/78→07/81	DERBY	02/77→07/83				
GOLF	08/79→10/86		JETTA	08/79→10/86	PASSAT	05/73→07/86				
POLO	12/76→07/88		SANTANA	08/81→07/83	SCIROCCO	08/79→12/83				

		
	08-404200-00 STD 08-404211-00 1.00mm 1.75  CR P 2.00  P 4.00  CR[52]	

[52] Steel







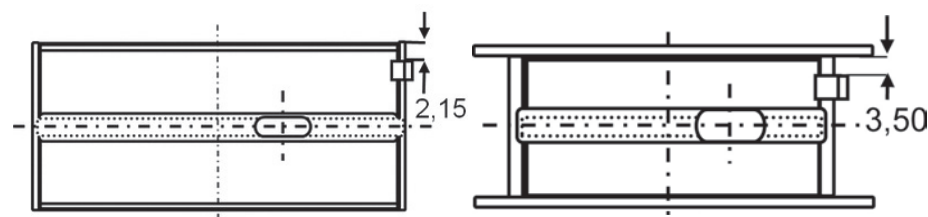

[52] Stahl

										
BE/PL	4	41.965/41.980	45.000/45.016	18.000	1.505	0.020/0.066	EC	71-3276	71-3276/4 STD 0.25 0.50	
MB/HL 1,2,4,5	8	53.958/53.978	59.000/59.019	18.500	2.502	0.020/0.082	AL-LF	02-3085U	H024/5 STD 0.25	
MB/HL 3	2	53.958/53.978	59.000/59.019	24.930	2.502	0.020/0.082	AL-LF	02-3086HU		
MB/HL 1-5	10	53.958/53.978	59.000/59.019	18.500	2.502	0.020/0.082	AL-LF	02-3085U	H026/5 STD 0.25 0.50	

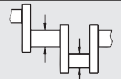



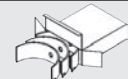

02-3085U

02-3086HU

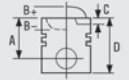







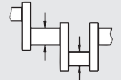
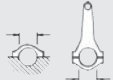

721		 75.00	Petrol							
										
TW/A	2	59.500	73.200		1.975		AL-LF	04-3527	A123/4 STD	
TW/A	2	59.500	73.200		1.975		AL-LF	04-3528		
SE/PB	1	20.000	23.000/23.025	24.000			BC	55-3277	55-3277 SEMI	
BU	1	42.959/42.975	46.055/46.095	15.000			AL-LF	07-3088	07-3088 STD SEMI	[68]
BU	1	41.959/41.975	45.000/45.025	15.000			AL-LF	07-3089	07-3089 STD SEMI	[68]

722		 75.00	Petrol							
GS	4 Cyl.	8.2:1	1272cc	43kW (58)PS				TD4096	30	
GOLF	08/82→12/83		JETTA	08/82→02/84						

		
	08-404200-00 STD 08-404211-00 1.00mm 1.75  CR P 2.00  P 4.00  CR[52]	

[52] Steel [52] Stahl

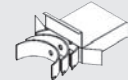
										
BE/PL	4	41.965/41.980	45.000/45.016	18.000	1.505	0.020/0.066	EC	71-3276	71-3276/4 STD 0.25 0.50	
MB/HL 1,2,4,5	8	53.958/53.978	59.000/59.019	18.500	2.502	0.020/0.082	AL-LF	02-3085U	H024/5 STD 0.25	
MB/HL 3	2	53.958/53.978	59.000/59.019	24.930	2.502	0.020/0.082	AL-LF	02-3086HU		
SE/PB	1	20.000	23.000/23.025	24.000			BC	55-3277	55-3277 SEMI	
BU	1	42.959/42.975	46.055/46.095	15.000			AL-LF	07-3088	07-3088 STD SEMI	[68]
BU	1	41.959/41.975	45.000/45.025	15.000			AL-LF	07-3089	07-3089 STD SEMI	[68]

723

75.00

Diesel



MN	4 Cyl.	22:1	1272cc	33kW (45)PS	TD4132	40
MN	4 Cyl.	22:1	1272cc	33kW (45)PS	TD9401	40
POLO	08/86→08/90		TERRA	03/90→12/94		

	08-991300-00 STD 08-991307-00 0.50mm 1.75 CR P 2.00 CR P 3.00 CR P	14-025070-00 D B 78.00 C 133.00 D 81.00 E 4.50

BE/PL	4	41.965/41.980	45.000/45.016	18.000	1.505	0.020/0.066	EC	71-3276	71-3276/4 STD 0.25 0.50
MB/HL 1,2,4,5	8	53.958/53.978	59.000/59.019	18.500	2.502	0.020/0.082	AL-LF	02-3085U	H024/5 STD 0.25
MB/HL 3	2	53.958/53.978	59.000/59.019	24.930	2.502	0.020/0.082	AL-LF	02-3086HU	
MB/HL 1-5	10	53.958/53.978	59.000/59.019	18.500	2.502	0.020/0.082	AL-LF	02-3085U	H026/5 STD 0.25 0.50

02-3085U

02-3086HU

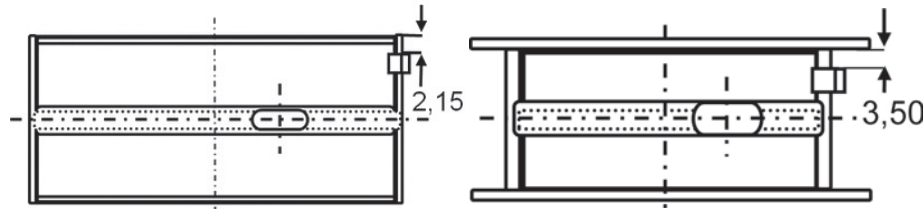

TW/A	2	59.500	73.200		1.975		AL-LF	04-3527	A123/4 STD	
TW/A	2	59.500	73.200		1.975		AL-LF	04-3528		
SE/PB	1	20.000	23.000/23.025	24.000			BC	55-3277	55-3277 SEMI	
BU	1	42.959/42.975	46.055/46.095	15.000			AL-LF	07-3088	07-3088 STD SEMI	[68]
BU	1	41.959/41.975	45.000/45.025	15.000			AL-LF	07-3089	07-3089 STD SEMI	[68]

724	75.00	Petrol				
EP	4 Cyl.	8.25/9:1	1297cc	44kW (60)PS	TD257	41
EP	4 Cyl.	8.25/9:1	1297cc	44kW (60)PS	TD5158	41
80	09/78→07/86	CITYGOLF	01/81→12/84	PASSAT	08/80→07/86	
SANTANA	08/84→12/85					

	08-408700-00 STD 08-408707-00 0.50mm 1.50 CR P 1.75 P 3.00 CR P	



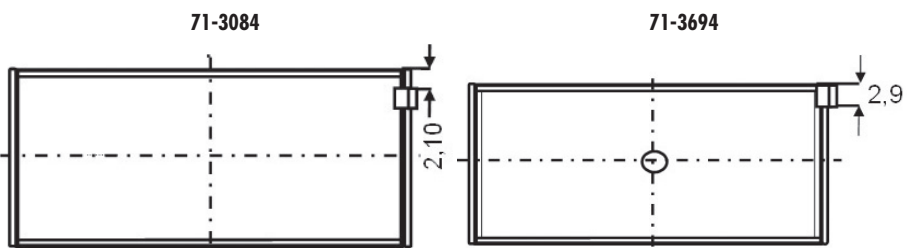

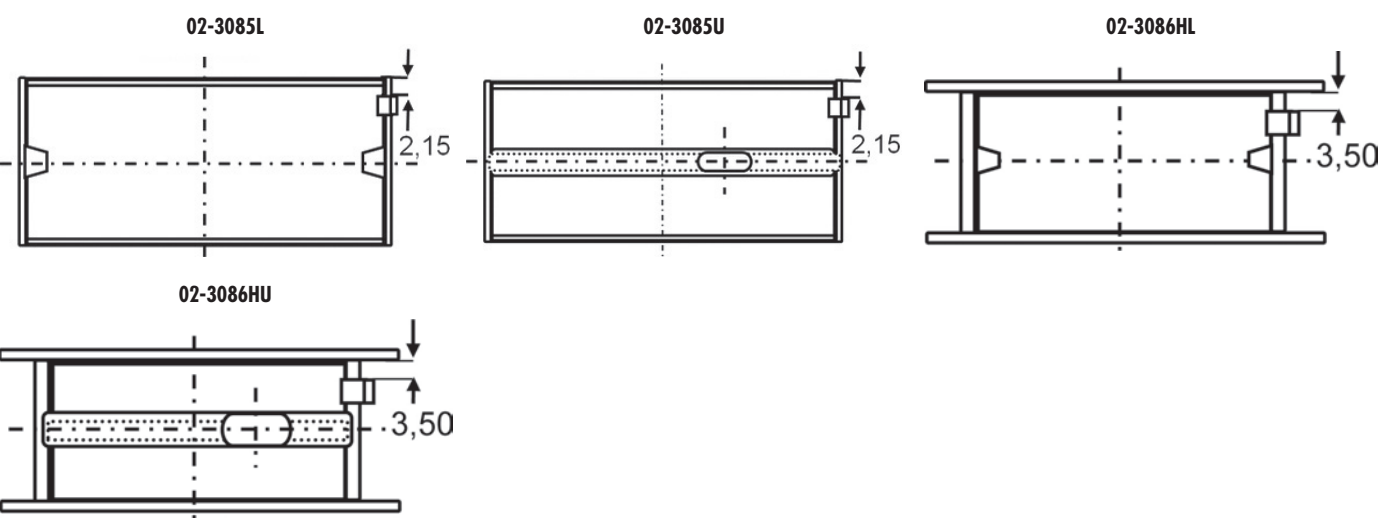

BE/PL	1	45.950/45.970	49.000/49.016	19.000	1.506	0.020/0.078	EC	71-3084	71-3084 STD 0.25 0.50
Mot.→81D250000									
BE/PL	4	47.758/47.778	50.600/50.612	19.000	1.406	0.020/0.067	EC	71-3694	71-3694/4 STD 0.25 0.50
Mot.81E000001→									





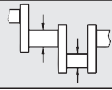
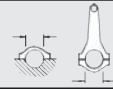

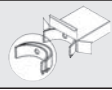
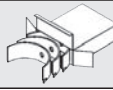

MB/HL	3	53.958/53.978	59.000/59.019	18.500	2.502	0.020/0.082	AL-LF	02-3085L	H025/5 STD 0.25 0.50
MB/HL	5	53.958/53.978	59.000/59.019	18.500	2.502	0.020/0.082	AL-LF	02-3085U	
MB/HL	1	53.958/53.978	59.000/59.019	24.930	2.502	0.020/0.082	AL-LF	02-3086HL	
MB/HL	1	53.958/53.978	59.000/59.019	24.930	2.502	0.020/0.082	AL-LF	02-3086HU	
MB/HL	4	53.958/53.978	59.000/59.019	18.500	2.502	0.020/0.082	AL-LF	02-3085L	H027/5 STD 0.25 0.50
MB/HL	6	53.958/53.978	59.000/59.019	18.500	2.502	0.020/0.082	AL-LF	02-3085U	



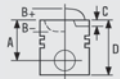





...Continued

724		 75.00	Petrol							
										
TW/A	2	59.500	73.200		1.975		AL-LF	04-3527	A123/4 STD	
TW/A	2	59.500	73.200		1.975		AL-LF	04-3528		
SE/PB	1	20.000	23.000/23.052	25.000			BC	55-3567	55-3567 SEMI	
01/83 →										
CB/NWB 1-5	5	25.939/25.960	28.250/28.271	17.000	1.138		AL-LF	03-3317	N118/5 STD [67]	
BU	1	42.959/42.975	46.055/46.095	15.000			AL-LF	07-3088	07-3088 STD SEMI [68]	
BU	1	41.959/41.975	45.000/45.025	15.000			AL-LF	07-3089	07-3089 STD SEMI [68]	

725		 75.00	Petrol							
ZA	4 Cyl.	8.5:1	1297cc	40kW (54)PS		TD4214	42			
ZA	4 Cyl.	8.5:1	1297cc	40kW (54)PS		TD5036	42			
ZF	4 Cyl.	8.5:1	1297cc	44kW (60)PS		TD368	43			
ZF	4 Cyl.	8.5:1	1297cc	44kW (60)PS		TD5140	43			
80	05/72 → 07/78	PASSAT		05/73 → 01/78						

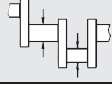
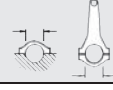
		
	08-108800-00 STD 08-108807-00 0.50mm 2.00  CR P 2.50  P 4.00  CR[52]	

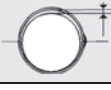
[52] Steel [52] Stahl

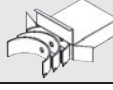
									
BE/PL	1	45.950/45.970	49.000/49.016	19.000	1.506	0.020/0.078	EC	71-3084	71-3084 STD 0.25 0.50
MB/HL	3	53.958/53.978	59.000/59.019	18.500	2.502	0.020/0.082	AL-LF	02-3085L	H025/5 STD 0.25 0.50
MB/HL	5	53.958/53.978	59.000/59.019	18.500	2.502	0.020/0.082	AL-LF	02-3085U	
MB/HL	1	53.958/53.978	59.000/59.019	24.930	2.502	0.020/0.082	AL-LF	02-3086HL	
MB/HL	1	53.958/53.978	59.000/59.019	24.930	2.502	0.020/0.082	AL-LF	02-3086HU	
CB/NWB 1-5	5	25.939/25.960	28.250/28.271	17.000	1.138		AL-LF	03-3317	N118/5 STD [67]
BU	1	42.959/42.975	46.055/46.095	15.000			AL-LF	07-3088	07-3088 STD SEMI [68]
BU	1	41.959/41.975	45.000/45.025	15.000			AL-LF	07-3089	07-3089 STD SEMI [68]

726	75.00	Diesel	
1W	4 Cyl.	22.5:1	1398cc 35kW (47)PS TD4959 45
1W	4 Cyl.	22.5:1	1398cc 35kW (47)PS TD9402 45
POLO	08/90→09/94	TERRA	10/90→12/95

	08-991300-00 STD 08-991307-00 0.50mm 1.75 CR P 2.00 CR P 3.00 CR P	14-025070-00 D B 78.00 C 133.00 D 81.00 E 4.50



BE/PL	4	41.965/41.980	45.000/45.016	18.000	1.505	0.020/0.066	EC	71-3276	71-3276/4 STD 0.25 0.50
MB/HL 1-5	10	53.958/53.978	59.000/59.019	18.500	2.502	0.020/0.082	AL-LF	02-3085U	H026/5 STD 0.25 0.50
TW/A	2	59.500	73.200		1.975		AL-LF	04-3527	A123/4 STD
TW/A	2	59.500	73.200		1.975		AL-LF	04-3528	
SE/PB	1	20.000	23.000/23.025	24.000			BC	55-3277	55-3277 SEMI
BU	1	42.959/42.975	46.055/46.095	15.000			AL-LF	07-3088	07-3088 STD SEMI [68]
BU	1	41.959/41.975	45.000/45.025	15.000			AL-LF	07-3089	07-3089 STD SEMI [68]









727	75.50	Petrol	
AMG	4 Cyl.	1289cc	40kW (54)PS TD13828 46
FELICIA	10/94→06/01		

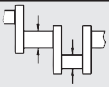

	08-962600-00 STD 1.50 CR P 1.50 P 3.00 CR[52]	





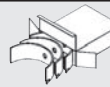



[52] Steel [52] Stahl

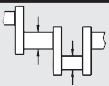

BE/PL	4	44.975/44.991	48.000/48.011	22.000	1.490	0.029/0.081	AL-LF	4645RA	01-4259/4 STD





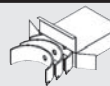

728	 75.50	Petrol				
AMH	4 Cyl.	9.7:1	1289cc	50kW (68)PS	TD13829	47
AMJ	4 Cyl.		1289cc	43kW (58)PS	TD13849	48
OHC	4 Cyl.		1289cc	40-45kW (55-61)PS	TD4902	49
FAVORIT	08/91→06/95		FELICIA	10/94→04/02		



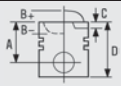





									
BE/PL	4	44.975/44.991	48.000/48.011	22.000	1.490	0.029/0.081	AL-LF	4645RA	01-4259/4 STD

729	 75.50	Petrol				
CDGA	4 Cyl.		1390cc	110kW (150)PS	TD22222	50
PASSAT	01/09→		TOURAN	05/09→		

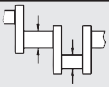
									
BE/PL	4	47.763/47.778	50.600/50.612	17.200	1.406	0.023/0.071	AL-LF	01-4100	01-4100/4 STD

730	 76.50	Diesel				
ANY	3 Cyl.	19.5:1	1191cc	45kW (61)PS	TD12029	54
ANY	3 Cyl.	19.5:1	1191cc	45kW (61)PS	TD17157	54
AYZ	3 Cyl.	19.5:1	1191cc	45kW (61)PS	TD15494	55
A2	03/01→08/05		LUPO	07/99→07/05		

		
	08-120100-00 STD 08-120107-00 0.50mm 1.75  CK P 2.00  P 3.00  CR P	

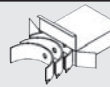
									
BE/PL	1	47.758/47.778	50.600/50.612	20.000	1.406	0.020/0.067	SP	71-3904	71-3904 STD 0.25 0.50 [64]
CB/NWB 1-4	4	28.947/28.960	32.000/32.025	25.000	1.513	0.020/0.068	EC	73-3903	N147/4 STD
BU	1	31.984/32.000	35.000/35.025	22.000			AL-LF	07-4037	07-4037 SEMI
BU	1	41.984/42.000	45.000/45.025	22.000			AL-LF	07-4038	07-4038 SEMI

731	76.50	Petrol							
ADX	4 Cyl.	10:1	1296cc	40kW (54)PS		TD4017		64	
POLO	10/94 → 07/95								

	08-103100-00 STD 1.20 NT[52] 1.50 P 2.50 P	
	08-502800-00 STD 08-502807-00 0.50mm 1.20 NT[52] 1.50 P 2.50 CR[52]	

[52] Steel [52] Stahl

BE/PL	4	47.763/47.778	50.600/50.612	18.500	1.406	0.020/0.062	AL-LF	01-3867	01-3867/4 STD 0.25	
MB/HL 1-5	10	53.958/53.978	59.000/59.019	18.500	2.502	0.020/0.082	AL-LF	02-3085U	H026/5 STD 0.25 0.50	
TW/A	2	59.500	73.200		1.975		AL-LF	04-3527	A123/4 STD	
TW/A	2	59.500	73.200		1.975		AL-LF	04-3528		
BU	1	42.959/42.975	46.055/46.095	15.000			AL-LF	07-3088	07-3088 STD SEMI	[68]
BU	1	41.959/41.975	45.000/45.025	15.000			AL-LF	07-3089	07-3089 STD SEMI	[68]

732	76.50	Petrol							
AEX	4 Cyl.	10.2:1	1390cc	44kW (60)PS		TD4984		65	
AEX	4 Cyl.	10.2:1	1390cc	44kW (60)PS		TD5532		65	
AROSA	05/97 → 06/04	CADDY	11/95 → 01/04	CORDOBA		06/94 → 06/99			
GOLF	10/91 → 04/99	IBIZA	09/93 → 08/99	INCA		11/95 → 06/03			
POLO	07/95 → 09/01	VENTO	11/91 → 09/98						

87-502800-00 STD 87-502807-00 [19] 0.50mm A 28.35 C 5.95 D 50.35 17x52	08-502800-00 STD 08-502807-00 0.50mm 1.20 NT[52] 1.50 P 2.50 CR[52]	14-021571-00 D B 79.56 C 142.00 D 82.50 E 4.50 14-028360-00 D [62] B 79.50 C 145.00 D 81.50 E 4.70
08-103100-00 STD 1.20 NT[52] 1.50 P 2.50 P		

[19] A = 28.100, D = 50.100

[19] A = 28.100, D = 50.100

[52] Steel







[52] Stahl

[62] With recesses on crankshaft side

[62] Mit kurbelwellenseitigen Aussparungen

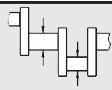
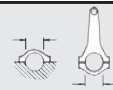
...Continued

732  **76.50** **Petrol**

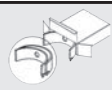
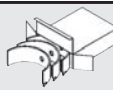
									
BE/PL	4	47.763/47.778	50.600/50.612	18.500	1.406	0.020/0.062	AL-LF	01-3867	01-3867/4 STD 0.25
BE/PL	4	47.763/47.778	50.600/50.612	17.200	1.406	0.023/0.071	AL-LF	01-4100	01-4100/4 STD

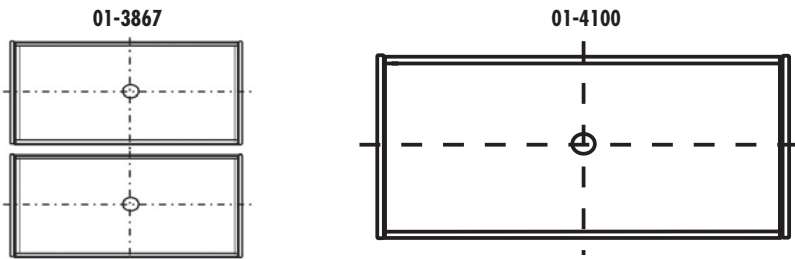





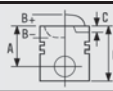
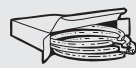

MB/HL 1-5	10	53.958/53.978	59.000/59.019	18.500	2.502	0.020/0.082	AL-LF	02-3085U	H026/5 STD 0.25 0.50
TW/A	2	59.500	73.200		1.975		AL-LF	04-3527	A123/4 STD
TW/A	2	59.500	73.200		1.975		AL-LF	04-3528	
BU	1	42.959/42.975	46.055/46.095	15.000			AL-LF	07-3088	07-3088 STD SEMI [68]
BU	1	41.959/41.975	45.000/45.025	15.000			AL-LF	07-3089	07-3089 STD SEMI [68]

733  **76.50** **Petrol**









AFH	4 Cyl.	10.5:1	1390cc	74kW (100)PS	TD4986	66
AFH	4 Cyl.	10.5:1	1390cc	74kW (100)PS	TD5534	66

CORDOBA 09/96→06/99 **IBIZA** 06/97→08/99 **POLO** 04/96→10/99

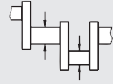
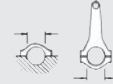
		
87-116100-00 STD 87-116107-00 [20] 0.50mm	08-116100-00 STD 08-116107-00 0.50mm	
A 28.92 B- 1.98 BØ 61.90 C 2.32 D 49.92  17x54	1.20  NT[52] 1.50  P 2.50  CR[52]	

[20] A = 28.670, D = 49.670 [20] A = 28.670, D = 49.670
[52] Steel [52] Stahl

733  **76.50** **Petrol**

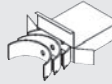
									
BE/PL	4	47.763/47.778	50.600/50.612	18.500	1.406	0.020/0.062	AL-LF	01-3867	01-3867/4 STD 0.25
BE/PL	4	47.758/47.778	50.600/50.612	20.000	1.406	0.020/0.067	SP	71-3847	71-3847/4 STD 0.25

[64]

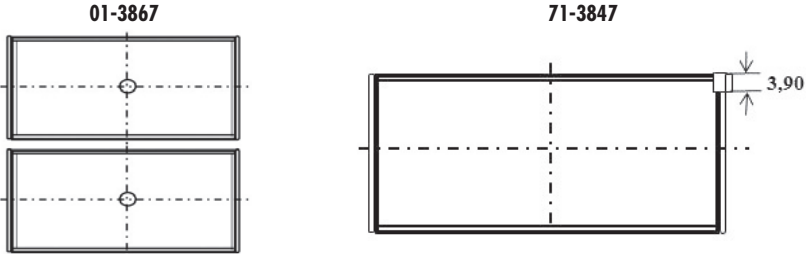

MB/HL 1-5	5	53.958/53.978	59.000/59.019	18.500	2.502	0.020/0.082	AL-LF	02-3085L	H084/5 STD 0.25 0.50
MB/HL 1-5	5	53.958/53.978	59.000/59.019	18.500	2.502	0.020/0.082	AL-LF	02-3085U	

Mot. → AFH030000

MB/HL 1-5	5	53.963/53.978	59.007/59.019	17.000	2.512	0.027/0.046	AL-LF	02-4929	H1325/5 STD 0.25 0.50
--------------	---	---------------	---------------	--------	-------	-------------	-------	---------	---------------------------------

Mot. AFH030001 →

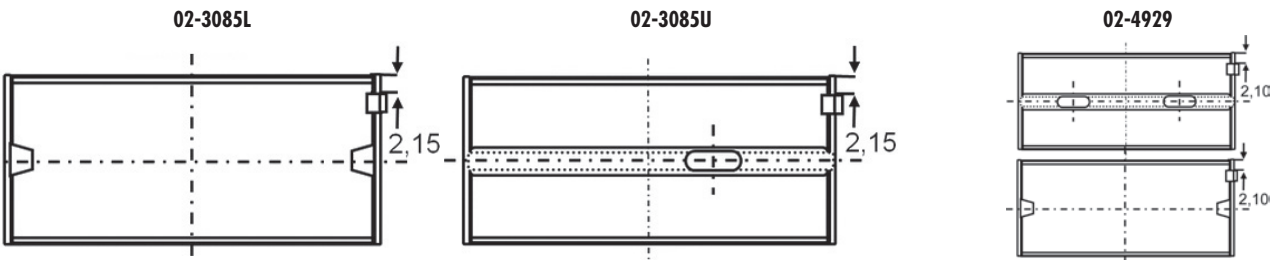



TW/A	2	59.500	73.200		1.975		AL-LF	04-3527	A123/4 STD
TW/A	2	59.500	73.200		1.975		AL-LF	04-3528	

734	76.50	Petrol				
AFK	4 Cyl.	10.5:1	1390cc	74kW (100)PS	TD12028	67
AFK	4 Cyl.	10.5:1	1390cc	74kW (100)PS	TD13893	67
AKQ	4 Cyl.	10.5:1	1390cc	55kW (75)PS	TD9454	70
AXP	4 Cyl.	10.5:1	1390cc	55kW (75)PS	TD15474	79
AXP	4 Cyl.	10.5:1	1390cc	55kW (75)PS	TD16050	79
AXP	4 Cyl.	10.5:1	1390cc	55kW (75)PS	TD16134	79
AROSA	01/00→06/04	BORA	03/00→05/05	GOLF	08/97→06/06	
LEON	11/99→06/06	LUPO	09/98→07/05	OCTAVIA	08/00→12/10	
POLO	10/99→09/01	TOLEDO	07/99→05/06			







87-116100-00 STD	87-116107-00 [20] 0.50mm	08-116100-00 STD	08-116107-00 0.50mm							
A 28.92	B- 1.98	BØ 61.90	C 2.32	D 49.92						
17x54										



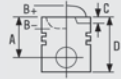
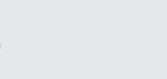

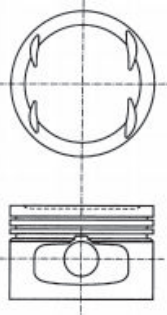
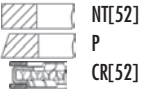



[20] A = 28.670, D = 49.670 [20] A = 28.670, D = 49.670
 [52] Steel [52] Stahl

BE/PL	4	47.763/47.778	50.600/50.612	18.500	1.406	0.020/0.062	AL-LF	01-3867	01-3867/4 STD 0.25	
MB/HL 1-5	5	53.963/53.978	59.007/59.019	17.000	2.512	0.027/0.046	AL-LF	02-4929	H1325/5 STD 0.25 0.50	
TW/A	2	59.500	73.200		1.975		AL-LF	04-3527	A123/4 STD	
TW/A	2	59.500	73.200		1.975		AL-LF	04-3528		
BU	1	42.959/42.975	46.055/46.095	15.000			AL-LF	07-3088	07-3088 STD SEMI	[68]
BU	1	41.959/41.975	45.000/45.025	15.000			AL-LF	07-3089	07-3089 STD SEMI	[68]

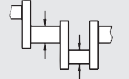
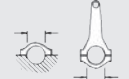





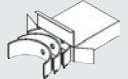
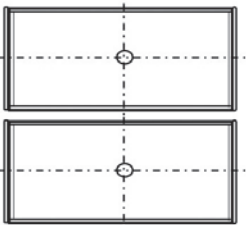
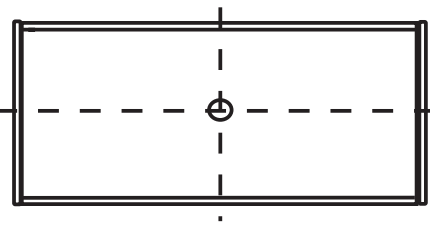

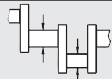

735	 76.50	Petrol			
AHW	4 Cyl.	10.5:1	1390cc	55kW (75)PS	TD9453 67
AHW	4 Cyl.	10.5:1	1390cc	55kW (75)PS	TD15529 67
APE	4 Cyl.	10.5:1	1390cc	55kW (75)PS	TD13268 67
APE	4 Cyl.	10.5:1	1390cc	55kW (75)PS	TD13468 67
AQQ	4 Cyl.	10.5:1	1390cc	74kW (100)PS	TD13469 67
AQQ	4 Cyl.	10.5:1	1390cc	74kW (100)PS	TD15528 67
AUA	4 Cyl.	10.5:1	1390cc	55kW (75)PS	TD13771 77
AUA	4 Cyl.	10.5:1	1390cc	55kW (75)PS	TD15248 77
AUA	4 Cyl.	10.5:1	1390cc	55kW (75)PS	TD15374 77
AUA	4 Cyl.	10.5:1	1390cc	55kW (75)PS	TD16197 77
AUB	4 Cyl.	10.5:1	1390cc	74kW (100)PS	TD13772 67
AUB	4 Cyl.	10.5:1	1390cc	74kW (100)PS	TD15375 67
AUB	4 Cyl.	10.5:1	1390cc	74kW (100)PS	TD16140 67
BBY	4 Cyl.	10.5:1	1390cc	55kW (75)PS	TD16335 77
BBY	4 Cyl.	10.5:1	1390cc	55kW (75)PS	TD16414 77
BBY	4 Cyl.	10.5:1	1390cc	55kW (75)PS	TD16460 77
BBY	4 Cyl.	10.5:1	1390cc	55kW (75)PS	TD17471 77
BBZ	4 Cyl.	10.5:1	1390cc	74kW (100)PS	TD16540 67
BBZ	4 Cyl.	10.5:1	1390cc	74kW (100)PS	TD16541 67
BBZ	4 Cyl.	10.5:1	1390cc	74kW (100)PS	TD17472 67

A2	02/00→08/05	AROSA	01/00→06/04	BORA	03/00→05/05
CADDY	08/00→01/04	CORDOBA	06/99→11/09	FABIA	10/99→03/08
GOLF	08/97→06/06	IBIZA	08/99→11/09	INCA	04/00→06/03
LEON	11/99→06/06	LUPO	09/98→07/05	POLO	10/99→
TOLEDO	07/99→05/06				







			
87-116100-00 STD 87-116107-00 [20] 0.50mm		08-116100-00 STD 08-116107-00 0.50mm	
A 28.92 B- 1.98 BØ 61.90 C 2.32 D 49.92  17x54		1.20  NT[52] 1.50  P 2.50  CR[52]	
[20] A = 28.670, D = 49.670 [52] Steel	[20] A = 28.670, D = 49.670 [52] Stahl		

									
BE/PL	4	47.763/47.778	50.600/50.612	18.500	1.406	0.020/0.062	AL-LF	01-3867	01-3867/4 STD 0.25
BE/PL	4	47.763/47.778	50.600/50.612	17.200	1.406	0.023/0.071	AL-LF	01-4100	01-4100/4 STD
01-3867					01-4100				
									

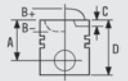







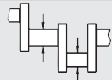
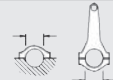

...Continued

735		 76.50	Petrol							
										
MB/HL 1-5	5	53.963/53.978	59.007/59.019	17.000	2.512	0.027/0.046	AL-LF	02-4929	H1325/5 STD 0.25 0.50	
TW/A	2	59.500	73.200		1.975		AL-LF	04-3527	A123/4 STD	
TW/A	2	59.500	73.200		1.975		AL-LF	04-3528		
BU	1	42.959/42.975	46.055/46.095	15.000			AL-LF	07-3088	07-3088 STD SEMI	[68]
BU	1	41.959/41.975	45.000/45.025	15.000			AL-LF	07-3089	07-3089 STD SEMI	[68]

736		 76.50	Petrol							
AKK	4 Cyl.	10.2:1	1390cc	44kW (60)PS	TD13768	68				
AKK	4 Cyl.	10.2:1	1390cc	44kW (60)PS	TD13892	68				
AUD	4 Cyl.	10.5:1	1390cc	44kW (60)PS	TD13770	78				
AUD	4 Cyl.	10.5:1	1390cc	44kW (60)PS	TD16139	78				
AROSA	05/97→06/04	CADDY	11/95→01/04	CORDOBA	06/99→12/02					
IBIZA	08/99→02/02	INCA	11/95→06/03	LUPO	10/00→07/05					
POLO	12/95→09/01									

		
	08-116100-00 STD 08-116107-00 0.50mm 1.20  NT[52] 1.50  P 2.50  CR[52]	

[52] Steel [52] Stahl

										
BE/PL	4	47.763/47.778	50.600/50.612	18.500	1.406	0.020/0.062	AL-LF	01-3867	01-3867/4 STD 0.25	
BE/PL	4	47.763/47.778	50.600/50.612	17.200	1.406	0.023/0.071	AL-LF	01-4100	01-4100/4 STD	

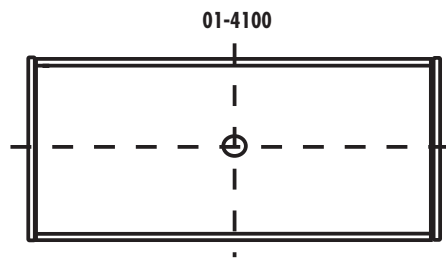
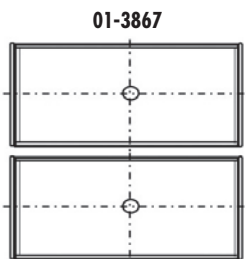

MB/HL 1-5	5	53.963/53.978	59.007/59.019	17.000	2.512	0.027/0.046	AL-LF	02-4929	H1325/5 STD 0.25 0.50	
TW/A	2	59.500	73.200		1.975		AL-LF	04-3527	A123/4 STD	
TW/A	2	59.500	73.200		1.975		AL-LF	04-3528		
BU	1	42.959/42.975	46.055/46.095	15.000			AL-LF	07-3088	07-3088 STD SEMI	[68]
BU	1	41.959/41.975	45.000/45.025	15.000			AL-LF	07-3089	07-3089 STD SEMI	[68]

737	76.50	Petrol	
AKP	4 Cyl.	1390cc	40kW (54)PS
POLO	12/98 → 09/01		TD14168 69

BE/PL	4	47.763/47.778	50.600/50.612	18.500	1.406	0.020/0.062	AL-LF	01-3867	01-3867/4 STD 0.25
MB/HL 1-5	5	53.963/53.978	59.007/59.019	17.000	2.512	0.027/0.046	AL-LF	02-4929	H1325/5 STD 0.25 0.50
TW/A	2	59.500	73.200		1.975		AL-LF	04-3527	A123/4 STD
TW/A	2	59.500	73.200		1.975		AL-LF	04-3528	
BU	1	42.959/42.975	46.055/46.095	15.000			AL-LF	07-3088	07-3088 STD SEMI [68]
BU	1	41.959/41.975	45.000/45.025	15.000			AL-LF	07-3089	07-3089 STD SEMI [68]

738	76.50	Petrol	
AKV	4 Cyl.	10.2:1	1390cc
AKV	4 Cyl.	10.2:1	1390cc
ANX	4 Cyl.	10.2:1	1390cc
ANX	4 Cyl.	10.2:1	1390cc
APQ	4 Cyl.	10.2:1	1390cc
APQ	4 Cyl.	10.2:1	1390cc
AROSA	05/97 → 06/04	CADDY	11/95 → 01/04
GOLF	07/93 → 04/99	IBIZA	09/93 → 08/99
POLO	07/95 → 09/01	CORDOBA	06/94 → 06/99
		INCA	11/95 → 06/03

87-502800-00 STD	08-502800-00 STD	14-021571-00 D B 79.56 C 142.00 D 82.50 E 4.50
87-502807-00 [19] 0.50mm	08-502807-00 0.50mm	14-028360-00 D [62] B 79.50 C 145.00 D 81.50 E 4.70
A 28.35	1.20 NT[52]	
C 5.95	1.50 P	
D 50.35	2.50 CR[52]	
17x52	08-103100-00 STD	
	1.20 NT[52]	
	1.50 P	
	2.50 P	

[19] A = 28.100, D = 50.100

[52] Steel

[62] With recesses on crankshaft side







[19] A = 28.100, D = 50.100

[52] Stahl

[62] Mit kurbelwellenseitigen Aussparungen

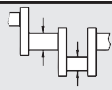
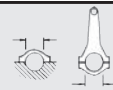
...Continued

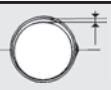
738  **76.50** **Petrol**

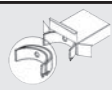
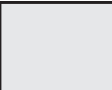
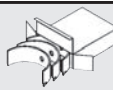
										
BE/PL	4	47.763/47.778	50.600/50.612	18.500	1.406	0.020/0.062	AL-LF	01-3867	01-3867/4 STD 0.25	
BE/PL	4	47.763/47.778	50.600/50.612	17.200	1.406	0.023/0.071	AL-LF	01-4100	01-4100/4 STD	

01-3867

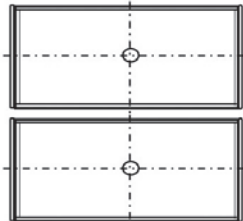

01-4100

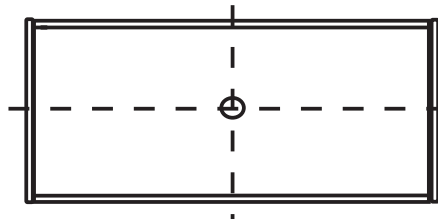

MB/HL 1-5	10	53.958/53.978	59.000/59.019	18.500	2.502	0.020/0.082	AL-LF	02-3085U	H026/5 STD 0.25 0.50
MB/HL 1-5	5	53.963/53.978	59.007/59.019	17.000	2.512	0.027/0.046	AL-LF	02-4929	H1325/5 STD 0.25 0.50

02-3085U

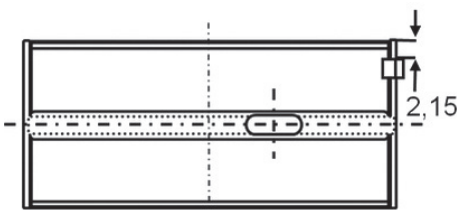



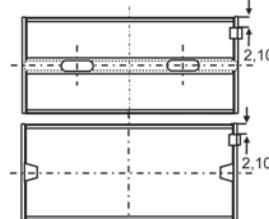



02-4929

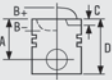

TW/A	2	59.500	73.200		1.975		AL-LF	04-3527	A123/4 STD	
TW/A	2	59.500	73.200		1.975		AL-LF	04-3528		
BU	1	42.959/42.975	46.055/46.095	15.000			AL-LF	07-3088	07-3088 STD SEMI	[68]
BU	1	41.959/41.975	45.000/45.025	15.000			AL-LF	07-3089	07-3089 STD SEMI	[68]







739  **76.50** **Petrol**

ANM	4 Cyl.	10.5:1	1390cc	74kW (100)PS	TD13470	72
ANM	4 Cyl.	10.5:1	1390cc	74kW (100)PS	TD13894	72



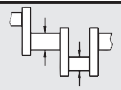
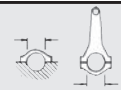

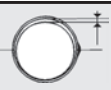

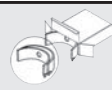
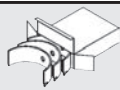
		
	<p>08-116100-00 STD</p> <p>08-116107-00 0.50mm</p> <p>1.20  NT[52]</p> <p>1.50  P</p> <p>2.50  CR[52]</p>	

[52] Steel

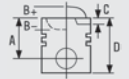





[52] Stahl

739		 76.50	Petrol							
										
BE/PL	4	47.763/47.778	50.600/50.612	18.500	1.406	0.020/0.062	AL-LF	01-3867	01-3867/4 STD 0.25	
BU	1	42.959/42.975	46.055/46.095	15.000			AL-LF	07-3088	07-3088 STD SEMI	[68]
BU	1	41.959/41.975	45.000/45.025	15.000			AL-LF	07-3089	07-3089 STD SEMI	[68]



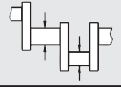
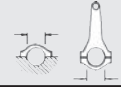

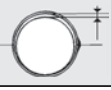

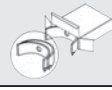
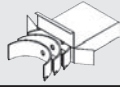
740		 76.50	Petrol								
ANW	4 Cyl.	10.2:1	1390cc	44kW (60)PS						TD13274	73
ANW	4 Cyl.	10.2:1	1390cc	44kW (60)PS						TD15568	73
AROSA	05/97→06/04		CORDOBA	06/99→12/02			IBIZA		08/99→02/02		
POLO	12/95→09/01										



		
	08-116100-00 STD 08-116107-00 0.50mm 1.20  NT[52] 1.50  P 2.50  CR[52]	

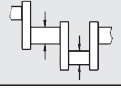
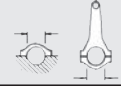

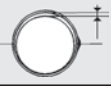

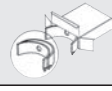
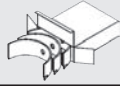



[52] Steel [52] Stahl

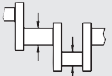
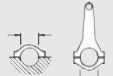

										
BE/PL	4	47.763/47.778	50.600/50.612	17.200	1.406	0.023/0.071	AL-LF	01-4100	01-4100/4 STD	





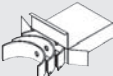

741		 76.50	Petrol								
ARR	4 Cyl.	11.5:1	1390cc	77kW (105)PS						TD15492	76
LUPO	02/01→07/05										



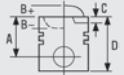







										
BE/PL	4	47.763/47.778	50.600/50.612	18.500	1.406	0.020/0.062	AL-LF	01-3867	01-3867/4 STD 0.25	
BU	1	42.959/42.975	46.055/46.095	15.000			AL-LF	07-3088	07-3088 STD SEMI	[68]
BU	1	41.959/41.975	45.000/45.025	15.000			AL-LF	07-3089	07-3089 STD SEMI	[68]

742	 76.50	Petrol	
AXU	4 Cyl.	1390cc	63kW (85)PS
POLO	02/02→07/06		TD16430 80

									
BE/PL	4	47.763/47.778	50.600/50.612	17.200	1.406	0.023/0.071	AL-LF	01-4100	01-4100/4 STD
MB/HL 1-5	10	53.958/53.978	59.000/59.019	18.500	2.502	0.020/0.082	AL-LF	02-3085U	H026/5 STD 0.25 0.50
TW/A	2	59.500	73.200		1.975		AL-LF	04-3527	A123/4 STD
TW/A	2	59.500	73.200		1.975		AL-LF	04-3528	
BU	1	42.959/42.975	46.055/46.095	15.000			AL-LF	07-3088	07-3088 STD SEMI [68]
BU	1	41.959/41.975	45.000/45.025	15.000			AL-LF	07-3089	07-3089 STD SEMI [68]

743	 76.50	Petrol	
BCA	4 Cyl.	10.5:1	1390cc
BCA	4 Cyl.	10.5:1	1390cc
BCA	4 Cyl.	10.5:1	1390cc
BORA	03/00→05/05	CADDY	03/04→05/06
LEON	11/99→06/06	NEW BEETLE	11/01→
TOLEDO	07/99→05/06	GOLF	08/97→
		OCTAVIA	08/00→12/10

		
87-116100-00 STD	08-116100-00 STD	
87-116107-00 [20] 0.50mm	08-116107-00 0.50mm	
A 28.92	1.20  NT[52]	
B- 1.98	1.50  P	
BØ 61.90	2.50  CR[52]	
C 2.32		
D 49.92		
 17x54		
[20] A = 28.670, D = 49.670	[20] A = 28.670, D = 49.670	
[52] Steel	[52] Stahl	

									
BE/PL	4	47.763/47.778	50.600/50.612	17.200	1.406	0.023/0.071	AL-LF	01-4100	01-4100/4 STD
MB/HL 1-5	5	53.963/53.978	59.007/59.019	17.000	2.512	0.027/0.046	AL-LF	02-4929	H1325/5 STD 0.25 0.50
TW/A	2	59.500	73.200		1.975		AL-LF	04-3527	A123/4 STD
TW/A	2	59.500	73.200		1.975		AL-LF	04-3528	
BU	1	42.959/42.975	46.055/46.095	15.000			AL-LF	07-3088	07-3088 STD SEMI [68]
BU	1	41.959/41.975	45.000/45.025	15.000			AL-LF	07-3089	07-3089 STD SEMI [68]

744	76.50	Petrol				
BKR	4 Cyl.	10.5:1	1390cc	55kW (75)PS	TD18271	83
FOX	04/05→					







87-436900-00 STD A 28.92 B- 2.28 BØ 61.14 C 1.07 C 1.04 D 46.92 17x45 TP ECOTOUGH [52] Steel [52] Stahl	08-436900-00 STD 1.20 NT[52] 1.20 P 2.00 CR[52] 	
07675-204		

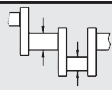
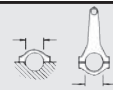

BE/PL	4	47.763/47.778	50.600/50.612	18.500	1.406	0.020/0.060	EC	71-3765	71-3765/4 STD 0.25
TW/A	2	59.500	73.200		1.975		AL-LF	04-3527	A123/4 STD
TW/A	2	59.500	73.200		1.975		AL-LF	04-3528	

745	76.50	Petrol						
BKY	4 Cyl.	10.5:1	1390cc	55kW (75)PS	TD18154	79		
BKY	4 Cyl.	10.5:1	1390cc	55kW (75)PS	TD18696	79		
BKY	4 Cyl.	10.5:1	1390cc	55kW (75)PS	TD18750	79		
CORDOBA	09/02→12/07		FABIA	10/99→03/08		IBIZA	02/02→12/07	
POLO	10/01→							



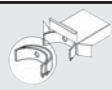
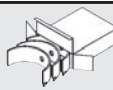
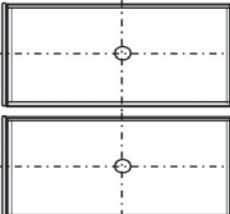
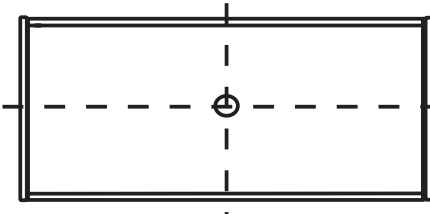



87-436900-00 STD 04/05→ A 28.92 B- 2.28 BØ 61.14 C 1.07 C 1.04 D 46.92 17x45 TP ECOTOUGH [52] Steel [52] Stahl	08-436900-00 STD 1.20 NT[52] 1.20 P 2.00 CR[52] 	
07675-204		

...Continued

745		 76.50	Petrol							
										
BE/PL	4	47.763/47.778	50.600/50.612	18.500	1.406	0.020/0.062	AL-LF	01-3867	01-3867/4 STD 0.25	
BE/PL	4	47.763/47.778	50.600/50.612	17.200	1.406	0.023/0.071	AL-LF	01-4100	01-4100/4 STD	
		01-3867	01-4100							
										
MB/HL 1-5	5	53.963/53.978	59.007/59.019	17.000	2.512	0.027/0.046	AL-LF	02-4929	H1325/5 STD 0.25 0.50	
TW/A	2	59.500	73.200		1.975		AL-LF	04-3527	A123/4 STD	
TW/A	2	59.500	73.200		1.975		AL-LF	04-3528		
BU	1	42.959/42.975	46.055/46.095	15.000			AL-LF	07-3088	07-3088 STD SEMI [68]	
BU	1	41.959/41.975	45.000/45.025	15.000			AL-LF	07-3089	07-3089 STD SEMI [68]	

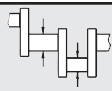
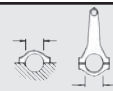
746		 76.50	Petrol							
BLG	4 Cyl.	10:1	1390cc	125kW (170)PS				TD18470	84	
BLN	4 Cyl.	12:1	1390cc	66kW (89)PS				TD18911	85	
BMY	4 Cyl.	10:1	1390cc	103kW (140)PS				TD18910	84	

GOLF	10/03→	JETTA	07/06→10/10	TOURAN	02/06→05/10
-------------	--------	--------------	-------------	---------------	-------------

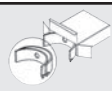
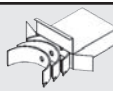
									
BE/PL	4	47.763/47.778	50.600/50.612	17.200	1.406	0.023/0.071	AL-LF	01-4100	01-4100/4 STD
MB/HL 1-5	5	53.963/53.978	59.007/59.019	17.000	2.512	0.027/0.046	AL-LF	02-4929	H1325/5 STD 0.25 0.50
TW/A	2	59.500	73.200		1.975		AL-LF	04-3527	A123/4 STD
TW/A	2	59.500	73.200		1.975		AL-LF	04-3528	
SE/PB	1	19.000	21.000/21.033	20.800			BC-LF	55-4715	55-4715 SEMI [65]

747

76.50

Petrol



BLM 4 Cyl. 1390cc 63kW (85)PS TD21076

POLO 12/03→05/05

87-116100-00 STD 87-116107-00 [20] 0.50mm A 28.92 B- 1.98 BØ 61.90 C 2.32 D 49.92 17x54	08-116100-00 STD 08-116107-00 0.50mm 1.20 NT[52] 1.50 P 2.50 CR[52]	

[20] A = 28.670, D = 49.670

[20] A = 28.670, D = 49.670

[52] Steel

[52] Stahl

BE/PL	4	47.763/47.778	50.600/50.612	17.200	1.406	0.023/0.071	AL-LF	01-4100	01-4100/4 STD
TW/A	2	59.500	73.200		1.975		AL-LF	04-3527	A123/4 STD
TW/A	2	59.500	73.200		1.975		AL-LF	04-3528	

748

76.50

Petrol



BUD 4 Cyl. 10.5:1 1390cc 59kW (80)PS TD18909 **86**

BUD 4 Cyl. 10.5:1 1390cc 59kW (80)PS TD20190 **86**

CADDY 05/06→08/10 FABIA 02/06→12/07 GOLF 05/06→
 OCTAVIA 06/04→ POLO 05/06→11/09







87-436900-00 STD 04/05→ A 28.92 B- 2.28 BØ 61.14 C 1.07 C 1.04 D 46.92 17x45 TP ECOTOUGH [52] Steel	08-436900-00 STD 1.20 NT[52] 1.20 P 2.00 CR[52]	

07675-204

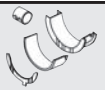
[52] Stahl

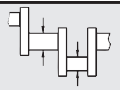
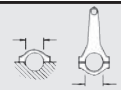
...Continued

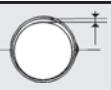
748  **76.50** **Petrol**

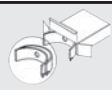
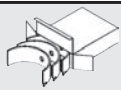
									
BE/PL	4	47.763/47.778	50.600/50.612	18.500	1.406	0.020/0.062	AL-LF	01-3867	01-3867/4 STD 0.25
BE/PL	4	47.763/47.778	50.600/50.612	17.200	1.406	0.023/0.071	AL-LF	01-4100	01-4100/4 STD

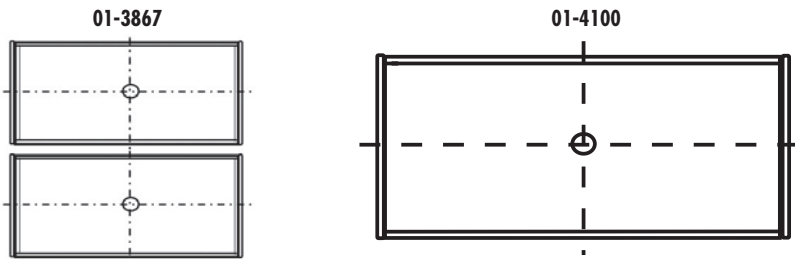









MB/HL 1-5	5	53.963/53.978	59.007/59.019	17.000	2.512	0.027/0.046	AL-LF	02-4929	H1325/5 STD 0.25 0.50
TW/A	2	59.500	73.200		1.975		AL-LF	04-3527	A123/4 STD
TW/A	2	59.500	73.200		1.975		AL-LF	04-3528	
SE/PB	1	19.000	21.000/21.033	20.800			BC-LF	55-4715	55-4715 SEMI

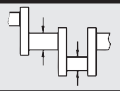
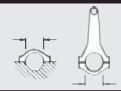

[65]

749  **76.50** **Petrol** 



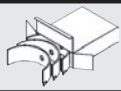



BWK	4 Cyl.		1390cc			110kW (150)PS			TD20734	87
CAVA	4 Cyl.	10:1	1390cc			110kW (150)PS			TD22452	87
CAVA	4 Cyl.	10:1	1390cc			110kW (150)PS			TD24449	87
CAVB	4 Cyl.	10:1	1390cc			125kW (170)PS			TD22173	88
CAVC	4 Cyl.	10:1	1390cc			103kW (140)PS			TD22174	84
CAVD	4 Cyl.	10:1	1390cc			118kW (160)PS			TD20792	88

ALHAMBRA	06/10→	BEETLE	04/11→	EOS	05/08→
GOLF	06/08→	JETTA	07/08→	SCIROCCO	05/08→
SHARAN	05/10→	TIGUAN	09/07→	TOURAN	02/06→

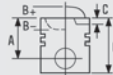



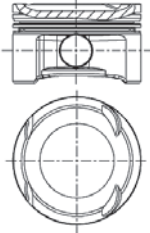



									
BE/PL	4	47.763/47.778	50.600/50.612	17.200	1.406	0.023/0.071	AL-LF	01-4100	01-4100/4 STD

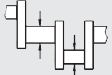
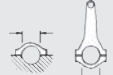

750		 76.50	Petrol			
BXW	4 Cyl.	10.5:1	1390cc	63kW (85)PS	TD19089	79
BXW	4 Cyl.	10.5:1	1390cc	63kW (85)PS	TD19427	79
CGGA	4 Cyl.	10.5:1	1390cc	59kW (80)PS	TD20791	91
CGGA	4 Cyl.	10.5:1	1390cc	59kW (80)PS	TD24838	91
CGGB	4 Cyl.		1390cc	63kW (85)PS	TD23103	79
CGGB	4 Cyl.		1390cc	63kW (85)PS	TD23136	79
CGGB	4 Cyl.		1390cc	63kW (85)PS	TD24980	79

ALTEA	05/06→	ALTEA XL	10/06→	CORDOBA	05/06→11/09
FABIA	01/07→	GOLF	05/06→	IBIZA	05/06→
LEON	06/06→	OCTAVIA	06/04→	POLO	06/09→
ROOMSTER	09/06→	ROOMSTER Praktik	03/07→		



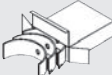





		
87-436900-00 STD	08-436900-00 STD	
04/05→	1.20 NT[52] 1.20 P 2.00 CR[52]	
A 28.92 B- 2.28 BØ 61.14 C 1.07 C 1.04 D 46.92  17x45	 	
TP	07675-204	
ECOTOUGH		

[52] Steel [52] Stahl

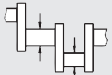
									
BE/PL	4	47.763/47.778	50.600/50.612	17.200	1.406	0.023/0.071	AL-LF	01-4100	01-4100/4 STD

751		 76.50	Petrol			
CAVE	4 Cyl.	10:1	1390cc	132kW (180)PS	TD23095	87
CAVE	4 Cyl.	10:1	1390cc	132kW (180)PS	TD24000	87
CAVE	4 Cyl.	10:1	1390cc	132kW (180)PS	TD24217	87
CAVF	4 Cyl.		1390cc	110kW (150)PS	TD23096	89
CNVA	4 Cyl.	10:1	1390cc	90kW (122)PS	TD24951	
CNWA	4 Cyl.		1390cc	118kW (160)PS	TD24834	

A1	05/10→	BEETLE	04/11→	FABIA	05/10→
GOLF	06/08→	IBIZA	06/09→	POLO	05/10→
SCIROCCO	05/08→				

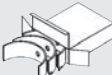
									
BE/PL	4	47.763/47.778	50.600/50.612	17.200	1.406	0.023/0.071	AL-LF	01-4100	01-4100/4 STD
TW/A	2	59.500	73.200		1.975		AL-LF	04-3527	A123/4 STD
TW/A	2	59.500	73.200		1.975		AL-LF	04-3528	

752

76.50

Petrol



CAXA	4 Cyl.	10:1	1390cc	90kW (122)PS	TD20606	87
CAXA	4 Cyl.	10:1	1390cc	90kW (122)PS	TD21592	87
CAXA	4 Cyl.	10:1	1390cc	90kW (122)PS	TD24386	87
CAXA	4 Cyl.	10:1	1390cc	90kW (122)PS	TD27223	87
CAXC	4 Cyl.	9.7:1	1390cc	92kW (125)PS	TD20488	84
CAXC	4 Cyl.	9.7:1	1390cc	92kW (125)PS	TD20715	84
CAXC	4 Cyl.	9.7:1	1390cc	92kW (125)PS	TD22677	84



A1	05/10→	A3	09/07→	ALTEA	11/07→
ALTEA XL	11/07→	EOS	11/07→	GOLF	05/07→
JETTA	05/07→	LEON	11/07→	OCTAVIA	11/08→
PASSAT	05/07→	RAPID	07/12→	SCIROCCO	08/08→
SUPERB	07/08→	TIGUAN	08/10→	TOLEDO	07/12→
YETI	06/10→				







<p>87-429900-00 STD</p> <p>87-429907-00 0.50mm</p> <p>A 29.20</p> <p>B- 4.50</p> <p>C 3.60</p> <p>D 48.20</p> <p> 19x52</p> <p>HA</p>	<p>08-429900-00 STD</p> <p>1.20 NT[52]</p> <p>1.20 P</p> <p>2.00 NT[52]</p>	



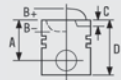



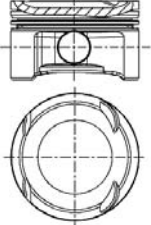

[52] Steel

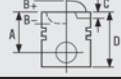

[52] Stahl





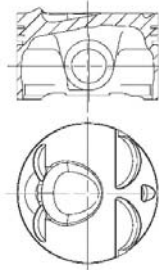





BE/PL	4	47.763/47.778	50.600/50.612	17.200	1.406	0.023/0.071	AL-LF	01-4100	01-4100/4 STD
TW/A	2	59.500	73.200		1.975		AL-LF	04-3527	A123/4 STD
TW/A	2	59.500	73.200		1.975		AL-LF	04-3528	

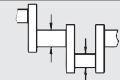

753	 76.50	Petrol			
CDDA	4 Cyl.	1390cc	63kW (85)PS	TD25789	90
CDDA	4 Cyl.	1390cc	63kW (85)PS	TD26495	90
CLPA	4 Cyl.	1390cc	63kW (85)PS	TD25868	92
CLPA	4 Cyl.	1390cc	63kW (85)PS	TD26336	92
CLPA	4 Cyl.	1390cc	63kW (85)PS	TD26496	92
POLO	06/09 →				

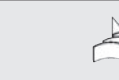

		
87-436900-00 STD 04/05 → A 28.92 B- 2.28 BØ 61.14 C 1.07 D 46.92  17x45 TP ECOTOUGH [52] Steel	08-436900-00 STD 1.20  NT[52] 1.20  P 2.00  CR[52]  07675-204 [52] Stahl	

754	 76.50	Petrol			
CMSA	4 Cyl.	1390cc	92kW (125)PS	TD23936	84
A3	09/07 →				
					
87-429900-00 STD 87-429907-00 0.50mm A 29.20 B- 4.50 C 3.60 D 48.20  19x52 HA [52] Steel	08-429900-00 STD 1.20  NT[52] 1.20  P 2.00  NT[52]  [52] Stahl				

755		 76.50	Petrol			
FB	4 Cyl.	8.2:1	1470cc	55kW (75)PS	TD4077	93
FD	4 Cyl.	9.7:1	1470cc	63kW (85)PS	TD3584	94
FD	4 Cyl.	9.7:1	1470cc	63kW (85)PS	TD21346	94
FF	4 Cyl.	7.5:1	1471cc	48kW (65)PS	TD4078	95
FH	4 Cyl.	9.7:1	1471cc	51kW (70)PS	TD4080	96
FK	4 Cyl.		1471cc	48kW (65)PS	TD4083	
XW	4 Cyl.		1471cc	57kW (77)PS	TD350	
GOLF		04/74→12/75	SCIROCCO		02/74→12/75	

										
BE/PL	1	45.950/45.970	49.000/49.016	19.000	1.506	0.020/0.078	EC	71-3084	71-3084 STD 0.25 0.50	
MB/HL	3	53.958/53.978	59.000/59.019	18.500	2.502	0.020/0.082	AL-LF	02-3085L	H025/5 STD 0.25 0.50	
MB/HL	5	53.958/53.978	59.000/59.019	18.500	2.502	0.020/0.082	AL-LF	02-3085U		
MB/HL	1	53.958/53.978	59.000/59.019	24.930	2.502	0.020/0.082	AL-LF	02-3086HL		
MB/HL	1	53.958/53.978	59.000/59.019	24.930	2.502	0.020/0.082	AL-LF	02-3086HU		
CB/NWB 1-5	5	25.939/25.960	28.250/28.271	17.000	1.138		AL-LF	03-3317	N118/5 STD	[67]
BU	1	42.959/42.975	46.055/46.095	15.000			AL-LF	07-3088	07-3088 STD SEMI	[68]
BU	1	41.959/41.975	45.000/45.025	15.000			AL-LF	07-3089	07-3089 STD SEMI	[68]

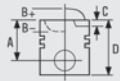
756		 76.50	Petrol			
YJ	4 Cyl.	8.2:1	1471cc	55kW (75)PS	TD4213	93
YJ	4 Cyl.	8.2:1	1471cc	55kW (75)PS	TD5033	93
ZB	4 Cyl.	8.1:1	1471cc	55kW (75)PS	TD366	97
ZB	4 Cyl.	8.1:1	1471cc	55kW (75)PS	TD5037	97
ZC	4 Cyl.	9.7:1	1471cc	63kW (85)PS	TD367	98
ZC	4 Cyl.	9.7:1	1471cc	63kW (85)PS	TD5141	98
80	05/72→07/76	PASSAT		05/73→12/75	SCIROCCO	02/74→12/77

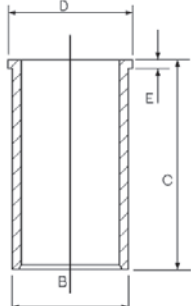
		
		14-023470-00 D [41] B 79.50 C 142.00 D 82.50 E 4.70 14-024670-00 D B 79.50 C 145.00 D 81.50 E 4.70 14-028360-00 D [62] B 79.50 C 145.00 D 81.50 E 4.70
		

[41] Phosphated

[41] Phosphated

[62] With recesses on crankshaft side

[62] Mit kurbelwellenseitigen Aussparungen

756		76.50		Petrol					
BE/PL	1	45.950/45.970	49.000/49.016	19.000	1.506	0.020/0.078	EC	71-3084	71-3084 STD 0.25 0.50
MB/HL	3	53.958/53.978	59.000/59.019	18.500	2.502	0.020/0.082	AL-LF	02-3085L	H025/5 STD 0.25 0.50
MB/HL	5	53.958/53.978	59.000/59.019	18.500	2.502	0.020/0.082	AL-LF	02-3085U	
MB/HL	1	53.958/53.978	59.000/59.019	24.930	2.502	0.020/0.082	AL-LF	02-3086HL	
MB/HL	1	53.958/53.978	59.000/59.019	24.930	2.502	0.020/0.082	AL-LF	02-3086HU	
CB/NWB 1-5	5	25.939/25.960	28.250/28.271	17.000	1.138		AL-LF	03-3317	N118/5 STD [67]
BU	1	42.959/42.975	46.055/46.095	15.000			AL-LF	07-3088	07-3088 STD SEMI [68]
BU	1	41.959/41.975	45.000/45.025	15.000			AL-LF	07-3089	07-3089 STD SEMI [68]

757		76.50		Diesel					
CK	4 Cyl.	23.5:1	1471 cc	37kW (50)PS			TD4046 99		
GOLF	08/76→07/80	JETTA	08/78→07/80	PASSAT			02/77→07/80		

<p>08-109500-00 STD</p> <p>08-109505-00 0.25mm</p> <p>08-109507-00 0.50mm</p> <p>08-109511-00 1.00mm</p> <p>12/81→</p> <p>1.75 CR P</p> <p>2.00 P</p> <p>3.00 CR P</p>	<p>08-405200-00 STD</p> <p>08-405205-00 0.25mm</p> <p>08-405207-00 0.50mm</p> <p>08-405211-00 1.00mm</p> <p>08/76→</p> <p>1.75 CR P</p> <p>2.00 P</p> <p>3.00 CR P</p>	<p>14-023470-00 D [41] B 79.50 C 142.00 D 82.50 E 4.70</p> <p>14-024670-00 D B 79.50 C 145.00 D 81.50 E 4.70</p> <p>14-028360-00 D [62] B 79.50 C 145.00 D 81.50 E 4.70</p>

[41] Phosphated









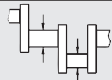
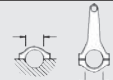

[41] Phosphated

[62] With recesses on crankshaft side











[62] Mit kurbelwellenseitigen Aussparungen

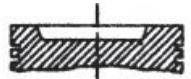
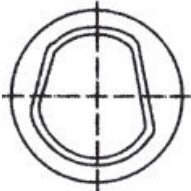







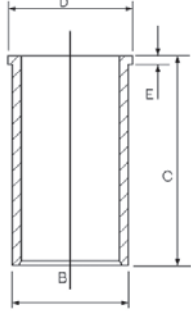

BE/PL	1	45.950/45.970	49.000/49.016	19.000	1.506	0.020/0.078	EC	71-3084	71-3084 STD 0.25 0.50
MB/HL	3	53.958/53.978	59.000/59.019	18.500	2.502	0.020/0.082	AL-LF	02-3085L	H025/5 STD 0.25 0.50
MB/HL	5	53.958/53.978	59.000/59.019	18.500	2.502	0.020/0.082	AL-LF	02-3085U	
MB/HL	1	53.958/53.978	59.000/59.019	24.930	2.502	0.020/0.082	AL-LF	02-3086HL	
MB/HL	1	53.958/53.978	59.000/59.019	24.930	2.502	0.020/0.082	AL-LF	02-3086HU	

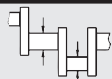
...Continued



757		 76.50	Diesel							
										
CB/NWB 1-5	5	25.939/25.960	28.250/28.271	17.000	1.138		AL-LF	03-3317	N118/5 STD	[67]
BU	1	42.959/42.975	46.055/46.095	15.000			AL-LF	07-3088	07-3088 STD SEMI	[68]
BU	1	41.959/41.975	45.000/45.025	15.000			AL-LF	07-3089	07-3089 STD SEMI	[68]





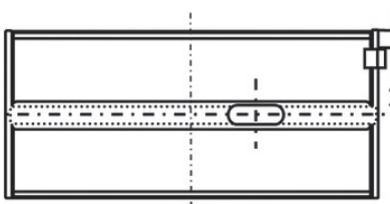
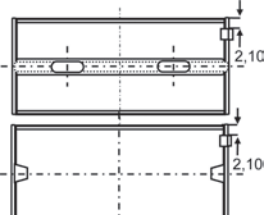

758		 76.50	Petrol							
AHS	4 Cyl.		1588cc	55kW (75)PS					TD12948	100
POLO	10/94 → 10/99									

		
87-502800-10 STD 87-502807-10 [23] 0.50mm   A 30.85 C 7.80 D 60.35  17x52	08-502800-00 STD 08-502807-00 0.50mm  1.20  NT[52] 1.50  P 2.50  CR[52] <hr/> 08-103100-00 STD 1.20  NT[52] 1.50  P 2.50  P	14-021571-00 D B 79.56 C 142.00 D 82.50 E 4.50 14-028360-00 D [62] B 79.50 C 145.00 D 81.50 E 4.70 
[23] A = 30.600, D = 52.600 [52] Steel [62] With recesses on crankshaft side	[23] A = 30.600, D = 52.600 [52] Stahl [62] Mit kurbelwellenseitigen Aussparungen	

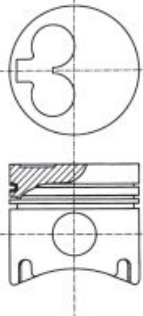
										
BE/PL	4	47.763/47.778	50.600/50.612	18.500	1.406	0.020/0.062	AL-LF	01-3867	01-3867/4 STD 0.25	
MB/HL 1-5	5	53.958/53.978	59.000/59.019	18.500	2.502	0.020/0.082	AL-LF	02-3085L	H084/5 STD 0.25 0.50	
MB/HL 1-5	5	53.958/53.978	59.000/59.019	18.500	2.502	0.020/0.082	AL-LF	02-3085U		
Mot. → 043000										
MB/HL 1-5	5	53.963/53.978	59.007/59.019	17.000	2.512	0.027/0.046	AL-LF	02-4929	H1325/5 STD 0.25 0.50	
Mot. 043001 →										

02-3085L			02-3085U			02-4929		
								
TW/A	2	59.500	73.200	1.975	AL-LF	04-3527	A123/4 STD	
TW/A	2	59.500	73.200	1.975	AL-LF	04-3528		

759		 76.50	Diesel			
1V	4 Cyl.	23:1	1588cc	44kW (60)PS	TD3996	101
JR	4 Cyl.	23:1	1588cc	51kW (70)PS	TD4121	107
JX	4 Cyl.	23.5:1	1588cc	50kW (68)PS	TD5018	108
MF	4 Cyl.	23:1	1588cc	51kW (70)PS	TD4130	101
RA	4 Cyl.	23:1	1588cc	59kW (80)PS	TD313	110
RA	4 Cyl.	23:1	1588cc	59kW (80)PS	TD5024	110
SB	4 Cyl.	23:1	1588cc	59kW (80)PS	TD4211	110
SB	4 Cyl.	23:1	1588cc	59kW (80)PS	TD5028	110
80	09/86→08/91	90	04/87→09/91	GOLF	08/83→10/91	
JETTA	01/84→10/91	PASSAT	05/86→09/93	SAVEIRO	08/91→07/96	
TRANSPORTER	08/84→07/92					

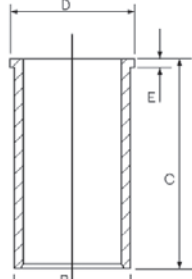







			
87-109800-10 STD 87-109807-10 [29] 0.50mm 87-109811-10 [29] 1.00mm A 41.70 B- 1.60 D 71.70  24x64 AK HA RT TP	08-109800-00 STD 08-109807-00 0.50mm 08-109811-00 1.00mm 1.75  CR P 2.00  CR P 3.00  CR P	14-021571-00 D B 79.56 C 142.00 D 82.50 E 4.50 14-028360-00 D [62] B 79.50 C 145.00 D 81.50 E 4.70 	

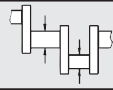

[29] A = 41.450





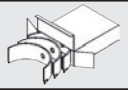



[29] A = 41.450

[62] With recesses on crankshaft side

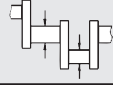



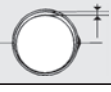

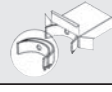
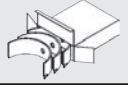



[62] Mit kurbelwellenseitigen Aussparungen

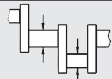







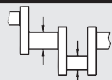

									
BE/PL	4	47.758/47.778	50.600/50.619	19.000	1.406	0.020/0.074	EC	71-3442	71-3442/4 STD 0.25 0.50 0.75
MB/HL 1-5	5	53.958/53.978	59.000/59.019	18.500	2.502	0.020/0.082	AL-LF	02-3085L	H084/5 STD 0.25 0.50
MB/HL 1-5	5	53.958/53.978	59.000/59.019	18.500	2.502	0.020/0.082	AL-LF	02-3085U	
TW/A	2	59.500	73.200		1.975		AL-LF	04-3527	A123/4 STD
TW/A	2	59.500	73.200		1.975		AL-LF	04-3528	
SE/PB	1	24.000/24.012	27.000/27.021	25.000			BC	55-3443	55-3443 SEMI

760		 76.50	Diesel			
685	4 Cyl.	23:1	1588cc	36kW (49)PS	TD22613	128
686	4 Cyl.	23:1	1588cc	45kW (61)PS	TD22614	129
68A	4 Cyl.	23:1	1588cc	45kW (61)PS	TD22615	130
68C	4 Cyl.	23:1	1588cc	50kW (68)PS	TD22616	131

									
BE/PL	4	47.758/47.778	50.600/50.619	19.000	1.406	0.020/0.074	EC	71-3442	71-3442/4 STD 0.25 0.50 0.75
MB/HL 1-5	5	53.958/53.978	59.000/59.019	18.500	2.502	0.020/0.082	AL-LF	02-3085L	H084/5 STD 0.25 0.50
MB/HL 1-5	5	53.958/53.978	59.000/59.019	18.500	2.502	0.020/0.082	AL-LF	02-3085U	









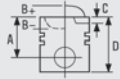

...Continued

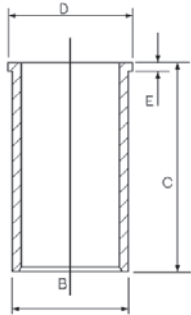
760		 76.50	Diesel							
										
TW/A	2	59.500	73.200		1.975		AL-LF	04-3527	A123/4 STD	
TW/A	2	59.500	73.200		1.975		AL-LF	04-3528		
SE/PB	1	24.000/24.012	27.000/27.021	25.000			BC	55-3443	55-3443 SEMI	

761		 76.50	Diesel							
ADK		4 Cyl.	22.5:1	1588cc	40kW (54)PS		TD22619			
										
BE/PL	4	47.758/47.778	50.600/50.619	19.000	1.406	0.020/0.074	EC	71-3442	71-3442/4 STD 0.25 0.50 0.75	
MB/HL 1-5	5	53.958/53.978	59.000/59.019	18.500	2.502	0.020/0.082	AL-LF	02-3085L	H084/5 STD 0.25 0.50	
MB/HL 1-5	5	53.958/53.978	59.000/59.019	18.500	2.502	0.020/0.082	AL-LF	02-3085U		
TW/A	2	59.500	73.200		1.975		AL-LF	04-3527	A123/4 STD	
TW/A	2	59.500	73.200		1.975		AL-LF	04-3528		
SE/PB	1	24.000/24.012	27.000/27.021	25.000			BC	55-3443	55-3443 SEMI	
CB/NWB 1-5	5	25.939/25.960	28.250/28.271	17.000	1.138		AL-LF	03-3317	N118/5 STD	

[68]

762		 76.50	Diesel								
CR	4 Cyl.	23:1	1588cc	40kW (54)PS		TD248 102					
CR	4 Cyl.	23:1	1588cc	40kW (54)PS		TD4992 102					
80	08/80→08/86	GOLF	08/80→07/83	JETTA	08/80→02/84						
PASSAT	02/79→03/88	SANTANA	08/81→12/84								

					
87-109500-00 [38]	STD	87-109500-00	STD	14-021571-00 D	B 79.56 C 142.00 D 82.50 E 4.50
87-109505-00 [38]	0.25mm	87-109505-00	0.25mm	14-028360-00 D [62]	B 79.50 C 145.00 D 81.50 E 4.70
87-109507-00 [38]	0.50mm	87-109507-00	0.50mm		
87-109511-00 [38]	1.00mm	87-109511-00	1.00mm		
A	41.70	12/81→			
B-	1.60	1.75 	CR P		
D	71.70	2.00 	P		
	24x64	3.00 	CR P		
RT		08-405200-00	STD		
		08-405205-00	0.25mm		
		08-405207-00	0.50mm		
		08-405211-00	1.00mm		
		08/76→			
		1.75 	CR P		
		2.00 	P		
		3.00 	CR P		

[38] No oil-jet cut out

[38] Ohne Aussparung für Kühllöspritzdüse

[62] With recesses on crankshaft side

[62] Mit kurbelwellenseitigen Aussparungen

762		76.50		Diesel							
BE/PL	4	47.758/47.778	50.600/50.619	19.000	1.406	0.020/0.074	EC	71-3442	71-3442/4 STD 0.25 0.50 0.75		
MB/HL	3	53.958/53.978	59.000/59.019	18.500	2.502	0.020/0.082	AL-LF	02-3085L	H025/5 STD 0.25 0.50		
MB/HL	5	53.958/53.978	59.000/59.019	18.500	2.502	0.020/0.082	AL-LF	02-3085U			
MB/HL	1	53.958/53.978	59.000/59.019	24.930	2.502	0.020/0.082	AL-LF	02-3086HL			
MB/HL	1	53.958/53.978	59.000/59.019	24.930	2.502	0.020/0.082	AL-LF	02-3086HU			
SE/PB	1	24.000/24.012	27.000/27.021	25.000			BC	55-3443	55-3443 SEMI		
CB/NWB 1-5	5	25.939/25.960	28.250/28.271	17.000	1.138		AL-LF	03-3317	N118/5 STD		[67]

763		76.50		Diesel							
CS	4 Cyl.	23:1	1588cc	37kW (50)PS							
TRANSPORTER	01/81→07/87										

87-109500-00 [38]		87-109505-00 [38]		87-109507-00 [38]		87-109511-00 [38]		08-109500-00		08-109505-00		08-109507-00		08-109511-00		14-021571-00 D		14-028360-00 D [62]		
STD	0.25mm	0.50mm	1.00mm					STD	0.25mm	0.50mm	1.00mm						B 79.56	C 142.00	D 82.50	E 4.50
																	B 79.50	C 145.00	D 81.50	E 4.70
A 41.70	B- 1.60	D 71.70	24x64					1.75 CR P	2.00 P	3.00 CR P										
RT								08-405200-00 STD	08-405205-00 0.25mm	08-405207-00 0.50mm	08-405211-00 1.00mm									
								08/76→	1.75 CR P	2.00 P	3.00 CR P									

[38] No oil-jet cut out









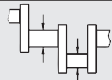
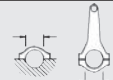

[38] Ohne Aussparung für Kùhlùlspritzdùse

[62] With recesses on crankshaft side





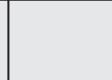

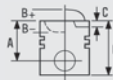
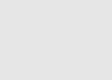
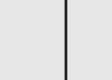

[62] Mit kurbelwellenseitigen Aussparungen

BE/PL		MB/HL 1,2,4,5		MB/HL 3		TW/A		TW/A							
4	47.758/47.778	50.600/50.619	19.000	1.406	0.020/0.074	EC	71-3442	71-3442/4 STD 0.25 0.50 0.75							
8	53.958/53.978	59.000/59.019	18.500	2.502	0.020/0.082	AL-LF	02-3085U	H024/5 STD 0.25							
2	53.958/53.978	59.000/59.019	24.930	2.502	0.020/0.082	AL-LF	02-3086HU								
2	59.500	73.200		1.975		AL-LF	04-3527	A123/4 STD							
2	59.500	73.200		1.975		AL-LF	04-3528								

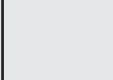
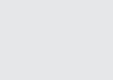
...Continued

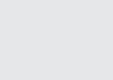
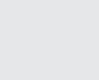
763		 76.50	Diesel							
										
SE/PB	1	24.000/24.012	27.000/27.021	25.000			BC	55-3443	55-3443 SEMI	
CB/NWB 1-5	5	25.939/25.960	28.250/28.271	17.000	1.138		AL-LF	03-3317	N118/5 STD [67]	

764		 76.50	Diesel							
CY	4 Cyl.	23/23.5:1	1588cc			51kW (70)PS		TD4052	104	
CY	4 Cyl.	23/23.5:1	1588cc			51kW (70)PS		TD4205	104	
80	08/81→05/86		90	10/85→01/87		GOLF	03/82→07/83			
JETTA	03/82→02/84		PASSAT	04/82→03/88		SANTANA	12/81→12/84			

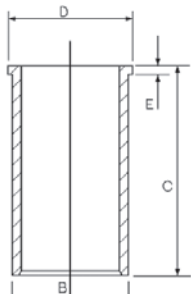







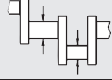

																	
87-109800-10	STD	87-109807-10 [29]	0.50mm	87-109811-10 [29]	1.00mm	08-109800-00	STD	08-109807-00	0.50mm	08-109811-00	1.00mm	14-021571-00 D	B 79.56	C 142.00	D 82.50	E 4.50	
87-109807-10 [29]	0.50mm	87-109811-10 [29]	1.00mm	08-109800-00	STD	08-109807-00	0.50mm	08-109811-00	1.00mm	14-028360-00 D [62]	B 79.50	C 145.00	D 81.50	E 4.70			
A	41.70	B-	1.60	D	71.70	1.75		CR P	2.00		CR P	3.00		CR P			
24x64																	
AK HA RT TP																	

[29] A = 41.450

[29] A = 41.450

[62] With recesses on crankshaft side

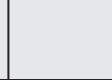
[62] Mit kurbelwellenseitigen Aussparungen

										
BE/PL	4	47.758/47.778	50.600/50.619	19.000	1.406	0.020/0.074	EC	71-3442	71-3442/4 STD 0.25 0.50 0.75	
MB/HL	3	53.958/53.978	59.000/59.019	18.500	2.502	0.020/0.082	AL-LF	02-3085L	H025/5 STD 0.25 0.50	
MB/HL	5	53.958/53.978	59.000/59.019	18.500	2.502	0.020/0.082	AL-LF	02-3085U		
MB/HL	1	53.958/53.978	59.000/59.019	24.930	2.502	0.020/0.082	AL-LF	02-3086HL		
MB/HL	1	53.958/53.978	59.000/59.019	24.930	2.502	0.020/0.082	AL-LF	02-3086HU		
SE/PB	1	24.000/24.012	27.000/27.021	25.000			BC	55-3443	55-3443 SEMI	

765	76.50	Diesel	
JK	4 Cyl.	23:1	1588cc
JK	4 Cyl.	23:1	1588cc
80	08/80→08/91	CADDY	08/82→07/92
JETTA	08/80→02/84	PASSAT	08/80→03/88
		GOLF	08/80→07/83
		SANTANA	08/81→12/84







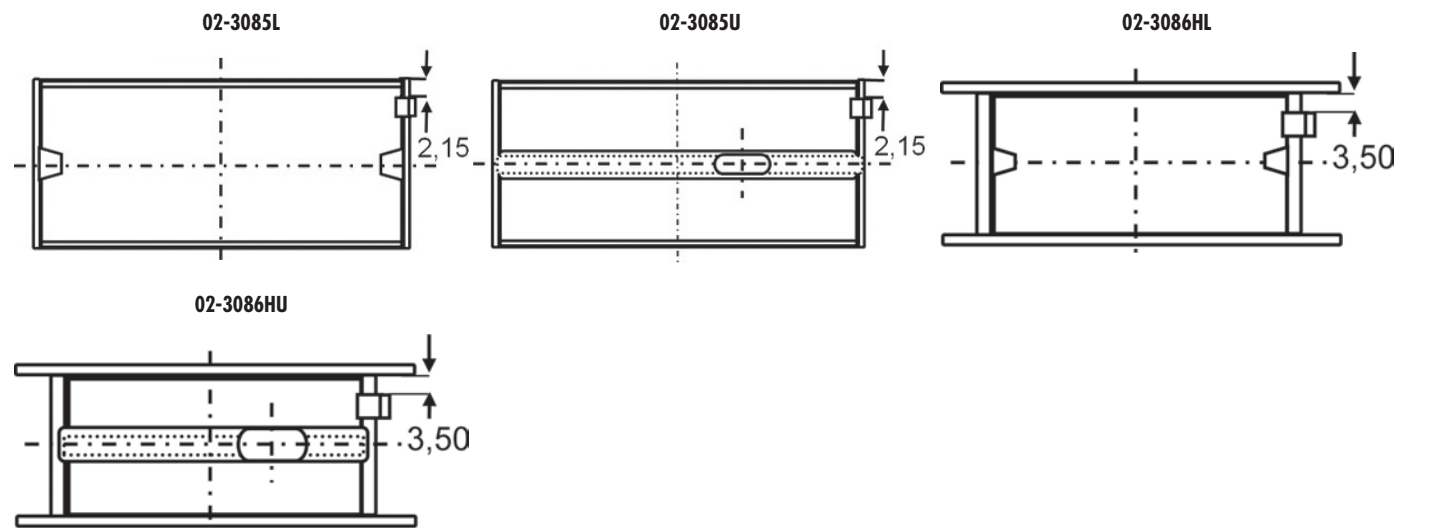

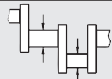

87-109500-00 [38] STD 87-109505-00 [38] 0.25mm 87-109507-00 [38] 0.50mm 87-109511-00 [38] 1.00mm A 41.70 B- 1.60 D 71.70 24x64 RT	08-109500-00 STD 08-109505-00 0.25mm 08-109507-00 0.50mm 08-109511-00 1.00mm 12/81→ 1.75 CR P 2.00 P 3.00 CR P 08-405200-00 STD 08-405205-00 0.25mm 08-405207-00 0.50mm 08-405211-00 1.00mm 08/76→ 1.75 CR P 2.00 P 3.00 CR P	14-021571-00 D B 79.56 C 142.00 D 82.50 E 4.50 14-028360-00 D [62] B 79.50 C 145.00 D 81.50 E 4.70

[38] No oil-jet cut out
 [38] Ohne Aussparung für Kühllöspritzdüse
 [62] With recesses on crankshaft side
 [62] Mit kurbelwellenseitigen Aussparungen

BE/PL	4	47.758/47.778	50.600/50.619	19.000	1.406	0.020/0.074	EC	71-3442	71-3442/4 STD 0.25 0.50 0.75
MB/HL	3	53.958/53.978	59.000/59.019	18.500	2.502	0.020/0.082	AL-LF	02-3085L	H025/5 STD 0.25 0.50
MB/HL	5	53.958/53.978	59.000/59.019	18.500	2.502	0.020/0.082	AL-LF	02-3085U	
MB/HL	1	53.958/53.978	59.000/59.019	24.930	2.502	0.020/0.082	AL-LF	02-3086HL	
MB/HL	1	53.958/53.978	59.000/59.019	24.930	2.502	0.020/0.082	AL-LF	02-3086HU	
MB/HL 1-5	5	53.958/53.978	59.000/59.019	18.500	2.502	0.020/0.082	AL-LF	02-3085L	H084/5 STD 0.25 0.50
MB/HL 1-5	5	53.958/53.978	59.000/59.019	18.500	2.502	0.020/0.082	AL-LF	02-3085U	



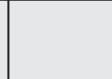







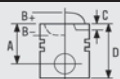

...Continued

765		 76.50	Diesel							
										
TW/A	2	59.500	73.200		1.975		AL-LF	04-3527	A123/4 STD	
TW/A	2	59.500	73.200		1.975		AL-LF	04-3528		
SE/PB	1	24.000/24.012	27.000/27.021	25.000			BC	55-3443	55-3443 SEMI	
CB/NWB 1-5	5	25.939/25.960	28.250/28.271	17.000	1.138		AL-LF	03-3317	N118/5 STD	

[67]

766		 76.50	Diesel							
JP	4 Cyl.		1588cc		40kW (54)PS				TD4120	106
GOLF	08/83→10/91		JETTA		01/84→10/91					

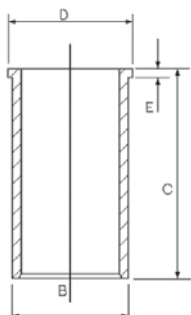







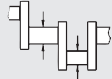
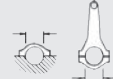

		
<p>87-109500-00 [38] STD</p> <p>87-109505-00 [38] 0.25mm</p> <p>87-109507-00 [38] 0.50mm</p> <p>87-109511-00 [38] 1.00mm</p> <p>A 41.70 B- 1.60 D 71.70  24x64</p> <p>RT</p>	<p>08-109500-00 STD</p> <p>08-109505-00 0.25mm</p> <p>08-109507-00 0.50mm</p> <p>08-109511-00 1.00mm</p> <p>12/81→</p> <p>1.75  CR P</p> <p>2.00  P</p> <p>3.00  CR P</p> <hr/> <p>08-405200-00 STD</p> <p>08-405205-00 0.25mm</p> <p>08-405207-00 0.50mm</p> <p>08-405211-00 1.00mm</p> <p>08/76→</p> <p>1.75  CR P</p> <p>2.00  P</p> <p>3.00  CR P</p>	<p>14-021571-00 D B 79.56 C 142.00 D 82.50 E 4.50</p> <p>14-028360-00 D [62] B 79.50 C 145.00 D 81.50 E 4.70</p> 

[38] No oil-jet cut out

[38] Ohne Aussparung für Kühllöspritzdüse



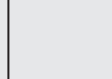





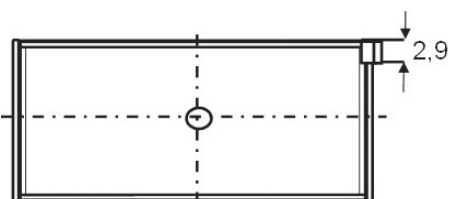

[62] With recesses on crankshaft side

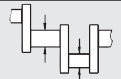
[62] Mit kurbelwellenseitigen Aussparungen









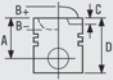

										
BE/PL	4	47.758/47.778	50.600/50.619	19.000	1.406	0.020/0.074	EC	71-3442	71-3442/4 STD 0.25 0.50 0.75	
BE/PL	4	47.758/47.778	50.600/50.612	19.000	1.406	0.020/0.067	EC	71-3694	71-3694/4 STD 0.25 0.50	

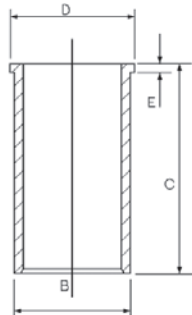
71-3694



766		 76.50		Diesel					
									
MB/HL 1-5	5	53.958/53.978	59.000/59.019	18.500	2.502	0.020/0.082	AL-LF	02-3085L	H084/5 STD 0.25 0.50
MB/HL 1-5	5	53.958/53.978	59.000/59.019	18.500	2.502	0.020/0.082	AL-LF	02-3085U	
TW/A	2	59.500	73.200		1.975		AL-LF	04-3527	A123/4 STD
TW/A	2	59.500	73.200		1.975		AL-LF	04-3528	
SE/PB	1	24.000/24.012	27.000/27.021	25.000			BC	55-3443	55-3443 SEMI

767		 76.50		Diesel					
ME	4 Cyl.	23:1	1588cc	40kW (54)PS			TD4129 109		
CADDY	08/82→07/92	GOLF	08/83→10/91	JETTA			01/84→10/91		









					
87-109500-00 [38]	STD	08-109500-00	STD	14-021571-00 D	B 79.56 C 142.00 D 82.50 E 4.50
87-109505-00 [38]	0.25mm	08-109505-00	0.25mm	14-028360-00 D [62]	B 79.50 C 145.00 D 81.50 E 4.70
87-109507-00 [38]	0.50mm	08-109507-00	0.50mm		
87-109511-00 [38]	1.00mm	08-109511-00	1.00mm		
A 41.70		12/81→			
B- 1.60		1.75 	CR P		
D 71.70		2.00 	P		
 24x64		3.00 	CR P		
RT		08-405200-00	STD		
		08-405205-00	0.25mm		
		08-405207-00	0.50mm		
		08-405211-00	1.00mm		
		08/76→			
		1.75 	CR P		
		2.00 	P		
		3.00 	CR P		

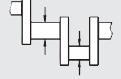

[38] No oil-jet cut out





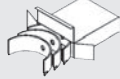

[38] Ohne Aussparung für Kùhlùlspritzdùse

[62] With recesses on crankshaft side

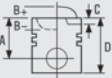







[62] Mit kurbelwellenseitigen Aussparungen

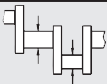
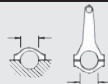

									
BE/PL	4	47.758/47.778	50.600/50.619	19.000	1.406	0.020/0.074	EC	71-3442	71-3442/4 STD 0.25 0.50 0.75
MB/HL 1-5	5	53.958/53.978	59.000/59.019	18.500	2.502	0.020/0.082	AL-LF	02-3085L	H084/5 STD 0.25 0.50
MB/HL 1-5	5	53.958/53.978	59.000/59.019	18.500	2.502	0.020/0.082	AL-LF	02-3085U	
TW/A	2	59.500	73.200		1.975		AL-LF	04-3527	A123/4 STD
TW/A	2	59.500	73.200		1.975		AL-LF	04-3528	
SE/PB	1	24.000/24.012	27.000/27.021	25.000			BC	55-3443	55-3443 SEMI







768	 76.50	Petrol				
AUS	4 Cyl.	11.5:1	1598cc	77kW (105)PS	TD15788	111
AUS	4 Cyl.	12:1	1597cc	77kW (105)PS	TD15477	111
AZD	4 Cyl.	11.5:1	1598cc	77kW (105)PS	TD15478	119
AZD	4 Cyl.	11.5:1	1598cc	77kW (105)PS	TD16131	119
BORA	02/00→05/05	GOLF	02/00→06/06	LEON	09/00→06/06	
TOLEDO	09/00→05/06					

		
	08-116100-00 STD 08-116107-00 0.50mm 1.20  NT[52] 1.50  P 2.50  CR[52]	

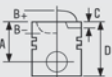







[52] Steel [52] Stahl

									
BE/PL	4	47.763/47.778	50.600/50.612	18.500	1.406	0.020/0.062	AL-LF	01-3867	01-3867/4 STD 0.25
MB/HL 1-5	5	53.963/53.978	59.007/59.019	17.000	2.512	0.027/0.046	AL-LF	02-4929	H1325/5 STD 0.25 0.50
TW/A	2	59.500	73.200		1.975		AL-LF	04-3527	A123/4 STD
TW/A	2	59.500	73.200		1.975		AL-LF	04-3528	

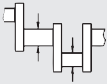
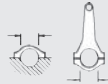
769	 76.50	Petrol				
ABU	4 Cyl.	9.3:1	1598cc	55kW (75)PS	TD4897	112
ABU	4 Cyl.	9.3:1	1598cc	55kW (75)PS	TD4976	112
CORDOBA	02/93→06/99	GOLF	09/92→12/97	IBIZA	03/93→08/99	
VENTO	09/92→09/98					

		
	08-502400-00 STD 1.50  CR P 1.50  P 2.50  CR[52]	

[52] Steel [52] Stahl

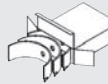
									
BE/PL	4	47.763/47.778	50.600/50.612	18.500	1.406	0.020/0.062	AL-LF	01-3867	01-3867/4 STD 0.25
MB/HL 1-5	10	53.958/53.978	59.000/59.019	18.500	2.502	0.020/0.082	AL-LF	02-3085U	H026/5 STD 0.25 0.50
TW/A	2	59.500	73.200		1.975		AL-LF	04-3527	A123/4 STD
TW/A	2	59.500	73.200		1.975		AL-LF	04-3528	
BU	1	42.959/42.975	46.055/46.095	15.000			AL-LF	07-3088	07-3088 STD SEMI [68]
BU	1	41.959/41.975	45.000/45.025	15.000			AL-LF	07-3089	07-3089 STD SEMI [68]

770	76.50	Petrol				
AEA	4 Cyl.	9.8:1	1598cc	55kW (75)PS	TD4019	113
GOLF	09/92→12/97	POLO	09/94→10/99	VENTO	09/92→09/98	

<p>87-502800-10 STD 87-502807-10 [23] 0.50mm</p> <p>A 30.85 C 7.80 D 60.35 17x52</p>	<p>08-502800-00 STD 08-502807-00 0.50mm</p> <p>1.20 NT[52] 1.50 P 2.50 CR[52]</p> <hr/> <p>08-103100-00 STD</p> <p>1.20 NT[52] 1.50 P 2.50 P</p>	<p>14-021571-00 D B 79.56 C 142.00 D 82.50 E 4.50 14-028360-00 D [62] B 79.50 C 145.00 D 81.50 E 4.70</p>
---	---	---

[23] A = 30.600, D = 52.600 [23] A = 30.600, D = 52.600
[52] Stahl [52] Stahl
[62] With recesses on crankshaft side [62] Mit kurbelwellenseitigen Aussparungen

BE/PL	4	47.763/47.778	50.600/50.612	18.500	1.406	0.020/0.062	AL-LF	01-3867	01-3867/4 STD 0.25
MB/HL 1-5	10	53.958/53.978	59.000/59.019	18.500	2.502	0.020/0.082	AL-LF	02-3085U	H026/5 STD 0.25 0.50
TW/A	2	59.500	73.200		1.975		AL-LF	04-3527	A123/4 STD
TW/A	2	59.500	73.200		1.975		AL-LF	04-3528	
BU	1	42.959/42.975	46.055/46.095	15.000			AL-LF	07-3088	07-3088 STD SEMI [68]
BU	1	41.959/41.975	45.000/45.025	15.000			AL-LF	07-3089	07-3089 STD SEMI [68]







771	76.50	Petrol				
AEE	4 Cyl.	9.8:1	1598cc	55kW (75)PS	TD4981	114
AEE	4 Cyl.	9.8:1	1598cc	55kW (75)PS	TD10867	114
AEE	4 Cyl.	9.8:1	1598cc	55kW (75)PS	TD13394	114
CADDY	11/95→12/00	CORDOBA	02/93→06/99	FELICIA	08/95→04/02	
GOLF	09/92→12/97	IBIZA	03/93→08/99	INCA	06/97→09/00	
OCTAVIA	09/96→09/04	POLO	10/94→09/01	VENTO	09/92→09/98	

<p>87-502800-10 STD 87-502807-10 [23] 0.50mm</p> <p>A 30.85 C 7.80 D 60.35 17x52</p>	<p>08-502800-00 STD 08-502807-00 0.50mm</p> <p>1.20 NT[52] 1.50 P 2.50 CR[52]</p> <hr/> <p>08-103100-00 STD</p> <p>1.20 NT[52] 1.50 P 2.50 P</p>	<p>14-021571-00 D B 79.56 C 142.00 D 82.50 E 4.50 14-028360-00 D [62] B 79.50 C 145.00 D 81.50 E 4.70</p>
---	---	---

[23] A = 30.600, D = 52.600 [23] A = 30.600, D = 52.600
[52] Stahl [52] Stahl
[62] With recesses on crankshaft side [62] Mit kurbelwellenseitigen Aussparungen

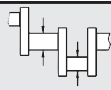
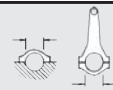
...Continued

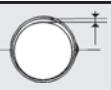
771  **76.50** **Petrol**

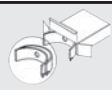
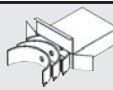
									
BE/PL	4	47.763/47.778	50.600/50.612	18.500	1.406	0.020/0.062	AL-LF	01-3867	01-3867/4 STD 0.25
BE/PL	4	47.763/47.778	50.600/50.612	17.200	1.406	0.023/0.071	AL-LF	01-4100	01-4100/4 STD

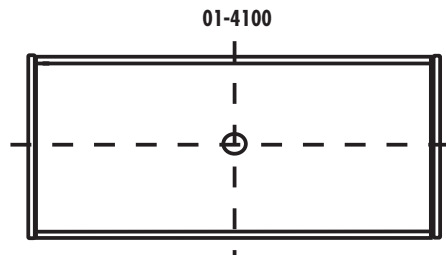
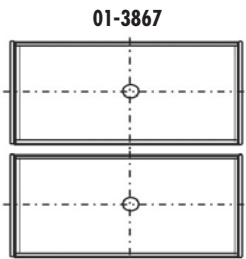

MB/HL 1-5	10	53.958/53.978	59.000/59.019	18.500	2.502	0.020/0.082	AL-LF	02-3085U	H026/5 STD 0.25 0.50
MB/HL 1-5	5	53.958/53.978	59.000/59.019	18.500	2.502	0.020/0.082	AL-LF	02-3085L	H084/5 STD 0.25 0.50
MB/HL 1-5	5	53.958/53.978	59.000/59.019	18.500	2.502	0.020/0.082	AL-LF	02-3085U	

Mot. → 629000

MB/HL 1-5	5	53.963/53.978	59.007/59.019	17.000	2.512	0.027/0.046	AL-LF	02-4929	H1325/5 STD 0.25 0.50
--------------	---	---------------	---------------	--------	-------	-------------	-------	---------	---------------------------------

Mot. 629001 →

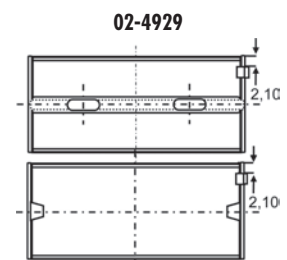
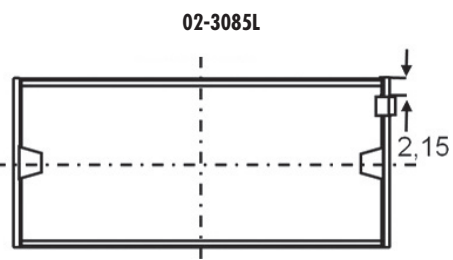
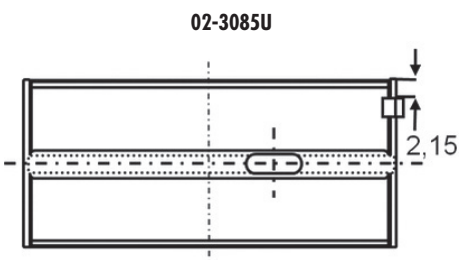







TW/A	2	59.500	73.200		1.975		AL-LF	04-3527	A123/4 STD	
TW/A	2	59.500	73.200		1.975		AL-LF	04-3528		
BU	1	42.959/42.975	46.055/46.095	15.000			AL-LF	07-3088	07-3088 STD SEMI	[68]
BU	1	41.959/41.975	45.000/45.025	15.000			AL-LF	07-3089	07-3089 STD SEMI	[68]

772  **76.50** **Petrol**

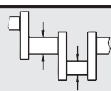
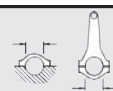
AJV 4 Cyl. 1598cc 88kW (120)PS TD11247 115

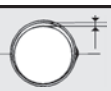
POLO 09/98 → 10/99

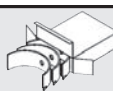
									
MB/HL 1-5	5	53.963/53.978	59.007/59.019	17.000	2.512	0.027/0.046	AL-LF	02-4929	H1325/5 STD 0.25 0.50
TW/A	2	59.500	73.200		1.975		AL-LF	04-3527	A123/4 STD
TW/A	2	59.500	73.200		1.975		AL-LF	04-3528	

773

76.50



Petrol











ALM	4 Cyl.	9.8:1	1598cc	55kW (75)PS	TD12949	116
ALM	4 Cyl.	9.8:1	1598cc	55kW (75)PS	TD15610	116
CORDOBA	02/93→12/02		IBIZA	03/93→02/02	INCA	06/97→09/00
POLO	11/95→09/01					

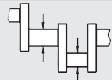
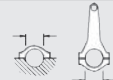

87-502800-10 STD 87-502807-10 [23] 0.50mm	08-502800-00 STD 08-502807-00 0.50mm	14-021571-00 D B 79.56 C 142.00 D 82.50 E 4.50 14-028360-00 D [62] B 79.50 C 145.00 D 81.50 E 4.70	1.20 NT[52] 1.50 P 2.50 CR[52]	08-103100-00 STD 1.20 NT[52] 1.50 P 2.50 P	A 30.85 C 7.80 D 60.35 17x52	[23] A = 30.600, D = 52.600 [52] Steel [62] With recesses on crankshaft side	[23] A = 30.600, D = 52.600 [52] Stahl [62] Mit kurbelwellenseitigen Aussparungen		

BE/PL	4	47.763/47.778	50.600/50.612	17.200	1.406	0.023/0.071	AL-LF	01-4100	01-4100/4 STD
MB/HL 1-5	5	53.963/53.978	59.007/59.019	17.000	2.512	0.027/0.046	AL-LF	02-4929	H1325/5 STD 0.25 0.50
TW/A	2	59.500	73.200		1.975		AL-LF	04-3527	A123/4 STD
TW/A	2	59.500	73.200		1.975		AL-LF	04-3528	
BU	1	42.959/42.975	46.055/46.095	15.000			AL-LF	07-3088	07-3088 STD SEMI [68]
BU	1	41.959/41.975	45.000/45.025	15.000			AL-LF	07-3089	07-3089 STD SEMI [68]







774		 76.50	Petrol			
ARC	4 Cyl.	10.6:1	1598cc	92kW (125)PS	TD14169	117
AVY	4 Cyl.	11.5:1	1598cc	92kW (125)PS	TD15493	118
BAD	4 Cyl.	12:1	1598cc	81kW (110)PS	TD16388	120
BAD	4 Cyl.	12:1	1598cc	81kW (110)PS	TD16415	120
BAG	4 Cyl.	12:1	1598cc	85kW (115)PS	TD17048	80
BLF	4 Cyl.	12:1	1598cc	85kW (115)PS	TD17501	123
BLF	4 Cyl.	12:1	1598cc	85kW (115)PS	TD18100	123
BLF	4 Cyl.	12:1	1598cc	85kW (115)PS	TD20713	123
BLP	4 Cyl.		1598cc	85kW (115)PS	TD17401	85
BLP	4 Cyl.		1598cc	85kW (115)PS	TD18202	85
BTS	4 Cyl.	10.5:1	1598cc	77kW (105)PS	TD19090	124
BTS	4 Cyl.	10.5:1	1598cc	77kW (105)PS	TD19093	124
BTS	4 Cyl.	10.5:1	1598cc	77kW (105)PS	TD19428	124
CFNA	4 Cyl.	10.5:1	1598cc	77kW (105)PS	TD24981	

A2	05/02→08/05	A3	08/03→	BORA	01/02→05/05
CORDOBA	11/06→11/09	EOS	06/06→05/08	FABIA	04/07→
GOLF	01/02→07/08	IBIZA	11/06→	JETTA	09/05→10/10
LUPO	09/00→07/05	OCTAVIA	02/04→10/08	PASSAT	03/05→06/08
POLO	10/99→11/09	ROOMSTER	09/06→	TOURAN	02/03→01/07

									
BE/PL	4	47.763/47.778	50.600/50.612	17.200	1.406	0.023/0.071	AL-LF	01-4100	01-4100/4 STD
MB/HL 1-5	5	53.963/53.978	59.007/59.019	17.000	2.512	0.027/0.046	AL-LF	02-4929	H1325/5 STD 0.25 0.50
TW/A	2	59.500	73.200		1.975		AL-LF	04-3527	A123/4 STD
TW/A	2	59.500	73.200		1.975		AL-LF	04-3528	









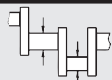

775		 76.50	Petrol			
ATN	4 Cyl.	11.5:1	1598cc	77kW (105)PS	TD15476	111
ATN	4 Cyl.	11.5:1	1598cc	77kW (105)PS	TD15531	111

BORA	02/00→05/05	GOLF	02/00→06/06	LEON	09/00→06/06
-------------	-------------	-------------	-------------	-------------	-------------

		
	08-116100-00 STD 08-116107-00 0.50mm 1.20  NT[52] 1.50  P 2.50  CR[52]	

[52] Steel

[52] Stahl

									
MB/HL 1-5	5	53.963/53.978	59.007/59.019	17.000	2.512	0.027/0.046	AL-LF	02-4929	H1325/5 STD 0.25 0.50
TW/A	2	59.500	73.200		1.975		AL-LF	04-3527	A123/4 STD
TW/A	2	59.500	73.200		1.975		AL-LF	04-3528	

776	76.50	Petrol	
BCB	4 Cyl.	11.5:1	1598cc
			77kW (105)PS
			TD16387 122
BCB	4 Cyl.	11.5:1	1598cc
			77kW (105)PS
			TD16435 122
BORA	02/00→05/05	GOLF	02/00→06/06
TOLEDO	09/00→05/06	LEON	09/00→06/06

BE/PL	4	47.763/47.778	50.600/50.612	18.500	1.406	0.020/0.062	AL-LF	01-3867	01-3867/4 STD 0.25
TW/A	2	59.500	73.200		1.975		AL-LF	04-3527	A123/4 STD
TW/A	2	59.500	73.200		1.975		AL-LF	04-3528	

777	76.50	Diesel	
1C	4 Cyl.	23:1	1600cc
			51kW (70)PS
			TD13489 126
ILTIS	08/87→12/88		

BE/PL	4	50.500	53.500	23.700	1.480	0.040/0.070	AL-LF	GS70003SA	01-4355/4 STD

778	76.50	Diesel	
CN	5 Cyl.	23:1	1986cc
			51kW (70)PS
			TD247 132
100	08/78→11/90		

<p>87-109500-00 [38] STD</p> <p>87-109505-00 [38] 0.25mm</p> <p>87-109507-00 [38] 0.50mm</p> <p>87-109511-00 [38] 1.00mm</p> <p>A 41.70</p> <p>B- 1.60</p> <p>D 71.70</p> <p> 24x64</p> <p>RT</p>	<p>08-109500-00 STD</p> <p>08-109505-00 0.25mm</p> <p>08-109507-00 0.50mm</p> <p>08-109511-00 1.00mm</p> <p>12/81→</p> <p>1.75 CR P</p> <p>2.00 P</p> <p>3.00 CR P</p> <hr/> <p>08-405200-00 STD</p> <p>08-405205-00 0.25mm</p> <p>08-405207-00 0.50mm</p> <p>08-405211-00 1.00mm</p> <p>08/76→</p> <p>1.75 CR P</p> <p>2.00 P</p> <p>3.00 CR P</p>	<p>14-021571-00 D B 79.56 C 142.00 D 82.50 E 4.50</p> <p>14-028360-00 D [62] B 79.50 C 145.00 D 81.50 E 4.70</p>

[38] No oil-jet cut out

[38] Ohne Aussparung für Kühllöspritzdüse

[62] With recesses on crankshaft side

[62] Mit kurbelwellenseitigen Aussparungen

...Continued

778		76.50		Diesel						
BE/PL	5	47.758/47.778	50.600/50.619	19.000	1.406	0.020/0.074	EC	71-3442	71-3442/5 STD 0.25 0.50	
MB/HL 1,2, 4-6	5	57.958/57.978	63.000/63.019	18.500	2.502	0.020/0.082	EC	72-3400	H941/6 STD 0.25	
MB/HL 3	1	57.958/57.978	63.000/63.019	24.930	2.502	0.020/0.082	EC	72-3401H		
		72-3401H	STD							
			0.25MM							
			0.50MM							
			0.75MM							
MB/HL 1-6	6	57.958/57.978	63.000/63.019	18.500	2.502	0.020/0.082	EC	72-3400	H981/6 STD 0.25	
TW/A	2	63.500/63.750	77.200/77.450		1.975		AL-LF	04-3529	A124/4 STD	
TW/A	2	63.500/63.750	77.200/77.450		1.975		AL-LF	04-3530		
TW/A	2	63.500/63.750	76.950/77.200		1.975		AL-LF	04-4782	A292/4 STD	
TW/A	2	63.500/63.750	76.950/77.200		1.975		AL-LF	04-4783		
SE/PB	1	24.000/24.012	27.000/27.021	25.000			BC	55-3443	55-3443 SEMI	

779		76.50		Diesel					
DE	5 Cyl.	23:1	1986cc	64kW (87)PS				TD251	133
NC	5 Cyl.	23:1	1986cc	74kW (100)PS				TD299	134
100	08/82→11/90		LT 28-35	12/82→09/93		LT 40-55		08/78→09/93	

87-109800-10	STD	08-109800-00	STD	14-021571-00 D	B 79.56 C 142.00 D 82.50 E 4.50
87-109807-10 [29]	0.50mm	08-109807-00	0.50mm	14-028360-00 D [62]	B 79.50 C 145.00 D 81.50 E 4.70
87-109811-10 [29]	1.00mm	08-109811-00	1.00mm		
A 41.70		1.75	CR P		
B- 1.60		2.00	CR P		
D 71.70		3.00	CR P		
24x64					
AK HA RT TP					







[29] A = 41.450

[62] With recesses on crankshaft side

[29] A = 41.450

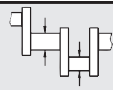
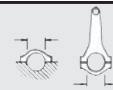

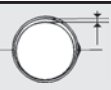

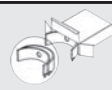
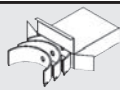





[62] Mit kurbelwellenseitigen Aussparungen

779 76.50 Diesel

										
BE/PL	5	47.758/47.778	50.600/50.619	19.000	1.406	0.020/0.074	EC	71-3442	71-3442/5 STD 0.25 0.50	
MB/HL 1,2, 4-6	5	57.958/57.978	63.000/63.019	18.500	2.502	0.020/0.082	EC	72-3400	H941/6 STD 0.25	
MB/HL 3	1	57.958/57.978	63.000/63.019	24.930	2.502	0.020/0.082	EC	72-3401H		
		72-3401H	STD							
			0.25MM							
			0.50MM							
			0.75MM							
MB/HL 1-6	6	57.958/57.978	63.000/63.019	18.500	2.502	0.020/0.082	EC	72-3400	H981/6 STD 0.25	
TW/A	2	63.500/63.750	77.200/77.450		1.975		AL-LF	04-3529	A124/4 STD	
TW/A	2	63.500/63.750	77.200/77.450		1.975		AL-LF	04-3530		
TW/A	2	63.500/63.750	76.950/77.200		1.975		AL-LF	04-4782	A292/4 STD	
TW/A	2	63.500/63.750	76.950/77.200		1.975		AL-LF	04-4783		
SE/PB	1	24.000/24.012	27.000/27.021	25.000			BC	55-3443	55-3443 SEMI	

780 76.50 Diesel

DV	6 Cyl.	23:1	2383cc	75/80kW (102/109)PS	TD4061	143
100	08/82→11/90	LT 28-35	12/82→09/93	LT 40-55	08/78→09/93	

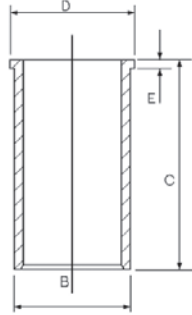
		
<p>87-109500-00 [38] STD</p> <p>87-109505-00 [38] 0.25mm</p> <p>87-109507-00 [38] 0.50mm</p> <p>87-109511-00 [38] 1.00mm</p> <p>A 41.70</p> <p>B- 1.60</p> <p>D 71.70</p> <p> 24x64</p> <p>RT</p>	<p>08-109500-00 STD</p> <p>08-109505-00 0.25mm</p> <p>08-109507-00 0.50mm</p> <p>08-109511-00 1.00mm</p> <p>12/81→</p> <p>1.75  CR P</p> <p>2.00  P</p> <p>3.00  CR P</p> <hr/> <p>08-405200-00 STD</p> <p>08-405205-00 0.25mm</p> <p>08-405207-00 0.50mm</p> <p>08-405211-00 1.00mm</p> <p>08/76→</p> <p>1.75  CR P</p> <p>2.00  P</p> <p>3.00  CR P</p>	<p>14-021571-00 D B 79.56 C 142.00 D 82.50 E 4.50</p> <p>14-028360-00 D [62] B 79.50 C 145.00 D 81.50 E 4.70</p> 







[38] No oil-jet cut out

[38] Ohne Aussparung für K hlspritzd se



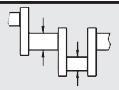
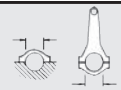

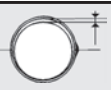

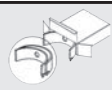
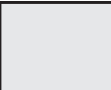
[62] With recesses on crankshaft side



[62] Mit kurbelwellenseitigen Aussparungen

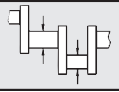
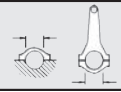

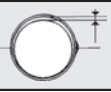

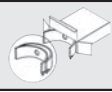
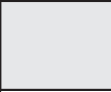

...Continued

780		 76.50		Diesel					
									
BE/PL	6	47.758/47.778	50.600/50.619	19.000	1.406	0.020/0.074	EC	71-3442	71-3442/6 STD 0.25 0.50
MB/HL 1,2, 4-7	6	57.958/57.978	63.000/63.019	18.500	2.502	0.020/0.082	EC	72-3400	H941/7 STD 0.25 0.75
MB/HL 3	1	57.958/57.978	63.000/63.019	24.930	2.502	0.020/0.082	EC	72-3401H	
		72-3401H	STD						
			0.25MM						
			0.50MM						
			0.75MM						
MB/HL 1-7	7	57.958/57.978	63.000/63.019	18.500	2.502	0.020/0.082	EC	72-3400	H981/7 STD 0.25 0.75
TW/A	2	63.500/63.750	77.200/77.450		1.975		AL-LF	04-3529	A124/4 STD
TW/A	2	63.500/63.750	77.200/77.450		1.975		AL-LF	04-3530	
TW/A	2	63.500/63.750	76.950/77.200		1.975		AL-LF	04-4782	A292/4 STD
TW/A	2	63.500/63.750	76.950/77.200		1.975		AL-LF	04-4783	
SE/PB	1	24.000/24.012	27.000/27.021	25.000			BC	55-3443	55-3443 SEMI

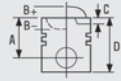
781		 76.50		Petrol					
TE	6 Cyl.		2382cc			70kW (95)PS		TD4956	135
DL	6 Cyl.	8:1	2383cc			66kW (89)PS		TD4995	136
HS	6 Cyl.	8:1	2383cc			62kW (84)PS		TD4108	139
LT 28-35	12/82→06/96		LT 40-55			12/82→06/96			

									
BE/PL	6	47.758/47.778	50.600/50.619	19.000	1.406	0.020/0.074	EC	71-3442	71-3442/6 STD 0.25 0.50
MB/HL 1-7	7	57.958/57.978	63.000/63.019	18.500	2.502	0.020/0.082	EC	72-3400	H981/7 STD 0.25 0.75
TW/A	2	63.500/63.750	77.200/77.450		1.975		AL-LF	04-3529	A124/4 STD
TW/A	2	63.500/63.750	77.200/77.450		1.975		AL-LF	04-3530	
TW/A	2	63.500/63.750	76.950/77.200		1.975		AL-LF	04-4782	A292/4 STD
TW/A	2	63.500/63.750	76.950/77.200		1.975		AL-LF	04-4783	
SE/PB	1	24.000/24.012	27.000/27.021	25.000			BC	55-3443	55-3443 SEMI

782	 76.50	Diesel				
1G	6 Cyl.	23:1	2383cc	68kW (92)PS	TD3993	140
ACL	6 Cyl.	22:1	2384cc	70kW (95)PS	TD4012	145
LT 28-35	08/88→06/96	LT 40-55	08/88→06/96			

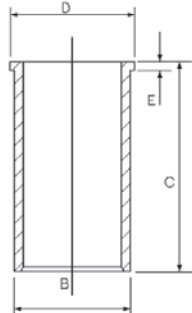







		
87-109800-10 STD 87-109807-10 [29] 0.50mm 87-109811-10 [29] 1.00mm A 41.70 B- 1.60 D 71.70  24x64 AK HA RT TP	87-109800-00 STD 87-109807-00 0.50mm 87-109811-00 1.00mm 1.75  CR P 2.00  CR P 3.00  CR P	14-021571-00 D B 79.56 C 142.00 D 82.50 E 4.50 14-028360-00 D [62] B 79.50 C 145.00 D 81.50 E 4.70 

[29] A = 41.450

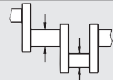
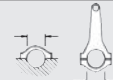
[29] A = 41.450

[62] With recesses on crankshaft side

[62] Mit kurbelwellenseitigen Aussparungen

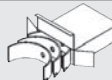
									
BE/PL	6	47.758/47.778	50.600/50.619	19.000	1.406	0.020/0.074	EC	71-3442	71-3442/6 STD 0.25 0.50
MB/HL 1-7	7	57.958/57.978	63.000/63.019	18.500	2.502	0.020/0.082	EC	72-3400	H981/7 STD 0.25 0.75
TW/A	2	63.500/63.750	77.200/77.450		1.975		AL-LF	04-3529	A124/4 STD
TW/A	2	63.500/63.750	77.200/77.450		1.975		AL-LF	04-3530	
TW/A	2	63.500/63.750	76.950/77.200		1.975		AL-LF	04-4782	A292/4 STD
TW/A	2	63.500/63.750	76.950/77.200		1.975		AL-LF	04-4783	
SE/PB	1	24.000/24.012	27.000/27.021	25.000			BC	55-3443	55-3443 SEMI

783

76.50

Diesel



1S	6 Cyl.	23.5:1	2383cc	51kW (70)PS	TD4958	141
ACT	6 Cyl.	22:1	2384cc	51kW (70)PS	TD4014	146
LT 28-35	08/89→06/96		LT 40-55	07/90→06/96		

<p>87-109500-00 [38] STD</p> <p>87-109505-00 [38] 0.25mm</p> <p>87-109507-00 [38] 0.50mm</p> <p>87-109511-00 [38] 1.00mm</p> <p>A 41.70</p> <p>B- 1.60</p> <p>D 71.70</p> <p> 24x64</p> <p>RT</p>	<p>08-109500-00 STD</p> <p>08-109505-00 0.25mm</p> <p>08-109507-00 0.50mm</p> <p>08-109511-00 1.00mm</p> <p>12/81→</p> <p>1.75 CR P</p> <p>2.00 P</p> <p>3.00 CR P</p> <hr/> <p>08-405200-00 STD</p> <p>08-405205-00 0.25mm</p> <p>08-405207-00 0.50mm</p> <p>08-405211-00 1.00mm</p> <p>08/76→</p> <p>1.75 CR P</p> <p>2.00 P</p> <p>3.00 CR P</p>	<p>14-021571-00 D B 79.56 C 142.00 D 82.50 E 4.50</p> <p>14-028360-00 D [62] B 79.50 C 145.00 D 81.50 E 4.70</p>

[62] With recesses on crankshaft side

[62] Mit kurbelwellenseitigen Aussparungen

BE/PL	6	47.758/47.778	50.600/50.619	19.000	1.406	0.020/0.074	EC	71-3442	71-3442/6 STD 0.25 0.50
MB/HL 1-7	7	57.958/57.978	63.000/63.019	18.500	2.502	0.020/0.082	EC	72-3400	H981/7 STD 0.25 0.75
TW/A	2	63.500/63.750	77.200/77.450		1.975		AL-LF	04-3529	A124/4 STD
TW/A	2	63.500/63.750	77.200/77.450		1.975		AL-LF	04-3530	
TW/A	2	63.500/63.750	76.950/77.200		1.975		AL-LF	04-4782	A292/4 STD
TW/A	2	63.500/63.750	76.950/77.200		1.975		AL-LF	04-4783	
SE/PB	1	24.000/24.012	27.000/27.021	25.000			BC	55-3443	55-3443 SEMI

784

76.50

Diesel



CP	6 Cyl.	23:1	2383cc	55kW (75)PS	TD4047	142
DW	6 Cyl.	23:1	2383cc	55/57kW (75/78)PS	TD4062	144
LT 28-35	12/78→07/92		LT 40-55	12/78→07/92		

87-109500-00 [38] STD 87-109500-00 [38] STD 87-109505-00 [38] 0.25mm 87-109507-00 [38] 0.50mm 87-109511-00 [38] 1.00mm	08-109500-00 STD 08-109500-00 STD 08-109505-00 0.25mm 08-109507-00 0.50mm 08-109511-00 1.00mm 12/81→ 1.75 CR P 2.00 P 3.00 CR P	14-021571-00 D B 79.56 C 142.00 D 82.50 E 4.50 14-021571-00 D B 79.56 C 142.00 D 82.50 E 4.50 14-028360-00 D [62] B 79.50 C 145.00 D 81.50 E 4.70	08-405200-00 STD 08-405205-00 0.25mm 08-405207-00 0.50mm 08-405211-00 1.00mm 08/76→ 1.75 CR P 2.00 P 3.00 CR P	D E C B	A 41.70 B- 1.60 D 71.70 24x64 RT



[38] No oil-jet cut out









[38] Ohne Aussparung für Kühllölspritzdüse

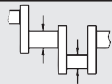

[62] With recesses on crankshaft side





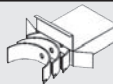

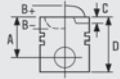

[62] Mit kurbelwellenseitigen Aussparungen

BE/PL	6	47.758/47.778	50.600/50.619	19.000	1.406	0.020/0.074	EC	71-3442	71-3442/6 STD 0.25 0.50	
MB/HL 1,2, 4-7	6	57.958/57.978	63.000/63.019	18.500	2.502	0.020/0.082	EC	72-3400	H941/7 STD 0.25 0.75	
MB/HL 3	1	57.958/57.978	63.000/63.019	24.930	2.502	0.020/0.082	EC	72-3401H		
		72-3401H	STD							
			0.25MM							
			0.50MM							
			0.75MM							
MB/HL 1-7	7	57.958/57.978	63.000/63.019	18.500	2.502	0.020/0.082	EC	72-3400	H981/7 STD 0.25 0.75	
TW/A	2	63.500/63.750	77.200/77.450		1.975		AL-LF	04-3529	A124/4 STD	
TW/A	2	63.500/63.750	77.200/77.450		1.975		AL-LF	04-3530		
TW/A	2	63.500/63.750	76.950/77.200		1.975		AL-LF	04-4782	A292/4 STD	
TW/A	2	63.500/63.750	76.950/77.200		1.975		AL-LF	04-4783		
SE/PB	1	24.000/24.012	27.000/27.021	25.000			BC	55-3443	55-3443 SEMI	

785		 77.00	Petrol		
122	4 Cyl.	7.5:1	1192cc	18-25kW (25-34)PS	TD22607
AC	4 Cyl.		1285cc	29kW (40)PS	TD5135 147
AR	Boxer4 Cyl.		1285cc	32kW (44)PS	TD4029 147
GOL	05/80→07/82	KAEFER	08/70→07/75		

									
BE/PL	4	54.971/54.990	57.800/57.819	17.600	1.397	0.020/0.079	EC	71-1950	71-1950/4 STD 0.25 0.50
MB/HL 1	1	54.971/54.990	65.000/65.019	26.936	4.987	0.036/0.099	AL	2931ATA	H1025/4 STD
MB/HL 2	1	54.971/54.990	65.000/65.019	22.000	5.035	0.020/0.038	BS	2932CP	
MB/HL 4	1	39.984/40.000	50.000/50.016	15.000	4.983	0.034/0.091	AL	2933AT	
MB/HL 3	1	54.971/54.990	65.000/65.019	22.000	4.990	0.030/0.039	AL	2934AT	
SE/PB	1	20.000	22.000	24.400			BC	55-2567	55-2567 SEMI
SE/PB	1	22.000	23.970/24.003	23.400			BC	55-2723	55-2723 SEMI
CB/NWB 1	2	24.987/25.000	27.500/27.521	20.000	1.245		BB	13-2368	N072/3 STD
CB/NWB 2	2	24.987/25.000	27.500/27.521	23.000	1.245		BB	13-2369	
CB/NWB 3	1	24.987/25.000	27.500/27.521	28.000	1.245		BB	13-2370HL	
CB/NWB 3	1	24.987/25.000	27.500/27.521	25.000	1.245		BB	13-2370U	
CB/NWB 1	2	24.987/25.000	27.500/27.521	20.000	1.245		BB	13-2368	N139/3 STD
CB/NWB 2	2	24.987/25.000	27.500/27.521	23.000	1.245		BB	13-2369	
CB/NWB 3	2	24.987/25.000	27.500/27.521	28.000	1.245		BB	13-2370HL	

786		 77.00	Petrol		
AB	Boxer4 Cyl.	7.5:1	1285cc	32kW (44)PS	TD4005 149
D	Boxer4 Cyl.	7.3:1	1192cc	25kW (34)PS	TD4054 148
E	Boxer4 Cyl.		1285cc	27kW (37)PS	TD5132 147
F	Boxer4 Cyl.		1285cc	29kW (40)PS	TD4076 149
KAEFER	01/60→12/85	KARMANN GHIA	09/57→07/74		

		
	08-390200-00 STD 08-390205-00 0.25mm →07/72 2.50  P 2.50  P 4.00  CR[52]	
	08-390207-10 0.50mm →07/72 2.50  P 2.50  P 4.00  CR[52]	



786

 77.00

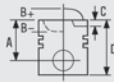
Petrol









08-394500-00 STD
08-394505-00 0.25mm
08-394507-00 0.50mm
 08/72 →

2.00  P
 2.00  P
 4.00  P

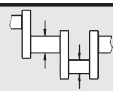
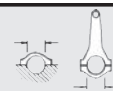
[52] Steel

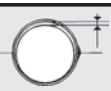
[52] Stahl

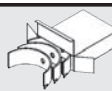
									
BE/PL	4	54.971/54.990	57.800/57.819	17.600	1.397	0.020/0.079	EC	71-1950	71-1950/4 STD 0.25 0.50
MB/HL 1	1	54.971/54.990	65.000/65.019	26.936	4.987	0.036/0.099	AL	2931ATA	H1025/4 STD
MB/HL 2	1	54.971/54.990	65.000/65.019	22.000	5.035	0.020/0.038	BS	2932CP	
MB/HL 4	1	39.984/40.000	50.000/50.016	15.000	4.983	0.034/0.091	AL	2933AT	
MB/HL 3	1	54.971/54.990	65.000/65.019	22.000	4.990	0.030/0.039	AL	2934AT	
SE/PB	1	20.000	22.000	24.400			BC	55-2567	55-2567 SEMI
SE/PB	1	22.000	23.970/24.003	23.400			BC	55-2723	55-2723 SEMI
CB/NWB 1	2	24.987/25.000	27.500/27.521	20.000	1.245		BB	13-2368	N072/3 STD
CB/NWB 2	2	24.987/25.000	27.500/27.521	23.000	1.245		BB	13-2369	
CB/NWB 3	1	24.987/25.000	27.500/27.521	28.000	1.245		BB	13-2370HL	
CB/NWB 3	1	24.987/25.000	27.500/27.521	25.000	1.245		BB	13-2370U	
CB/NWB 1	2	24.987/25.000	27.500/27.521	20.000	1.245		BB	13-2368	N139/3 STD
CB/NWB 2	2	24.987/25.000	27.500/27.521	23.000	1.245		BB	13-2369	
CB/NWB 3	2	24.987/25.000	27.500/27.521	28.000	1.245		BB	13-2370HL	

787

78.30

Diesel



AFB	V6 Cyl.		2496cc	110kW (150)PS	TD9517	150
AFB	V6 Cyl.		2496cc	110kW (150)PS	TD11499	150
AKN	V6 Cyl.	19.5:1	2496cc	110kW (150)PS	TD11356	150
AKN	V6 Cyl.	19.5:1	2496cc	110kW (150)PS	TD11498	150



A4	09/97→09/01	A6	07/97→01/05	A8	01/97→04/00
PASSAT	07/98→05/05				











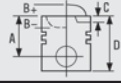

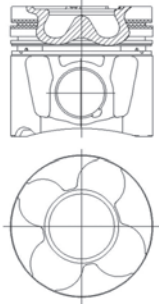

87-103000-00 [54] STD A 47.83 B- 16.50 BØ 35.80 C 1.38 D 71.83 26x66 AK KK RT	 	08-103000-00 STD 08-103007-00 0.50mm 1.75 CK P 2.00 P 3.00 CR P			
87-103000-10 [61] STD A 47.83 B- 16.50 BØ 35.80 C 1.38 D 71.83 26x66 AK KK RT	 	08-103000-00 STD 08-103007-00 0.50mm 1.75 CK P 2.00 P 3.00 CR P			

[54] To cylinder 1-3
 [61] To cylinder 4-6

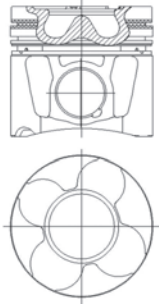
[54] Zum Zylinder 1-3
 [61] Zum Zylinder 4-6









MB/HL 1-4	4	64.959/64.978	70.000/70.019	18.000	2.508	0.020/0.070	EC	72-3712	H034/4 STD 0.25

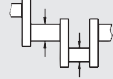
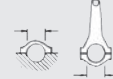

788		 78.30		Diesel			
AKE	V6 Cyl.	18.5:1	2496cc	132kW (180)PS	TD15312	150	
AYM	V6 Cyl.	18.5:1	2496cc	114kW (155)PS	TD16384	151	
AYM	V6 Cyl.	18.5:1	2496cc	114kW (155)PS	TD16404	151	
BAU	V6 Cyl.	18.5:1	2496cc	132kW (180)PS	TD17033	152	
BAU	V6 Cyl.	18.5:1	2496cc	132kW (180)PS	TD17046	152	
BCZ	V6 Cyl.	19.5:1	2496cc	120kW (163)PS	TD16859	153	
BFC	V6 Cyl.	19.5:1	2496cc	120kW (163)PS	TD16858	155	
A4	10/00→12/05	A6	02/00→01/05	A8	09/00→09/02		
ALLROAD	05/00→08/05	PASSAT	01/03→05/05	SUPERB	12/01→08/03		







					
87-103000-30 [54]	STD		08-103000-00 STD 08-103007-00 0.50mm		
A 47.83 B- 17.25 BØ 36.00 C 1.38 C 1.38 D 71.83  26x58			1.75  CK P 2.00  P 3.00  CR P		
AK KK RT TP					
87-103000-40 [61]	STD		08-103000-00 STD 08-103007-00 0.50mm		
A 78.31 B- 17.25 BØ 36.00 C 1.38 C 1.38 D 71.83  26x58			1.75  CK P 2.00  P 3.00  CR P		
AK KK RT TP					



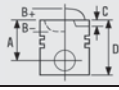



[54] To cylinder 1-3
[61] To cylinder 4-6



[54] Zum Zylinder 1-3
[61] Zum Zylinder 4-6

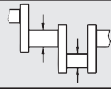
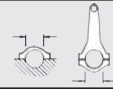



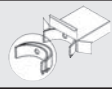
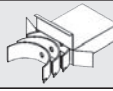

									
MB/HL 1-4	4	64.959/64.978	70.000/70.019	18.000	2.508	0.020/0.070	EC	72-3712	H034/4 STD 0.25

789		78.30	Diesel			
BDG	V6 Cyl.	18.5:1	2496cc	120kW (163)PS	TD16860	154
BDG	V6 Cyl.	18.5:1	2496cc	120kW (163)PS	TD16985	154
BDG	V6 Cyl.	18.5:1	2496cc	120kW (163)PS	TD17350	154
BDH	V6 Cyl.	18.5:1	2496cc	132kW (180)PS	TD17034	154
BDH	V6 Cyl.	18.5:1	2496cc	132kW (180)PS	TD17047	154
A4	11/00→05/06	A6	02/00→01/05	PASSAT	01/03→05/05	
SUPERB	06/03→03/08					

		
	08-103000-00 STD 08-103007-00 0.50mm 1.75  CK P 2.00  P 3.00  CR P	

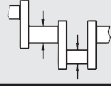
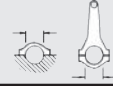

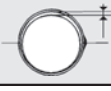

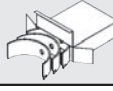

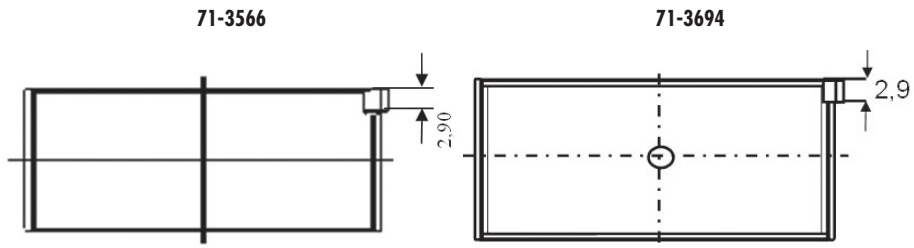

									
MB/HL 1-4	4	64.959/64.978	70.000/70.019	18.000	2.508	0.020/0.070	EC	72-3712	H034/4 STD 0.25



790		79.30	Petrol		
KW	5 Cyl.	2133cc	235kW (320)PS	TD292	158
QUATTRO	05/84→07/87				

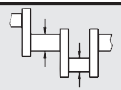
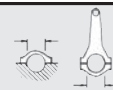

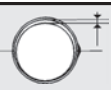

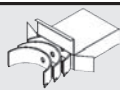



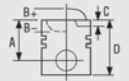
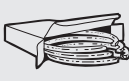

									
BE/PL	5	47.758/47.778	50.600/50.619	19.000	1.406	0.020/0.074	EC	71-3566	71-3566/5 STD
→12/85									
BE/PL	5	47.758/47.778	50.600/50.612	19.000	1.406	0.020/0.067	EC	71-3694	71-3694/5 STD 0.25
01/86→									





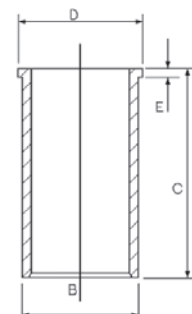



MB/HL 1-6	6	57.958/57.978	63.000/63.019	18.500	2.502	0.020/0.082	EC	72-3400	H981/6 STD 0.25
TW/A	2	63.500/63.750	77.200/77.450		1.975		AL-LF	04-3529	A124/4 STD
TW/A	2	63.500/63.750	77.200/77.450		1.975		AL-LF	04-3530	
TW/A	2	63.500/63.750	76.950/77.200		1.975		AL-LF	04-4782	A292/4 STD
TW/A	2	63.500/63.750	76.950/77.200		1.975		AL-LF	04-4783	
SE/PB	1	20.000	23.000/23.021	25.000			BC	55-3698	55-3698 SEMI

791	 79.50	Diesel								
CFWA	3 Cyl.	16.5:1	1199cc	55kW (75)PS			TD24261			
FABIA	05/10→	ROOMSTER		03/10→	ROOMSTER Praktik			03/10→		
										
MB/HL 1-5	5	53.958/53.978	59.000/59.012	18.500	2.501	0.020/0.076	EC	72-3931	H079/5 STD 0.25 0.50	



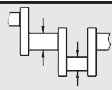
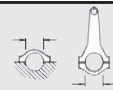

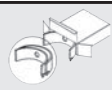
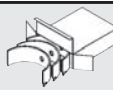

792	 79.50	Diesel								
AMF	3 Cyl.	19.5:1	1422cc	55kW (75)PS			TD12589	159		
AMF	3 Cyl.	19.5:1	1422cc	55kW (75)PS			TD13895	159		
AMF	3 Cyl.	19.5:1	1422cc	55kW (75)PS			TD17156	159		
AMF	3 Cyl.	19.5:1	1422cc	55kW (75)PS			TD17348	159		
BAY	3 Cyl.		1422cc	55kW (75)PS			TD16336	161		
BHC	3 Cyl.	19.5:1	1422cc	55kW (75)PS			TD18133	162		
A2	02/00→08/05	AROSA	01/00→06/04	CORDOBA			10/02→12/05			
FABIA	04/03→03/08	IBIZA	05/02→12/05	LUPO			01/99→07/05			
POLO	10/99→									

		
87-114900-80 [47] [55] STD 87-114907-80 [55] 0.50mm A 45.80 B- 17.65 BØ 38.00 C 1.10 D 69.80  26x63 AK KK NB RT TP	08-114900-00 STD 08-114905-00 0.25mm 08-114907-00 0.50mm 08-114911-00 1.00mm 1.75  CK P 2.00  P 3.00  CR P	14-027950-00 D B 82.50 C 152.00 D 85.50 E 4.70 
87-114900-85 [57] [47] STD 87-114907-85 [57] 0.50mm A 45.80 B- 17.65 BØ 38.00 C 1.10 D 69.80  26x63 AK KK NB RT TP	08-114900-00 STD 08-114905-00 0.25mm 08-114907-00 0.50mm 08-114911-00 1.00mm 1.75  CK P 2.00  P 3.00  CR P	
[47] Piston Chamber Volume [ccm] 23.75	[47] Volumen der Kolbenmulde [ccm] 23.75	
[55] To cylinder 1-2	[55] Zum Zylinder 1-2	
[57] To cylinder 3	[57] Zum Zylinder 3	



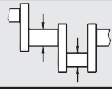
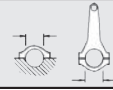

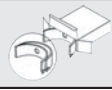
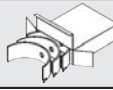

...Continued



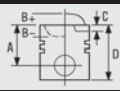



792		 79.50	Diesel							
										
BE/PL	1	47.758/47.778	50.600/50.612	20.000	1.406	0.020/0.067	SP	71-3904	71-3904 STD 0.25 0.50	[64]
CB/NWB 1-4	4	28.947/28.960	32.000/32.025	25.000	1.513	0.020/0.068	EC	73-3903	N147/4 STD	
BU	1	31.984/32.000	35.000/35.025	22.000			AL-LF	07-4037	07-4037 SEMI	
BU	1	41.984/42.000	45.000/45.025	22.000			AL-LF	07-4038	07-4038 SEMI	

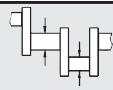
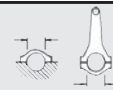

793		 79.50	Diesel							
ATL	3 Cyl.	19.5:1	1422cc	66kW (89)PS				TD17071	160	
ATL	3 Cyl.	19.5:1	1422cc	66kW (89)PS				TD21352	160	
A2	11/03→08/05	POLO		01/00→10/00						

										
BE/PL	1	47.758/47.778	50.600/50.612	20.000	1.406	0.020/0.067	SP	71-3904	71-3904 STD 0.25 0.50	[64]
CB/NWB 1-4	4	28.947/28.960	32.000/32.025	25.000	1.513	0.020/0.068	EC	73-3903	N147/4 STD	
BU	1	31.984/32.000	35.000/35.025	22.000			AL-LF	07-4037	07-4037 SEMI	
BU	1	41.984/42.000	45.000/45.025	22.000			AL-LF	07-4038	07-4038 SEMI	

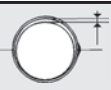

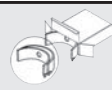
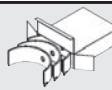



794		 79.50	Diesel							
BMS	3 Cyl.	19.5:1	1422cc	59kW (80)PS				TD18157	163	
BMS	3 Cyl.	19.5:1	1422cc	59kW (80)PS				TD18727	163	
BMS	3 Cyl.	19.5:1	1422cc	59kW (80)PS				TD19092	163	
BNM	3 Cyl.	19.5:1	1422cc	51kW (70)PS				TD18159	162	
BNM	3 Cyl.	19.5:1	1422cc	51kW (70)PS				TD18726	162	
BNM	3 Cyl.	19.5:1	1422cc	51kW (70)PS				TD18740	162	
BNV	3 Cyl.	19.5:1	1422cc	59kW (80)PS				TD18158	162	
BNV	3 Cyl.	19.5:1	1422cc	59kW (80)PS				TD18738	162	
BNV	3 Cyl.	19.5:1	1422cc	59kW (80)PS				TD18741	162	
BWB	3 Cyl.	19.5:1	1422cc	51kW (70)PS				TD20514	164	
CORDOBA	05/05→11/09	FABIA		10/05→	FOX		04/05→			
IBIZA	05/05→06/10	POLO		04/05→11/09	ROOMSTER		07/06→03/10			
ROOMSTER Praktik	03/07→03/10									

		
	08-114900-00 STD 08-114905-00 0.25mm 08-114907-00 0.50mm 08-114911-00 1.00mm	
	1.75  CK P 2.00  P 3.00  CR P	

794		 79.50	Diesel						
									
BE/PL	1	47.758/47.778	50.600/50.612	20.000	1.406	0.020/0.067	SP	71-3904	71-3904 STD 0.25 0.50 [64]
BU	1	31.984/32.000	35.000/35.025	22.000			AL-LF	07-4037	07-4037 SEMI
BU	1	41.984/42.000	45.000/45.025	22.000			AL-LF	07-4038	07-4038 SEMI

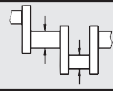
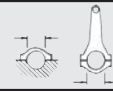
795		 79.50	Petrol				
496	4 Cyl.	8:1	1588cc	48kW (65)PS		TD22610 291	
EF	4 Cyl.	8.2:1	1588cc	60kW (81)PS		TD4066 138	
EH	4 Cyl.	8.20:1	1457cc	57kW (77)PS		TD21347 167	
EM	4 Cyl.	8.2:1	1588cc	55kW (75)PS		TD4068 168	
FP	4 Cyl.	8.2:1	1588cc	55kW (75)PS		TD4086 171	
FR	4 Cyl.	8.2:1	1588cc	63kW (85)PS		TD4088 172	
FS	4 Cyl.		1588cc	53kW (72)PS		TD258 173	
FS	4 Cyl.		1588cc	53kW (72)PS		TD16536 173	
FV	4 Cyl.	8.2:1	1588cc	51kW (70)PS		TD4090 175	
GH	4 Cyl.	8.2:1	1457cc	48kW (65)PS		TD22653 176	
WP	4 Cyl.	8.2:1	1588cc	48kW (65)PS		TD340 177	
WP	4 Cyl.	8.2:1	1588cc	48kW (65)PS		TD17200 177	
WT	4 Cyl.	8.2:1	1716cc	58kW (79)PS		TD343 195	
WV	4 Cyl.	8.2:1	1588cc	55kW (75)PS		TD345 178	
WV	4 Cyl.	8.2:1	1588cc	55kW (75)PS		TD5032 178	
WZ	4 Cyl.	8.2:1	1588cc	55kW (75)PS		TD4171 180	
WZ	4 Cyl.	8.2:1	1588cc	55kW (75)PS		TD17147 180	
XX	4 Cyl.		1588cc	74kW (100)PS		TD351 181	
YG	4 Cyl.	8.2:1	1588cc	61kW (82)PS		TD353 192	
YG	4 Cyl.	8.2:1	1588cc	61kW (82)PS		TD19257	
YH	4 Cyl.	8.2:1	1588cc	61kW (82)PS		TD354 193	
YH	4 Cyl.	8.2:1	1588cc	61kW (82)PS		TD4175 182	
YK	4 Cyl.	8.2:1	1588cc	61kW (82)PS		TD356	
YK	4 Cyl.	8.2:1	1588cc	61kW (82)PS		TD4176	
YM	4 Cyl.		1588cc	63kW (85)PS		TD357	
YT	4 Cyl.		1588cc	51kW (70)PS		TD361 186	
YU	4 Cyl.	8.2:1	1588cc	51kW (70)PS		TD4177	
ZV	4 Cyl.	8.2:1	1716cc	59kW (80)PS		TD377	

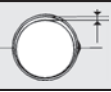
80	09/73→07/86	100	11/68→07/76	CADDY	10/82→10/83
GOLF	08/75→02/84	JETTA	08/78→02/84	PARATI	05/82→07/87
PASSAT	08/75→03/88	SANTANA	08/81→12/84	SCIROCCO	08/75→04/84

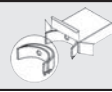
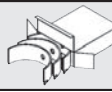





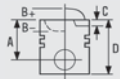

									
BE/PL	1	45.950/45.970	49.000/49.016	19.000	1.506	0.020/0.078	EC	71-3084	71-3084 STD 0.25 0.50
MB/HL	3	53.958/53.978	59.000/59.019	18.500	2.502	0.020/0.082	AL-LF	02-3085L	H025/5 STD 0.25 0.50
MB/HL	5	53.958/53.978	59.000/59.019	18.500	2.502	0.020/0.082	AL-LF	02-3085U	
MB/HL	1	53.958/53.978	59.000/59.019	24.930	2.502	0.020/0.082	AL-LF	02-3086HL	
MB/HL	1	53.958/53.978	59.000/59.019	24.930	2.502	0.020/0.082	AL-LF	02-3086HU	

...Continued

795		 79.50	Petrol							
CB/NWB 1-5	5	25.939/25.960	28.250/28.271	17.000	1.138	AL-LF	03-3317	N118/5 STD	[67]	
BU	1	42.959/42.975	46.055/46.095	15.000		AL-LF	07-3088	07-3088 STD SEMI	[68]	
BU	1	41.959/41.975	45.000/45.025	15.000		AL-LF	07-3089	07-3089 STD SEMI	[68]	







796		 79.50	Petrol							
JB	4 Cyl.	8.2:1	1457cc					51kW (70)PS	TD4115	165
WY	4 Cyl.	8.2:1	1588cc					55kW (75)PS	TD348	191
WY	4 Cyl.	8.2:1	1588cc					55kW (75)PS	TD21343	179
YN	4 Cyl.	8.2:1	1588cc					55kW (75)PS	TD358	183
YN	4 Cyl.	8.2:1	1588cc					55kW (75)PS	TD5034	183
YP	4 Cyl.	8.2:1	1588cc					63kW (85)PS	TD359	184
YP	4 Cyl.	8.2:1	1588cc					63kW (85)PS	TD5035	184
YV	4 Cyl.		1588cc					63kW (85)PS	TD362	187
YY	4 Cyl.	9:1	1588cc					51kW (70)PS	TD363	188
YY	4 Cyl.	9:1	1588cc					51kW (70)PS	TD22655	188

80	09/75→07/86	100	08/76→02/83	CADDY	08/82→07/83
COUPE	07/80→08/81	GOLF	08/77→11/83	JETTA	08/78→02/84
PASSAT	08/75→03/88	SANTANA	08/81→12/82	SCIROCCO	08/77→12/83

		
	<p>08-404100-00 STD 08/77→08/84</p> <p>1.75  CR P 2.00  P 4.00  CR[52]</p>	
	<p>08-404700-10 STD 08-404705-10 0.25mm 08-404707-10 0.50mm 08/77→08/84</p> <p>1.75  CR P 2.00  P 4.00  CR[52]</p>	

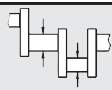
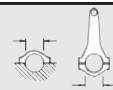
[52] Steel

[52] Stahl

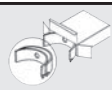
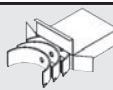
									
BE/PL	1	45.950/45.970	49.000/49.016	19.000	1.506	0.020/0.078	EC	71-3084	71-3084 STD 0.25 0.50
MB/HL	3	53.958/53.978	59.000/59.019	18.500	2.502	0.020/0.082	AL-LF	02-3085L	H025/5 STD 0.25 0.50
MB/HL	5	53.958/53.978	59.000/59.019	18.500	2.502	0.020/0.082	AL-LF	02-3085U	
MB/HL	1	53.958/53.978	59.000/59.019	24.930	2.502	0.020/0.082	AL-LF	02-3086HL	
MB/HL	1	53.958/53.978	59.000/59.019	24.930	2.502	0.020/0.082	AL-LF	02-3086HU	
CB/NWB 1-5	5	25.939/25.960	28.250/28.271	17.000	1.138		AL-LF	03-3317	N118/5 STD [67]
BU	1	42.959/42.975	46.055/46.095	15.000			AL-LF	07-3088	07-3088 STD SEMI [68]
BU	1	41.959/41.975	45.000/45.025	15.000			AL-LF	07-3089	07-3089 STD SEMI [68]

797	79.50	Petrol	
EE	4 Cyl.	1588cc	60kW (81)PS
			TD4065 137

	08-399200-00 STD 08/75→07/77 1.75 CR P 2.50 P 5.00 P	

798	79.50	Petrol	
------------	--------------	---------------	--

EG	4 Cyl.	9.5:1	1588cc	81kW (110)PS	TD4999	166
YS	4 Cyl.	9.5:1	1588cc	81kW (110)PS	TD360	185
YS	4 Cyl.	9.5:1	1588cc	81kW (110)PS	TD9378	185
YZ	4 Cyl.	9.5:1	1588cc	81kW (110)PS	TD364	189

80	01/76→12/86	GOLF	08/76→07/82	JETTA	08/78→07/82
PASSAT	08/77→07/80	SCIROCCO	06/76→07/82		

	08-405000-00 STD 1.75 MO P 2.00 P 4.00 CR[52]	

[52] Steel [52] Stahl

BE/PL	1	45.950/45.970	49.000/49.016	19.000	1.506	0.020/0.078	EC	71-3084	71-3084 STD 0.25 0.50	
MB/HL	3	53.958/53.978	59.000/59.019	18.500	2.502	0.020/0.082	AL-LF	02-3085L	H025/5 STD 0.25 0.50	
MB/HL	5	53.958/53.978	59.000/59.019	18.500	2.502	0.020/0.082	AL-LF	02-3085U		
MB/HL	1	53.958/53.978	59.000/59.019	24.930	2.502	0.020/0.082	AL-LF	02-3086HL		
MB/HL	1	53.958/53.978	59.000/59.019	24.930	2.502	0.020/0.082	AL-LF	02-3086HU		
CB/NWB 1-5	5	25.939/25.960	28.250/28.271	17.000	1.138		AL-LF	03-3317	N118/5 STD [67]	
BU	1	42.959/42.975	46.055/46.095	15.000			AL-LF	07-3088	07-3088 STD SEMI [68]	
BU	1	41.959/41.975	45.000/45.025	15.000			AL-LF	07-3089	07-3089 STD SEMI [68]	

799

79.50

Petrol



FN	4 Cyl.	1588cc	51kW (70)PS	TD4085	170
GOLF	08/75→02/84	SCIROCCO	08/75→07/79		

	<p>08-399200-00 STD 08/75→07/77</p> <p>1.75 CR P 2.50 P 5.00 P</p>	
	<p>08-404100-00 STD 08/77→05/84</p> <p>1.75 CR P 2.00 P 4.00 CR[52]</p>	

[52] Steel

[52] Stahl

BE/PL	1	45.950/45.970	49.000/49.016	19.000	1.506	0.020/0.078	EC	71-3084	71-3084 STD 0.25 0.50	
MB/HL	3	53.958/53.978	59.000/59.019	18.500	2.502	0.020/0.082	AL-LF	02-3085L	H025/5 STD 0.25 0.50	
MB/HL	5	53.958/53.978	59.000/59.019	18.500	2.502	0.020/0.082	AL-LF	02-3085U		
MB/HL	1	53.958/53.978	59.000/59.019	24.930	2.502	0.020/0.082	AL-LF	02-3086HL		
MB/HL	1	53.958/53.978	59.000/59.019	24.930	2.502	0.020/0.082	AL-LF	02-3086HU		
CB/NWB 1-5	5	25.939/25.960	28.250/28.271	17.000	1.138		AL-LF	03-3317	N118/5 STD	[67]
BU	1	42.959/42.975	46.055/46.095	15.000			AL-LF	07-3088	07-3088 STD SEMI	[68]
BU	1	41.959/41.975	45.000/45.025	15.000			AL-LF	07-3089	07-3089 STD SEMI	[68]

800

 **79.50**

Petrol





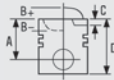







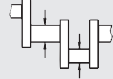
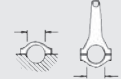

FT	4 Cyl.	1588cc	51kW (70)PS	TD4089	174
GOLF	08/75→07/77	SCIROCCO	08/75→07/77		











08-399200-00 STD
08/75→07/77

- 1.75  CR P
- 2.50  P
- 5.00  P

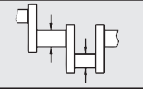
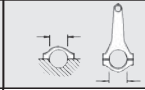
										
BE/PL	1	45.950/45.970	49.000/49.016	19.000	1.506	0.020/0.078	EC	71-3084	71-3084 STD 0.25 0.50	
MB/HL	3	53.958/53.978	59.000/59.019	18.500	2.502	0.020/0.082	AL-LF	02-3085L	H025/5 STD 0.25 0.50	
MB/HL	5	53.958/53.978	59.000/59.019	18.500	2.502	0.020/0.082	AL-LF	02-3085U		
MB/HL	1	53.958/53.978	59.000/59.019	24.930	2.502	0.020/0.082	AL-LF	02-3086HL		
MB/HL	1	53.958/53.978	59.000/59.019	24.930	2.502	0.020/0.082	AL-LF	02-3086HU		
CB/NWB 1-5	5	25.939/25.960	28.250/28.271	17.000	1.138		AL-LF	03-3317	N118/5 STD	[67]
BU	1	42.959/42.975	46.055/46.095	15.000			AL-LF	07-3088	07-3088 STD SEMI	[68]
BU	1	41.959/41.975	45.000/45.025	15.000			AL-LF	07-3089	07-3089 STD SEMI	[68]

801		 79.50	Diesel			
CAYA	4 Cyl.	16.5:1	1598cc	55kW (75)PS	TD23105	
CAYA	4 Cyl.	16.5:1	1598cc	55kW (75)PS	TD24216	
CAYB	4 Cyl.	16.5:1	1598cc	66kW (89)PS	TD22638	
CAYB	4 Cyl.	16.5:1	1598cc	66kW (89)PS	TD22661	
CAYB	4 Cyl.	16.5:1	1598cc	66kW (89)PS	TD22670	
CAYB	4 Cyl.	16.5:1	1598cc	66kW (89)PS	TD23929	
CAYC	4 Cyl.		1598cc	77kW (105)PS	TD22639	
CAYC	4 Cyl.		1598cc	77kW (105)PS	TD22662	
CAYC	4 Cyl.		1598cc	77kW (105)PS	TD22671	
CAYC	4 Cyl.		1598cc	77kW (105)PS	TD22678	
CAYD	4 Cyl.		1598cc	75kW (102)PS	TD24364	
CAYE	4 Cyl.		1598cc	55kW (75)PS	TD24365	
CLNA	4 Cyl.	16.5:1	1598cc	77kW (105)PS	TD23934	

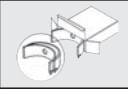
A1	05/10→	A3	05/09→	ALTEA	10/09→
ALTEA XL	10/09→	BEETLE	10/11→	CADDY	08/10→
FABIA	03/10→	GOLF	02/09→	IBIZA	05/09→
JETTA	06/09→	LEON	02/10→	OCTAVIA	06/09→
PASSAT	08/09→	POLO	06/09→	RAPID	07/12→
ROOMSTER	03/10→	ROOMSTER Praktik	03/10→	SUPERB	09/10→
TOLEDO	07/12→	TOURAN	04/10→	YETI	11/10→

									
→11/11									
MB/HL 2-5	4	53.958/53.978	59.000/59.019	18.500	2.502	0.020/0.082	AL-LF	02-3085L	H1328/5 STD
MB/HL 2-5	4	53.958/53.978	59.000/59.019	18.500	2.502	0.020/0.082	AL-LF	02-3085U	
MB/HL 1	1	53.958/53.978	59.000/59.012	18.500	2.506	0.020/0.062	IX-LF	02-4941L	
MB/HL 1	1	53.958/53.978	59.000/59.012	18.500	2.506	0.020/0.062	IX-LF	02-4941U	
12/11→									

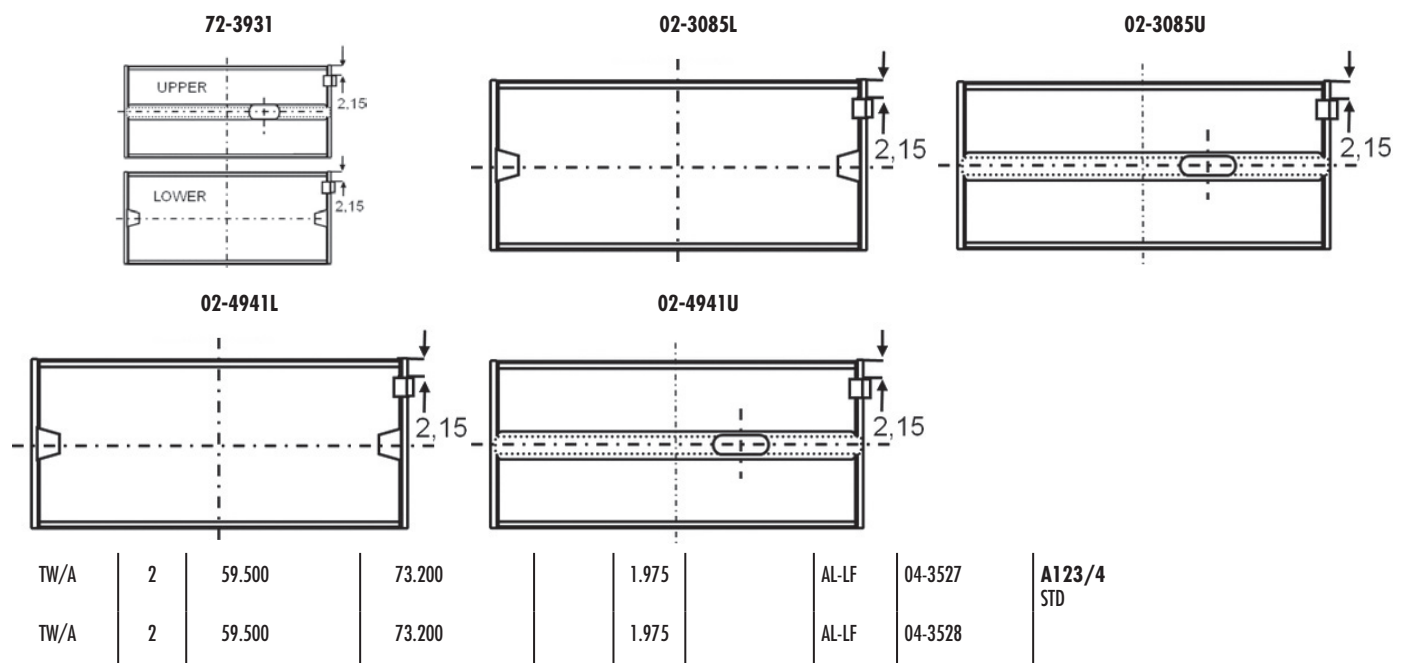

TW/A	2	59.500	73.200		1.975		AL-LF	04-3527	A123/4 STD
TW/A	2	59.500	73.200		1.975		AL-LF	04-3528	

802	79.50	Diesel	
KY	4 Cyl.	23:1	1715cc
			42kW (57)PS
			TD4126 194
TRANSPORTER 08/85→07/92			



	08-990100-00 STD 08-990105-00 0.25mm 08-990107-00 0.50mm 08-990111-00 1.00mm 1.75 CR P 2.00 P 3.00 CR P	













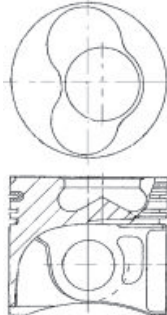

BE/PL	4	47.758/47.778	50.600/50.619	19.000	1.406	0.020/0.074	EC	71-3442	71-3442/4 STD 0.25 0.50 0.75
MB/HL 1-5	5	53.958/53.978	59.000/59.019	18.500	2.502	0.020/0.082	AL-LF	02-3085L	H084/5 STD 0.25 0.50
MB/HL 1-5	5	53.958/53.978	59.000/59.019	18.500	2.502	0.020/0.082	AL-LF	02-3085U	
TW/A	2	59.500	73.200		1.975		AL-LF	04-3527	A123/4 STD
TW/A	2	59.500	73.200		1.975		AL-LF	04-3528	
SE/PB	1	24.000/24.012	27.000/27.021	25.000			BC	55-3443	55-3443 SEMI

803	79.50	Petrol	
EN	4 Cyl.	8.2:1	1716cc
			57kW (77)PS
			TD22652 169

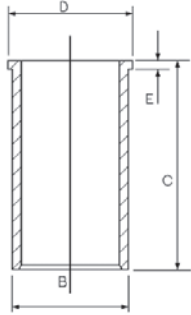
BE/PL	4	47.758/47.778	50.600/50.619	19.000	1.406	0.020/0.074	EC	71-3442	71-3442/4 STD 0.25 0.50 0.75
MB/HL 1-5	5	53.958/53.978	59.000/59.019	18.500	2.502	0.020/0.082	AL-LF	02-3085L	H084/5 STD 0.25 0.50
MB/HL 1-5	5	53.958/53.978	59.000/59.019	18.500	2.502	0.020/0.082	AL-LF	02-3085U	
TW/A	2	59.500	73.200		1.975		AL-LF	04-3527	A123/4 STD
TW/A	2	59.500	73.200		1.975		AL-LF	04-3528	
CB/NWB 1-5	5	25.939/25.960	28.250/28.271	17.000	1.138		AL-LF	03-3317	N118/5 STD

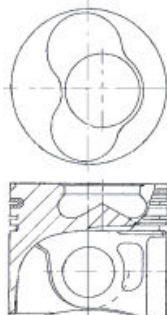









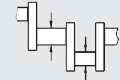

[67]

804	 79.50	Diesel				
AHB	4 Cyl.	19.5:1	1716cc	42kW (57)PS	TD9403	197
AHB	4 Cyl.	19.5:1	1716cc	42kW (57)PS	TD15028	197
AHG	4 Cyl.	19.5:1	1716cc	42kW (57)PS	TD11207	198
AKU	4 Cyl.	19.5:1	1716cc	44kW (60)PS	TD9513	199
AKU	4 Cyl.	19.5:1	1716cc	44kW (60)PS	TD13896	199
AKW	4 Cyl.	19.5:1	1716cc	42kW (57)PS	TD9687	200
AROSA	08/97→06/04	CADDY	07/96→09/00	CORDOBA	07/97→06/99	
INCA	09/96→06/03	LUPO	09/98→07/05	POLO	04/97→09/01	

		
<p>87-114900-40 [42] [55] STD 87-114907-40 [30] [55] 0.50mm</p> <p>A 44.35 B- 16.75 BØ 38.00 C 1.00 D 70.35</p> <p> 24x63</p> <p>AK RT</p> <p style="text-align: center;"> 07958</p>	<p>08-114900-00 STD 08-114905-00 0.25mm 08-114907-00 0.50mm 08-114911-00 1.00mm</p> <p>1.75  CK P 2.00  P 3.00  CR P</p>	<p>14-027950-00 D B 82.50 C 152.00 D 85.50 E 4.70</p> <p style="text-align: center;"></p>
<p>87-114900-50 [42] [59] STD 87-114907-50 [30] [59] 0.50mm</p> <p>A 44.35 B- 16.75 BØ 38.00 C 1.00 D 70.35</p> <p> 24x63</p> <p>AK RT</p> <p style="text-align: center;"> 07958A</p>	<p>08-114900-00 STD 08-114905-00 0.25mm 08-114907-00 0.50mm 08-114911-00 1.00mm</p> <p>1.75  CK P 2.00  P 3.00  CR P</p>	

[30] A = 44.100, D = 70.100
 [42] Piston Chamber Volume [ccm] 20.70
 [55] To cylinder 1-2
 [59] To cylinder 3-4

[30] A = 44.100, D = 70.100
 [42] Volumen der Kolbenmulde [ccm] 20.70
 [55] Zum Zylinder 1-2
 [59] Zum Zylinder 3-4

												
BE/PL	4	47.758/47.778	50.600/50.619	19.000	1.406	0.020/0.074	EC	71-3442	71-3442/4 STD 0.25 0.50 0.75			
MB/HL 1-5	5	53.958/53.978	59.000/59.019	18.500	2.502	0.020/0.082	AL-LF	02-3085L	H084/5 STD 0.25 0.50			
MB/HL 1-5	5	53.958/53.978	59.000/59.019	18.500	2.502	0.020/0.082	AL-LF	02-3085U				
TW/A	2	59.500	73.200		1.975		AL-LF	04-3527	A123/4 STD			
TW/A	2	59.500	73.200		1.975		AL-LF	04-3528				
SE/PB	1	24.000	27.000/27.021	25.000			BC	55-3696	55-3696 SEMI			

805

79.50

Diesel



1X 4 Cyl. 22.5:1 1896cc 44kW (60)PS TD3997 201

TRANSPORTER 07/90 → 12/95

<p>87-990100-40 STD</p> <p>87-990105-40 0.25mm</p> <p>87-990107-40 [27] 0.50mm</p> <p>87-990111-40 [27] 1.00mm</p>	<p>07945</p>	<p>08-990100-00 STD</p> <p>08-990105-00 0.25mm</p> <p>08-990107-00 0.50mm</p> <p>08-990111-00 1.00mm</p>
<p>A 39.65</p> <p>B- 1.90</p> <p>D 65.70</p> <p> 24x64</p> <p>AK RT</p>	<p>1.75 CR P</p> <p>2.00 P</p> <p>3.00 CR P</p>	<p>14-027950-00 D B 82.50 C 152.00 D 85.50 E 4.70</p>

[27] A = 39.400

[27] A = 39.400



BE/PL	4	47.758/47.778	50.600/50.619	19.000	1.406	0.020/0.074	EC	71-3442	71-3442/4 STD 0.25 0.50 0.75
MB/HL	4	53.958/53.978	59.000/59.019	18.500	2.502	0.020/0.082	AL-LF	02-3085L	H027/5 STD 0.25 0.50
MB/HL	6	53.958/53.978	59.000/59.019	18.500	2.502	0.020/0.082	AL-LF	02-3085U	
MB/HL 1-5	5	53.958/53.978	59.000/59.019	18.500	2.502	0.020/0.082	AL-LF	02-3085L	H084/5 STD 0.25 0.50
MB/HL 1-5	5	53.958/53.978	59.000/59.019	18.500	2.502	0.020/0.082	AL-LF	02-3085U	

02-3085L

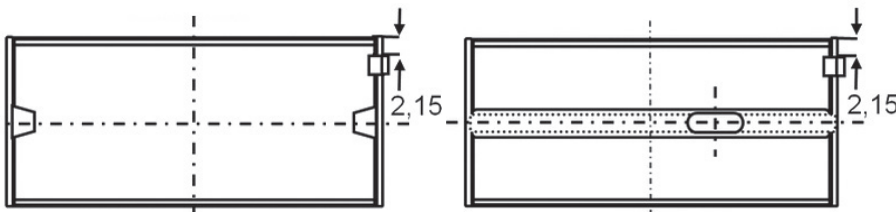





02-3085U

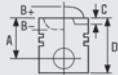
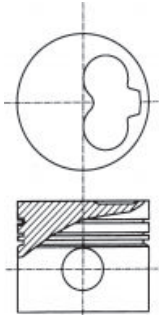

TW/A	2	59.500	73.200		1.975	AL-LF	04-3527	A123/4 STD
TW/A	2	59.500	73.200		1.975	AL-LF	04-3528	
SE/PB	1	24.000	27.000/27.021	25.000		BC	55-3696	55-3696 SEMI





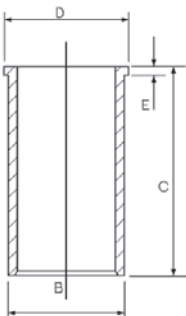



806	 79.50	Diesel				
1Y	4 Cyl.	22.5:1	1896cc	47kW (64)PS	TD213	202
1Y	4 Cyl.	22.5:1	1896cc	47kW (64)PS	TD4891	202
1Y	4 Cyl.	22.5:1	1896cc	47kW (64)PS	TD4960	202
AEF	4 Cyl.	22.5:1	1896cc	47kW (64)PS	TD4020	209
AEF	4 Cyl.	22.5:1	1896cc	47kW (64)PS	TD9373	209
AEF	4 Cyl.	22.5:1	1896cc	47kW (64)PS	TD13395	209

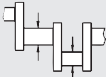
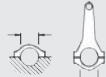

80	08/89→08/91	CADDY	11/95→06/09	CORDOBA	02/93→08/96
FELICIA	10/95→04/02	GOL	06/02→12/10	GOLF	11/91→04/99
IBIZA	04/93→08/96	INCA	11/95→06/03	PARATI	08/02→
PASSAT	05/89→10/93	POLO	10/94→09/01	TOLEDO	05/91→03/99
VENTO	11/91→09/98	VOYAGE	06/96→09/01		

	 <p>07945</p>		<p>08-990100-00 STD 08-990105-00 0.25mm 08-990107-00 0.50mm 08-990111-00 1.00mm</p> <p>1.75  CR P 2.00  P 3.00  CR P</p>	 <p>14-027950-00 D B 82.50 C 152.00 D 85.50 E 4.70</p> 
---	--	---	--	---



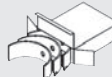







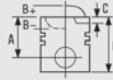

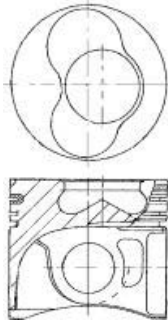

A 39.65
B- 1.90
D 65.70
 24x64
AK RT

[27] A = 39.400 [27] A = 39.400

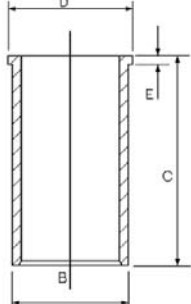
									
BE/PL	4	47.758/47.778	50.600/50.619	19.000	1.406	0.020/0.074	EC	71-3442	71-3442/4 STD 0.25 0.50 0.75
MB/HL 1-5	5	53.958/53.978	59.000/59.019	18.500	2.502	0.020/0.082	AL-LF	02-3085L	H084/5 STD 0.25 0.50
MB/HL 1-5	5	53.958/53.978	59.000/59.019	18.500	2.502	0.020/0.082	AL-LF	02-3085U	
TW/A	2	59.500	73.200		1.975		AL-LF	04-3527	A123/4 STD
TW/A	2	59.500	73.200		1.975		AL-LF	04-3528	
SE/PB	1	24.000	27.000/27.021	25.000			BC	55-3696	55-3696 SEMI

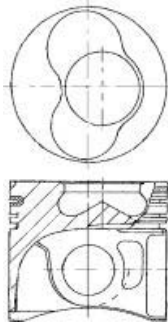









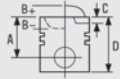

807	 79.50	Diesel				
1Z	4 Cyl.	19.5:1	1896cc	66kW (89)PS	TD214	203
1Z	4 Cyl.	19.5:1	1896cc	66kW (89)PS	TD4961	203
1Z	4 Cyl.	19.5:1	1896cc	66kW (89)PS	TD5527	203
AFF	4 Cyl.		1896cc	55kW (75)PS	TD11597	211
AHH	4 Cyl.	19.5:1	1896cc	66kW (89)PS	TD10927	217
AHH	4 Cyl.	19.5:1	1896cc	66kW (89)PS	TD16413	217
ALH	4 Cyl.	19.5:1	1896cc	66kW (89)PS	TD9455	221
ALH	4 Cyl.	19.5:1	1896cc	66kW (89)PS	TD11595	221
ALH	4 Cyl.	19.5:1	1896cc	66kW (89)PS	TD13272	221
ALH	4 Cyl.	19.5:1	1896cc	66kW (89)PS	TD16090	221

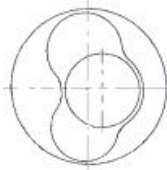
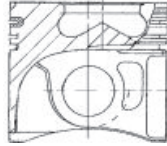
80	09/91→01/96	A3	09/96→07/01	A4	01/95→09/01
A6	06/94→12/97	ALHAMBRA	04/96→03/10	BORA	10/98→06/01
CABRIOLET	06/95→08/00	CADDY	09/96→01/04	CORDOBA	08/96→12/02
GOLF	09/93→05/06	IBIZA	08/96→02/02	INCA	09/96→06/03
LEON	11/99→06/06	NEW BEETLE	01/98→06/04	OCTAVIA	09/96→03/10
PASSAT	10/93→11/00	POLO	09/96→09/01	SHARAN	09/95→03/10
TOLEDO	08/95→05/06	VENTO	09/93→09/98	VOYAGE	09/99→09/01

		
<p>87-114900-60 [45] [55] STD 87-114905-60 [55] 0.25mm 87-114907-60 [33] [55] 0.50mm 87-114911-60 [33] [55] 1.00mm</p> <p>A 45.80 B- 17.65 BØ 38.00 C 1.10 D 68.80  26x66</p> <p>AK KK NB RT</p> <p> 07987</p>	<p>08-114900-00 STD 08-114905-00 0.25mm 08-114907-00 0.50mm 08-114911-00 1.00mm</p> <p>1.75  CK P 2.00  P 3.00  CR P</p>	<p>14-027950-00 D B 82.50 C 152.00 D 85.50 E 4.70</p> <p></p>
<p>87-114900-70 [45] [59] STD 87-114905-70 [59] 0.25mm 87-114907-70 [33] [59] 0.50mm 87-114911-70 [33] [59] 1.00mm</p> <p>A 45.80 B- 17.65 BØ 38.00 C 1.10 D 68.80  26x66</p> <p>AK KK NB RT</p> <p> 07987A</p>	<p>08-114900-00 STD 08-114905-00 0.25mm 08-114907-00 0.50mm 08-114911-00 1.00mm</p> <p>1.75  CK P 2.00  P 3.00  CR P</p>	

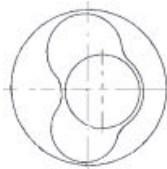
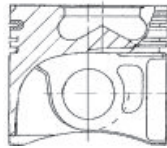









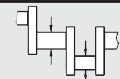

...Continued

807  **79.50** **Diesel**

			
87-114900-90 [55] STD 87-114905-90 [55] 0.25mm 87-114907-90 [34] [55] 0.50mm 87-114911-90 [34] [55] 1.00mm A 45.80 B- 17.65 BØ 38.00 C 1.10 D 71.80  26x66 AK NB RT	 	08-114900-00 STD 08-114905-00 0.25mm 08-114907-00 0.50mm 08-114911-00 1.00mm 1.75  CK P 2.00  P 3.00  CR P	
87-114900-95 [59] STD 87-114905-95 [59] 0.25mm 87-114907-95 [34] [59] 0.50mm 87-114911-95 [34] [59] 1.00mm A 45.80 B- 17.65 BØ 38.00 C 1.10 D 71.80  26x66 AK NB RT	 	08-114900-00 STD 08-114905-00 0.25mm 08-114907-00 0.50mm 08-114911-00 1.00mm 1.75  CK P 2.00  P 3.00  CR P	

[33] A = 45.550, D = 68.550
 [34] A = 45.550, D = 71.550
 [45] Piston Chamber Volume [ccm] 23.54
 [55] To cylinder 1-2
 [59] To cylinder 3-4

[33] A = 45.550, D = 68.550
 [34] A = 45.550, D = 71.550
 [45] Volumen der Kolbenmulde [ccm] 23.54
 [55] Zum Zylinder 1-2
 [59] Zum Zylinder 3-4

												
BE/PL	4	47.758/47.778	50.600/50.619	20.000	1.406	0.020/0.074	EC	71-3728	71-3728/4 STD 0.25 0.50			
MB/HL 1-5	5	53.958/53.978	59.000/59.019	18.500	2.502	0.020/0.082	AL-LF	02-3085L	H084/5 STD 0.25 0.50			
MB/HL 1-5	5	53.958/53.978	59.000/59.019	18.500	2.502	0.020/0.082	AL-LF	02-3085U				
TW/A	2	59.500	73.200		1.975		AL-LF	04-3527	A123/4 STD			
TW/A	2	59.500	73.200		1.975		AL-LF	04-3528				
SE/PB	1	26.000	29.000/29.052	25.000			BC	55-3729	55-3729 SEMI			
BU	1	42.959/42.975	46.055/46.095	15.000			AL-LF	07-3088	07-3088 STD SEMI			[68]
BU	1	41.959/41.975	45.000/45.025	15.000			AL-LF	07-3089	07-3089 STD SEMI			[68]

808

79.50

Diesel



AAZ	4 Cyl.	22.5:1	1896cc	55kW (75)PS	TD229	204
AAZ	4 Cyl.	22.5:1	1896cc	55kW (75)PS	TD4894	204
AAZ	4 Cyl.	22.5:1	1896cc	55kW (75)PS	TD4972	204
ABL	4 Cyl.	22.5:1	1896cc	50kW (68)PS	TD4009	205



80	09/91→12/94	CORDOBA	02/93→08/96	GOLF	11/91→09/99
IBIZA	03/93→08/96	PASSAT	03/91→05/97	TOLEDO	05/91→03/99
TRANSPORTER	10/92→04/03	VENTO	11/91→09/98		







87-990100-10 STD 87-990105-10 0.25mm 87-990107-10 [31] 0.50mm 87-990111-10 [31] 1.00mm	08-990100-00 STD 08-990105-00 0.25mm 08-990107-00 0.50mm 08-990111-00 1.00mm	14-027950-00 D B 82.50 C 152.00 D 85.50 E 4.70
A 45.65 B- 1.90 D 71.70 26x66 AK HA RT	1.75 CR P 2.00 P 3.00 CR P	

[31] A = 45.430

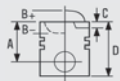





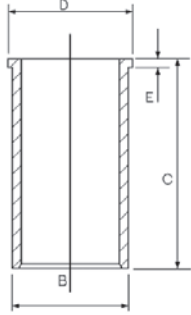

[31] A = 45.430

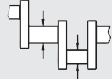
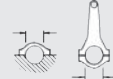

BE/PL	4	47.758/47.778	50.600/50.619	20.000	1.406	0.020/0.074	EC	71-3728	71-3728/4 STD 0.25 0.50
MB/HL 1-5	5	53.958/53.978	59.000/59.019	18.500	2.502	0.020/0.082	AL-LF	02-3085L	H084/5 STD 0.25 0.50
MB/HL 1-5	5	53.958/53.978	59.000/59.019	18.500	2.502	0.020/0.082	AL-LF	02-3085U	
TW/A	2	59.500	73.200		1.975		AL-LF	04-3527	A123/4 STD
TW/A	2	59.500	73.200		1.975		AL-LF	04-3528	
SE/PB	1	26.000	29.000/29.052	25.000			BC	55-3729	55-3729 SEMI
BU	1	42.959/42.975	46.055/46.095	15.000			AL-LF	07-3088	07-3088 STD SEMI [68]
BU	1	41.959/41.975	45.000/45.025	15.000			AL-LF	07-3089	07-3089 STD SEMI [68]







809	 79.50	Diesel				
ADE	4 Cyl.	22.5:1	1896cc	55kW (75)PS	TD20097	206
ADE	4 Cyl.	22.5:1	1896cc	55kW (75)PS	TD22656	207

		
87-990100-10 STD 87-990105-10 0.25mm 87-990107-10 [31] 0.50mm 87-990111-10 [31] 1.00mm A 45.65 B- 1.90 D 71.70  26x66 AK HA RT	08-990100-00 STD 08-990105-00 0.25mm 08-990107-00 0.50mm 08-990111-00 1.00mm 1.75  CR P 2.00  P 3.00  CR P	14-027950-00 D B 82.50 C 152.00 D 85.50 E 4.70 

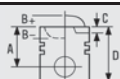
[31] A = 45.430 [31] A = 45.430





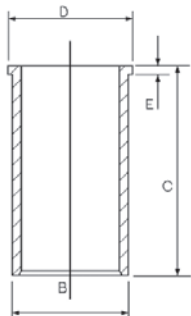

									
BE/PL	4	47.758/47.778	50.600/50.619	20.000	1.406	0.020/0.074	EC	71-3728	71-3728/4 STD 0.25 0.50
MB/HL 1-5	5	53.958/53.978	59.000/59.019	18.500	2.502	0.020/0.082	AL-LF	02-3085L	H084/5 STD 0.25 0.50
MB/HL 1-5	5	53.958/53.978	59.000/59.019	18.500	2.502	0.020/0.082	AL-LF	02-3085U	
TW/A	2	59.500	73.200		1.975		AL-LF	04-3527	A123/4 STD
TW/A	2	59.500	73.200		1.975		AL-LF	04-3528	
SE/PB	1	26.000	29.000/29.052	25.000			BC	55-3729	55-3729 SEMI

810	 79.50	Diesel				
ADG	4 Cyl.	22.5:1	1896cc	48kW (65)PS	TD20098	208

		
87-990100-40 STD 87-990105-40 0.25mm 87-990107-40 [27] 0.50mm 87-990111-40 [27] 1.00mm A 39.65 B- 1.90 D 65.70  24x64 AK RT 07945	08-990100-00 STD 08-990105-00 0.25mm 08-990107-00 0.50mm 08-990111-00 1.00mm 1.75  CR P 2.00  P 3.00  CR P	14-027950-00 D B 82.50 C 152.00 D 85.50 E 4.70 

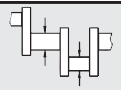
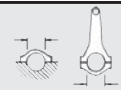
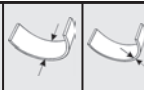
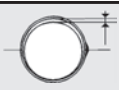
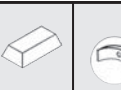
[27] A = 39.400 [27] A = 39.400

810 79.50 Diesel











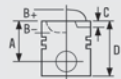

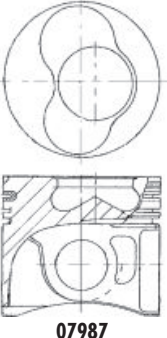

									
BE/PL	4	47.758/47.778	50.600/50.619	19.000	1.406	0.020/0.074	EC	71-3442	71-3442/4 STD 0.25 0.50 0.75
MB/HL 1-5	5	53.958/53.978	59.000/59.019	18.500	2.502	0.020/0.082	AL-LF	02-3085L	H084/5 STD 0.25 0.50
MB/HL 1-5	5	53.958/53.978	59.000/59.019	18.500	2.502	0.020/0.082	AL-LF	02-3085U	
TW/A	2	59.500	73.200		1.975		AL-LF	04-3527	A123/4 STD
TW/A	2	59.500	73.200		1.975		AL-LF	04-3528	
SE/PB	1	24.000	27.000/27.021	25.000			BC	55-3696	55-3696 SEMI
CB/NWB 1-5	5	25.939/25.960	28.250/28.271	17.000	1.138		AL-LF	03-3317	N118/5 STD

[67]

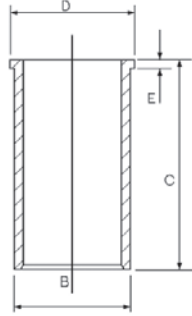
811 79.50 Diesel

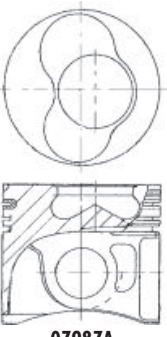
AEY	4 Cyl.	19.5:1	1896cc	47kW (64)PS	TD4985	210
AEY	4 Cyl.	19.5:1	1896cc	47kW (64)PS	TD5535	210
AEY	4 Cyl.	19.5:1	1896cc	47kW (64)PS	TD18729	210
AGD	4 Cyl.	22.5:1	1896cc	47kW (64)PS	TD9372	213

CADDY	11/95→01/04	CORDOBA	08/96→06/99	GOLF	07/95→04/99
IBIZA	08/96→08/99	INCA	11/95→06/03	POLO	12/95→09/01
VENTO	04/97→09/98				











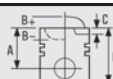

		
<p>87-114900-60 [45] [55] STD 87-114905-60 [55] 0.25mm 87-114907-60 [33] [55] 0.50mm 87-114911-60 [33] [55] 1.00mm</p> <p>A 45.80 B- 17.65 BØ 38.00 C 1.10 D 68.80  26x66</p> <p>AK KK NB RT</p>  <p>07987</p>	<p>08-114900-00 STD 08-114905-00 0.25mm 08-114907-00 0.50mm 08-114911-00 1.00mm</p> <p>1.75  CK P 2.00  P 3.00  CR P</p>	<p>14-027950-00 D B 82.50 C 152.00 D 85.50 E 4.70</p> 
<p>87-114900-70 [45] [59] STD 87-114905-70 [59] 0.25mm 87-114907-70 [33] [59] 0.50mm 87-114911-70 [33] [59] 1.00mm</p> <p>A 45.80 B- 17.65 BØ 38.00 C 1.10 D 68.80  26x66</p> <p>AK KK NB RT</p>  <p>07987A</p>	<p>08-114900-00 STD 08-114905-00 0.25mm 08-114907-00 0.50mm 08-114911-00 1.00mm</p> <p>1.75  CK P 2.00  P 3.00  CR P</p>	

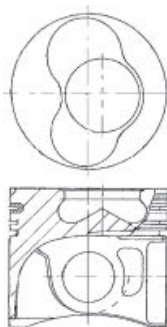
...Continued

811

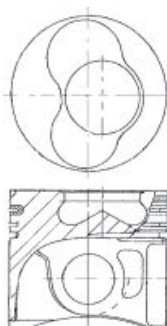
 79.50

Diesel

		
<p>87-114900-90 [55] STD 87-114905-90 [55] 0.25mm 87-114907-90 [34] [55] 0.50mm 87-114911-90 [34] [55] 1.00mm</p> <p>A 45.80 B- 17.65 BØ 38.00 C 1.10 D 71.80  26x66</p> <p>AK NB RT</p> 	<p>08-114900-00 STD 08-114905-00 0.25mm 08-114907-00 0.50mm 08-114911-00 1.00mm</p> <p>1.75  CK P 2.00  P 3.00  CR P</p>	
<p>87-114900-95 [59] STD 87-114905-95 [59] 0.25mm 87-114907-95 [34] [59] 0.50mm 87-114911-95 [34] [59] 1.00mm</p> <p>A 45.80 B- 17.65 BØ 38.00 C 1.10 D 71.80  26x66</p> <p>AK NB RT</p> 	<p>08-114900-00 STD 08-114905-00 0.25mm 08-114907-00 0.50mm 08-114911-00 1.00mm</p> <p>1.75  CK P 2.00  P 3.00  CR P</p>	

[33] A = 45.550, D = 68.550

[33] A = 45.550, D = 68.550

[34] A = 45.550, D = 71.550

[34] A = 45.550, D = 71.550

[45] Piston Chamber Volume [ccm] 23.54









[45] Volumen der Kolbenmulde [ccm] 23.54

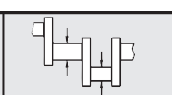

[55] To cylinder 1-2





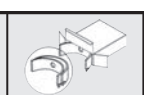
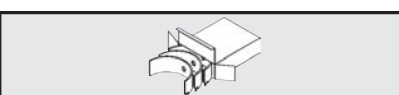



[55] Zum Zylinder 1-2

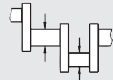
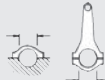

[59] To cylinder 3-4

[59] Zum Zylinder 3-4



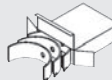







									
BE/PL	4	47.758/47.778	50.600/50.619	20.000	1.406	0.020/0.074	EC	71-3728	71-3728/4 STD 0.25 0.50
MB/HL 1-5	5	53.958/53.978	59.000/59.019	18.500	2.502	0.020/0.082	AL-LF	02-3085L	H084/5 STD 0.25 0.50
MB/HL 1-5	5	53.958/53.978	59.000/59.019	18.500	2.502	0.020/0.082	AL-LF	02-3085U	
TW/A	2	59.500	73.200		1.975		AL-LF	04-3527	A123/4 STD
TW/A	2	59.500	73.200		1.975		AL-LF	04-3528	
SE/PB	1	26.000	29.000/29.052	25.000			BC	55-3729	55-3729 SEMI

812	 79.50	Diesel				
AFD	4 Cyl.	20:1	1896cc	58kW (79)PS	TD16184	196
ARD	4 Cyl.		1896cc	44kW (60)PS	TD20099	225

									
BE/PL	4	47.758/47.778	50.600/50.619	20.000	1.406	0.020/0.074	EC	71-3728	71-3728/4 STD 0.25 0.50
MB/HL 1-5	5	53.958/53.978	59.000/59.019	18.500	2.502	0.020/0.082	AL-LF	02-3085L	H084/5 STD 0.25 0.50
MB/HL 1-5	5	53.958/53.978	59.000/59.019	18.500	2.502	0.020/0.082	AL-LF	02-3085U	
TW/A	2	59.500	73.200		1.975		AL-LF	04-3527	A123/4 STD
TW/A	2	59.500	73.200		1.975		AL-LF	04-3528	
SE/PB	1	26.000	29.000/29.052	25.000			BC	55-3729	55-3729 SEMI

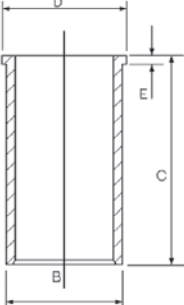







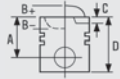

813	 79.50	Diesel				
AFN	4 Cyl.	19.5:1	1896cc	81kW (110)PS	TD4202	212
AFN	4 Cyl.	19.5:1	1896cc	81kW (110)PS	TD4987	212
AFN	4 Cyl.	19.5:1	1896cc	81kW (110)PS	TD5531	212
AVG	4 Cyl.	19.5:1	1896cc	81kW (110)PS	TD13774	235
AVG	4 Cyl.	19.5:1	1896cc	81kW (110)PS	TD14988	235
AVG	4 Cyl.	19.5:1	1896cc	81kW (110)PS	TD23884	235

A4	10/95→09/01	A6	04/97→04/01	ALHAMBRA	08/96→06/00
CORDOBA	03/97→06/99	GOLF	04/96→06/02	IBIZA	02/97→08/99
PASSAT	03/96→11/00	POLO	06/98→09/01	SHARAN	09/96→04/00
TOLEDO	11/96→03/99	VENTO	04/96→09/98		

		
<p>87-114900-60 [45] [55] STD 87-114905-60 [55] 0.25mm 87-114907-60 [33] [55] 0.50mm 87-114911-60 [33] [55] 1.00mm</p> <p>A 45.80 B- 17.65 BØ 38.00 C 1.10 D 68.80</p> <p> 26x66</p> <p>AK KK NB RT</p>	<p>08-114900-00 STD 08-114905-00 0.25mm 08-114907-00 0.50mm 08-114911-00 1.00mm</p> <p>1.75  CK P 2.00  P 3.00  CR P</p> <p>07987</p>	<p>14-027950-00 D B 82.50 C 152.00 D 85.50 E 4.70</p> <p></p>
<p>87-114900-70 [45] [59] STD 87-114905-70 [59] 0.25mm 87-114907-70 [33] [59] 0.50mm 87-114911-70 [33] [59] 1.00mm</p> <p>A 45.80 B- 17.65 BØ 38.00 C 1.10 D 68.80</p> <p> 26x66</p> <p>AK KK NB RT</p>	<p>08-114900-00 STD 08-114905-00 0.25mm 08-114907-00 0.50mm 08-114911-00 1.00mm</p> <p>1.75  CK P 2.00  P 3.00  CR P</p> <p>07987A</p>	











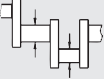

...Continued

813  **79.50** **Diesel**

		
<p>87-114900-90 [55] STD 87-114905-90 [55] 0.25mm 87-114907-90 [34] [55] 0.50mm 87-114911-90 [34] [55] 1.00mm</p> <p>A 45.80 B- 17.65 BØ 38.00 C 1.10 D 71.80  26x66</p> <p>AK NB RT</p>	<p>08-114900-00 STD 08-114905-00 0.25mm 08-114907-00 0.50mm 08-114911-00 1.00mm</p> <p>1.75  CK P 2.00  P 3.00  CR P</p>	
<p>87-114900-95 [59] STD 87-114905-95 [59] 0.25mm 87-114907-95 [34] [59] 0.50mm 87-114911-95 [34] [59] 1.00mm</p> <p>A 45.80 B- 17.65 BØ 38.00 C 1.10 D 71.80  26x66</p> <p>AK NB RT</p>	<p>08-114900-00 STD 08-114905-00 0.25mm 08-114907-00 0.50mm 08-114911-00 1.00mm</p> <p>1.75  CK P 2.00  P 3.00  CR P</p>	

[33] A = 45.550, D = 68.550
 [34] A = 45.550, D = 71.550
 [45] Piston Chamber Volume [ccm] 23.54
 [55] To cylinder 1-2
 [59] To cylinder 3-4

[33] A = 45.550, D = 68.550
 [34] A = 45.550, D = 71.550
 [45] Volumen der Kolbenmulde [ccm] 23.54
 [55] Zum Zylinder 1-2
 [59] Zum Zylinder 3-4

											
BE/PL	4	47.758/47.778	50.600/50.612	20.000	1.406	0.020/0.067	SP	71-3847	71-3847/4	STD 0.25	[64]
BE/PL	4	47.758/47.778	50.600/50.612	19.000	1.406	0.020/0.067	EC	71-3929	71-3929/4	STD	[66]

71-3847

71-3929

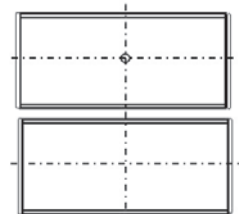
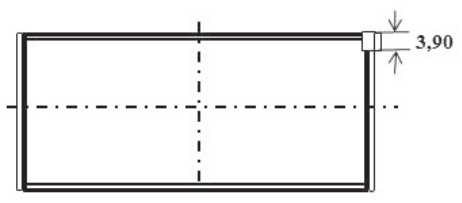

MB/HL 1-5	5	53.958/53.978	59.000/59.019	18.500	2.502	0.020/0.082	AL-LF	02-3085L	H084/5 STD 0.25 0.50
MB/HL 1-5	5	53.958/53.978	59.000/59.019	18.500	2.502	0.020/0.082	AL-LF	02-3085U	
TW/A	2	59.500	73.200		1.975		AL-LF	04-3527	A123/4 STD
TW/A	2	59.500	73.200		1.975		AL-LF	04-3528	
SE/PB	1	26.000	29.000/29.052	25.000			BC	55-3729	55-3729 SEMI

814











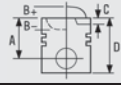

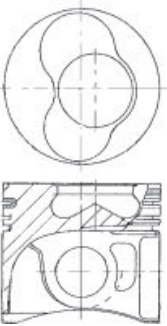
 **79.50**

Diesel

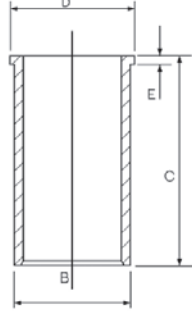

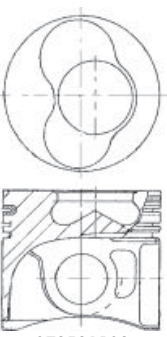
AGP	4 Cyl.	19.5:1	1896cc	50kW (68)PS	TD9452	214
AGP	4 Cyl.	19.5:1	1896cc	50kW (68)PS	TD14808	214
AGP	4 Cyl.	19.5:1	1896cc	50kW (68)PS	TD16424	214

BORA	10/98→05/05	CORDOBA	06/99→12/02	GOLF	08/97→06/06
IBIZA	08/99→02/02	OCTAVIA	06/97→12/03	POLO	08/99→09/01

 <p>87-114900-20 [46] [55] STD 87-114907-20 [28] [55] 0.50mm 87-114911-20 [28] [55] 1.00mm</p> <p>A 39.80 B- 17.75 BØ 38.00 C 1.00 D 60.80</p> <p> 24x58</p>  <p>07959-109</p>	 <p>08-114900-00 STD 08-114905-00 0.25mm 08-114907-00 0.50mm 08-114911-00 1.00mm</p> <p>1.75  CK P 2.00  P 3.00  CR P</p>	 <p>14-027950-00 D B 82.50 C 152.00 D 85.50 E 4.70</p>
<p>87-114900-30 [46] [59] STD 87-114907-30 [28] [59] 0.50mm 87-114911-30 [28] [59] 1.00mm</p> <p>A 39.80 B- 17.75 BØ 38.00 C 1.00 D 60.80</p> <p> 24x58</p>  <p>07959A109</p>	<p>08-114900-00 STD 08-114905-00 0.25mm 08-114907-00 0.50mm 08-114911-00 1.00mm</p> <p>1.75  CK P 2.00  P 3.00  CR P</p>	

[28] A = 39.550, D = 60.550

[28] A = 39.550, D = 60.550

[46] Piston Chamber Volume [ccm] 23.60









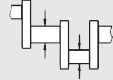

[46] Volumen der Kolbenmulde [ccm] 23.60

[55] To cylinder 1-2

[55] Zum Zylinder 1-2

[59] To cylinder 3-4

[59] Zum Zylinder 3-4

									
BE/PL	4	47.758/47.778	50.600/50.619	19.000	1.406	0.020/0.074	EC	71-3442	71-3442/4 STD 0.25 0.50 0.75
Mot.AGP065001 →									
BE/PL	4	47.758/47.778	50.600/50.619	20.000	1.406	0.020/0.074	EC	71-3728	71-3728/4 STD 0.25 0.50
Mot. → AGP065000									
MB/HL 1-5	5	53.958/53.978	59.000/59.019	18.500	2.502	0.020/0.082	AL-LF	02-3085L	H084/5 STD 0.25 0.50
MB/HL 1-5	5	53.958/53.978	59.000/59.019	18.500	2.502	0.020/0.082	AL-LF	02-3085U	
TW/A	2	59.500	73.200		1.975		AL-LF	04-3527	A123/4 STD
TW/A	2	59.500	73.200		1.975		AL-LF	04-3528	
SE/PB	1	24.000	27.000/27.021	25.000			BC	55-3696	55-3696 SEMI
SE/PB	1	26.000	29.000/29.052	25.000			BC	55-3729	55-3729 SEMI

815

79.50

Diesel



AGR	4 Cyl.	19.5:1	1896cc	66kW (89)PS	TD5076	215
AGR	4 Cyl.	19.5:1	1896cc	66kW (89)PS	TD9364	215
AGR	4 Cyl.	19.5:1	1896cc	66kW (89)PS	TD13278	215
AGR	4 Cyl.	19.5:1	1896cc	66kW (89)PS	TD17905	215

A3	09/96→07/01	BORA	10/98→05/05	CORDOBA	06/99→12/02
GOLF	10/97→05/06	IBIZA	08/99→02/02	LEON	11/99→06/06
OCTAVIA	09/96→03/10	POLO	09/96→09/01	TOLEDO	04/99→05/06

<p>87-114900-60 [45] [55] STD 87-114905-60 [55] 0.25mm 87-114907-60 [33] [55] 0.50mm 87-114911-60 [33] [55] 1.00mm</p> <p>A 45.80 B- 17.65 BØ 38.00 C 1.10 D 68.80</p> <p>AK KK NB RT</p>	<p>08-114900-00 STD 08-114905-00 0.25mm 08-114907-00 0.50mm 08-114911-00 1.00mm</p> <p>1.75 CK P 2.00 P 3.00 CR P</p>	<p>14-027950-00 D B 82.50 C 152.00 D 85.50 E 4.70</p>
<p>87-114900-70 [45] [59] STD 87-114905-70 [59] 0.25mm 87-114907-70 [33] [59] 0.50mm 87-114911-70 [33] [59] 1.00mm</p> <p>A 45.80 B- 17.65 BØ 38.00 C 1.10 D 68.80</p> <p>AK KK NB RT</p>	<p>08-114900-00 STD 08-114905-00 0.25mm 08-114907-00 0.50mm 08-114911-00 1.00mm</p> <p>1.75 CK P 2.00 P 3.00 CR P</p>	
<p>87-114900-90 [55] STD 87-114905-90 [55] 0.25mm 87-114907-90 [34] [55] 0.50mm 87-114911-90 [34] [55] 1.00mm</p> <p>A 45.80 B- 17.65 BØ 38.00 C 1.10 D 71.80</p> <p>AK NB RT</p>	<p>08-114900-00 STD 08-114905-00 0.25mm 08-114907-00 0.50mm 08-114911-00 1.00mm</p> <p>1.75 CK P 2.00 P 3.00 CR P</p>	

815

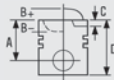

 **79.50**
Diesel

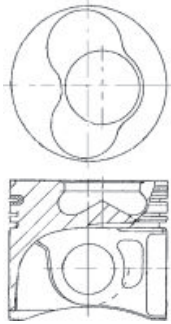
87-114900-95 [59] STD
87-114905-95 [59] 0.25mm
87-114907-95 [34] [59] 0.50mm
87-114911-95 [34] [59] 1.00mm



08-114900-00 STD
08-114905-00 0.25mm
08-114907-00 0.50mm
08-114911-00 1.00mm

A 45.80
B- 17.65
BØ 38.00
C 1.10
D 71.80
 26x66

1.75  CK P
 2.00  P
 3.00  CR P

AK NB RT

[33] A = 45.550, D = 68.550

[33] A = 45.550, D = 68.550

[34] A = 45.550, D = 71.550

[34] A = 45.550, D = 71.550

[45] Piston Chamber Volume [ccm] 23.54









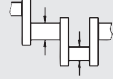

[45] Volumen der Kolbenmulde [ccm] 23.54

[55] To cylinder 1-2

[55] Zum Zylinder 1-2

[59] To cylinder 3-4

[59] Zum Zylinder 3-4

									
BE/PL	4	47.758/47.778	50.600/50.619	20.000	1.406	0.020/0.074	EC	71-3728	71-3728/4 STD 0.25 0.50
MB/HL	4	53.958/53.978	59.000/59.019	18.500	2.502	0.020/0.082	AL-LF	02-3085L	H027/5 STD 0.25 0.50
MB/HL	6	53.958/53.978	59.000/59.019	18.500	2.502	0.020/0.082	AL-LF	02-3085U	
MB/HL 1-5	5	53.958/53.978	59.000/59.019	18.500	2.502	0.020/0.082	AL-LF	02-3085L	H084/5 STD 0.25 0.50
MB/HL 1-5	5	53.958/53.978	59.000/59.019	18.500	2.502	0.020/0.082	AL-LF	02-3085U	

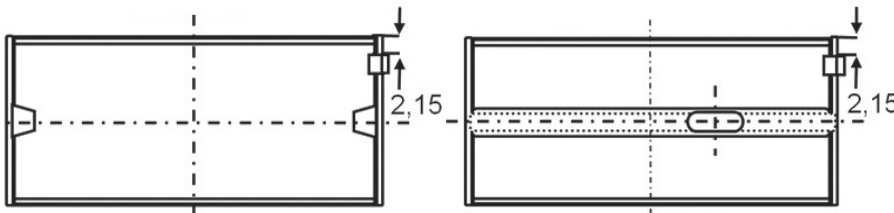
02-3085L
02-3085U











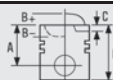

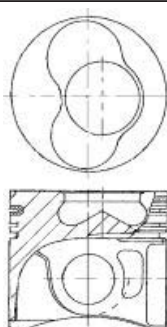



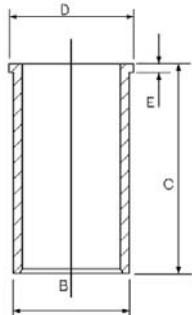

TW/A	2	59.500	73.200		1.975		AL-LF	04-3527	A123/4 STD	
TW/A	2	59.500	73.200		1.975		AL-LF	04-3528		
SE/PB	1	26.000	29.000/29.052	25.000			BC	55-3729	55-3729 SEMI	
BU	1	42.959/42.975	46.055/46.095	15.000			AL-LF	07-3088	07-3088 STD SEMI	[68]
BU	1	41.959/41.975	45.000/45.025	15.000			AL-LF	07-3089	07-3089 STD SEMI	[68]

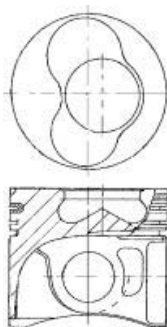
816

79.50
Diesel

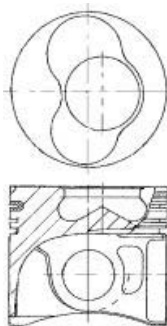
AHF	4 Cyl.	19.5:1	1896cc	81kW (110)PS	TD9371	216
AHF	4 Cyl.	19.5:1	1896cc	81kW (110)PS	TD9788	216
AHF	4 Cyl.	19.5:1	1896cc	81kW (110)PS	TD12512	216
AHF	4 Cyl.	19.5:1	1896cc	81kW (110)PS	TD17910	216
ASV	4 Cyl.	19.5:1	1896cc	81kW (110)PS	TD13273	228
ASV	4 Cyl.	19.5:1	1896cc	81kW (110)PS	TD13773	228
ASV	4 Cyl.	19.5:1	1896cc	81kW (110)PS	TD15354	228
ASV	4 Cyl.	19.5:1	1896cc	81kW (110)PS	TD16091	228

A3	08/97→07/01	BORA	10/98→06/01	CORDOBA	06/99→12/02
GOLF	08/97→05/04	IBIZA	08/99→02/02	LEON	11/99→
OCTAVIA	08/97→01/06	POLO	06/98→09/01	TOLEDO	04/99→05/06

 <p> 87-114900-60 [45] [55] STD 87-114905-60 [55] 0.25mm 87-114907-60 [33] [55] 0.50mm 87-114911-60 [33] [55] 1.00mm </p> <p> A 45.80 B- 17.65 BØ 38.00 C 1.10 D 68.80  26x66 </p> <p>AK KK NB RT</p>  <p>07987</p>	 <p> 08-114900-00 STD 08-114905-00 0.25mm 08-114907-00 0.50mm 08-114911-00 1.00mm </p> <p> 1.75  CK P 2.00  P 3.00  CR P </p>	 <p> 14-027950-00 D B 82.50 C 152.00 D 85.50 E 4.70 </p> 
<p> 87-114900-70 [45] [59] STD 87-114905-70 [59] 0.25mm 87-114907-70 [33] [59] 0.50mm 87-114911-70 [33] [59] 1.00mm </p> <p> A 45.80 B- 17.65 BØ 38.00 C 1.10 D 68.80  26x66 </p> <p>AK KK NB RT</p>  <p>07987A</p>	<p> 08-114900-00 STD 08-114905-00 0.25mm 08-114907-00 0.50mm 08-114911-00 1.00mm </p> <p> 1.75  CK P 2.00  P 3.00  CR P </p>	
<p> 87-114900-90 [55] STD 87-114905-90 [55] 0.25mm 87-114907-90 [34] [55] 0.50mm 87-114911-90 [34] [55] 1.00mm </p> <p> A 45.80 B- 17.65 BØ 38.00 C 1.10 D 71.80  26x66 </p> <p>AK NB RT</p> 	<p> 08-114900-00 STD 08-114905-00 0.25mm 08-114907-00 0.50mm 08-114911-00 1.00mm </p> <p> 1.75  CK P 2.00  P 3.00  CR P </p>	

816

 79.50

Diesel

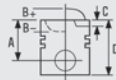

87-114900-95 [59] STD
 87-114905-95 [59] 0.25mm
 87-114907-95 [34] [59] 0.50mm
 87-114911-95 [34] [59] 1.00mm

A 45.80
 B- 17.65
 BØ 38.00
 C 1.10
 D 71.80
 26x66

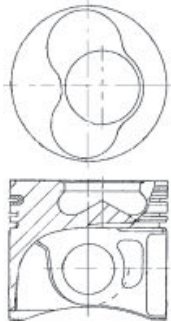

08-114900-00 STD
 08-114905-00 0.25mm
 08-114907-00 0.50mm
 08-114911-00 1.00mm

1.75  CK P
 2.00  P
 3.00  CR P



AK NB RT

[33] A = 45.550, D = 68.550

[33] A = 45.550, D = 68.550

[34] A = 45.550, D = 71.550

[34] A = 45.550, D = 71.550

[45] Piston Chamber Volume [ccm] 23.54











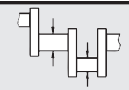

[45] Volumen der Kolbenmulde [ccm] 23.54

[55] To cylinder 1-2

[55] Zum Zylinder 1-2

[59] To cylinder 3-4

[59] Zum Zylinder 3-4

											
BE/PL	4	47.758/47.778	50.600/50.612	20.000	1.406	0.020/0.067	SP	71-3847	71-3847/4 STD 0.25	[64]	
MB/HL 1-5	5	53.958/53.978	59.000/59.019	18.500	2.502	0.020/0.082	AL-LF	02-3085L	H084/5 STD 0.25 0.50		
MB/HL 1-5	5	53.958/53.978	59.000/59.019	18.500	2.502	0.020/0.082	AL-LF	02-3085U			
TW/A	2	59.500	73.200		1.975		AL-LF	04-3527	A123/4 STD		
TW/A	2	59.500	73.200		1.975		AL-LF	04-3528			
SE/PB	1	26.000	29.000/29.052	25.000			BC	55-3729	55-3729 SEMI		
BU	1	42.959/42.975	46.055/46.095	15.000			AL-LF	07-3088	07-3088 STD SEMI	[68]	
BU	1	41.959/41.975	45.000/45.025	15.000			AL-LF	07-3089	07-3089 STD SEMI	[68]	

817

 **79.50**
Diesel



AHU	4 Cyl.	19.5:1	1896cc	66kW (89)PS	TD4990	218
AHU	4 Cyl.	19.5:1	1896cc	66kW (89)PS	TD5528	218
AHU	4 Cyl.	19.5:1	1896cc	66kW (89)PS	TD10814	218

A4	01/95→09/01	A6	06/94→12/97	ALHAMBRA	04/96→03/10
CABRIOLET	06/95→08/00	CADDY	09/96→01/04	CORDOBA	08/96→10/02
GOLF	09/93→06/02	IBIZA	08/96→08/99	PASSAT	10/93→11/00
POLO	09/96→09/01	SHARAN	09/95→03/10	TOLEDO	08/95→03/99
VENTO	09/93→09/98				



87-114900-60 [45] [55] STD
87-114905-60 [55] 0.25mm
87-114907-60 [33] [55] 0.50mm
87-114911-60 [33] [55] 1.00mm

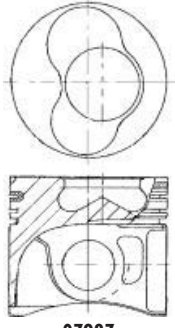

A 45.80
B- 17.65
BØ 38.00
C 1.10
D 68.80
 26x66



07987

AK KK NB RT

08-114900-00 STD
08-114905-00 0.25mm
08-114907-00 0.50mm
08-114911-00 1.00mm

1.75  CK P
 2.00  P
 3.00  CR P

14-027950-00 D **B** 82.50 **C** 152.00 **D** 85.50 **E** 4.70

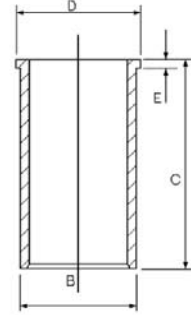

87-114900-70 [45] [59] STD
87-114905-70 [59] 0.25mm
87-114907-70 [33] [59] 0.50mm
87-114911-70 [33] [59] 1.00mm

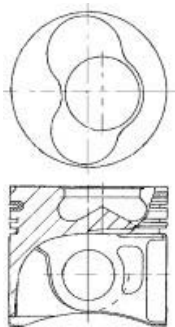

A 45.80
B- 17.65
BØ 38.00
C 1.10
D 68.80
 26x66



07987A

AK KK NB RT

08-114900-00 STD
08-114905-00 0.25mm
08-114907-00 0.50mm
08-114911-00 1.00mm

1.75  CK P
 2.00  P
 3.00  CR P

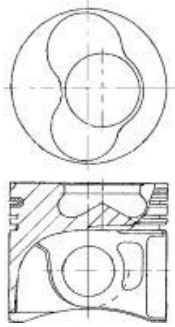

87-114900-90 [55] STD
87-114905-90 [55] 0.25mm
87-114907-90 [34] [55] 0.50mm
87-114911-90 [34] [55] 1.00mm

A 45.80
B- 17.65
BØ 38.00
C 1.10
D 71.80
 26x66









AK NB RT

08-114900-00 STD
08-114905-00 0.25mm
08-114907-00 0.50mm
08-114911-00 1.00mm

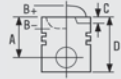
1.75  CK P
 2.00  P
 3.00  CR P

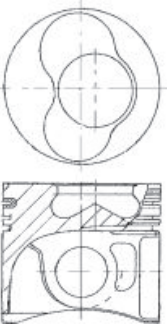
817

 **79.50**
Diesel

		
87-114900-95 [59] STD 87-114905-95 [59] 0.25mm 87-114907-95 [34] [59] 0.50mm 87-114911-95 [34] [59] 1.00mm		08-114900-00 STD 08-114905-00 0.25mm 08-114907-00 0.50mm 08-114911-00 1.00mm
A 45.80 B- 17.65 BØ 38.00 C 1.10 D 71.80  26x66	1.75  CK P 2.00  P 3.00  CR P	
AK NB RT		

[33] A = 45.550, D = 68.550

[33] A = 45.550, D = 68.550

[34] A = 45.550, D = 71.550

[34] A = 45.550, D = 71.550

[45] Piston Chamber Volume [ccm] 23.54









[45] Volumen der Kolbenmulde [ccm] 23.54

[55] To cylinder 1-2

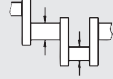
[55] Zum Zylinder 1-2

[59] To cylinder 3-4

[59] Zum Zylinder 3-4

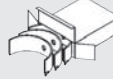
									
BE/PL	4	47.758/47.778	50.600/50.619	20.000	1.406	0.020/0.074	EC	71-3728	71-3728/4 STD 0.25 0.50
BE/PL	4	47.758/47.778	50.600/50.612	19.000	1.406	0.020/0.067	EC	71-3929	71-3929/4 STD

[66]

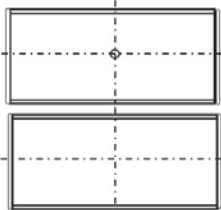
71-3929

MB/HL 1-5	5	53.958/53.978	59.000/59.019	18.500	2.502	0.020/0.082	AL-LF	02-3085L	H084/5 STD 0.25 0.50
MB/HL 1-5	5	53.958/53.978	59.000/59.019	18.500	2.502	0.020/0.082	AL-LF	02-3085U	
TW/A	2	59.500	73.200		1.975		AL-LF	04-3527	A123/4 STD
TW/A	2	59.500	73.200		1.975		AL-LF	04-3528	
SE/PB	1	26.000	29.000/29.052	25.000			BC	55-3729	55-3729 SEMI
BU	1	42.959/42.975	46.055/46.095	15.000			AL-LF	07-3088	07-3088 STD SEMI
BU	1	41.959/41.975	45.000/45.025	15.000			AL-LF	07-3089	07-3089 STD SEMI

[68]

[68]











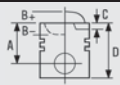

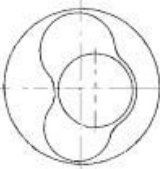



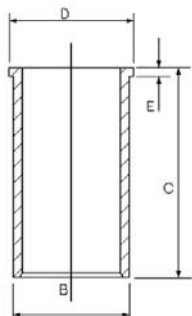

818

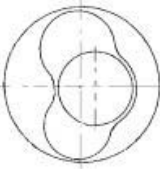
79.50

Diesel

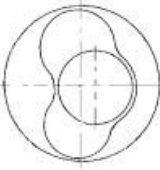

AJM	4 Cyl.	19.5:1	1896cc	85kW (115)PS	TD11527	219
AJM	4 Cyl.	19.5:1	1896cc	85kW (115)PS	TD12588	219
A4	03/00→09/01		A6	07/00→01/05	BORA	12/98→06/01
GOLF	12/98→06/01		PASSAT	08/98→11/00		

 <p>87-114900-05 [37] [55] STD 87-114907-05 [33] [37] [55] 0.50mm</p> <p>→09/02</p> <p>A 45.80 B- 17.80 BØ 38.00 C 1.30 D 68.80</p>  26x66	 <p>07969L-101</p>	 <p>08-114900-00 STD 08-114905-00 0.25mm 08-114907-00 0.50mm 08-114911-00 1.00mm</p> <p>1.75  CK P 2.00  P 3.00  CR P</p>	 <p>14-027950-00 D B 82.50 C 152.00 D 85.50 E 4.70</p> 
<p>87-114900-15 [37] [59] STD 87-114907-15 [33] [37] [59] 0.50mm</p> <p>→09/02</p> <p>A 45.80 B- 17.80 BØ 38.00 C 1.30 D 68.80</p>  26x66	 <p>07969L-101</p>	<p>08-114900-00 STD 08-114905-00 0.25mm 08-114907-00 0.50mm 08-114911-00 1.00mm</p> <p>1.75  CK P 2.00  P 3.00  CR P</p>	
<p>87-114900-55 [36] [46] [55] STD 87-114907-55 [33] [36] [55] 0.50mm</p> <p>09/02→</p> <p>A 45.80 B- 17.60 BØ 38.00 C 1.10 D 68.80</p>  26x66	 <p>07969L-101</p>	<p>08-114900-00 STD 08-114905-00 0.25mm 08-114907-00 0.50mm 08-114911-00 1.00mm</p> <p>1.75  CK P 2.00  P 3.00  CR P</p>	

818

 79.50

Diesel

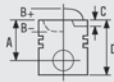

87-114900-56 [36] [46] [59] STD
87-114907-56 [33] [36] [59] 0.50mm

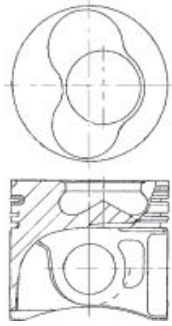

09/02 →

A 45.80
B- 17.60
BØ 38.00
C 1.10
D 68.60
 26x66



07969L-101

08-114900-00 STD
08-114905-00 0.25mm
08-114907-00 0.50mm
08-114911-00 1.00mm

1.75  CK P
2.00  P
3.00  CR P

AK KK NB RT TP

[33] A = 45.550, D = 68.550

[33] A = 45.550, D = 68.550

[36] For newer design straight injection nozzle

[36] Für neuere Ausführungen, direkt einspritzende Düsen

[37] For side angled injection nozzle

[37] Nur für schräg angeordnete Einspritzdüsen

[46] Piston Chamber Volume [ccm] 23.60









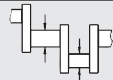

[46] Volumen der Kolbenmulde [ccm] 23.60

[55] To cylinder 1-2

[55] Zum Zylinder 1-2

[59] To cylinder 3-4

[59] Zum Zylinder 3-4

										
BE/PL	1	47.758/47.778	50.600/50.612	20.000	1.406	0.020/0.067	SP	71-3904	71-3904 STD 0.25 0.50	[64]
MB/HL 1-5	5	53.958/53.978	59.000/59.019	18.500	2.502	0.020/0.082	AL-LF	02-3085L	H084/5 STD 0.25 0.50	
MB/HL 1-5	5	53.958/53.978	59.000/59.019	18.500	2.502	0.020/0.082	AL-LF	02-3085U		
TW/A	2	59.500	73.200		1.975		AL-LF	04-3527	A123/4 STD	
TW/A	2	59.500	73.200		1.975		AL-LF	04-3528		
CB/NWB 1-5	5	28.947/28.960	32.000/32.025	25.000	1.513	0.020/0.068	EC	73-3903	N147/5 STD	
BU	1	42.959/42.975	46.055/46.095	15.000			AL-LF	07-3088	07-3088 STD SEMI	[68]
BU	1	41.959/41.975	45.000/45.025	15.000			AL-LF	07-3089	07-3089 STD SEMI	[68]











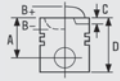

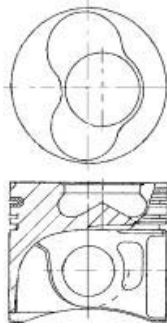
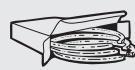

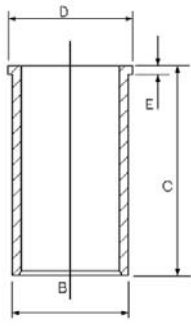

819

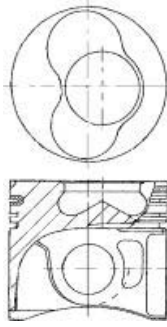
 **79.50**



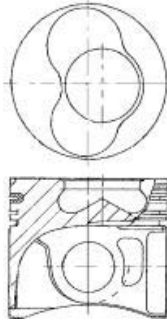





Diesel

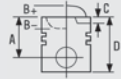



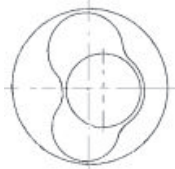
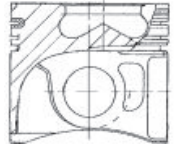





ALE	4 Cyl.	1896cc	66kW (89)PS	TD9512	220
CADDY	10/96→01/04	GOLF	09/93→06/02	POLO	09/96→09/01
VENTO	09/93→09/98				

 <p>87-114900-60 [45] [55] STD 87-114905-60 [55] 0.25mm 87-114907-60 [33] [55] 0.50mm 87-114911-60 [33] [55] 1.00mm</p> <p>A 45.80 B- 17.65 BØ 38.00 C 1.10 D 68.80</p>  26x66  <p>07987</p> <p>AK KK NB RT</p>	 <p>08-114900-00 STD 08-114905-00 0.25mm 08-114907-00 0.50mm 08-114911-00 1.00mm</p> <p>1.75  CK P 2.00  P 3.00  CR P</p>	 <p>14-027950-00 D B 82.50 C 152.00 D 85.50 E 4.70</p> 
<p>87-114900-70 [45] [59] STD 87-114905-70 [59] 0.25mm 87-114907-70 [33] [59] 0.50mm 87-114911-70 [33] [59] 1.00mm</p> <p>A 45.80 B- 17.65 BØ 38.00 C 1.10 D 68.80</p>  26x66  <p>07987A</p> <p>AK KK NB RT</p>	<p>08-114900-00 STD 08-114905-00 0.25mm 08-114907-00 0.50mm 08-114911-00 1.00mm</p> <p>1.75  CK P 2.00  P 3.00  CR P</p>	
<p>87-114900-90 [55] STD 87-114905-90 [55] 0.25mm 87-114907-90 [34] [55] 0.50mm 87-114911-90 [34] [55] 1.00mm</p> <p>A 45.80 B- 17.65 BØ 38.00 C 1.10 D 71.80</p>  26x66  <p>AK NB RT</p>	<p>08-114900-00 STD 08-114905-00 0.25mm 08-114907-00 0.50mm 08-114911-00 1.00mm</p> <p>1.75  CK P 2.00  P 3.00  CR P</p>	

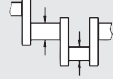
819  **79.50** **Diesel**

		
<p>87-114900-95 [59] STD 87-114905-95 [59] 0.25mm 87-114907-95 [34] [59] 0.50mm 87-114911-95 [34] [59] 1.00mm</p> <p>A 45.80 B- 17.65 BØ 38.00 C 1.10 D 71.80  26x66</p> <p>AK NB RT</p>	 	<p>08-114900-00 STD 08-114905-00 0.25mm 08-114907-00 0.50mm 08-114911-00 1.00mm</p> <p>1.75  CK P 2.00  P 3.00  CR P</p>

[33] A = 45.550, D = 68.550 [33] A = 45.550, D = 68.550
 [34] A = 45.550, D = 71.550 [34] A = 45.550, D = 71.550
 [45] Piston Chamber Volume [ccm] 23.54 [45] Volumen der Kolbenmulde [ccm] 23.54
 [55] To cylinder 1-2 [55] Zum Zylinder 1-2
 [59] To cylinder 3-4 [59] Zum Zylinder 3-4

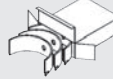
									
BE/PL	4	47.758/47.778	50.600/50.619	20.000	1.406	0.020/0.074	EC	71-3728	71-3728/4 STD 0.25 0.50
BE/PL	4	47.758/47.778	50.600/50.612	19.000	1.406	0.020/0.067	EC	71-3929	71-3929/4 STD

71-3929

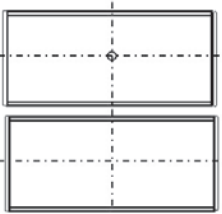







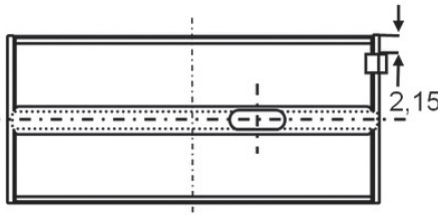
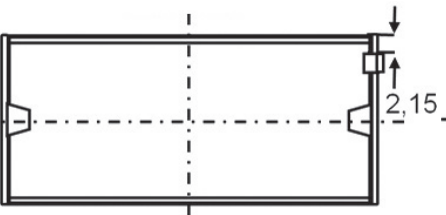

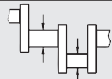

MB/HL	4	53.958/53.978	59.000/59.019	18.500	2.502	0.020/0.082	AL-LF	02-3085L	H027/5 STD 0.25 0.50
MB/HL	6	53.958/53.978	59.000/59.019	18.500	2.502	0.020/0.082	AL-LF	02-3085U	
MB/HL 1-5	5	53.958/53.978	59.000/59.019	18.500	2.502	0.020/0.082	AL-LF	02-3085L	H084/5 STD 0.25 0.50
MB/HL 1-5	5	53.958/53.978	59.000/59.019	18.500	2.502	0.020/0.082	AL-LF	02-3085U	

02-3085L









02-3085U



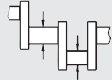
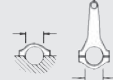





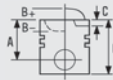

...Continued

819		 79.50	Diesel							
										
TW/A	2	59.500	73.200		1.975		AL-LF	04-3527	A123/4 STD	
TW/A	2	59.500	73.200		1.975		AL-LF	04-3528		
SE/PB	1	26.000	29.000/29.052	25.000			BC	55-3729	55-3729 SEMI	
BU	1	42.959/42.975	46.055/46.095	15.000			AL-LF	07-3088	07-3088 STD SEMI [68]	
BU	1	41.959/41.975	45.000/45.025	15.000			AL-LF	07-3089	07-3089 STD SEMI [68]	

820		 79.50	Diesel							
ANC	4 Cyl.	22:1	1896cc	44kW (60)PS	TD20491 222					

										
BE/PL	4	47.758/47.778	50.600/50.619	19.000	1.406	0.020/0.074	EC	71-3442	71-3442/4 STD 0.25 0.50 0.75	
MB/HL 1-5	5	53.958/53.978	59.000/59.019	18.500	2.502	0.020/0.082	AL-LF	02-3085L	H084/5 STD 0.25 0.50	
MB/HL 1-5	5	53.958/53.978	59.000/59.019	18.500	2.502	0.020/0.082	AL-LF	02-3085U		
TW/A	2	59.500	73.200		1.975		AL-LF	04-3527	A123/4 STD	
TW/A	2	59.500	73.200		1.975		AL-LF	04-3528		
SE/PB	1	24.000	27.000/27.021	25.000			BC	55-3696	55-3696 SEMI	

821		 79.50	Diesel							
ANU	4 Cyl.	18:1	1896cc	66kW (89)PS	TD11596 223					
ANU	4 Cyl.	18:1	1896cc	66kW (89)PS	TD13443 223					
ANU	4 Cyl.	18:1	1896cc	66kW (89)PS	TD14911 223					
ALHAMBRA	04/96→03/10		SHARAN	09/95→03/10						

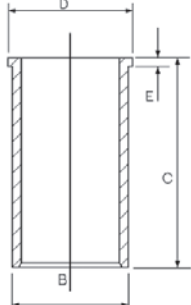
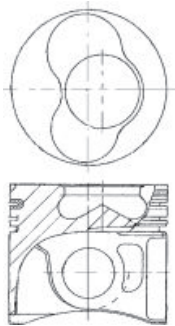
		
87-114900-65 [43] [55] STD 87-114907-65 [33] [55] 0.50mm A 45.80 B- 17.20 BØ 38.00 C 1.10 D 68.80  26x66 AK KK NB RT TP	 08-114900-00 STD 08-114905-00 0.25mm 08-114907-00 0.50mm 08-114911-00 1.00mm 1.75  CK P 2.00  P 3.00  CR P	14-027950-00 D B 82.50 C 152.00 D 85.50 E 4.70 
		

821

 79.50

Diesel

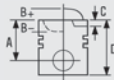

87-114900-66 [43] [59] STD
87-114907-66 [33] [59] 0.50mm

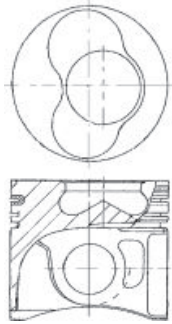

A 45.80
B- 17.20
BØ 38.00
C 1.10
D 68.80
 26x66



AK KK NB RT TP

07901D-302

08-114900-00 STD
08-114905-00 0.25mm
08-114907-00 0.50mm
08-114911-00 1.00mm

1.75  CK P
2.00  P
3.00  CR P

[33] A = 45.550, D = 68.550

[33] A = 45.550, D = 68.550

[43] Piston Chamber Volume [ccm] 22.85









[43] Volumen der Kolbenmulde [ccm] 22.85

[55] To cylinder 1-2

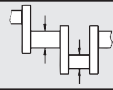
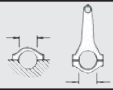
[55] Zum Zylinder 1-2

[59] To cylinder 3-4

[59] Zum Zylinder 3-4

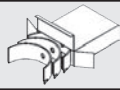
									
BE/PL	4	47.758/47.778	50.600/50.612	20.000	1.406	0.020/0.067	SP	71-3847	71-3847/4 STD 0.25 [64]
MB/HL 1-5	5	53.958/53.978	59.000/59.019	18.500	2.502	0.020/0.082	AL-LF	02-3085L	H084/5 STD 0.25 0.50
MB/HL 1-5	5	53.958/53.978	59.000/59.019	18.500	2.502	0.020/0.082	AL-LF	02-3085U	
TW/A	2	59.500	73.200		1.975		AL-LF	04-3527	A123/4 STD
TW/A	2	59.500	73.200		1.975		AL-LF	04-3528	
SE/PB	1	26.000	29.000/29.052	25.000			BC	55-3729	55-3729 SEMI
CB/NWB 1-5	5	28.947/28.960	32.000/32.025	25.000	1.513	0.020/0.068	EC	73-3903	N147/5 STD
BU	1	42.959/42.975	46.055/46.095	15.000			AL-LF	07-3088	07-3088 STD SEMI [68]
BU	1	41.959/41.975	45.000/45.025	15.000			AL-LF	07-3089	07-3089 STD SEMI [68]

822

79.50
Diesel

AQM	4 Cyl.	19.5:1	1896cc	50kW (68)PS	TD11351	224
AQM	4 Cyl.	19.5:1	1896cc	50kW (68)PS	TD13271	224
AQM	4 Cyl.	19.5:1	1896cc	50kW (68)PS	TD16089	224
ASY	4 Cyl.	19.5:1	1896cc	47kW (64)PS	TD15376	230
ASY	4 Cyl.	19.5:1	1896cc	47kW (64)PS	TD16338	230
ASY	4 Cyl.	19.5:1	1896cc	47kW (64)PS	TD16461	230

BORA	10/98→05/05	CORDOBA	06/99→11/09	FABIA	11/99→03/08
FOX	12/07→	GOLF	08/97→06/06	IBIZA	08/99→12/05
LEON	11/99→06/06	OCTAVIA	06/97→12/03	POLO	08/99→
SPACEFOX	09/07→	TOLEDO	11/99→06/04		

87-114900-20 [46] [55] STD 87-114907-20 [28] [55] 0.50mm 87-114911-20 [28] [55] 1.00mm A 39.80 B- 17.75 BØ 38.00 C 1.00 D 60.80 24x58	08-114900-00 STD 08-114905-00 0.25mm 08-114907-00 0.50mm 08-114911-00 1.00mm 1.75 CK P 2.00 P 3.00 CR P 07959-109	14-027950-00 D B 82.50 C 152.00 D 85.50 E 4.70
87-114900-30 [46] [59] STD 87-114907-30 [28] [59] 0.50mm 87-114911-30 [28] [59] 1.00mm A 39.80 B- 17.75 BØ 38.00 C 1.00 D 60.80 24x58	08-114900-00 STD 08-114905-00 0.25mm 08-114907-00 0.50mm 08-114911-00 1.00mm 1.75 CK P 2.00 P 3.00 CR P 07959A109	

[28] A = 39.550, D = 60.550

[28] A = 39.550, D = 60.550

[46] Piston Chamber Volume [ccm] 23.60

[46] Volumen der Kolbenmulde [ccm] 23.60

[55] To cylinder 1-2

[55] Zum Zylinder 1-2

[59] To cylinder 3-4

[59] Zum Zylinder 3-4

BE/PL	4	47.758/47.778	50.600/50.619	19.000	1.406	0.020/0.074	EC	71-3442	71-3442/4 STD 0.25 0.50 0.75
MB/HL 1-5	5	53.958/53.978	59.000/59.019	18.500	2.502	0.020/0.082	AL-LF	02-3085L	H084/5 STD 0.25 0.50
MB/HL 1-5	5	53.958/53.978	59.000/59.019	18.500	2.502	0.020/0.082	AL-LF	02-3085U	
TW/A	2	59.500	73.200		1.975		AL-LF	04-3527	A123/4 STD
TW/A	2	59.500	73.200		1.975		AL-LF	04-3528	
SE/PB	1	24.000	27.000/27.021	25.000			BC	55-3696	55-3696 SEMI











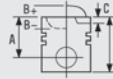



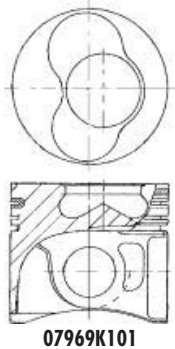

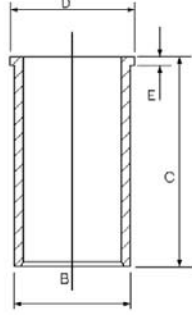

823

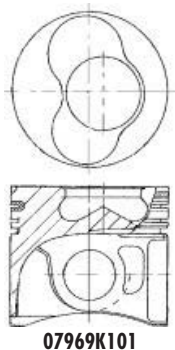
 79.50

Diesel

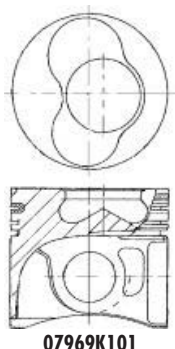







ARL	4 Cyl.	19.5:1	1896cc	110kW (150)PS	TD15484	226
ARL	4 Cyl.	19.5:1	1896cc	110kW (150)PS	TD15768	226
ALHAMBRA	05/05→05/07		BORA	05/00→05/05	GOLF	02/00→06/06
LEON	02/01→06/06		TOLEDO	10/00→05/06		

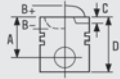





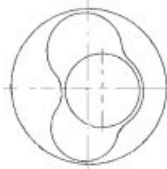
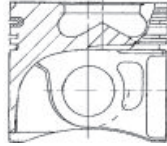

		
<p>87-114900-25 [50] [55] STD 87-114907-25 [33] [55] 0.50mm</p> <p>→09/02</p> <p>A 45.80 B- 17.90 BØ 38.00 C 1.10 D 68.80  26x66</p> <p>AK KK NB RT TP</p>  <p>07969K101</p>	<p>08-114900-00 STD 08-114905-00 0.25mm 08-114907-00 0.50mm 08-114911-00 1.00mm</p> <p>1.75  CK P 2.00  P 3.00  CR P</p>	<p>14-027950-00 D B 82.50 C 152.00 D 85.50 E 4.70</p> 
<p>87-114900-35 [33] [42] STD 87-114907-35 [33] [59] 0.50mm</p> <p>→09/02</p> <p>A 45.80 B- 17.90 BØ 38.00 C 1.10 D 68.80  26x66</p> <p>AK KK NB RT TP</p>  <p>07969K101</p>	<p>08-114900-00 STD 08-114905-00 0.25mm 08-114907-00 0.50mm 08-114911-00 1.00mm</p> <p>1.75  CK P 2.00  P 3.00  CR P</p>	
<p>87-114900-45 [48] [55] STD 87-114907-45 [33] [55] 0.50mm</p> <p>09/02→</p> <p>A 45.80 B- 17.50 BØ 38.00 C 1.10 D 68.80  26x66</p> <p>AK KK NB RT TP</p>  <p>07969K101</p>	<p>08-114900-00 STD 08-114905-00 0.25mm 08-114907-00 0.50mm 08-114911-00 1.00mm</p> <p>1.75  CK P 2.00  P 3.00  CR P</p>	

...Continued

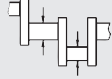
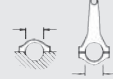
823  **79.50** **Diesel**





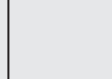
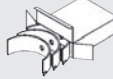

 <p>87-114900-46 [48] [59] STD 87-114907-46 [33] [59] 0.50mm</p> <p>09/02→</p> <p>A 45.80 B- 17.50 BØ 38.00 C 1.10 D 68.80  26x66</p> <p>AK KK NB RT TP</p>	 <p>08-114900-00 STD 08-114905-00 0.25mm 08-114907-00 0.50mm 08-114911-00 1.00mm</p> <p>1.75  CK P 2.00  P 3.00  CR P</p>	
  <p>07969K101</p>		

[33] A = 45.550, D = 68.550	[33] A = 45.550, D = 68.550
[48] Piston Chamber Volume [ccm] 24.05	[48] Volumen der Kolbenmulde [ccm] 24.05
[50] Piston Chamber Volume [ccm] 24.60	[50] Volumen der Kolbenmulde [ccm] 24.60
[55] To cylinder 1-2	[55] Zum Zylinder 1-2
[59] To cylinder 3-4	[59] Zum Zylinder 3-4

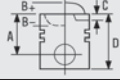
										
BE/PL	1	50.858/50.878	53.700/53.712	20.400	1.403	0.020/0.073	SP	71-3930	71-3930 STD 0.25 0.50	[64]
MB/HL 1-5	5	53.958/53.978	59.000/59.012	18.500	2.501	0.020/0.076	EC	72-3931	H079/5 STD 0.25 0.50	
TW/A	2	59.500	73.200		1.975		AL-LF	04-3527	A123/4 STD	
TW/A	2	59.500	73.200		1.975		AL-LF	04-3528		
SE/PB	1	24.000	27.000/27.021	25.000			BC	55-3696	55-3696 SEMI	
CB/NWB 1-5	5	28.947/28.960	32.000/32.025	25.000	1.513	0.020/0.068	EC	73-3903	N147/5 STD	

824  **79.50** **Diesel** 







ASK	4 Cyl.	1896cc	81kW (110)PS	TD13277 227
CORDOBA	06/99→12/02	IBIZA	08/99→02/02	

	 <p>08-114900-00 STD 08-114905-00 0.25mm 08-114907-00 0.50mm 08-114911-00 1.00mm</p> <p>1.75  CK P 2.00  P 3.00  CR P</p>	
---	--	---

824

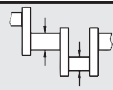
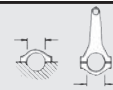
 **79.50**

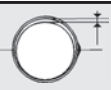
Diesel

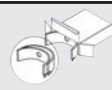
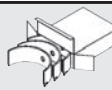
										
BE/PL	4	47.758/47.778	50.600/50.612	20.000	1.406	0.020/0.067	SP	71-3847	71-3847/4 STD 0.25	[64]
BE/PL	1	47.758/47.778	50.600/50.612	20.000	1.406	0.020/0.067	SP	71-3904	71-3904 STD 0.25 0.50	[64]

71-3847

71-3904

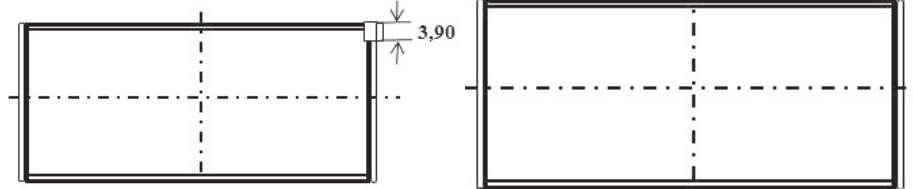

MB/HL	4	53.958/53.978	59.000/59.019	18.500	2.502	0.020/0.082	AL-LF	02-3085L	H027/5 STD 0.25 0.50
MB/HL	6	53.958/53.978	59.000/59.019	18.500	2.502	0.020/0.082	AL-LF	02-3085U	
MB/HL 1-5	5	53.958/53.978	59.000/59.019	18.500	2.502	0.020/0.082	AL-LF	02-3085L	H084/5 STD 0.25 0.50
MB/HL 1-5	5	53.958/53.978	59.000/59.019	18.500	2.502	0.020/0.082	AL-LF	02-3085U	

02-3085L

02-3085U

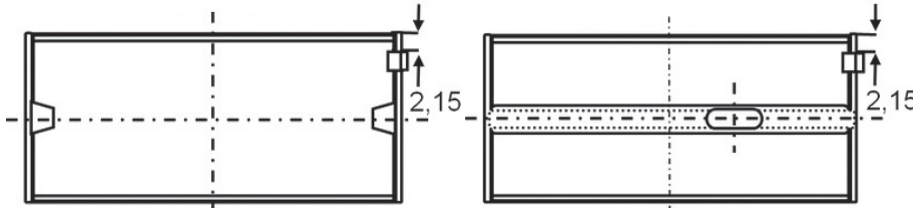

TW/A	2	59.500	73.200		1.975		AL-LF	04-3527	A123/4 STD	
TW/A	2	59.500	73.200		1.975		AL-LF	04-3528		
SE/PB	1	26.000	29.000/29.052	25.000			BC	55-3729	55-3729 SEMI	
CB/NWB 1-5	5	28.947/28.960	32.000/32.025	25.000	1.513	0.020/0.068	EC	73-3903	N147/5 STD	
BU	1	42.959/42.975	46.055/46.095	15.000			AL-LF	07-3088	07-3088 STD SEMI	[68]
BU	1	41.959/41.975	45.000/45.025	15.000			AL-LF	07-3089	07-3089 STD SEMI	[68]

825

79.50

Diesel



ASX	4 Cyl.	1896cc	47kW (64)PS	TD15495	229
POLO 10/99→09/01					

<p>87-114900-20 [46] [55] STD 87-114907-20 [28] [55] 0.50mm 87-114911-20 [28] [55] 1.00mm</p> <p>A 39.80 B- 17.75 BØ 38.00 C 1.00 D 60.80</p> <p> 24x58</p> <p style="text-align: center;"> 07959-109</p>	<p>08-114900-00 STD 08-114905-00 0.25mm 08-114907-00 0.50mm 08-114911-00 1.00mm</p> <p>1.75 CK P 2.00 P 3.00 CR P</p>	<p>14-027950-00 D B 82.50 C 152.00 D 85.50 E 4.70</p> <p style="text-align: center;"></p>
<p>87-114900-30 [46] [59] STD 87-114907-30 [28] [59] 0.50mm 87-114911-30 [28] [59] 1.00mm</p> <p>A 39.80 B- 17.75 BØ 38.00 C 1.00 D 60.80</p> <p> 24x58</p> <p style="text-align: center;"> 07959A109</p>	<p>08-114900-00 STD 08-114905-00 0.25mm 08-114907-00 0.50mm 08-114911-00 1.00mm</p> <p>1.75 CK P 2.00 P 3.00 CR P</p>	

[28] A = 39.550, D = 60.550 [28] A = 39.550, D = 60.550
 [46] Piston Chamber Volume [ccm] 23.60 [46] Volumen der Kolbenmulde [ccm] 23.60
 [55] To cylinder 1-2 [55] Zum Zylinder 1-2
 [59] To cylinder 3-4 [59] Zum Zylinder 3-4

BE/PL	4	47.758/47.778	50.600/50.619	20.000	1.406	0.020/0.074	EC	71-3728	71-3728/4 STD 0.25 0.50	
MB/HL 1-5	5	53.958/53.978	59.000/59.019	18.500	2.502	0.020/0.082	AL-LF	02-3085L	H084/5 STD 0.25 0.50	
MB/HL 1-5	5	53.958/53.978	59.000/59.019	18.500	2.502	0.020/0.082	AL-LF	02-3085U		
TW/A	2	59.500	73.200		1.975		AL-LF	04-3527	A123/4 STD	
TW/A	2	59.500	73.200		1.975		AL-LF	04-3528		
SE/PB	1	26.000	29.000/29.052	25.000			BC	55-3729	55-3729 SEMI	

826











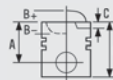

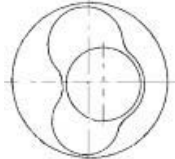
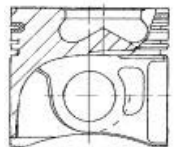
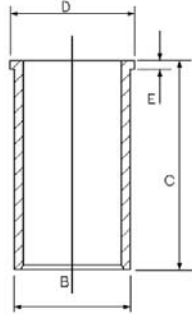

 79.50

Diesel

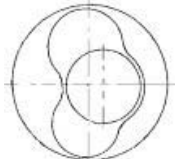
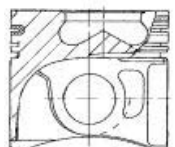

ASZ	4 Cyl.	19.5:1	1896cc	96kW (131)PS	TD15351	231
ASZ	4 Cyl.	19.5:1	1896cc	96kW (131)PS	TD16231	231
ASZ	4 Cyl.	19.5:1	1896cc	96kW (131)PS	TD16463	231
ASZ	4 Cyl.	19.5:1	1896cc	96kW (131)PS	TD17036	231

A3	08/00→05/03	ALHAMBRA	11/02→11/08	BORA	11/00→05/05
CORDOBA	10/02→11/09	FABIA	06/03→03/08	GOLF	11/00→06/06
IBIZA	02/02→11/09	LEON	05/03→06/06	OCTAVIA	09/02→09/04
POLO	11/03→11/09	SHARAN	11/02→03/10	TOLEDO	05/03→05/06

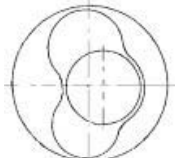
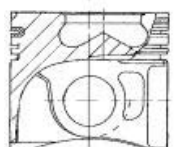
		
<p>87-114900-25 [50] [55] STD 87-114907-25 [33] [55] 0.50mm</p> <p>→09/02</p> <p>A 45.80 B- 17.90 BØ 38.00 C 1.10 D 68.80</p> <p> 26x66</p> <p>AK KK NB RT TP</p>	<p>08-114900-00 STD 08-114905-00 0.25mm 08-114907-00 0.50mm 08-114911-00 1.00mm</p> <p>1.75  CK P 2.00  P 3.00  CR P</p> <p> 07969K101</p> <p></p>	<p>14-027950-00 D B 82.50 C 152.00 D 85.50 E 4.70</p> <p></p>
<p>87-114900-35 [33] [42] STD 87-114907-35 [33] [59] 0.50mm</p> <p>→09/02</p> <p>A 45.80 B- 17.90 BØ 38.00 C 1.10 D 68.80</p> <p> 26x66</p> <p>AK KK NB RT TP</p>	<p>08-114900-00 STD 08-114905-00 0.25mm 08-114907-00 0.50mm 08-114911-00 1.00mm</p> <p>1.75  CK P 2.00  P 3.00  CR P</p> <p> 07969K102</p> <p></p>	
<p>87-114900-45 [48] [55] STD 87-114907-45 [33] [55] 0.50mm</p> <p>09/02→</p> <p>A 45.80 B- 17.50 BØ 38.00 C 1.10 D 68.80</p> <p> 26x66</p> <p>AK KK NB RT TP</p>	<p>08-114900-00 STD 08-114905-00 0.25mm 08-114907-00 0.50mm 08-114911-00 1.00mm</p> <p>1.75  CK P 2.00  P 3.00  CR P</p> <p> 07901C105</p> <p></p>	

...Continued

826

 79.50

Diesel



87-114900-46 [48] [59] STD
87-114907-46 [33] [59] 0.50mm

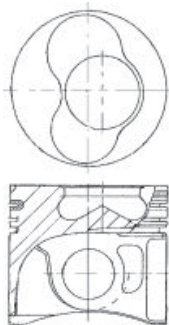

08-114900-00 STD
08-114905-00 0.25mm
08-114907-00 0.50mm
08-114911-00 1.00mm

09/02→

A 45.80
B- 17.50
BØ 38.00
C 1.10
D 68.80
 26x66

1.75  CK P
2.00  P
3.00  CR P

07901C106

AK KK NB RT TP

[33] A = 45.550, D = 68.550

[33] A = 45.550, D = 68.550

[48] Piston Chamber Volume [ccm] 24.05

[48] Volumen der Kolbenmulde [ccm] 24.05

[50] Piston Chamber Volume [ccm] 24.60









[50] Volumen der Kolbenmulde [ccm] 24.60

[55] To cylinder 1-2

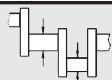
[55] Zum Zylinder 1-2

[59] To cylinder 3-4

[59] Zum Zylinder 3-4

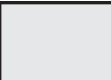
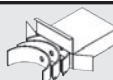
										
BE/PL	1	50.858/50.878	53.700/53.712	20.400	1.403	0.020/0.073	SP	71-3930	71-3930 STD 0.25 0.50	[64]
MB/HL 1-5	5	53.958/53.978	59.000/59.012	18.500	2.501	0.020/0.076	EC	72-3931	H079/5 STD 0.25 0.50	
TW/A	2	59.500	73.200		1.975		AL-LF	04-3527	A123/4 STD	
TW/A	2	59.500	73.200		1.975		AL-LF	04-3528		
SE/PB	1	24.000	27.000/27.021	25.000			BC	55-3696	55-3696 SEMI	
SE/PB	1	26.000	29.000/29.052	25.000			BC	55-3729	55-3729 SEMI	
CB/NWB 1-5	5	28.947/28.960	32.000/32.025	25.000	1.513	0.020/0.068	EC	73-3903	N147/5 STD	
BU	1	42.959/42.975	46.055/46.095	15.000			AL-LF	07-3088	07-3088 STD SEMI	[68]
BU	1	41.959/41.975	45.000/45.025	15.000			AL-LF	07-3089	07-3089 STD SEMI	[68]

827











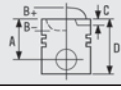

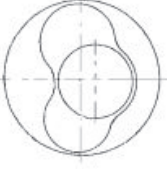

 79.50

Diesel

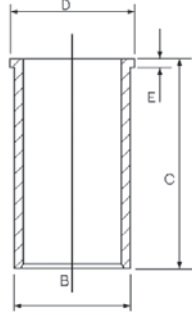

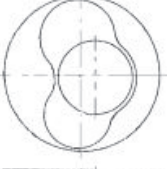
ATD	4 Cyl.	19:1	1896cc	74kW (100)PS	TD15377	232
ATD	4 Cyl.	19:1	1896cc	74kW (100)PS	TD15473	232
ATD	4 Cyl.	19:1	1896cc	74kW (100)PS	TD16028	232
ATD	4 Cyl.	19:1	1896cc	74kW (100)PS	TD16462	232

A3	10/00→05/03	BORA	09/00→05/05	CORDOBA	09/02→11/09
FABIA	01/00→03/08	GOLF	09/00→06/06	IBIZA	02/02→11/09
NEW BEETLE	02/01→	OCTAVIA	08/00→12/10	POLO	10/01→

		
<p>87-114900-65 [43] [55] STD 87-114907-65 [33] [55] 0.50mm</p> <p>A 45.80 B- 17.20 BØ 38.00 C 1.10 D 68.80</p> <p> 26x66</p> <p>AK KK NB RT TP</p> <p style="text-align: center;"> 07901D-301</p>	<p>08-114900-00 STD 08-114905-00 0.25mm 08-114907-00 0.50mm 08-114911-00 1.00mm</p> <p>1.75  CK P 2.00  P 3.00  CR P</p>	<p>14-027950-00 D B 82.50 C 152.00 D 85.50 E 4.70</p> <p style="text-align: center;">  </p>
<p>87-114900-66 [43] [59] STD 87-114907-66 [33] [59] 0.50mm</p> <p>A 45.80 B- 17.20 BØ 38.00 C 1.10 D 68.80</p> <p> 26x66</p> <p>AK KK NB RT TP</p> <p style="text-align: center;"> 07901D-302</p>	<p>08-114900-00 STD 08-114905-00 0.25mm 08-114907-00 0.50mm 08-114911-00 1.00mm</p> <p>1.75  CK P 2.00  P 3.00  CR P</p>	

[33] A = 45.550, D = 68.550

[33] A = 45.550, D = 68.550

[43] Piston Chamber Volume [ccm] 22.85









[43] Volumen der Kolbenmulde [ccm] 22.85

[55] To cylinder 1-2

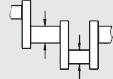
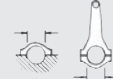
[55] Zum Zylinder 1-2

[59] To cylinder 3-4

[59] Zum Zylinder 3-4

										
BE/PL	1	47.758/47.778	50.600/50.612	20.000	1.406	0.020/0.067	SP	71-3904	71-3904 STD 0.25 0.50	[64]
MB/HL 1-5	5	53.958/53.978	59.000/59.019	18.500	2.502	0.020/0.082	AL-LF	02-3085L	H084/5 STD 0.25 0.50	
MB/HL 1-5	5	53.958/53.978	59.000/59.019	18.500	2.502	0.020/0.082	AL-LF	02-3085U		
TW/A	2	59.500	73.200		1.975		AL-LF	04-3527	A123/4 STD	
TW/A	2	59.500	73.200		1.975		AL-LF	04-3528		
SE/PB	1	24.000	27.000/27.021	25.000			BC	55-3696	55-3696 SEMI	
SE/PB	1	26.000	29.000/29.052	25.000			BC	55-3729	55-3729 SEMI	
CB/NWB 1-5	5	28.947/28.960	32.000/32.025	25.000	1.513	0.020/0.068	EC	73-3903	N147/5 STD	

...Continued

827		79.50		Diesel						
BU	1	42.959/42.975	46.055/46.095	15.000		AL-LF	07-3088	07-3088 STD SEMI	[68]	
BU	1	41.959/41.975	45.000/45.025	15.000		AL-LF	07-3089	07-3089 STD SEMI	[68]	

828		79.50		Diesel						
ATJ	4 Cyl.	1896cc	85kW (115)PS	TD15989	219					
ATJ	4 Cyl.	1896cc	85kW (115)PS	TD16258	219					
A4	03/00→09/01	PASSAT	08/98→11/00							

<p>87-114900-05 [37] [55] STD 87-114907-05 [33] [37] [55] 0.50mm</p> <p>→09/02</p> <p>A 45.80 B- 17.80 BØ 38.00 C 1.30 D 68.80</p> <p></p> <p>26x66</p> <p>07969L-101</p> <p>AK KK NB RT TP</p>	<p>08-114900-00 STD 08-114905-00 0.25mm 08-114907-00 0.50mm 08-114911-00 1.00mm</p> <p>1.75 CK P 2.00 P 3.00 CR P</p>	<p>14-027950-00 D B 82.50 C 152.00 D 85.50 E 4.70</p> <p></p>
<p>87-114900-15 [37] [59] STD 87-114907-15 [33] [37] [59] 0.50mm</p> <p>→09/02</p> <p>A 45.80 B- 17.80 BØ 38.00 C 1.30 D 68.80</p> <p></p> <p>26x66</p> <p>07969L-102</p> <p>AK KK NB RT TP</p>	<p>08-114900-00 STD 08-114905-00 0.25mm 08-114907-00 0.50mm 08-114911-00 1.00mm</p> <p>1.75 CK P 2.00 P 3.00 CR P</p>	
<p>87-114900-55 [36] [46] [55] STD 87-114907-55 [33] [36] [55] 0.50mm</p> <p>09/02→</p> <p>A 45.80 B- 17.60 BØ 38.00 C 1.10 D 68.80</p> <p></p> <p>26x66</p> <p>07901D101</p> <p>AK KK NB RT TP</p>	<p>08-114900-00 STD 08-114905-00 0.25mm 08-114907-00 0.50mm 08-114911-00 1.00mm</p> <p>1.75 CK P 2.00 P 3.00 CR P</p>	

828

79.50

Diesel

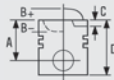

87-114900-56 [36] [46] [59] STD
87-114907-56 [33] [36] [59] 0.50mm

09/02 →

A 45.80
B- 17.60
BØ 38.00
C 1.10
D 68.60
 26x66

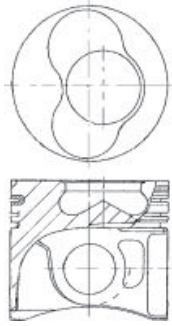

07901D102

08-114900-00 STD
08-114905-00 0.25mm
08-114907-00 0.50mm
08-114911-00 1.00mm

1.75 CK P
2.00 P
3.00 CR P

AK KK NB RT TP

[33] A = 45.550, D = 68.550

[36] A = 45.550, D = 68.550

[36] For newer design straight injection nozzle

[36] Für neuere Ausführungen, direkt einspritzende Düsen

[37] For side angled injection nozzle

[37] Nur für schräg angeordnete Einspritzdüsen

[46] Piston Chamber Volume [ccm] 23.60

[46] Volumen der Kolbenmulde [ccm] 23.60

[55] To cylinder 1-2

[55] Zum Zylinder 1-2

[59] To cylinder 3-4

[59] Zum Zylinder 3-4

BE/PL	1	47.758/47.778	50.600/50.612	20.000	1.406	0.020/0.067	SP	71-3904	71-3904 STD 0.25 0.50	[68]
MB/HL 1-5	5	53.958/53.978	59.000/59.019	18.500	2.502	0.020/0.082	AL-LF	02-3085L	H084/5 STD 0.25 0.50	
MB/HL 1-5	5	53.958/53.978	59.000/59.019	18.500	2.502	0.020/0.082	AL-LF	02-3085U		
TW/A	2	59.500	73.200		1.975		AL-LF	04-3527	A123/4 STD	
TW/A	2	59.500	73.200		1.975		AL-LF	04-3528		
CB/NWB 1-5	5	28.947/28.960	32.000/32.025	25.000	1.513	0.020/0.068	EC	73-3903	N147/5 STD	

829

79.50

Diesel



AUY	4 Cyl.	18:1	1896cc	85kW (115)PS	TD14912	226
AUY	4 Cyl.	18:1	1896cc	85kW (115)PS	TD14915	226

ALHAMBRA	06/00 → 03/10	BORA	12/98 → 06/01	GOLF	12/98 → 06/01
SHARAN	04/00 → 03/10				

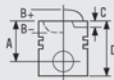

87-114900-05 [37] [55] STD
87-114907-05 [33] [37] [55] 0.50mm

→09/02

A 45.80
B- 17.80
BØ 38.00
C 1.30
D 68.80
 26x66

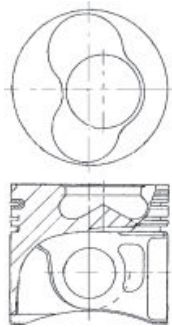

07969L-101

08-114900-00 STD
08-114905-00 0.25mm
08-114907-00 0.50mm
08-114911-00 1.00mm

1.75 CK P
2.00 P
3.00 CR P



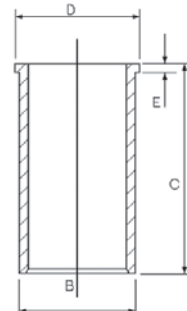











14-027950-00 D B 82.50 C 152.00 D 85.50 E 4.70

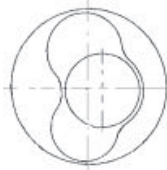
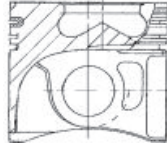



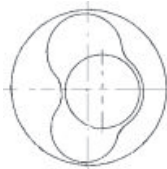
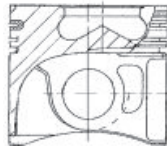



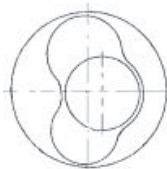
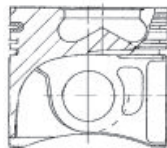

AK KK NB RT TP

...Continued

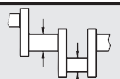





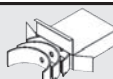

829  **79.50** **Diesel**

		
<p>87-114900-15 [37] [59] STD 87-114907-15 [33] [37] [59] 0.50mm</p> <p>→09/02</p> <p>A 45.80 B- 17.80 BØ 38.00 C 1.30 D 68.80</p> <p> 26x66</p> <p>AK KK NB RT TP</p>	<p>08-114900-00 STD 08-114905-00 0.25mm 08-114907-00 0.50mm 08-114911-00 1.00mm</p> <p>1.75  CK P 2.00  P 3.00  CR P</p> <p>  07969L-102</p>	
<p>87-114900-55 [36] [46] [55] STD 87-114907-55 [33] [36] [55] 0.50mm</p> <p>09/02→</p> <p>A 45.80 B- 17.60 BØ 38.00 C 1.10 D 68.80</p> <p> 26x66</p> <p>AK KK NB RT TP</p>	<p>08-114900-00 STD 08-114905-00 0.25mm 08-114907-00 0.50mm 08-114911-00 1.00mm</p> <p>1.75  CK P 2.00  P 3.00  CR P</p> <p>  07901D101</p>	
<p>87-114900-56 [36] [46] [59] STD 87-114907-56 [33] [36] [59] 0.50mm</p> <p>09/02→</p> <p>A 45.80 B- 17.60 BØ 38.00 C 1.10 D 68.60</p> <p> 26x66</p> <p>AK KK NB RT TP</p>	<p>08-114900-00 STD 08-114905-00 0.25mm 08-114907-00 0.50mm 08-114911-00 1.00mm</p> <p>1.75  CK P 2.00  P 3.00  CR P</p> <p>  07901D102</p>	

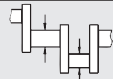
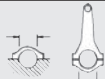
[33] A = 45.550, D = 68.550
 [36] For newer design straight injection nozzle [36] Für neuere Ausführungen, direkt einspritzende Düsen
 [37] For side angled injection nozzle [37] Nur für schräg angeordnete Einspritzdüsen
 [46] Piston Chamber Volume [ccm] 23.60 [46] Volumen der Kolbenmulde [ccm] 23.60
 [55] To cylinder 1-2 [55] Zum Zylinder 1-2
 [59] To cylinder 3-4 [59] Zum Zylinder 3-4

									
BE/PL	1	47.758/47.778	50.600/50.612	20.000	1.406	0.020/0.067	SP	71-3904	71-3904 STD 0.25 0.50
MB/HL 1-5	5	53.958/53.978	59.000/59.019	18.500	2.502	0.020/0.082	AL-LF	02-3085L	H084/5 STD 0.25 0.50
MB/HL 1-5	5	53.958/53.978	59.000/59.019	18.500	2.502	0.020/0.082	AL-LF	02-3085U	











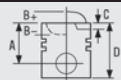

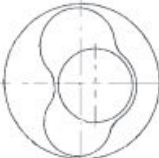

829  **79.50 Diesel**

									
TW/A	2	59.500	73.200		1.975		AL-LF	04-3527	A123/4 STD
TW/A	2	59.500	73.200		1.975		AL-LF	04-3528	
SE/PB	1	26.000	29.000/29.052	25.000			BC	55-3729	55-3729 SEMI
CB/NWB 1-5	5	28.947/28.960	32.000/32.025	25.000	1.513	0.020/0.068	EC	73-3903	N147/5 STD
BU	1	42.959/42.975	46.055/46.095	15.000			AL-LF	07-3088	07-3088 STD SEMI [68]
BU	1	41.959/41.975	45.000/45.025	15.000			AL-LF	07-3089	07-3089 STD SEMI [68]

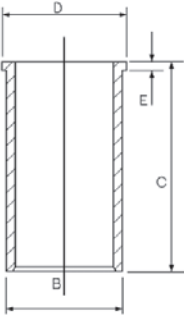
830  **79.50 Diesel** 

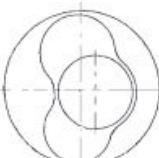
AVB	4 Cyl.	19:1	1896cc	74kW (100)PS	TD15152	233
AVB	4 Cyl.	19:1	1896cc	74kW (100)PS	TD16518	233
AVB	4 Cyl.	19:1	1896cc	74kW (100)PS	TD17037	233

A4	05/01→12/04	PASSAT	02/00→05/05	SUPERB	08/02→10/05
-----------	-------------	---------------	-------------	---------------	-------------

		
<p>87-114900-65 [43] [55] STD 87-114907-65 [33] [55] 0.50mm</p> <p>A 45.80 B- 17.20 Bø 38.00 C 1.10 D 68.80  26x66</p> <p>AK KK NB RT TP</p> <p> 07901D-301</p>	<p>08-114900-00 STD 08-114905-00 0.25mm 08-114907-00 0.50mm 08-114911-00 1.00mm</p> <p>1.75  CK P 2.00  P 3.00  CR P</p>	<p>14-027950-00 D B 82.50 C 152.00 D 85.50 E 4.70</p> <p></p>
<p>87-114900-66 [43] [59] STD 87-114907-66 [33] [59] 0.50mm</p> <p>A 45.80 B- 17.20 Bø 38.00 C 1.10 D 68.80  26x66</p> <p>AK KK NB RT TP</p> <p> 07901D-302</p>	<p>08-114900-00 STD 08-114905-00 0.25mm 08-114907-00 0.50mm 08-114911-00 1.00mm</p> <p>1.75  CK P 2.00  P 3.00  CR P</p>	

[33] A = 45.550, D = 68.550

[43] Piston Chamber Volume [ccm] 22.85

[55] To cylinder 1-2

[59] To cylinder 3-4

[33] A = 45.550, D = 68.550

[43] Volumen der Kolbenmulde [ccm] 22.85

[55] Zum Zylinder 1-2

[59] Zum Zylinder 3-4

...Continued

830		79.50		Diesel						
BE/PL	1	47.758/47.778	50.600/50.612	20.000	1.406	0.020/0.067	SP	71-3904	71-3904 STD 0.25 0.50	[64]
MB/HL 1-5	5	53.958/53.978	59.000/59.019	18.500	2.502	0.020/0.082	AL-LF	02-3085L	H084/5 STD 0.25 0.50	
MB/HL 1-5	5	53.958/53.978	59.000/59.019	18.500	2.502	0.020/0.082	AL-LF	02-3085U		
TW/A	2	59.500	73.200		1.975		AL-LF	04-3527	A123/4 STD	
TW/A	2	59.500	73.200		1.975		AL-LF	04-3528		
SE/PB	1	26.000	29.000/29.052	25.000			BC	55-3729	55-3729 SEMI	
CB/NWB 1-5	5	28.947/28.960	32.000/32.025	25.000	1.513	0.020/0.068	EC	73-3903	N147/5 STD	











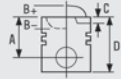

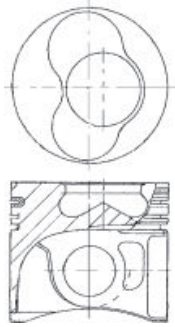
831		79.50		Diesel					
AVF	4 Cyl.	19:1	1896cc	96kW (131)PS		TD15153	234		
AVF	4 Cyl.	19:1	1896cc	96kW (131)PS		TD15348	234		
AVF	4 Cyl.	19:1	1896cc	96kW (131)PS		TD18239	234		
AWX	4 Cyl.	19:1	1896cc	96kW (131)PS		TD15154	232		
AWX	4 Cyl.	19:1	1896cc	96kW (131)PS		TD16133	232		
AWX	4 Cyl.	19:1	1896cc	96kW (131)PS		TD16403	232		
A4	11/00→12/04	A6	08/01→01/05	PASSAT	11/00→05/05				
SUPERB	12/01→03/08								

<p>87-114900-25 [50] [55] STD</p> <p>87-114907-25 [33] [55] 0.50mm</p> <p>→09/02</p> <p>A 45.80</p> <p>B- 17.90</p> <p>BØ 38.00</p> <p>C 1.10</p> <p>D 68.80</p> <p> 26x66</p> <p>AK KK NB RT TP</p>	<p>07969K101</p>	<p>08-114900-00 STD</p> <p>08-114905-00 0.25mm</p> <p>08-114907-00 0.50mm</p> <p>08-114911-00 1.00mm</p> <p>1.75 CK P</p> <p>2.00 P</p> <p>3.00 CR P</p>	<p>14-027950-00 D B 82.50 C 152.00 D 85.50 E 4.70</p>	<p>87-114900-35 [33] [42] STD</p> <p>87-114907-35 [33] [59] 0.50mm</p> <p>→09/02</p> <p>A 45.80</p> <p>B- 17.90</p> <p>BØ 38.00</p> <p>C 1.10</p> <p>D 68.80</p> <p> 26x66</p> <p>AK KK NB RT TP</p>	<p>07969K102</p>	<p>08-114900-00 STD</p> <p>08-114905-00 0.25mm</p> <p>08-114907-00 0.50mm</p> <p>08-114911-00 1.00mm</p> <p>1.75 CK P</p> <p>2.00 P</p> <p>3.00 CR P</p>

831

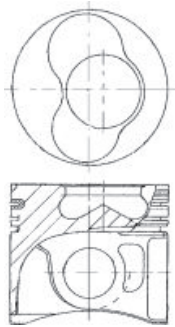
 **79.50**

Diesel

 <p>87-114900-45 [48] [55] STD 87-114907-45 [33] [55] 0.50mm</p> <p>09/02→</p> <p>A 45.80 B- 17.50 BØ 38.00 C 1.10 D 68.80  26x66</p>  <p>07901C105</p> <p>AK KK NB RT TP</p>	 <p>08-114900-00 STD 08-114905-00 0.25mm 08-114907-00 0.50mm 08-114911-00 1.00mm</p> <p>1.75  CK P 2.00  P 3.00  CR P</p>	
<p>87-114900-46 [48] [59] STD 87-114907-46 [33] [59] 0.50mm</p> <p>09/02→</p> <p>A 45.80 B- 17.50 BØ 38.00 C 1.10 D 68.80  26x66</p>  <p>07901C106</p> <p>AK KK NB RT TP</p>	<p>08-114900-00 STD 08-114905-00 0.25mm 08-114907-00 0.50mm 08-114911-00 1.00mm</p> <p>1.75  CK P 2.00  P 3.00  CR P</p>	

[33] A = 45.550, D = 68.550

[33] A = 45.550, D = 68.550

[48] Piston Chamber Volume [ccm] 24.05

[48] Volumen der Kolbenmulde [ccm] 24.05

[50] Piston Chamber Volume [ccm] 24.60









[50] Volumen der Kolbenmulde [ccm] 24.60

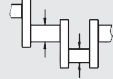
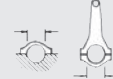

[55] To cylinder 1-2

[55] Zum Zylinder 1-2



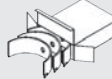



[59] To cylinder 3-4



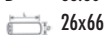

[59] Zum Zylinder 3-4

										
BE/PL	1	50.858/50.878	53.700/53.712	20.400	1.403	0.020/0.073	SP	71-3930	71-3930 STD 0.25 0.50	[64]
MB/HL 1-5	5	53.958/53.978	59.000/59.012	18.500	2.501	0.020/0.076	EC	72-3931	H079/5 STD 0.25 0.50	
TW/A	2	59.500	73.200		1.975		AL-LF	04-3527	A123/4 STD	
TW/A	2	59.500	73.200		1.975		AL-LF	04-3528		
SE/PB	1	26.000	29.000/29.052	25.000			BC	55-3729	55-3729 SEMI	
CB/NWB 1-5	5	28.947/28.960	32.000/32.025	25.000	1.513	0.020/0.068	EC	73-3903	N147/5 STD	

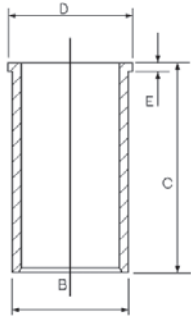

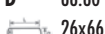





832	 79.50	Diesel				
AVQ	4 Cyl.	19:1	1896cc	74kW (100)PS	TD16861	237
AXR	4 Cyl.	19:1	1896cc	74kW (100)PS	TD16337	239
AXR	4 Cyl.	19:1	1896cc	74kW (100)PS	TD16416	239
AXR	4 Cyl.	19:1	1896cc	74kW (100)PS	TD18739	239
AXR	4 Cyl.	19:1	1896cc	74kW (100)PS	TD20195	239

A3	10/00→05/03	BORA	09/00→05/05	CORDOBA	09/02→11/09
FABIA	01/00→03/08	GOLF	09/00→06/06	IBIZA	02/02→11/09
LEON	10/05→06/06	NEW BEETLE	06/03→09/10	OCTAVIA	08/00→12/10
POLO	10/01→11/09	ROOMSTER	03/06→05/06	TOLEDO	08/05→05/06
TOURAN	02/03→05/04				

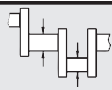
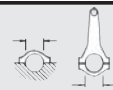
		
87-114900-65 [43] [55] STD 87-114907-65 [33] [55] 0.50mm A 45.80 B- 17.20 BØ 38.00 C 1.10 D 68.80  26x66 AK KK NB RT TP	08-114900-00 STD 08-114905-00 0.25mm 08-114907-00 0.50mm 08-114911-00 1.00mm 1.75  CK P 2.00  P 3.00  CR P 07901D-301	14-027950-00 D B 82.50 C 152.00 D 85.50 E 4.70 

87-114900-66 [43] [59] STD 87-114907-66 [33] [59] 0.50mm A 45.80 B- 17.20 BØ 38.00 C 1.10 D 68.80  26x66 AK KK NB RT TP	08-114900-00 STD 08-114905-00 0.25mm 08-114907-00 0.50mm 08-114911-00 1.00mm 1.75  CK P 2.00  P 3.00  CR P 07901D-302
---	--

[33] A = 45.550, D = 68.550 [33] A = 45.550, D = 68.550
[43] Piston Chamber Volume [ccm] 22.85 [43] Volumen der Kolbenmulde [ccm] 22.85
[55] To cylinder 1-2 [55] Zum Zylinder 1-2
[59] To cylinder 3-4 [59] Zum Zylinder 3-4

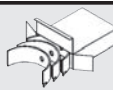
										
BE/PL	1	47.758/47.778	50.600/50.612	20.000	1.406	0.020/0.067	SP	71-3904	71-3904 STD 0.25 0.50	[64]
MB/HL 1-5	5	53.958/53.978	59.000/59.012	18.500	2.501	0.020/0.076	EC	72-3931	H079/5 STD 0.25 0.50	
TW/A	2	59.500	73.200		1.975		AL-LF	04-3527	A123/4 STD	
TW/A	2	59.500	73.200		1.975		AL-LF	04-3528		
CB/NWB 1-5	5	28.947/28.960	32.000/32.025	25.000	1.513	0.020/0.068	EC	73-3903	N147/5 STD	









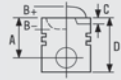
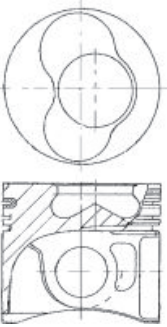

833

79.50

Diesel

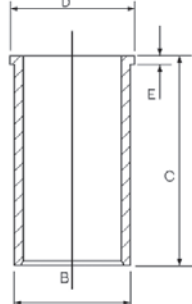
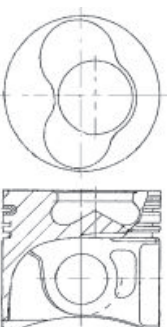

AXB	4 Cyl.	18.5:1	1896cc	77kW (105)PS	TD16867	238
AXC	4 Cyl.	18.5:1	1896cc	63kW (85)PS	TD16881	238
MULTIVAN	04/03→11/09		TRANSPORTER	04/03→11/09		

 <p>87-114900-25 [50] [55] STD 87-114907-25 [33] [55] 0.50mm</p> <p>A 45.80 B- 17.90 BØ 38.00 C 1.10 D 68.80</p> <p> 26x66</p> <p>AK KK NB RT TP</p>  <p>07969K101</p>	 <p>08-114900-00 STD 08-114905-00 0.25mm 08-114907-00 0.50mm 08-114911-00 1.00mm</p> <p>1.75  CK P 2.00  P 3.00  CR P</p>	 <p>14-027950-00 D B 82.50 C 152.00 D 85.50 E 4.70</p> 
<p>87-114900-35 [33] [42] STD 87-114907-35 [33] [59] 0.50mm</p> <p>A 45.80 B- 17.90 BØ 38.00 C 1.10 D 68.80</p> <p> 26x66</p> <p>AK KK NB RT TP</p>  <p>07969K102</p>	<p>08-114900-00 STD 08-114905-00 0.25mm 08-114907-00 0.50mm 08-114911-00 1.00mm</p> <p>1.75  CK P 2.00  P 3.00  CR P</p>	

[33] A = 45.550, D = 68.550

[33] A = 45.550, D = 68.550

[50] Piston Chamber Volume [ccm] 24.60









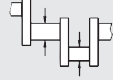

[50] Volumen der Kolbenmulde [ccm] 24.60

[55] To cylinder 1-2

[55] Zum Zylinder 1-2

[59] To cylinder 3-4

[59] Zum Zylinder 3-4

										
BE/PL	1	50.858/50.878	53.700/53.712	20.400	1.403	0.020/0.073	SP	71-3930	71-3930 STD 0.25 0.50	[64]

834

79.50

Diesel



AYQ	4 Cyl.	1896cc	47kW (64)PS	TD16198	240
AYQ	4 Cyl.	1896cc	47kW (64)PS	TD16863	240
CADDY	11/95→01/04	INCA	11/95→06/03		

<p>87-114900-20 [46] [55] STD 87-114907-20 [28] [55] 0.50mm 87-114911-20 [28] [55] 1.00mm</p> <p>A 39.80 B- 17.75 BØ 38.00 C 1.00 D 60.80 24x58</p> <p style="text-align: center;"> 07959-109</p>	<p>08-114900-00 STD 08-114905-00 0.25mm 08-114907-00 0.50mm 08-114911-00 1.00mm</p> <p>1.75 CK P 2.00 P 3.00 CR P</p>	<p>14-027950-00 D B 82.50 C 152.00 D 85.50 E 4.70</p> <p style="text-align: center;"></p>
<p>87-114900-30 [46] [59] STD 87-114907-30 [28] [59] 0.50mm 87-114911-30 [28] [59] 1.00mm</p> <p>A 39.80 B- 17.75 BØ 38.00 C 1.00 D 60.80 24x58</p> <p style="text-align: center;"> 07959A109</p>	<p>08-114900-00 STD 08-114905-00 0.25mm 08-114907-00 0.50mm 08-114911-00 1.00mm</p> <p>1.75 CK P 2.00 P 3.00 CR P</p>	

[28] A = 39.550, D = 60.550

[28] A = 39.550, D = 60.550

[46] Piston Chamber Volume [ccm] 23.60

[46] Volumen der Kolbenmulde [ccm] 23.60

[55] To cylinder 1-2

[55] Zum Zylinder 1-2

[59] To cylinder 3-4

[59] Zum Zylinder 3-4

BE/PL	4	47.758/47.778	50.600/50.619	19.000	1.406	0.020/0.074	EC	71-3442	71-3442/4 STD 0.25 0.50 0.75	
MB/HL 1-5	5	53.958/53.978	59.000/59.019	18.500	2.502	0.020/0.082	AL-LF	02-3085L	H084/5 STD 0.25 0.50	
MB/HL 1-5	5	53.958/53.978	59.000/59.019	18.500	2.502	0.020/0.082	AL-LF	02-3085U		
TW/A	2	59.500	73.200		1.975		AL-LF	04-3527	A123/4 STD	
TW/A	2	59.500	73.200		1.975		AL-LF	04-3528		
SE/PB	1	24.000	27.000/27.021	25.000			BC	55-3696	55-3696 SEMI	
BU	1	42.959/42.975	46.055/46.095	15.000			AL-LF	07-3088	07-3088 STD SEMI	[68]
BU	1	41.959/41.975	45.000/45.025	15.000			AL-LF	07-3089	07-3089 STD SEMI	[68]

835	79.50	Diesel	
BEQ	4 Cyl.	1896cc	33kW (45)PS
BJC	4 Cyl.	19.5:1	53kW (72)PS
			TD20100 241
			TD22453 248

	08-433000-00 STD 08-433007-00 0.50mm with DPF 1.75 GDC P 2.00 P 3.00 CR P 	



















BE/PL	4	47.758/47.778	50.600/50.619	20.000	1.406	0.020/0.074	EC	71-3728	71-3728/4 STD 0.25 0.50	
MB/HL 1-5	5	53.958/53.978	59.000/59.019	18.500	2.502	0.020/0.082	AL-LF	02-3085L	H084/5 STD 0.25 0.50	
MB/HL 1-5	5	53.958/53.978	59.000/59.019	18.500	2.502	0.020/0.082	AL-LF	02-3085U		
TW/A	2	59.500	73.200		1.975		AL-LF	04-3527	A123/4 STD	
TW/A	2	59.500	73.200		1.975		AL-LF	04-3528		
SE/PB	1	26.000	29.000/29.052	25.000			BC	55-3729	55-3729 SEMI	

836	79.50	Diesel	
BEU	4 Cyl.	1896cc	33kW (45)PS
			TD20101 242

87-114900-60 [45] [55] STD 87-114905-60 [55] 0.25mm 87-114907-60 [33] [55] 0.50mm 87-114911-60 [33] [55] 1.00mm A 45.80 B- 17.65 BØ 38.00 C 1.10 D 68.80 26x66 AK KK NB RT	08-114900-00 STD 08-114905-00 0.25mm 08-114907-00 0.50mm 08-114911-00 1.00mm 1.75 CK P 2.00 P 3.00 CR P 	14-027950-00 D B 82.50 C 152.00 D 85.50 E 4.70

...Continued

836  **79.50** **Diesel**

		
<p> 87-114900-70 [45] [59] STD 87-114905-70 [59] 0.25mm 87-114907-70 [33] [59] 0.50mm 87-114911-70 [33] [59] 1.00mm </p> <p> A 45.80 B- 17.65 BØ 38.00 C 1.10 D 68.80  26x66 </p> <p>AK KK NB RT</p> <p style="text-align: center;">07987A</p>	<p> 08-114900-00 STD 08-114905-00 0.25mm 08-114907-00 0.50mm 08-114911-00 1.00mm </p> <p> 1.75  CK P 2.00  P 3.00  CR P </p>	
<p> 87-114900-90 [55] STD 87-114905-90 [55] 0.25mm 87-114907-90 [34] [55] 0.50mm 87-114911-90 [34] [55] 1.00mm </p> <p> A 45.80 B- 17.65 BØ 38.00 C 1.10 D 71.80  26x66 </p> <p>AK NB RT</p>	<p> 08-114900-00 STD 08-114905-00 0.25mm 08-114907-00 0.50mm 08-114911-00 1.00mm </p> <p> 1.75  CK P 2.00  P 3.00  CR P </p>	
<p> 87-114900-95 [59] STD 87-114905-95 [59] 0.25mm 87-114907-95 [34] [59] 0.50mm 87-114911-95 [34] [59] 1.00mm </p> <p> A 45.80 B- 17.65 BØ 38.00 C 1.10 D 71.80  26x66 </p> <p>AK NB RT</p>	<p> 08-114900-00 STD 08-114905-00 0.25mm 08-114907-00 0.50mm 08-114911-00 1.00mm </p> <p> 1.75  CK P 2.00  P 3.00  CR P </p> <hr/> <p> 08-433000-00 STD 08-433007-00 0.50mm with DPF, 01/06 → </p> <p> 1.75  GDC P 2.00  P 3.00  CR P </p> <p style="text-align: center;"></p>	

[33] A = 45.550, D = 68.550

[33] A = 45.550, D = 68.550

[34] A = 45.550, D = 71.550

[34] A = 45.550, D = 71.550

[45] Piston Chamber Volume [ccm] 23.54

[45] Volumen der Kolbenmulde [ccm] 23.54

[55] To cylinder 1-2

[55] Zum Zylinder 1-2

[59] To cylinder 3-4

[59] Zum Zylinder 3-4

836		79.50		Diesel					
BE/PL	4	47.758/47.778	50.600/50.619	20.000	1.406	0.020/0.074	EC	71-3728	71-3728/4 STD 0.25 0.50
MB/HL 1-5	5	53.958/53.978	59.000/59.019	18.500	2.502	0.020/0.082	AL-LF	02-3085L	H084/5 STD 0.25 0.50
MB/HL 1-5	5	53.958/53.978	59.000/59.019	18.500	2.502	0.020/0.082	AL-LF	02-3085U	
TW/A	2	59.500	73.200		1.975		AL-LF	04-3527	A123/4 STD
TW/A	2	59.500	73.200		1.975		AL-LF	04-3528	
SE/PB	1	26.000	29.000/29.052	25.000			BC	55-3729	55-3729 SEMI

837		79.50		Diesel					
BEW	4 Cyl.	19:1	1896cc	74kW (100)PS	TD19255 243				
NEW BEETLE 02/01 →									

87-114900-65 [43] [55] STD 87-114907-65 [33] [55] 0.50mm A 45.80 B- 17.20 BØ 38.00 C 1.10 D 68.80 26x66 AK KK NB RT TP 07901D-301	08-114900-00 STD 08-114905-00 0.25mm 08-114907-00 0.50mm 08-114911-00 1.00mm 1.75 CK P 2.00 P 3.00 CR P	14-027950-00 D B 82.50 C 152.00 D 85.50 E 4.70 			
87-114900-66 [43] [59] STD 87-114907-66 [33] [59] 0.50mm A 45.80 B- 17.20 BØ 38.00 C 1.10 D 68.80 26x66 AK KK NB RT TP 07901D-302	08-114900-00 STD 08-114905-00 0.25mm 08-114907-00 0.50mm 08-114911-00 1.00mm 1.75 CK P 2.00 P 3.00 CR P	08-433000-00 STD 08-433007-00 0.50mm with DPF, 01/06 → 1.75 GDC P 2.00 P 3.00 CR P 			

[33] A = 45.550, D = 68.550

[43] Piston Chamber Volume [ccm] 22.85

[55] To cylinder 1-2

[59] To cylinder 3-4

[33] A = 45.550, D = 68.550

[43] Volumen der Kolbenmulde [ccm] 22.85

[55] Zum Zylinder 1-2

[59] Zum Zylinder 3-4

...Continued

837		79.50		Diesel						
MB/HL 1-5	5	53.958/53.978	59.000/59.012	18.500	2.501	0.020/0.076	EC	72-3931	H079/5 STD 0.25 0.50	
TW/A	2	59.500	73.200		1.975		AL-LF	04-3527	A123/4 STD	
TW/A	2	59.500	73.200		1.975		AL-LF	04-3528		
CB/NWB 1-5	5	28.947/28.960	32.000/32.025	25.000	1.513	0.020/0.068	EC	73-3903	N147/5 STD	

838		79.50		Diesel					
BGG	4 Cyl.	22.50:1	1896cc	47kW (64)PS		TD21349	244		
BGL	4 Cyl.	19:1	1896cc	37kW (50)PS		TD25870	245		
BGM	4 Cyl.	19:1	1896cc	29kW (40)PS		TD25871	246		
BXT	4 Cyl.	19:1	1896cc	30kW (41)PS		TD25869	262		
CDXA	4 Cyl.	23:1	1896cc	55kW (75)PS		TD23291	263		
CDXB	4 Cyl.	23:1	1896cc	29kW (40)PS		TD23292	264		
GOL	06/02→12/10	GOLF	12/05→	PARATI	08/02→				
POINTER	12/05→								

	08-433000-00 STD 08-433007-00 0.50mm with DPF 1.75 GDC P 2.00 P 3.00 CR P 	











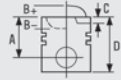

839		79.50		Diesel					
BJB	4 Cyl.	19:1	1896cc	77kW (105)PS		TD17078	247		
BJB	4 Cyl.	19:1	1896cc	77kW (105)PS		TD17356	247		
BJB	4 Cyl.	19:1	1896cc	77kW (105)PS		TD17499	247		
ALTEA	04/04→	CADDY	04/04→08/10	OCTAVIA	06/04→12/10				
TOLEDO	10/04→05/09								

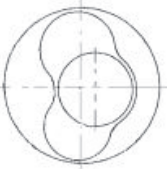
87-114900-65 [43] [55] STD 87-114907-65 [33] [55] 0.50mm A 45.80 B- 17.20 BØ 38.00 C 1.10 D 68.80 26x66 AK KK NB RT TP 07901D-301	08-114900-00 STD 08-114905-00 0.25mm 08-114907-00 0.50mm 08-114911-00 1.00mm 1.75 CK P 2.00 P 3.00 CR P	14-027950-00 D B 82.50 C 152.00 D 85.50 E 4.70

839

 79.50

Diesel

		
<p>87-114900-66 [43] [59] STD 87-114907-66 [33] [59] 0.50mm</p> <p>A 45.80 B- 17.20 BØ 38.00 C 1.10 D 68.80</p> <p> 26x66</p> <p>AK KK NB RT TP</p>	<p style="text-align: center;">  07901D-302 </p> <p>08-114900-00 STD 08-114905-00 0.25mm 08-114907-00 0.50mm 08-114911-00 1.00mm</p> <p>1.75  CK P 2.00  P 3.00  CR P</p>	
	<p>08-433000-00 STD 08-433007-00 0.50mm with DPF, 01/06 →</p> <p>1.75  GDC P 2.00  P 3.00  CR P</p> <p style="text-align: center;"></p>	

[33] A = 45.550, D = 68.550

[33] A = 45.550, D = 68.550

[43] Piston Chamber Volume [ccm] 22.85









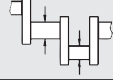

[43] Volumen der Kolbenmulde [ccm] 22.85

[55] To cylinder 1-2

[55] Zum Zylinder 1-2











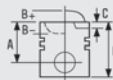



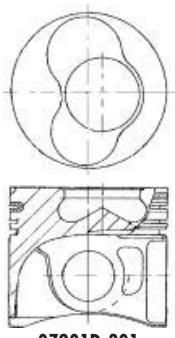

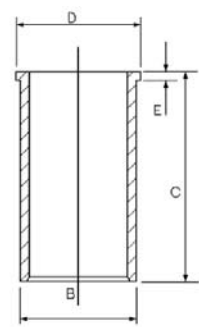

[59] To cylinder 3-4

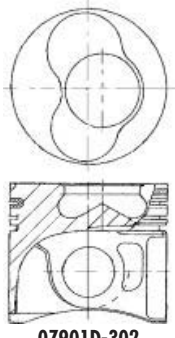
[59] Zum Zylinder 3-4

										
BE/PL	1	47.758/47.778	50.600/50.612	20.000	1.406	0.020/0.067	SP	71-3904	71-3904 STD 0.25 0.50	[64]
MB/HL 1-5	5	53.958/53.978	59.000/59.012	18.500	2.501	0.020/0.076	EC	72-3931	H079/5 STD 0.25 0.50	
TW/A	2	59.500	73.200		1.975		AL-LF	04-3527	A123/4 STD	
TW/A	2	59.500	73.200		1.975		AL-LF	04-3528		
CB/NWB 1-5	5	28.947/28.960	32.000/32.025	25.000	1.513	0.020/0.068	EC	73-3903	N147/5 STD	

840		79.50		Diesel			
BKC	4 Cyl.	19:1	1896cc	77kW (105)PS	TD17026	247	
BKC	4 Cyl.	19:1	1896cc	77kW (105)PS	TD17079	247	
BKC	4 Cyl.	19:1	1896cc	77kW (105)PS	TD17355	247	
BKC	4 Cyl.	19:1	1896cc	77kW (105)PS	TD17497	247	
BMT	4 Cyl.		1896cc	74kW (100)PS	TD20494	250	
BMT	4 Cyl.		1896cc	74kW (100)PS	TD20495	250	
BXE	4 Cyl.	19:1	1896cc	77kW (105)PS	TD18908	247	
BXE	4 Cyl.	19:1	1896cc	77kW (105)PS	TD19819	247	
BXE	4 Cyl.	19:1	1896cc	77kW (105)PS	TD20513	247	
BXE	4 Cyl.	19:1	1896cc	77kW (105)PS	TD22657	247	
BXF	4 Cyl.	19:1	1896cc	66kW (89)PS	TD18907	247	
BXF	4 Cyl.	19:1	1896cc	66kW (89)PS	TD20866	247	
BXJ	4 Cyl.	19.5:1	1896cc	66kW (89)PS	TD20493	250	
BXJ	4 Cyl.	19.5:1	1896cc	66kW (89)PS	TD20840	250	

A3	05/03→05/10	ALTEA	04/04→	ALTEA XL	10/06→
CORDOBA	09/02→11/09	GOLF	10/03→	IBIZA	02/02→06/10
JETTA	08/05→10/10	LEON	07/05→	OCTAVIA	06/04→12/10
PASSAT	03/05→11/08	POLO	10/01→11/09	SUPERB	03/08→
TOLEDO	10/04→05/09	TOURAN	08/03→05/10		

					
87-114900-65 [43] [55] STD 87-114907-65 [33] [55] 0.50mm A 45.80 B- 17.20 BØ 38.00 C 1.10 D 68.80  26x66 AK KK NB RT TP	 07901D-301	08-114900-00 STD 08-114905-00 0.25mm 08-114907-00 0.50mm 08-114911-00 1.00mm 1.75  CK P 2.00  P 3.00  CR P	14-027950-00 D B 82.50 C 152.00 D 85.50 E 4.70 		
87-114900-66 [43] [59] STD 87-114907-66 [33] [59] 0.50mm A 45.80 B- 17.20 BØ 38.00 C 1.10 D 68.80  26x66 AK KK NB RT TP	 07901D-302	08-114900-00 STD 08-114905-00 0.25mm 08-114907-00 0.50mm 08-114911-00 1.00mm 1.75  CK P 2.00  P 3.00  CR P 08-433000-00 STD 08-433007-00 0.50mm with DPF, 01/06→ 1.75  GDC P 2.00  P 3.00  CR P 			

[33] A = 45.550, D = 68.550

[33] A = 45.550, D = 68.550

[43] Piston Chamber Volume [ccm] 22.85







[43] Volumen der Kolbenmulde [ccm] 22.85

[55] To cylinder 1-2



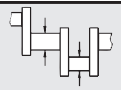
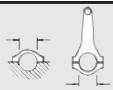

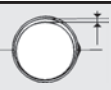

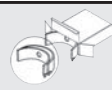
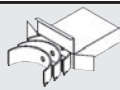

[55] Zum Zylinder 1-2

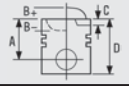
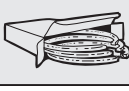







[59] To cylinder 3-4

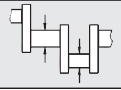
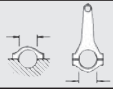

[59] Zum Zylinder 3-4

840		 79.50	Diesel							
										
BE/PL	1	47.758/47.778	50.600/50.612	20.000	1.406	0.020/0.067	SP	71-3904	71-3904 STD 0.25 0.50	[64]
MB/HL 1-5	5	53.958/53.978	59.000/59.012	18.500	2.501	0.020/0.076	EC	72-3931	H079/5 STD 0.25 0.50	
TW/A	2	59.500	73.200		1.975		AL-LF	04-3527	A123/4 STD	
TW/A	2	59.500	73.200		1.975		AL-LF	04-3528		

841		 79.50	Diesel						
BKE	4 Cyl.	1896cc	85kW (115)PS				TD17596	249	
A4	06/04 → 06/08								

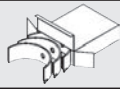
		
<p>08-114900-00 STD 08-114905-00 0.25mm 08-114907-00 0.50mm 08-114911-00 1.00mm</p> <p>1.75  CK P 2.00  P 3.00  CR P</p> <p>08-433000-00 STD 08-433007-00 0.50mm with DPF, 01/06 →</p> <p>1.75  GDC P 2.00  P 3.00  CR P</p> <p></p>		

									
MB/HL 1-5	5	53.958/53.978	59.000/59.012	18.500	2.501	0.020/0.076	EC	72-3931	H079/5 STD 0.25 0.50
TW/A	2	59.500	73.200		1.975		AL-LF	04-3527	A123/4 STD
TW/A	2	59.500	73.200		1.975		AL-LF	04-3528	
SE/PB	1	26.000	29.000/29.052	25.000			BC	55-3729	55-3729 SEMI
CB/NWB 1-5	5	28.947/28.960	32.000/32.025	25.000	1.513	0.020/0.068	EC	73-3903	N147/5 STD

842	 79.50	Diesel				
BLS	4 Cyl.	19:1	1896cc	77kW (105)PS	TD18224	250
BLS	4 Cyl.	19:1	1896cc	77kW (105)PS	TD18268	250
BLS	4 Cyl.	19:1	1896cc	77kW (105)PS	TD19091	250
BLS	4 Cyl.	19:1	1896cc	77kW (105)PS	TD20823	250

A3	05/03 →	ALTEA	04/04 →	ALTEA XL	10/06 →
CADDY	04/04 →08/10	FABIA	04/07 →	GOLF	10/03 →
IBIZA	03/08 →06/10	JETTA	08/05 →10/10	LEON	07/05 →
OCTAVIA	06/04 →12/10	PASSAT	03/05 →11/08	ROOMSTER	09/06 →03/10
SUPERB	03/08 →	TOLEDO	10/04 →05/09	TOURAN	08/03 →05/10



87-114900-65 [43] [55] STD
87-114907-65 [33] [55] 0.50mm

A 45.80
 B- 17.20
 BØ 38.00
 C 1.10
 D 68.80

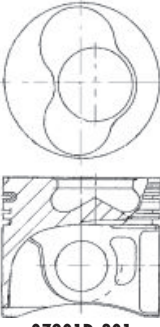

 26x66

AK KK NB RT TP



07901D-301

08-114900-00 STD
08-114905-00 0.25mm
08-114907-00 0.50mm
08-114911-00 1.00mm

1.75  CK P
 2.00  P
 3.00  CR P

87-114900-66 [43] [59] STD
87-114907-66 [33] [59] 0.50mm

A 45.80
 B- 17.20
 BØ 38.00
 C 1.10
 D 68.80

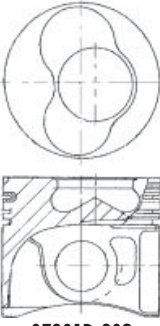

 26x66

AK KK NB RT TP







07901D-302

08-114900-00 STD
08-114905-00 0.25mm
08-114907-00 0.50mm
08-114911-00 1.00mm

1.75  CK P
 2.00  P
 3.00  CR P

08-433000-00 STD
08-433007-00 0.50mm
 with DPf, 01/06 →









1.75  GDC P
 2.00  P
 3.00  CR P

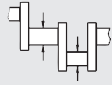
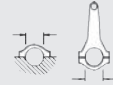

[33] A = 45.550, D = 68.550
 [43] Piston Chamber Volume [ccm] 22.85
 [55] To cylinder 1-2

[33] A = 45.550, D = 68.550
 [43] Volumen der Kolbenmulde [ccm] 22.85
 [55] Zum Zylinder 1-2

[59] To cylinder 3-4
 [59] Zum Zylinder 3-4

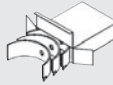
										[64]
BE/PL	1	47.758/47.778	50.600/50.612	20.000	1.406	0.020/0.067	SP	71-3904	71-3904 STD 0.25 0.50	[64]
MB/HL 1-5	5	53.958/53.978	59.000/59.012	18.500	2.501	0.020/0.076	EC	72-3931	H079/5 STD 0.25 0.50	
TW/A	2	59.500	73.200		1.975		AL-LF	04-3527	A123/4 STD	
TW/A	2	59.500	73.200		1.975		AL-LF	04-3528		

843











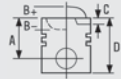



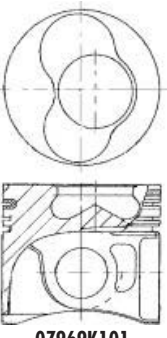

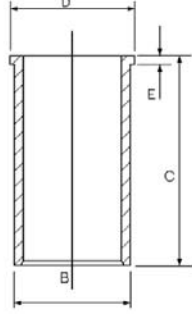

 79.50

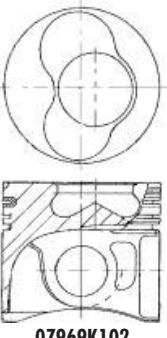
Diesel



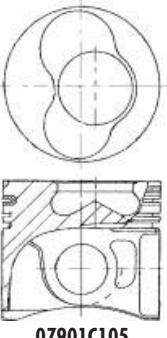







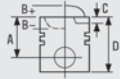

BLT	4 Cyl.	19:1	1896cc	96kW (131)PS	TD17467	238
BLT	4 Cyl.	19:1	1896cc	96kW (131)PS	TD20516	238
BLT	4 Cyl.	19:1	1896cc	96kW (131)PS	TD20517	238

CORDOBA	10/02→11/09	FABIA	06/03→03/08	IBIZA	02/02→11/09
POLO	11/03→11/09				

		
<p>87-114900-25 [50] [55] STD 87-114907-25 [33] [55] 0.50mm</p> <p>→09/02</p> <p>A 45.80 B- 17.90 BØ 38.00 C 1.10 D 68.80  26x66</p> <p>AK KK NB RT TP</p>  <p style="text-align: center;">07969K101</p>	<p>08-114900-00 STD 08-114905-00 0.25mm 08-114907-00 0.50mm 08-114911-00 1.00mm</p> <p>1.75  CK P 2.00  P 3.00  CR P</p>	<p>14-027950-00 D B 82.50 C 152.00 D 85.50 E 4.70</p> 
<p>87-114900-35 [33] [42] STD 87-114907-35 [33] [59] 0.50mm</p> <p>→09/02</p> <p>A 45.80 B- 17.90 BØ 38.00 C 1.10 D 68.80  26x66</p> <p>AK KK NB RT TP</p>  <p style="text-align: center;">07969K102</p>	<p>08-114900-00 STD 08-114905-00 0.25mm 08-114907-00 0.50mm 08-114911-00 1.00mm</p> <p>1.75  CK P 2.00  P 3.00  CR P</p>	
<p>87-114900-45 [48] [55] STD 87-114907-45 [33] [55] 0.50mm</p> <p>09/02→</p> <p>A 45.80 B- 17.50 BØ 38.00 C 1.10 D 68.80  26x66</p> <p>AK KK NB RT TP</p>  <p style="text-align: center;">07901C105</p>	<p>08-114900-00 STD 08-114905-00 0.25mm 08-114907-00 0.50mm 08-114911-00 1.00mm</p> <p>1.75  CK P 2.00  P 3.00  CR P</p>	





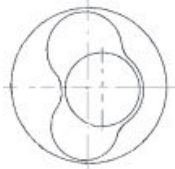
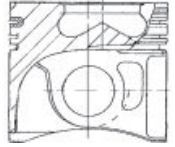



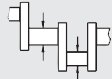
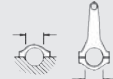

...Continued

843  **79.50** **Diesel**

 <p>87-114900-46 [48] [59] STD 87-114907-46 [33] [59] 0.50mm</p> <p>09/02→</p> <p>A 45.80 B- 17.50 BØ 38.00 C 1.10 D 68.80  26x66</p> <p>AK KK NB RT TP</p>	 <p>08-114900-00 STD 08-114905-00 0.25mm 08-114907-00 0.50mm 08-114911-00 1.00mm</p> <p>1.75  CK P 2.00  P 3.00  CR P</p> <hr/> <p>08-433000-00 STD 08-433007-00 0.50mm with DPF, 01/06→</p> <p>1.75  GDC P 2.00  P 3.00  CR P</p> <p></p>	
  <p>07901C106</p>		

[33] A = 45.550, D = 68.550
 [48] Piston Chamber Volume [ccm] 24.05
 [50] Piston Chamber Volume [ccm] 24.60
 [55] To cylinder 1-2
 [59] To cylinder 3-4



[33] A = 45.550, D = 68.550
 [48] Volumen der Kolbenmulde [ccm] 24.05
 [50] Volumen der Kolbenmulde [ccm] 24.60
 [55] Zum Zylinder 1-2
 [59] Zum Zylinder 3-4



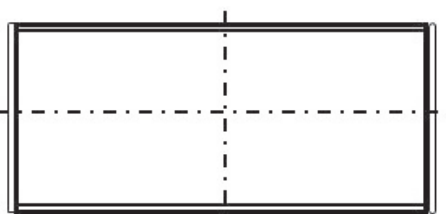



										
BE/PL	1	47.758/47.778	50.600/50.612	20.000	1.406	0.020/0.067	SP	71-3904	71-3904 STD 0.25 0.50	[64]
BE/PL	1	50.858/50.878	53.700/53.712	20.400	1.403	0.020/0.073	SP	71-3930	71-3930 STD 0.25 0.50	[64]

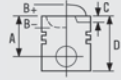

71-3904











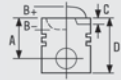





MB/HL 1-5	5	53.958/53.978	59.000/59.012	18.500	2.501	0.020/0.076	EC	72-3931	H079/5 STD 0.25 0.50
TW/A	2	59.500	73.200		1.975		AL-LF	04-3527	A123/4 STD
TW/A	2	59.500	73.200		1.975		AL-LF	04-3528	
CB/NWB 1-5	5	28.947/28.960	32.000/32.025	25.000	1.513	0.020/0.068	EC	73-3903	N147/5 STD

844	 79.50	Diesel				
BPX	4 Cyl.	19:1	1896cc	118kW (160)PS	TD17640	252
IBIZA	03/04 → 02/08					

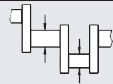
		
	<p>08-433000-00 STD 08-433007-00 0.50mm with DPF</p> <p>1.75  GDC P 2.00  P 3.00  CR P</p> <p></p>	

845	 79.50	Diesel					
BPZ	4 Cyl.	19:1	1896cc	85kW (115)PS	TD20205	253	
BPZ	4 Cyl.	19:1	1896cc	85kW (115)PS	TD25766	253	
BSV	4 Cyl.		1896cc	77kW (105)PS	TD20206	258	
BTB	4 Cyl.		1896cc	110kW (150)PS	TD18232	238	
BTB	4 Cyl.		1896cc	110kW (150)PS	TD20625	238	
ALHAMBRA	05/05 → 05/07		SHARAN	06/05 → 03/10		SUPERB	10/05 → 03/08

		
	<p>08-433000-00 STD 08-433007-00 0.50mm with DPF</p> <p>1.75  GDC P 2.00  P 3.00  CR P</p> <p></p>	

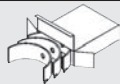
									
BE/PL	1	50.858/50.878	53.700/53.712	20.400	1.403	0.020/0.073	SP	71-3930	71-3930 STD 0.25 0.50
MB/HL 1-5	5	53.958/53.978	59.000/59.012	18.500	2.501	0.020/0.076	EC	72-3931	H079/5 STD 0.25 0.50
TW/A	2	59.500	73.200		1.975		AL-LF	04-3527	A123/4 STD
TW/A	2	59.500	73.200		1.975		AL-LF	04-3528	

846

79.50

Diesel



BRB 4 Cyl. 19:1 1896cc 85kW (115)PS TD20492 254

A4 11/04→06/08

<p>87-114900-55 [36] [46] [55] STD 87-114907-55 [33] [55] 0.50mm</p> <p>A 45.80 B- 17.60 BØ 38.00 C 1.10 D 68.80 26x66</p> <p>AK KK NB RT TP</p> <p>07901D101</p>	<p>08-114900-00 STD 08-114905-00 0.25mm 08-114907-00 0.50mm 08-114911-00 1.00mm</p> <p>1.75 CK P 2.00 P 3.00 CR P</p>	<p>14-027950-00 D B 82.50 C 152.00 D 85.50 E 4.70</p>
<p>87-114900-56 [36] [46] [59] STD 87-114907-56 [33] [36] [59] 0.50mm</p> <p>A 45.80 B- 17.60 BØ 38.00 C 1.10 D 68.60 26x66</p> <p>AK KK NB RT TP</p> <p>07901D102</p>	<p>08-114900-00 STD 08-114905-00 0.25mm 08-114907-00 0.50mm 08-114911-00 1.00mm</p> <p>1.75 CK P 2.00 P 3.00 CR P</p> <p>08-433000-00 STD 08-433007-00 0.50mm with DPF, 01/06→</p> <p>1.75 GDC P 2.00 P 3.00 CR P</p> <p></p>	

[33] A = 45.550, D = 68.550 [36] For newer design straight injection nozzle [36] Für neuere Ausführungen, direkt einspritzende Düsen
 [46] Piston Chamber Volume [ccm] 23.60 [46] Volumen der Kolbenmulde [ccm] 23.60
 [55] To cylinder 1-2 [55] Zum Zylinder 1-2
 [59] To cylinder 3-4 [59] Zum Zylinder 3-4

BE/PL	1	50.858/50.878	53.700/53.712	20.400	1.403	0.020/0.073	SP	71-3930	71-3930 STD 0.25 0.50	[64]
MB/HL 1-5	5	53.958/53.978	59.000/59.012	18.500	2.501	0.020/0.076	EC	72-3931	H079/5 STD 0.25 0.50	
TW/A	2	59.500	73.200		1.975		AL-LF	04-3527	A123/4 STD	
TW/A	2	59.500	73.200		1.975		AL-LF	04-3528		
CB/NWB 1-5	5	28.947/28.960	32.000/32.025	25.000	1.513	0.020/0.068	EC	73-3903	N147/5 STD	

847









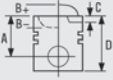

 79.50

Diesel



BRM 4 Cyl. 1896cc 74kW (100)PS TD20629 255

JETTA 08/05→06/08

		
	<p>08-114900-00 STD 08-114905-00 0.25mm 08-114907-00 0.50mm 08-114911-00 1.00mm</p> <p>1.75  CK P 2.00  P 3.00  CR P</p> <hr/> <p>08-433000-00 STD 08-433007-00 0.50mm with DPF, 01/06→</p> <p>1.75  GDC P 2.00  P 3.00  CR P</p> <p></p>	

848

 79.50









Diesel

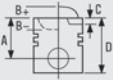

BRR 4 Cyl. 1896cc 62kW (84)PS TD20159 256

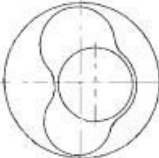



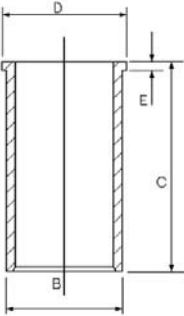



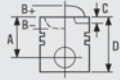

BRS 4 Cyl. 1896cc 75kW (102)PS TD18994 256

MULTIVAN 01/06→11/09 TRANSPORTER 01/06→11/09

		
<p>87-114900-45 [48] [55] STD 87-114907-45 [33] [55] 0.50mm</p> <p>A 45.80 B- 17.50 BØ 38.00 C 1.10 D 68.80</p> <p> 26x66</p> <p>AK KK NB RT TP</p> <p>  07901C105</p>	<p>08-114900-00 STD 08-114905-00 0.25mm 08-114907-00 0.50mm 08-114911-00 1.00mm</p> <p>1.75  CK P 2.00  P 3.00  CR P</p>	<p>14-027950-00 D B 82.50 C 152.00 D 85.50 E 4.70</p> <p></p>





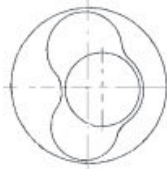
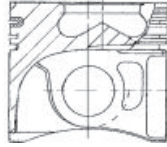



...Continued

848  **79.50** **Diesel**

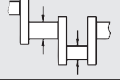
 <p>87-114900-46 [48] [59] STD 87-114907-46 [33] [59] 0.50mm</p> <p>A 45.80 B- 17.50 BØ 38.00 C 1.10 D 68.80</p>  26x66 <p>AK KK NB RT TP</p>	 <p>08-114900-00 STD 08-114905-00 0.25mm 08-114907-00 0.50mm 08-114911-00 1.00mm</p> <p>1.75  CK P 2.00  P 3.00  CR P</p> <hr/> <p>08-433000-00 STD 08-433007-00 0.50mm with DPF, 01/06 →</p> <p>1.75  GDC P 2.00  P 3.00  CR P</p> <p style="text-align: center;"></p>	
  <p style="text-align: center;">07901C106</p>		

[33] A = 45.550, D = 68.550
 [48] Piston Chamber Volume [ccm] 24.05
 [55] To cylinder 1-2
 [59] To cylinder 3-4

[33] A = 45.550, D = 68.550
 [48] Volumen der Kolbenmulde [ccm] 24.05
 [55] Zum Zylinder 1-2
 [59] Zum Zylinder 3-4

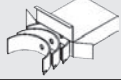
										
BE/PL	1	50.858/50.878	53.700/53.712	20.400	1.403	0.020/0.073	SP	71-3930	71-3930 STD 0.25 0.50	[64]
MB/HL 1-5	5	53.958/53.978	59.000/59.019	18.500	2.502	0.020/0.082	AL-LF	02-3085L	H084/5 STD 0.25 0.50	
MB/HL 1-5	5	53.958/53.978	59.000/59.019	18.500	2.502	0.020/0.082	AL-LF	02-3085U		
TW/A	2	59.500	73.200		1.975		AL-LF	04-3527	A123/4 STD	
TW/A	2	59.500	73.200		1.975		AL-LF	04-3528		
CB/NWB 1-5	5	28.947/28.960	32.000/32.025	25.000	1.513	0.020/0.068	EC	73-3903	N147/5 STD	
BU	1	42.959/42.975	46.055/46.095	15.000			AL-LF	07-3088	07-3088 STD SEMI	[68]
BU	1	41.959/41.975	45.000/45.025	15.000			AL-LF	07-3089	07-3089 STD SEMI	[68]

849

79.50

Diesel



BRU	4 Cyl.	19:1	1896cc	66kW (89)PS	TD17468	247
BSU	4 Cyl.		1896cc	55kW (75)PS	TD18755	257
BSW	4 Cyl.	18.5:1	1896cc	77kW (105)PS	TD18771	259
BSW	4 Cyl.	18.5:1	1896cc	77kW (105)PS	TD20004	259

CADDY	09/05→08/10	FABIA	04/07→	GOLF	05/04→12/08
NEW BEETLE	07/05→	ROOMSTER	09/06→03/10	TOURAN	11/04→05/10

<p>87-114900-65 [43] [55] STD 87-114907-65 [33] [55] 0.50mm</p> <p>A 45.80 B- 17.20 BØ 38.00 C 1.10 D 68.80 26x66</p> <p>AK KK NB RT TP</p> <p style="text-align: center;">07901D-301</p>	<p>08-114900-00 STD 08-114905-00 0.25mm 08-114907-00 0.50mm 08-114911-00 1.00mm</p> <p>1.75 CK P 2.00 P 3.00 CR P</p>	<p>14-027950-00 D B 82.50 C 152.00 D 85.50 E 4.70</p> <p style="text-align: center;">07901D-302</p>
<p>87-114900-66 [43] [59] STD 87-114907-66 [33] [59] 0.50mm</p> <p>A 45.80 B- 17.20 BØ 38.00 C 1.10 D 68.80 26x66</p> <p>AK KK NB RT TP</p> <p style="text-align: center;">07901D-302</p>	<p>08-114900-00 STD 08-114905-00 0.25mm 08-114907-00 0.50mm 08-114911-00 1.00mm</p> <p>1.75 CK P 2.00 P 3.00 CR P</p>	
	<p>08-433000-00 STD 08-433007-00 0.50mm with DPF, 01/06→</p> <p>1.75 GDC P 2.00 P 3.00 CR P</p> <p style="text-align: center;"></p>	

[33] A = 45.550, D = 68.550

[33] A = 45.550, D = 68.550

[43] Piston Chamber Volume [ccm] 22.85

[43] Volumen der Kolbenmulde [ccm] 22.85

[55] To cylinder 1-2

[55] Zum Zylinder 1-2

[59] To cylinder 3-4

[59] Zum Zylinder 3-4

BE/PL	1	47.758/47.778	50.600/50.612	20.000	1.406	0.020/0.067	SP	71-3904	71-3904 STD 0.25 0.50	[64]
MB/HL 1-5	5	53.958/53.978	59.000/59.019	18.500	2.502	0.020/0.082	AL-LF	02-3085L	H084/5 STD 0.25 0.50	
MB/HL 1-5	5	53.958/53.978	59.000/59.019	18.500	2.502	0.020/0.082	AL-LF	02-3085U		
TW/A	2	59.500	73.200		1.975		AL-LF	04-3527	A123/4 STD	
TW/A	2	59.500	73.200		1.975		AL-LF	04-3528		

850	79.50	Diesel	
BUK	4 Cyl.	19:1	1896cc
			118kW (160)PS
			TD22667 260
IBIZA	03/04 → 02/08		

	<p>08-114900-00 STD</p> <p>08-114905-00 0.25mm</p> <p>08-114907-00 0.50mm</p> <p>08-114911-00 1.00mm</p> <p>1.75 CK P</p> <p>2.00 P</p> <p>3.00 CR P</p>	<p>14-027950-00 D B 82.50 C 152.00 D 85.50 E 4.70</p>
	<p>08-433000-00 STD</p> <p>08-433007-00 0.50mm</p> <p>with DPF, 01/06 →</p> <p>1.75 GDC P</p> <p>2.00 P</p> <p>3.00 CR P</p> <p></p>	

851	79.50	Diesel	
BVK	4 Cyl.	18:1	1896cc
			85kW (115)PS
			TD20489 261
BVK	4 Cyl.	18:1	1896cc
			85kW (115)PS
			TD20515 261
ALHAMBRA	06/00 → 03/10		SHARAN 04/00 → 03/10

<p>87-114900-05 [37] [55] STD</p> <p>87-114907-05 [33] [55] 0.50mm</p> <p>→09/02</p> <p>A 45.80</p> <p>B- 17.80</p> <p>BØ 38.00</p> <p>C 1.30</p> <p>D 68.80</p> <p> 26x66</p> <p>AK KK NB RT TP</p> <p>07969L-101</p>	<p>08-114900-00 STD</p> <p>08-114905-00 0.25mm</p> <p>08-114907-00 0.50mm</p> <p>08-114911-00 1.00mm</p> <p>1.75 CK P</p> <p>2.00 P</p> <p>3.00 CR P</p>	<p>14-027950-00 D B 82.50 C 152.00 D 85.50 E 4.70</p>
<p>87-114900-15 [37] [59] STD</p> <p>87-114907-15 [33] [37] [59] 0.50mm</p> <p>→09/02</p> <p>A 45.80</p> <p>B- 17.80</p> <p>BØ 38.00</p> <p>C 1.30</p> <p>D 68.80</p> <p> 26x66</p> <p>AK KK NB RT TP</p> <p>07969L-102</p>	<p>08-114900-00 STD</p> <p>08-114905-00 0.25mm</p> <p>08-114907-00 0.50mm</p> <p>08-114911-00 1.00mm</p> <p>1.75 CK P</p> <p>2.00 P</p> <p>3.00 CR P</p>	

851

79.50

Diesel

<p>87-114900-55 [36] [46] [55] STD 87-114907-55 [33] [36] [55] 0.50mm</p> <p>09/02→</p> <p>A 45.80 B- 17.60 BØ 38.00 C 1.10 D 68.80 26x66</p> <p>AK KK NB RT TP</p>	<p>07901D101</p>	<p>08-114900-00 STD 08-114905-00 0.25mm 08-114907-00 0.50mm 08-114911-00 1.00mm</p> <p>1.75 CK P 2.00 P 3.00 CR P</p>
<p>87-114900-56 [36] [46] [59] STD 87-114907-56 [33] [36] [59] 0.50mm</p> <p>09/02→</p> <p>A 45.80 B- 17.60 BØ 38.00 C 1.10 D 68.60 26x66</p> <p>AK KK NB RT TP</p>	<p>07901D102</p>	<p>08-114900-00 STD 08-114905-00 0.25mm 08-114907-00 0.50mm 08-114911-00 1.00mm</p> <p>1.75 CK P 2.00 P 3.00 CR P</p> <p>08-433000-00 STD 08-433007-00 0.50mm with DPF, 01/06→</p> <p>1.75 GDC P 2.00 P 3.00 CR P</p> <p style="text-align: center;"></p>

[33] A = 45.550, D = 68.550

[33] A = 45.550, D = 68.550

[36] For newer design straight injection nozzle

[36] Für neuere Ausführungen, direkt einspritzende Düsen

[37] For side angled injection nozzle

[37] Nur für schräg angeordnete Einspritzdüsen

[46] Piston Chamber Volume [ccm] 23.60

[46] Volumen der Kolbenmulde [ccm] 23.60

[55] To cylinder 1-2

[55] Zum Zylinder 1-2

[59] To cylinder 3-4

[59] Zum Zylinder 3-4

BE/PL	1	50.858/50.878	53.700/53.712	20.400	1.403	0.020/0.073	SP	71-3930	71-3930	71-3930
MB/HL 1-5	5	53.958/53.978	59.000/59.019	18.500	2.502	0.020/0.082	AL-LF	02-3085L	02-3085L	STD 0.25 0.50 H084/5 STD 0.25 0.50
MB/HL 1-5	5	53.958/53.978	59.000/59.019	18.500	2.502	0.020/0.082	AL-LF	02-3085U	02-3085U	
TW/A	2	59.500	73.200		1.975		AL-LF	04-3527	04-3527	A123/4 STD
TW/A	2	59.500	73.200		1.975		AL-LF	04-3528	04-3528	

852







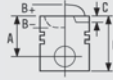
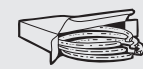

 79.50

Petrol











WH 5 Cyl. 10:1 1921cc 74kW (100)PS TD336 265

100 08/80→07/84

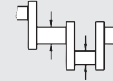
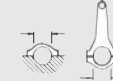
		
	<p>08-404100-00 STD 08/77→08/84</p> <p>1.75  CR P 2.00  P 4.00  CR[52]</p>	
	<p>08-404700-10 STD 08-404705-10 0.25mm 08-404707-10 0.50mm 08/77→08/84</p> <p>1.75  CR P 2.00  P 4.00  CR[52]</p>	

[52] Steel

[52] Stahl

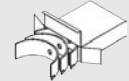
									
BE/PL	1	45.950/45.970	49.000/49.016	19.000	1.506	0.020/0.078	EC	71-3084	71-3084 STD 0.25 0.50
→12/83									
BE/PL	5	47.758/47.778	50.600/50.619	19.000	1.406	0.020/0.074	EC	71-3566	71-3566/5 STD
01/84→									

71-3084

71-3566

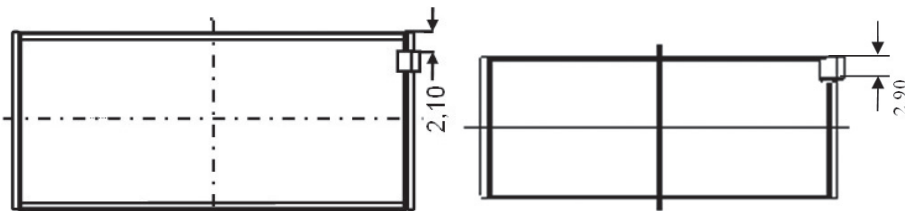

MB/HL 1-6	6	57.958/57.978	63.000/63.019	18.500	2.502	0.020/0.082	EC	72-3400	H981/6 STD 0.25
TW/A	2	63.500/63.750	77.200/77.450		1.975		AL-LF	04-3529	A124/4 STD
TW/A	2	63.500/63.750	77.200/77.450		1.975		AL-LF	04-3530	
TW/A	2	63.500/63.750	76.950/77.200		1.975		AL-LF	04-4782	A292/4 STD
TW/A	2	63.500/63.750	76.950/77.200		1.975		AL-LF	04-4783	

853
 **79.50**
Petrol

WN	5 Cyl.	9.5/10:1	1921cc	85kW (115)PS	TD339	268
WN	5 Cyl.	9.5/10:1	1921cc	85kW (115)PS	TD5031	268
80	09/81→07/83		COUPE	08/80→07/83	PASSAT	01/81→07/83
SANTANA	08/81→07/83					

<p>08-404100-00 STD 08/77→08/84</p> <p>1.75 CR P 2.00 P 4.00 CR[52]</p>		
<p>08-404700-10 STD 08-404705-10 0.25mm 08-404707-10 0.50mm 08/77→08/84</p> <p>1.75 CR P 2.00 P 4.00 CR[52]</p>		

[52] Steel

[52] Stahl









BE/PL	1	45.950/45.970	49.000/49.016	19.000	1.506	0.020/0.078	EC	71-3084	71-3084 STD 0.25 0.50
MB/HL 1-6	6	57.958/57.978	63.000/63.019	18.500	2.502	0.020/0.082	EC	72-3400	H981/6 STD 0.25
TW/A	2	63.500/63.750	77.200/77.450		1.975		AL-LF	04-3529	A124/4 STD
TW/A	2	63.500/63.750	77.200/77.450		1.975		AL-LF	04-3530	
TW/A	2	63.500/63.750	76.950/77.200		1.975		AL-LF	04-4782	A292/4 STD
TW/A	2	63.500/63.750	76.950/77.200		1.975		AL-LF	04-4783	

854

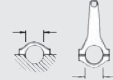
79.50
Petrol

GV	5 Cyl.		2144cc	147kW (200)PS		TD261	269
JY	5 Cyl.		2144cc	134kW (182)PS		TD280	270
KH	5 Cyl.	10:1	2144cc	100kW (136)PS		TD284	274
WK	5 Cyl.	9.3:1	2144cc	100kW (136)PS		TD338	266

QUATTRO 07/80 → 07/87

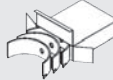
									
BE/PL	1	45.950/45.970	49.000/49.016	19.000	1.506	0.020/0.078	EC	71-3084	71-3084 STD 0.25 0.50
→12/83									
BE/PL	5	47.758/47.778	50.600/50.619	19.000	1.406	0.020/0.074	EC	71-3566	71-3566/5 STD
01/84 → 12/85									
BE/PL	5	47.758/47.778	50.600/50.612	19.000	1.406	0.020/0.067	EC	71-3694	71-3694/5 STD 0.25
01/86 →									

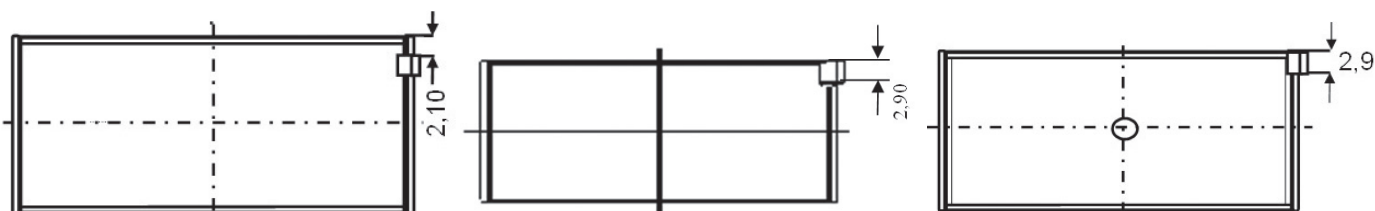
71-3084
71-3566
71-3694

MB/HL 1-6	6	57.958/57.978	63.000/63.019	18.500	2.502	0.020/0.082	EC	72-3400	H981/6 STD 0.25
TW/A	2	63.500/63.750	77.200/77.450		1.975		AL-LF	04-3529	A124/4 STD
TW/A	2	63.500/63.750	77.200/77.450		1.975		AL-LF	04-3530	
TW/A	2	63.500/63.750	76.950/77.200		1.975		AL-LF	04-4782	A292/4 STD
TW/A	2	63.500/63.750	76.950/77.200		1.975		AL-LF	04-4783	
SE/PB	1	20.000	23.000/23.021	25.000			BC	55-3698	55-3698 SEMI

855







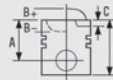

 79.50

Petrol











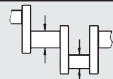

KE	5 Cyl.	2144cc	96kW (131)PS	TD281	271
KF	5 Cyl.	2144cc	96kW (131)PS	TD282	272
KK	5 Cyl.	2144cc	100kW (136)PS	TD286	275
KL	5 Cyl.	2144cc	96kW (131)PS	TD288	277
WU	5 Cyl.	2144cc	79kW (107)PS	TD344	272

80	08/82→07/84	100	08/82→07/84	COUPE	09/82→08/84
----	-------------	-----	-------------	-------	-------------

		
<p>08-404100-00 STD 08/77→08/84</p> <p>1.75  CR P 2.00  P 4.00  CR[52]</p>		
<p>08-404700-10 STD 08-404705-10 0.25mm 08-404707-10 0.50mm 08/77→08/84</p> <p>1.75  CR P 2.00  P 4.00  CR[52]</p>		

[52] Steel

[52] Stahl



									
BE/PL	1	45.950/45.970	49.000/49.016	19.000	1.506	0.020/0.078	EC	71-3084	71-3084 STD 0.25 0.50
→12/83									
BE/PL	5	47.758/47.778	50.600/50.619	19.000	1.406	0.020/0.074	EC	71-3566	71-3566/5 STD
01/84→									



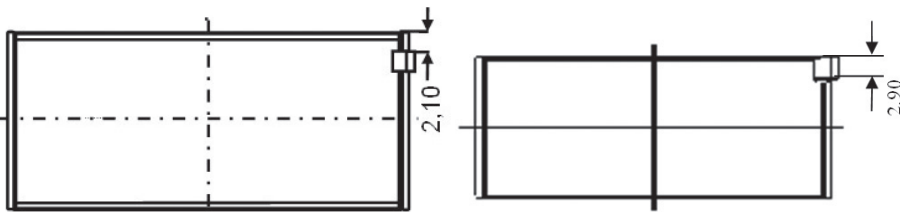



71-3084

71-3566

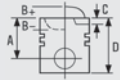







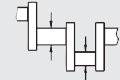
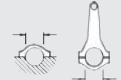

MB/HL 1-6	6	57.958/57.978	63.000/63.019	18.500	2.502	0.020/0.082	EC	72-3400	H981/6 STD 0.25
TW/A	2	63.500/63.750	77.200/77.450		1.975		AL-LF	04-3529	A124/4 STD
TW/A	2	63.500/63.750	77.200/77.450		1.975		AL-LF	04-3530	
TW/A	2	63.500/63.750	76.950/77.200		1.975		AL-LF	04-4782	A292/4 STD
TW/A	2	63.500/63.750	76.950/77.200		1.975		AL-LF	04-4783	
SE/PB	1	20.000	23.000/23.021	25.000			BC	55-3698	55-3698 SEMI

856	 79.50	Petrol				
KG	5 Cyl.	2144cc	134kW (182)PS	TD283	273	
WR	5 Cyl.	7.1:1	2144cc	147kW (200)PS	TD341	283
WX	5 Cyl.	2144cc	119kW (162)PS	TD347	270	
200	08/83→01/88	QUATTRO	07/80→07/89			

		
	08-405000-00 STD	
	1.75  MO P 2.00  P 4.00  CR[52]	

[52] Steel [52] Stahl

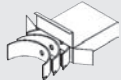
										
BE/PL	1	45.950/45.970	49.000/49.016	19.000	1.506	0.020/0.078	EC	71-3084	71-3084 STD 0.25 0.50	
→12/83										
BE/PL	5	47.758/47.778	50.600/50.619	19.000	1.406	0.020/0.074	EC	71-3566	71-3566/5 STD	
01/84→12/85										
BE/PL	5	47.758/47.778	50.600/50.612	19.000	1.406	0.020/0.067	EC	71-3694	71-3694/5 STD 0.25	
01/86→										

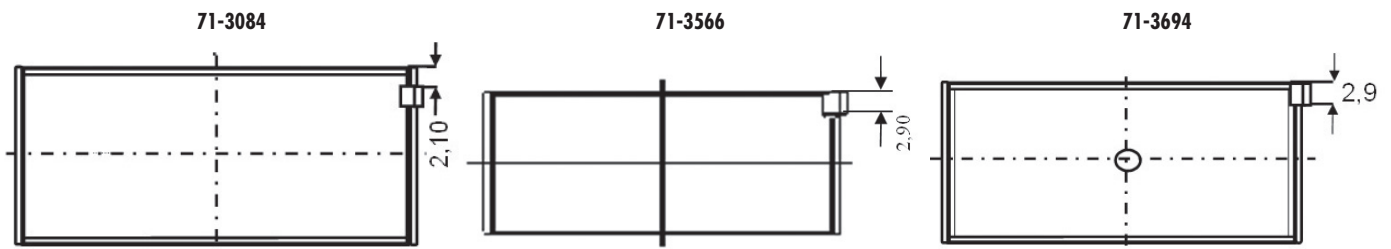

MB/HL 1-6	6	57.958/57.978	63.000/63.019	18.500	2.502	0.020/0.082	EC	72-3400	H981/6 STD 0.25
TW/A	2	63.500/63.750	77.200/77.450		1.975		AL-LF	04-3529	A124/4 STD
TW/A	2	63.500/63.750	77.200/77.450		1.975		AL-LF	04-3530	
TW/A	2	63.500/63.750	76.950/77.200		1.975		AL-LF	04-4782	A292/4 STD
TW/A	2	63.500/63.750	76.950/77.200		1.975		AL-LF	04-4783	
SE/PB	1	20.000	23.000/23.021	25.000			BC	55-3698	55-3698 SEMI

857	79.50	Petrol	
KJ	5 Cyl.	2144cc	125kW (170)PS
			TD285 276

	08-405000-00 STD 1.75 MO P 2.00 P 4.00 CR[52]	

[52] Steel [52] Stahl

BE/PL	1	45.950/45.970	49.000/49.016	19.000	1.506	0.020/0.078	EC	71-3084	71-3084 STD 0.25 0.50
MB/HL 1,2, 4-6	5	57.958/57.978	63.000/63.019	18.500	2.502	0.020/0.082	EC	72-3400	H941/6 STD 0.25
MB/HL 3	1	57.958/57.978	63.000/63.019	24.930	2.502	0.020/0.082	EC	72-3401H	
		72-3401H	STD						
			0.25MM						
			0.50MM						
			0.75MM						

858	79.50	Petrol	
WB	5 Cyl.	8.2:1	2144cc
			85kW (115)PS
			TD330 278
100	07/77→02/83		

	08-404100-00 STD 08/77→08/84 1.75 CR P 2.00 P 4.00 CR[52]	
	08-404700-10 STD 08-404705-10 0.25mm 08-404707-10 0.50mm 08/77→08/84 1.75 CR P 2.00 P 4.00 CR[52]	

[52] Steel [52] Stahl

...Continued

858		79.50		Petrol					
BE/PL	1	45.950/45.970	49.000/49.016	19.000	1.506	0.020/0.078	EC	71-3084	71-3084 STD 0.25 0.50
MB/HL 1,2, 4-6	5	57.958/57.978	63.000/63.019	18.500	2.502	0.020/0.082	EC	72-3400	H941/6 STD 0.25
MB/HL 3	1	57.958/57.978	63.000/63.019	24.930	2.502	0.020/0.082	EC	72-3401H	
		72-3401H	STD						
			0.25MM						
			0.50MM						
			0.75MM						
MB/HL 1-6	6	57.958/57.978	63.000/63.019	18.500	2.502	0.020/0.082	EC	72-3400	H981/6 STD 0.25
		01/79 →							
TW/A	2	63.500/63.750	77.200/77.450		1.975		AL-LF	04-3529	A124/4 STD
TW/A	2	63.500/63.750	77.200/77.450		1.975		AL-LF	04-3530	
TW/A	2	63.500/63.750	76.950/77.200		1.975		AL-LF	04-4782	A292/4 STD
TW/A	2	63.500/63.750	76.950/77.200		1.975		AL-LF	04-4783	

859		79.50		Petrol					
WC	5 Cyl.	9.3:1	2144cc	100kW (136)PS		TD331		279	
100	03/77 → 07/84		200	10/79 → 07/84					

	<p>08-404100-00 STD 08/77 → 08/84</p> <p>1.75 CR P 2.00 P 4.00 CR[52]</p>	
	<p>08-404700-10 STD 08-404705-10 0.25mm 08-404707-10 0.50mm 08/77 → 08/84</p> <p>1.75 CR P 2.00 P 4.00 CR[52]</p>	

[52] Steel

[52] Stahl

859



79.50

Petrol

BE/PL	1	45.950/45.970	49.000/49.016	19.000	1.506	0.020/0.078	EC	71-3084	71-3084 STD 0.25 0.50	
→12/83										
BE/PL	5	47.758/47.778	50.600/50.619	19.000	1.406	0.020/0.074	EC	71-3566	71-3566/5 STD	
01/84→										

71-3084

71-3566

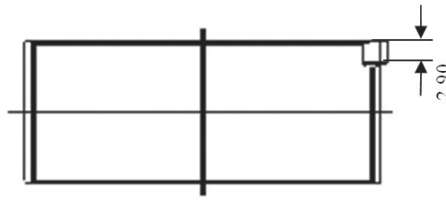
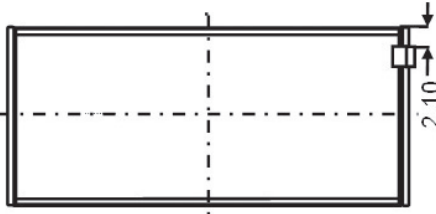

MB/HL 1,2, 4-6	5	57.958/57.978	63.000/63.019	18.500	2.502	0.020/0.082	EC	72-3400	H941/6 STD 0.25	
MB/HL 3	1	57.958/57.978	63.000/63.019	24.930	2.502	0.020/0.082	EC	72-3401H		
		72-3401H	STD							
			0.25MM							
			0.50MM							
			0.75MM							
MB/HL 1-6	6	57.958/57.978	63.000/63.019	18.500	2.502	0.020/0.082	EC	72-3400	H981/6 STD 0.25	
01/79→										
TW/A	2	63.500/63.750	77.200/77.450		1.975		AL-LF	04-3529	A124/4 STD	
TW/A	2	63.500/63.750	77.200/77.450		1.975		AL-LF	04-3530		
TW/A	2	63.500/63.750	76.950/77.200		1.975		AL-LF	04-4782	A292/4 STD	
TW/A	2	63.500/63.750	76.950/77.200		1.975		AL-LF	04-4783		
SE/PB	1	20.000	23.000/23.021	25.000			BC	55-3698	55-3698 SEMI	

860

79.50

Petrol



WD 5 Cyl. 8.2:1 2144cc 79kW (107)PS TD332

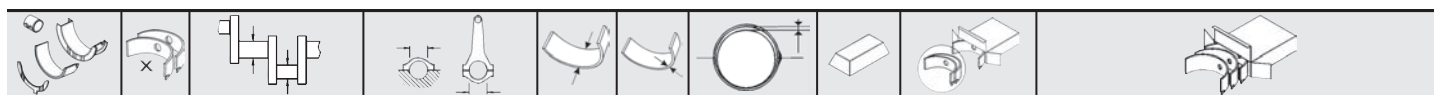



BE/PL	1	45.950/45.970	49.000/49.016	19.000	1.506	0.020/0.078	EC	71-3084	71-3084 STD 0.25 0.50
→12/83									
BE/PL	5	47.758/47.778	50.600/50.619	19.000	1.406	0.020/0.074	EC	71-3566	71-3566/5 STD
01/84→									



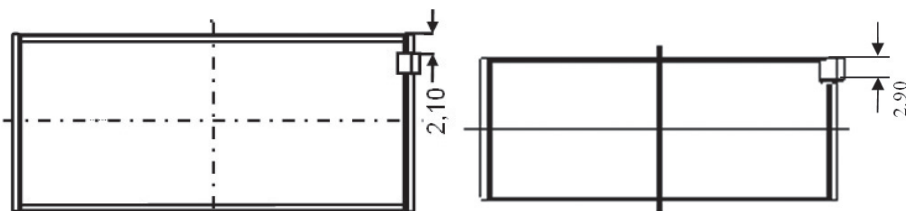



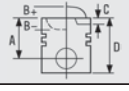

71-3084

71-3566









MB/HL 1,2, 4-6	5	57.958/57.978	63.000/63.019	18.500	2.502	0.020/0.082	EC	72-3400	H941/6 STD 0.25
MB/HL 3	1	57.958/57.978	63.000/63.019	24.930	2.502	0.020/0.082	EC	72-3401H	
72-3401H STD 0.25MM 0.50MM 0.75MM									
MB/HL 1-6	6	57.958/57.978	63.000/63.019	18.500	2.502	0.020/0.082	EC	72-3400	H981/6 STD 0.25
01/79→									
TW/A	2	63.500/63.750	77.200/77.450		1.975		AL-LF	04-3529	A124/4 STD
TW/A	2	63.500/63.750	77.200/77.450		1.975		AL-LF	04-3530	
TW/A	2	63.500/63.750	76.950/77.200		1.975		AL-LF	04-4782	A292/4 STD
TW/A	2	63.500/63.750	76.950/77.200		1.975		AL-LF	04-4783	
SE/PB	1	20.000	23.000/23.021	25.000			BC	55-3698	55-3698 SEMI

861	 79.50	Petrol	
WE	5 Cyl.	2144cc	85kW (115)PS
WE	5 Cyl.	2144cc	85kW (115)PS
80	10/80→07/83	100	07/77→02/83
PASSAT	01/81→07/83	SANTANA	08/82→12/83
			COUPE 01/81→07/83
			TD333 280
			TD16427 280

		
	<p>08-404100-00 STD 08/77→08/84</p> <p>1.75  CR P 2.00  P 4.00  CR[52]</p> <p>08-404700-10 STD 08-404705-10 0.25mm 08-404707-10 0.50mm 08/77→08/84</p> <p>1.75  CR P 2.00  P 4.00  CR[52]</p>	

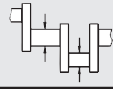
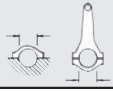
[52] Steel

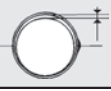
[52] Stahl

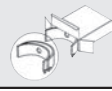
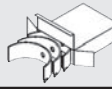
									
BE/PL	1	45.950/45.970	49.000/49.016	19.000	1.506	0.020/0.078	EC	71-3084	71-3084 STD 0.25 0.50
MB/HL 1,2, 4-6	5	57.958/57.978	63.000/63.019	18.500	2.502	0.020/0.082	EC	72-3400	H941/6 STD 0.25
MB/HL 3	1	57.958/57.978	63.000/63.019	24.930	2.502	0.020/0.082	EC	72-3401H	
		72-3401H	STD						
			0.25MM						
			0.50MM						
			0.75MM						

862

79.50

Petrol



WG	5 Cyl.	2144cc	100kW (136)PS	TD335	281
100	03/77→02/83				

<p>08-404100-00 STD 08/77→08/84</p> <p>1.75 CR P 2.00 P 4.00 CR[52]</p>		
<p>08-404700-10 STD 08-404705-10 0.25mm 08-404707-10 0.50mm 08/77→08/84</p> <p>1.75 CR P 2.00 P 4.00 CR[52]</p>		

[52] Steel

[52] Stahl

BE/PL	1	45.950/45.970	49.000/49.016	19.000	1.506	0.020/0.078	EC	71-3084	71-3084 STD 0.25 0.50
MB/HL 1,2, 4-6	5	57.958/57.978	63.000/63.019	18.500	2.502	0.020/0.082	EC	72-3400	H941/6 STD 0.25
MB/HL 3	1	57.958/57.978	63.000/63.019	24.930	2.502	0.020/0.082	EC	72-3401H	
		72-3401H	STD						
			0.25MM						
			0.50MM						
			0.75MM						
MB/HL 1-6	6	57.958/57.978	63.000/63.019	18.500	2.502	0.020/0.082	EC	72-3400	H981/6 STD 0.25
TW/A	2	63.500/63.750	77.200/77.450		1.975		AL-LF	04-3529	A124/4 STD
TW/A	2	63.500/63.750	77.200/77.450		1.975		AL-LF	04-3530	
TW/A	2	63.500/63.750	76.950/77.200		1.975		AL-LF	04-4782	A292/4 STD
TW/A	2	63.500/63.750	76.950/77.200		1.975		AL-LF	04-4783	
SE/PB	1	20.000	23.000/23.021	25.000			BC	55-3698	55-3698 SEMI

863

79.50

Petrol



WJ 5 Cyl. 7.1:1 2144cc 125kW (170)PS TD337 282

200 10/79→08/82

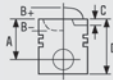

08-405000-00 STD

1.75 MO P
2.00 P
4.00 CR[52]

[52] Steel

[52] Stahl

BE/PL	1	45.950/45.970	49.000/49.016	19.000	1.506	0.020/0.078	EC	71-3084	71-3084 STD 0.25 0.50	
MB/HL 1-6	6	57.958/57.978	63.000/63.019	18.500	2.502	0.020/0.082	EC	72-3400	H981/6 STD 0.25	
TW/A	2	63.500/63.750	77.200/77.450		1.975		AL-LF	04-3529	A124/4 STD	
TW/A	2	63.500/63.750	77.200/77.450		1.975		AL-LF	04-3530		
TW/A	2	63.500/63.750	76.950/77.200		1.975		AL-LF	04-4782	A292/4 STD	
TW/A	2	63.500/63.750	76.950/77.200		1.975		AL-LF	04-4783		
SE/PB	1	20.000	23.000/23.021	25.000			BC	55-3698	55-3698 SEMI	

864



79.50







Petrol

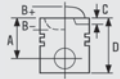
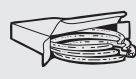

WS 5 Cyl. 2144cc 125kW (170)PS TD342 284

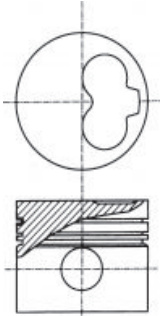



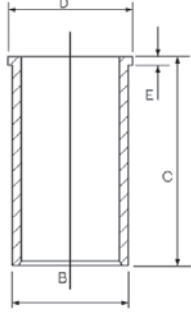





BE/PL	1	45.950/45.970	49.000/49.016	19.000	1.506	0.020/0.078	EC	71-3084	71-3084 STD 0.25 0.50	
MB/HL 1-6	6	57.958/57.978	63.000/63.019	18.500	2.502	0.020/0.082	EC	72-3400	H981/6 STD 0.25	
TW/A	2	63.500/63.750	77.200/77.450		1.975		AL-LF	04-3529	A124/4 STD	
TW/A	2	63.500/63.750	77.200/77.450		1.975		AL-LF	04-3530		
TW/A	2	63.500/63.750	76.950/77.200		1.975		AL-LF	04-4782	A292/4 STD	
TW/A	2	63.500/63.750	76.950/77.200		1.975		AL-LF	04-4783		
SE/PB	1	20.000	23.000/23.021	25.000			BC	55-3698	55-3698 SEMI	

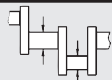

865	 79.50	Diesel				
3D	5 Cyl.	2370cc	60kW (81)PS	TD218	285	
AAB	5 Cyl.	22.5:1	2370cc	57kW (77)PS	TD4000	286
AAS	5 Cyl.	2370cc	60kW (81)PS	TD227	287	
AJA	5 Cyl.	2370cc	55kW (75)PS	TD11049	288	
100	08/89→06/94	TRANSPORTER	07/90→04/03			







		
87-990100-00 STD 87-990105-40 0.25mm 87-990107-40 [27] 0.50mm 87-990111-40 [27] 1.00mm A 39.65 B- 1.90 D 65.70  24x64 AK RT  07945	08-990100-00 STD 08-990105-00 0.25mm 08-990107-00 0.50mm 08-990111-00 1.00mm 1.75  CR P 2.00  P 3.00  CR P	14-027950-00 D B 82.50 C 152.00 D 85.50 E 4.70 

[27] A = 39.400

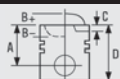
[27] A = 39.400

									
BE/PL	5	47.758/47.778	50.600/50.619	19.000	1.406	0.020/0.074	EC	71-3442	71-3442/5 STD 0.25 0.50
MB/HL 1-6	6	57.958/57.978	63.000/63.019	18.500	2.502	0.020/0.082	EC	72-3400	H981/6 STD 0.25
TW/A	2	63.500/63.750	77.200/77.450		1.975		AL-LF	04-3529	A124/4 STD
TW/A	2	63.500/63.750	77.200/77.450		1.975		AL-LF	04-3530	
TW/A	2	63.500/63.750	76.950/77.200		1.975		AL-LF	04-4782	A292/4 STD
TW/A	2	63.500/63.750	76.950/77.200		1.975		AL-LF	04-4783	
SE/PB	1	24.000	27.000/27.021	25.000			BC	55-3696	55-3696 SEMI

866	 81.00	Petrol			
AKS	4 Cyl.	1588cc	74kW (100)PS	TD9991	292
GOLF	07/94→06/02				

		
87-105900-00 STD 87-105907-00 [24] 0.50mm A 32.00 B- 2.30 B+ 0.70 BØ 61.40 D 53.70  20x57	08-105900-00 STD 08-105907-00 0.50mm 1.20  NT[52] 1.50  P 2.00  CR[52]	







[24] A = 31.700, D = 53.400

[24] A = 31.700, D = 53.400

[52] Steel

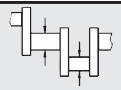
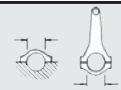
[52] Stahl

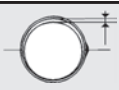
866  **81.00** **Petrol**

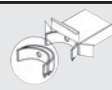
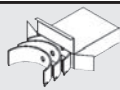
									
BE/PL	4	47.758/47.778	50.600/50.612	19.000	1.406	0.020/0.067	EC	71-3694	71-3694/4 STD 0.25 0.50
BE/PL	4	47.758/47.778	50.600/50.612	19.000	1.406	0.020/0.067	EC	71-3929	71-3929/4 STD

[66]

71-3694

71-3929

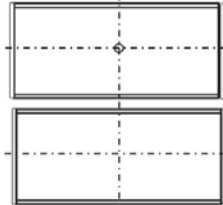
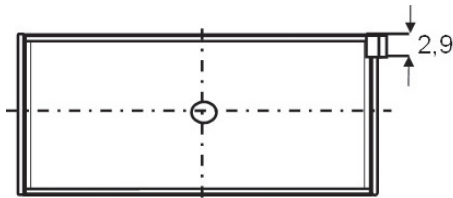

MB/HL	4	53.958/53.978	59.000/59.019	18.500	2.502	0.020/0.082	AL-LF	02-3085L	H027/5 STD 0.25 0.50
MB/HL	6	53.958/53.978	59.000/59.019	18.500	2.502	0.020/0.082	AL-LF	02-3085U	
MB/HL 1-5	5	53.958/53.978	59.000/59.019	18.500	2.502	0.020/0.082	AL-LF	02-3085L	H084/5 STD 0.25 0.50
MB/HL 1-5	5	53.958/53.978	59.000/59.019	18.500	2.502	0.020/0.082	AL-LF	02-3085U	

02-3085L

02-3085U

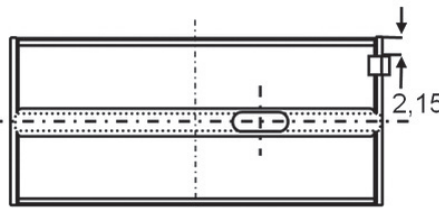
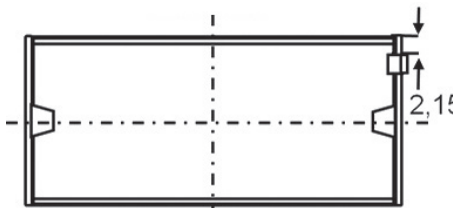

TW/A	2	59.500	73.200		1.975		AL-LF	04-3527	A123/4 STD
TW/A	2	59.500	73.200		1.975		AL-LF	04-3528	
SE/PB	1	20.000	23.000/23.021	25.000			BC	55-3698	55-3698 SEMI

867

81.00

Petrol



1F	4 Cyl.	9.5:1	1595cc	53/55kW (72/75)PS	TD4890	293
1F	4 Cyl.	9.5:1	1595cc	53/55kW (72/75)PS	TD4957	293
ABM	4 Cyl.		1595cc	52kW (71)PS	TD234	295
ABN	4 Cyl.	9:1	1595cc	55kW (75)PS	TD4974	296
ABN	4 Cyl.	9:1	1595cc	55kW (75)PS	TD17897	296
ADA	4 Cyl.		1595cc	74kW (100)PS	TD240	297

80	09/91→01/96	CADDY	11/95→05/97	CORDOBA	05/94→06/99
GOLF	08/83→07/92	IBIZA	09/94→06/99	INCA	11/95→05/98
JETTA	01/84→07/92	PASSAT	02/88→09/91	POLO	11/95→09/97
SAVEIRO	08/90→02/02	TOLEDO	05/91→03/99		

87-109700-20 STD 87-109707-20 [26] 0.50mm	08-109700-00 STD 08-109705-00 0.25mm 08-109707-00 0.50mm	
A 35.60 B- 2.30 B+ 2.20 D 66.80 20x57	1.50 CR P 1.75 P 3.00 CR P	

[26] A = 35.300, D = 66.500

[26] A = 35.300, D = 66.500

BE/PL	4	47.758/47.778	50.600/50.612	19.000	1.406	0.020/0.067	EC	71-3694	71-3694/4 STD 0.25 0.50
MB/HL	4	53.958/53.978	59.000/59.019	18.500	2.502	0.020/0.082	AL-LF	02-3085L	H027/5 STD 0.25 0.50
MB/HL	6	53.958/53.978	59.000/59.019	18.500	2.502	0.020/0.082	AL-LF	02-3085U	
TW/A	2	59.500	73.200		1.975		AL-LF	04-3527	A123/4 STD
TW/A	2	59.500	73.200		1.975		AL-LF	04-3528	
SE/PB	1	20.000	23.000/23.021	25.000			BC	55-3698	55-3698 SEMI
BU	1	42.959/42.975	46.055/46.095	15.000			AL-LF	07-3088	07-3088 STD SEMI [68]
BU	1	41.959/41.975	45.000/45.025	15.000			AL-LF	07-3089	07-3089 STD SEMI [68]

868







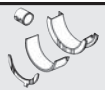

 81.00

Petrol

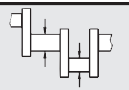
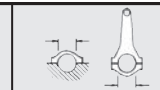

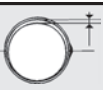
ABB 4 Cyl. 10:1 1595cc 75kW (102)PS TD230 294

80 08/90→10/91

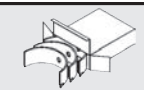
										
BE/PL	4	47.758/47.778	50.600/50.612	19.000	1.406	0.020/0.067	EC	71-3694	71-3694/4 STD 0.25 0.50	
MB/HL	4	53.958/53.978	59.000/59.019	18.500	2.502	0.020/0.082	AL-LF	02-3085L	H027/5 STD 0.25 0.50	
MB/HL	6	53.958/53.978	59.000/59.019	18.500	2.502	0.020/0.082	AL-LF	02-3085U		
TW/A	2	59.500	73.200		1.975		AL-LF	04-3527	A123/4 STD	
TW/A	2	59.500	73.200		1.975		AL-LF	04-3528		
SE/PB	1	20.000	23.000/23.021	25.000			BC	55-3698	55-3698 SEMI	
BU	1	42.959/42.975	46.055/46.095	15.000			AL-LF	07-3088	07-3088 STD SEMI [68]	
BU	1	41.959/41.975	45.000/45.025	15.000			AL-LF	07-3089	07-3089 STD SEMI [68]	

869

 81.00











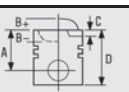

Petrol







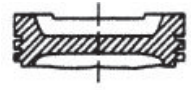
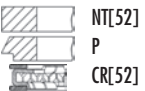



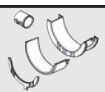

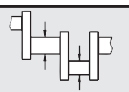
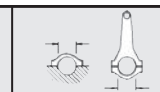
ADP 4 Cyl. 10.3:1 1595cc 74kW (100)PS TD4198 299

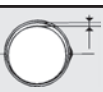
ADP 4 Cyl. 10.3:1 1595cc 74kW (100)PS TD16253 299

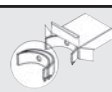

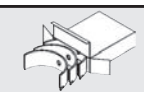





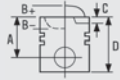

A4 11/94→09/01 PASSAT 10/96→11/00

										
87-105900-00 87-105907-00 [24]	STD 0.50mm		08-105900-00 08-105907-00	STD 0.50mm		NT[52] P CR[52]				
A 32.00 B- 2.30 B+ 0.70 BØ 61.40 D 53.70  20x57										
[24] A = 31.700, D = 53.400 [52] Steel		[24] A = 31.700, D = 53.400 [52] Stahl								









										
BE/PL	4	47.758/47.778	50.600/50.612	19.000	1.406	0.020/0.067	EC	71-3694	71-3694/4 STD 0.25 0.50	
MB/HL	4	53.958/53.978	59.000/59.019	18.500	2.502	0.020/0.082	AL-LF	02-3085L	H027/5 STD 0.25 0.50	
MB/HL	6	53.958/53.978	59.000/59.019	18.500	2.502	0.020/0.082	AL-LF	02-3085U		
TW/A	2	59.500	73.200		1.975		AL-LF	04-3527	A123/4 STD	
TW/A	2	59.500	73.200		1.975		AL-LF	04-3528		

870		 81.00	Petrol			
AEH	4 Cyl.	10.2:1	1595cc	74kW (100)PS	TD5074	300
AEH	4 Cyl.	10.2:1	1595cc	74kW (100)PS	TD9450	300
AEH	4 Cyl.	10.2:1	1595cc	74kW (100)PS	TD12488	300
AEH	4 Cyl.	10.2:1	1595cc	74kW (100)PS	TD12950	300
AKL	4 Cyl.	10.3:1	1595cc	74kW (100)PS	TD9451	304
AKL	4 Cyl.	10.3:1	1595cc	74kW (100)PS	TD9990	304
AKL	4 Cyl.	10.3:1	1595cc	74kW (100)PS	TD12509	304
AKL	4 Cyl.	10.3:1	1595cc	74kW (100)PS	TD12951	304
APF	4 Cyl.	10.3:1	1595cc	74kW (100)PS	TD11588	308
APF	4 Cyl.	10.3:1	1595cc	74kW (100)PS	TD12848	308
APF	4 Cyl.	10.3:1	1595cc	74kW (100)PS	TD13269	308

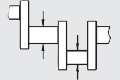
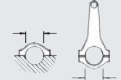
A3	09/96→05/03	BORA	10/98→05/05	CORDOBA	07/96→12/02
GOLF	08/97→02/00	IBIZA	08/99→02/02	LEON	11/99→06/06
OCTAVIA	02/97→12/07	POLO	12/95→09/01	TOLEDO	04/99→09/00

					
87-105900-00	STD	87-105907-00 [24]	0.50mm	08-105900-00	STD
				08-105907-00	0.50mm
A	32.00			1.20	 NT[52]
B-	2.30			1.50	 P
B+	0.70			2.00	 CR[52]
BØ	61.40				
D	53.70				
	20x57				

[24] A = 31.700, D = 53.400 [24] A = 31.700, D = 53.400
 [52] Steel [52] Stahl

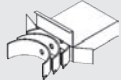
									
BE/PL	4	47.758/47.778	50.600/50.612	19.000	1.406	0.020/0.067	EC	71-3694	71-3694/4 STD 0.25 0.50
BE/PL	4	47.758/47.778	50.600/50.612	19.000	1.406	0.020/0.067	EC	71-3929	71-3929/4 STD

71-3694

71-3929

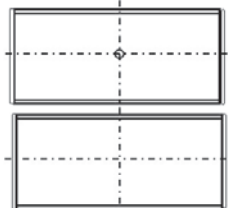
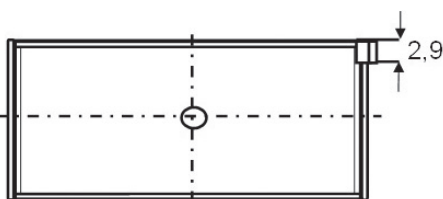

MB/HL 1-5	5	53.958/53.978	59.000/59.019	18.500	2.502	0.020/0.082	AL-LF	02-3085L	H084/5 STD 0.25 0.50
MB/HL 1-5	5	53.958/53.978	59.000/59.019	18.500	2.502	0.020/0.082	AL-LF	02-3085U	
TW/A	2	59.500	73.200		1.975		AL-LF	04-3527	A123/4 STD
TW/A	2	59.500	73.200		1.975		AL-LF	04-3528	
SE/PB	1	20.000	23.000/23.021	25.000			BC	55-3698	55-3698 SEMI

871	81.00	Petrol	
AEK	4 Cyl.	10.2:1	1595cc
			74kW (100)PS
			TD4982 301
GOLF	07/94→04/99	PASSAT	07/94→08/96
		VENTO	10/94→09/98

87-105900-00 STD 87-105907-00 [24] 0.50mm	 A 32.00 B- 2.30 B+ 0.70 BØ 61.40 D 53.70 20x57	08-105900-00 STD 08-105907-00 0.50mm 1.20 NT[52] 1.50 P 2.00 CR[52]
[24] A = 31.700, D = 53.400	[24] A = 31.700, D = 53.400	
[52] Steel	[52] Stahl	

BE/PL	4	47.758/47.778	50.600/50.612	19.000	1.406	0.020/0.067	EC	71-3694	71-3694/4 STD 0.25 0.50
MB/HL	4	53.958/53.978	59.000/59.019	18.500	2.502	0.020/0.082	AL-LF	02-3085L	H027/5 STD 0.25 0.50
MB/HL	6	53.958/53.978	59.000/59.019	18.500	2.502	0.020/0.082	AL-LF	02-3085U	
TW/A	2	59.500	73.200		1.975		AL-LF	04-3527	A123/4 STD
TW/A	2	59.500	73.200		1.975		AL-LF	04-3528	
SE/PB	1	20.000	23.000/23.021	25.000			BC	55-3698	55-3698 SEMI









872	81.00	Petrol	
AFT	4 Cyl.	10.3:1	1595cc
			74kW (100)PS
			TD4988 292
AFT	4 Cyl.	10.3:1	1595cc
			74kW (100)PS
			TD5536 292

CORDOBA	07/96→10/99	GOLF	07/94→06/02	IBIZA	04/96→08/99
PASSAT	07/94→08/96	POLO	12/95→09/01	TOLEDO	11/96→03/99
VENTO	10/94→09/98				

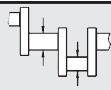
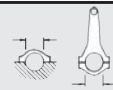
87-105900-00 STD 87-105907-00 [24] 0.50mm	 A 32.00 B- 2.30 B+ 0.70 BØ 61.40 D 53.70 20x57	08-105900-00 STD 08-105907-00 0.50mm 1.20 NT[52] 1.50 P 2.00 CR[52]
[24] A = 31.700, D = 53.400	[24] A = 31.700, D = 53.400	
[52] Steel	[52] Stahl	

...Continued

872  **81.00** **Petrol**

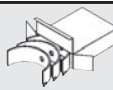
										
BE/PL	4	47.758/47.778	50.600/50.612	19.000	1.406	0.020/0.067	EC	71-3694	71-3694/4 STD 0.25 0.50	
BE/PL	4	47.758/47.778	50.600/50.612	19.000	1.406	0.020/0.067	EC	71-3929	71-3929/4 STD	[66]

71-3694

71-3929

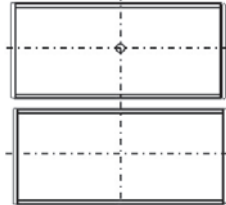
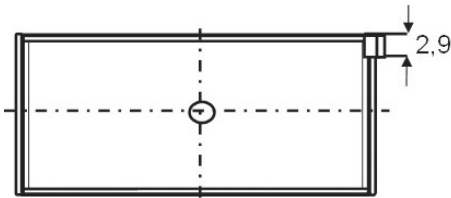

MB/HL	4	53.958/53.978	59.000/59.019	18.500	2.502	0.020/0.082	AL-LF	02-3085L	H027/5 STD 0.25 0.50
MB/HL	6	53.958/53.978	59.000/59.019	18.500	2.502	0.020/0.082	AL-LF	02-3085U	

Mot. → 1EY010001

MB/HL 1-5	5	53.958/53.978	59.000/59.019	18.500	2.502	0.020/0.082	AL-LF	02-3085L	H084/5 STD 0.25 0.50
MB/HL 1-5	5	53.958/53.978	59.000/59.019	18.500	2.502	0.020/0.082	AL-LF	02-3085U	

Mot. 1EY010001 →

02-3085L

02-3085U

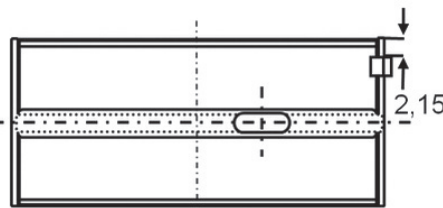
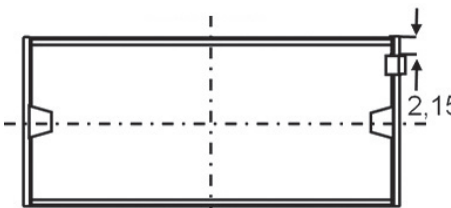

TW/A	2	59.500	73.200		1.975		AL-LF	04-3527	A123/4 STD	
TW/A	2	59.500	73.200		1.975		AL-LF	04-3528		
SE/PB	1	20.000	23.000/23.021	25.000			BC	55-3698	55-3698 SEMI	
BU	1	42.959/42.975	46.055/46.095	15.000			AL-LF	07-3088	07-3088 STD SEMI	[68]
BU	1	41.959/41.975	45.000/45.025	15.000			AL-LF	07-3089	07-3089 STD SEMI	[68]

873

81.00

Petrol



AHL	4 Cyl.	1595cc	74kW (100)PS	TD5556	303
AHL	4 Cyl.	1595cc	74kW (100)PS	TD10816	303
A4	11/94→09/01	PASSAT	10/96→11/00		

87-105900-00 87-105907-00 [24]	STD 0.50mm		08-105900-00 08-105907-00	STD 0.50mm	
A 32.00 B- 2.30 B+ 0.70 BØ 61.40 D 53.70 20x57			1.20 NT[52] 1.50 P 2.00 CR[52]		
[24] A = 31.700, D = 53.400		[24] A = 31.700, D = 53.400			
[52] Steel		[52] Stahl			



BE/PL	4	47.758/47.778	50.600/50.612	19.000	1.406	0.020/0.067	EC	71-3694	71-3694/4 STD 0.25 0.50
BE/PL	4	47.758/47.778	50.600/50.612	19.000	1.406	0.020/0.067	EC	71-3929	71-3929/4 STD [66]

71-3694

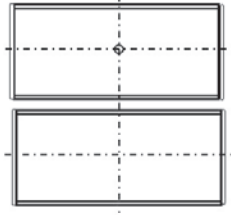
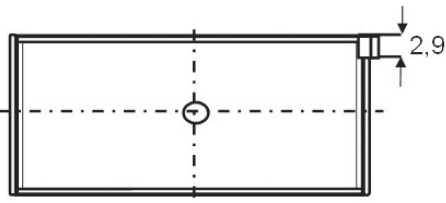
71-3929





SE/PB	1	20.000	23.000/23.021	25.000			BC	55-3698	55-3698 SEMI
-------	---	--------	---------------	--------	--	--	----	---------	-----------------

874		 81.00	Petrol			
ALZ	4 Cyl.	10.3:1	1595cc	75kW (102)PS	TD15148	305
ALZ	4 Cyl.	10.3:1	1595cc	75kW (102)PS	TD15748	305
ALZ	4 Cyl.	10.3:1	1595cc	75kW (102)PS	TD22242	305
BFQ	4 Cyl.	10.2:1	1595cc	75kW (102)PS	TD17166	312
BFQ	4 Cyl.	10.2:1	1595cc	75kW (102)PS	TD17912	312
BFQ	4 Cyl.	10.2:1	1595cc	75kW (102)PS	TD18137	312
BFQ	4 Cyl.	10.2:1	1595cc	75kW (102)PS	TD20621	312
BGU	4 Cyl.	10.3:1	1595cc	75kW (102)PS	TD16871	313
BGU	4 Cyl.	10.3:1	1595cc	75kW (102)PS	TD17067	313
BGU	4 Cyl.	10.3:1	1595cc	75kW (102)PS	TD17352	313
BGU	4 Cyl.	10.3:1	1595cc	75kW (102)PS	TD17496	313
BSE	4 Cyl.		1595cc	75kW (102)PS	TD18222	312
BSE	4 Cyl.		1595cc	75kW (102)PS	TD18245	312
BSE	4 Cyl.		1595cc	75kW (102)PS	TD20711	312
BSE	4 Cyl.		1595cc	75kW (102)PS	TD20898	312
BSF	4 Cyl.		1595cc	75kW (102)PS	TD18223	312
BSF	4 Cyl.		1595cc	75kW (102)PS	TD18246	312
BSF	4 Cyl.		1595cc	75kW (102)PS	TD20712	312
BSF	4 Cyl.		1595cc	75kW (102)PS	TD20899	312
CCSA	4 Cyl.	10.5:1	1595cc	75kW (102)PS	TD20710	312
CCSA	4 Cyl.	10.5:1	1595cc	75kW (102)PS	TD20780	312
CCSA	4 Cyl.	10.5:1	1595cc	75kW (102)PS	TD20900	312
CCSA	4 Cyl.	10.5:1	1595cc	75kW (102)PS	TD22665	312

A3	08/00 →	A4	07/00 →06/08	ALTEA	03/04 →
ALTEA XL	10/06 →	BORA	08/00 →05/05	CADDY	04/04 →
EXEO	03/09 →09/10	GOLF	08/00 →	JETTA	10/05 →10/10
LEON	07/05 →	OCTAVIA	09/00 →	PASSAT	11/00 →11/10
TOLEDO	10/04 →05/09	TOURAN	07/03 →05/10		



08-148300-00 STD

- 1.00  NT[52]
- 1.20  P
- 2.00  CR P

[52] Steel

[52] Stahl

875	81.00	Petrol				
ANA	4 Cyl.	1595cc	74kW (100)PS	TD14128	306	
ANA	4 Cyl.	1595cc	74kW (100)PS	TD16254	306	
AVU	4 Cyl.	10.3:1	1595cc	75kW (102)PS	TD15350	310
AVU	4 Cyl.	10.3:1	1595cc	75kW (102)PS	TD15475	310
AVU	4 Cyl.	10.3:1	1595cc	75kW (102)PS	TD16068	310
A3	08/00→05/03	A4	11/94→09/01	BORA	08/00→05/05	
GOLF	08/00→06/06	OCTAVIA	09/00→12/10	PASSAT	10/96→11/00	

	08-148300-00 STD 1.00 NT[52] 1.20 P 2.00 CR P	

[52] Steel [52] Stahl



BE/PL	4	41.965/41.980	45.000/45.016	19.000	1.505	0.020/0.070	AL-LF	01-3961	01-3961/4 STD









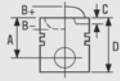
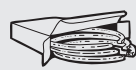

876	81.00	Petrol				
ARM	4 Cyl.	10.3:1	1595cc	74kW (100)PS	TD14148	306
ARM	4 Cyl.	10.3:1	1595cc	74kW (100)PS	TD16255	306
A4	11/94→09/01	PASSAT	10/96→11/00			

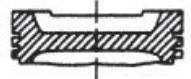







87-105900-00 STD 87-105907-00 [24] 0.50mm A 32.00 B- 2.30 B+ 0.70 BØ 61.40 D 53.70 20x57	08-105900-00 STD 08-105907-00 0.50mm 1.20 NT[52] 1.50 P 2.00 CR[52]	

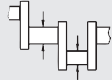
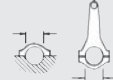

[24] A = 31.700, D = 53.400 [24] A = 31.700, D = 53.400
 [52] Steel [52] Stahl









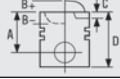

BE/PL	4	47.758/47.778	50.600/50.612	19.000	1.406	0.020/0.067	EC	71-3694	71-3694/4 STD 0.25 0.50
SE/PB	1	20.000	23.000/23.021	25.000			BC	55-3698	55-3698 SEMI







877	 81.00	Petrol				
AUR	4 Cyl.	10.3:1	1595cc	74kW (100)PS	TD15611	309
AUR	4 Cyl.	10.3:1	1595cc	74kW (100)PS	TD16200	309
CORDOBA	06/99→12/02	IBIZA	08/99→02/02	POLO	12/95→09/01	

		
87-105900-00 STD 87-105907-00 [24] 0.50mm   A 32.00 B- 2.30 B+ 0.70 BØ 61.40 D 53.70  20x57 <small>[24] A = 31.700, D = 53.400</small> <small>[52] Steel</small>	08-105900-00 STD 08-105907-00 0.50mm   1.20  NT[52] 1.50  P 2.00  CR[52]	



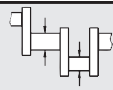
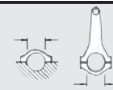

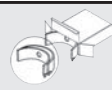
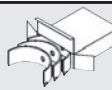

									
BE/PL	4	47.758/47.778	50.600/50.612	19.000	1.406	0.020/0.067	EC	71-3694	71-3694/4 STD 0.25 0.50
MB/HL 1-5	5	53.958/53.978	59.000/59.019	18.500	2.502	0.020/0.082	AL-LF	02-3085L	H084/5 STD 0.25 0.50
MB/HL 1-5	5	53.958/53.978	59.000/59.019	18.500	2.502	0.020/0.082	AL-LF	02-3085U	
TW/A	2	59.500	73.200		1.975		AL-LF	04-3527	A123/4 STD
TW/A	2	59.500	73.200		1.975		AL-LF	04-3528	
SE/PB	1	20.000	23.000/23.021	25.000			BC	55-3698	55-3698 SEMI
BU	1	42.959/42.975	46.055/46.095	15.000			AL-LF	07-3088	07-3088 STD SEMI [68]
BU	1	41.959/41.975	45.000/45.025	15.000			AL-LF	07-3089	07-3089 STD SEMI [68]

878	 81.00	Petrol				
AWH	4 Cyl.		1595cc	74kW (100)PS	TD15465	308
NEW BEETLE	10/99→09/00					

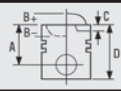
		
87-105900-00 STD 87-105907-00 [24] 0.50mm   A 32.00 B- 2.30 B+ 0.70 BØ 61.40 D 53.70  20x57 <small>[24] A = 31.700, D = 53.400</small> <small>[52] Steel</small>	08-105900-00 STD 08-105907-00 0.50mm   1.20  NT[52] 1.50  P 2.00  CR[52]	

878		 81.00	Petrol							
										
BE/PL	4	47.758/47.778	50.600/50.612	19.000	1.406	0.020/0.067	EC	71-3929	71-3929/4 STD	[66]
MB/HL 1-5	5	53.958/53.978	59.000/59.019	18.500	2.502	0.020/0.082	AL-LF	02-3085L	H084/5 STD 0.25 0.50	
MB/HL 1-5	5	53.958/53.978	59.000/59.019	18.500	2.502	0.020/0.082	AL-LF	02-3085U		
TW/A	2	59.500	73.200		1.975		AL-LF	04-3527	A123/4 STD	
TW/A	2	59.500	73.200		1.975		AL-LF	04-3528		
SE/PB	1	20.000	23.000/23.021	25.000			BC	55-3698	55-3698 SEMI	







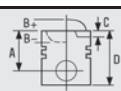

879		 81.00	Petrol							
BFS	4 Cyl.	1595cc	75kW (102)PS							TD16743 312
NEW BEETLE		06/00 →								

		
	08-148300-00 STD 1.00  NT[52] 1.20  P 2.00  CR P	

[52] Steel

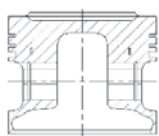
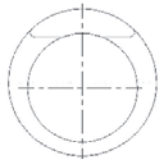
[52] Stahl

880		 81.00	Petrol							
DT	4 Cyl.	1595cc	55kW (75)PS							TD4206 319
DT	4 Cyl.	1595cc	55kW (75)PS							TD4997 319
80	08/78 → 07/86	PASSAT	08/80 → 03/88	SANTANA	08/81 → 12/84					

		
87-109700-20 STD 87-109707-20 [26] 0.50mm A 35.60 B- 2.30 B+ 2.20 D 66.80  20x57	  08-109700-00 STD 08-109705-00 0.25mm 08-109707-00 0.50mm 1.50  CR P 1.75  P 3.00  CR P	

[26] A = 35.300, D = 66.500









[26] A = 35.300, D = 66.500

...Continued

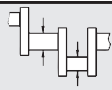
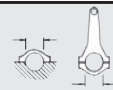
880

81.00

Petrol

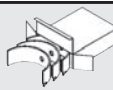
									
BE/PL	4	47.758/47.778	50.600/50.612	19.000	1.406	0.020/0.067	EC	71-3694	71-3694/4 STD 0.25 0.50
MB/HL	3	53.958/53.978	59.000/59.019	18.500	2.502	0.020/0.082	AL-LF	02-3085L	H025/5 STD 0.25 0.50
MB/HL	5	53.958/53.978	59.000/59.019	18.500	2.502	0.020/0.082	AL-LF	02-3085U	
MB/HL	1	53.958/53.978	59.000/59.019	24.930	2.502	0.020/0.082	AL-LF	02-3086HL	
MB/HL	1	53.958/53.978	59.000/59.019	24.930	2.502	0.020/0.082	AL-LF	02-3086HU	
MB/HL	4	53.958/53.978	59.000/59.019	18.500	2.502	0.020/0.082	AL-LF	02-3085L	H027/5 STD 0.25 0.50
MB/HL	6	53.958/53.978	59.000/59.019	18.500	2.502	0.020/0.082	AL-LF	02-3085U	

02-3085L

02-3085U

02-3086HL

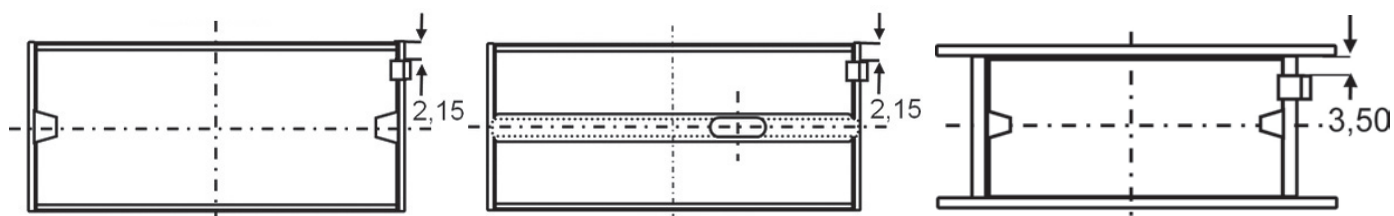

02-3086HU

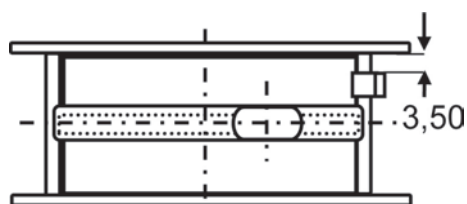

TW/A	2	59.500	73.200		1.975		AL-LF	04-3527	A123/4 STD	
TW/A	2	59.500	73.200		1.975		AL-LF	04-3528		
SE/PB	1	20.000	23.000/23.052	25.000			BC	55-3567	55-3567 SEMI	
CB/NWB 1-5	5	25.939/25.960	28.250/28.271	17.000	1.138		AL-LF	03-3317	N118/5 STD	[67]
BU	1	42.959/42.975	46.055/46.095	15.000			AL-LF	07-3088	07-3088 STD SEMI	[68]
BU	1	41.959/41.975	45.000/45.025	15.000			AL-LF	07-3089	07-3089 STD SEMI	[68]

881



81.00

Petrol



DTA	4 Cyl.	9:1	1595cc	55kW (75)PS	TD255	320
DTA	4 Cyl.	9:1	1595cc	55kW (75)PS	TD22646	403

<p>87-109700-20 STD</p> <p>87-109707-20 [26] 0.50mm</p> <p>A 35.60</p> <p>B- 2.30</p> <p>B+ 2.20</p> <p>D 66.80</p> <p> 20x57</p>	<p>08-109700-00 STD</p> <p>08-109705-00 0.25mm</p> <p>08-109707-00 0.50mm</p> <p>1.50 CR P</p> <p>1.75 P</p> <p>3.00 CR P</p>								

[26] A = 35.300, D = 66.500 [26] A = 35.300, D = 66.500

BE/PL	1	45.950/45.970	49.000/49.016	19.000	1.506	0.020/0.078	EC	71-3084	71-3084 STD 0.25 0.50	
BE/PL	4	47.758/47.778	50.600/50.619	19.000	1.406	0.020/0.074	EC	71-3566	71-3566/4 STD 0.25 0.50	
01/84 → 12/85										
BE/PL	4	47.758/47.778	50.600/50.612	19.000	1.406	0.020/0.067	EC	71-3694	71-3694/4 STD 0.25 0.50	

71-3084





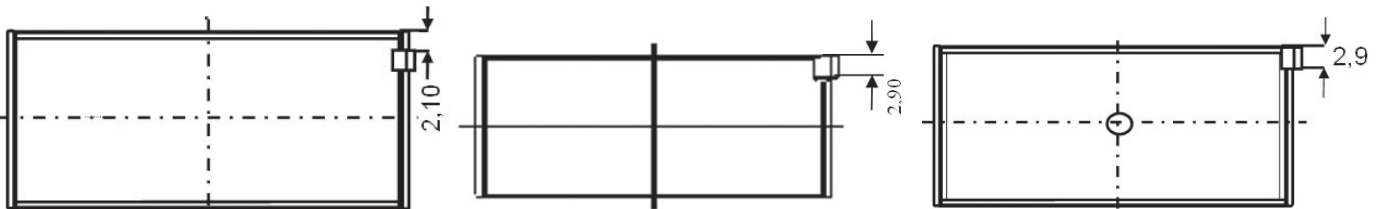



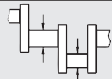

71-3566

71-3694



...Continued

881  **81.00** **Petrol**

									
MB/HL	3	53.958/53.978	59.000/59.019	18.500	2.502	0.020/0.082	AL-LF	02-3085L	H025/5 STD 0.25 0.50
MB/HL	5	53.958/53.978	59.000/59.019	18.500	2.502	0.020/0.082	AL-LF	02-3085U	
MB/HL	1	53.958/53.978	59.000/59.019	24.930	2.502	0.020/0.082	AL-LF	02-3086HL	
MB/HL	1	53.958/53.978	59.000/59.019	24.930	2.502	0.020/0.082	AL-LF	02-3086HU	H027/5 STD 0.25 0.50
MB/HL	4	53.958/53.978	59.000/59.019	18.500	2.502	0.020/0.082	AL-LF	02-3085L	
MB/HL	6	53.958/53.978	59.000/59.019	18.500	2.502	0.020/0.082	AL-LF	02-3085U	

02-3085L

02-3085U

02-3086HL

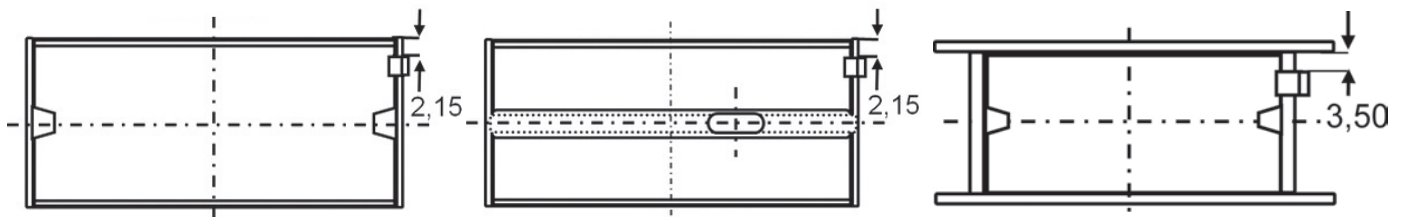

02-3086HU

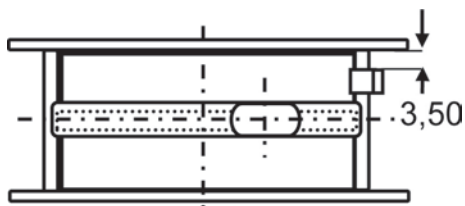

TW/A	2	59.500	73.200		1.975		AL-LF	04-3527	A123/4 STD	
TW/A	2	59.500	73.200		1.975		AL-LF	04-3528		
SE/PB	1	20.000	23.000/23.052	25.000			BC	55-3567	55-3567 SEMI	
BU	1	42.959/42.975	46.055/46.095	15.000			AL-LF	07-3088	07-3088 STD SEMI	[68]
BU	1	41.959/41.975	45.000/45.025	15.000			AL-LF	07-3089	07-3089 STD SEMI	[68]

882

81.00

Petrol



EW	4 Cyl.	9:1	1595cc	55kW (75)PS	TD4070	321
CADDY	01/83→07/92		GOLF	01/83→04/92	JETTA	08/82→07/83
SAVEIRO	08/90→02/02		SCIROCCO	01/83→12/89		

87-109700-20 STD 87-109707-20 [26] 0.50mm	08-109700-00 STD 08-109705-00 0.25mm 08-109707-00 0.50mm	
A 35.60 B- 2.30 B+ 2.20 D 66.80 20x57	1.50 CR P 1.75 P 3.00 CR P	

[26] A = 35.300, D = 66.500

[26] A = 35.300, D = 66.500

BE/PL	1	45.950/45.970	49.000/49.016	19.000	1.506	0.020/0.078	EC	71-3084	71-3084 STD 0.25 0.50
BE/PL	4	47.758/47.778	50.600/50.619	19.000	1.406	0.020/0.074	EC	71-3566	71-3566/4 STD 0.25 0.50
BE/PL	4	47.758/47.778	50.600/50.612	19.000	1.406	0.020/0.067	EC	71-3694	71-3694/4 STD 0.25 0.50

71-3084





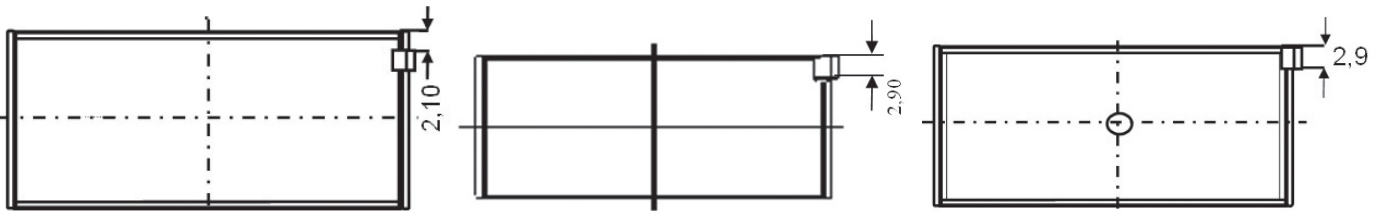



71-3566

71-3694

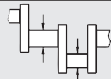

...Continued

882  **81.00** **Petrol**

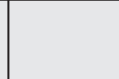
										
MB/HL	3	53.958/53.978	59.000/59.019	18.500	2.502	0.020/0.082	AL-LF	02-3085L	H025/5 STD 0.25 0.50	
MB/HL	5	53.958/53.978	59.000/59.019	18.500	2.502	0.020/0.082	AL-LF	02-3085U		
MB/HL	1	53.958/53.978	59.000/59.019	24.930	2.502	0.020/0.082	AL-LF	02-3086HL		
MB/HL	1	53.958/53.978	59.000/59.019	24.930	2.502	0.020/0.082	AL-LF	02-3086HU		
MB/HL	4	53.958/53.978	59.000/59.019	18.500	2.502	0.020/0.082	AL-LF	02-3085L		H027/5 STD 0.25 0.50
MB/HL	6	53.958/53.978	59.000/59.019	18.500	2.502	0.020/0.082	AL-LF	02-3085U		

02-3085L

02-3085U

02-3086HL

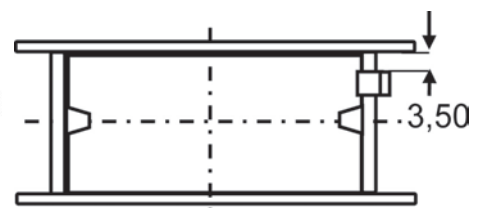
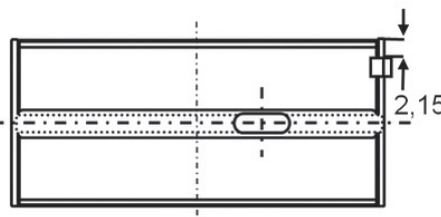
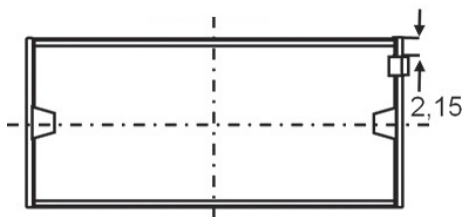

02-3086HU

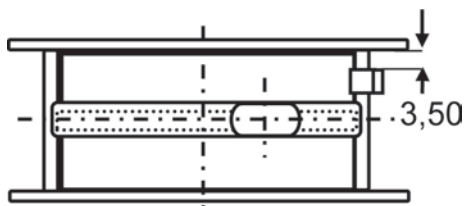

TW/A	2	59.500	73.200	1.975	AL-LF	04-3527	A123/4 STD
TW/A	2	59.500	73.200	1.975	AL-LF	04-3528	
SE/PB	1	20.000	23.000/23.052	25.000	BC	55-3567	55-3567 SEMI
SE/PB	1	20.000	23.000/23.021	25.000	BC	55-3698	

55-3567

55-3698

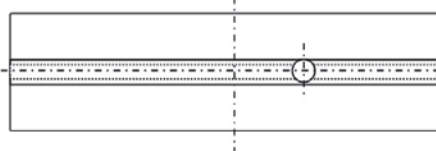
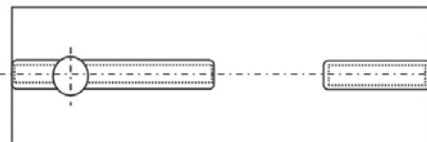

CB/NWB 1-5	5	25.939/25.960	28.250/28.271	17.000	1.138	AL-LF	03-3317	N118/5 STD	[67]	
BU	1	42.959/42.975	46.055/46.095	15.000		AL-LF	07-3088		07-3088 STD SEMI	[68]
BU	1	41.959/41.975	45.000/45.025	15.000		AL-LF	07-3089		07-3089 STD SEMI	[68]

883

81.00

Petrol



EZ	4 Cyl.	9:1	1595cc	55kW (75)PS	TD4074	323	
EZ	4 Cyl.	9:1	1595cc	55kW (75)PS	TD4899	323	
GOLF	08/83→07/92		JETTA	01/84→07/92		KOMBI	08/92→07/00
PASSAT	02/88→09/91		TOLEDO	05/91→03/99			

87-109700-20 STD 87-109707-20 [26] 0.50mm		08-109700-00 STD 08-109705-00 0.25mm 08-109707-00 0.50mm
A 35.60 B- 2.30 B+ 2.20 D 66.80 20x57		1.50 CR P 1.75 P 3.00 CR P

[26] A = 35.300, D = 66.500

[26] A = 35.300, D = 66.500

BE/PL	4	47.758/47.778	50.600/50.612	19.000	1.406	0.020/0.067	EC	71-3694	71-3694/4 STD 0.25 0.50
MB/HL	3	53.958/53.978	59.000/59.019	18.500	2.502	0.020/0.082	AL-LF	02-3085L	H025/5 STD 0.25 0.50
MB/HL	5	53.958/53.978	59.000/59.019	18.500	2.502	0.020/0.082	AL-LF	02-3085U	
MB/HL	1	53.958/53.978	59.000/59.019	24.930	2.502	0.020/0.082	AL-LF	02-3086HL	
MB/HL	1	53.958/53.978	59.000/59.019	24.930	2.502	0.020/0.082	AL-LF	02-3086HU	
MB/HL	4	53.958/53.978	59.000/59.019	18.500	2.502	0.020/0.082	AL-LF	02-3085L	H027/5 STD 0.25 0.50
MB/HL	6	53.958/53.978	59.000/59.019	18.500	2.502	0.020/0.082	AL-LF	02-3085U	

02-3085L





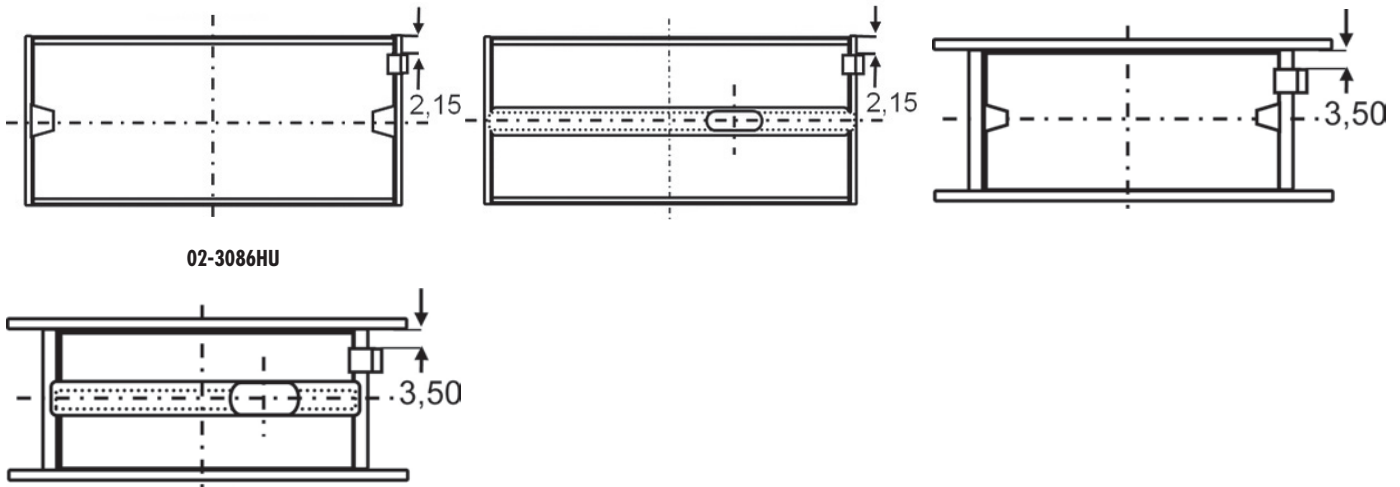



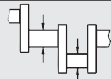

02-3085U

02-3086HL



02-3086HU



...Continued





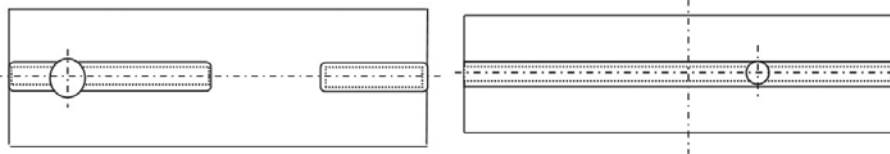

883		81.00	Petrol							
										
TW/A	2	59.500	73.200		1.975		AL-LF	04-3527	A123/4 STD	
TW/A	2	59.500	73.200		1.975		AL-LF	04-3528		
SE/PB	1	20.000	23.000/23.052	25.000			BC	55-3567	55-3567 SEMI	
Mot. → 53L020000										
SE/PB	1	20.000	23.000/23.021	25.000			BC	55-3698	55-3698 SEMI	
Mot. 53M000001 →										

55-3567

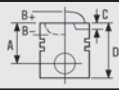
55-3698









884		81.00	Petrol							
EZA	4 Cyl.		1595cc		51kW (70)PS				TD4075	324
HM	4 Cyl.	9:1	1595cc		55kW (75)PS				TD3590	325
HM	4 Cyl.	9:1	1595cc		55kW (75)PS				TD9523	325
CITYGOLF	06/96 → 12/99		FOX		01/87 → 12/93		GOLF		08/83 → 07/92	
JETTA	01/84 → 07/92									

		
87-109700-20 STD 87-109707-20 [26] 0.50mm A 35.60 B- 2.30 B+ 2.20 D 66.80  20x57	08-109700-00 STD 08-109705-00 0.25mm 08-109707-00 0.50mm 1.50  CR P 1.75  P 3.00  CR P	

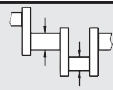
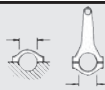
[26] A = 35.300, D = 66.500

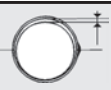
[26] A = 35.300, D = 66.500

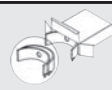
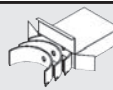
									
BE/PL	4	47.758/47.778	50.600/50.612	19.000	1.406	0.020/0.067	EC	71-3694	71-3694/4 STD 0.25 0.50
MB/HL	3	53.958/53.978	59.000/59.019	18.500	2.502	0.020/0.082	AL-LF	02-3085L	H025/5 STD 0.25 0.50
MB/HL	5	53.958/53.978	59.000/59.019	18.500	2.502	0.020/0.082	AL-LF	02-3085U	
MB/HL	1	53.958/53.978	59.000/59.019	24.930	2.502	0.020/0.082	AL-LF	02-3086HL	
MB/HL	1	53.958/53.978	59.000/59.019	24.930	2.502	0.020/0.082	AL-LF	02-3086HU	
MB/HL	4	53.958/53.978	59.000/59.019	18.500	2.502	0.020/0.082	AL-LF	02-3085L	H027/5 STD 0.25 0.50
MB/HL	6	53.958/53.978	59.000/59.019	18.500	2.502	0.020/0.082	AL-LF	02-3085U	

02-3085L

02-3085U

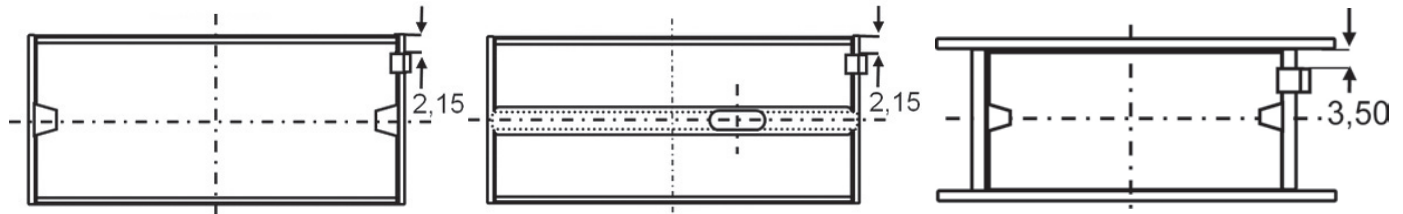

02-3086HL



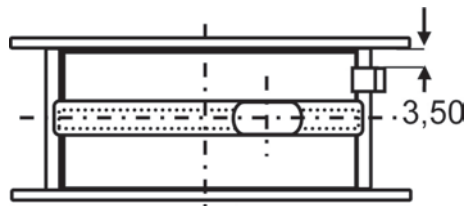





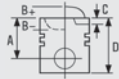

02-3086HU



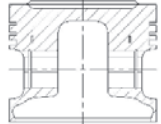
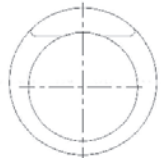





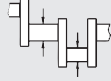
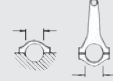

TW/A	2	59.500	73.200		1.975		AL-LF	04-3527	A123/4 STD	
TW/A	2	59.500	73.200		1.975		AL-LF	04-3528		
SE/PB	1	20.000	23.000/23.052	25.000			BC	55-3567	55-3567 SEMI	
BU	1	42.959/42.975	46.055/46.095	15.000			AL-LF	07-3088	07-3088 STD SEMI	[68]
BU	1	41.959/41.975	45.000/45.025	15.000			AL-LF	07-3089	07-3089 STD SEMI	[68]

885	 81.00	Petrol				
HN	4 Cyl.	1595cc	55kW (75)PS	TD4107	326	
JU	4 Cyl.	9:1	1595cc	55kW (75)PS	TD277	327
JU	4 Cyl.	9:1	1595cc	55kW (75)PS	TD12532	327
GOLF	01/83→04/92					

		
87-109700-20 STD 87-109707-20 [26] 0.50mm A 35.60 B- 2.30 B+ 2.20 D 66.80  20x57	 	08-109700-00 STD 08-109705-00 0.25mm 08-109707-00 0.50mm 1.50  CR P 1.75  P 3.00  CR P

[26] A = 35.300, D = 66.500 [26] A = 35.300, D = 66.500

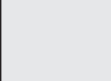
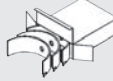
										
BE/PL	1	45.950/45.970	49.000/49.016	19.000	1.506	0.020/0.078	EC	71-3084	71-3084 STD 0.25 0.50	
→12/83										
BE/PL	4	47.758/47.778	50.600/50.619	19.000	1.406	0.020/0.074	EC	71-3566	71-3566/4 STD 0.25 0.50	
01/84→12/85										
BE/PL	4	47.758/47.778	50.600/50.612	19.000	1.406	0.020/0.067	EC	71-3694	71-3694/4 STD 0.25 0.50	
01/86→										

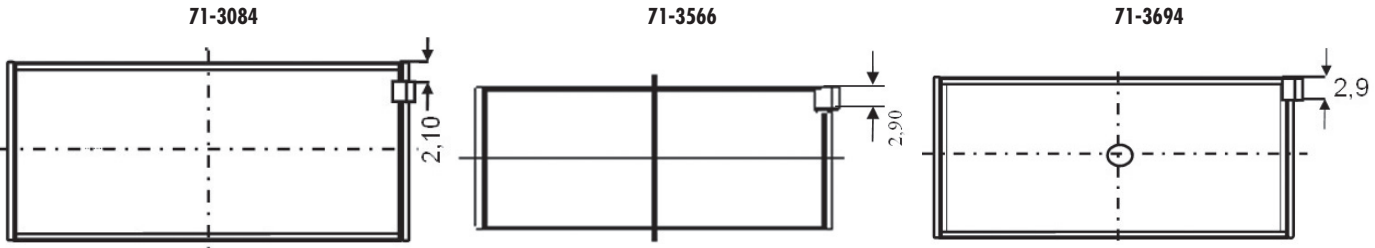

MB/HL	3	53.958/53.978	59.000/59.019	18.500	2.502	0.020/0.082	AL-LF	02-3085L	H025/5 STD 0.25 0.50
MB/HL	5	53.958/53.978	59.000/59.019	18.500	2.502	0.020/0.082	AL-LF	02-3085U	
MB/HL	1	53.958/53.978	59.000/59.019	24.930	2.502	0.020/0.082	AL-LF	02-3086HL	H027/5 STD 0.25 0.50
MB/HL	1	53.958/53.978	59.000/59.019	24.930	2.502	0.020/0.082	AL-LF	02-3086HU	
MB/HL	4	53.958/53.978	59.000/59.019	18.500	2.502	0.020/0.082	AL-LF	02-3085L	
MB/HL	6	53.958/53.978	59.000/59.019	18.500	2.502	0.020/0.082	AL-LF	02-3085U	

02-3085L

02-3085U

02-3086HL

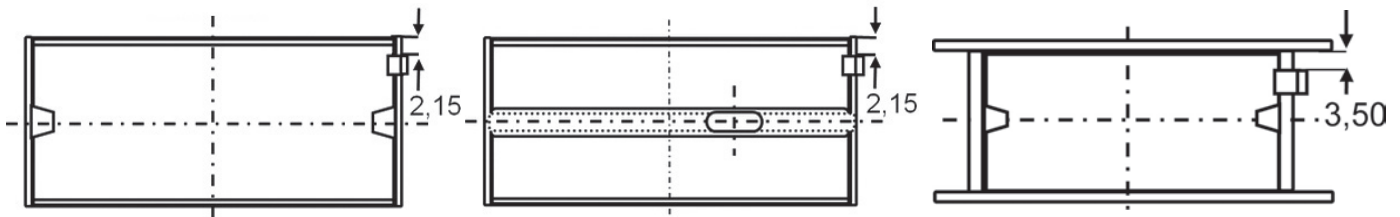

02-3086HU

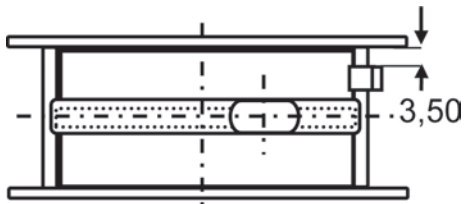

TW/A	2	59.500	73.200		1.975		AL-LF	04-3527	A123/4 STD	
TW/A	2	59.500	73.200		1.975		AL-LF	04-3528		
SE/PB	1	20.000	23.000/23.052	25.000			BC	55-3567	55-3567 SEMI	
CB/NWB 1-5	5	25.939/25.960	28.250/28.271	17.000	1.138		AL-LF	03-3317	N118/5 STD	[67]
BU	1	42.959/42.975	46.055/46.095	15.000			AL-LF	07-3088	07-3088 STD SEMI	[68]
BU	1	41.959/41.975	45.000/45.025	15.000			AL-LF	07-3089	07-3089 STD SEMI	[68]

886	81.00	Petrol				
PN	4 Cyl.	9:1	1595cc	51kW (70)PS	TD4141	328
RF	4 Cyl.	9:1	1595cc	53kW (72)PS	TD5025	328
GOLF	02/86→12/92	JETTA	03/86→10/91			

87-109700-20 STD 87-109707-20 [26] 0.50mm A 35.60 B- 2.30 B+ 2.20 D 66.80 20x57	08-109700-00 STD 08-109705-00 0.25mm 08-109707-00 0.50mm 1.50 CR P 1.75 P 3.00 CR P	

[26] A = 35.300, D = 66.500 [26] A = 35.300, D = 66.500

BE/PL	4	47.758/47.778	50.600/50.612	19.000	1.406	0.020/0.067	EC	71-3694	71-3694/4 STD 0.25 0.50	
MB/HL	4	53.958/53.978	59.000/59.019	18.500	2.502	0.020/0.082	AL-LF	02-3085L	H027/5 STD 0.25 0.50	
MB/HL	6	53.958/53.978	59.000/59.019	18.500	2.502	0.020/0.082	AL-LF	02-3085U		
TW/A	2	59.500	73.200		1.975		AL-LF	04-3527	A123/4 STD	
TW/A	2	59.500	73.200		1.975		AL-LF	04-3528		
SE/PB	1	20.000	23.000/23.052	25.000			BC	55-3567	55-3567 SEMI	
SE/PB	1	20.000	23.000/23.021	25.000			BC	55-3698	55-3698 SEMI	
55-3567			55-3698							

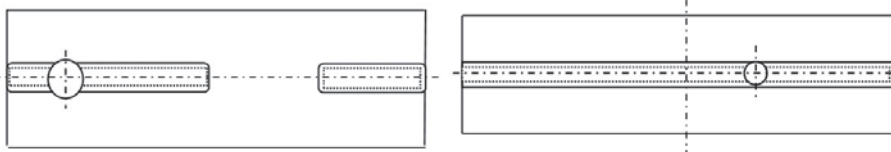

BU	1	42.959/42.975	46.055/46.095	15.000			AL-LF	07-3088	07-3088 STD SEMI	[68]
BU	1	41.959/41.975	45.000/45.025	15.000			AL-LF	07-3089	07-3089 STD SEMI	[68]

887	81.00	Petrol	
PP	4 Cyl.	9:1	1595cc 51kW (70)PS TD307 329
PP	4 Cyl.	9:1	1595cc 51kW (70)PS TD5022 329
RN	4 Cyl.		1595cc 55kW (75)PS TD314 331
80	09/86→09/91	PASSAT	08/87→03/88

87-109700-20 STD 87-109707-20 [26] 0.50mm A 35.60 B- 2.30 B+ 2.20 D 66.80 20x57	87-109700-00 STD 87-109705-00 0.25mm 87-109707-00 0.50mm 1.50 CR P 1.75 P 3.00 CR P								

[26] A = 35.300, D = 66.500 [26] A = 35.300, D = 66.500

BE/PL	4	47.758/47.778	50.600/50.612	19.000	1.406	0.020/0.067	EC	71-3694	71-3694/4 STD 0.25 0.50	
MB/HL	4	53.958/53.978	59.000/59.019	18.500	2.502	0.020/0.082	AL-LF	02-3085L	H027/5 STD 0.25 0.50	
MB/HL	6	53.958/53.978	59.000/59.019	18.500	2.502	0.020/0.082	AL-LF	02-3085U		
TW/A	2	59.500	73.200		1.975		AL-LF	04-3527	A123/4 STD	
TW/A	2	59.500	73.200		1.975		AL-LF	04-3528		
SE/PB	1	20.000	23.000/23.052	25.000			BC	55-3567	55-3567 SEMI	
BU	1	42.959/42.975	46.055/46.095	15.000			AL-LF	07-3088	07-3088 STD SEMI	[68]
BU	1	41.959/41.975	45.000/45.025	15.000			AL-LF	07-3089	07-3089 STD SEMI	[68]







888	81.00	Petrol	
RE	4 Cyl.	9:1	1595cc 53kW (72)PS TD4145 328
GOLF	04/86→02/90	SCIROCCO	04/86→07/90

87-109700-20 STD 87-109707-20 [26] 0.50mm A 35.60 B- 2.30 B+ 2.20 D 66.80 20x57	87-109700-00 STD 87-109705-00 0.25mm 87-109707-00 0.50mm 1.50 CR P 1.75 P 3.00 CR P								

[26] A = 35.300, D = 66.500 [26] A = 35.300, D = 66.500

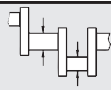
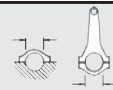
...Continued

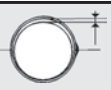
888  **81.00** **Petrol**

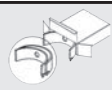
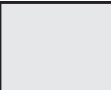
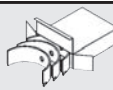
										
BE/PL	4	47.758/47.778	50.600/50.612	19.000	1.406	0.020/0.067	EC	71-3694	71-3694/4 STD 0.25 0.50	
MB/HL	3	53.958/53.978	59.000/59.019	18.500	2.502	0.020/0.082	AL-LF	02-3085L	H025/5 STD 0.25 0.50	
MB/HL	5	53.958/53.978	59.000/59.019	18.500	2.502	0.020/0.082	AL-LF	02-3085U		
MB/HL	1	53.958/53.978	59.000/59.019	24.930	2.502	0.020/0.082	AL-LF	02-3086HL		
MB/HL	1	53.958/53.978	59.000/59.019	24.930	2.502	0.020/0.082	AL-LF	02-3086HU		
MB/HL	4	53.958/53.978	59.000/59.019	18.500	2.502	0.020/0.082	AL-LF	02-3085L	H027/5 STD 0.25 0.50	
MB/HL	6	53.958/53.978	59.000/59.019	18.500	2.502	0.020/0.082	AL-LF	02-3085U		

02-3085L

02-3085U

02-3086HL

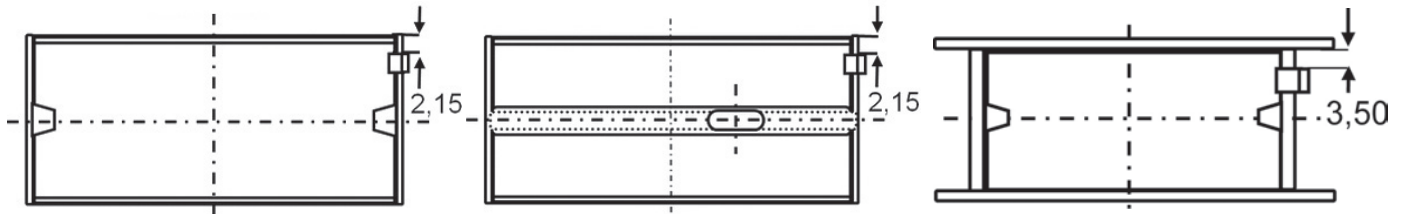

02-3086HU

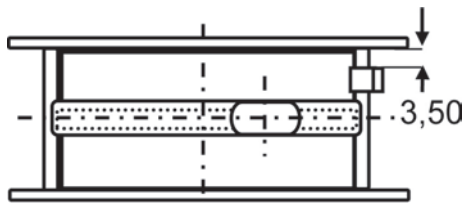

TW/A	2	59.500	73.200	1.975	AL-LF	04-3527	A123/4 STD
TW/A	2	59.500	73.200	1.975	AL-LF	04-3528	
SE/PB	1	20.000	23.000/23.052	25.000	BC	55-3567	55-3567 SEMI
SE/PB	1	20.000	23.000/23.021	25.000	BC	55-3698	55-3698 SEMI

55-3567

55-3698

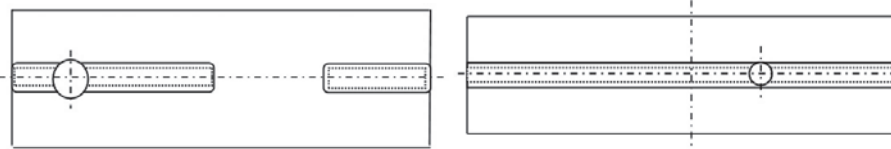

BU	1	42.959/42.975	46.055/46.095	15.000	AL-LF	07-3088	07-3088 STD SEMI	[68]
BU	1	41.959/41.975	45.000/45.025	15.000	AL-LF	07-3089	07-3089 STD SEMI	[68]

889

81.00

Petrol



RL 4 Cyl. 9:1 1595cc 53kW (72)PS TD4148 330

PASSAT 01/85→03/88

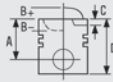

87-109700-20 STD
87-109707-20 [26] 0.50mm

STD
0.50mm

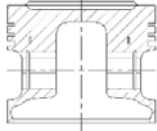

08-109700-00 STD
08-109705-00 0.25mm
08-109707-00 0.50mm

1.50 CR P
1.75 P
3.00 CR P

A 35.60
B- 2.30
B+ 2.20
D 66.80
20x57



[26] A = 35.300, D = 66.500

[26] A = 35.300, D = 66.500

BE/PL	4	47.758/47.778	50.600/50.619	19.000	1.406	0.020/0.074	EC	71-3566	71-3566/4 STD 0.25 0.50
BE/PL	4	47.758/47.778	50.600/50.612	19.000	1.406	0.020/0.067	EC	71-3694	71-3694/4 STD 0.25 0.50

01/86→

71-3566

71-3694

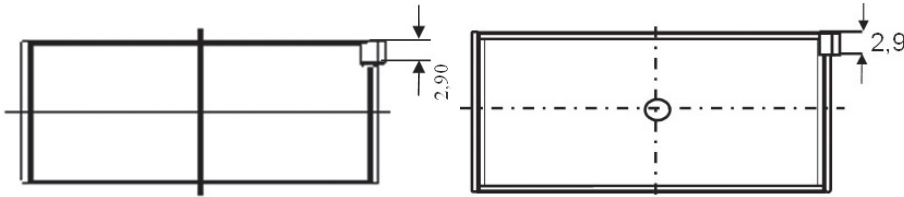

MB/HL	3	53.958/53.978	59.000/59.019	18.500	2.502	0.020/0.082	AL-LF	02-3085L	H025/5 STD 0.25 0.50
MB/HL	5	53.958/53.978	59.000/59.019	18.500	2.502	0.020/0.082	AL-LF	02-3085U	
MB/HL	1	53.958/53.978	59.000/59.019	24.930	2.502	0.020/0.082	AL-LF	02-3086HL	
MB/HL	1	53.958/53.978	59.000/59.019	24.930	2.502	0.020/0.082	AL-LF	02-3086HU	
MB/HL	4	53.958/53.978	59.000/59.019	18.500	2.502	0.020/0.082	AL-LF	02-3085L	H027/5 STD 0.25 0.50
MB/HL	6	53.958/53.978	59.000/59.019	18.500	2.502	0.020/0.082	AL-LF	02-3085U	

02-3085L

02-3085U



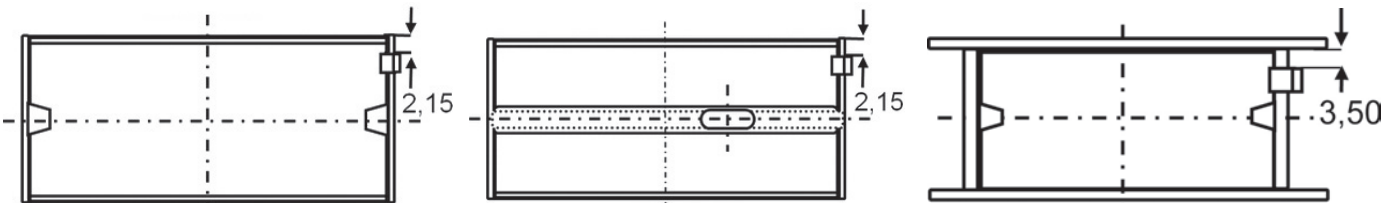



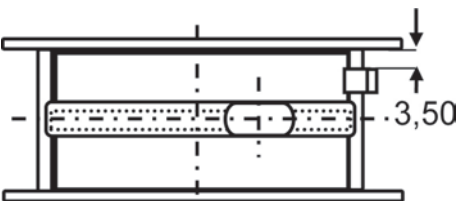



02-3086HL

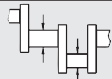







02-3086HU



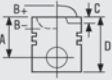







...Continued

889		 81.00		Petrol						
										
TW/A	2	59.500	73.200		1.975		AL-LF	04-3527	A123/4 STD	
TW/A	2	59.500	73.200		1.975		AL-LF	04-3528		
SE/PB	1	20.000	23.000/23.052	25.000			BC	55-3567	55-3567 SEMI	
CB/NWB 1-5	5	25.939/25.960	28.250/28.271	17.000	1.138		AL-LF	03-3317	N118/5 STD	[67]
BU	1	42.959/42.975	46.055/46.095	15.000			AL-LF	07-3088	07-3088 STD SEMI	[68]
BU	1	41.959/41.975	45.000/45.025	15.000			AL-LF	07-3089	07-3089 STD SEMI	[68]

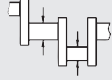
890		 81.00		Petrol						
SA	4 Cyl.	9:1	1595cc	54kW (73)PS					TD321	332
80	02/86→07/86									

		
87-109700-20 STD 87-109707-20 [26] 0.50mm A 35.60 B- 2.30 B+ 2.20 D 66.80  20x57	08-109700-00 STD 08-109705-00 0.25mm 08-109707-00 0.50mm 1.50  CR P 1.75  P 3.00  CR P	

[26] A = 35.300, D = 66.500 [26] A = 35.300, D = 66.500

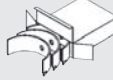
										
BE/PL	4	47.758/47.778	50.600/50.612	19.000	1.406	0.020/0.067	EC	71-3694	71-3694/4 STD 0.25 0.50	
MB/HL	3	53.958/53.978	59.000/59.019	18.500	2.502	0.020/0.082	AL-LF	02-3085L	H025/5 STD 0.25 0.50	
MB/HL	5	53.958/53.978	59.000/59.019	18.500	2.502	0.020/0.082	AL-LF	02-3085U		
MB/HL	1	53.958/53.978	59.000/59.019	24.930	2.502	0.020/0.082	AL-LF	02-3086HL		
MB/HL	1	53.958/53.978	59.000/59.019	24.930	2.502	0.020/0.082	AL-LF	02-3086HU		
SE/PB	1	20.000	23.000/23.052	25.000			BC	55-3567	55-3567 SEMI	
BU	1	42.959/42.975	46.055/46.095	15.000			AL-LF	07-3088	07-3088 STD SEMI	[68]
BU	1	41.959/41.975	45.000/45.025	15.000			AL-LF	07-3089	07-3089 STD SEMI	[68]

891	81.00	Petrol	
1H	4 Cyl.	1781cc	118kW (160)PS
GOLF	08/88→07/91		TD3994 334



BE/PL	4	47.758/47.778	50.600/50.612	19.000	1.406	0.020/0.067	EC	71-3694	71-3694/4 STD 0.25 0.50
TW/A	2	63.500/63.750	77.200/77.450		1.975		AL-LF	04-3529	A124/4 STD
TW/A	2	63.500/63.750	77.200/77.450		1.975		AL-LF	04-3530	
TW/A	2	63.500/63.750	76.950/77.200		1.975		AL-LF	04-4782	A292/4 STD
TW/A	2	63.500/63.750	76.950/77.200		1.975		AL-LF	04-4783	







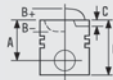

892	81.00	Petrol	
1P	4 Cyl.	1781cc	72kW (98)PS
GOLF	08/88→07/91	JETTA	08/88→07/91

87-109400-50 [51] STD 87-109407-50 [51] [63] 0.50mm A 32.20 B- 4.40 B+ 1.30 BØ 55.70 D 62.50 20x57	08-109400-10 STD 08-109407-10 0.50mm 1.50 P PS 1.75 P 3.00 CR P	
08130E-110		

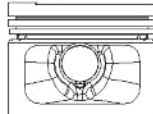
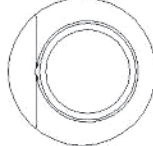

[51] Pistons to be replaced in Engine Sets only [51] Kolben nur Motorsätzen zu ersetzen
 [63] A=31.90 D=62.20 [63] A=31.90 D=62.20









BE/PL	4	47.758/47.778	50.600/50.612	19.000	1.406	0.020/0.067	EC	71-3694	71-3694/4 STD 0.25 0.50
MB/HL	4	53.958/53.978	59.000/59.019	18.500	2.502	0.020/0.082	AL-LF	02-3085L	H027/5 STD 0.25 0.50
MB/HL	6	53.958/53.978	59.000/59.019	18.500	2.502	0.020/0.082	AL-LF	02-3085U	
TW/A	2	59.500	73.200		1.975		AL-LF	04-3527	A123/4 STD
TW/A	2	59.500	73.200		1.975		AL-LF	04-3528	
SE/PB	1	20.000	23.000/23.052	25.000			BC	55-3567	55-3567 SEMI
BU	1	42.959/42.975	46.055/46.095	15.000			AL-LF	07-3088	07-3088 STD SEMI [68]
BU	1	41.959/41.975	45.000/45.025	15.000			AL-LF	07-3089	07-3089 STD SEMI [68]

893	 81.00	Petrol				
2H	4 Cyl.	9:1	1781cc	72kW (98)PS	TD4965	336
GZ	4 Cyl.	10:1	1781cc	66kW (89)PS	TD4102	409
HT	4 Cyl.	10:1	1781cc	74-77kW (100-104)PS	TD4109	410
HV	4 Cyl.	10:1	1781cc	66kW (89)PS	TD4111	411
MU	4 Cyl.	10:1	1781cc	82kW (111)PS	TD298	419
GOLF	08/83 → 03/93	JETTA	01/84 → 10/91			

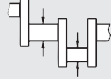
		
87-109400-50 [51] STD 87-109407-50 [51] [63] 0.50mm A 32.20 B- 4.40 B+ 1.30 BØ 55.70 D 62.50  20x57   08130E-110	08-109400-10 STD 08-109407-10 0.50mm 1.50  P PS 1.75  P 3.00  CR P	

[51] Pistons to be replaced in Engine Sets only [51] Kolben nur Motorsätzen zu ersetzen
 [63] A=31.90 D=62.20 [63] A=31.90 D=62.20

894	 81.00	Petrol			
4B	4 Cyl.	1781cc	66kW (89)PS	TD219	337
NP	4 Cyl.	1781cc	66kW (89)PS	TD304	416
100	08/83 → 11/90				

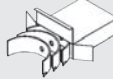





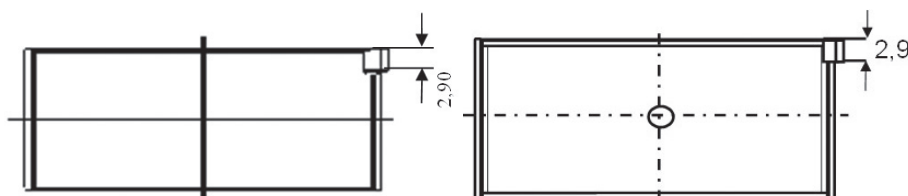

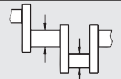

									
BE/PL	4	47.758/47.778	50.600/50.619	19.000	1.406	0.020/0.074	EC	71-3566	71-3566/4 STD 0.25 0.50
→12/85									
BE/PL	4	47.758/47.778	50.600/50.612	19.000	1.406	0.020/0.067	EC	71-3694	71-3694/4 STD 0.25 0.50
01/86 →									

71-3566







71-3694



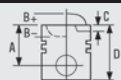







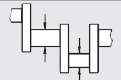

MB/HL	4	53.958/53.978	59.000/59.019	18.500	2.502	0.020/0.082	AL-LF	02-3085L	H027/5 STD 0.25 0.50
MB/HL	6	53.958/53.978	59.000/59.019	18.500	2.502	0.020/0.082	AL-LF	02-3085U	
TW/A	2	59.500	73.200		1.975		AL-LF	04-3527	A123/4 STD
TW/A	2	59.500	73.200		1.975		AL-LF	04-3528	
SE/PB	1	20.000	23.000/23.052	25.000			BC	55-3567	55-3567 SEMI

894		 81.00	Petrol							
										
CB/NWB 1-5	5	25.939/25.960	28.250/28.271	17.000	1.138		AL-LF	03-3317	N118/5 STD	[67]
BU	1	42.959/42.975	46.055/46.095	15.000			AL-LF	07-3088	07-3088 STD SEMI	[68]
BU	1	41.959/41.975	45.000/45.025	15.000			AL-LF	07-3089	07-3089 STD SEMI	[68]

895		 81.00	Petrol							
AAM	4 Cyl.	9:1	1781cc	55kW (75)PS			TD4004		338	
GOLF	11/91→06/02	PASSAT	08/90→05/97	VENTO			11/91→09/98			

		
	08-109700-00 STD 08-109705-00 0.25mm 08-109707-00 0.50mm 1.50  CR P 1.75  P 3.00  CR P	

										
BE/PL	4	47.758/47.778	50.600/50.612	19.000	1.406	0.020/0.067	EC	71-3694	71-3694/4 STD 0.25 0.50	
BE/PL	4	47.758/47.778	50.600/50.612	19.000	1.406	0.020/0.067	EC	71-3929	71-3929/4 STD	[66]

71-3694

71-3929

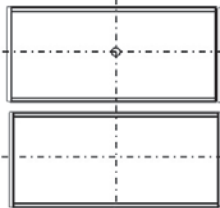
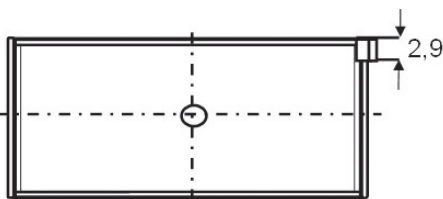

MB/HL	4	53.958/53.978	59.000/59.019	18.500	2.502	0.020/0.082	AL-LF	02-3085L	H027/5 STD 0.25 0.50
MB/HL	6	53.958/53.978	59.000/59.019	18.500	2.502	0.020/0.082	AL-LF	02-3085U	
TW/A	2	59.500	73.200		1.975		AL-LF	04-3527	A123/4 STD
TW/A	2	59.500	73.200		1.975		AL-LF	04-3528	
SE/PB	1	20.000	23.000/23.021	25.000			BC	55-3698	55-3698 SEMI

896

81.00

Petrol



ABS	4 Cyl.	10:1	1781cc	66kW (89)PS	TD3576	339
ABS	4 Cyl.	10:1	1781cc	66kW (89)PS	TD4975	339
ADZ	4 Cyl.	9:1	1781cc	66kW (89)PS	TD4980	344
ADZ	4 Cyl.	9:1	1781cc	66kW (89)PS	TD9384	344

CORDOBA	02/93→06/99	GOLF	11/91→06/02	IBIZA	03/93→08/99
PASSAT	02/88→05/97	POLO	05/97→09/01	TOLEDO	11/93→12/96
VENTO	11/91→09/98				



87-109400-50 [51] STD 87-109407-50 [51] [63] 0.50mm		08-109400-10 STD 08-109407-10 0.50mm
A 32.20 B- 4.40 B+ 1.30 B0 55.70 D 62.50 20x57		1.50 P PS 1.75 P 3.00 CR P
<p>08130E-110</p>		







[51] Pistons to be replaced in Engine Sets only [51] Kolben nur Motorsätzen zu ersetzen



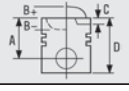







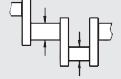

[63] A=31.90 D=62.20



[63] A=31.90 D=62.20











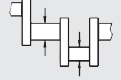

BE/PL	4	47.758/47.778	50.600/50.612	19.000	1.406	0.020/0.067	EC	71-3694	71-3694/4 STD 0.25 0.50	
MB/HL	4	53.958/53.978	59.000/59.019	18.500	2.502	0.020/0.082	AL-LF	02-3085L	H027/5 STD 0.25 0.50	
MB/HL	6	53.958/53.978	59.000/59.019	18.500	2.502	0.020/0.082	AL-LF	02-3085U		
TW/A	2	59.500	73.200		1.975		AL-LF	04-3527	A123/4 STD	
TW/A	2	59.500	73.200		1.975		AL-LF	04-3528		
SE/PB	1	20.000	23.000/23.021	25.000			BC	55-3698	55-3698 SEMI	
BU	1	42.959/42.975	46.055/46.095	15.000			AL-LF	07-3088	07-3088 STD SEMI	[68]
BU	1	41.959/41.975	45.000/45.025	15.000			AL-LF	07-3089	07-3089 STD SEMI	[68]

897	 81.00	Petrol				
ACC	4 Cyl.	10:1	1781cc	66kW (89)PS	TD4011	340
ACC	4 Cyl.	10:1	1781cc	66kW (89)PS	TD18752	340
CORDOBA	02/93→09/02	GOLF	11/91→09/99	IBIZA	03/93→08/99	
TOLEDO	11/93→12/96					

		
	08-109700-00 STD 08-109705-00 0.25mm 08-109707-00 0.50mm 1.50  CR P 1.75  P 3.00  CR P	

											
BE/PL	4	47.758/47.778	50.600/50.612	19.000	1.406	0.020/0.067	EC	71-3694	71-3694/4 STD 0.25 0.50		
MB/HL	4	53.958/53.978	59.000/59.019	18.500	2.502	0.020/0.082	AL-LF	02-3085L	H027/5 STD 0.25 0.50		
MB/HL	6	53.958/53.978	59.000/59.019	18.500	2.502	0.020/0.082	AL-LF	02-3085U			
TW/A	2	59.500	73.200		1.975		AL-LF	04-3527	A123/4 STD		
TW/A	2	59.500	73.200		1.975		AL-LF	04-3528			
SE/PB	1	20.000	23.000/23.021	25.000			BC	55-3698	55-3698 SEMI		

898	 81.00	Petrol				
ADD	4 Cyl.		1781cc	66kW (89)PS	TD15496	341
ADF	4 Cyl.	9:1	1781cc	55kW (75)PS	TD21353	298
ADL	4 Cyl.	10.5:1	1781cc	95kW (129)PS	TD3578	342
CORDOBA	10/93→08/96	IBIZA	11/93→08/96	POLO	01/97→12/08	

											
BE/PL	4	47.758/47.778	50.600/50.612	19.000	1.406	0.020/0.067	EC	71-3694	71-3694/4 STD 0.25 0.50		
MB/HL	4	53.958/53.978	59.000/59.019	18.500	2.502	0.020/0.082	AL-LF	02-3085L	H027/5 STD 0.25 0.50		
MB/HL	6	53.958/53.978	59.000/59.019	18.500	2.502	0.020/0.082	AL-LF	02-3085U			
TW/A	2	59.500	73.200		1.975		AL-LF	04-3527	A123/4 STD		
TW/A	2	59.500	73.200		1.975		AL-LF	04-3528			
SE/PB	1	20.000	23.000/23.021	25.000			BC	55-3698	55-3698 SEMI		

899	81.00	Petrol				
ADR	4 Cyl.	10.3:1	1781cc	92kW (125)PS	TD241	343
ADR	4 Cyl.	10.3:1	1781cc	92kW (125)PS	TD5557	343
ADR	4 Cyl.	10.3:1	1781cc	92kW (125)PS	TD20805	343
A4	01/95→09/01	A6	12/95→12/97	CABRIOLET	01/97→08/00	
PASSAT	10/96→11/00					

87-502900-00 [35] STD 87-502907-00 [35] 0.50mm A 32.55 C 3.60 D 56.55 20x59 AK	 08-502900-00 STD 08-502905-00 0.25mm 08-502907-00 0.50mm 1.50 CK P 1.75 P 2.00 CR P	

[35] Conrod gap 27.50mm [35] Pleuelaugenabstand 27.50mm

BE/PL	4	47.758/47.778	50.600/50.612	19.000	1.406	0.020/0.067	EC	71-3694	71-3694/4 STD 0.25 0.50	
MB/HL	4	53.958/53.978	59.000/59.019	18.500	2.502	0.020/0.082	AL-LF	02-3085L	H027/5 STD 0.25 0.50	
MB/HL	6	53.958/53.978	59.000/59.019	18.500	2.502	0.020/0.082	AL-LF	02-3085U		
MB/HL 1-5	5	53.958/53.978	59.000/59.019	18.500	2.502	0.020/0.082	AL-LF	02-3085L	H084/5 STD 0.25 0.50	
MB/HL 1-5	5	53.958/53.978	59.000/59.019	18.500	2.502	0.020/0.082	AL-LF	02-3085U		

02-3085L

02-3085U

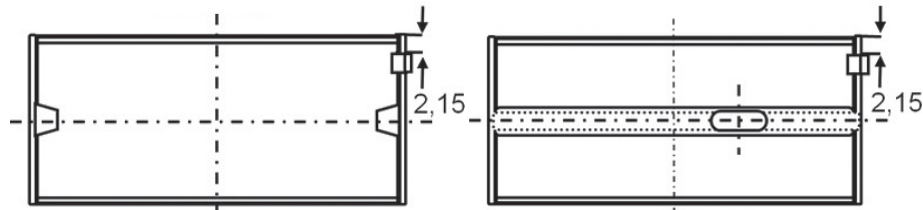

TW/A	2	59.500	73.200		1.975		AL-LF	04-3527	A123/4 STD
TW/A	2	59.500	73.200		1.975		AL-LF	04-3528	
SE/PB	1	20.000	23.000/23.021	25.000			BC	55-3698	55-3698 SEMI

900

81.00

Petrol



AEB	4 Cyl.	9.5:1	1781cc	110kW (150)PS	TD4199	345
AEB	4 Cyl.	9.5:1	1781cc	110kW (150)PS	TD5558	345
A4	01/95→09/01		A6	01/97→01/05	PASSAT	10/96→11/00

87-502900-10 STD 87-502905-10 0.25mm 87-502907-10 0.50mm	08-502900-00 STD 08-502905-00 0.25mm 08-502907-00 0.50mm	
A 32.70 B- 2.05 BØ 70.00 D 53.70 20x59 AK		

BE/PL	4	47.758/47.778	50.600/50.612	19.000	1.395	0.032/0.089	SP	71-3732	71-3732/4 STD	[64]
MB/HL	4	53.958/53.978	59.000/59.019	18.500	2.502	0.020/0.082	AL-LF	02-3085L	H027/5 STD 0.25 0.50	
MB/HL	6	53.958/53.978	59.000/59.019	18.500	2.502	0.020/0.082	AL-LF	02-3085U		
MB/HL 1-5	5	53.958/53.978	59.000/59.019	18.500	2.502	0.020/0.082	AL-LF	02-3085L	H084/5 STD 0.25 0.50	
MB/HL 1-5	5	53.958/53.978	59.000/59.019	18.500	2.502	0.020/0.082	AL-LF	02-3085U		

02-3085L

02-3085U

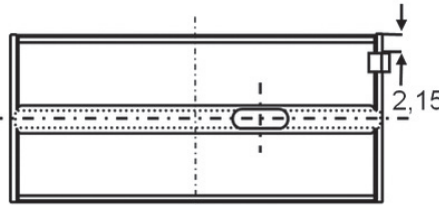
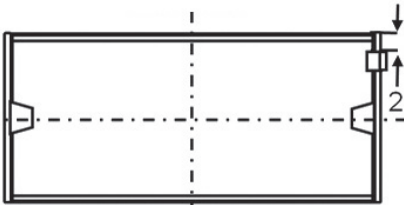

TW/A	2	59.500	73.200	1.975	AL-LF	04-3527	A123/4 STD
TW/A	2	59.500	73.200	1.975	AL-LF	04-3528	

901	81.00	Petrol			
AFY	4 Cyl.	1781cc	85kW (115)PS	TD13948	346
AFY	4 Cyl.	1781cc	85kW (115)PS	TD16244	346
A4	04/95→09/01	A6	05/97→01/05	PASSAT	01/97→03/05

BE/PL	4	47.758/47.778	50.600/50.612	19.000	1.406	0.020/0.067	EC	71-3694	71-3694/4 STD 0.25 0.50	
MB/HL	4	53.958/53.978	59.000/59.019	18.500	2.502	0.020/0.082	AL-LF	02-3085L	H027/5 STD 0.25 0.50	
MB/HL	6	53.958/53.978	59.000/59.019	18.500	2.502	0.020/0.082	AL-LF	02-3085U		
MB/HL 1-5	5	53.958/53.978	59.000/59.019	18.500	2.502	0.020/0.082	AL-LF	02-3085L	H084/5 STD 0.25 0.50	
MB/HL 1-5	5	53.958/53.978	59.000/59.019	18.500	2.502	0.020/0.082	AL-LF	02-3085U		

02-3085L

02-3085U

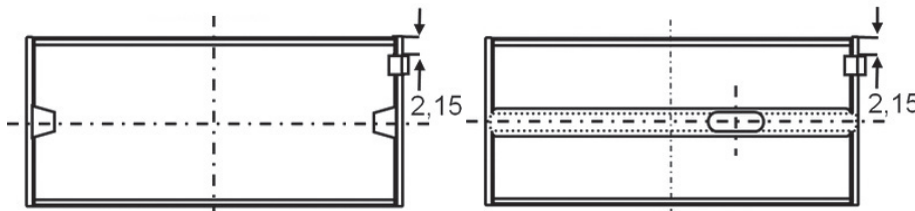







TW/A	2	59.500	73.200	1.975	AL-LF	04-3527	A123/4 STD
TW/A	2	59.500	73.200	1.975	AL-LF	04-3528	
SE/PB	1	20.000	23.000/23.021	25.000	BC	55-3698	55-3698 SEMI

902	81.00	Petrol				
AGN	4 Cyl.	10.3:1	1781cc	92kW (125)PS	TD5073	347
AGN	4 Cyl.	10.3:1	1781cc	92kW (125)PS	TD9363	347
AGN	4 Cyl.	10.3:1	1781cc	92kW (125)PS	TD12510	347
AGN	4 Cyl.	10.3:1	1781cc	92kW (125)PS	TD17903	347
APT	4 Cyl.	10.3:1	1781cc	92kW (125)PS	TD11497	362
APT	4 Cyl.	10.3:1	1781cc	92kW (125)PS	TD13775	362
ARG	4 Cyl.		1781cc	92kW (125)PS	TD13776	367
ARG	4 Cyl.		1781cc	92kW (125)PS	TD16237	367
A3	09/96→05/03	A4	01/95→09/01	BORA	10/98→05/05	
CITYGOLF	06/96→12/99	GOLF	08/97→06/06	LEON	11/99→06/06	
OCTAVIA	09/96→07/00	PASSAT	10/96→03/05	TOLEDO	04/99→05/06	



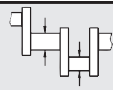
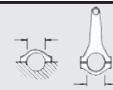

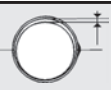

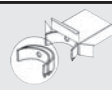
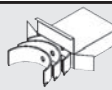

87-502900-00 [35] 87-502907-00 [35]	STD 0.50mm	08-502900-00 08-502905-00 08-502907-00	STD 0.25mm 0.50mm	1.50 1.75 2.00	CK P P CR P
A 32.55 C 3.60 D 56.55 20x59					
AK					

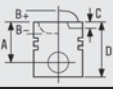

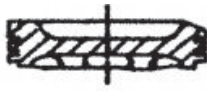



[35] Conrod gap 27.50mm

[35] Pleuelaugenabstand 27.50mm

902		 81.00	Petrol						
									
BE/PL	4	47.758/47.778	50.600/50.612	19.000	1.406	0.020/0.067	EC	71-3694	71-3694/4 STD 0.25 0.50
MB/HL 1-5	5	53.958/53.978	59.000/59.019	18.500	2.502	0.020/0.082	AL-LF	02-3085L	H084/5 STD 0.25 0.50
MB/HL 1-5	5	53.958/53.978	59.000/59.019	18.500	2.502	0.020/0.082	AL-LF	02-3085U	
TW/A	2	59.500	73.200		1.975		AL-LF	04-3527	A123/4 STD
TW/A	2	59.500	73.200		1.975		AL-LF	04-3528	
SE/PB	1	20.000	23.000/23.021	25.000			BC	55-3698	55-3698 SEMI

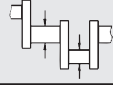
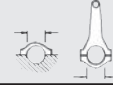
903		 81.00	Petrol						
AGU	4 Cyl.	9.5:1	1781cc			110kW (150)PS			TD5075 348
AGU	4 Cyl.	9.5:1	1781cc			110kW (150)PS			TD9456 348
AGU	4 Cyl.	9.5:1	1781cc			110kW (150)PS			TD13396 348
ARZ	4 Cyl.	9.5:1	1781cc			110kW (150)PS			TD11593 371
ARZ	4 Cyl.	9.5:1	1781cc			110kW (150)PS			TD16030 371
ARZ	4 Cyl.	9.5:1	1781cc			110kW (150)PS			TD16385 371
AWC	4 Cyl.	9.5:1	1781cc			110kW (150)PS			TD14909 349
AWC	4 Cyl.	9.5:1	1781cc			110kW (150)PS			TD14914 349
A3	12/96 → 05/03	ALHAMBRA		10/97 → 03/10		BORA		05/00 → 05/05	
GOLF	08/97 → 06/06	NEW BEETLE		10/99 →		OCTAVIA		08/97 → 12/10	
SHARAN	09/97 → 03/10								

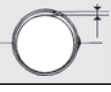
					
87-502900-10	STD		08-502900-00	STD	
87-502905-10	0.25mm		08-502905-00	0.25mm	
87-502907-10	0.50mm		08-502907-00	0.50mm	
A 32.70			1.50		CK P
B- 2.05			1.75		P
BØ 70.00			2.00		CR P
D 53.70					
 20x59					
AK					

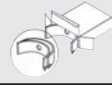
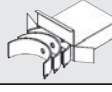
902		 81.00	Petrol						
									
BE/PL	4	47.758/47.778	50.600/50.612	19.000	1.395	0.032/0.089	SP	71-3732	71-3732/4 STD [64]
MB/HL 1-5	5	53.958/53.978	59.000/59.019	18.500	2.502	0.020/0.082	AL-LF	02-3085L	H084/5 STD 0.25 0.50
MB/HL 1-5	5	53.958/53.978	59.000/59.019	18.500	2.502	0.020/0.082	AL-LF	02-3085U	
TW/A	2	59.500	73.200		1.975		AL-LF	04-3527	A123/4 STD
TW/A	2	59.500	73.200		1.975		AL-LF	04-3528	
SE/PB	1	20.000	23.000/23.021	25.000			BC	55-3698	55-3698 SEMI

904

81.00



Petrol











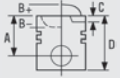



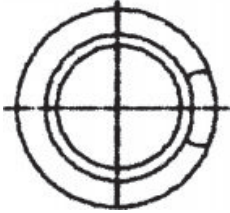



AJH	4 Cyl.	9.5:1	1781cc	110kW (150)PS	TD10887	349
AJH	4 Cyl.	9.5:1	1781cc	110kW (150)PS	TD17899	349
ALHAMBRA		10/97→03/10		SHARAN	09/97→03/10	

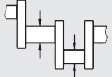

87-502900-10	STD		08-502900-00	STD	
87-502905-10	0.25mm		08-502905-00	0.25mm	
87-502907-10	0.50mm		08-502907-00	0.50mm	
A	32.70				
B-	2.05				
BØ	70.00				
D	53.70				
	20x59				
AK					





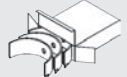



BE/PL	4	47.758/47.778	50.600/50.612	19.000	1.395	0.032/0.089	SP	71-3732	71-3732/4 STD	[64]
MB/HL	4	53.958/53.978	59.000/59.019	18.500	2.502	0.020/0.082	AL-LF	02-3085L	H027/5 STD 0.25 0.50	
MB/HL	6	53.958/53.978	59.000/59.019	18.500	2.502	0.020/0.082	AL-LF	02-3085U		
TW/A	2	59.500	73.200		1.975		AL-LF	04-3527	A123/4 STD	
TW/A	2	59.500	73.200		1.975		AL-LF	04-3528		
SE/PB	1	20.000	23.000/23.021	25.000			BC	55-3698	55-3698 SEMI	

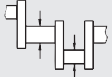

905		 81.00	Petrol			
AJL	4 Cyl.		1781cc	132kW (180)PS	TD9470 350	
AJQ	4 Cyl.	9.5:1	1781cc	132kW (180)PS	TD11347 352	
AJQ	4 Cyl.	9.5:1	1781cc	132kW (180)PS	TD16199 352	
APP	4 Cyl.	9.5:1	1781cc	132kW (180)PS	TD11591 352	
APP	4 Cyl.	9.5:1	1781cc	132kW (180)PS	TD13270 352	
AQA	4 Cyl.	9.5:1	1781cc	110kW (150)PS	TD11592 364	
AQA	4 Cyl.	9.5:1	1781cc	110kW (150)PS	TD22620 364	
A3	12/96→05/03		A4	12/97→09/01	A6	12/97→01/05
GOLF	08/97→06/06		LEON	11/99→06/06	TOLEDO	05/01→05/06
TT	10/98→06/06					





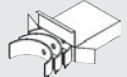

		
87-502900-10 STD 87-502905-10 0.25mm 87-502907-10 0.50mm	08-502900-00 STD 08-502905-00 0.25mm 08-502907-00 0.50mm	
A 32.70 B- 2.05 BØ 70.00 D 53.70  20x59 AK	  1.50  CK P 1.75  P 2.00  CR P	

										
BE/PL	4	47.758/47.778	50.600/50.612	19.000	1.395	0.032/0.089	SP	71-3732	71-3732/4 STD	[64]
SE/PB	1	20.000	23.000/23.021	25.000			BC	55-3698	55-3698 SEMI	

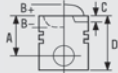

906		 81.00	Petrol		
AJP	4 Cyl.		1781cc	92kW (125)PS	TD9518 351
AQE	4 Cyl.		1781cc	92kW (125)PS	TD14029 365
ARH	4 Cyl.		1781cc	92kW (125)PS	TD15329 368
A6	07/97→01/05				









									
BE/PL	4	47.758/47.778	50.600/50.612	19.000	1.406	0.020/0.067	EC	71-3694	71-3694/4 STD 0.25 0.50
SE/PB	1	26.000	29.000/29.052	25.000			BC	55-3729	55-3729 SEMI

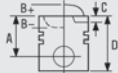







907		 81.00	Petrol			
AMK	4 Cyl.	9:1	1781cc	154kW (210)PS	TD12648	354
AMK	4 Cyl.	9:1	1781cc	154kW (210)PS	TD16436	354
AMU	4 Cyl.		1781cc	165kW (224)PS	TD15358	355
APX	4 Cyl.	8.9:1	1781cc	121/162kW (165/221)PS	TD11349	361
APY	4 Cyl.		1781cc	154kW (210)PS	TD11594	363
AUL	4 Cyl.		1781cc	154kW (210)PS	TD15355	372
BAM	4 Cyl.	9:1	1781cc	165kW (224)PS	TD16331	383
BAM	4 Cyl.	9:1	1781cc	165kW (224)PS	TD17347	383
A3	03/99→05/03		LEON	02/02→06/06	TOLEDO	05/02→10/05
TT	10/98→06/06					

		
	08-115900-00 STD 1.50  PS[52] 1.75  P 2.00  CR P	

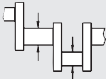
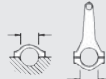
[52] Steel [52] Stahl

908		 81.00	Petrol			
ANB	4 Cyl.	9.5:1	1781cc	110kW (150)PS	TD13949	356
ANB	4 Cyl.	9.5:1	1781cc	110kW (150)PS	TD16256	356
APU	4 Cyl.	9.5:1	1781cc	110kW (150)PS	TD13950	356
APU	4 Cyl.	9.5:1	1781cc	110kW (150)PS	TD16257	356
A4	01/95→09/01		A6	01/97→01/05	PASSAT	10/96→11/00

		
87-502900-10 STD 87-502905-10 0.25mm 87-502907-10 0.50mm   A 32.70 B- 2.05 BØ 70.00 D 53.70  20x59 AK	08-502900-00 STD 08-502905-00 0.25mm 08-502907-00 0.50mm 1.50  CK P 1.75  P 2.00  CR P	

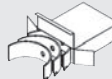
									
BE/PL	4	47.758/47.778	50.600/50.612	19.000	1.395	0.032/0.089	SP	71-3732	71-3732/4 STD
MB/HL 1-5	5	53.958/53.978	59.000/59.019	18.500	2.502	0.020/0.082	AL-LF	02-3085L	H084/5 STD 0.25 0.50
MB/HL 1-5	5	53.958/53.978	59.000/59.019	18.500	2.502	0.020/0.082	AL-LF	02-3085U	
TW/A	2	59.500	73.200		1.975		AL-LF	04-3527	A123/4 STD
TW/A	2	59.500	73.200		1.975		AL-LF	04-3528	

909









 **81.00**

Petrol

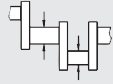
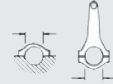

ANN	4 Cyl.	9:1	1781cc	55kW (75)PS	TD10847	357
ANP	4 Cyl.	9:1	1781cc	66kW (89)PS	TD10848	358

GOLF 07/93→06/02

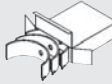
									
BE/PL	4	47.758/47.778	50.600/50.612	19.000	1.406	0.020/0.067	EC	71-3694	71-3694/4 STD 0.25 0.50
BE/PL	4	47.758/47.778	50.600/50.612	19.000	1.406	0.020/0.067	EC	71-3929	71-3929/4 STD

[66]

71-3694

71-3929

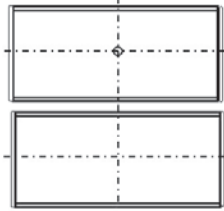
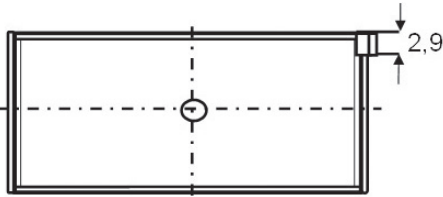

MB/HL	4	53.958/53.978	59.000/59.019	18.500	2.502	0.020/0.082	AL-LF	02-3085L	H027/5 STD 0.25 0.50
MB/HL	6	53.958/53.978	59.000/59.019	18.500	2.502	0.020/0.082	AL-LF	02-3085U	
TW/A	2	59.500	73.200		1.975		AL-LF	04-3527	A123/4 STD
TW/A	2	59.500	73.200		1.975		AL-LF	04-3528	
SE/PB	1	20.000	23.000/23.021	25.000			BC	55-3698	55-3698 SEMI

910









 **81.00**

Petrol

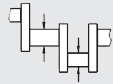
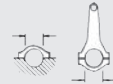

APG	4 Cyl.	10.3:1	1781cc	92kW (125)PS	TD11589	360
APG	4 Cyl.	10.3:1	1781cc	92kW (125)PS	TD15530	360

A3 09/96→05/03 **LEON** 11/99→06/06 **TOLEDO** 04/99→05/06

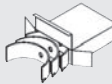
									
BE/PL	4	47.758/47.778	50.600/50.612	19.000	1.406	0.020/0.067	EC	71-3694	71-3694/4 STD 0.25 0.50
SE/PB	1	20.000	23.000/23.021	25.000			BC	55-3698	55-3698 SEMI

911

81.00
Petrol

APH	4 Cyl.	1781cc	110kW (150)PS	TD13441	361
------------	--------	--------	---------------	---------	------------

NEW BEETLE	10/99→				
-------------------	--------	--	--	--	--

87-502900-10 STD 87-502905-10 0.25mm 87-502907-10 0.50mm	08-502900-00 STD 08-502905-00 0.25mm 08-502907-00 0.50mm	
A 32.70 B- 2.05 BØ 70.00 D 53.70 20x59 AK		

BE/PL	4	47.758/47.778	50.600/50.612	19.000	1.395	0.032/0.089	SP	71-3732	71-3732/4 STD	[64]
MB/HL 1-5	5	53.958/53.978	59.000/59.019	18.500	2.502	0.020/0.082	AL-LF	02-3085L	H084/5 STD 0.25 0.50	
MB/HL 1-5	5	53.958/53.978	59.000/59.019	18.500	2.502	0.020/0.082	AL-LF	02-3085U		
SE/PB	1	20.000	23.000/23.021	25.000			BC	55-3698	55-3698 SEMI	

912

81.00
Petrol

AQX	4 Cyl.	9.5:1	1781cc	115kW (156)PS	TD13275	366
------------	--------	-------	--------	---------------	---------	------------

AYP	4 Cyl.		1781cc	115kW (156)PS	TD16201	366
------------	--------	--	--------	---------------	---------	------------

CORDOBA	07/00→10/02	IBIZA	07/00→02/02
----------------	-------------	--------------	-------------

BE/PL	4	47.758/47.778	50.600/50.612	19.000	1.395	0.032/0.089	SP	71-3732	71-3732/4 STD	[64]
MB/HL	4	53.958/53.978	59.000/59.019	18.500	2.502	0.020/0.082	AL-LF	02-3085L	H027/5 STD 0.25 0.50	
MB/HL	6	53.958/53.978	59.000/59.019	18.500	2.502	0.020/0.082	AL-LF	02-3085U		
TW/A	2	59.500	73.200		1.975		AL-LF	04-3527	A123/4 STD	
TW/A	2	59.500	73.200		1.975		AL-LF	04-3528		
SE/PB	1	20.000	23.000/23.021	25.000			BC	55-3698	55-3698 SEMI	

913

81.00

Petrol



ARK	4 Cyl.	1781cc	110kW (150)PS	TD13929	369
A4	01/95→09/01	A6	01/97→01/05		

87-502900-10 STD 87-502905-10 0.25mm 87-502907-10 0.50mm		08-502900-00 STD 08-502905-00 0.25mm 08-502907-00 0.50mm
A 32.70 B- 2.05 BØ 70.00 D 53.70 20x59 AK		1.50 CK P 1.75 P 2.00 CR P

BE/PL	4	47.758/47.778	50.600/50.612	19.000	1.395	0.032/0.089	SP	71-3732	71-3732/4 STD	[64]
MB/HL 1-5	5	53.958/53.978	59.000/59.019	18.500	2.502	0.020/0.082	AL-LF	02-3085L	H084/5 STD 0.25 0.50	
MB/HL 1-5	5	53.958/53.978	59.000/59.019	18.500	2.502	0.020/0.082	AL-LF	02-3085U		
TW/A	2	59.500	73.200		1.975		AL-LF	04-3527	A123/4 STD	
TW/A	2	59.500	73.200		1.975		AL-LF	04-3528		
SE/PB	1	20.000	23.000/23.021	25.000			BC	55-3698	55-3698 SEMI	
CB/NWB 1-5	5	25.939/25.960	28.250/28.271	17.000	1.138		AL-LF	03-3317		

914

81.00

Petrol







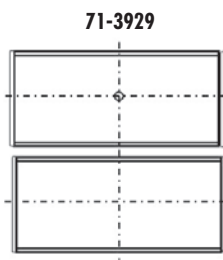
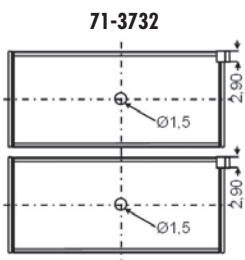



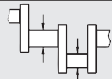

ARX	4 Cyl.	9.5:1	1781cc	110kW (150)PS	TD15485	352
ARX	4 Cyl.	9.5:1	1781cc	110kW (150)PS	TD15988	352
ARX	4 Cyl.	9.5:1	1781cc	110kW (150)PS	TD16069	352
A3	12/96→05/03	BORA	05/00→05/05	OCTAVIA	08/97→12/10	









BE/PL	4	47.758/47.778	50.600/50.612	19.000	1.395	0.032/0.089	SP	71-3732	71-3732/4 STD	[64]
BE/PL	4	47.758/47.778	50.600/50.612	19.000	1.406	0.020/0.067	EC	71-3929	71-3929/4 STD	[66]

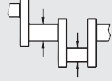
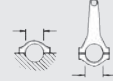

...Continued









914		 81.00	Petrol							
										
MB/HL 1-5	5	53.958/53.978	59.000/59.019	18.500	2.502	0.020/0.082	AL-LF	02-3085L	H084/5 STD 0.25 0.50	
MB/HL 1-5	5	53.958/53.978	59.000/59.019	18.500	2.502	0.020/0.082	AL-LF	02-3085U		
TW/A	2	59.500	73.200		1.975		AL-LF	04-3527	A123/4 STD	
TW/A	2	59.500	73.200		1.975		AL-LF	04-3528		
SE/PB	1	20.000	23.000/23.021	25.000			BC	55-3698	55-3698 SEMI	

915		 81.00	Petrol							
ARY	4 Cyl.	9.5:1	1781cc	132kW (180)PS					TD15352	370
ARY	4 Cyl.	9.5:1	1781cc	132kW (180)PS					TD16136	370
A3	10/98→05/03		LEON	11/99→06/06			TOLEDO	05/01→04/04		
TT	10/98→06/06									

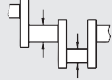
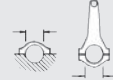
									
BE/PL	4	47.758/47.778	50.600/50.612	19.000	1.406	0.020/0.067	EC	71-3929	71-3929/4 STD [66]
TW/A	2	59.500	73.200		1.975		AL-LF	04-3527	A123/4 STD
TW/A	2	59.500	73.200		1.975		AL-LF	04-3528	
SE/PB	1	20.000	23.000/23.021	25.000			BC	55-3698	55-3698 SEMI

916		 81.00	Petrol							
AUM	4 Cyl.	9.5:1	1781cc	110kW (150)PS					TD15486	373
AUM	4 Cyl.	9.5:1	1781cc	110kW (150)PS					TD15629	373
AUM	4 Cyl.	9.5:1	1781cc	110kW (150)PS					TD16070	373
AUQ	4 Cyl.	9.5:1	1781cc	132kW (180)PS					TD15353	361
AUQ	4 Cyl.	9.5:1	1781cc	132kW (180)PS					TD16135	361
AUQ	4 Cyl.	9.5:1	1781cc	132kW (180)PS					TD16279	361
AUQ	4 Cyl.	9.5:1	1781cc	132kW (180)PS					TD16420	361
AWT	4 Cyl.	9.5:1	1781cc	110kW (150)PS					TD15149	379
AWT	4 Cyl.	9.5:1	1781cc	110kW (150)PS					TD15335	379
AWT	4 Cyl.	9.5:1	1781cc	110kW (150)PS					TD16365	379

A3	12/96→05/03		A4	01/95→09/01		A6	01/97→01/05
BORA	05/00→05/05		GOLF	08/97→06/06		LEON	11/99→06/06
OCTAVIA	08/97→12/10		PASSAT	11/00→05/05		SUPERB	12/01→03/08
TOLEDO	05/01→05/06		TT	10/98→06/06			

									
BE/PL	4	47.758/47.778	50.600/50.612	19.000	1.406	0.020/0.067	EC	71-3929	71-3929/4 STD [66]

917







 **81.00**



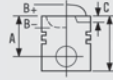

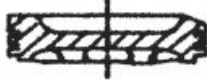

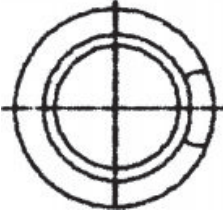

Petrol

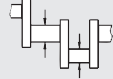
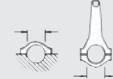

AVC 4 Cyl. 9.5:1 1781cc 110kW (150)PS TD15467 **361**

NEW BEETLE 10/99→

					
87-502900-10	STD		08-502900-00	STD	
87-502905-10	0.25mm		08-502905-00	0.25mm	
87-502907-10	0.50mm		08-502907-00	0.50mm	
A	32.70				
B-	2.05				
BØ	70.00				
D	53.70				
	20x59				
AK					

										
BE/PL	4	47.758/47.778	50.600/50.612	19.000	1.395	0.032/0.089	SP	71-3732	71-3732/4 STD	[64]
TW/A	2	59.500	73.200		1.975		AL-LF	04-3527	A123/4 STD	
TW/A	2	59.500	73.200		1.975		AL-LF	04-3528		

918

 **81.00**

Petrol









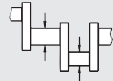
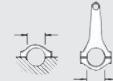

AVJ 4 Cyl. 9.3:1 1781cc 110kW (150)PS TD15349 **374**

BEX 4 Cyl. 1781cc 140kW (190)PS TD16730 **386**

BFB 4 Cyl. 1781cc 120kW (163)PS TD16728 **386**



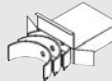

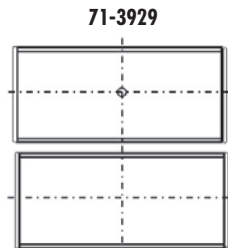
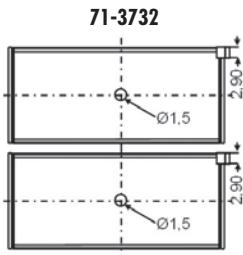



A4 11/00→03/09

										
BE/PL	4	47.758/47.778	50.600/50.612	19.000	1.395	0.032/0.089	SP	71-3732	71-3732/4 STD	[64]
BE/PL	4	47.758/47.778	50.600/50.612	19.000	1.406	0.020/0.067	EC	71-3929	71-3929/4 STD	[66]

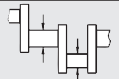

...Continued

918  **81.00** **Petrol**

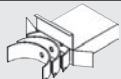
									
MB/HL	3	53.958/53.978	59.000/59.019	18.500	2.502	0.020/0.082	AL-LF	02-3085L	H025/5 STD 0.25 0.50
MB/HL	5	53.958/53.978	59.000/59.019	18.500	2.502	0.020/0.082	AL-LF	02-3085U	
MB/HL	1	53.958/53.978	59.000/59.019	24.930	2.502	0.020/0.082	AL-LF	02-3086HL	
MB/HL	1	53.958/53.978	59.000/59.019	24.930	2.502	0.020/0.082	AL-LF	02-3086HU	
MB/HL	4	53.958/53.978	59.000/59.019	18.500	2.502	0.020/0.082	AL-LF	02-3085L	H027/5 STD 0.25 0.50
MB/HL	6	53.958/53.978	59.000/59.019	18.500	2.502	0.020/0.082	AL-LF	02-3085U	
MB/HL 1-5	5	53.958/53.978	59.000/59.019	18.500	2.502	0.020/0.082	AL-LF	02-3085L	H084/5 STD 0.25 0.50
MB/HL 1-5	5	53.958/53.978	59.000/59.019	18.500	2.502	0.020/0.082	AL-LF	02-3085U	

02-3085L

02-3085U

02-3086HL

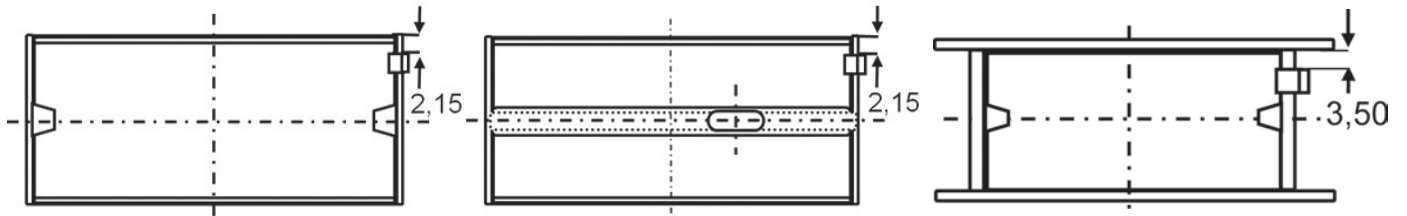

02-3086HU

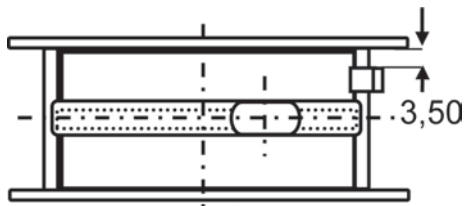

TW/A	2	59.500	73.200		1.975	AL-LF	04-3527	A123/4 STD
TW/A	2	59.500	73.200		1.975	AL-LF	04-3528	
SE/PB	1	20.000	23.000/23.052	25.000		BC	55-3567	55-3567 SEMI
SE/PB	1	20.000	23.000/23.021	25.000		BC	55-3698	

55-3567

55-3698

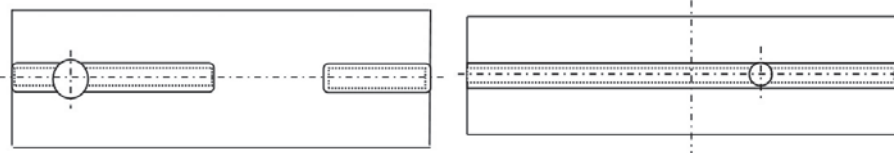

919









 **81.00**

Petrol

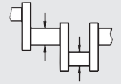
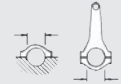

AVV 4 Cyl. 1781cc 92kW (125)PS TD16412 **375**

A4 01/95→09/01

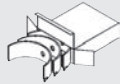
									
BE/PL	4	47.758/47.778	50.600/50.612	19.000	1.406	0.020/0.067	EC	71-3694	71-3694/4 STD 0.25 0.50
TW/A	2	59.500	73.200		1.975		AL-LF	04-3527	A123/4 STD
TW/A	2	59.500	73.200		1.975		AL-LF	04-3528	

920







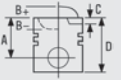

 **81.00**

Petrol







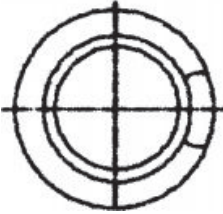





AWD 4 Cyl. 9.5:1 1781cc 110kW (150)PS TD20628

GOLF 08/97→06/06

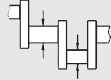
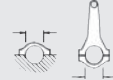
		
<p>87-502900-10 STD</p> <p>87-502905-10 0.25mm</p> <p>87-502907-10 0.50mm</p>	<p>08-502900-00 STD</p> <p>08-502905-00 0.25mm</p> <p>08-502907-00 0.50mm</p>	
<p>A 32.70</p> <p>B- 2.05</p> <p>BØ 70.00</p> <p>D 53.70</p> <p> 20x59</p>	<p> CK P</p> <p> P</p> <p> CR P</p>	
		
		

AK

921	 81.00	Petrol				
AWL	4 Cyl.	9.5:1	1781cc	110kW (150)PS	TD19192	376
AWP	4 Cyl.	9.5:1	1781cc	132kW (180)PS	TD15356	378
BKB	4 Cyl.		1781cc	120kW (163)PS	TD19135	390
A6	01/97→01/05	TT	10/98→06/06			

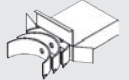
									
BE/PL	4	47.758/47.778	50.600/50.612	19.000	1.406	0.020/0.067	EC	71-3694	71-3694/4 STD 0.25 0.50
BE/PL	4	47.758/47.778	50.600/50.612	19.000	1.406	0.020/0.067	EC	71-3929	71-3929/4 STD

71-3694

71-3929

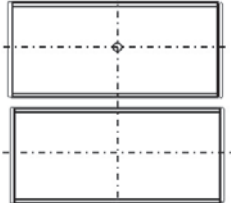
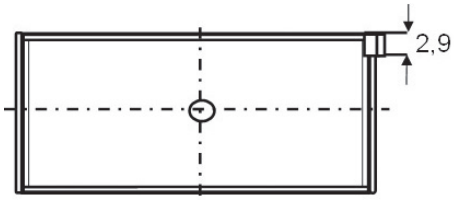

MB/HL	3	53.958/53.978	59.000/59.019	18.500	2.502	0.020/0.082	AL-LF	02-3085L	H025/5 STD 0.25 0.50
MB/HL	5	53.958/53.978	59.000/59.019	18.500	2.502	0.020/0.082	AL-LF	02-3085U	
MB/HL	1	53.958/53.978	59.000/59.019	24.930	2.502	0.020/0.082	AL-LF	02-3086HL	
MB/HL	1	53.958/53.978	59.000/59.019	24.930	2.502	0.020/0.082	AL-LF	02-3086HU	
MB/HL	4	53.958/53.978	59.000/59.019	18.500	2.502	0.020/0.082	AL-LF	02-3085L	H027/5 STD 0.25 0.50
MB/HL	6	53.958/53.978	59.000/59.019	18.500	2.502	0.020/0.082	AL-LF	02-3085U	
MB/HL 1-5	5	53.958/53.978	59.000/59.019	18.500	2.502	0.020/0.082	AL-LF	02-3085L	H084/5 STD 0.25 0.50
MB/HL 1-5	5	53.958/53.978	59.000/59.019	18.500	2.502	0.020/0.082	AL-LF	02-3085U	

02-3085L





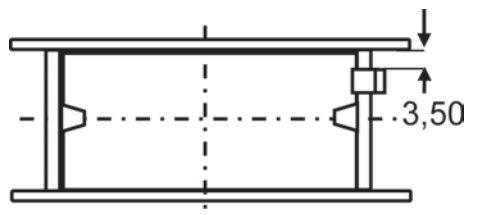
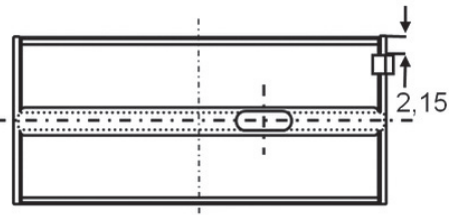
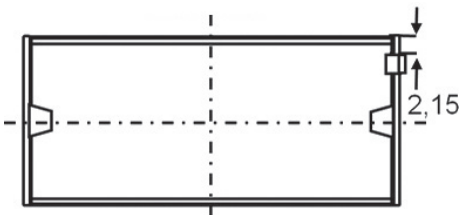

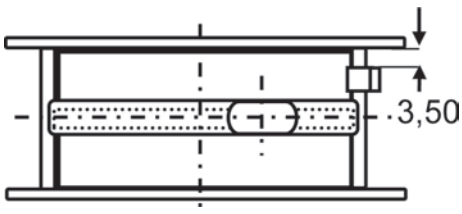

02-3085U

02-3086HL

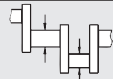
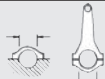

02-3086HU





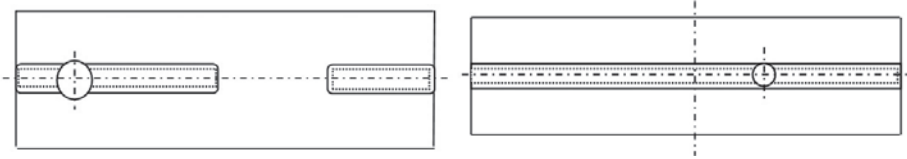





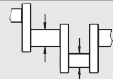
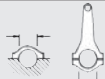

921		 81.00	Petrol							
										
TW/A	2	59.500	73.200		1.975		AL-LF	04-3527	A123/4 STD	
TW/A	2	59.500	73.200		1.975		AL-LF	04-3528		
SE/PB	1	20.000	23.000/23.052	25.000			BC	55-3567	55-3567 SEMI	
SE/PB	1	20.000	23.000/23.021	25.000			BC	55-3698		55-3698 SEMI
55-3567			55-3698							











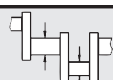

CB/NWB 1-5	5	25.939/25.960	28.250/28.271	17.000	1.138		AL-LF	03-3317	N118/5 STD	[67]
BU	1	42.959/42.975	46.055/46.095	15.000			AL-LF	07-3088	07-3088 STD SEMI	[68]
BU	1	41.959/41.975	45.000/45.025	15.000			AL-LF	07-3089	07-3089 STD SEMI	[68]





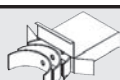



922		 81.00	Petrol								
AWU	4 Cyl.		1781cc							TD15468	378
BLZ	4 Cyl.		1781cc							TD18751	394
IBIZA	01/04→02/08		NEW BEETLE								

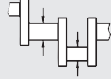
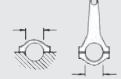

										
BE/PL	4	47.758/47.778	50.600/50.612	19.000	1.406	0.020/0.067	EC	71-3929	71-3929/4 STD	[66]
MB/HL 1-5	5	53.958/53.978	59.000/59.019	18.500	2.502	0.020/0.082	AL-LF	02-3085L		H084/5 STD 0.25 0.50
MB/HL 1-5	5	53.958/53.978	59.000/59.019	18.500	2.502	0.020/0.082	AL-LF	02-3085U		
TW/A	2	59.500	73.200		1.975		AL-LF	04-3527	A123/4 STD	
TW/A	2	59.500	73.200		1.975		AL-LF	04-3528		





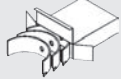





923		 81.00	Petrol								
AWV	4 Cyl.		1781cc							TD15469	380
NEW BEETLE	10/99→										

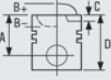
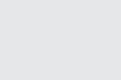



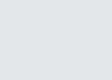
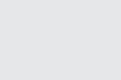



										
BE/PL	4	47.758/47.778	50.600/50.612	19.000	1.406	0.020/0.067	EC	71-3929	71-3929/4 STD	[66]
MB/HL 1-5	5	53.958/53.978	59.000/59.019	18.500	2.502	0.020/0.082	AL-LF	02-3085L		H084/5 STD 0.25 0.50
MB/HL 1-5	5	53.958/53.978	59.000/59.019	18.500	2.502	0.020/0.082	AL-LF	02-3085U		

924	 81.00	Petrol							
DD	4 Cyl.	1781cc	55kW (75)PS			TD250	400		
COUPE	08/81→07/83								

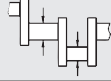
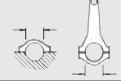
										
BE/PL	1	45.950/45.970	49.000/49.016	19.000	1.506	0.020/0.078	EC	71-3084	71-3084 STD 0.25 0.50	
MB/HL	3	53.958/53.978	59.000/59.019	18.500	2.502	0.020/0.082	AL-LF	02-3085L	H025/5 STD 0.25 0.50	
MB/HL	5	53.958/53.978	59.000/59.019	18.500	2.502	0.020/0.082	AL-LF	02-3085U		
MB/HL	1	53.958/53.978	59.000/59.019	24.930	2.502	0.020/0.082	AL-LF	02-3086HL		
MB/HL	1	53.958/53.978	59.000/59.019	24.930	2.502	0.020/0.082	AL-LF	02-3086HU		
CB/NWB 1-5	5	25.939/25.960	28.250/28.271	17.000	1.138		AL-LF	03-3317	N118/5 STD	[67]
BU	1	42.959/42.975	46.055/46.095	15.000			AL-LF	07-3088	07-3088 STD SEMI	[68]
BU	1	41.959/41.975	45.000/45.025	15.000			AL-LF	07-3089	07-3089 STD SEMI	[68]

925	 81.00	Petrol							
DR	4 Cyl.	1781cc	55kW (75)PS			TD252	401		
JN	4 Cyl.	8.75/9:1	1781cc	66kW (89)PS			TD4208	414	
JN	4 Cyl.	8.75/9:1	1781cc	66kW (89)PS			TD5014	414	
80	08/83→10/91	100	08/82→12/87	COUPE		01/85→10/88			
PASSAT	01/83→03/88	SANTANA	05/91→07/94						

										
										
										08-109700-00 STD 08-109705-00 0.25mm 08-109707-00 0.50mm 1.50  CR P 1.75  P 3.00  CR P

										
BE/PL	4	47.758/47.778	50.600/50.619	19.000	1.406	0.020/0.074	EC	71-3566	71-3566/4 STD 0.25 0.50	
→12/85										
BE/PL	4	47.758/47.778	50.600/50.612	19.000	1.406	0.020/0.067	EC	71-3694	71-3694/4 STD 0.25 0.50	
01/86→										

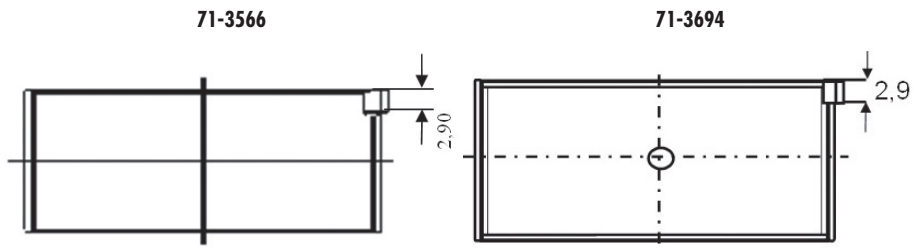

925

81.00

Petrol

MB/HL	3	53.958/53.978	59.000/59.019	18.500	2.502	0.020/0.082	AL-LF	02-3085L	H025/5 STD 0.25 0.50	
MB/HL	5	53.958/53.978	59.000/59.019	18.500	2.502	0.020/0.082	AL-LF	02-3085U		
MB/HL	1	53.958/53.978	59.000/59.019	24.930	2.502	0.020/0.082	AL-LF	02-3086HL		
MB/HL	1	53.958/53.978	59.000/59.019	24.930	2.502	0.020/0.082	AL-LF	02-3086HU		
MB/HL	4	53.958/53.978	59.000/59.019	18.500	2.502	0.020/0.082	AL-LF	02-3085L		H027/5 STD 0.25 0.50
MB/HL	6	53.958/53.978	59.000/59.019	18.500	2.502	0.020/0.082	AL-LF	02-3085U		

02-3085L

02-3085U

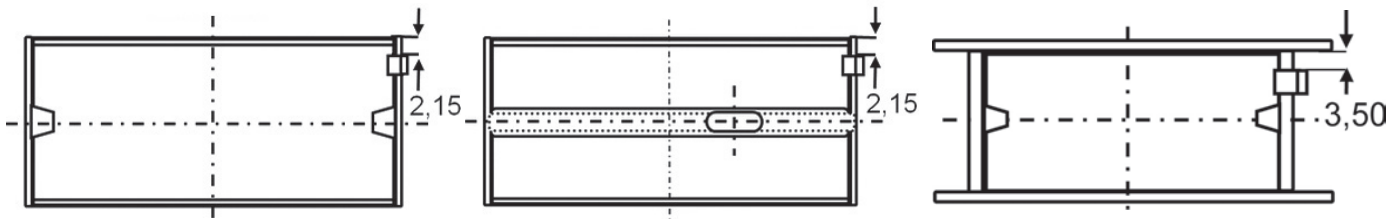

02-3086HL



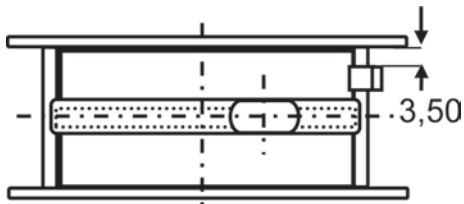







02-3086HU



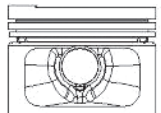
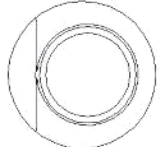







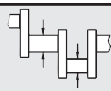
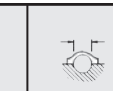

TW/A	2	59.500	73.200		1.975		AL-LF	04-3527	A123/4 STD	
TW/A	2	59.500	73.200		1.975		AL-LF	04-3528		
SE/PB	1	20.000	23.000/23.052	25.000			BC	55-3567	55-3567 SEMI	
CB/NWB 1-5	5	25.939/25.960	28.250/28.271	17.000	1.138		AL-LF	03-3317	N118/5 STD	[67]
BU	1	42.959/42.975	46.055/46.095	15.000			AL-LF	07-3088	07-3088 STD SEMI	[68]
BU	1	41.959/41.975	45.000/45.025	15.000			AL-LF	07-3089	07-3089 STD SEMI	[68]

926	 81.00	Petrol				
DS	4 Cyl.	10:1	1781cc	66kW (89)PS	TD253	402
DS	4 Cyl.	10:1	1781cc	66kW (89)PS	TD4996	402
JV	4 Cyl.	10:1	1781cc	66kW (89)PS	TD278	415
JV	4 Cyl.	10:1	1781cc	66kW (89)PS	TD5017	415
NE	4 Cyl.		1781cc	66kW (89)PS	TD4210	420
PV	4 Cyl.		1781cc	82kW (111)PS	TD311	426
80	01/83→10/91	100	08/83→07/89	COUPE	09/82→10/88	
PASSAT	01/83→03/88	QUANTUM	04/85→07/90	SANTANA	01/83→12/99	

		
87-109400-50 [51] STD 87-109407-50 [51] [63] 0.50mm A 32.20 B- 4.40 B+ 1.30 B0 55.70 D 62.50  20x57   08130E-110	08-109400-10 STD 08-109407-10 0.50mm 1.50  P PS 1.75  P 3.00  CR P	

[51] Pistons to be replaced in Engine Sets only [51] Kolben nur Motorsätzen zu ersetzen
 [63] A=31.90 D=62.20 [63] A=31.90 D=62.20

											
BE/PL	4	47.758/47.778	50.600/50.619	19.000	1.406	0.020/0.074	EC	71-3566	71-3566/4 STD 0.25 0.50		
→12/85											
BE/PL	4	47.758/47.778	50.600/50.612	19.000	1.406	0.020/0.067	EC	71-3694	71-3694/4 STD 0.25 0.50		
01/86→											

71-3566

71-3694

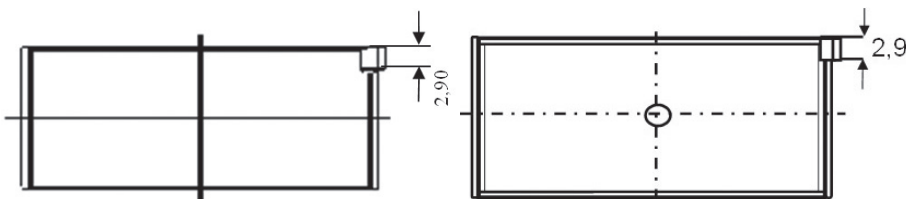

MB/HL	3	53.958/53.978	59.000/59.019	18.500	2.502	0.020/0.082	AL-LF	02-3085L	H025/5 STD 0.25 0.50
MB/HL	5	53.958/53.978	59.000/59.019	18.500	2.502	0.020/0.082	AL-LF	02-3085U	
MB/HL	1	53.958/53.978	59.000/59.019	24.930	2.502	0.020/0.082	AL-LF	02-3086HL	H027/5 STD 0.25 0.50
MB/HL	1	53.958/53.978	59.000/59.019	24.930	2.502	0.020/0.082	AL-LF	02-3086HU	
MB/HL	4	53.958/53.978	59.000/59.019	18.500	2.502	0.020/0.082	AL-LF	02-3085L	H027/5 STD 0.25 0.50
MB/HL	6	53.958/53.978	59.000/59.019	18.500	2.502	0.020/0.082	AL-LF	02-3085U	

02-3085L

02-3085U

02-3086HL

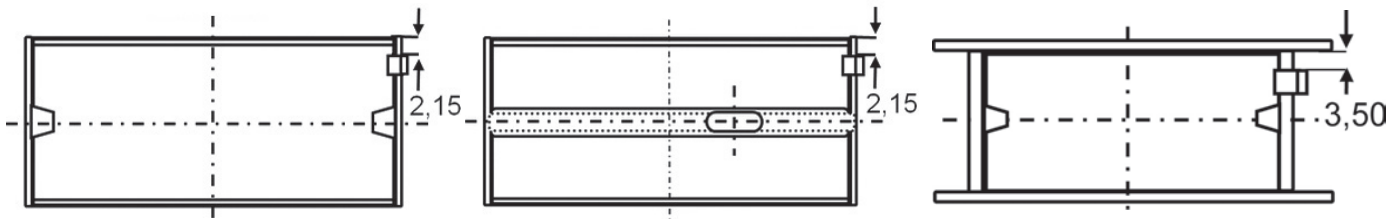

02-3086HU

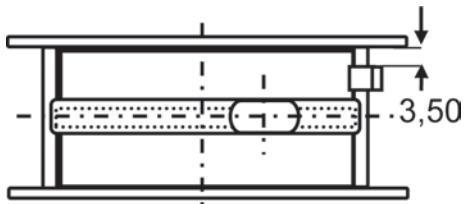

TW/A	2	59.500	73.200		1.975		AL-LF	04-3527	A123/4 STD	
TW/A	2	59.500	73.200		1.975		AL-LF	04-3528		
SE/PB	1	20.000	23.000/23.052	25.000			BC	55-3567	55-3567 SEMI	
CB/NWB 1-5	5	25.939/25.960	28.250/28.271	17.000	1.138		AL-LF	03-3317	N118/5 STD	[67]
BU	1	42.959/42.975	46.055/46.095	15.000			AL-LF	07-3088	07-3088 STD SEMI	[68]
BU	1	41.959/41.975	45.000/45.025	15.000			AL-LF	07-3089	07-3089 STD SEMI	[68]

927	81.00	Petrol				
DX	4 Cyl.	10:1	1781cc	82kW (111)PS	TD4063	404
GOLF	08/82→12/92	JETTA	08/82→02/84	SCIROCCO	08/82→12/89	

87-109400-50 [51] STD 87-109407-50 [51] [63] 0.50mm A 32.20 B- 4.40 B+ 1.30 BØ 55.70 D 62.50 20x57	08-109400-10 STD 08-109407-10 0.50mm 1.50 P PS 1.75 P 3.00 CR P	
 08130E-110		

[51] Pistons to be replaced in Engine Sets only [51] Kolben nur Motorsätzen zu ersetzen
 [63] A=31.90 D=62.20 [63] A=31.90 D=62.20

BE/PL	4	47.758/47.778	50.600/50.619	19.000	1.406	0.020/0.074	EC	71-3566	71-3566/4 STD 0.25 0.50
BE/PL	4	47.758/47.778	50.600/50.612	19.000	1.406	0.020/0.067	EC	71-3694	71-3694/4 STD 0.25 0.50
01/86 →									

71-3566

71-3694

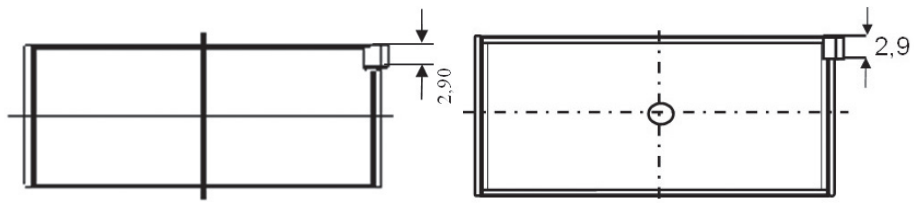

927

81.00

Petrol

MB/HL	3	53.958/53.978	59.000/59.019	18.500	2.502	0.020/0.082	AL-LF	02-3085L	H025/5 STD 0.25 0.50
MB/HL	5	53.958/53.978	59.000/59.019	18.500	2.502	0.020/0.082	AL-LF	02-3085U	
MB/HL	1	53.958/53.978	59.000/59.019	24.930	2.502	0.020/0.082	AL-LF	02-3086HL	
MB/HL	1	53.958/53.978	59.000/59.019	24.930	2.502	0.020/0.082	AL-LF	02-3086HU	
MB/HL	4	53.958/53.978	59.000/59.019	18.500	2.502	0.020/0.082	AL-LF	02-3085L	H027/5 STD 0.25 0.50
MB/HL	6	53.958/53.978	59.000/59.019	18.500	2.502	0.020/0.082	AL-LF	02-3085U	

02-3085L

02-3085U

02-3086HL

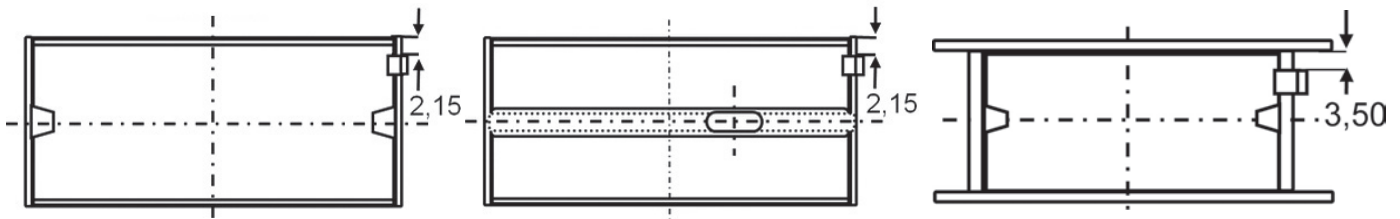

02-3086HU

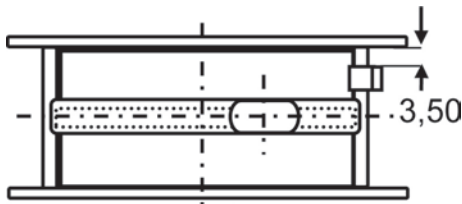



TW/A	2	59.500	73.200		1.975		AL-LF	04-3527	A123/4 STD
TW/A	2	59.500	73.200		1.975		AL-LF	04-3528	
SE/PB	1	20.000	23.000/23.052	25.000			BC	55-3567	55-3567 SEMI
SE/PB	1	20.000	23.000/23.021	25.000			BC	55-3698	



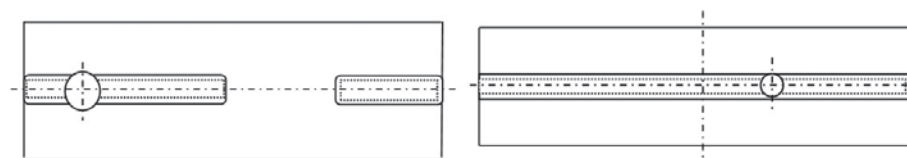

55-3567

55-3698



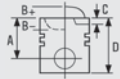

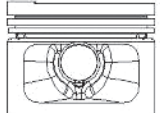
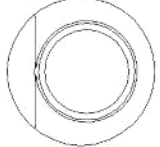



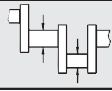

CB/NWB 1-5	5	25.939/25.960	28.250/28.271	17.000	1.138		AL-LF	03-3317	N118/5 STD	[67]
BU	1	42.959/42.975	46.055/46.095	15.000			AL-LF	07-3088	07-3088 STD SEMI	[68]
BU	1	41.959/41.975	45.000/45.025	15.000			AL-LF	07-3089	07-3089 STD SEMI	[68]

928	 81.00	Petrol				
DZ	4 Cyl.	10:1	1781cc	82kW (111)PS	TD256	405
DZ	4 Cyl.	10:1	1781cc	82kW (111)PS	TD4998	405
RG	4 Cyl.	10:1	1781cc	79kW (107)PS	TD4146	428
80	08/84→08/91	COUPE	12/84→07/91	PASSAT	12/83→03/88	

		
87-109400-50 [51] STD 87-109407-50 [51] [63] 0.50mm   08130E-110	08-109400-10 STD 08-109407-10 0.50mm  <ul style="list-style-type: none"> 1.50 P PS 1.75 P 3.00 CR P 	

[51] Pistons to be replaced in Engine Sets only [51] Kolben nur Motorsätzen zu ersetzen
 [63] A=31.90 D=62.20 [63] A=31.90 D=62.20

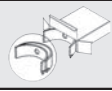
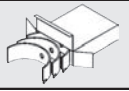
									
BE/PL	4	47.758/47.778	50.600/50.612	19.000	1.406	0.020/0.067	EC	71-3694	71-3694/4 STD 0.25 0.50
MB/HL	3	53.958/53.978	59.000/59.019	18.500	2.502	0.020/0.082	AL-LF	02-3085L	H025/5 STD 0.25 0.50
MB/HL	5	53.958/53.978	59.000/59.019	18.500	2.502	0.020/0.082	AL-LF	02-3085U	
MB/HL	1	53.958/53.978	59.000/59.019	24.930	2.502	0.020/0.082	AL-LF	02-3086HL	
MB/HL	1	53.958/53.978	59.000/59.019	24.930	2.502	0.020/0.082	AL-LF	02-3086HU	
MB/HL	4	53.958/53.978	59.000/59.019	18.500	2.502	0.020/0.082	AL-LF	02-3085L	H027/5 STD 0.25 0.50
MB/HL	6	53.958/53.978	59.000/59.019	18.500	2.502	0.020/0.082	AL-LF	02-3085U	

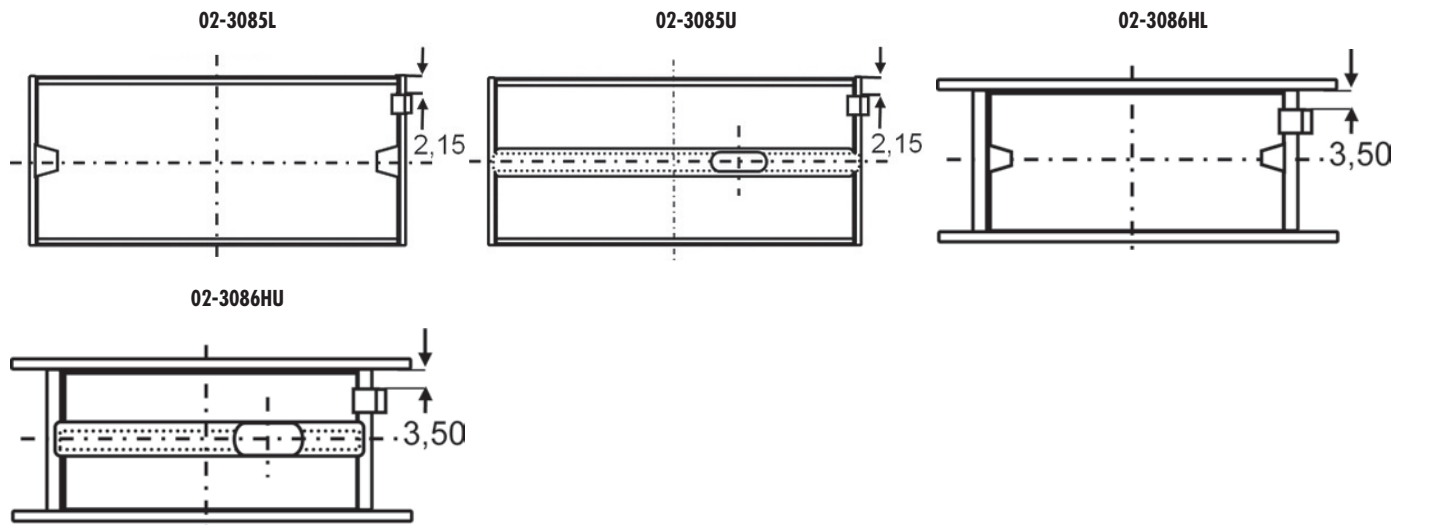

928		81.00		Petrol						
TW/A	2	59.500	73.200		1.975		AL-LF	04-3527	A123/4 STD	
TW/A	2	59.500	73.200		1.975		AL-LF	04-3528		
SE/PB	1	20.000	23.000/23.052	25.000			BC	55-3567	55-3567 SEMI	
BU	1	42.959/42.975	46.055/46.095	15.000			AL-LF	07-3088	07-3088 STD SEMI [68]	
BU	1	41.959/41.975	45.000/45.025	15.000			AL-LF	07-3089	07-3089 STD SEMI [68]	

929		81.00		Petrol						
EV	4 Cyl.	10:1	1781cc	82kW (111)PS				TD4069	406	
GX	4 Cyl.	10:1	1781cc	66kW (89)PS				TD4100	408	
KT	4 Cyl.	10:1	1781cc	82kW (111)PS				TD4124	418	
FOX	10/90→12/95	GOLF		08/82→10/91	JETTA		01/84→10/91			
SCIROCCO	08/82→12/89									

87-109400-50 [51] STD		87-109407-50 [51] [63] 0.50mm		08-109400-10 STD		08-109407-10 0.50mm			
A	32.20	B-	4.40	B+	1.30	BØ	55.70	D	62.50
08130E-110		08130E-110		08130E-110		08130E-110		08130E-110	
1.50		1.75		3.00		P PS		P	
						CR P			





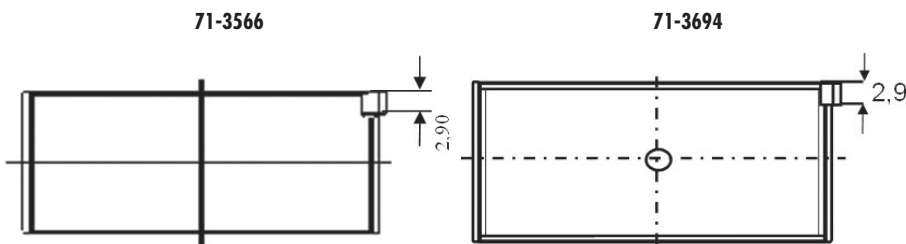



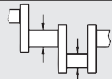

[51] Pistons to be replaced in Engine Sets only [51] Kolben nur Motorsätzen zu ersetzen
 [63] A=31.90 D=62.20 [63] A=31.90 D=62.20

71-3566		71-3694	
BE/PL	4	47.758/47.778	50.600/50.619
BE/PL	4	47.758/47.778	50.600/50.612
01/86→			



...Continued

929  **81.00** **Petrol**

									
MB/HL	3	53.958/53.978	59.000/59.019	18.500	2.502	0.020/0.082	AL-LF	02-3085L	H025/5 STD 0.25 0.50
MB/HL	5	53.958/53.978	59.000/59.019	18.500	2.502	0.020/0.082	AL-LF	02-3085U	
MB/HL	1	53.958/53.978	59.000/59.019	24.930	2.502	0.020/0.082	AL-LF	02-3086HL	
MB/HL	1	53.958/53.978	59.000/59.019	24.930	2.502	0.020/0.082	AL-LF	02-3086HU	H027/5 STD 0.25 0.50
MB/HL	4	53.958/53.978	59.000/59.019	18.500	2.502	0.020/0.082	AL-LF	02-3085L	
MB/HL	6	53.958/53.978	59.000/59.019	18.500	2.502	0.020/0.082	AL-LF	02-3085U	

02-3085L

02-3085U

02-3086HL

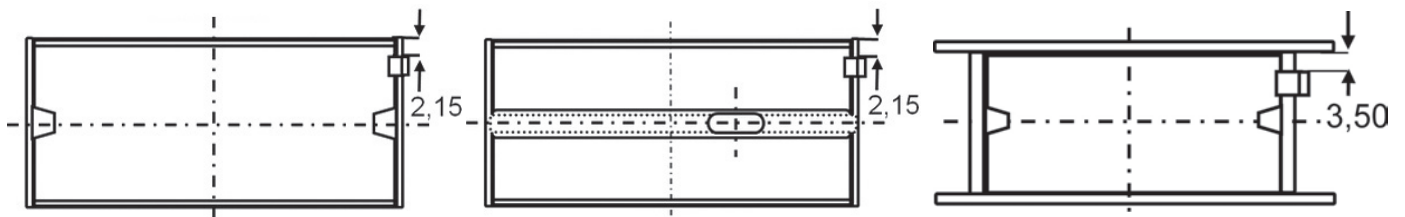

02-3086HU

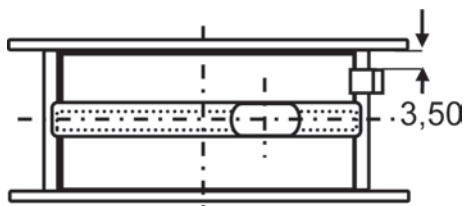

TW/A	2	59.500	73.200		1.975		AL-LF	04-3527	A123/4 STD	
TW/A	2	59.500	73.200		1.975		AL-LF	04-3528		
SE/PB	1	20.000	23.000/23.052	25.000			BC	55-3567	55-3567 SEMI	
BU	1	42.959/42.975	46.055/46.095	15.000			AL-LF	07-3088	07-3088 STD SEMI	[68]
BU	1	41.959/41.975	45.000/45.025	15.000			AL-LF	07-3089	07-3089 STD SEMI	[68]

930

81.00

Petrol



EX	4 Cyl.	10:1	1781cc	66kW (89)PS	TD5000	407
GU	4 Cyl.	9/10:1	1781cc	66kW (89)PS	TD5007	296
JH	4 Cyl.	8.5:1	1781cc	70kW (95)PS	TD4117	412

CADDY	08/85→07/92	GOLF	08/83→04/93	JETTA	08/84→10/91
PARATI	08/87→07/94	SCIROCCO	08/83→07/92		

87-109400-50 [51] STD 87-109407-50 [51] [63] 0.50mm	 08130E-110	08-109400-10 STD 08-109407-10 0.50mm 1.50 P PS 1.75 P 3.00 CR P

[51] Pistons to be replaced in Engine Sets only [51] Kolben nur Motorsätzen zu ersetzen
 [63] A=31.90 D=62.20 [63] A=31.90 D=62.20

BE/PL	4	47.758/47.778	50.600/50.619	19.000	1.406	0.020/0.074	EC	71-3566	71-3566/4 STD 0.25 0.50
BE/PL	4	47.758/47.778	50.600/50.612	19.000	1.406	0.020/0.067	EC	71-3694	71-3694/4 STD 0.25 0.50

01/86→





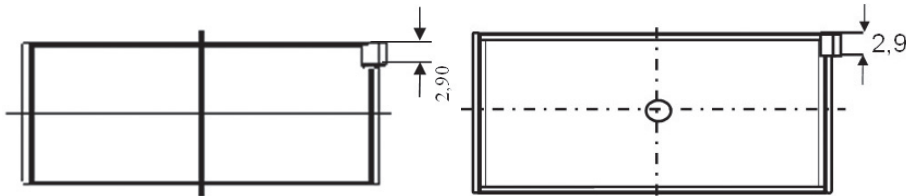



71-3566

71-3694

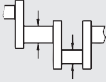
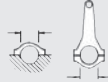

...Continued

930  **81.00** **Petrol**

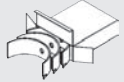
									
MB/HL	3	53.958/53.978	59.000/59.019	18.500	2.502	0.020/0.082	AL-LF	02-3085L	H025/5 STD 0.25 0.50
MB/HL	5	53.958/53.978	59.000/59.019	18.500	2.502	0.020/0.082	AL-LF	02-3085U	
MB/HL	1	53.958/53.978	59.000/59.019	24.930	2.502	0.020/0.082	AL-LF	02-3086HL	H027/5 STD 0.25 0.50
MB/HL	1	53.958/53.978	59.000/59.019	24.930	2.502	0.020/0.082	AL-LF	02-3086HU	
MB/HL	4	53.958/53.978	59.000/59.019	18.500	2.502	0.020/0.082	AL-LF	02-3085L	
MB/HL	6	53.958/53.978	59.000/59.019	18.500	2.502	0.020/0.082	AL-LF	02-3085U	

02-3085L

02-3085U

02-3086HL

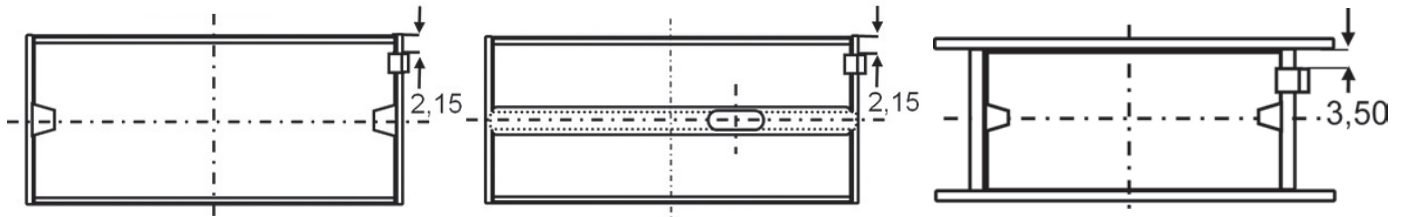

02-3086HU

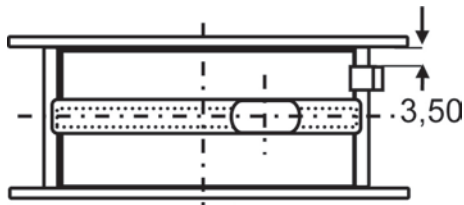

TW/A	2	59.500	73.200	1.975	AL-LF	04-3527	A123/4 STD
TW/A	2	59.500	73.200	1.975	AL-LF	04-3528	
SE/PB	1	20.000	23.000/23.052	25.000	BC	55-3567	55-3567 SEMI
SE/PB	1	20.000	23.000/23.021	25.000	BC	55-3698	

55-3567

55-3698

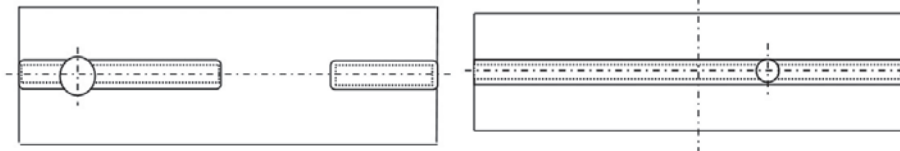

BU	1	42.959/42.975	46.055/46.095	15.000	AL-LF	07-3088	07-3088 STD SEMI	[68]
BU	1	41.959/41.975	45.000/45.025	15.000	AL-LF	07-3089	07-3089 STD SEMI	[68]

931

 81.00

Petrol



JW 4 Cyl. 1781cc 66kW (89)PS TD279 416

100 08/83→07/89

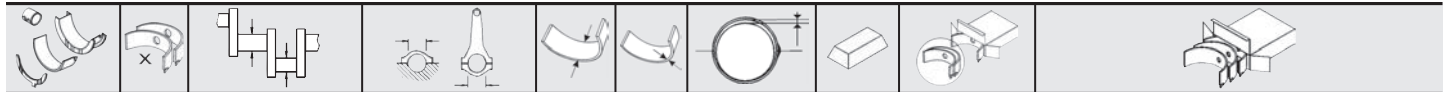

BE/PL	4	47.758/47.778	50.600/50.619	19.000	1.406	0.020/0.074	EC	71-3566	71-3566/4 STD 0.25 0.50
-------	---	---------------	---------------	--------	-------	-------------	----	---------	-----------------------------------

→12/85

BE/PL	4	47.758/47.778	50.600/50.612	19.000	1.406	0.020/0.067	EC	71-3694	71-3694/4 STD 0.25 0.50
-------	---	---------------	---------------	--------	-------	-------------	----	---------	-----------------------------------

01/86→

71-3566

71-3694

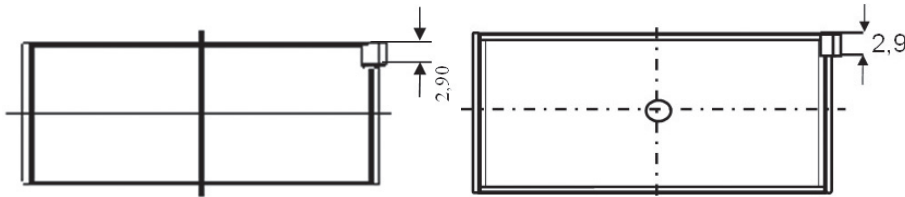

MB/HL	3	53.958/53.978	59.000/59.019	18.500	2.502	0.020/0.082	AL-LF	02-3085L	H025/5 STD 0.25 0.50
MB/HL	5	53.958/53.978	59.000/59.019	18.500	2.502	0.020/0.082	AL-LF	02-3085U	
MB/HL	1	53.958/53.978	59.000/59.019	24.930	2.502	0.020/0.082	AL-LF	02-3086HL	
MB/HL	1	53.958/53.978	59.000/59.019	24.930	2.502	0.020/0.082	AL-LF	02-3086HU	
MB/HL	4	53.958/53.978	59.000/59.019	18.500	2.502	0.020/0.082	AL-LF	02-3085L	H027/5 STD 0.25 0.50
MB/HL	6	53.958/53.978	59.000/59.019	18.500	2.502	0.020/0.082	AL-LF	02-3085U	

02-3085L

02-3085U

02-3086HL

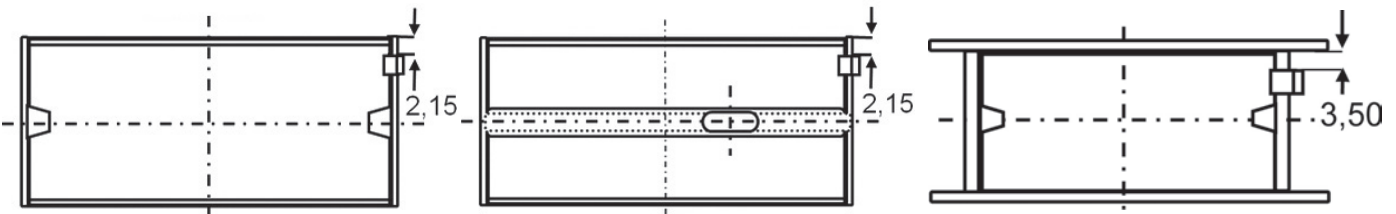

02-3086HU

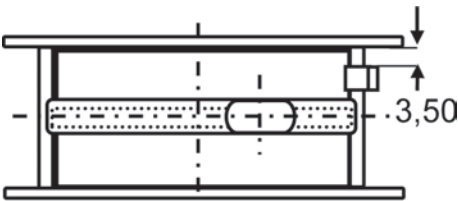

TW/A	2	59.500	73.200		1.975		AL-LF	04-3527	A123/4 STD
TW/A	2	59.500	73.200		1.975		AL-LF	04-3528	
SE/PB	1	20.000	23.000/23.052	25.000			BC	55-3567	55-3567 SEMI
CB/NWB 1-5	5	25.939/25.960	28.250/28.271	17.000	1.138		AL-LF	03-3317	N118/5 STD [67]
BU	1	42.959/42.975	46.055/46.095	15.000			AL-LF	07-3088	07-3088 STD SEMI [68]
BU	1	41.959/41.975	45.000/45.025	15.000			AL-LF	07-3089	07-3089 STD SEMI [68]

932

81.00

Petrol



KR	4 Cyl.	10:1	1781cc	98kW (133)PS	TD3591	417
KR	4 Cyl.	10:1	1781cc	98kW (133)PS	TD5019	417

CORRADO	04/89→07/92	GOLF	02/86→06/90	JETTA	06/87→12/89
PASSAT	04/88→09/93	SCIROCCO	10/85→07/89	TOLEDO	05/91→03/99

<p>08-109400-10 STD 08-109407-10 0.50mm</p> <p>1.50 P PS 1.75 P 3.00 CR P</p>		

BE/PL	4	47.758/47.778	50.600/50.612	19.000	1.406	0.020/0.067	EC	71-3694	71-3694/4 STD 0.25 0.50
MB/HL	3	53.958/53.978	59.000/59.019	18.500	2.502	0.020/0.082	AL-LF	02-3085L	H025/5 STD 0.25 0.50
MB/HL	5	53.958/53.978	59.000/59.019	18.500	2.502	0.020/0.082	AL-LF	02-3085U	
MB/HL	1	53.958/53.978	59.000/59.019	24.930	2.502	0.020/0.082	AL-LF	02-3086HL	
MB/HL	1	53.958/53.978	59.000/59.019	24.930	2.502	0.020/0.082	AL-LF	02-3086HU	
MB/HL	4	53.958/53.978	59.000/59.019	18.500	2.502	0.020/0.082	AL-LF	02-3085L	H027/5 STD 0.25 0.50
MB/HL	6	53.958/53.978	59.000/59.019	18.500	2.502	0.020/0.082	AL-LF	02-3085U	

02-3085L





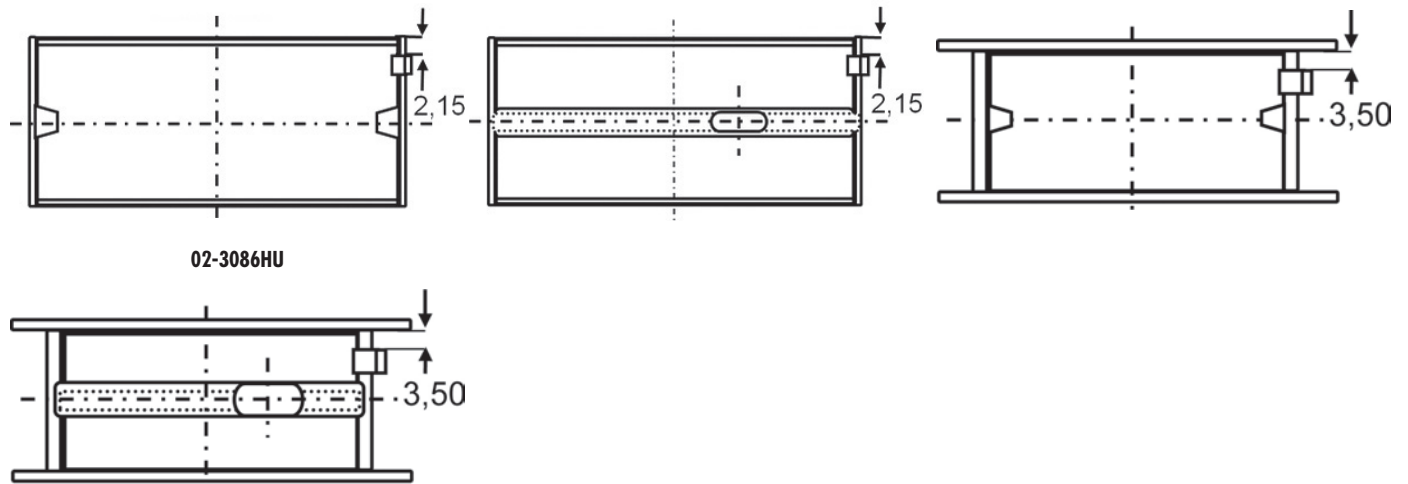



02-3085U

02-3086HL

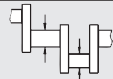

02-3086HU

932  **81.00** **Petrol**

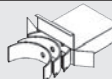
									
TW/A	2	59.500	73.200		1.975		AL-LF	04-3527	A123/4 STD
TW/A	2	59.500	73.200		1.975		AL-LF	04-3528	
SE/PB	1	20.000	23.000/23.052	25.000			BC	55-3567	55-3567 SEMI
SE/PB	1	20.000	23.000/23.021	25.000			BC	55-3698	

55-3567



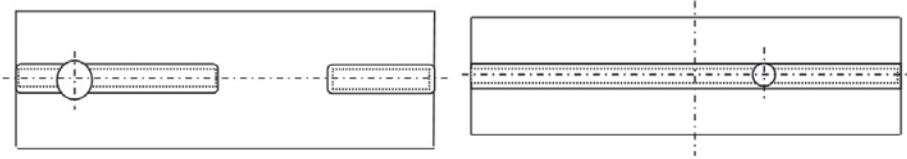





55-3698

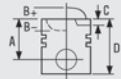

BU	1	42.959/42.975	46.055/46.095	15.000		AL-LF	07-3088	07-3088 STD SEMI	[68]
BU	1	41.959/41.975	45.000/45.025	15.000		AL-LF	07-3089	07-3089 STD SEMI	[68]

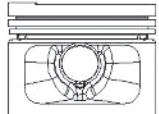
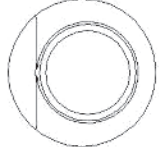
933  **81.00** **Petrol** 







PB	4 Cyl.	10:1	1781cc	82kW (111)PS	TD9367	421
GOLF	08/82→10/91	JETTA	01/84→10/91	PASSAT	04/88→07/92	
SCIROCCO	08/82→12/89					

		
87-109400-50 [51] STD 87-109407-50 [51] [63] 0.50mm A 32.20 B- 4.40 B+ 1.30 BØ 55.70 D 62.50  20x57   08130E-110	08-109400-10 STD 08-109407-10 0.50mm 1.50  PPS 1.75  P 3.00  CR P	

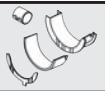
[51] Pistons to be replaced in Engine Sets only [51] Kolben nur Motorsätzen zu ersetzen
 [63] A=31.90 D=62.20 [63] A=31.90 D=62.20

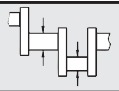
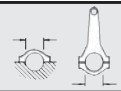
...Continued

933  **81.00** **Petrol**

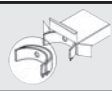
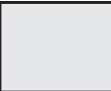
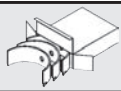
										
BE/PL	4	47.758/47.778	50.600/50.619	19.000	1.406	0.020/0.074	EC	71-3566	71-3566/4 STD 0.25 0.50	
→12/85										
BE/PL	4	47.758/47.778	50.600/50.612	19.000	1.406	0.020/0.067	EC	71-3694	71-3694/4 STD 0.25 0.50	
01/86→										

71-3566

71-3694

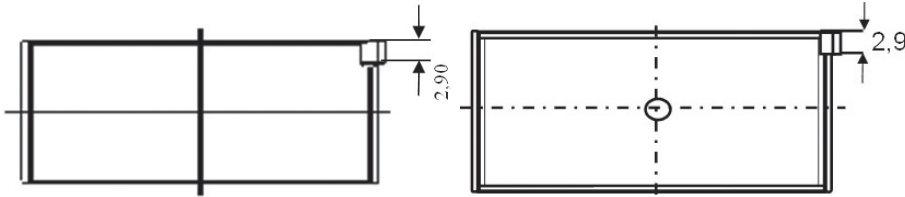

MB/HL	4	53.958/53.978	59.000/59.019	18.500	2.502	0.020/0.082	AL-LF	02-3085L	H027/5 STD 0.25 0.50
MB/HL	6	53.958/53.978	59.000/59.019	18.500	2.502	0.020/0.082	AL-LF	02-3085U	
MB/HL 1-5	5	53.958/53.978	59.000/59.019	18.500	2.502	0.020/0.082	AL-LF	02-3085L	H084/5 STD 0.25 0.50
MB/HL 1-5	5	53.958/53.978	59.000/59.019	18.500	2.502	0.020/0.082	AL-LF	02-3085U	

02-3085L

02-3085U

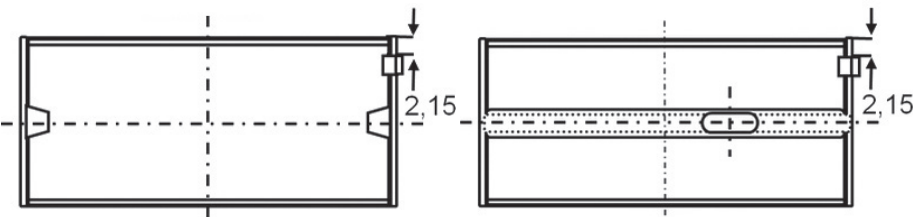

TW/A	2	59.500	73.200		1.975		AL-LF	04-3527	A123/4 STD
TW/A	2	59.500	73.200		1.975		AL-LF	04-3528	
SE/PB	1	20.000	23.000/23.052	25.000			BC	55-3567	55-3567 SEMI
SE/PB	1	20.000	23.000/23.021	25.000			BC	55-3698	

55-3567

55-3698

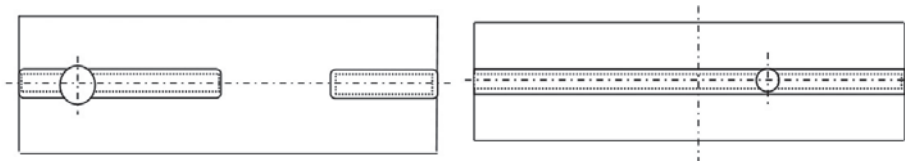

CB/NWB 1-5	5	25.939/25.960	28.250/28.271	17.000	1.138		AL-LF	03-3317	N118/5 STD	[67]
BU	1	42.959/42.975	46.055/46.095	15.000			AL-LF	07-3088	07-3088 STD SEMI	[68]
BU	1	41.959/41.975	45.000/45.025	15.000			AL-LF	07-3089	07-3089 STD SEMI	[68]

934	81.00	Petrol				
PD	4 Cyl.	9/10:1	1781cc	49kW (67)PS	TD4138	422
TRANSPORTER 12/90→07/92						

	08-502000-00 STD	
	1.75 CR P	
	2.00 P	
	3.00 CR[52]	

[52] Steel [52] Stahl







935	81.00	Petrol				
PF	4 Cyl.	9/10:1	1781cc	79kW (107)PS	TD4139	423
GOLF	01/87→10/91	JETTA	01/87→10/91	PASSAT	04/88→07/93	

87-109400-50 [51] STD	08-109400-10 STD	
87-109407-50 [51] [63] 0.50mm	08-109407-10 0.50mm	
A 32.20	1.50 P PS	
B- 4.40	1.75 P	
B+ 1.30	3.00 CR P	
BØ 55.70		
D 62.50		
20x57		
 08130E-110		

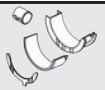
[51] Pistons to be replaced in Engine Sets only [51] Kolben nur Motorsätzen zu ersetzen
 [63] A=31.90 D=62.20 [63] A=31.90 D=62.20

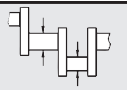
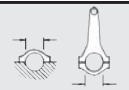
...Continued

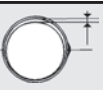
935  **81.00** **Petrol**

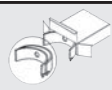
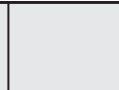
									
BE/PL	4	47.758/47.778	50.600/50.612	19.000	1.406	0.020/0.067	EC	71-3694	71-3694/4 STD 0.25 0.50
MB/HL	4	53.958/53.978	59.000/59.019	18.500	2.502	0.020/0.082	AL-LF	02-3085L	H027/5 STD 0.25 0.50
MB/HL	6	53.958/53.978	59.000/59.019	18.500	2.502	0.020/0.082	AL-LF	02-3085U	
TW/A	2	59.500	73.200		1.975		AL-LF	04-3527	A123/4 STD
TW/A	2	59.500	73.200		1.975		AL-LF	04-3528	
SE/PB	1	20.000	23.000/23.052	25.000			BC	55-3567	55-3567 SEMI
SE/PB	1	20.000	23.000/23.021	25.000			BC	55-3698	55-3698 SEMI

55-3567



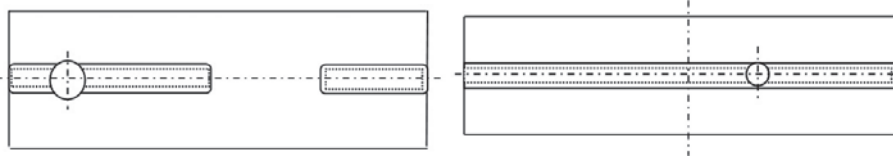



55-3698



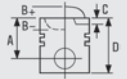









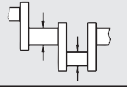
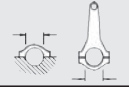

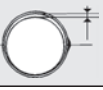



BU	1	42.959/42.975	46.055/46.095	15.000			AL-LF	07-3088	07-3088 STD SEMI	[68]
BU	1	41.959/41.975	45.000/45.025	15.000			AL-LF	07-3089	07-3089 STD SEMI	[68]

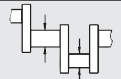

936  **81.00** **Petrol**





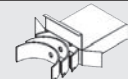

PG	4 Cyl.	1781cc	118kW (160)PS	TD4140	424
CORRADO	09/88→09/93	GOLF	08/88→07/91	PASSAT	08/88→05/97

		
	<p>08-109400-10 STD</p> <p>08-109407-10 0.50mm</p> <p>1.50  P PS</p> <p>1.75  P</p> <p>3.00  CR P</p>	

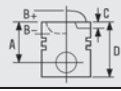





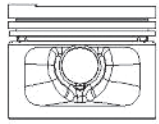
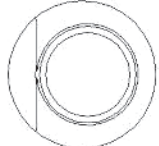

									
BE/PL	4	47.758/47.778	50.600/50.612	19.000	1.406	0.020/0.067	EC	71-3694	71-3694/4 STD 0.25 0.50
MB/HL	4	53.958/53.978	59.000/59.019	18.500	2.502	0.020/0.082	AL-LF	02-3085L	H027/5 STD 0.25 0.50
MB/HL	6	53.958/53.978	59.000/59.019	18.500	2.502	0.020/0.082	AL-LF	02-3085U	
TW/A	2	59.500	73.200		1.975		AL-LF	04-3527	A123/4 STD
TW/A	2	59.500	73.200		1.975		AL-LF	04-3528	

936		 81.00	Petrol							
										
BU	1	42.959/42.975	46.055/46.095	15.000			AL-LF	07-3088	07-3088 STD SEMI	[68]
BU	1	41.959/41.975	45.000/45.025	15.000			AL-LF	07-3089	07-3089 STD SEMI	[68]

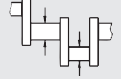
937		 81.00	Petrol							
PH	4 Cyl.	1781cc	66kW (89)PS				TD305		425	
100	03/85→11/90									

		
87-109400-50 [51] STD 87-109407-50 [51][63] 0.50mm	08-109400-10 STD 08-109407-10 0.50mm	
A 32.20 B- 4.40 B+ 1.30 BØ 55.70 D 62.50  20x57	1.50  P PS 1.75  P 3.00  CR P	
		
		
08130E-110		

[51] Pistons to be replaced in Engine Sets only [51] Kolben nur Motorsätzen zu ersetzen
 [63] A=31.90 D=62.20 [63] A=31.90 D=62.20

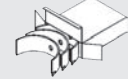
										
BE/PL	4	47.758/47.778	50.600/50.619	19.000	1.406	0.020/0.074	EC	71-3566	71-3566/4 STD 0.25 0.50	
→12/85										
BE/PL	4	47.758/47.778	50.600/50.612	19.000	1.406	0.020/0.067	EC	71-3694	71-3694/4 STD 0.25 0.50	
01/86→										





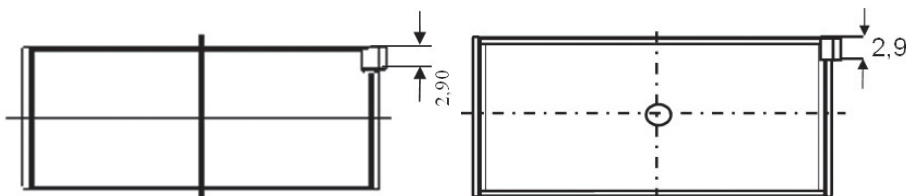



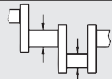

71-3566

71-3694





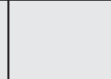





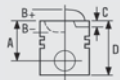





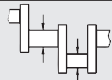

MB/HL	4	53.958/53.978	59.000/59.019	18.500	2.502	0.020/0.082	AL-LF	02-3085L	H027/5 STD 0.25 0.50	
MB/HL	6	53.958/53.978	59.000/59.019	18.500	2.502	0.020/0.082	AL-LF	02-3085U		
TW/A	2	59.500	73.200		1.975		AL-LF	04-3527	A123/4 STD	
TW/A	2	59.500	73.200		1.975		AL-LF	04-3528		
SE/PB	1	20.000	23.000/23.052	25.000			BC	55-3567	55-3567 SEMI	
CB/NWB 1-5	5	25.939/25.960	28.250/28.271	17.000	1.138		AL-LF	03-3317	N118/5 STD	[67]

...Continued

937		 81.00	Petrol							
										
BU	1	42.959/42.975	46.055/46.095	15.000			AL-LF	07-3088	07-3088 STD SEMI	[68]
BU	1	41.959/41.975	45.000/45.025	15.000			AL-LF	07-3089	07-3089 STD SEMI	[68]

938		 81.00	Petrol								
PL	4 Cyl.	10:1	1781cc	95kW (129)PS						TD3595	417
PL	4 Cyl.	10:1	1781cc	95kW (129)PS						TD5021	417
GOLF	02/86→10/91	JETTA		08/86→10/91	SCIROCCO		03/86→07/92				
TOLEDO	05/91→03/99										

		
<p>08-109400-10 STD 08-109407-10 0.50mm</p> <p>1.50  P PS 1.75  P 3.00  CR P</p>		







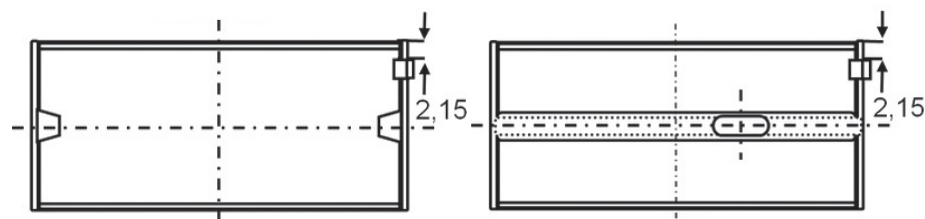

										
BE/PL	4	47.758/47.778	50.600/50.612	19.000	1.406	0.020/0.067	EC	71-3694	71-3694/4 STD 0.25 0.50	
MB/HL	4	53.958/53.978	59.000/59.019	18.500	2.502	0.020/0.082	AL-LF	02-3085L	H027/5 STD 0.25 0.50	
MB/HL	6	53.958/53.978	59.000/59.019	18.500	2.502	0.020/0.082	AL-LF	02-3085U		
MB/HL 1-5	5	53.958/53.978	59.000/59.019	18.500	2.502	0.020/0.082	AL-LF	02-3085L	H084/5 STD 0.25 0.50	
MB/HL 1-5	5	53.958/53.978	59.000/59.019	18.500	2.502	0.020/0.082	AL-LF	02-3085U		

02-3085L

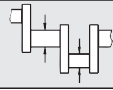
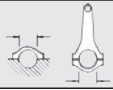
02-3085U

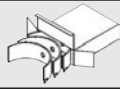

938  **81.00** **Petrol**

									
TW/A	2	59.500	73.200		1.975		AL-LF	04-3527	A123/4 STD
TW/A	2	59.500	73.200		1.975		AL-LF	04-3528	
SE/PB	1	20.000	23.000/23.052	25.000			BC	55-3567	55-3567 SEMI
SE/PB	1	20.000	23.000/23.021	25.000			BC	55-3698	55-3698 SEMI

55-3567



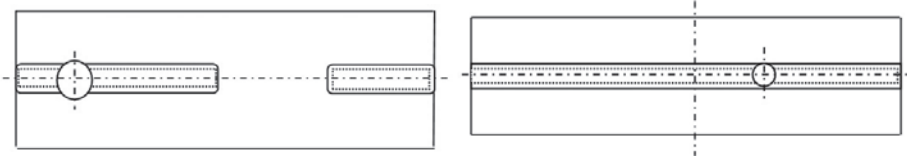



55-3698



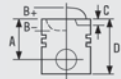







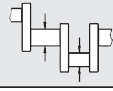
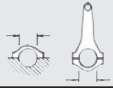

BU	1	42.959/42.975	46.055/46.095	15.000			AL-LF	07-3088	07-3088 STD SEMI	[68]
BU	1	41.959/41.975	45.000/45.025	15.000			AL-LF	07-3089	07-3089 STD SEMI	[68]





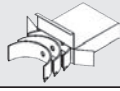

939  **81.00** **Petrol** 

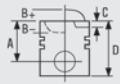

PM	4 Cyl.	1781cc	66kW (89)PS	TD306	414
SH	4 Cyl.	1781cc	65kW (88)PS	TD326	416
80	09/86→10/91	100	02/86→07/90		







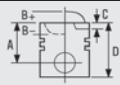

		
	08-109400-10 STD 08-109407-10 0.50mm 1.50  P PS 1.75  P 3.00  CR P	

										
BE/PL	4	47.758/47.778	50.600/50.612	19.000	1.406	0.020/0.067	EC	71-3694	71-3694/4 STD 0.25 0.50	
MB/HL	4	53.958/53.978	59.000/59.019	18.500	2.502	0.020/0.082	AL-LF	02-3085L	H027/5 STD 0.25 0.50	
MB/HL	6	53.958/53.978	59.000/59.019	18.500	2.502	0.020/0.082	AL-LF	02-3085U		
TW/A	2	59.500	73.200		1.975		AL-LF	04-3527	A123/4 STD	
TW/A	2	59.500	73.200		1.975		AL-LF	04-3528		
SE/PB	1	20.000	23.000/23.052	25.000			BC	55-3567	55-3567 SEMI	
BU	1	42.959/42.975	46.055/46.095	15.000			AL-LF	07-3088	07-3088 STD SEMI	[68]
BU	1	41.959/41.975	45.000/45.025	15.000			AL-LF	07-3089	07-3089 STD SEMI	[68]



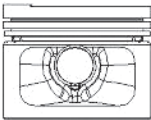
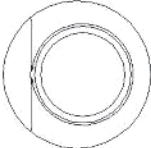





940	 81.00	Petrol				
RD	4 Cyl.	10:1	1781cc	79kW (107)PS	TD4143	427
GOLF	08/85→10/87	JETTA	08/85→10/87			

		
	08-109700-00 STD 08-109705-00 0.25mm 08-109707-00 0.50mm 1.50  CR P 1.75  P 3.00  CR P	

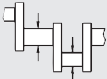
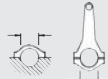
941	 81.00	Petrol				
RH	4 Cyl.	9/10:1	1781cc	62kW (84)PS	TD5026	429
GOLF	08/86→01/90	JETTA	08/86→01/90			

		
87-109400-50 [51] STD 87-109407-50 [51] [63] 0.50mm A 32.20 B- 4.40 B+ 1.30 BØ 55.70 D 62.50  20x57   08130E-110	08-109400-10 STD 08-109407-10 0.50mm 1.50  P PS 1.75  P 3.00  CR P	

[51] Pistons to be replaced in Engine Sets only [51] Kolben nur Motorsätzen zu ersetzen
 [63] A=31.90 D=62.20 [63] A=31.90 D=62.20

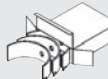





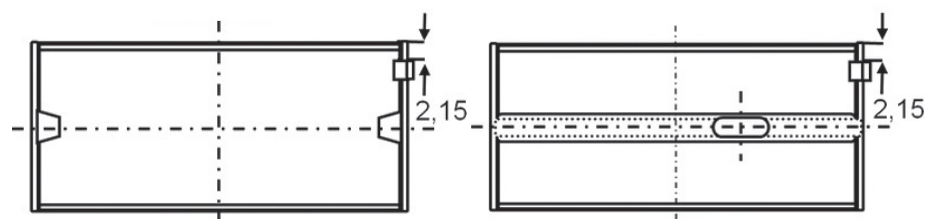

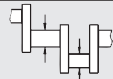

									
BE/PL	4	47.758/47.778	50.600/50.612	19.000	1.406	0.020/0.067	EC	71-3694	71-3694/4 STD 0.25 0.50
MB/HL	4	53.958/53.978	59.000/59.019	18.500	2.502	0.020/0.082	AL-LF	02-3085L	H027/5 STD 0.25 0.50
MB/HL	6	53.958/53.978	59.000/59.019	18.500	2.502	0.020/0.082	AL-LF	02-3085U	
MB/HL 1-5	5	53.958/53.978	59.000/59.019	18.500	2.502	0.020/0.082	AL-LF	02-3085L	H084/5 STD 0.25 0.50
MB/HL 1-5	5	53.958/53.978	59.000/59.019	18.500	2.502	0.020/0.082	AL-LF	02-3085U	

02-3085L

02-3085U

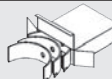

941  **81.00** **Petrol**

										
TW/A	2	59.500	73.200		1.975		AL-LF	04-3527	A123/4 STD	
TW/A	2	59.500	73.200		1.975		AL-LF	04-3528		
SE/PB	1	20.000	23.000/23.052	25.000			BC	55-3567	55-3567 SEMI	
SE/PB	1	20.000	23.000/23.021	25.000			BC	55-3698	55-3698 SEMI	

55-3567



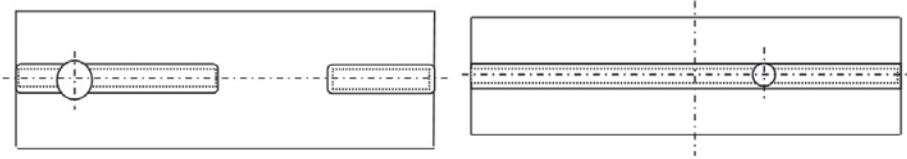



55-3698



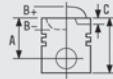







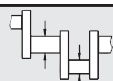

BU	1	42.959/42.975	46.055/46.095	15.000			AL-LF	07-3088	07-3088 STD SEMI	[68]
BU	1	41.959/41.975	45.000/45.025	15.000			AL-LF	07-3089	07-3089 STD SEMI	[68]

942  **81.00** **Petrol** 

RM	4 Cyl.	10:1	1781cc	64kW (87)PS	TD4149	430
GOL	05/84→09/94	LOGUS	10/93→09/94	PARATI	08/91→07/94	
PASSAT	05/86→03/88	POINTER	10/93→09/94	VOYAGE	05/84→09/88	

		
	08-109700-00 STD 08-109705-00 0.25mm 08-109707-00 0.50mm 1.50  CR P 1.75  P 3.00  CR P	

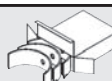
										
MB/HL	4	53.958/53.978	59.000/59.019	18.500	2.502	0.020/0.082	AL-LF	02-3085L	H027/5 STD 0.25 0.50	
MB/HL	6	53.958/53.978	59.000/59.019	18.500	2.502	0.020/0.082	AL-LF	02-3085U		
SE/PB	1	20.000	23.000/23.052	25.000			BC	55-3567	55-3567 SEMI	
BU	1	42.959/42.975	46.055/46.095	15.000			AL-LF	07-3088	07-3088 STD SEMI	[68]
BU	1	41.959/41.975	45.000/45.025	15.000			AL-LF	07-3089	07-3089 STD SEMI	[68]

943	81.00	Petrol				
RP	4 Cyl.	9:1	1781cc	66kW (89)PS	TD3596	296
RP	4 Cyl.	9:1	1781cc	66kW (89)PS	TD5027	296
GOLF	08/87→10/91	JETTA	08/87→10/91	PASSAT	02/88→05/97	
TOLEDO	05/91→12/96					

87-109707-10 0.50mm		
A 31.90 B- 8.10 BØ 56.80 D 62.00 20x54	08-109700-00 STD 08-109705-00 0.25mm 08-109707-00 0.50mm 1.50 CR P 1.75 P 3.00 CR P	

BE/PL	4	47.758/47.778	50.600/50.612	19.000	1.406	0.020/0.067	EC	71-3694	71-3694/4 STD 0.25 0.50	
MB/HL	4	53.958/53.978	59.000/59.019	18.500	2.502	0.020/0.082	AL-LF	02-3085L	H027/5 STD 0.25 0.50	
MB/HL	6	53.958/53.978	59.000/59.019	18.500	2.502	0.020/0.082	AL-LF	02-3085U		
MB/HL 1-5	5	53.958/53.978	59.000/59.019	18.500	2.502	0.020/0.082	AL-LF	02-3085L	H084/5 STD 0.25 0.50	
MB/HL 1-5	5	53.958/53.978	59.000/59.019	18.500	2.502	0.020/0.082	AL-LF	02-3085U		

02-3085L

02-3085U

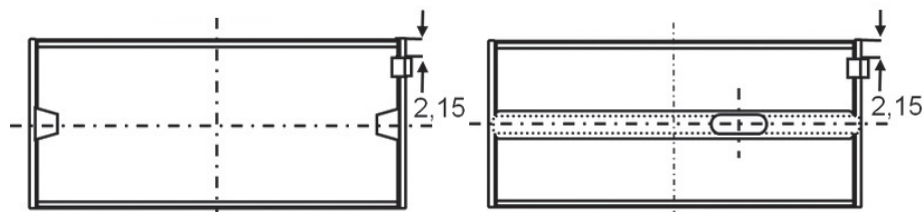







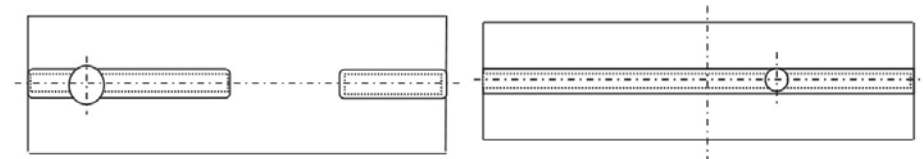

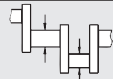
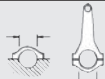

TW/A	2	59.500	73.200		1.975		AL-LF	04-3527	A123/4 STD
TW/A	2	59.500	73.200		1.975		AL-LF	04-3528	
SE/PB	1	20.000	23.000/23.052	25.000			BC	55-3567	55-3567 SEMI
SE/PB	1	20.000	23.000/23.021	25.000			BC	55-3698	55-3698 SEMI







55-3567



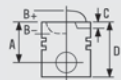







55-3698

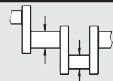

943		 81.00	Petrol							
										
BU	1	42.959/42.975	46.055/46.095	15.000			AL-LF	07-3088	07-3088 STD SEMI	[68]
BU	1	41.959/41.975	45.000/45.025	15.000			AL-LF	07-3089	07-3089 STD SEMI	[68]

944		 81.00	Petrol							
RS	4 Cyl.	1781cc	55kW (75)PS	TD317	432					
100	08/82→12/87									

										
			08-109400-10 STD							
			08-109407-10 0.50mm							
			1.50  P PS							
			1.75  P							
			3.00  CR P							



										
BE/PL	4	47.758/47.778	50.600/50.619	19.000	1.406	0.020/0.074	EC	71-3566	71-3566/4 STD 0.25 0.50	
→12/85										
BE/PL	4	47.758/47.778	50.600/50.612	19.000	1.406	0.020/0.067	EC	71-3694	71-3694/4 STD 0.25 0.50	
01/86→										



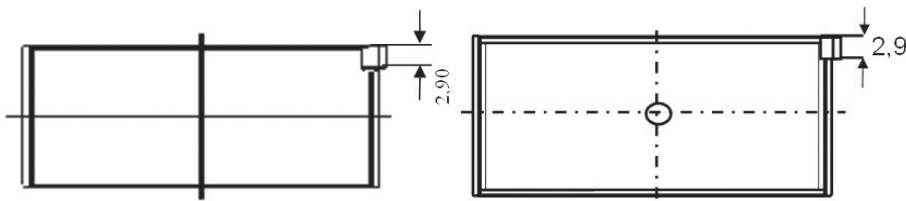



71-3566



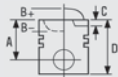





71-3694



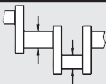
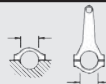







MB/HL	4	53.958/53.978	59.000/59.019	18.500	2.502	0.020/0.082	AL-LF	02-3085L	H027/5 STD 0.25 0.50	
MB/HL	6	53.958/53.978	59.000/59.019	18.500	2.502	0.020/0.082	AL-LF	02-3085U		
TW/A	2	59.500	73.200		1.975		AL-LF	04-3527	A123/4 STD	
TW/A	2	59.500	73.200		1.975		AL-LF	04-3528		
SE/PB	1	20.000	23.000/23.052	25.000			BC	55-3567	55-3567 SEMI	
CB/NWB 1-5	5	25.939/25.960	28.250/28.271	17.000	1.138		AL-LF	03-3317	N118/5 STD	[67]
BU	1	42.959/42.975	46.055/46.095	15.000			AL-LF	07-3088	07-3088 STD SEMI	[68]
BU	1	41.959/41.975	45.000/45.025	15.000			AL-LF	07-3089	07-3089 STD SEMI	[68]

945	 81.00	Petrol			
RU	4 Cyl.	1781cc	55kW (75)PS	TD320	420
SF	4 Cyl.	1781cc	64kW (87)PS	TD325	420
80	02/86→12/90	COUPE	04/86→10/88		

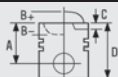
		
	08-109700-00 STD 08-109705-00 0.25mm 08-109707-00 0.50mm 1.50  CR P 1.75  P 3.00  CR P	

									
BE/PL	4	47.758/47.778	50.600/50.612	19.000	1.406	0.020/0.067	EC	71-3694	71-3694/4 STD 0.25 0.50
MB/HL	4	53.958/53.978	59.000/59.019	18.500	2.502	0.020/0.082	AL-LF	02-3085L	H027/5 STD 0.25 0.50
MB/HL	6	53.958/53.978	59.000/59.019	18.500	2.502	0.020/0.082	AL-LF	02-3085U	
TW/A	2	59.500	73.200		1.975		AL-LF	04-3527	A123/4 STD
TW/A	2	59.500	73.200		1.975		AL-LF	04-3528	
SE/PB	1	20.000	23.000/23.052	25.000			BC	55-3567	55-3567 SEMI
BU	1	42.959/42.975	46.055/46.095	15.000			AL-LF	07-3088	07-3088 STD SEMI [68]
BU	1	41.959/41.975	45.000/45.025	15.000			AL-LF	07-3089	07-3089 STD SEMI [68]

946	 81.00	Petrol				
RV	4 Cyl.	10:1	1781cc	77kW (105)PS	TD4151	423
GOLF	01/85→07/85	JETTA	01/85→07/88			

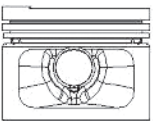
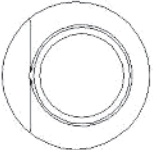
		
87-109400-50 [51] STD 87-109407-50 [51] [63] 0.50mm A 32.20 B- 4.40 B+ 1.30 BØ 55.70 D 62.50  20x57	08-109400-10 STD 08-109407-10 0.50mm 1.50  P PS 1.75  P 3.00  CR P	
		
08130E-110		

[51] Pistons to be replaced in Engine Sets only
 [63] A=31.90 D=62.20

[51] Kolben nur Motorsätzen zu ersetzen
 [63] A=31.90 D=62.20

946

81.00

Petrol

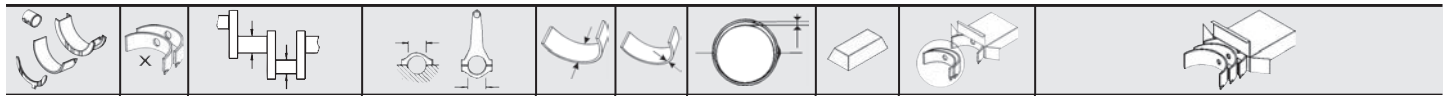

BE/PL	4	47.758/47.778	50.600/50.619	19.000	1.406	0.020/0.074	EC	71-3566	71-3566/4 STD 0.25 0.50
-------	---	---------------	---------------	--------	-------	-------------	----	---------	-----------------------------------

→12/85

BE/PL	4	47.758/47.778	50.600/50.612	19.000	1.406	0.020/0.067	EC	71-3694	71-3694/4 STD 0.25 0.50
-------	---	---------------	---------------	--------	-------	-------------	----	---------	-----------------------------------

01/86→

BE/PL	4	47.758/47.778	50.600/50.612	19.000	1.406	0.020/0.067	EC	71-3929	71-3929/4 STD
-------	---	---------------	---------------	--------	-------	-------------	----	---------	-------------------------

[66]

71-3566

71-3694

71-3929

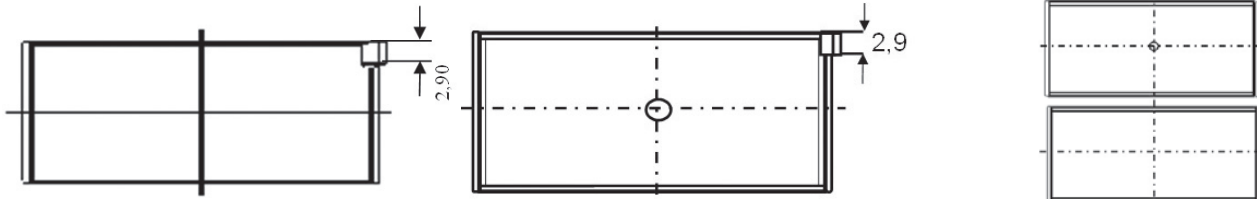

MB/HL	4	53.958/53.978	59.000/59.019	18.500	2.502	0.020/0.082	AL-LF	02-3085L	H027/5 STD 0.25 0.50
MB/HL	6	53.958/53.978	59.000/59.019	18.500	2.502	0.020/0.082	AL-LF	02-3085U	
MB/HL 1-5	5	53.958/53.978	59.000/59.019	18.500	2.502	0.020/0.082	AL-LF	02-3085L	H084/5 STD 0.25 0.50
MB/HL 1-5	5	53.958/53.978	59.000/59.019	18.500	2.502	0.020/0.082	AL-LF	02-3085U	

02-3085L

02-3085U

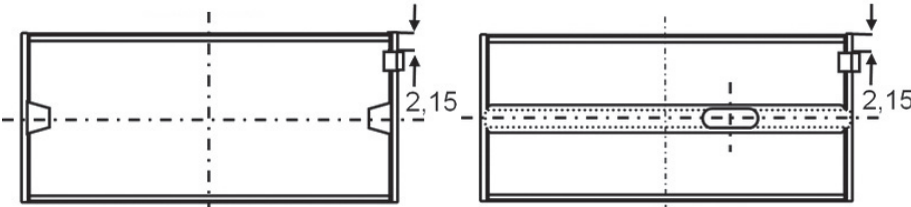

TW/A	2	59.500	73.200		1.975		AL-LF	04-3527	A123/4 STD
TW/A	2	59.500	73.200		1.975		AL-LF	04-3528	
SE/PB	1	20.000	23.000/23.052	25.000			BC	55-3567	55-3567 SEMI
SE/PB	1	20.000	23.000/23.021	25.000			BC	55-3698	

55-3567

55-3698

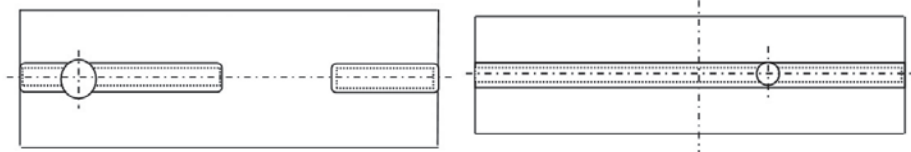

BU	1	42.959/42.975	46.055/46.095	15.000			AL-LF	07-3088	07-3088 STD SEMI	[68]
BU	1	41.959/41.975	45.000/45.025	15.000			AL-LF	07-3089	07-3089 STD SEMI	[68]

947

 **81.00**
Petrol

AAC	4 Cyl.	8.5:1	1968cc	62kW (84)PS	TD4001 434
-----	--------	-------	--------	-------------	-------------------

TRANSPORTER 07/90→04/03	VENTO	11/91→07/98
-------------------------	-------	-------------

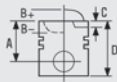







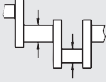
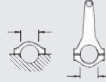

08-502000-00 STD

- 1.75 CR P
- 2.00 P
- 3.00 CR[52]

[52] Steel

[52] Stahl

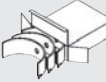
									
BE/PL	4	47.758/47.778	50.600/50.612	19.000	1.406	0.020/0.067	EC	71-3694	71-3694/4 STD 0.25 0.50
MB/HL	4	53.958/53.978	59.000/59.019	18.500	2.502	0.020/0.082	AL-LF	02-3085L	H027/5 STD 0.25 0.50
MB/HL	6	53.958/53.978	59.000/59.019	18.500	2.502	0.020/0.082	AL-LF	02-3085U	
TW/A	2	59.500	73.200		1.975		AL-LF	04-3527	A123/4 STD
TW/A	2	59.500	73.200		1.975		AL-LF	04-3528	
SE/PB	1	24.000	27.000/27.021	25.000			BC	55-3696	55-3696 SEMI

948

81.00

Diesel



AZV	4 Cyl.	18:1	1968cc	100kW (136)PS	TD16862	435
AZV	4 Cyl.	18:1	1968cc	100kW (136)PS	TD17027	435
AZV	4 Cyl.	18:1	1968cc	100kW (136)PS	TD18247	435
AZV	4 Cyl.	18:1	1968cc	100kW (136)PS	TD20909	435
BKD	4 Cyl.	18:1	1968cc	103kW (140)PS	TD17025	440
BKD	4 Cyl.	18:1	1968cc	103kW (140)PS	TD17080	440
BKD	4 Cyl.	18:1	1968cc	103kW (140)PS	TD17357	440
BKD	4 Cyl.	18:1	1968cc	103kW (140)PS	TD17500	440
BKP	4 Cyl.	18.5:1	1968cc	103kW (140)PS	TD18135	441
BLB	4 Cyl.		1968cc	103kW (140)PS	TD17377	442
BMA	4 Cyl.		1968cc	100kW (136)PS	TD18225	435
BMN	4 Cyl.	18.5:1	1968cc	125kW (170)PS	TD18471	444
BMN	4 Cyl.	18.5:1	1968cc	125kW (170)PS	TD18977	444
BMN	4 Cyl.	18.5:1	1968cc	125kW (170)PS	TD18991	444
BMN	4 Cyl.	18.5:1	1968cc	125kW (170)PS	TD20735	444
BMR	4 Cyl.		1968cc	125kW (170)PS	TD18188	446
BNA	4 Cyl.		1968cc	100kW (136)PS	TD18009	447
BRE	4 Cyl.		1968cc	103kW (140)PS	TD18029	451
BRF	4 Cyl.		1968cc	100kW (136)PS	TD18748	447
BVA	4 Cyl.	18:1	1968cc	120kW (163)PS	TD20529	457
BVD	4 Cyl.		1968cc	90kW (122)PS	TD18542	562
BVE	4 Cyl.		1968cc	90kW (122)PS	TD18543	446

A3	05/03→	A4	11/04→06/08	A6	07/04→08/11
ALTEA	03/04→	ALTEA XL	10/06→	GOLF	10/03→
JETTA	08/05→10/10	LEON	07/05→	OCTAVIA	02/04→
PASSAT	03/05→	SUPERB	01/09→	TOLEDO	04/04→05/09
TOURAN	02/03→05/10				

87-139500-00 [47] STD 87-139507-00 [33] 0.50mm	08-139500-00 STD 08-139507-00 0.50mm	
A 45.83 B- 17.80 BØ 38.00 D 68.80 26x66 AK KK NB RT TP	1.75 CK P 2.00 P 3.00 CR P	
07901J		

[33] A = 45.550, D = 68.550

[33] A = 45.550, D = 68.550

[47] Piston Chamber Volume [ccm] 23.75

[47] Volumen der Kolbenmulde [ccm] 23.75

BE/PL	1	50.858/50.878	53.700/53.712	20.400	1.403	0.020/0.073	SP	71-3930	71-3930 STD 0.25 0.50	[64]
MB/HL 1-5	5	53.958/53.978	59.000/59.012	18.500	2.501	0.020/0.076	EC	72-3931	H079/5 STD 0.25 0.50	
TW/A	2	59.500	73.200		1.975		AL-LF	04-3527	A123/4 STD	
TW/A	2	59.500	73.200		1.975		AL-LF	04-3528		

949

81.00

Diesel



BDJ	4 Cyl.	1968cc	51kW (70)PS	TD17358	436
CADDY 03/04→08/10					

<p>87-139500-30 [49] [55] STD 87-139507-30 [55] 0.50mm</p> <p>A 37.80 B- 17.35 BØ 38.00 C 0.70 D 58.80 22x60</p> <p>AK RT TP</p> <p style="text-align: center;">08102-205</p>	<p>08-139500-00 STD 08-139507-00 0.50mm</p> <p>1.75 CK P 2.00 P 3.00 CR P</p>	
<p>87-139500-40 [49] [59] STD 87-139507-40 [59] 0.50mm</p> <p>A 37.80 B- 17.35 BØ 38.00 C 0.70 D 58.80 22x60</p> <p>AK RT TP</p> <p style="text-align: center;">08102-206</p>	<p>08-139500-00 STD 08-139507-00 0.50mm</p> <p>1.75 CK P 2.00 P 3.00 CR P</p>	

[49] Piston Chamber Volume [ccm] 24.50 [49] Volumen der Kolbenmulde [ccm] 24.50
 [55] To cylinder 1-2 [55] Zum Zylinder 1-2
 [59] To cylinder 3-4 [59] Zum Zylinder 3-4

BE/PL	1	47.758/47.778	50.600/50.612	20.000	1.406	0.020/0.067	SP	71-3904	71-3904 STD 0.25 0.50	[64]
MB/HL 1-5	5	53.958/53.978	59.000/59.012	18.500	2.501	0.020/0.076	EC	72-3931	H079/5 STD 0.25 0.50	
TW/A	2	59.500	73.200		1.975		AL-LF	04-3527	A123/4 STD	
TW/A	2	59.500	73.200		1.975		AL-LF	04-3528		

950	81.00	Diesel	
BDK	4 Cyl.	1968cc	55kW (75)PS
GOLF	01/04 → 11/08		TD17359 437

87-139500-30 [49] [55] STD 87-139507-30 [55] 0.50mm A 37.80 B- 17.35 BØ 38.00 C 0.70 D 58.80 22x60 AK RT TP 08102-205	08-139500-00 STD 08-139507-00 0.50mm 1.75 CK P 2.00 P 3.00 CR P	
87-139500-40 [49] [59] STD 87-139507-40 [59] 0.50mm A 37.80 B- 17.35 BØ 38.00 C 0.70 D 58.80 22x60 AK RT TP 08102-206	08-139500-00 STD 08-139507-00 0.50mm 1.75 CK P 2.00 P 3.00 CR P	

[49] Piston Chamber Volume [ccm] 24.50 [49] Volumen der Kolbenmulde [ccm] 24.50
 [55] To cylinder 1-2 [55] Zum Zylinder 1-2
 [59] To cylinder 3-4 [59] Zum Zylinder 3-4

MB/HL 1-5	5	53.958/53.978	59.000/59.012	18.500	2.501	0.020/0.076	EC	72-3931	H079/5 STD 0.25 0.50
TW/A	2	59.500	73.200		1.975		AL-LF	04-3527	A123/4 STD
TW/A	2	59.500	73.200		1.975		AL-LF	04-3528	
CB/NWB 1-5	5	28.947/28.960	32.000/32.025	25.000	1.513	0.020/0.068	EC	73-3903	N147/5 STD

951	81.00	Diesel	
BEE	4 Cyl.	18:1	96kW (131)PS
GOLF	05/05 → 05/07		TD24836 438

	08-432300-00 STD 1.75 GDC P 2.00 P 3.00 CR P 	

952

81.00

Diesel



BGW 4 Cyl. 18.5:1 1968cc 100kW (136)PS TD18539 439

PASSAT 12/03→05/05

<p>87-139500-10 [44] [55] STD 87-139507-10 [55] 0.50mm</p> <p>A 45.83 B- 17.50 BØ 38.00 C 0.70 D 68.80 26x66</p> <p>AK KK NB RT TP</p> <p style="text-align: center;">07901D833</p>	<p>08-139500-00 STD 08-139507-00 0.50mm</p> <p>1.75 CK P 2.00 P 3.00 CR P</p>	
<p>87-139500-20 [44] [59] STD 87-139507-20 [59] 0.50mm</p> <p>A 45.83 B- 17.50 BØ 38.00 C 0.70 D 68.80 26x66</p> <p>AK KK NB RT TP</p> <p style="text-align: center;">07901D834</p>	<p>08-139500-00 STD 08-139507-00 0.50mm</p> <p>1.75 CK P 2.00 P 3.00 CR P</p>	

[44] Piston Chamber Volume [ccm] 23.30

[44] Volumen der Kolbenmulde [ccm] 23.30

[55] To cylinder 1-2

[55] Zum Zylinder 1-2

[59] To cylinder 3-4

[59] Zum Zylinder 3-4

BE/PL	1	50.858/50.878	53.700/53.712	20.400	1.403	0.020/0.073	SP	71-3930	71-3930 STD 0.25 0.50	[64]
MB/HL 1-5	5	53.958/53.978	59.000/59.012	18.500	2.501	0.020/0.076	EC	72-3931	H079/5 STD 0.25 0.50	
TW/A	2	59.500	73.200		1.975		AL-LF	04-3527	A123/4 STD	
TW/A	2	59.500	73.200		1.975		AL-LF	04-3528		
SE/PB	1	26.000	29.000/29.052	25.000			BC	55-3729	55-3729 SEMI	

953

81.00
Diesel

BHW	4 Cyl.	18.5:1	1968cc	100kW (136)PS	TD22177	439
------------	--------	--------	--------	----------------------	----------------	------------

PASSAT 12/03→05/05

BE/PL	1	50.858/50.878	53.700/53.712	20.400	1.403	0.020/0.073	SP	71-3930	71-3930 STD 0.25 0.50	[64]
MB/HL 1-5	5	53.958/53.978	59.000/59.012	18.500	2.501	0.020/0.076	EC	72-3931	H079/5 STD 0.25 0.50	
TW/A	2	59.500	73.200		1.975		AL-LF	04-3527	A123/4 STD	
TW/A	2	59.500	73.200		1.975		AL-LF	04-3528		
SE/PB	1	26.000	29.000/29.052	25.000			BC	55-3729	55-3729 SEMI	

954

81.00
Diesel

BMM	4 Cyl.	18:1	1968cc	103kW (140)PS	TD18203	443
BMM	4 Cyl.	18:1	1968cc	103kW (140)PS	TD18269	443
BMM	4 Cyl.	18:1	1968cc	103kW (140)PS	TD18482	443
BMM	4 Cyl.	18:1	1968cc	103kW (140)PS	TD19315	443
BMP	4 Cyl.	18.5:1	1968cc	103kW (140)PS	TD18136	445
BMP	4 Cyl.	18.5:1	1968cc	103kW (140)PS	TD20945	445
BPW	4 Cyl.		1968cc	103kW (140)PS	TD18010	448
BRT	4 Cyl.	18.5:1	1968cc	103kW (140)PS	TD19105	452
BRT	4 Cyl.	18.5:1	1968cc	103kW (140)PS	TD19388	452

A3	06/05→06/08	A4	11/04→03/09	ALHAMBRA	11/05→03/10
ALTEA	11/05→	ALTEA XL	10/06→	CADDY	09/07→08/10
EOS	06/06→05/08	GOLF	08/04→	JETTA	10/05→10/10
LEON	10/05→	OCTAVIA	11/05→	PASSAT	03/05→
SHARAN	11/05→03/10	SUPERB	03/08→	TOLEDO	11/05→05/09
TOURAN	12/05→05/10				

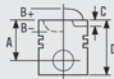
87-139500-10 [44] [55] STD
87-139507-10 [55] 0.50mm



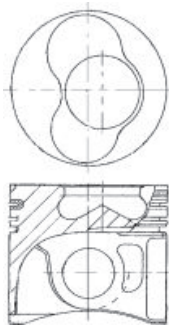



A 45.83
 B- 17.50
 BØ 38.00
 C 0.70
 D 68.80
 26x66

AK KK NB RT TP

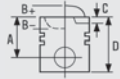
08-139500-00 STD
08-139507-00 0.50mm





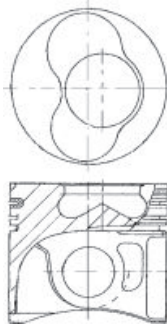

1.75 CK P
 2.00 P
 3.00 CR P

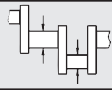
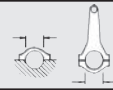

...Continued

954  **81.00** **Diesel**



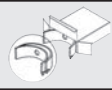
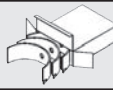





		
<p>87-139500-20 [44] [59] STD 87-139507-20 [59] 0.50mm</p> <p>A 45.83 B- 17.50 BØ 38.00 C 0.70 D 68.80  26x66</p> <p>AK KK NB RT TP</p>	<p>08-139500-00 STD 08-139507-00 0.50mm</p> <p>1.75  CK P 2.00  P 3.00  CR P</p>	
 <p>07901D834</p>		

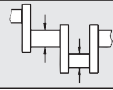

[44] Piston Chamber Volume [ccm] 23.30 [44] Volumen der Kolbenmulde [ccm] 23.30
 [55] To cylinder 1-2 [55] Zum Zylinder 1-2
 [59] To cylinder 3-4 [59] Zum Zylinder 3-4

										
BE/PL	1	50.858/50.878	53.700/53.712	20.400	1.403	0.020/0.073	SP	71-3930	71-3930 STD 0.25 0.50	[64]
MB/HL 1-5	5	53.958/53.978	59.000/59.012	18.500	2.501	0.020/0.076	EC	72-3931	H079/5 STD 0.25 0.50	
TW/A	2	59.500	73.200		1.975		AL-LF	04-3527	A123/4 STD	
TW/A	2	59.500	73.200		1.975		AL-LF	04-3528		



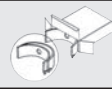
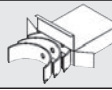



955		 81.00		Diesel					
BRC	4 Cyl.	18:1	1968cc	100kW (136)PS		TD20672	449		
BVH	4 Cyl.		1968cc	100kW (136)PS		TD20520	459		
CAGC	4 Cyl.	16.5:1	1968cc	88kW (120)PS		TD21118	463		
CAGC	4 Cyl.	16.5:1	1968cc	88kW (120)PS		TD22669	463		
CBBA	4 Cyl.		1968cc	120kW (163)PS		TD21661	462		
CBEA	4 Cyl.	18:1	1968cc	103kW (140)PS		TD22176	468		
CFHD	4 Cyl.	16.5:1	1968cc	105kW (143)PS		TD23582	473		
CFHD	4 Cyl.	16.5:1	1968cc	105kW (143)PS		TD24939			
CGLA	4 Cyl.		1968cc	120kW (163)PS		TD24406			
CGLB	4 Cyl.		1968cc	125kW (170)PS		TD24948			
CGLC	4 Cyl.		1968cc	130kW (177)PS		TD24870			
CGLD	4 Cyl.		1968cc	120kW (163)PS		TD24943			
CJCA	4 Cyl.		1968cc	105kW (143)PS		TD24949	475		
CJCB	4 Cyl.		1968cc	100kW (136)PS		TD24941			
CMEA	4 Cyl.		1968cc	105kW (143)PS		TD23939	462		
CMGB	4 Cyl.		1968cc	130kW (177)PS		TD24871			

A1	09/11→	A4	01/06→	A4 Allroad	04/09→
A5	08/08→	A6	03/11→	EXEO	12/08→
IBIZA	01/10→	PASSAT CC	05/08→11/08	Q5	11/08→
SHARAN	11/05→03/10	TIGUAN	02/08→08/09		

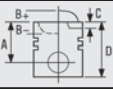
									
BE/PL	1	50.858/50.878	53.700/53.712	20.400	1.403	0.020/0.073	SP	71-3930	71-3930 STD 0.25 0.50
MB/HL 1-5	5	53.958/53.978	59.000/59.012	18.500	2.501	0.020/0.076	EC	72-3931	H079/5 STD 0.25 0.50
TW/A	2	59.500	73.200		1.975		AL-LF	04-3527	A123/4 STD
TW/A	2	59.500	73.200		1.975		AL-LF	04-3528	

956		 81.00		Diesel					
BRD	4 Cyl.		1968cc	125kW (170)PS		TD20402	450		
BUY	4 Cyl.		1968cc	120kW (163)PS		TD20403	455		
BUZ	4 Cyl.	18.5:1	1968cc	120kW (163)PS		TD20499	456		
BVF	4 Cyl.	18:1	1968cc	93kW (126)PS		TD20497			
BVG	4 Cyl.	18:1	1968cc	89kW (121)PS		TD20496	458		
BWV	4 Cyl.	18.5:1	1968cc	88kW (120)PS		TD20498	460		

A3	06/06→06/08	A4	09/05→06/08	A6	09/05→06/06
PASSAT	08/05→				

		
	08-139500-00 STD 08-139507-00 0.50mm	
	1.75  CK P 2.00  P 3.00  CR P	

...Continued

956		81.00		Diesel						
BE/PL	1	50.858/50.878	53.700/53.712	20.400	1.403	0.020/0.073	SP	71-3930	71-3930 STD 0.25 0.50	[64]
MB/HL 1-5	5	53.958/53.978	59.000/59.012	18.500	2.501	0.020/0.076	EC	72-3931	H079/5 STD 0.25 0.50	
TW/A	2	59.500	73.200		1.975		AL-LF	04-3527	A123/4 STD	
TW/A	2	59.500	73.200		1.975		AL-LF	04-3528		

957		81.00		Diesel					
BSS	4 Cyl.	18.5:1	1968cc	103kW (140)PS				TD19317	454
SUPERB		10/05→03/08							

87-139500-10 [44] [55] STD	87-139507-10 [55] 0.50mm		08-139500-00 STD	08-139507-00 0.50mm	
A 45.83			1.75	CK P	
B- 17.50			2.00	P	
BØ 38.00			3.00	CR P	
C 0.70					
D 68.80					
	26x66				
AK KK NB RT TP		07901D833			
87-139500-20 [44] [59] STD	87-139507-20 [59] 0.50mm		08-139500-00 STD	08-139507-00 0.50mm	
A 45.83			1.75	CK P	
B- 17.50			2.00	P	
BØ 38.00			3.00	CR P	
C 0.70					
D 68.80					
	26x66				
AK KK NB RT TP		07901D834			

[44] Piston Chamber Volume [ccm] 23.30









[44] Volumen der Kolbenmulde [ccm] 23.30

[55] To cylinder 1-2

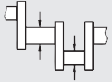
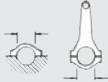





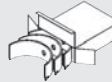

[55] Zum Zylinder 1-2

[59] To cylinder 3-4

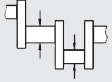
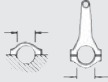
[59] Zum Zylinder 3-4

957		 81.00	Diesel							
										
BE/PL	1	50.858/50.878	53.700/53.712	20.400	1.403	0.020/0.073	SP	71-3930	71-3930 STD 0.25 0.50	[64]
MB/HL 1-5	5	53.958/53.978	59.000/59.012	18.500	2.501	0.020/0.076	EC	72-3931	H079/5 STD 0.25 0.50	
TW/A	2	59.500	73.200		1.975		AL-LF	04-3527	A123/4 STD	
TW/A	2	59.500	73.200		1.975		AL-LF	04-3528		
CB/NWB 1-5	5	28.947/28.960	32.000/32.025	25.000	1.513	0.020/0.068	EC	73-3903	N147/5 STD	
BU	1	42.959/42.975	46.055/46.095	15.000			AL-LF	07-3088	07-3088 STD SEMI	[68]
BU	1	41.959/41.975	45.000/45.025	15.000			AL-LF	07-3089	07-3089 STD SEMI	[68]

958		 81.00	Diesel							
BST	4 Cyl.	19:1	1968cc	51kW (70)PS		TD20501		436		
CADDY	03/04 → 08/10									

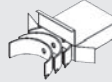
										
BE/PL	1	47.758/47.778	50.600/50.612	20.000	1.406	0.020/0.067	SP	71-3904	71-3904 STD 0.25 0.50	[64]
MB/HL 1-5	5	53.958/53.978	59.000/59.012	18.500	2.501	0.020/0.076	EC	72-3931	H079/5 STD 0.25 0.50	
TW/A	2	59.500	73.200		1.975		AL-LF	04-3527	A123/4 STD	
TW/A	2	59.500	73.200		1.975		AL-LF	04-3528		

959

81.00

Diesel



CAAA Euro 5	4 Cyl.		1968cc	62kW (84)PS	TD23411	461
CAAB Euro 5	4 Cyl.		1968cc	75kW (102)PS	TD23412	462
CAAC Euro 5	4 Cyl.		1968cc	103kW (140)PS	TD23414	462
CAAE	4 Cyl.		1968cc	100kW (136)PS	TD24473	462
CCHA	4 Cyl.		1968cc	103kW (140)PS	TD24471	462
CCHB	4 Cyl.		1968cc	100kW (136)PS	TD24474	462
CDBA	4 Cyl.		1968cc	90kW (122)PS	TD24402	
CDCA	4 Cyl.		1968cc	120kW (163)PS	TD24403	
CFCA Euro 5	4 Cyl.		1968cc	132kW (180)PS	TD23421	462
CFHE	4 Cyl.	16.5:1	1968cc	62kW (84)PS	TD25438	
CJAA	4 Cyl.		1968cc	103kW (140)PS	TD23179	474
CLLA	4 Cyl.	16.5:1	1968cc	125kW (170)PS	TD24441	

AMAROK	09/10→	BEETLE	04/11→	CADDY	11/10→
CC	11/11→	GOLF	10/08→	JETTA	08/05→
MULTIVAN	09/09→	PASSAT	08/10→	PASSAT CC	06/08→
TRANSPORTER	09/09→				

BE/PL	1	50.858/50.878	53.700/53.712	20.400	1.403	0.020/0.073	SP	71-3930	71-3930 STD 0.25 0.50
MB/HL 1-5	5	53.958/53.978	59.000/59.012	18.500	2.501	0.020/0.076	EC	72-3931	H079/5 STD 0.25 0.50
MB/HL 2-5	4	53.958/53.978	59.000/59.019	18.500	2.502	0.020/0.082	AL-LF	02-3085L	H1328/5 STD
MB/HL 2-5	4	53.958/53.978	59.000/59.019	18.500	2.502	0.020/0.082	AL-LF	02-3085U	
MB/HL 1	1	53.958/53.978	59.000/59.012	18.500	2.506	0.020/0.062	IX-LF	02-4941L	
MB/HL 1	1	53.958/53.978	59.000/59.012	18.500	2.506	0.020/0.062	IX-LF	02-4941U	

12/11→

72-3931

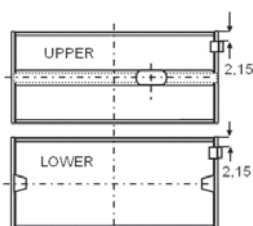

02-3085L

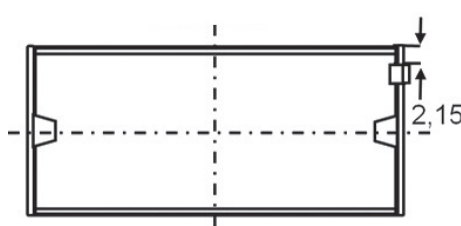

02-3085U

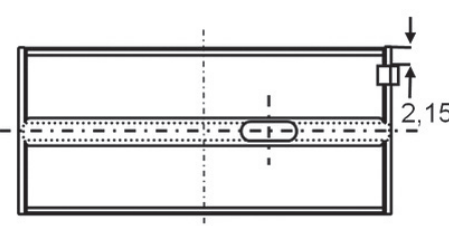

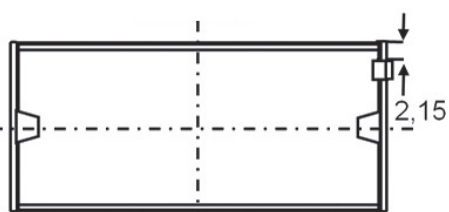

02-4941L



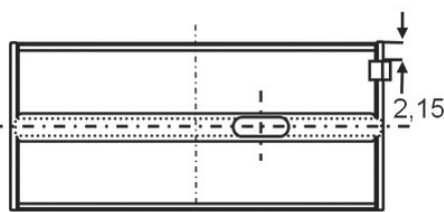







02-4941U

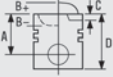

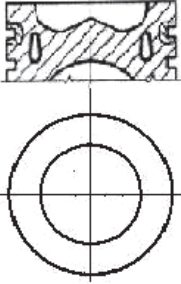







TW/A	2	59.500	73.200		1.975	AL-LF	04-3527	A123/4 STD
TW/A	2	59.500	73.200		1.975	AL-LF	04-3528	

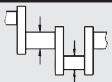

960	 81.00	Diesel			
CAGA	4 Cyl.	16.5:1	1968cc	105kW (143)PS	TD20597 463
CAGA	4 Cyl.	16.5:1	1968cc	105kW (143)PS	TD22243 463
CAGB	4 Cyl.		1968cc	100kW (136)PS	TD20598 464
CAHA	4 Cyl.	16.5:1	1968cc	125kW (170)PS	TD20602 463
CAHA	4 Cyl.	16.5:1	1968cc	125kW (170)PS	TD22244 463
CAHB	4 Cyl.		1968cc	120kW (163)PS	TD20864 462
CBAA	4 Cyl.	16:1	1968cc	100kW (136)PS	TD20798 465
CBAA	4 Cyl.	16:1	1968cc	100kW (136)PS	TD20825 465
CBAB	4 Cyl.	16:1	1968cc	103kW (140)PS	TD20799 462
CBAB	4 Cyl.	16:1	1968cc	103kW (140)PS	TD20828 462
CBAC	4 Cyl.	16:1	1968cc	105kW (143)PS	TD20800 466
CBDA	4 Cyl.	16:1	1968cc	100kW (136)PS	TD22715 467
CBDC	4 Cyl.	16:1	1968cc	81kW (110)PS	TD21109 462

A3	05/03 →	A4	11/07 →	A4 Allroad	04/09 →
A5	08/08 →	A6	07/04 → 08/11	EOS	05/08 →
EXEO	12/08 →	GOLF	10/03 →	JETTA	09/05 → 10/10
PASSAT	03/05 →	PASSAT CC	06/08 →	Q5	11/08 →
TIGUAN	09/07 →				



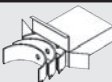



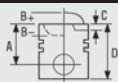

		
87-432300-00 [39] STD  A 45.80 B- 12.70 BØ 50.88 D 68.80  26x66 HA KK NB RT TP	08-432300-00 STD  1.75  GDC P 2.00  P 3.00  CR P 	

[39] OE 03L 107 065G, Gen 1 engine only [39] OE 03L 107 065G, nur für Motoren der Generation 1

									
BE/PL	1	50.858/50.878	53.700/53.712	20.400	1.403	0.020/0.073	SP	71-3930	71-3930 STD 0.25 0.50 [64]
MB/HL 1-5	5	53.958/53.978	59.000/59.012	18.500	2.501	0.020/0.076	EC	72-3931	H079/5 STD 0.25 0.50
TW/A	2	59.500	73.200		1.975		AL-LF	04-3527	A123/4 STD
TW/A	2	59.500	73.200		1.975		AL-LF	04-3528	

961		 81.00	Diesel			
CBBB	4 Cyl.	16:1	1968cc	125kW (170)PS	TD20939	462
CBBB	4 Cyl.	16:1	1968cc	125kW (170)PS	TD20944	462
CBBB	4 Cyl.	16:1	1968cc	125kW (170)PS	TD20949	462
CBDB	4 Cyl.	16:1	1968cc	103kW (140)PS	TD21070	463
CBDB	4 Cyl.	16:1	1968cc	103kW (140)PS	TD23586	463
CBDB	4 Cyl.	16:1	1968cc	103kW (140)PS	TD24327	463
CEGA	4 Cyl.	16:1	1968cc	125kW (170)PS	TD20905	463
CEGA	4 Cyl.	16:1	1968cc	125kW (170)PS	TD22674	463
CEGA	4 Cyl.	16:1	1968cc	125kW (170)PS	TD24125	463

A3	03/06→	ALTEA	03/06→	ALTEA XL	06/07→
GOLF	01/05→	JETTA	08/05→10/10	LEON	05/06→
OCTAVIA	04/06→	PASSAT	08/05→	PASSAT CC	06/08→
SCIROCCO	08/08→	SUPERB	07/08→	TIGUAN	09/07→
TOLEDO	01/06→05/09	TT	06/08→	YETI	05/09→

		
87-432300-00 [39] STD A 45.80 B- 12.70 BØ 50.88 D 68.80  26x66 HA KK NB RT TP	08-432300-00 STD 1.75  GDC P 2.00  P 3.00  CR P 	









[39] OE 03L 107 065G, Gen 1 engine only

[39] OE 03L 107 065G, nur für Motoren der Generation 1

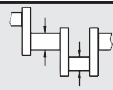
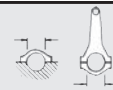
961

 81.00

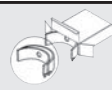
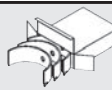
Diesel

										
BE/PL	1	50.858/50.878	53.700/53.712	20.400	1.403	0.020/0.073	SP	71-3930	71-3930 STD 0.25 0.50	[64]
MB/HL 1-5	5	53.958/53.978	59.000/59.012	18.500	2.501	0.020/0.076	EC	72-3931	H079/5 STD 0.25 0.50	
MB/HL 2-5	4	53.958/53.978	59.000/59.019	18.500	2.502	0.020/0.082	AL-LF	02-3085L	H1328/5 STD	
MB/HL 2-5	4	53.958/53.978	59.000/59.019	18.500	2.502	0.020/0.082	AL-LF	02-3085U		
MB/HL 1	1	53.958/53.978	59.000/59.012	18.500	2.506	0.020/0.062	IX-LF	02-4941L		
MB/HL 1	1	53.958/53.978	59.000/59.012	18.500	2.506	0.020/0.062	IX-LF	02-4941U		

12/11 →

72-3931

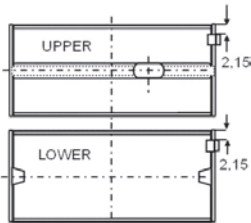

02-3085L

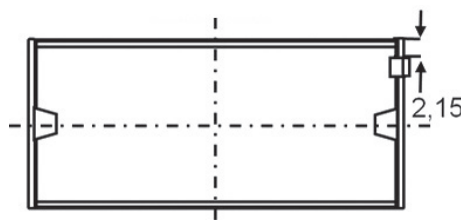

02-3085U

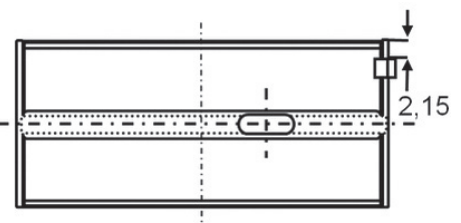

02-4941L

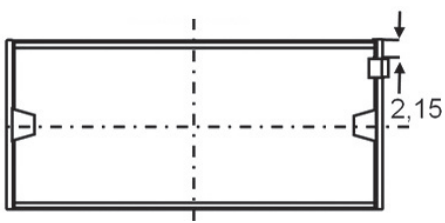

02-4941U

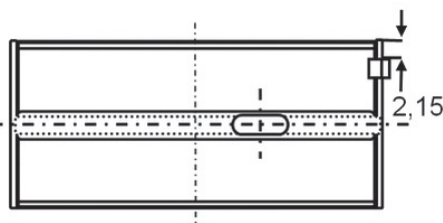

TW/A	2	59.500	73.200	1.975	AL-LF	04-3527	A123/4 STD
TW/A	2	59.500	73.200	1.975	AL-LF	04-3528	

962

 81.00









Diesel



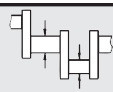
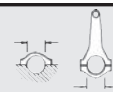

CBHA	4 Cyl.	1968cc	47kW (64)PS	TD22527	470
CBJB	4 Cyl.	1968cc	55kW (75)PS	TD22525	469
CBKA	4 Cyl.	1968cc	74kW (100)PS	TD22528	471
CFHA	4 Cyl.	16.5:1 1968cc	81kW (110)PS	TD23584	466

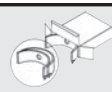
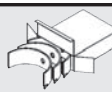





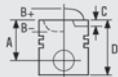

YETI

11/09 →

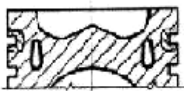
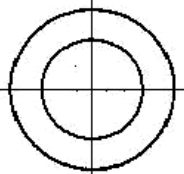
										
BE/PL	1	50.858/50.878	53.700/53.712	20.400	1.403	0.020/0.073	SP	71-3930	71-3930 STD 0.25 0.50	[64]
MB/HL 1-5	5	53.958/53.978	59.000/59.012	18.500	2.501	0.020/0.076	EC	72-3931	H079/5 STD 0.25 0.50	
TW/A	2	59.500	73.200	1.975	AL-LF	04-3527	A123/4 STD			
TW/A	2	59.500	73.200	1.975	AL-LF	04-3528				
CB/NWB 1-5	5	28.947/28.960	32.000/32.025	25.000	1.513	0.020/0.068	EC	73-3903	N147/5 STD	

963	 81.00	Diesel			
CFFA	4 Cyl.	16.5:1	1968cc	100kW (136)PS	TD23312 472
CFFA	4 Cyl.	16.5:1	1968cc	100kW (136)PS	TD23858 472
CFFA	4 Cyl.	16.5:1	1968cc	100kW (136)PS	TD25404 472
CFFB	4 Cyl.	16.5:1	1968cc	103kW (140)PS	TD23178 463
CFFB	4 Cyl.	16.5:1	1968cc	103kW (140)PS	TD23589 463
CFFB	4 Cyl.	16.5:1	1968cc	103kW (140)PS	TD23859 463
CFFB	4 Cyl.	16.5:1	1968cc	103kW (140)PS	TD24450 463
CFFD	4 Cyl.	16.5:1	1968cc	81kW (110)PS	TD24215 461
CFGB	4 Cyl.	16.5:1	1968cc	125kW (170)PS	TD23180 463
CFGB	4 Cyl.	16.5:1	1968cc	125kW (170)PS	TD23591 463
CFGB	4 Cyl.	16.5:1	1968cc	125kW (170)PS	TD23857 463
CFGB	4 Cyl.	16.5:1	1968cc	125kW (170)PS	TD24451 463
CFHB	4 Cyl.	16.5:1	1968cc	100kW (136)PS	TD24314
CFHB	4 Cyl.	16.5:1	1968cc	100kW (136)PS	TD25662
CFHC	4 Cyl.	16.5:1	1968cc	103kW (140)PS	TD23587 463
CFHC	4 Cyl.	16.5:1	1968cc	103kW (140)PS	TD24315 463
CFHC	4 Cyl.	16.5:1	1968cc	103kW (140)PS	TD24326 463
CFHF	4 Cyl.	16.5:1	1968cc	81kW (110)PS	TD23585 462
CFHF	4 Cyl.	16.5:1	1968cc	81kW (110)PS	TD24366 462
CFJA	4 Cyl.	16.5:1	1968cc	125kW (170)PS	TD23588 463
CFJA	4 Cyl.	16.5:1	1968cc	125kW (170)PS	TD24333 463
CFJA	4 Cyl.	16.5:1	1968cc	125kW (170)PS	TD24994 463
CLCA	4 Cyl.	16.5:1	1968cc	81kW (110)PS	TD24835
CLCA	4 Cyl.	16.5:1	1968cc	81kW (110)PS	TD24839
CLCB	4 Cyl.	16.5:1	1968cc	103kW (140)PS	TD24598 463
CLCB	4 Cyl.	16.5:1	1968cc	103kW (140)PS	TD24600 463
CLCB	4 Cyl.	16.5:1	1968cc	103kW (140)PS	TD25102 463
CLJA	4 Cyl.	16.5:1	1968cc	103kW (140)PS	TD23590 462
CLJA	4 Cyl.	16.5:1	1968cc	103kW (140)PS	TD23938 462
CLJA	4 Cyl.	16.5:1	1968cc	103kW (140)PS	TD24963

A1	05/12→	A3	05/03→	ALHAMBRA	06/10→
ALTEA	03/04→	ALTEA XL	10/06→	BEETLE	04/11→
CADDY	08/10→	CC	11/11→	EOS	05/08→
GOLF	01/05→	JETTA	01/10→	LEON	07/05→
OCTAVIA	02/04→	PASSAT	08/10→	PASSAT ALLTRACK	01/12→
PASSAT CC	06/08→	Q3	09/11→	SCIROCCO	08/08→
SHARAN	05/10→	SUPERB	07/08→	TIGUAN	09/07→
TOURAN	12/05→	TT	06/08→	YETI	05/09→

		
87-432300-10 [40] STD   A 45.80 B- 13.10 BØ 50.88 D 68.80  26x66 AK KK NB RT TP	08-432300-10 STD 1.75  GDC P 2.00  MO P 3.00  CR P 	

[40] OE 03L 107 065S, Gen 2 engine only

[40] OE 03L 107 065S, nur für Motoren der Generation 2

BE/PL	1	50.858/50.878	53.700/53.712	20.400	1.403	0.020/0.073	SP	71-3930	71-3930 STD 0.25 0.50	[64]
MB/HL 1-5	5	53.958/53.978	59.000/59.012	18.500	2.501	0.020/0.076	EC	72-3931	H079/5 STD 0.25 0.50	
MB/HL 2-5	4	53.958/53.978	59.000/59.019	18.500	2.502	0.020/0.082	AL-LF	02-3085L	H1328/5 STD	
MB/HL 2-5	4	53.958/53.978	59.000/59.019	18.500	2.502	0.020/0.082	AL-LF	02-3085U		
MB/HL 1	1	53.958/53.978	59.000/59.012	18.500	2.506	0.020/0.062	IX-LF	02-4941L		
MB/HL 1	1	53.958/53.978	59.000/59.012	18.500	2.506	0.020/0.062	IX-LF	02-4941U		

12/11 →

72-3931

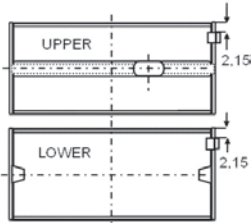

02-3085L

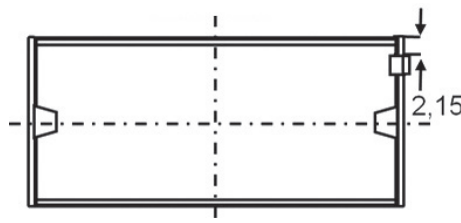

02-3085U

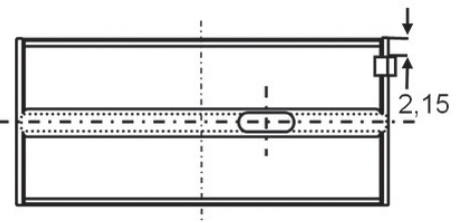



02-4941L



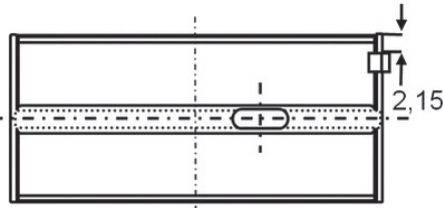





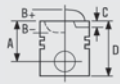

02-4941U

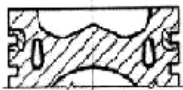
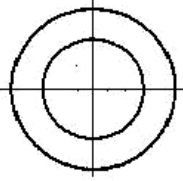



TW/A	2	59.500	73.200	1.975	AL-LF	04-3527	A123/4 STD
TW/A	2	59.500	73.200	1.975	AL-LF	04-3528	







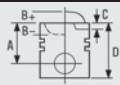

964	 81.00	Diesel			
CFFE	4 Cyl.	16.5:1	1968cc	85kW (115)PS	TD25403
ALHAMBRA	05/11→				

		
87-432300-10 [40] STD   A 45.80 B- 13.10 BØ 50.88 D 68.80  26x66 AK KK NB RT TP	08-432300-10 STD 1.75  GDC P 2.00  MO P 3.00  CR P 	

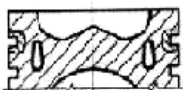
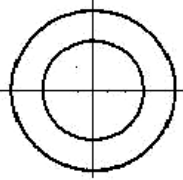
[40] OE 03L 107 065S, Gen 2 engine only

[40] OE 03L 107 065S, nur für Motoren der Generation 2

965	 81	Diesel			
CFGC	4 Cyl.	1968cc	130kW (177)PS	TD25727	
CFGC	4 Cyl.	16-0	1968cc	130kW (177)PS	TD26990
CFGC	4 Cyl.	16-0	1968cc	130kW (177)PS	TD27529
ALHAMBRA	11/12→	CC	12/12→	PASSAT	12/12→
PASSAT ALLTRACK	01/13→	Q3	06/11→	SHARAN	05/11→
SCIROCCO	01/13→	TIGUAN	11/12→		

		
87-432300-10 [40] STD   A 45.80 B- 13.10 BØ 50.88 D 68.80  26x66 AK KK NB RT TP	08-432300-10 STD 1.75  GDC P 2.00  MO P 3.00  CR P 	

[40] OE 03L 107 065S, Gen 2 engine only

[40] OE 03L 107 065S, nur für Motoren der Generation 2

966









 81.00

Diesel

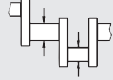

CKTB	4 Cyl.	1968cc	80kW (109)PS	TD25415
CKTC	4 Cyl.	1968cc	100kW (136)PS	TD25416
CKUB	4 Cyl.	1968cc	120kW (163)PS	TD25417
CKUC	4 Cyl.	1968cc	105kW (143)PS	TD25418

CRAFTER 30-35 05/11 → **CRAFTER 30-50** 05/11 →

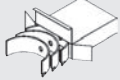
									
MB/HL 1-5	5	53.958/53.978	59.000/59.012	18.500	2.501	0.020/0.076	EC	72-3931	H079/5 STD 0.25 0.50
MB/HL 2-5	4	53.958/53.978	59.000/59.019	18.500	2.502	0.020/0.082	AL-LF	02-3085L	H1328/5 STD
MB/HL 2-5	4	53.958/53.978	59.000/59.019	18.500	2.502	0.020/0.082	AL-LF	02-3085U	
MB/HL 1	1	53.958/53.978	59.000/59.012	18.500	2.506	0.020/0.062	IX-LF	02-4941L	
MB/HL 1	1	53.958/53.978	59.000/59.012	18.500	2.506	0.020/0.062	IX-LF	02-4941U	

12/11 →

72-3931

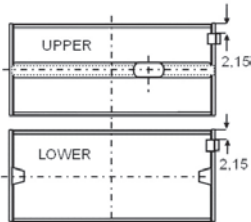

02-3085L

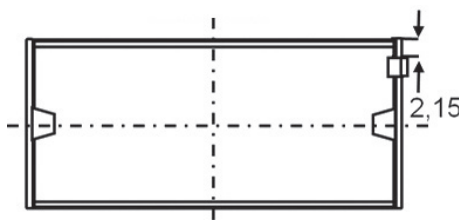

02-3085U

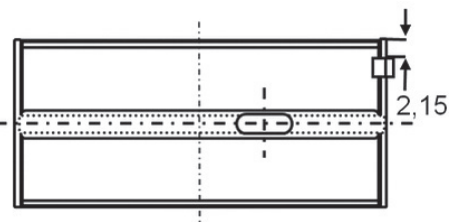

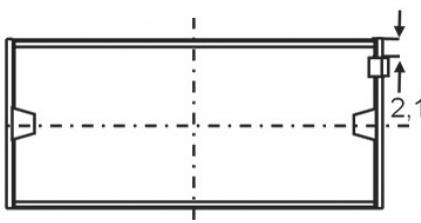

02-4941L



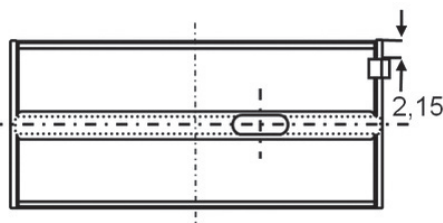







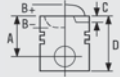





02-4941U



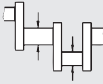
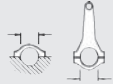





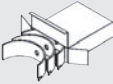

TW/A	2	59.500	73.200	1.975	AL-LF	04-3527	A123/4 STD
TW/A	2	59.500	73.200	1.975	AL-LF	04-3528	

967	 81.00	Petrol				
HP	5 Cyl.	10:1	1994cc	85kW (115)PS	TD266	477
HP	5 Cyl.	10:1	1994cc	85kW (115)PS	TD16429	477
JS	5 Cyl.	10:1	1994cc	85kW (115)PS	TD274	479
JS	5 Cyl.	10:1	1994cc	85kW (115)PS	TD5015	479
RT	5 Cyl.	10:1	1994cc	85kW (115)PS	TD318	483
SK	5 Cyl.		1994cc	85kW (115)PS	TD327	484
SL	5 Cyl.	10:1	1994cc	83kW (113)PS	TD328	485
80	10/83→09/84	90	08/84→03/87	100	08/86→11/90	
COUPE	09/83→04/88	PASSAT	08/83→03/88	SANTANA	08/83→12/84	

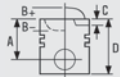











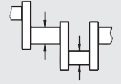
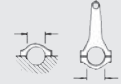



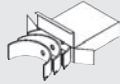

		
	08-109700-00 STD 08-109705-00 0.25mm 08-109707-00 0.50mm 1.50  CR P 1.75  P 3.00  CR P	

									
BE/PL	5	47.758/47.778	50.600/50.612	19.000	1.406	0.020/0.067	EC	71-3694	71-3694/5 STD 0.25
MB/HL 1-6	6	57.958/57.978	63.000/63.019	18.500	2.502	0.020/0.082	EC	72-3400	H981/6 STD 0.25
TW/A	2	63.500/63.750	77.200/77.450		1.975		AL-LF	04-3529	A124/4 STD
TW/A	2	63.500/63.750	77.200/77.450		1.975		AL-LF	04-3530	
TW/A	2	63.500/63.750	76.950/77.200		1.975		AL-LF	04-4782	A292/4 STD
TW/A	2	63.500/63.750	76.950/77.200		1.975		AL-LF	04-4783	
SE/PB	1	20.000	23.000/23.052	25.000			BC	55-3567	55-3567 SEMI

968	 81.00	Petrol				
KP	5 Cyl.		1994cc	85kW (115)PS	TD289	480
100	08/84→12/87					

		
	08-109700-00 STD 08-109705-00 0.25mm 08-109707-00 0.50mm 1.50  CR P 1.75  P 3.00  CR P	









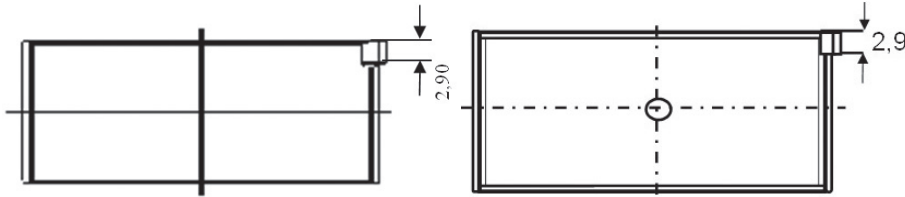







































968  **81.00** **Petrol**

									
→12/85									
									
01/86→									

71-3566







71-3694



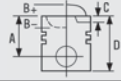





969  **81.00** **Petrol** 

NM	5 Cyl.	1994cc	118kW (160)PS	TD303	481
90	08/88→09/91	COUPE	08/89→07/91		

		
	<p>08-109400-10 STD</p> <p>08-109407-10 0.50mm</p> <p>1.50  P PS</p> <p>1.75  P</p> <p>3.00  CR P</p>	

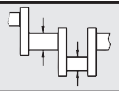
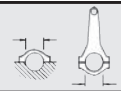
...Continued

969  **81.00** **Petrol**

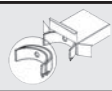
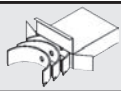
									
BE/PL	5	47.758/47.778	50.600/50.612	19.000	1.406	0.020/0.067	EC	71-3694	71-3694/5 STD 0.25
MB/HL 1-6	6	57.958/57.978	63.000/63.019	18.500	2.502	0.020/0.082	EC	72-3400	H981/6 STD 0.25
TW/A	2	63.500/63.750	77.200/77.450		1.975		AL-LF	04-3529	A124/4 STD
TW/A	2	63.500/63.750	77.200/77.450		1.975		AL-LF	04-3530	
TW/A	2	63.500/63.750	76.950/77.200		1.975		AL-LF	04-4782	A292/4 STD
TW/A	2	63.500/63.750	76.950/77.200		1.975		AL-LF	04-4783	
SE/PB	1	20.000	23.000/23.052	25.000			BC	55-3567	55-3567 SEMI
SE/PB	1	20.000	23.000/23.021	25.000			BC	55-3698	55-3698 SEMI

55-3567



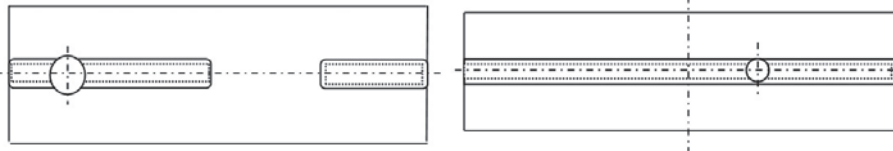

55-3698





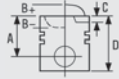
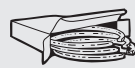





970  **81.00** **Petrol** 

PS 5 Cyl. 10:1 1994cc 85kW (115)PS TD308 482

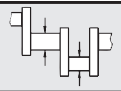
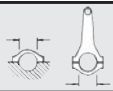
90 07/88→09/91

		
	<p>08-109700-00 STD</p> <p>08-109705-00 0.25mm</p> <p>08-109707-00 0.50mm</p> <p>1.50  CR P</p> <p>1.75  P</p> <p>3.00  CR P</p>	

970  **81.00** **Petrol**

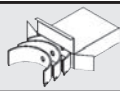
									
BE/PL	5	47.758/47.778	50.600/50.612	19.000	1.406	0.020/0.067	EC	71-3694	71-3694/5 STD 0.25
MB/HL 1-6	6	57.958/57.978	63.000/63.019	18.500	2.502	0.020/0.082	EC	72-3400	H981/6 STD 0.25
TW/A	2	63.500/63.750	77.200/77.450		1.975		AL-LF	04-3529	A124/4 STD
TW/A	2	63.500/63.750	77.200/77.450		1.975		AL-LF	04-3530	
TW/A	2	63.500/63.750	76.950/77.200		1.975		AL-LF	04-4782	A292/4 STD
TW/A	2	63.500/63.750	76.950/77.200		1.975		AL-LF	04-4783	
SE/PB	1	20.000	23.000/23.052	25.000			BC	55-3567	55-3567 SEMI
SE/PB	1	20.000	23.000/23.021	25.000			BC	55-3698	55-3698 SEMI





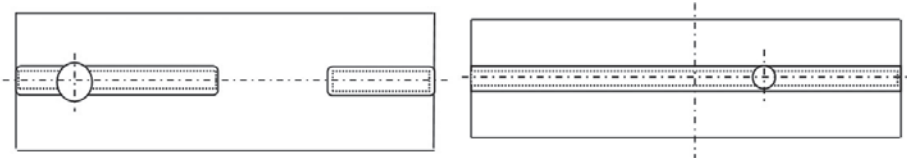

55-3567



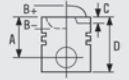





55-3698

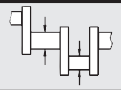
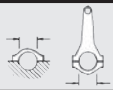

971  **81.00** **Petrol**





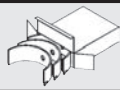



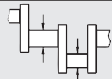

1B	5 Cyl.	2226cc	147kW (200)PS	TD211	486
2B	5 Cyl.	2226cc	140kW (190)PS	TD215	487
200	02/88→12/91	QUATTRO	08/87→07/89		

		
	<p>08-109700-00 STD</p> <p>08-109705-00 0.25mm</p> <p>08-109707-00 0.50mm</p> <p>1.50  CR P</p> <p>1.75  P</p> <p>3.00  CR P</p>	







									
BE/PL	5	47.758/47.778	50.600/50.612	19.000	1.406	0.020/0.067	EC	71-3694	71-3694/5 STD 0.25
MB/HL 1,2, 4-6	5	57.958/57.978	63.000/63.019	18.500	2.502	0.020/0.082	EC	72-3400	H941/6 STD 0.25
MB/HL 3	1	57.958/57.978	63.000/63.019	24.930	2.502	0.020/0.082	EC	72-3401H	



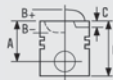





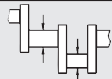

72-3401H	STD
	0.25MM
	0.50MM
	0.75MM

...Continued

971		 81.00		Petrol					
									
MB/HL 1-6	6	57.958/57.978	63.000/63.019	18.500	2.502	0.020/0.082	EC	72-3400	H981/6 STD 0.25
TW/A	2	63.500/63.750	77.200/77.450		1.975		AL-LF	04-3529	A124/4 STD
TW/A	2	63.500/63.750	77.200/77.450		1.975		AL-LF	04-3530	
TW/A	2	63.500/63.750	76.950/77.200		1.975		AL-LF	04-4782	A292/4 STD
TW/A	2	63.500/63.750	76.950/77.200		1.975		AL-LF	04-4783	
SE/PB	1	20.000	23.000/23.021	25.000			BC	55-3698	55-3698 SEMI

972		 81.00		Petrol						
3B	5 Cyl.		2226cc			162kW (220)PS			TD4192	488
AAN	5 Cyl.		2226cc			169kW (230)PS			TD225	489
ABY	5 Cyl.		2226cc			169kW (230)PS			TD237	490
ADU	5 Cyl.		2226cc			232kW (316)PS			TD242	491
80	02/93→07/95		100			08/91→06/94		200		03/89→12/90
A6	06/94→12/97		COUPE			09/90→12/96				

		
	08-109400-10 STD 08-109407-10 0.50mm 1.50  P PS 1.75  P 3.00  CR P	







971		 81.00		Petrol					
									
BE/PL	5	47.758/47.778	50.600/50.612	19.000	1.395	0.032/0.089	SP	71-3732	71-3732/5 STD [64]
MB/HL 1-6	6	57.958/57.978	63.000/63.019	18.500	2.502	0.020/0.082	EC	72-3400	H981/6 STD 0.25
TW/A	2	63.500/63.750	77.200/77.450		1.975		AL-LF	04-3529	A124/4 STD
TW/A	2	63.500/63.750	77.200/77.450		1.975		AL-LF	04-3530	
TW/A	2	63.500/63.750	76.950/77.200		1.975		AL-LF	04-4782	A292/4 STD
TW/A	2	63.500/63.750	76.950/77.200		1.975		AL-LF	04-4783	
SE/PB	1	20.000	23.000/23.021	25.000			BC	55-3698	55-3698 SEMI

973

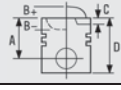
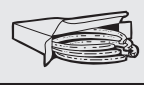
81.00
Petrol

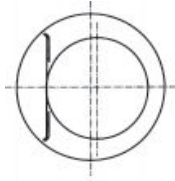



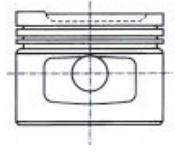





HX	5 Cyl.		2226cc	100kW (136)PS	TD267	492
HY	5 Cyl.	9.3:1	2226cc	100kW (136)PS	TD268	493
HY	5 Cyl.	9.3:1	2226cc	100kW (136)PS	TD21344	493

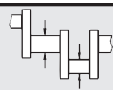
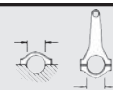

90	10/84→03/87	100	06/89→11/90	COUPE	09/84→10/88
QUATTRO	12/84→07/87				



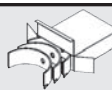



					
87-109700-30 87-109705-30 [25]	STD 0.25mm		08-109700-00 STD 08-109705-00 0.25mm 08-109707-00 0.50mm	1.50  CR P 1.75  P 3.00  CR P	
A 32.20 B- 4.60 B+ 1.10 BØ 60.15 D 62.30  20x57					

[25] A = 31.900, D = 62.000

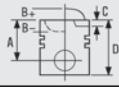







[25] A = 31.900, D = 62.000

									
BE/PL	5	47.758/47.778	50.600/50.612	19.000	1.406	0.020/0.067	EC	71-3694	71-3694/5 STD 0.25
MB/HL 1-6	6	57.958/57.978	63.000/63.019	18.500	2.502	0.020/0.082	EC	72-3400	H981/6 STD 0.25
TW/A	2	63.500/63.750	77.200/77.450		1.975		AL-LF	04-3529	A124/4 STD
TW/A	2	63.500/63.750	77.200/77.450		1.975		AL-LF	04-3530	
TW/A	2	63.500/63.750	76.950/77.200		1.975		AL-LF	04-4782	A292/4 STD
TW/A	2	63.500/63.750	76.950/77.200		1.975		AL-LF	04-4783	
SE/PB	1	20.000	23.000/23.052	25.000			BC	55-3567	55-3567 SEMI

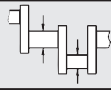
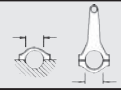
974	 81.00	Petrol				
JT	5 Cyl.	10:1	2226cc	88kW (120)PS	TD276	494
JT	5 Cyl.	10:1	2226cc	88kW (120)PS	TD5016	494
KX	5 Cyl.	10:1	2226cc	85kW (115)PS	TD293	497
KX	5 Cyl.	10:1	2226cc	85kW (115)PS	TD5020	497
KZ	5 Cyl.		2226cc	85kW (115)PS	TD294	498
90	01/85→03/87	100	10/84→09/86	COUPE	07/81→10/88	
PASSAT	01/85→03/88	QUATTRO	12/84→07/87			

		
87-109700-00 STD 87-109707-00 [25] 0.50mm A 32.20 B- 8.10 B+ 1.10 D 62.30  20x57	08-109700-00 STD 08-109705-00 0.25mm 08-109707-00 0.50mm 1.50  CR P 1.75  P 3.00  CR P	

[25] A = 31.900, D = 62.000 [25] A = 31.900, D = 62.000

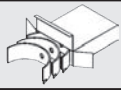
										
BE/PL	5	47.758/47.778	50.600/50.619	19.000	1.406	0.020/0.074	EC	71-3566	71-3566/5 STD	
→12/85										
BE/PL	5	47.758/47.778	50.600/50.612	19.000	1.406	0.020/0.067	EC	71-3694	71-3694/5 STD 0.25	
01/86→										

71-3566

71-3694

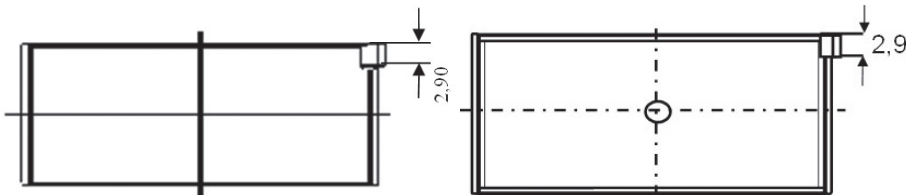

MB/HL 1-6	6	57.958/57.978	63.000/63.019	18.500	2.502	0.020/0.082	EC	72-3400	H981/6 STD 0.25
TW/A	2	63.500/63.750	77.200/77.450		1.975		AL-LF	04-3529	A124/4 STD
TW/A	2	63.500/63.750	77.200/77.450		1.975		AL-LF	04-3530	
TW/A	2	63.500/63.750	76.950/77.200		1.975		AL-LF	04-4782	A292/4 STD
TW/A	2	63.500/63.750	76.950/77.200		1.975		AL-LF	04-4783	
SE/PB	1	20.000	23.000/23.052	25.000			BC	55-3567	55-3567 SEMI

975

81.00

Petrol



KU	5 Cyl.	10:1	2226cc	101-103kW (137-140)PS	TD9375	495
KV	5 Cyl.	10:1	2226cc	100kW (136)PS	TD4125	496
KV	5 Cyl.	10:1	2226cc	100kW (136)PS	TD4209	496

90	10/84→09/91	100	08/84→11/90	200	08/84→07/85
COUPE	09/84→07/91	PASSAT	01/85→03/88	QUATTRO	12/84→07/87

87-109700-30 STD 87-109705-30 [25] 0.25mm	08-109700-00 STD 08-109705-00 0.25mm 08-109707-00 0.50mm	1.50 CR P 1.75 P 3.00 CR P		

[25] A = 31.900, D = 62.000 [25] A = 31.900, D = 62.000



BE/PL	5	47.758/47.778	50.600/50.619	19.000	1.406	0.020/0.074	EC	71-3566	71-3566/5 STD	
→12/85										
BE/PL	5	47.758/47.778	50.600/50.612	19.000	1.406	0.020/0.067	EC	71-3694	71-3694/5 STD 0.25	
01/86→										



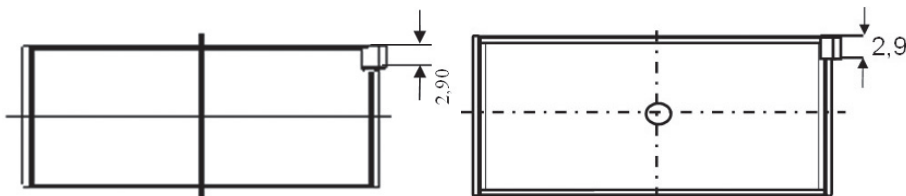





71-3566

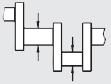
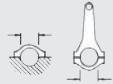

71-3694





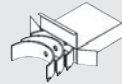





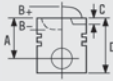





MB/HL 1-6	6	57.958/57.978	63.000/63.019	18.500	2.502	0.020/0.082	EC	72-3400	H981/6 STD 0.25
TW/A	2	63.500/63.750	77.200/77.450		1.975		AL-LF	04-3529	A124/4 STD
TW/A	2	63.500/63.750	77.200/77.450		1.975		AL-LF	04-3530	
TW/A	2	63.500/63.750	76.950/77.200		1.975		AL-LF	04-4782	A292/4 STD
TW/A	2	63.500/63.750	76.950/77.200		1.975		AL-LF	04-4783	
SE/PB	1	20.000	23.000/23.052	25.000			BC	55-3567	55-3567 SEMI

976	 81.00	Petrol	
MB	5 Cyl.	2226cc	147kW (200)PS
QUATTRO	08/87→07/89		TD295 499

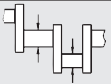
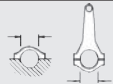
									
BE/PL	1	45.950/45.970	49.000/49.016	19.000	1.506	0.020/0.078	EC	71-3084	71-3084 STD 0.25 0.50
TW/A	2	63.500/63.750	77.200/77.450		1.975		AL-LF	04-3529	A124/4 STD
TW/A	2	63.500/63.750	77.200/77.450		1.975		AL-LF	04-3530	
TW/A	2	63.500/63.750	76.950/77.200		1.975		AL-LF	04-4782	A292/4 STD
TW/A	2	63.500/63.750	76.950/77.200		1.975		AL-LF	04-4783	

977	 81.00	Petrol	
MC	5 Cyl.	2226cc	121kW (165)PS
100	08/86→11/90	200	09/83→12/91





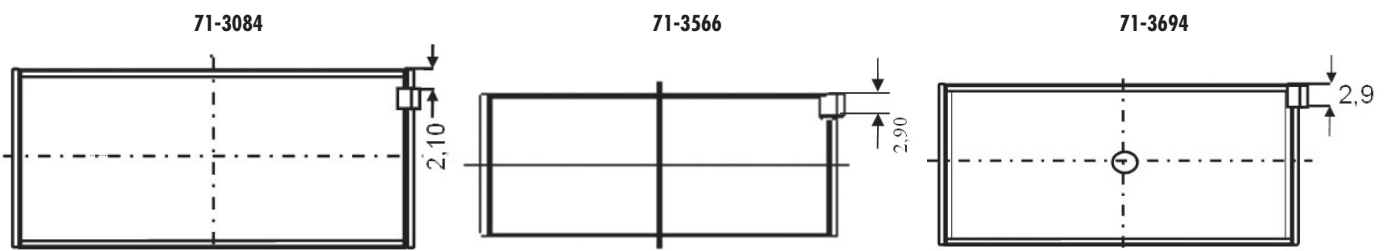



		
	08-109700-00 STD 08-109705-00 0.25mm 08-109707-00 0.50mm 1.50  CR P 1.75  P 3.00  CR P	

									
BE/PL	1	45.950/45.970	49.000/49.016	19.000	1.506	0.020/0.078	EC	71-3084	71-3084 STD 0.25 0.50
→12/83									
BE/PL	5	47.758/47.778	50.600/50.619	19.000	1.406	0.020/0.074	EC	71-3566	71-3566/5 STD
01/84→12/85									
BE/PL	5	47.758/47.778	50.600/50.612	19.000	1.406	0.020/0.067	EC	71-3694	71-3694/5 STD 0.25
01/86→									

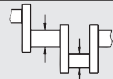
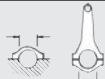

MB/HL 1-6	6	57.958/57.978	63.000/63.019	18.500	2.502	0.020/0.082	EC	72-3400	H981/6 STD 0.25
TW/A	2	63.500/63.750	77.200/77.450		1.975		AL-LF	04-3529	A124/4 STD
TW/A	2	63.500/63.750	77.200/77.450		1.975		AL-LF	04-3530	









977  **81.00** **Petrol**

									
TW/A	2	63.500/63.750	76.950/77.200		1.975		AL-LF	04-4782	A292/4 STD
TW/A	2	63.500/63.750	76.950/77.200		1.975		AL-LF	04-4783	

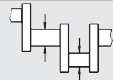
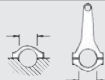
978  **81.00** **Petrol** 

PX 5 Cyl. 2226cc 88kW (120)PS TD312 501

100 08/85→07/86

									
--	---	---	---	---	---	---	---	--	---

BE/PL	5	47.758/47.778	50.600/50.619	19.000	1.406	0.020/0.074	EC	71-3566	71-3566/5 STD
→12/85									
BE/PL	5	47.758/47.778	50.600/50.612	19.000	1.406	0.020/0.067	EC	71-3694	71-3694/5 STD 0.25
01/86→									

71-3566

71-3694

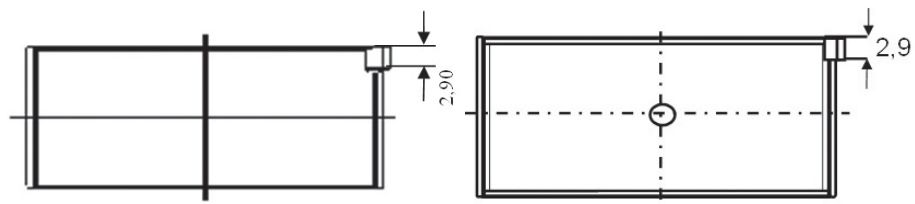





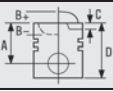

MB/HL 1-6	6	57.958/57.978	63.000/63.019	18.500	2.502	0.020/0.082	EC	72-3400	H981/6 STD 0.25
TW/A	2	63.500/63.750	77.200/77.450		1.975		AL-LF	04-3529	
TW/A	2	63.500/63.750	77.200/77.450		1.975		AL-LF	04-3530	A292/4 STD
TW/A	2	63.500/63.750	76.950/77.200		1.975		AL-LF	04-4782	
TW/A	2	63.500/63.750	76.950/77.200		1.975		AL-LF	04-4783	
SE/PB	1	20.000	23.000/23.052	25.000			BC	55-3567	

979  **81.00** **Petrol** 

RR 5 Cyl. 2226cc 162kW (220)PS TD316 502

QUATTRO 08/89→07/91

		
	<p>08-109700-00 STD</p> <p>08-109705-00 0.25mm</p> <p>08-109707-00 0.50mm</p> <p>1.50  CR P</p> <p>1.75  P</p> <p>3.00  CR P</p>	

...Continued

979		81.00		Petrol							
BE/PL	5	47.758/47.778	50.600/50.612	19.000	1.395	0.032/0.089	SP	71-3732	71-3732/5 STD	[64]	
MB/HL 1-6	6	57.958/57.978	63.000/63.019	18.500	2.502	0.020/0.082	EC	72-3400	H981/6 STD 0.25		
TW/A	2	63.500/63.750	77.200/77.450		1.975		AL-LF	04-3529	A124/4 STD		
TW/A	2	63.500/63.750	77.200/77.450		1.975		AL-LF	04-3530			
TW/A	2	63.500/63.750	76.950/77.200		1.975		AL-LF	04-4782	A292/4 STD		
TW/A	2	63.500/63.750	76.950/77.200		1.975		AL-LF	04-4783			
SE/PB	1	20.000	23.000/23.021	25.000			BC	55-3698	55-3698 SEMI		

980		81.00		Petrol						
AAF	5 Cyl.	8.5:1	2459cc	81kW (110)PS		TD4002	503			
ACU	5 Cyl.	10:1	2459cc	81kW (110)PS		TD4015	504			
AET	5 Cyl.		2461cc	81kW (110)PS		TD4983	509			
AEU	5 Cyl.		2459cc	81kW (110)PS		TD9344	505			
APL	5 Cyl.		2461cc	85kW (115)PS		TD15288	509			
AVT	5 Cyl.		2461cc	85kW (115)PS		TD15370	510			
TRANSPORTER		11/90→04/03								

		08-502000-00 STD		
1.75		CR P		
2.00		P		
3.00		CR[52]		

[52] Steel

[52] Stahl

979		81.00		Petrol							
BE/PL	5	47.758/47.778	50.600/50.612	19.000	1.406	0.020/0.067	EC	71-3694	71-3694/5 STD 0.25		
MB/HL 1-6	6	57.958/57.978	63.000/63.019	18.500	2.502	0.020/0.082	EC	72-3400	H981/6 STD 0.25		
TW/A	2	63.500/63.750	77.200/77.450		1.975		AL-LF	04-3529	A124/4 STD		
TW/A	2	63.500/63.750	77.200/77.450		1.975		AL-LF	04-3530			
TW/A	2	63.500/63.750	76.950/77.200		1.975		AL-LF	04-4782	A292/4 STD		
TW/A	2	63.500/63.750	76.950/77.200		1.975		AL-LF	04-4783			
SE/PB	1	24.000	27.000/27.021	25.000			BC	55-3696	55-3696 SEMI		

981

81.00

Diesel



ACV	5 Cyl.	20.5:1	246lcc	74kW (100)PS	TD4978	514
AHD	5 Cyl.	19.5:1	2459cc	75kW (102)PS	TD9294	506
AHY	5 Cyl.		246lcc	111kW (151)PS	TD10748	516
AJT	5 Cyl.		246lcc	65kW (88)PS	TD10747	517
ANJ	5 Cyl.		246lcc	80kW (109)PS	TD13446	518
APA	5 Cyl.		246lcc	66kW (89)PS	TD13445	519
AUF	5 Cyl.		246lcc	75kW (102)PS	TD16857	520
AXG	5 Cyl.	18:1	246lcc	111kW (151)PS	TD17505	516
AXL	5 Cyl.	19.5:1	246lcc	75kW (102)PS	TD18687	523
AYC	5 Cyl.	19.5:1	246lcc	75kW (102)PS	TD17504	520
AYY	5 Cyl.	18:1	246lcc	65kW (88)PS	TD17503	517
BBE	5 Cyl.		246lcc	61kW (82)PS	TD16451	518
BBF	5 Cyl.		246lcc	70kW (95)PS	TD16452	518

LT 28-35	05/96→07/06	LT 28-46	05/96→07/06	TRANSPORTER	09/95→04/03
----------	-------------	----------	-------------	-------------	-------------

<p>87-501500-00 [55] STD 87-501507-00 [32] [55] 0.50mm</p> <p>A 45.75 B- 17.20 Bø 39.60 C 1.35 D 69.75</p> <p> 26x68</p> <p>AK HA NB RT</p>	<p>08-501500-00 STD 08-501507-00 0.50mm</p> <p>2.50 P PS 2.00 CR P 3.00 CR P</p>	<p>14-020420-00 D B 84.00 C 158.00 D 85.00 E 5.00 14-020421-00 D B 84.50 C 158.00 D 85.50 E 5.50</p>
<p>87-501500-10 [58] STD 87-501507-10 [32] [58] 0.50mm</p> <p>A 45.75 B- 17.20 Bø 39.60 C 1.35 D 69.75</p> <p> 26x68</p> <p>AK HA NB RT</p>	<p>08-501500-00 STD 08-501507-00 0.50mm</p> <p>2.50 P PS 2.00 CR P 3.00 CR P</p>	

[32] A = 45.500, D = 69.500 [55] To cylinder 1-2 [58] Zum Zylinder 1-2
[55] To cylinder 3-5 [58] Zum Zylinder 3-5

BE/PL	5	47.758/47.778	50.600/50.612	20.000	1.406	0.020/0.067	SP	71-3847	71-3847/5 STD	[64]	
MB/HL 1-6	6	57.958/57.978	63.000/63.019	18.500	2.502	0.020/0.082	EC	72-3400	H981/6 STD 0.25		
TW/A	2	63.500/63.750	77.200/77.450		1.975		AL-LF	04-3529	A124/4 STD		
TW/A	2	63.500/63.750	77.200/77.450		1.975		AL-LF	04-3530			
TW/A	2	63.500/63.750	76.950/77.200		1.975		AL-LF	04-4782	A292/4 STD		
TW/A	2	63.500/63.750	76.950/77.200		1.975		AL-LF	04-4783			
SE/PB	1	26.000	29.000/29.052	25.000			BC	55-3729	55-3729 SEMI		

982	81.00	Diesel	
AGX	5 Cyl.	19.5:1	2459cc
			55kW (75)PS
			TD9295
			506
LT 28-35	07/96→07/06	LT 28-46	09/96→07/06









87-501500-00 [55] STD 87-501507-00 [32] [55] 0.50mm A 45.75 B- 17.20 BØ 39.60 C 1.35 D 69.75 26x68 AK HA NB RT	08-501500-00 STD 08-501507-00 0.50mm 2.50 P PS 2.00 CR P 3.00 CR P	14-020420-00 D B 84.00 C 158.00 D 85.00 E 5.00 14-020421-00 D B 84.50 C 158.00 D 85.50 E 5.50
87-501500-10 [58] STD 87-501507-10 [32] [58] 0.50mm A 45.75 B- 17.20 BØ 39.60 C 1.35 D 69.75 26x68 AK HA NB RT	08-501500-00 STD 08-501507-00 0.50mm 2.50 P PS 2.00 CR P 3.00 CR P	

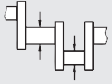
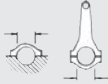

[32] A = 45.500, D = 69.500 [32] A = 45.500, D = 69.500
 [55] To cylinder 1-2 [55] Zum Zylinder 1-2
 [58] To cylinder 3-5 [58] Zum Zylinder 3-5

BE/PL	5	47.758/47.778	50.600/50.612	20.000	1.406	0.020/0.067	SP	71-3847	71-3847/5	[64]
SE/PB	1	26.000	29.000/29.052	25.000			BC	55-3729	55-3729	
									SEMI	









983	81.00	Diesel	
BNZ	5 Cyl.	18:1	2460cc
			96kW (131)PS
			TD20398
			507
MULTIVAN	04/03→11/09	TRANSPORTER	04/03→11/09

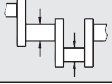
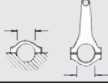

	08-421000-00 STD 08-421007-00 0.50mm 2.50 CK P 2.00 P 3.00 CR P	





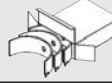



983		 81.00		Diesel						
										[64]
BE/PL	1	50.858/50.878	53.700/53.712	20.400	1.403	0.020/0.073	SP	71-3930	71-3930 STD 0.25 0.50	
MB/HL 1-6	6	57.963/57.978	64.000/64.010	18.500	3.003		AL-LF	02-4781	H1294/6 STD 0.25	
CB/NWB	1	28.947/28.960	32.000/32.025	18.000	1.513	0.020/0.078	EC-LF	73-4828	73-4828 STD	
CB/NWB 1-5	5	28.947/28.960	32.000/32.025	25.000	1.513	0.020/0.068	EC	73-3903	N147/5 STD	

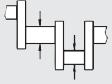
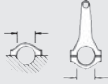

984		 81.00		Diesel						
BPC	5 Cyl.	18:1	2460cc	128kW (174)PS					TD20397	507
BPD	5 Cyl.	18:1	2461cc	120kW (163)PS					TD20507	529
BPE	5 Cyl.	18:1	2461cc	128kW (174)PS					TD20508	530





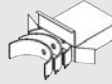



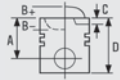
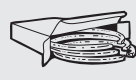

MULTIVAN	04/03 → 11/09	TOUAREG	01/03 → 05/10	TRANSPORTER	04/03 → 11/09
-----------------	---------------	----------------	---------------	--------------------	---------------

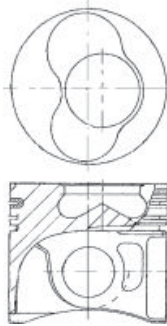
										[64]
BE/PL	1	50.858/50.878	53.700/53.712	20.400	1.403	0.020/0.073	SP	71-3930	71-3930 STD 0.25 0.50	
MB/HL 1-6	6	57.963/57.978	64.000/64.010	18.500	3.003		AL-LF	02-4781	H1294/6 STD 0.25	
CB/NWB	1	28.947/28.960	32.000/32.025	18.000	1.513	0.020/0.078	EC-LF	73-4828	73-4828 STD	
CB/NWB 1-5	5	28.947/28.960	32.000/32.025	25.000	1.513	0.020/0.068	EC	73-3903	N147/5 STD	



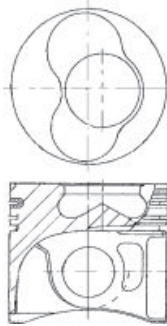





985		 81.00		Petrol						
AEN	5 Cyl.		2461cc	81kW (110)PS					TD9347	508
TRANSPORTER	11/90 → 04/03									

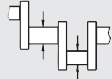
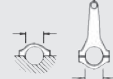

										
BE/PL	5	47.758/47.778	50.600/50.612	19.000	1.406	0.020/0.067	EC	71-3694	71-3694/5 STD 0.25	
MB/HL 1-6	6	57.958/57.978	63.000/63.019	18.500	2.502	0.020/0.082	EC	72-3400	H981/6 STD 0.25	
TW/A	2	63.500/63.750	77.200/77.450		1.975		AL-LF	04-3529	A124/4 STD	
TW/A	2	63.500/63.750	77.200/77.450		1.975		AL-LF	04-3530		
TW/A	2	63.500/63.750	76.950/77.200		1.975		AL-LF	04-4782	A292/4 STD	
TW/A	2	63.500/63.750	76.950/77.200		1.975		AL-LF	04-4783		
SE/PB	1	24.000	27.000/27.021	25.000			BC	55-3696	55-3696 SEMI	









986	 81.00	Diesel			
1T	5 Cyl.	2461cc	88kW (120)PS	TD212	511
AAT	5 Cyl.	2461cc	85kW (115)PS	TD228	512
ABP	5 Cyl.	2461cc	85kW (115)PS	TD235	513
AEL	5 Cyl.	2461cc	103kW (140)PS	TD245	515
100	01/90 → 06/94	A6	06/94 → 12/97		

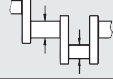
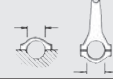

		
87-501500-20 [55] STD 87-501507-20 [32] [55] 0.50mm A 45.75 B- 17.25 BØ 39.60 C 1.35 D 69.75  26x68 AK NB RT	 08-501500-00 STD 08-501507-00 0.50mm 2.50  P PS 2.00  CR P 3.00  CR P	
87-501500-30 [58] STD 87-501507-30 [32] [58] 0.50mm A 45.75 B- 17.25 BØ 39.60 C 1.35 D 69.75  26x68 AK NB RT	 08-501500-00 STD 08-501507-00 0.50mm 2.50  P PS 2.00  CR P 3.00  CR P	









[32] A = 45.500, D = 69.500 [32] A = 45.500, D = 69.500
 [55] To cylinder 1-2 [55] Zum Zylinder 1-2
 [58] To cylinder 3-5 [58] Zum Zylinder 3-5

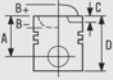
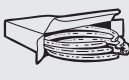

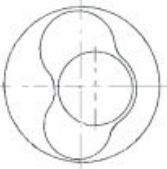
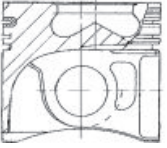

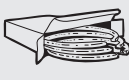



										
BE/PL	5	47.758/47.778	50.600/50.612	19.000	1.395	0.032/0.089	SP	71-3732	71-3732/5 STD	[64]
MB/HL 1-6	6	57.958/57.978	63.000/63.019	18.500	2.502	0.020/0.082	EC	72-3400	H981/6 STD 0.25	
TW/A	2	63.500/63.750	77.200/77.450		1.975		AL-LF	04-3529	A124/4 STD	
TW/A	2	63.500/63.750	77.200/77.450		1.975		AL-LF	04-3530		
TW/A	2	63.500/63.750	76.950/77.200		1.975		AL-LF	04-4782	A292/4 STD	
TW/A	2	63.500/63.750	76.950/77.200		1.975		AL-LF	04-4783		

987	 81.00	Diesel			
ANF	5 Cyl.	19.5:1	246lcc	55kW (75)PS	TD20502
ANG	5 Cyl.	19.5:1	246lcc	88kW (120)PS	TD20503
ANH	5 Cyl.	19.5:1	246lcc	111kW (151)PS	TD20504
BCT	5 Cyl.	19.5:1	246lcc	40kW (54)PS	TD22630
BCU	5 Cyl.	19.5:1	246lcc	74kW (100)PS	TD22631
BCV	5 Cyl.	19.5:1	246lcc	108kW (147)PS	TD22632

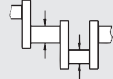
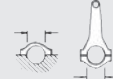
									
BE/PL	5	47.758/47.778	50.600/50.612	20.000	1.406	0.020/0.067	SP	71-3847	71-3847/5 STD [64]
MB/HL 1-6	6	57.958/57.978	63.000/63.019	18.500	2.502	0.020/0.082	EC	72-3400	H981/6 STD 0.25
TW/A	2	63.500/63.750	77.200/77.450		1.975		AL-LF	04-3529	A124/4 STD
TW/A	2	63.500/63.750	77.200/77.450		1.975		AL-LF	04-3530	
TW/A	2	63.500/63.750	76.950/77.200		1.975		AL-LF	04-4782	A292/4 STD
TW/A	2	63.500/63.750	76.950/77.200		1.975		AL-LF	04-4783	
SE/PB	1	26.000	29.000/29.052	25.000			BC	55-3729	55-3729 SEMI

988	 81.00	Diesel			
AVR	5 Cyl.		246lcc	80kW (109)PS	TD15497 521
BBR	5 Cyl.	19.5:1	246lcc	80kW (109)PS	TD22627 524
LT 28-35	05/99→07/06		LT 28-46	05/99→07/06	

		
87-501500-40 STD 87-501507-40 0.50mm   A 45.80 B- 16.80 BØ 46.00 C 1.35 C 1.35 D 69.80  26x68 AK NB RT	 08-501500-00 STD 08-501507-00 0.50mm 2.50  P PS 2.00  CR P 3.00  CR P	

									
BE/PL	5	47.758/47.778	50.600/50.612	20.000	1.406	0.020/0.067	SP	71-3847	71-3847/5 STD [64]
MB/HL 1-6	6	57.958/57.978	63.000/63.019	18.500	2.502	0.020/0.082	EC	72-3400	H981/6 STD 0.25
TW/A	2	63.500/63.750	77.200/77.450		1.975		AL-LF	04-3529	A124/4 STD
TW/A	2	63.500/63.750	77.200/77.450		1.975		AL-LF	04-3530	
TW/A	2	63.500/63.750	76.950/77.200		1.975		AL-LF	04-4782	A292/4 STD
TW/A	2	63.500/63.750	76.950/77.200		1.975		AL-LF	04-4783	
SE/PB	1	26.000	29.000/29.052	25.000			BC	55-3729	55-3729 SEMI

989

81.00

Diesel



AXD	5 Cyl.		2461cc	96kW (131)PS	TD16868	522
AXE	5 Cyl.		2461cc	128kW (174)PS	TD16869	522
BAC	5 Cyl.	18:1	2461cc	128kW (174)PS	TD16855	522
BLJ	5 Cyl.	18:1	2461cc	120kW (163)PS	TD20505	528
BLK	5 Cyl.	18:1	2461cc	120kW (163)PS	TD20506	528

MULTIVAN	04/03→11/09	TOUAREG	01/03→05/10	TRANSPORTER	04/03→11/09
-----------------	-------------	----------------	-------------	--------------------	-------------

87-421000-10 [55] STD 87-421007-10 [55] 0.50mm A 45.75 B- 18.20 BØ 37.80 C 1.40 D 69.75 26x65 AK KK NB RT	08-421000-00 STD 08-421007-00 0.50mm 2.50 CK P 2.00 P 3.00 CR P	14-020420-00 D B 84.00 C 158.00 D 85.00 E 5.00 14-020421-00 D B 84.50 C 158.00 D 85.50 E 5.50
87-421000-20 [58] STD 87-421007-20 [58] 0.50mm A 45.75 B- 18.20 BØ 37.80 C 1.40 D 69.75 26x65 AK KK NB RT	08-421000-00 STD 08-421007-00 0.50mm 2.50 CK P 2.00 P 3.00 CR P	

[55] To cylinder 1-2
 [58] To cylinder 3-5

[55] Zum Zylinder 1-2
 [58] Zum Zylinder 3-5

BE/PL	1	50.858/50.878	53.700/53.712	20.400	1.403	0.020/0.073	SP	71-3930	71-3930 STD 0.25 0.50	[64]
MB/HL 1-6	6	57.963/57.978	64.000/64.010	18.500	3.003		AL-LF	02-4781	H1294/6 STD 0.25	
CB/NWB	1	28.947/28.960	32.000/32.025	18.000	1.513	0.020/0.078	EC-LF	73-4828	73-4828 STD	
CB/NWB 1-5	5	28.947/28.960	32.000/32.025	25.000	1.513	0.020/0.068	EC	73-3903	N147/5 STD	

990		81.00	Diesel		
BJJ	5 Cyl.	246lcc	65kW (88)PS	TD18891	525
BJK	5 Cyl.	246lcc	80kW (109)PS	TD18892	525
CEBA	5 Cyl.	246lcc	65kW (88)PS	TD24719	531
CEBB	5 Cyl.	246lcc	80kW (109)PS	TD24720	531

CRAFTER 30-35 04/06 → **CRAFTER 30-50** 04/06 →



BE/PL	1	50.858/50.878	53.700/53.712	20.400	1.403	0.020/0.073	SP	71-3930	71-3930 STD 0.25 0.50	[64]
MB/HL 1-6	6	57.958/57.978	63.000/63.019	18.500	2.502	0.020/0.082	EC	72-3400	H981/6 STD 0.25	
TW/A	2	63.500/63.750	77.200/77.450		1.975		AL-LF	04-3529	A124/4 STD	
TW/A	2	63.500/63.750	77.200/77.450		1.975		AL-LF	04-3530		
TW/A	2	63.500/63.750	76.950/77.200		1.975		AL-LF	04-4782	A292/4 STD	
TW/A	2	63.500/63.750	76.950/77.200		1.975		AL-LF	04-4783		







991		81.00	Diesel		
BJL	5 Cyl.	246lcc	100kW (136)PS	TD18893	526
BJM	5 Cyl.	246lcc	120kW (163)PS	TD18894	527
CECA	5 Cyl.	246lcc	100kW (136)PS	TD24721	531

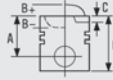
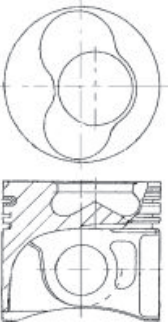

CRAFTER 30-35 04/06 → **CRAFTER 30-50** 04/06 →







87-421000-30 87-421007-30	STD 0.50mm		08-421000-00 08-421007-00	STD 0.50mm						
A 45.75 B- 16.65 BØ 46.00 C 1.35 C 1.35 D 68.75 26x66			2.50 CK P 2.00 P 3.00 CR P							
AK KK NB RT TP		0811C-101								



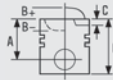
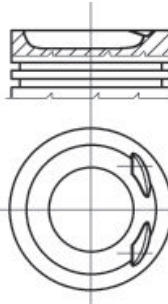





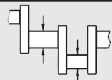

BE/PL	1	50.858/50.878	53.700/53.712	20.400	1.403	0.020/0.073	SP	71-3930	71-3930 STD 0.25 0.50	[64]
MB/HL 1-6	6	57.958/57.978	63.000/63.019	18.500	2.502	0.020/0.082	EC	72-3400	H981/6 STD 0.25	
TW/A	2	63.500/63.750	77.200/77.450		1.975		AL-LF	04-3529	A124/4 STD	
TW/A	2	63.500/63.750	77.200/77.450		1.975		AL-LF	04-3530		
TW/A	2	63.500/63.750	76.950/77.200		1.975		AL-LF	04-4782	A292/4 STD	
TW/A	2	63.500/63.750	76.950/77.200		1.975		AL-LF	04-4783		

992	 81.00	Diesel	
CECB	5 Cyl.	2461cc	120kW (163)PS
TD24722	532		
CRAFTER 30-35	04/06→07/11	CRAFTER 30-50	04/06→07/11

			
87-421000-30 87-421007-30	STD 0.50mm	08-421000-00 08-421007-00	STD 0.50mm
A 45.75 B- 16.65 BØ 46.00 C 1.35 C 1.35 D 68.75  26x66		2.50  CK P 2.00  P 3.00  CR P	
AK KK NB RT TP	0811C-101		

993	 81.00	Petrol	
AGZ	V5 Cyl.	10:1	2324cc
AGZ	V5 Cyl.	10:1	2324cc
TD5559	533		
TD12511	533		
BORA	10/98→10/00	GOLF	08/97→06/06
TOLEDO	04/99→05/01		PASSAT 10/96→11/00

			
87-501900-00 87-501907-00	STD 0.50mm	08-501900-00 08-501907-00	STD 0.50mm
A 30.52 B+ 4.26 BØ 57.00 C 6.22 D 55.78  20x57		1.50  P PS 1.75  P 3.00  CR P	

									
BE/PL	5	53.958/53.978	56.800/56.819	17.000	1.406	0.020/0.074	AL-LF	01-3841	01-3841/5 0.25
TW/A	2	65.450	80.000		1.723		AL-LF	04-3717	A139/4 STD
TW/A	2	65.450	80.000		1.723		AL-LF	04-3718	
SE/PB	1		23.000/23.052	20.000			BC	55-3719	55-3719 SEMI
BU	1	42.959/42.975	46.055/46.095	15.000			AL-LF	07-3088	07-3088 STD SEMI
BU	1	14.473/14.484	17.500/17.518	20.000			BB	17-3720	17-3720 SEMI
									[68]
									[68]

994	81.00	Petrol				
AQN	V5 Cyl.	10.8:1	2324cc	125kW (170)PS	TD15472	534
AQN	V5 Cyl.	10.8:1	2324cc	125kW (170)PS	TD16163	534
AZX	V5 Cyl.	10.8:1	2324cc	125kW (170)PS	TD15151	535
BORA	10/00→05/05	GOLF	10/00→06/06	LEON	09/00→11/03	
NEW BEETLE	10/00→	PASSAT	11/00→05/05	TOLEDO	05/01→05/06	

	08-501900-00 STD 08-501907-00 0.50mm 1.50 P PS 1.75 P 3.00 CR P	

BE/PL	5	53.958/53.978	56.800/56.819	17.000	1.406	0.020/0.074	AL-LF	01-3841	01-3841/5 0.25	
TW/A	2	65.450	80.000		1.723		AL-LF	04-3717	A139/4 STD	
TW/A	2	65.450	80.000		1.723		AL-LF	04-3718		
SE/PB	1		23.000/23.052	20.000			BC	55-3719	55-3719 SEMI	
BU	1	42.959/42.975	46.055/46.095	15.000			AL-LF	07-3088	07-3088 STD SEMI [68]	
BU	1	14.473/14.484	17.500/17.518	20.000			BB	17-3720	17-3720 SEMI [68]	

995	81.00	Petrol				
AFM	V6 Cyl.		2393cc	110kW (150)PS	TD17146	536
A4	07/95→07/97	A6	07/95→12/97			

BE/PL	6	53.958/53.978	57.600/57.612	17.000	1.806	0.020/0.069	EC	71-3711	71-3711/6 STD
TW/A	2	70.500	84.900		1.965		AL-LF	04-3713	A138/4 STD
TW/A	2	70.500	84.900		1.965		AL-LF	04-3714	
SE/PB	1	20.995/21.000	23.000/23.052	23.500			BC	55-3715	55-3715 SEMI

996		81.00	Petrol		
AGA	V6 Cyl.	2393cc	121kW (165)PS	TD9515	538
AJG	V6 Cyl.	2393cc	120kW (163)PS	TD13928	539
ALF	V6 Cyl.	2393cc	121kW (165)PS	TD11359	540
ALW	V6 Cyl.	2393cc	100kW (136)PS	TD11088	541
AML	V6 Cyl.	2393cc	121kW (165)PS	TD13951	539
AMM	V6 Cyl.	2393cc	120kW (163)PS	TD15331	542
APC	V6 Cyl.	2393cc	115kW (156)PS	TD11360	541
APS	V6 Cyl.	2393cc	120kW (163)PS	TD13952	540
APZ	V6 Cyl.	2393cc	121kW (165)PS	TD13954	543
ARJ	V6 Cyl.	2393cc	121kW (165)PS	TD13953	539
ARN	V6 Cyl.	2393cc	100kW (136)PS	TD14028	541
ASM	V6 Cyl.	2393cc	100kW (136)PS	TD15330	541
BDV	V6 Cyl.	2393cc	125kW (170)PS	TD16410	545



A4	03/97→12/05	A6	02/97→01/05
----	-------------	----	-------------









MB/HL 1-4	4	57.959/57.978	63.000/63.019	18.500	2.507		AL-LF	02-3849	H066/4 STD
SE/PB	1	20.995/21.000	23.000/23.052	23.500			BC	55-3715	55-3715 SEMI

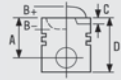

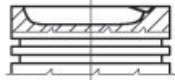







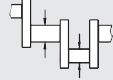
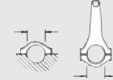

997		81.00	Petrol		
AAA	V6 Cyl.	10.1:1	2792cc	128kW (174)PS	TD3999 553
GOLF	01/92→09/99	JETTA	10/09→10/10	PASSAT	06/91→05/97
SHARAN	09/95→04/00	VENTO	01/92→09/98		



87-501900-00 87-501907-00	STD 0.50mm	87-501900-00 STD 87-501907-00 0.50mm
A 30.52 B+ 4.26 BØ 57.00 C 6.22 D 55.78 20x57		1.50 P PS 1.75 P 3.00 CR P







BE/PL	6	53.958/53.978	56.800/56.819	17.000	1.406	0.020/0.074	AL-LF	01-3841	01-3841/6 STD 0.25
MB/HL 1-7	7	59.958/59.978	65.000/65.010	17.000	2.501	0.020/0.075	AL-LF	02-3716	H035/7 STD 0.25
04/93→									
TW/A	2	65.450	80.000		1.723		AL-LF	04-3717	A139/4 STD
TW/A	2	65.450	80.000		1.723		AL-LF	04-3718	
SE/PB	1		23.000/23.052	20.000			BC	55-3719	55-3719 SEMI
BU	1	42.959/42.975	46.055/46.095	15.000			AL-LF	07-3088	07-3088 STD SEMI [68]
BU	1	14.473/14.484	17.500/17.518	20.000			BB	17-3720	17-3720 SEMI [68]

998	 81.00	Petrol				
AES	V6 Cyl.	10:1	2792cc	103kW (140)PS	TD9346	554
AMY	V6 Cyl.	10.75:1	2792cc	128kW (174)PS	TD17199	556
SHARAN	09/95→04/00		TRANSPORTER	11/95→05/00		

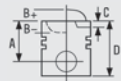





		
87-501900-00 STD 87-501907-00 0.50mm   A 30.52 B+ 4.26 BØ 57.00 C 6.22 D 55.78  20x57	08-501900-00 STD 08-501907-00 0.50mm  1.50  P PS 1.75  P 3.00  CR P	

												
BE/PL	6	53.958/53.978	56.800/56.819	17.000	1.406	0.020/0.074	AL-LF	01-3841	01-3841/6 STD 0.25			
MB/HL 1-7	7	59.958/59.978	65.000/65.010	17.000	2.501	0.020/0.075	AL-LF	02-3716	H035/7 STD 0.25			
TW/A	2	65.450	80.000		1.723		AL-LF	04-3717	A139/4 STD			
TW/A	2	65.450	80.000		1.723		AL-LF	04-3718				
SE/PB	1		23.000/23.052	20.000			BC	55-3719	55-3719 SEMI			
BU	1	42.959/42.975	46.055/46.095	15.000			AL-LF	07-3088	07-3088 STD SEMI			[68]
BU	1	14.473/14.484	17.500/17.518	20.000			BB	17-3720	17-3720 SEMI			[68]



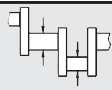
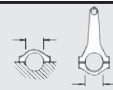

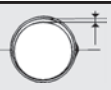

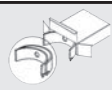
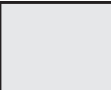
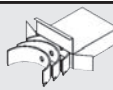

999	 81.00	Petrol						
AMV	V6 Cyl.		2792cc	150kW (204)PS	TD15128	555		
AQP	V6 Cyl.	10.75:1	2792cc	150kW (204)PS	TD12849	557		
AUE	V6 Cyl.	10.75:1	2792cc	150kW (204)PS	TD15482	558		
AUE	V6 Cyl.	10.75:1	2792cc	150kW (204)PS	TD16137	558		
AYL	V6 Cyl.	10.5:1	2792cc	150kW (204)PS	TD14910	559		
AYL	V6 Cyl.	10.5:1	2792cc	150kW (204)PS	TD14916	559		
ALHAMBRA	06/00→03/10		BORA	03/99→05/05		GOLF	03/99→06/06	
LEON	02/01→06/06		SHARAN	04/00→03/10		TOLEDO	10/00→07/01	
TRANSPORTER	04/00→04/03							

		
	08-501900-00 STD 08-501907-00 0.50mm  1.50  P PS 1.75  P 3.00  CR P	

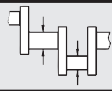
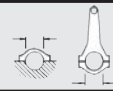





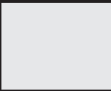
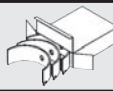

...Continued

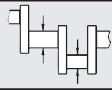
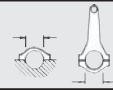

999		 81.00	Petrol							
										
BE/PL	6	53.958/53.978	56.800/56.819	17.000	1.406	0.020/0.074	AL-LF	01-3841	01-3841/6 STD 0.25	
MB/HL 1-7	7	59.958/59.978	65.000/65.010	17.000	2.501	0.020/0.075	AL-LF	02-3716	H035/7 STD 0.25	
TW/A	2	65.450	80.000		1.723		AL-LF	04-3717	A139/4 STD	
TW/A	2	65.450	80.000		1.723		AL-LF	04-3718		
SE/PB	1		23.000/23.052	20.000			BC	55-3719	55-3719 SEMI	
BU	1	42.959/42.975	46.055/46.095	15.000			AL-LF	07-3088	07-3088 STD SEMI	[68]
BU	1	14.473/14.484	17.500/17.518	20.000			BB	17-3720	17-3720 SEMI	[68]





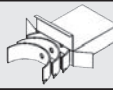

1000		 81.00	Petrol							
BDE	V6 Cyl.	10.75:1	2792cc			150kW (204)PS			TD16390	560
BDE	V6 Cyl.	10.75:1	2792cc			150kW (204)PS			TD18753	560
BORA	03/99→05/05	GOLF		03/99→06/06	LEON		05/02→06/04			
TOLEDO	05/02→04/04									

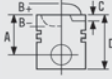

										
BE/PL	6	53.958/53.978	56.800/56.819	17.000	1.406	0.020/0.074	AL-LF	01-3841	01-3841/6 STD 0.25	
MB/HL 1-7	7	59.958/59.978	65.000/65.010	17.000	2.501	0.020/0.075	AL-LF	02-3716	H035/7 STD 0.25	
TW/A	2	65.450	80.000		1.723		AL-LF	04-3717	A139/4 STD	
TW/A	2	65.450	80.000		1.723		AL-LF	04-3718		
SE/PB	1		23.000/23.052	20.000			BC	55-3719	55-3719 SEMI	
BU	1	42.959/42.975	46.055/46.095	15.000			AL-LF	07-3088	07-3088 STD SEMI	[68]
BU	1	14.473/14.484	17.500/17.518	20.000			BB	17-3720	17-3720 SEMI	[68]







1001		 81.00	Petrol							
PT	V8 Cyl.		3562cc			184kW (250)PS			TD310	561
V8	10/88→02/94									

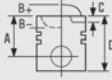

										
BE/PL	8	53.958/53.978	56.800/56.819	17.000	1.406	0.020/0.074	AL-LF	01-3841	01-3841/8 STD	
BE/PL	8	49.958/49.978	53.200/53.219	18.000	1.601	0.020/0.084	EC	71-3933	71-3933/8 STD	







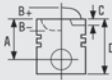

1002	 81.00	Diesel				
AJS	V10 Cyl.	18:1	492lcc	230kW (313)PS	TD16530	564
AYH	V10 Cyl.	18.5:1	492lcc	230kW (313)PS	TD17043	564
PHAETON	11/02→	TOUAREG	10/02→05/10			

		
	08-421000-00 STD 08-421007-00 0.50mm 2.50  CK P 2.00  P 3.00  CR P	

1003	 83.00	Diesel				
BPP	V6 Cyl.		2698cc	132kW (180)PS	TD18926	567
A4	01/06→03/09	A6	11/04→10/08	A6 Allroad	05/06→10/08	

		
	08-434300-00 STD 08-434307-00 0.50mm 2.00  CK 2.00  P 3.00  CR	

1004	 83.00	Diesel				
BSG	V6 Cyl.		2698cc	120kW (163)PS	TD18030	567
A4	11/05→06/08	A6	11/04→08/11	A6 Allroad	05/06→08/11	

		
	08-433100-00 STD 08-433105-00 0.25mm 08-433107-00 0.50mm 1.75  GDC[52] 2.00  MO P 3.00  CR P 08-434300-00 STD 08-434307-00 0.50mm 2.00  CK 2.00  P 3.00  CR	

[52] Steel

[52] Stahl

1005

82.00
Petrol

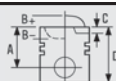
ABV V6 Cyl. 2861cc 140kW (190)PS TD4977 **568**
CORRADO 08/91→12/95 **GOLF** 10/94→04/99 **PASSAT** 01/94→05/97

08-502300-00 STD

1.50 P PS
 1.75 P
 3.00 CR P

BE/PL	6	53.958/53.978	56.800/56.819	17.000	1.406	0.020/0.074	AL-LF	01-3841	01-3841/6 STD 0.25
MB/HL 1-7	7	59.958/59.978	65.000/65.010	17.000	2.501	0.020/0.075	AL-LF	02-3716	H035/7 STD 0.25
04/93→									
TW/A	2	65.450	80.000		1.723		AL-LF	04-3717	A139/4 STD
TW/A	2	65.450	80.000		1.723		AL-LF	04-3718	
SE/PB	1		23.000/23.052	20.000			BC	55-3719	55-3719 SEMI
BU	1	42.959/42.975	46.055/46.095	15.000			AL-LF	07-3088	07-3088 STD SEMI [68]
BU	1	14.473/14.484	17.500/17.518	20.000			BB	17-3720	17-3720 SEMI [68]

1006

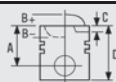
82.50
Petrol

SD 4 Cyl. 1847cc 83kW (113)PS TD323 **572**
80 09/86→08/90

08-991000-00 STD

1.50 P PS
 1.75 P
 3.00 CR P

BE/PL	4	47.758/47.778	50.600/50.612	19.000	1.406	0.020/0.067	EC	71-3694	71-3694/4 STD 0.25 0.50
MB/HL	4	53.958/53.978	59.000/59.019	18.500	2.502	0.020/0.082	AL-LF	02-3085L	H027/5 STD 0.25 0.50
MB/HL	6	53.958/53.978	59.000/59.019	18.500	2.502	0.020/0.082	AL-LF	02-3085U	
TW/A	2	59.500	73.200		1.975		AL-LF	04-3527	A123/4 STD
TW/A	2	59.500	73.200		1.975		AL-LF	04-3528	

1006		82.50	Petrol						
SE/PB	1	20.000	23.000/23.052	25.000			BC	55-3567	55-3567 SEMI
BU	1	42.959/42.975	46.055/46.095	15.000			AL-LF	07-3088	07-3088 STD SEMI [68]
BU	1	41.959/41.975	45.000/45.025	15.000			AL-LF	07-3089	07-3089 STD SEMI [68]

1007		82.50	Petrol						
2E	4 Cyl.	10.4:1	1984cc	85kW (115)PS		TD3570	573		
2E	4 Cyl.	10.4:1	1984cc	85kW (115)PS		TD4963	573		
ABK	4 Cyl.		1984cc	85kW (115)PS		TD233	580		
ADY	4 Cyl.	10.4:1	1984cc	85kW (115)PS		TD4979	584		
ADY	4 Cyl.	10.4:1	1984cc	85kW (115)PS		TD9386	584		







80	09/91→01/96	100	12/90→06/94	A6	06/94→12/97
ALHAMBRA	04/96→03/10	CABRIOLET	01/93→07/98	CORDOBA	02/93→06/99
CORRADO	04/93→12/95	COUPE	05/89→12/96	GOLF	11/91→04/99
IBIZA	03/93→08/99	PASSAT	02/90→05/97	SHARAN	09/95→03/10
TOLEDO	05/91→03/99	VENTO	11/91→09/98		

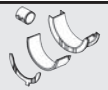

87-501800-20	STD	08-501800-00	STD		
87-501807-20 [22]	0.50mm	08-501807-00	0.50mm		
A 30.90		1.20	PS		
B- 5.70		1.50	P		
B+ 0.90		2.00	CR P		
BØ 64.00					
D 51.80					
21x55					
87-501800-50	STD	08-501800-00	STD		
		08-501807-00	0.50mm		
A 30.90		1.20	PS		
B- 5.00		1.50	P		
B+ 0.90		2.00	CR P		
BØ 64.00					
D 51.80					
21x56					

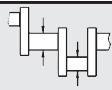
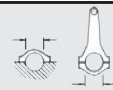



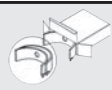
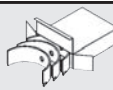

[22] A = 30.600, D = 51.500

[22] A = 30.600, D = 51.500

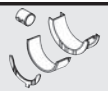
...Continued

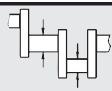
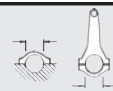
1007		 82.50	Petrol						
									
BE/PL	4	47.758/47.778	50.600/50.612	19.000	1.406	0.020/0.067	EC	71-3694	71-3694/4 STD 0.25 0.50
MB/HL	4	53.958/53.978	59.000/59.019	18.500	2.502	0.020/0.082	AL-LF	02-3085L	H027/5 STD 0.25 0.50
MB/HL	6	53.958/53.978	59.000/59.019	18.500	2.502	0.020/0.082	AL-LF	02-3085U	
TW/A	2	59.500	73.200		1.975		AL-LF	04-3527	A123/4 STD
TW/A	2	59.500	73.200		1.975		AL-LF	04-3528	
BU	1	42.959/42.975	46.055/46.095	15.000			AL-LF	07-3088	07-3088 STD SEMI [68]
BU	1	41.959/41.975	45.000/45.025	15.000			AL-LF	07-3089	07-3089 STD SEMI [68]

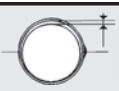
1008		 82.50	Petrol							
3A	4 Cyl.	1984cc	83kW (113)PS	TD4191	574					
80	08/88→08/91	COUPE	05/89→07/90							

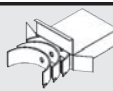
									
BE/PL	4	47.758/47.778	50.600/50.612	19.000	1.406	0.020/0.067	EC	71-3694	71-3694/4 STD 0.25 0.50
MB/HL	4	53.958/53.978	59.000/59.019	18.500	2.502	0.020/0.082	AL-LF	02-3085L	H027/5 STD 0.25 0.50
MB/HL	6	53.958/53.978	59.000/59.019	18.500	2.502	0.020/0.082	AL-LF	02-3085U	
TW/A	2	59.500	73.200		1.975		AL-LF	04-3527	A123/4 STD
TW/A	2	59.500	73.200		1.975		AL-LF	04-3528	
SE/PB	1	20.000	23.000/23.021	25.000			BC	55-3698	55-3698 SEMI
BU	1	42.959/42.975	46.055/46.095	15.000			AL-LF	07-3088	07-3088 STD SEMI [68]
BU	1	41.959/41.975	45.000/45.025	15.000			AL-LF	07-3089	07-3089 STD SEMI [68]

1009

82.50

Petrol



6A	4 Cyl.	1984cc	101kW (137)PS	TD4193	575	
9A	4 Cyl.	10.5:1	1984cc	100kW (136)PS	TD3998	576
80	03/90→09/91	90	08/89→07/90	CORRADO	08/91→12/95	
COUPE	01/92→07/92	JETTA	08/89→07/92	PASSAT	08/88→09/93	

<p>87-501807-60 0.50mm</p> <p>A 29.50 C 3.00 D 58.10</p> <p> 21x56</p>	<p>08-501800-00 STD 08-501807-00 0.50mm</p> <p>1.20 PS 1.50 P 2.00 CR P</p>	
---	--	--

BE/PL	4	47.758/47.778	50.600/50.612	19.000	1.406	0.020/0.067	EC	71-3694	71-3694/4 STD 0.25 0.50
MB/HL	4	53.958/53.978	59.000/59.019	18.500	2.502	0.020/0.082	AL-LF	02-3085L	H027/5 STD 0.25 0.50
MB/HL	6	53.958/53.978	59.000/59.019	18.500	2.502	0.020/0.082	AL-LF	02-3085U	
TW/A	2	59.500	73.200		1.975		AL-LF	04-3527	A123/4 STD
TW/A	2	59.500	73.200		1.975		AL-LF	04-3528	
SE/PB	1	20.000	23.000/23.021	25.000			BC	55-3698	55-3698 SEMI
BU	1	42.959/42.975	46.055/46.095	15.000			AL-LF	07-3088	07-3088 STD SEMI [68]
BU	1	41.959/41.975	45.000/45.025	15.000			AL-LF	07-3089	07-3089 STD SEMI [68]

1010

82.50









Petrol

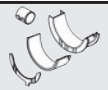

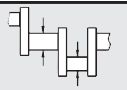
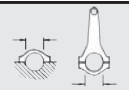

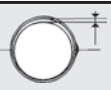

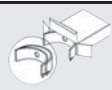

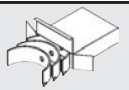
AAD	4 Cyl.	1984cc	85kW (115)PS	TD222	577
80	10/90→08/91	100	12/90→06/94	COUPE	05/89→12/96







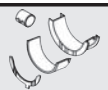

	<p>08-500600-00 STD 08/88→06/90</p> <p>1.50 P PS 1.50 P 2.00 CR P</p> <p>08-501800-00 STD 08-501807-00 0.50mm 06/90→</p> <p>1.20 PS 1.50 P 2.00 CR P</p>	
--	---	--

...Continued

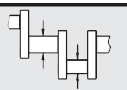
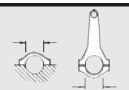
1010		 82.50	Petrol							
										
BE/PL	4	47.758/47.778	50.600/50.612	19.000	1.406	0.020/0.067	EC	71-3694	71-3694/4 STD 0.25 0.50	
MB/HL	4	53.958/53.978	59.000/59.019	18.500	2.502	0.020/0.082	AL-LF	02-3085L	H027/5 STD 0.25 0.50	
MB/HL	6	53.958/53.978	59.000/59.019	18.500	2.502	0.020/0.082	AL-LF	02-3085U		
TW/A	2	59.500	73.200		1.975		AL-LF	04-3527	A123/4 STD	
TW/A	2	59.500	73.200		1.975		AL-LF	04-3528		
BU	1	42.959/42.975	46.055/46.095	15.000			AL-LF	07-3088	07-3088 STD SEMI	[68]
BU	1	41.959/41.975	45.000/45.025	15.000			AL-LF	07-3089	07-3089 STD SEMI	[68]

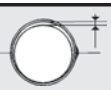
1011		 82.50	Petrol								
A4E	4 Cyl.		1984cc			74kW (100)PS				TD223	578
100	12/90→06/94		A6			06/94→12/97					

		
	08-501800-00 STD 08-501807-00 0.50mm 1.20  PS 1.50  P 2.00  CR P	

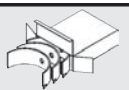
										
BE/PL	4	47.758/47.778	50.600/50.612	19.000	1.406	0.020/0.067	EC	71-3694	71-3694/4 STD 0.25 0.50	
MB/HL	4	53.958/53.978	59.000/59.019	18.500	2.502	0.020/0.082	AL-LF	02-3085L	H027/5 STD 0.25 0.50	
MB/HL	6	53.958/53.978	59.000/59.019	18.500	2.502	0.020/0.082	AL-LF	02-3085U		
TW/A	2	59.500	73.200		1.975		AL-LF	04-3527	A123/4 STD	
TW/A	2	59.500	73.200		1.975		AL-LF	04-3528		
SE/PB	1	20.000	23.000/23.021	25.000			BC	55-3698	55-3698 SEMI	
BU	1	42.959/42.975	46.055/46.095	15.000			AL-LF	07-3088	07-3088 STD SEMI	[68]
BU	1	41.959/41.975	45.000/45.025	15.000			AL-LF	07-3089	07-3089 STD SEMI	[68]







1012



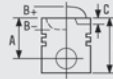
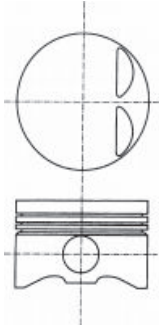





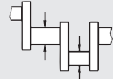

 **82.50**

Petrol



ABF	4 Cyl.	10.4:1	1984cc	110kW (150)PS	TD4007	579
ABF	4 Cyl.	10.4:1	1984cc	110kW (150)PS	TD4895	579
CORDOBA	08/96→06/99		GOLF	08/92→08/97	IBIZA	08/96→08/99
PASSAT	01/94→05/97		SHARAN	09/95→02/00	TOLEDO	11/93→03/99

 <p>87-501800-40 STD</p> <p>A 31.60 C 3.20 D 51.60</p> <p></p> <p> 21x56</p>	 <p>08-501800-00 STD 08-501807-00 0.50mm</p> <p>1.20  PS 1.50  P 2.00  CR P</p>	
--	---	---

									
BE/PL	4	47.758/47.778	50.600/50.612	19.000	1.406	0.020/0.067	EC	71-3694	71-3694/4 STD 0.25 0.50
MB/HL	4	53.958/53.978	59.000/59.019	18.500	2.502	0.020/0.082	AL-LF	02-3085L	H027/5 STD 0.25 0.50
MB/HL	6	53.958/53.978	59.000/59.019	18.500	2.502	0.020/0.082	AL-LF	02-3085U	
TW/A	2	59.500	73.200		1.975		AL-LF	04-3527	A123/4 STD
TW/A	2	59.500	73.200		1.975		AL-LF	04-3528	
BU	1	42.959/42.975	46.055/46.095	15.000			AL-LF	07-3088	07-3088 STD SEMI [68]
BU	1	41.959/41.975	45.000/45.025	15.000			AL-LF	07-3089	07-3089 STD SEMI [68]





1013

 **82.50**

Petrol

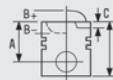
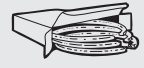

ABT	4 Cyl.		1984cc	66kW (89)PS	TD236	581
80	09/91→01/96					

	 <p>08-501800-00 STD 08-501807-00 0.50mm</p> <p>1.20  PS 1.50  P 2.00  CR P</p>	
---	---	---

...Continued

1013		82.50		Petrol						
BE/PL	4	47.758/47.778	50.600/50.612	19.000	1.406	0.020/0.067	EC	71-3694	71-3694/4 STD 0.25 0.50	
MB/HL	4	53.958/53.978	59.000/59.019	18.500	2.502	0.020/0.082	AL-LF	02-3085L	H027/5 STD 0.25 0.50	
MB/HL	6	53.958/53.978	59.000/59.019	18.500	2.502	0.020/0.082	AL-LF	02-3085U		
TW/A	2	59.500	73.200		1.975		AL-LF	04-3527	A123/4 STD	
TW/A	2	59.500	73.200		1.975		AL-LF	04-3528		
BU	1	42.959/42.975	46.055/46.095	15.000			AL-LF	07-3088	07-3088 STD SEMI	[68]
BU	1	41.959/41.975	45.000/45.025	15.000			AL-LF	07-3089	07-3089 STD SEMI	[68]

1014		82.50		Petrol					
ACE	4 Cyl.	1984cc	103kW (140)PS	TD238	582				
80	04/92→01/96	100	01/92→06/94	A6	06/94→12/97				
CABRIOLET	06/95→07/96	COUPE	08/92→12/96						

87-501807-60	0.50mm	
A 29.50		08-501800-00 STD
C 3.00		08-501807-00 0.50mm
D 58.10		1.20 PS
21x56		1.50 P
		2.00 CR P

1014		82.50		Petrol						
BE/PL	4	47.758/47.778	50.600/50.612	19.000	1.406	0.020/0.067	EC	71-3694	71-3694/4 STD 0.25 0.50	
MB/HL	4	53.958/53.978	59.000/59.019	18.500	2.502	0.020/0.082	AL-LF	02-3085L	H027/5 STD 0.25 0.50	
MB/HL	6	53.958/53.978	59.000/59.019	18.500	2.502	0.020/0.082	AL-LF	02-3085U		
TW/A	2	59.500	73.200		1.975		AL-LF	04-3527	A123/4 STD	
TW/A	2	59.500	73.200		1.975		AL-LF	04-3528		
BU	1	42.959/42.975	46.055/46.095	15.000			AL-LF	07-3088	07-3088 STD SEMI	[68]
BU	1	41.959/41.975	45.000/45.025	15.000			AL-LF	07-3089	07-3089 STD SEMI	[68]

1015	82.50	Petrol				
AEG	4 Cyl.	10.5:1	1984cc	85kW (115)PS	TD13442	585
AEG	4 Cyl.	10.5:1	1984cc	85kW (115)PS	TD16280	585
APK	4 Cyl.	10.3:1	1984cc	85kW (115)PS	TD11927	590
APK	4 Cyl.	10.3:1	1984cc	85kW (115)PS	TD16031	590
AQY	4 Cyl.	10.5:1	1984cc	85kW (115)PS	TD10607	590
AQY	4 Cyl.	10.5:1	1984cc	85kW (115)PS	TD13869	590
BORA	10/98→05/05	FABIA	12/99→03/08	GOLF	07/98→06/06	
NEW BEETLE	01/98→	OCTAVIA	04/99→05/07			

	08-501800-00 STD 08-501807-00 0.50mm 1.20 PS 1.50 P 2.00 CR P	









BE/PL	4	47.758/47.778	50.600/50.612	19.000	1.406	0.020/0.067	EC	71-3694	71-3694/4 STD 0.25 0.50
TW/A	2	59.500	73.200		1.975		AL-LF	04-3527	A123/4 STD
TW/A	2	59.500	73.200		1.975		AL-LF	04-3528	
SE/PB	1	20.000	23.000/23.021	25.000			BC	55-3698	55-3698 SEMI

1016	82.50	Petrol				
AEP	4 Cyl.		1984cc	79kW (107)PS	TD11448	586
GOLF	08/95→09/97	PASSAT	03/95→08/96	VENTO	05/96→12/97	

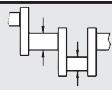
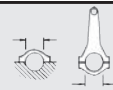
	08-501800-00 STD 08-501807-00 0.50mm 1.20 PS 1.50 P 2.00 CR P	

...Continued

1016  **82.50** **Petrol**

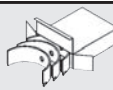
										
BE/PL	4	47.758/47.778	50.600/50.612	19.000	1.406	0.020/0.067	EC	71-3694		71-3694/4 STD 0.25 0.50
MB/HL	4	53.958/53.978	59.000/59.019	18.500	2.502	0.020/0.082	AL-LF	02-3085L		H027/5 STD 0.25 0.50
MB/HL	6	53.958/53.978	59.000/59.019	18.500	2.502	0.020/0.082	AL-LF	02-3085U		
MB/HL 1-5	5	53.958/53.978	59.000/59.019	18.500	2.502	0.020/0.082	AL-LF	02-3085L		H084/5 STD 0.25 0.50
MB/HL 1-5	5	53.958/53.978	59.000/59.019	18.500	2.502	0.020/0.082	AL-LF	02-3085U		

02-3085L



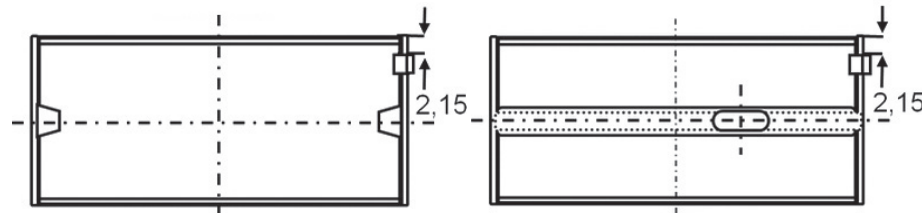







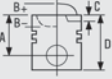
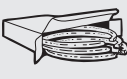

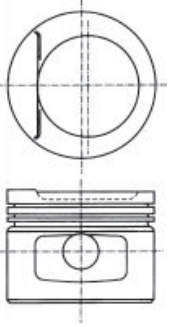
02-3085U

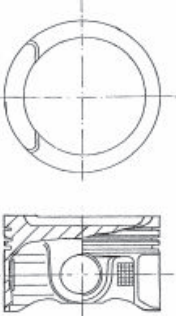

TW/A	2	59.500	73.200	1.975	AL-LF	04-3527	A123/4 STD
TW/A	2	59.500	73.200	1.975	AL-LF	04-3528	

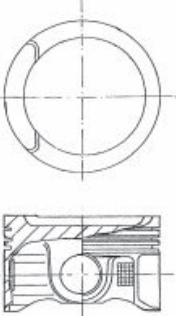
1017  **82.50** **Petrol**

AGG	4 Cyl.	10:1	1984cc	85kW (115)PS	TD4989	587
AGG	4 Cyl.	10:1	1984cc	85kW (115)PS	TD5537	587
CORDOBA	02/93→06/99	GOLF	11/91→06/02	IBIZA	03/93→08/99	
PASSAT	02/90→05/97	TOLEDO	05/91→03/99	VENTO	11/91→09/98	

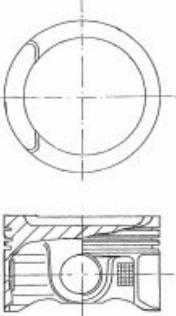
		
<p>87-501800-20 STD</p> <p>87-501807-20 [22] 0.50mm</p> <p>A 30.90 B- 5.70 B+ 0.90 BØ 64.00 D 51.80  21x55</p> 	<p>08-501800-00 STD</p> <p>08-501807-00 0.50mm</p> <p>1.20  PS</p> <p>1.50  P</p> <p>2.00  CR P</p> 	
<p>87-501800-50 STD</p> <p>A 30.90 B- 5.00 B+ 0.90 BØ 64.00 D 51.80  21x56</p> 	<p>08-501800-00 STD</p> <p>08-501807-00 0.50mm</p> <p>1.20  PS</p> <p>1.50  P</p> <p>2.00  CR P</p> 	

[22] A = 30.600, D = 51.500

[22] A = 30.600, D = 51.500

1017

82.50
Petrol

BE/PL	4	47.758/47.778	50.600/50.612	19.000	1.406	0.020/0.067	EC	71-3694	71-3694/4 STD 0.25 0.50	
BE/PL	4	47.758/47.778	50.600/50.612	19.000	1.406	0.020/0.067	EC	71-3929	71-3929/4 STD	[66]

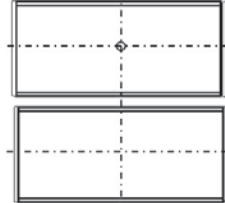
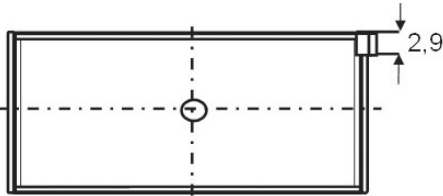
71-3694
71-3929

MB/HL 1-5	5	53.958/53.978	59.000/59.019	18.500	2.502	0.020/0.082	AL-LF	02-3085L	H084/5 STD 0.25 0.50	
MB/HL 1-5	5	53.958/53.978	59.000/59.019	18.500	2.502	0.020/0.082	AL-LF	02-3085U		
TW/A	2	59.500	73.200		1.975		AL-LF	04-3527	A123/4 STD	
TW/A	2	59.500	73.200		1.975		AL-LF	04-3528		
BU	1	42.959/42.975	46.055/46.095	15.000			AL-LF	07-3088	07-3088 STD SEMI	[68]
BU	1	41.959/41.975	45.000/45.025	15.000			AL-LF	07-3089	07-3089 STD SEMI	[68]

1018

82.50
Petrol

AKR	4 Cyl.	1984cc	85kW (115)PS	TD11354	588
------------	--------	--------	---------------------	----------------	------------

GOLF	11/91→06/02	VENTO	11/91→09/98
-------------	-------------	--------------	-------------







87-501800-20	STD	08-501800-00	STD	
87-501807-20 [22]	0.50mm	08-501807-00	0.50mm	
A 30.90		1.20	PS	
B- 5.70		1.50	P	
B+ 0.90		2.00	CR P	
BØ 64.00				
D 51.80				
21x55				
87-501800-50	STD	08-501800-00	STD	
87-501807-50 [22]	0.50mm	08-501807-00	0.50mm	
A 30.90		1.20	PS	
B- 5.00		1.50	P	
B+ 0.90		2.00	CR P	
BØ 64.00				
D 51.80				
21x56				

[22] A = 30.600, D = 51.500

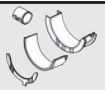
[22] A = 30.600, D = 51.500

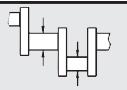
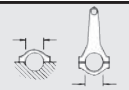
...Continued

1018  **82.50** **Petrol**

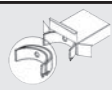
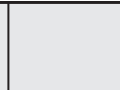
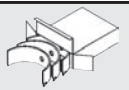
										
BE/PL	4	47.758/47.778	50.600/50.612	19.000	1.406	0.020/0.067	EC	71-3694	71-3694/4 STD 0.25 0.50	
BE/PL	4	47.758/47.778	50.600/50.612	19.000	1.406	0.020/0.067	EC	71-3929	71-3929/4 STD	[66]

71-3694



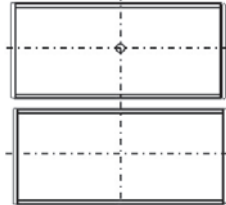
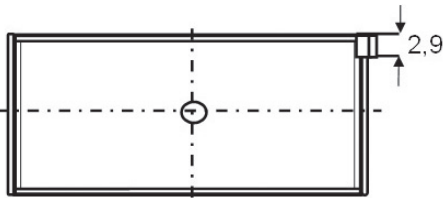





71-3929

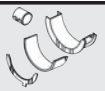

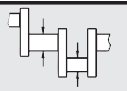
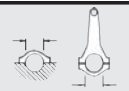
MB/HL 1-5	5	53.958/53.978	59.000/59.019	18.500	2.502	0.020/0.082	AL-LF	02-3085L	H084/5 STD 0.25 0.50
MB/HL 1-5	5	53.958/53.978	59.000/59.019	18.500	2.502	0.020/0.082	AL-LF	02-3085U	
TW/A	2	59.500	73.200		1.975		AL-LF	04-3527	A123/4 STD
TW/A	2	59.500	73.200		1.975		AL-LF	04-3528	



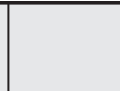
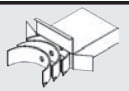

1019  **82.50** **Petrol**

ALT	4 Cyl.	10.3:1	1984cc	96kW (131)PS	TD15345	589
A4	11/00→06/08	A6	08/01→01/05			

										
BE/PL	4	47.758/47.778	50.600/50.612	19.000	1.406	0.020/0.067	EC	71-3929	71-3929/4 STD	[66]

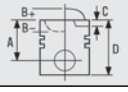
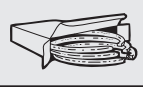





1020  **82.50** **Petrol**

ATM	4 Cyl.	10.5:1	1984cc	85kW (115)PS	TD14908	592
ATM	4 Cyl.	10.5:1	1984cc	85kW (115)PS	TD14913	592
ALHAMBRA	04/96→03/10	SHARAN	09/95→03/10			

		
	08-501800-00 STD 08-501807-00 0.50mm 1.20  PS 1.50  P 2.00  CR P	

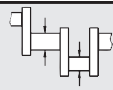
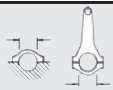
1020

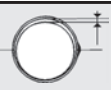
 **82.50**
Petrol

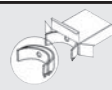
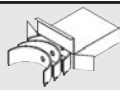





									
BE/PL	4	47.758/47.778	50.600/50.612	19.000	1.406	0.020/0.067	EC	71-3929	71-3929/4 STD [66]
MB/HL 1-5	5	53.958/53.978	59.000/59.019	18.500	2.502	0.020/0.082	AL-LF	02-3085L	H084/5 STD 0.25 0.50
MB/HL 1-5	5	53.958/53.978	59.000/59.019	18.500	2.502	0.020/0.082	AL-LF	02-3085U	
TW/A	2	59.500	73.200		1.975		AL-LF	04-3527	A123/4 STD
TW/A	2	59.500	73.200		1.975		AL-LF	04-3528	
BU	1	42.959/42.975	46.055/46.095	15.000			AL-LF	07-3088	07-3088 STD SEMI [68]
BU	1	41.959/41.975	45.000/45.025	15.000			AL-LF	07-3089	07-3089 STD SEMI [68]

1021

 **82.50**
Petrol

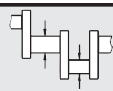
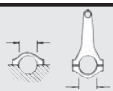

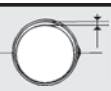
ATU	4 Cyl.	1984cc	85kW (115)PS	TD15490	593
AUZ	4 Cyl.	1984cc	88kW (120)PS	TD16243	
AWF	4 Cyl.	1984cc	85kW (115)PS	TD15488	596
AWG	4 Cyl.	1984cc	85kW (115)PS	TD15489	596

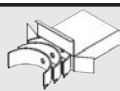
GOLF	06/98 → 06/02	PASSAT	04/00 → 11/00
-------------	---------------	---------------	---------------

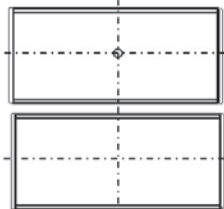
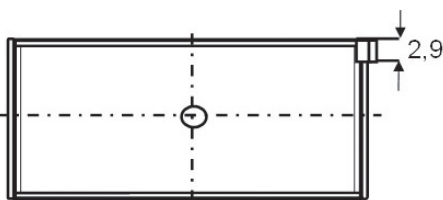





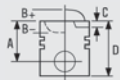

									
BE/PL	4	47.758/47.778	50.600/50.612	19.000	1.406	0.020/0.067	EC	71-3694	71-3694/4 STD 0.25 0.50
BE/PL	4	47.758/47.778	50.600/50.612	19.000	1.406	0.020/0.067	EC	71-3929	71-3929/4 STD [66]

71-3694
71-3929

MB/HL 1-5	5	53.958/53.978	59.000/59.019	18.500	2.502	0.020/0.082	AL-LF	02-3085L	H084/5 STD 0.25 0.50
MB/HL 1-5	5	53.958/53.978	59.000/59.019	18.500	2.502	0.020/0.082	AL-LF	02-3085U	
TW/A	2	59.500	73.200		1.975		AL-LF	04-3527	A123/4 STD
TW/A	2	59.500	73.200		1.975		AL-LF	04-3528	
BU	1	42.959/42.975	46.055/46.095	15.000			AL-LF	07-3088	07-3088 STD SEMI [68]
BU	1	41.959/41.975	45.000/45.025	15.000			AL-LF	07-3089	07-3089 STD SEMI [68]

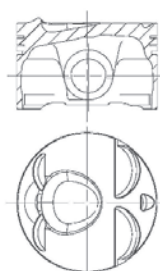







1022	 82.50	Petrol				
AWA	4 Cyl.	11.5:1	1984cc	110kW (150)PS	TD17035	595
AXW	4 Cyl.	11.5:1	1984cc	110kW (150)PS	TD16872	598
AXW	4 Cyl.	11.5:1	1984cc	110kW (150)PS	TD17081	598
BLR	4 Cyl.	11.5:1	1984cc	110kW (150)PS	TD17353	614
BLR	4 Cyl.	11.5:1	1984cc	110kW (150)PS	TD18102	614
BLR	4 Cyl.	11.5:1	1984cc	110kW (150)PS	TD18134	614
BLR	4 Cyl.	11.5:1	1984cc	110kW (150)PS	TD18199	614
BLX	4 Cyl.	11.5:1	1984cc	110kW (150)PS	TD17404	614
BLX	4 Cyl.	11.5:1	1984cc	110kW (150)PS	TD17985	614
BLX	4 Cyl.	11.5:1	1984cc	110kW (150)PS	TD20393	614
BLY	4 Cyl.	11.5:1	1984cc	110kW (150)PS	TD17354	614
BLY	4 Cyl.	11.5:1	1984cc	110kW (150)PS	TD17405	614
BLY	4 Cyl.	11.5:1	1984cc	110kW (150)PS	TD17986	614
BLY	4 Cyl.	11.5:1	1984cc	110kW (150)PS	TD18101	614
BMB	4 Cyl.	11.5:1	1984cc	110kW (150)PS	TD17406	615
BVX	4 Cyl.	11.5:1	1984cc	110kW (150)PS	TD18912	614
BVX	4 Cyl.	11.5:1	1984cc	110kW (150)PS	TD20394	614
BVY	4 Cyl.	11.5:1	1984cc	110kW (150)PS	TD18200	614
BVY	4 Cyl.	11.5:1	1984cc	110kW (150)PS	TD18266	614
BVY	4 Cyl.	11.5:1	1984cc	110kW (150)PS	TD18468	614
BVY	4 Cyl.	11.5:1	1984cc	110kW (150)PS	TD20518	614
BVZ	4 Cyl.	11.5:1	1984cc	110kW (150)PS	TD18201	614
BVZ	4 Cyl.	11.5:1	1984cc	110kW (150)PS	TD18267	614
BVZ	4 Cyl.	11.5:1	1984cc	110kW (150)PS	TD18469	614
BVZ	4 Cyl.	11.5:1	1984cc	110kW (150)PS	TD20519	614

A3	05/03→	A4	07/02→07/05	ALTEA	05/04→03/09
ALTEA XL	10/06→03/09	EOS	03/06→05/08	GOLF	01/04→11/08
JETTA	08/05→10/10	LEON	07/05→05/10	OCTAVIA	11/04→
PASSAT	03/05→11/10	TOLEDO	10/04→05/09	TOURAN	10/03→11/05

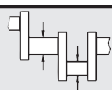
		
<p>87-435100-00</p> <p>A 29.39 B+ 12.46 D 59.85  19x44</p> <p>TP</p> 	<p>1.20  NT [52] 1.50  P 2.00  [52]</p>	

[52] Steel

[52] Stahl

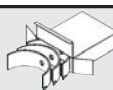
										[66]
BE/PL	4	47.758/47.778	50.600/50.612	19.000	1.406	0.020/0.067	EC	71-3929	71-3929/4 STD	[66]

1023	82.50	Petrol				
AXA	4 Cyl.	10.3:1	1984cc	85kW (115)PS	TD16865	597
AXA	4 Cyl.	10.3:1	1984cc	85kW (115)PS	TD16866	597
MULTIVAN	11/03→	TRANSPORTER	11/03→			

	08-501800-00 STD 08-501807-00 0.50mm 1.20 PS 1.50 P 2.00 CR P	

BE/PL	4	47.758/47.778	50.600/50.612	19.000	1.406	0.020/0.067	EC	71-3694	71-3694/4 STD 0.25 0.50	
Mot.→71-5-036000										
BE/PL	4	47.758/47.778	50.600/50.612	19.000	1.406	0.020/0.067	EC	71-3929	71-3929/4 STD	[66]
Mot.71-5-036001→										

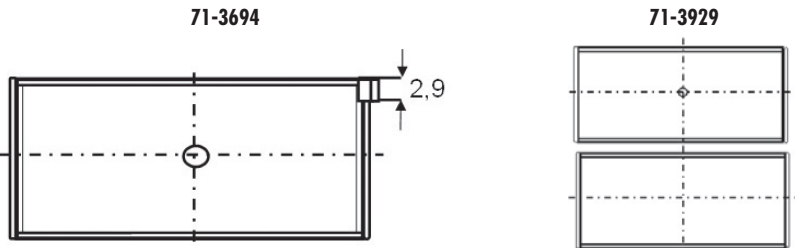









TW/A	2	59.500	73.200		1.975		AL-LF	04-3527	A123/4 STD	
TW/A	2	59.500	73.200		1.975		AL-LF	04-3528		
SE/PB	1	20.000	23.000/23.021	25.000			BC	55-3698	55-3698 SEMI	
BU	1	42.959/42.975	46.055/46.095	15.000			AL-LF	07-3088	07-3088 STD SEMI	[68]
BU	1	41.959/41.975	45.000/45.025	15.000			AL-LF	07-3089	07-3089 STD SEMI	[68]

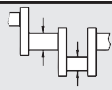
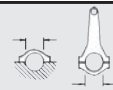

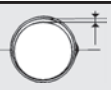

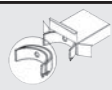
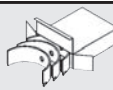

1024	82.50	Petrol				
AZH	4 Cyl.		1984cc	85kW (115)PS	TD15479	601
AZH	4 Cyl.		1984cc	85kW (115)PS	TD16092	601
BORA	10/98→05/05	GOLF	10/00→06/06	OCTAVIA	04/99→05/07	

	08-501800-00 STD 08-501807-00 0.50mm 1.20 PS 1.50 P 2.00 CR P	







...Continued

1024		 82.50	Petrol							
										[66]
BE/PL	4	47.758/47.778	50.600/50.612	19.000	1.406	0.020/0.067	EC	71-3929	71-3929/4 STD	
MB/HL 1-5	5	53.958/53.978	59.000/59.019	18.500	2.502	0.020/0.082	AL-LF	02-3085L	H084/5 STD 0.25 0.50	
MB/HL 1-5	5	53.958/53.978	59.000/59.019	18.500	2.502	0.020/0.082	AL-LF	02-3085U		
TW/A	2	59.500	73.200		1.975		AL-LF	04-3527	A123/4 STD	
TW/A	2	59.500	73.200		1.975		AL-LF	04-3528		

1025		 82.50	Petrol							
AZJ	4 Cyl.	10.5:1	1984cc			85kW (115)PS			TD16419	602
AZJ	4 Cyl.	10.5:1	1984cc			85kW (115)PS			TD17466	602
AZM	4 Cyl.	10.3:1	1984cc			85kW (115)PS			TD15150	604
AZM	4 Cyl.	10.3:1	1984cc			85kW (115)PS			TD16366	604
BORA	10/98→05/05	GOLF		07/98→06/06	NEW BEETLE		01/98→			
OCTAVIA	04/99→05/07	PASSAT		11/00→05/05	SUPERB		12/01→03/08			

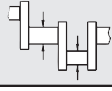
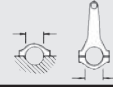
		
	08-501800-00 STD 08-501807-00 0.50mm 1.20  PS 1.50  P 2.00  CR P	

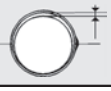
1026		 82.50	Petrol							
AZL	4 Cyl.	10.5:1	1984cc			85kW (115)PS			TD16241	603
AZL	4 Cyl.	10.5:1	1984cc			85kW (115)PS			TD17901	603
CORDOBA	09/02→11/09	FABIA		12/99→03/08	IBIZA		04/02→11/09			

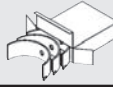
										[66]
BE/PL	4	47.758/47.778	50.600/50.612	19.000	1.406	0.020/0.067	EC	71-3929	71-3929/4 STD	
MB/HL 1-5	5	53.958/53.978	59.000/59.019	18.500	2.502	0.020/0.082	AL-LF	02-3085L	H084/5 STD 0.25 0.50	
MB/HL 1-5	5	53.958/53.978	59.000/59.019	18.500	2.502	0.020/0.082	AL-LF	02-3085U		
TW/A	2	59.500	73.200		1.975		AL-LF	04-3527	A123/4 STD	
TW/A	2	59.500	73.200		1.975		AL-LF	04-3528		
SE/PB	1	20.000	23.000/23.021	25.000			BC	55-3698	55-3698 SEMI	

1027		82.50	Petrol		
BBX	4 Cyl.	10.5:1	1984cc	85kW (115)PS	TD18446 605
BBX	4 Cyl.	10.5:1	1984cc	85kW (115)PS	TD21077 605
BEH	4 Cyl.		1984cc	85kW (115)PS	TD16527 608
BEJ	4 Cyl.	10.3:1	1984cc	85kW (115)PS	TD21073 609
BER	4 Cyl.	10.3:1	1984cc	85kW (115)PS	TD18049 609
BHP	4 Cyl.		1984cc	85kW (115)PS	TD21074 609
CBPA	4 Cyl.		1984cc	85kW (115)PS	TD21075 623
CORDOBA	09/02→11/09		GOLF	02/02→06/06	IBIZA 04/02→11/09
JETTA	06/10→		NEW BEETLE	01/98→	POLO 09/02→



	08-501800-00 STD 08-501807-00 0.50mm 1.20 PS 1.50 P 2.00 CR P	









1028		82.50	Petrol		
CEKA	4 Cyl.	1984cc	85kW (115)PS	TD22467	
IBIZA	10/08→				

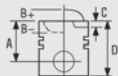







BE/PL	4	47.758/47.778	50.600/50.612	19.000	1.406	0.020/0.067	EC	71-3929	71-3929/4 STD	[66]
MB/HL 1-5	5	53.958/53.978	59.000/59.019	18.500	2.502	0.020/0.082	AL-LF	02-3085L	H084/5 STD 0.25 0.50	
MB/HL 1-5	5	53.958/53.978	59.000/59.019	18.500	2.502	0.020/0.082	AL-LF	02-3085U		
TW/A	2	59.500	73.200		1.975		AL-LF	04-3527	A123/4 STD	
TW/A	2	59.500	73.200		1.975		AL-LF	04-3528		

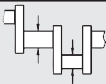
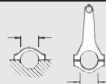

1029		82.50	Petrol		
ADW	4 Cyl.	1985cc	79kW (107)PS	TD243 630	
80	11/93→01/96		A6	08/95→07/96	





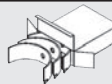

BE/PL	4	47.758/47.778	50.600/50.612	19.000	1.406	0.020/0.067	EC	71-3694	71-3694/4 STD 0.25 0.50	
MB/HL	4	53.958/53.978	59.000/59.019	18.500	2.502	0.020/0.082	AL-LF	02-3085L	H027/5 STD 0.25 0.50	
MB/HL	6	53.958/53.978	59.000/59.019	18.500	2.502	0.020/0.082	AL-LF	02-3085U		
TW/A	2	59.500	73.200		1.975		AL-LF	04-3527	A123/4 STD	
TW/A	2	59.500	73.200		1.975		AL-LF	04-3528		
BU	1	42.959/42.975	46.055/46.095	15.000			AL-LF	07-3088	07-3088 STD SEMI	[68]
BU	1	41.959/41.975	45.000/45.025	15.000			AL-LF	07-3089	07-3089 STD SEMI	[68]

1030	 82.50	Petrol	
7A	5 Cyl.	2309cc	125kW (170)PS
90	06/88→09/91	COUPE	11/88→12/96
			TD221 631

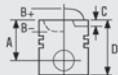
		
	<p>08-501200-00 STD 12/90→</p> <p>1.20  P PS 1.75  P 3.00  CR P</p>	
	<p>08-991000-00 STD 08/88→11/90</p> <p>1.50  P PS 1.75  P 3.00  CR P</p>	

										
BE/PL	5	47.758/47.778	50.600/50.612	19.000	1.406	0.020/0.067	EC	71-3694	71-3694/5 STD 0.25	
MB/HL 1-6	6	57.958/57.978	63.000/63.019	18.500	2.502	0.020/0.082	EC	72-3400	H981/6 STD 0.25	
TW/A	2	63.500/63.750	77.200/77.450		1.975		AL-LF	04-3529	A124/4 STD	
TW/A	2	63.500/63.750	77.200/77.450		1.975		AL-LF	04-3530		
TW/A	2	63.500/63.750	76.950/77.200		1.975		AL-LF	04-4782	A292/4 STD	
TW/A	2	63.500/63.750	76.950/77.200		1.975		AL-LF	04-4783		
SE/PB	1	20.000	23.000/23.021	25.000			BC	55-3698	55-3698 SEMI	

1031	 82.50	Petrol	
AAR	5 Cyl.	2309cc	98kW (133)PS
100	01/90→06/94	A6	06/94→12/95
			TD4194 632

		
	<p>08-991400-00 STD 08-991407-00 0.50mm</p> <p>1.50  CR P 1.75  P 3.00  CR[52]</p>	

[52] Steel

[52] Stahl

1031



82.50
Petrol

BE/PL	5	47.758/47.778	50.600/50.612	19.000	1.406	0.020/0.067	EC	71-3694	71-3694/5 STD 0.25
MB/HL 1-6	6	57.958/57.978	63.000/63.019	18.500	2.502	0.020/0.082	EC	72-3400	H981/6 STD 0.25
TW/A	2	63.500/63.750	77.200/77.450		1.975		AL-LF	04-3529	A124/4 STD
TW/A	2	63.500/63.750	77.200/77.450		1.975		AL-LF	04-3530	
TW/A	2	63.500/63.750	76.950/77.200		1.975		AL-LF	04-4782	A292/4 STD
TW/A	2	63.500/63.750	76.950/77.200		1.975		AL-LF	04-4783	
SE/PB	1	20.000	23.000/23.021	25.000			BC	55-3698	55-3698 SEMI

1032

82.50
Petrol

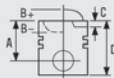
NF	5 Cyl.		2309cc		100kW (136)PS		TD301	633
NG	5 Cyl.	10:1	2309cc		98-100kW (133-136)PS		TD302	634
80	10/87→01/96		90	04/87→09/91		100	08/86→11/90	
200	11/86→09/91		CABRIOLET	05/91→07/94		COUPE	01/87→12/96	









08-991400-00 STD
08-991407-00 0.50mm

1.50 CR P
 1.75 P
 3.00 CR[52]

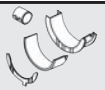

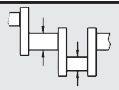
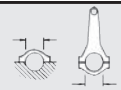

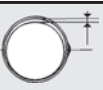
[52] Steel

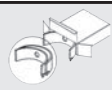
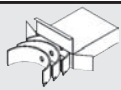

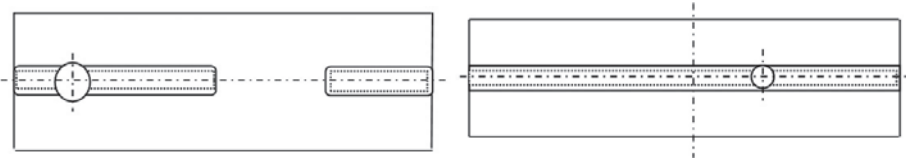

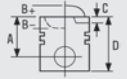
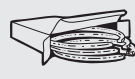

[52] Stahl

...Continued

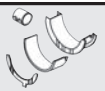
1032		 82.50		Petrol					
									
BE/PL	5	47.758/47.778	50.600/50.612	19.000	1.406	0.020/0.067	EC	71-3694	71-3694/5 STD 0.25
MB/HL 1-6	6	57.958/57.978	63.000/63.019	18.500	2.502	0.020/0.082	EC	72-3400	H981/6 STD 0.25
TW/A	2	63.500/63.750	77.200/77.450		1.975		AL-LF	04-3529	A124/4 STD
TW/A	2	63.500/63.750	77.200/77.450		1.975		AL-LF	04-3530	
TW/A	2	63.500/63.750	76.950/77.200		1.975		AL-LF	04-4782	A292/4 STD
TW/A	2	63.500/63.750	76.950/77.200		1.975		AL-LF	04-4783	
SE/PB	1	20.000	23.000/23.052	25.000			BC	55-3567	55-3567 SEMI
Mot. → ch44L300000									
SE/PB	1	20.000	23.000/23.021	25.000			BC	55-3698	55-3698 SEMI
55-3567					55-3698				

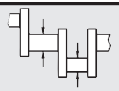
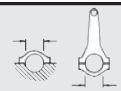

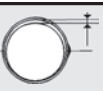
1033		 82.50		Petrol					
ABC	V6 Cyl.	2598cc	110kW (150)PS	TD231	636				
ACZ	V6 Cyl.	2598cc	102kW (139)PS	TD239	637				
80	06/92 → 01/96	100	03/92 → 07/94	A4	01/95 → 09/01				
A6	06/94 → 12/97	CABRIOLET	06/93 → 08/00	COUPE	08/92 → 12/96				
									
			08-991400-00 STD 08-991407-00 0.50mm						
			1.50  CR P 1.75  P 3.00  CR[52]						
[52] Steel		[52] Stahl							

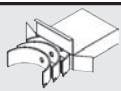
									
BE/PL	6	53.958/53.978	57.600/57.612	17.000	1.806	0.020/0.069	EC	71-3711	71-3711/6 STD
MB/HL 1-4	4	64.959/64.978	70.000/70.019	18.000	2.508	0.020/0.070	EC	72-3712	H034/4 STD 0.25
TW/A	2	70.500	84.900		1.965		AL-LF	04-3713	A138/4 STD
TW/A	2	70.500	84.900		1.965		AL-LF	04-3714	

1034

82.50
Petrol

AAH	V6 Cyl.	2771cc	128kW (174)PS	TD224	638
80	09/91→01/96	100	12/90→06/94	A4	01/95→07/97
A6	06/94→12/97	A8	03/94→03/96	CABRIOLET	11/92→08/00
COUPE	08/91→12/96				

87-501800-10	STD	08-501800-00	STD		
87-501807-10 [21]	0.50mm	08-501807-00	0.50mm		
A 30.80		1.20	PS		
B- 4.25		1.50	P		
B+ 0.70		2.00	CR P		
BØ 61.00					
D 52.50					
21x55					

[21] A = 30.500, D = 52.200

[21] A = 30.500, D = 52.200

BE/PL	6	53.958/53.978	57.600/57.612	17.000	1.806	0.020/0.069	EC	71-3711	71-3711/6	STD	
MB/HL	4	64.959/64.978	70.000/70.019	18.000	2.508	0.020/0.070	EC	72-3712	H034/4	STD 0.25	
TW/A	2	70.500	84.900		1.965		AL-LF	04-3713	A138/4	STD	
TW/A	2	70.500	84.900		1.965		AL-LF	04-3714			







1035



82.50
Petrol

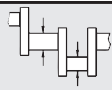
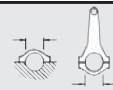



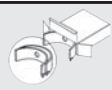
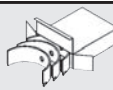



ACK	V6 Cyl.	10.6:1	2771cc	142kW (193)PS	TD4197	639
ACK	V6 Cyl.	10.6:1	2771cc	142kW (193)PS	TD5560	639
AEJ	V6 Cyl.		2771cc	120-128kW (163-174)PS	TD9541	640
AFC	V6 Cyl.		2771cc	120kW (163)PS	TD246	641
ALG	V6 Cyl.		2771cc	142kW (193)PS	TD9516	642
ALG	V6 Cyl.		2771cc	142kW (193)PS	TD16260	642
AMX	V6 Cyl.	10.6:1	2771cc	142kW (193)PS	TD13930	644
AMX	V6 Cyl.	10.6:1	2771cc	142kW (193)PS	TD15155	644
AMX	V6 Cyl.	10.6:1	2771cc	142kW (193)PS	TD16367	644
APR	V6 Cyl.	10.6:1	2771cc	142kW (193)PS	TD13931	642
APR	V6 Cyl.	10.6:1	2771cc	142kW (193)PS	TD15808	642
AQD	V6 Cyl.	10.6:1	2771cc	142kW (193)PS	TD13932	642
AQD	V6 Cyl.	10.6:1	2771cc	142kW (193)PS	TD16259	642
A4	10/96→09/01	A6	06/94→01/05	A8	07/95→09/02	
PASSAT	08/96→05/05	SUPERB	12/01→03/08			

08-501800-00	STD	08-501807-00	0.50mm		
1.20	PS				
1.50	P				
2.00	CR P				

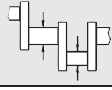
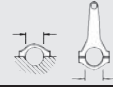

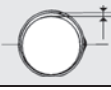

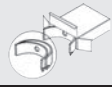
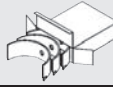

...Continued

1035		 82.50	Petrol							
										
BE/PL	6	53.958/53.978	57.600/57.612	17.000	1.806	0.020/0.069	EC	71-3711	71-3711/6 STD	
TW/A	2	70.500	84.900		1.965		AL-LF	04-3713	A138/4 STD	
TW/A	2	70.500	84.900		1.965		AL-LF	04-3714		

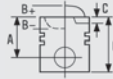
1036		 82.50	Petrol							
AGE	V6 Cyl.		2771cc			132kW (180)PS			TD15616	642
AGE	V6 Cyl.		2771cc			132kW (180)PS			TD16251	642
ASN	V6 Cyl.	10.5:1	2976cc			162kW (220)PS			TD15346	648
ATQ	V6 Cyl.		2771cc			142kW (193)PS			TD16422	645
ATX	V6 Cyl.		2771cc			140kW (190)PS			TD15617	646
ATX	V6 Cyl.		2771cc			140kW (190)PS			TD16252	646
BBG	V6 Cyl.	10.6:1	2771cc			140kW (190)PS			TD18754	647
BBG	V6 Cyl.	10.6:1	2771cc			140kW (190)PS			TD19142	647
A4	03/99→12/05		A6	10/97→01/05		A8	07/03→05/05			
PASSAT	05/97→05/05		SUPERB	06/02→03/08						

									
BE/PL	6	53.958/53.978	57.600/57.612	17.000	1.806	0.020/0.069	EC	71-3711	71-3711/6 STD
MB/HL 1-4	4	64.959/64.978	70.000/70.019	18.000	2.508	0.020/0.070	EC	72-3712	H034/4 STD 0.25
TW/A	2	70.500	84.900		1.965		AL-LF	04-3713	A138/4 STD
TW/A	2	70.500	84.900		1.965		AL-LF	04-3714	

1037		 83.00	Petrol							
H	Boxer4 Cyl.	7.5:1	1493cc			32kW (44)PS			TD4103	653
181	09/69→07/70		KAEFER	01/66→11/73		KARMANN GHIA	01/66→12/69			

		
	08-394800-00 STD	
	2.00  P	
	2.00  P	
	4.00  CR[52]	

[52] Steel

[52] Stahl

1037

83.00
Petrol

BE/PL	4	54.971/54.990	57.800/57.819	17.600	1.397	0.020/0.079	EC	71-1950	71-1950/4 STD 0.25 0.50
MB/HL 1	1	54.971/54.990	65.000/65.019	26.936	4.987	0.036/0.099	AL	2931ATA	H1025/4 STD
MB/HL 2	1	54.971/54.990	65.000/65.019	22.000	5.035	0.020/0.038	BS	2932CP	
MB/HL 4	1	39.984/40.000	50.000/50.016	15.000	4.983	0.034/0.091	AL	2933AT	
MB/HL 3	1	54.971/54.990	65.000/65.019	22.000	4.990	0.030/0.039	AL	2934AT	
SE/PB	1	20.000	22.000	24.400			BC	55-2567	55-2567 SEMI
SE/PB	1	22.000	23.970/24.003	23.400			BC	55-2723	55-2723 SEMI
CB/NWB 1	2	24.987/25.000	27.500/27.521	20.000	1.245		BB	13-2368	N072/3 STD
CB/NWB 2	2	24.987/25.000	27.500/27.521	23.000	1.245		BB	13-2369	
CB/NWB 3	1	24.987/25.000	27.500/27.521	28.000	1.245		BB	13-2370HL	
CB/NWB 3	1	24.987/25.000	27.500/27.521	25.000	1.245		BB	13-2370U	



1038

83.00
Diesel







ASB	V6 Cyl.		2967cc		171kW (233)PS		TD17336	656
BKN	6 Cyl.		2967cc		150kW (204)PS		TD18027	654
BMK	V6 Cyl.	17:1	2967cc		165kW (224)PS		TD17845	656
BMK	V6 Cyl.	17:1	2967cc		165kW (224)PS		TD18023	656
BUG	V6 Cyl.		2967cc		171kW (233)PS		TD18996	658

A4	11/04 → 03/09	A6	05/04 → 08/11	A6 Allroad	05/06 → 10/08
A8	08/03 → 07/10	PHAETON	09/04 →	Q7	03/06 → 05/08

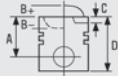
87-434300-00 87-434307-00	STD 0.50mm	08-434300-00 08-434307-00
A 46.30 B- 15.10 BØ 45.00 D 70.80 30x68		2.00 CK 2.00 3.00 CR
AK KK RT		



1039		 83.00	Diesel		
CAMA	V6 Cyl.	2698cc	140kW (190)PS	TD20006	655
CAMB	V6 Cyl.	2698cc	120kW (163)PS	TD20599	655
CAP	V6 Cyl.	2967cc	176kW (239)PS	TD20007	655
CARB	V6 Cyl.	2967cc	176kW (239)PS	TD22605	
CASA	V6 Cyl.	2967cc	176kW (239)PS	TD20709	655
CASA	V6 Cyl.	2967cc	176kW (239)PS	TD20865	655
CASC	V6 Cyl.	2967cc	176kW (239)PS	TD22560	655
CCWA	V6 Cyl.	2967cc	176kW (239)PS	TD20600	655
CCWB	V6 Cyl.	2967cc	155kW (211)PS	TD21029	655
CDYA	V6 Cyl.	2967cc	176kW (239)PS	TD21177	655
CDYC	V6 Cyl.	2967cc	176kW (239)PS	TD22973	655
CEXA	V6 Cyl.	2967cc	176kW (239)PS	TD22389	655
CGKA	V6 Cyl.	2698cc	140kW (190)PS	TD21065	655
CGKB	V6 Cyl.	2698cc	120kW (163)PS	TD21064	655
CJGA	V6 Cyl.	2967cc	176kW (239)PS	TD24959	
CJMA	V6 Cyl.	2967cc	150kW (204)PS	TD24397	
CJMA	V6 Cyl.	2967cc	150kW (204)PS	TD24892	







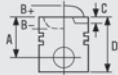

A4	11/07→	A4 Allroad	04/09→	A5	06/07→
A6	10/08→08/11	A6 Allroad	10/08→08/11	PHAETON	11/08→
Q5	11/08→	Q7	11/07→	TOUAREG	11/07→

		
	<p>08-433100-00 STD</p> <p>08-433105-00 0.25mm</p> <p>08-433107-00 0.50mm</p> <p>1.75  GDC[52]</p> <p>2.00  MO P</p> <p>3.00  CR P</p>	

[52] Steel



[52] Stahl











1040		 83.00	Diesel		
CAND	V6 Cyl.	16.8:1	2698cc	120kW (163)PS	TD23099 655
A6	06/05→08/11	A6 Allroad	05/06→08/11		

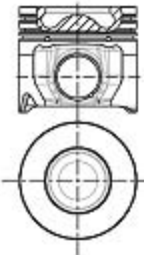

		
	<p>08-433100-00 STD</p> <p>08-433105-00 0.25mm</p> <p>08-433107-00 0.50mm</p> <p>1.75  GDC[52]</p> <p>2.00  MO P</p> <p>3.00  CR P</p>	
	<p>08-434300-00 STD</p> <p>08-434307-00 0.50mm</p> <p>2.00  CK</p> <p>2.00  CR</p> <p>3.00  CR</p>	







[52] Steel

[52] Stahl

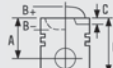
1041		 83.00	Diesel		
BKS	V6 Cyl.	17:1	2967cc	165kW (224)PS	TD18031 654
BNG	V6 Cyl.		2967cc	155kW (211)PS	TD17337 656
BUN	V6 Cyl.		2967cc	155kW (211)PS	TD19881 654
BUN	V6 Cyl.		2967cc	155kW (211)PS	TD21182 654
CASB	V6 Cyl.	16.8:1	2967cc	155kW (211)PS	TD21315 655
CASB	V6 Cyl.	16.8:1	2967cc	155kW (211)PS	TD22636 655
CATA	V6 Cyl.	16.8:1	2967cc	165kW (224)PS	TD22637 655
CATA	V6 Cyl.	16.8:1	2967cc	165kW (224)PS	TD22660 655
CDYB	V6 Cyl.		2967cc	155kW (211)PS	TD22955 655
A6	05/04→08/11		A6 Allroad	05/06→08/11	A8 11/03→07/10
Q7	03/06→05/12		TOUAREG	11/04→05/10	

		
87-434300-00 STD 87-434307-00 0.50mm A 46.30 B- 15.10 BØ 45.00 D 70.80  30x68 AK KK RT	 08-434300-00 STD 08-434307-00 0.50mm 2.00  CK 2.00  CR 3.00  08-433100-00 STD 08-433105-00 0.25mm 08-433107-00 0.50mm 1.75  GD[52] 2.00  MO P 3.00  CR P	
[52] Steel	[52] Stahl	









1042		 83.00	Diesel		
CASD	V6 Cyl.		2967cc	150kW (204)PS	TD24893 655
CCMA	V6 Cyl.		2967cc	176kW (239)PS	TD21316 655
Q7	11/07→		TOUAREG	01/10→	

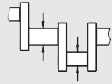
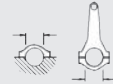

		
	08-433100-00 STD 08-433105-00 0.25mm 08-433107-00 0.50mm 1.75  GD[52] 2.00  MO P 3.00  CR P	
[52] Steel	[52] Stahl	

1043



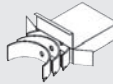



84.00
Petrol

AD Boxer4 Cyl. 1584cc **35-37kW (48-50)PS** TD4016 **661**
KAEFER 01/70→12/79 **KARMANN GHIA** 01/70→07/74 **TRANSPORTER** 08/68→07/79

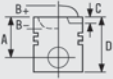







									
BE/PL	4	54.971/54.990	57.800/57.819	17.600	1.397	0.020/0.079	EC	71-1950	71-1950/4 STD 0.25 0.50
MB/HL 1	1	54.971/54.990	65.000/65.019	26.936	4.987	0.036/0.099	AL	2931ATA	H1025/4 STD
MB/HL 2	1	54.971/54.990	65.000/65.019	22.000	5.035	0.020/0.038	BS	2932CP	
MB/HL 4	1	39.984/40.000	50.000/50.016	15.000	4.983	0.034/0.091	AL	2933AT	
MB/HL 3	1	54.971/54.990	65.000/65.019	22.000	4.990	0.030/0.039	AL	2934AT	
SE/PB	1	20.000	22.000	24.400			BC	55-2567	55-2567 SEMI
SE/PB	1	22.000	23.970/24.003	23.400			BC	55-2723	55-2723 SEMI
CB/NWB 1	2	24.987/25.000	27.500/27.521	20.000	1.245		BB	13-2368	N072/3 STD
CB/NWB 2	2	24.987/25.000	27.500/27.521	23.000	1.245		BB	13-2369	
CB/NWB 3	1	24.987/25.000	27.500/27.521	28.000	1.245		BB	13-2370HL	
CB/NWB 3	1	24.987/25.000	27.500/27.521	25.000	1.245		BB	13-2370U	

1044	 84.00	Petrol				
AXJ	V6 Cyl.	3189cc	165kW (224)PS	TD15471	665	
AYT	V6 Cyl.	3189cc	177kW (240)PS	TD16481	664	
AZZ	V6 Cyl.	11:1	3189cc	162kW (220)PS	TD17041	664
BAA	V6 Cyl.	11.3:1	3189cc	162kW (220)PS	TD20531	664
BDB	V6 Cyl.		3189cc	184kW (250)PS	TD17068	664
BDL	V6 Cyl.	11.3:1	3189cc	170kW (231)PS	TD16870	664
BFH	V6 Cyl.		3189cc	177kW (240)PS	TD16526	664
BHE	V6 Cyl.	11.3:1	3189cc	184kW (250)PS	TD17029	664
BKJ	V6 Cyl.	11:1	3189cc	162kW (220)PS	TD17042	664
BKK	V6 Cyl.		3189cc	173kW (235)PS	TD17186	664
BKL	V6 Cyl.	11.3:1	3189cc	177kW (240)PS	TD18024	664
BMJ	V6 Cyl.		3189cc	184kW (250)PS	TD17407	664
BMV	V6 Cyl.	11.3:1	3189cc	162kW (220)PS	TD20525	664
BMX	V6 Cyl.		3189cc	177kW (240)PS	TD19256	664
BPF	V6 Cyl.	11.3:1	3189cc	184kW (250)PS	TD20524	664
BPF	V6 Cyl.	11.3:1	3189cc	184kW (250)PS	TD20705	664
BRK	V6 Cyl.	11.3:1	3189cc	177kW (240)PS	TD18025	664
BUB	V6 Cyl.		3189cc	184kW (250)PS	TD18472	664
BUB	V6 Cyl.		3189cc	184kW (250)PS	TD19200	664
CBR	V6 Cyl.		3189cc	184kW (250)PS	TD20023	663
CBRA	V6 Cyl.	11.3:1	3189cc	184kW (250)PS	TD22178	664
CFLA	V6 Cyl.		3189cc	173kW (235)PS	TD20920	666

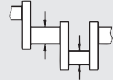
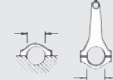
A3	07/03→05/09	EOS	06/06→	GOLF	09/02→11/08
MULTIVAN	11/03→11/09	NEW BEETLE	04/00→05/01	PHAETON	04/02→
TOUAREG	10/02→11/06	TRANSPORTER	04/03→11/09	TT	07/03→06/10

		
	08-137400-00 STD	
	1.20  NT[52]	
	1.50  P	
	2.00  CR[52]	

[52] Steel [52] Stahl

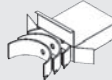
									
BE/PL	6	53.958/53.978	56.800/56.819	17.000	1.406	0.020/0.074	AL-LF	01-3841	01-3841/6 STD 0.25
MB/HL 1-7	7	59.958/59.978	65.000/65.010	17.000	2.501	0.020/0.075	AL-LF	02-3716	H035/7 STD 0.25
TW/A	2	65.450	80.000		1.723		AL-LF	04-3717	A139/4 STD
TW/A	2	65.450	80.000		1.723		AL-LF	04-3718	
SE/PB	1		23.000/23.052	20.000			BC	55-3719	55-3719 SEMI
BU	1	42.959/42.975	46.055/46.095	15.000			AL-LF	07-3088	07-3088 STD SEMI [68]
BU	1	14.473/14.484	17.500/17.518	20.000			BB	17-3720	17-3720 SEMI [68]

1045	84.00	Petrol				
BJS	V6 Cyl.	11.3:1	3189cc	177kW (240)PS	TD25200	
BRJ	V6 Cyl.	10.8:1	3189cc	162kW (220)PS	TD20526	664
GOLF	01/04→11/08	TOUAREG	10/02→11/06			

BE/PL	6	53.958/53.978	56.800/56.819	17.000	1.406	0.020/0.074	AL-LF	01-3841	01-3841/6 STD 0.25	
MB/HL 1-7	7	59.958/59.978	65.000/65.010	17.000	2.501	0.020/0.075	AL-LF	02-3716	H035/7 STD 0.25	
TW/A	2	65.450	80.000		1.723		AL-LF	04-3717	A139/4 STD	
TW/A	2	65.450	80.000		1.723		AL-LF	04-3718		
SE/PB	1		23.000/23.052	20.000			BC	55-3719	55-3719 SEMI	
BU	1	42.959/42.975	46.055/46.095	15.000			AL-LF	07-3088	07-3088 STD SEMI	[68]
BU	1	14.473/14.484	17.500/17.518	20.000			BB	17-3720	17-3720 SEMI	[68]

1046	84.00	Petrol				
BML	V6 Cyl.	11.3:1	3189cc	177kW (240)PS	TD20523	664
GOLF	09/02→06/05					

	08-137400-00 STD	
	1.20 NT[52]	
	1.50 P	
	2.00 CR[52]	

[52] Steel [52] Stahl

1047	84.50	Petrol				
BDX	V6 Cyl.	12:1	2773cc	154kW (210)PS	TD20108	
CCDA	V6 Cyl.		2773cc	140kW (190)PS	TD21174	671
CCEA	V6 Cyl.		2773cc	162kW (220)PS	TD21175	671
A6	11/06→08/11	A8	08/07→07/10			

BE/PL	6	53.958/53.978	56.800/56.819	17.000	1.406	0.010/0.069	AL-LF	01-4818	01-4818/6 STD
MB/HL 1-4	4	57.958/57.978	63.000/63.019	18.500	2.503	0.026/0.085	AL-LF	02-4819	H1300/4 STD

1048

84.50
Petrol

AUK V6 Cyl. 3123cc **188kW (256)PS** **TD17376** **672**
A4 01/05→03/09 **A6** 05/04→05/09 **A6 Allroad** 05/06→10/08

MB/HL 1-4	4	64.959/64.978	70.000/70.019	18.000	2.508	0.020/0.070	EC	72-3712	H034/4 STD 0.25 A138/4 STD
TW/A	2	70.500	84.900		1.965		AL-LF	04-3713	
TW/A	2	70.500	84.900		1.965		AL-LF	04-3714	

1049

84.50
Petrol

AEW V8 Cyl. 3697cc **169kW (230)PS** **TD4201** **673**
A8 07/95→12/98

BE/PL	8	53.958/53.978	56.800/56.819	17.000	1.406	0.020/0.074	AL-LF	01-3841	01-3841/8 STD

1050

84.50
Petrol



AKC V8 Cyl. 11:1 3697cc **191kW (260)PS** **TD15343**
AQG V8 Cyl. 11:1 3697cc **191kW (260)PS** **TD11358**
A6 03/99→01/05 **A8** 11/98→09/02







	08-139600-00 STD	
	1.20 NT[52]	
	1.50 P	
	3.00 NT[52]	

[52] Steel

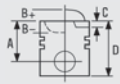

[52] Stahl







BE/PL	8	49.958/49.978	53.200/53.219	18.000	1.601	0.020/0.084	EC	71-3933	71-3933/8 STD A138/4 STD
TW/A	2	70.500	84.900		1.965		AL-LF	04-3713	
TW/A	2	70.500	84.900		1.965		AL-LF	04-3714	

1051		 84.50	Petrol			
ANK	V8 Cyl.	11:1	4172cc	250kW (340)PS	TD15338	
AQF	V8 Cyl.	11:1	4172cc	228kW (310)PS	TD11357	
AQJ	V8 Cyl.	11:1	4172cc	250kW (340)PS	TD15339	
ARS	V8 Cyl.	11:1	4172cc	220kW (299)PS	TD12107	
ASG	V8 Cyl.	11:1	4172cc	220kW (299)PS	TD15337	
AUW	V8 Cyl.	11:1	4172cc	228kW (310)PS	TD15342	
AUX	V8 Cyl.	11:1	4172cc	228kW (310)PS	TD15341	
AVP	V8 Cyl.	11:1	4172cc	265kW (360)PS	TD15340	
AWN	V8 Cyl.	11:1	4172cc	220kW (299)PS	TD15336	
BAS	V8 Cyl.	11:1	4172cc	220kW (299)PS	TD16433	
BFL	V8 Cyl.	11:1	3697cc	206kW (280)PS	TD17031	
BFM	V8 Cyl.	11:1	4172cc	246kW (335)PS	TD17032	
A6	11/98→01/05	A8	11/98→07/10	ALLROAD	07/02→08/05	

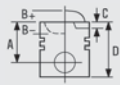







		
<p>08-139600-00 STD</p> <p>1.20  NT[52]</p> <p>1.50  P</p> <p>3.00  NT[52]</p>		

[52] Steel [52] Stahl

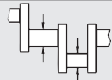
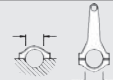
1052		 84.50	Petrol			
AXQ	V8 Cyl.	11:1	4172cc	228kW (310)PS	TD16853	
TOUAREG	12/02→11/06					

		
<p>08-139600-00 STD</p> <p>1.20  NT[52]</p> <p>1.50  P</p> <p>3.00  NT[52]</p>		

[52] Steel [52] Stahl

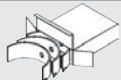





									
BE/PL	1	53.958/53.978	57.600/57.619	18.000	1.801	0.020/0.084	EC	71-3932	71-3932 STD
TW/A	2	70.500	84.900		1.965		AL-LF	04-3713	A138/4 STD
TW/A	2	70.500	84.900		1.965		AL-LF	04-3714	

1053

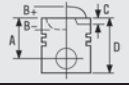
 **84.50**
Petrol

BGH	V8 Cyl.	11:1	4172cc	246kW (335)PS	TD17018
BGJ	V8 Cyl.	11:1	4172cc	246kW (335)PS	TD18026
BHX	V8 Cyl.	11:1	4172cc	228kW (310)PS	TD16854

PHAETON 05/03 →

		
	08-139600-00 STD 1.20  NT[52] 1.50  P 3.00  NT[52]	

[52] Steel









[52] Stahl

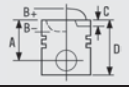







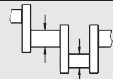

1054

 **85.50**
Petrol









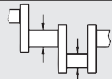

AE	Boxer 4 Cyl.	7.5:1	1584cc	35-37kW (48-50)PS	TD5133	680
AH	Boxer 4 Cyl.		1584cc	35-37kW (48-50)PS	TD4018	
AJ	Boxer 4 Cyl.		1584cc	37kW (50)PS	TD4024	
AK	Boxer 4 Cyl.		1584cc	35kW (47)PS	TD5134	
AL	Boxer 4 Cyl.		1584cc	35kW (47)PS	TD14189	
AM	Boxer 4 Cyl.	6.6:1	1584cc	35kW (47)PS	TD14190	
AS	Boxer 4 Cyl.	7.5:1	1584cc	37kW (50)PS	TD4030	681
B	Boxer 4 Cyl.		1584cc	35kW (47)PS	TD5137	
U	Boxer 4 Cyl.		1584cc	40kW (54)PS	TD5030	

181	03/73 → 02/79	1500,1600	08/65 → 07/73	KAEFER	07/69 → 12/79
KARMANN GHIA	07/71 → 07/74	TRANSPORTER	08/64 → 07/79		

		
	08-394600-00 STD 2.00  P 2.00  P 5.00  P 08-394614-10 1.50mm 2.00  P 2.00  P 5.00  P	









									
BE/PL	4	54.971/54.990	57.800/57.819	17.600	1.397	0.020/0.079	EC	71-1950	71-1950/4 STD 0.25 0.50
MB/HL 1	1	54.971/54.990	65.000/65.019	26.936	4.987	0.036/0.099	AL	2931ATA	H1025/4 STD
MB/HL 2	1	54.971/54.990	65.000/65.019	22.000	5.035	0.020/0.038	BS	2932CP	
MB/HL 4	1	39.984/40.000	50.000/50.016	15.000	4.983	0.034/0.091	AL	2933AT	
MB/HL 3	1	54.971/54.990	65.000/65.019	22.000	4.990	0.030/0.039	AL	2934AT	









...Continued

1054		 85.50	Petrol						
									
SE/PB	1	20.000	22.000	24.400			BC	55-2567	55-2567 SEMI
SE/PB	1	22.000	23.970/24.003	23.400			BC	55-2723	55-2723 SEMI
CB/NWB 1	2	24.987/25.000	27.500/27.521	20.000	1.245		BB	13-2368	N072/3 STD
CB/NWB 2	2	24.987/25.000	27.500/27.521	23.000	1.245		BB	13-2369	
CB/NWB 3	1	24.987/25.000	27.500/27.521	28.000	1.245		BB	13-2370HL	
CB/NWB 3	1	24.987/25.000	27.500/27.521	25.000	1.245		BB	13-2370U	

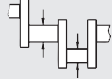
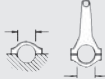

1055		 85.50	Petrol						
CZ	Boxer 4 Cyl.	7.5:1	1584cc	34kW (46)PS					TD4053 682
P	Boxer 4 Cyl.		1584cc	37kW (50)PS					TD5139



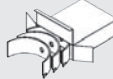



1500,1600 07/64 → 07/73

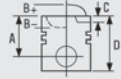

		
	08-394600-00 STD	
	2.00  P	
	2.00  P	
	5.00  P	
	08-394614-10 1.50mm	
	2.00  P	
	2.00  P	
	5.00  P	









									
BE/PL	4	54.971/54.990	57.800/57.819	17.600	1.397	0.020/0.079	EC	71-1950	71-1950/4 STD 0.25 0.50
MB/HL 1	1	54.971/54.990	65.000/65.019	26.936	4.987	0.036/0.099	AL	2931ATA	H1025/4 STD
MB/HL 2	1	54.971/54.990	65.000/65.019	22.000	5.035	0.020/0.038	BS	2932CP	
MB/HL 4	1	39.984/40.000	50.000/50.016	15.000	4.983	0.034/0.091	AL	2933AT	
MB/HL 3	1	54.971/54.990	65.000/65.019	22.000	4.990	0.030/0.039	AL	2934AT	
SE/PB	1	20.000	22.000	24.400			BC	55-2567	55-2567 SEMI
SE/PB	1	22.000	23.970/24.003	23.400			BC	55-2723	55-2723 SEMI
CB/NWB 1	2	24.987/25.000	27.500/27.521	20.000	1.245		BB	13-2368	N072/3 STD
CB/NWB 2	2	24.987/25.000	27.500/27.521	23.000	1.245		BB	13-2369	
CB/NWB 3	1	24.987/25.000	27.500/27.521	28.000	1.245		BB	13-2370HL	
CB/NWB 3	1	24.987/25.000	27.500/27.521	25.000	1.245		BB	13-2370U	

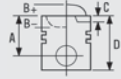

01/65 →







1056	 85.50	Petrol			
ACD	Boxer4 Cyl.	6.6:1	1584cc	34kW (46)PS	TD9471
KAEFER	10/92→07/03				

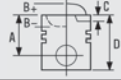

		
	08-405300-10 STD 08-405314-10 1.50mm 08/79→ 1.75  P 2.00  P 5.00  P	







1057	 85.50	Petrol		
T	Boxer4 Cyl.	1584cc	40kW (54)PS	TD5029
1500,1600	08/65→07/73			

		
	08-394600-00 STD 2.00  P 2.00  P 5.00  P 08-394614-10 1.50mm 2.00  P 2.00  P 5.00  P	

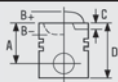
1058	 86.50	Petrol				
CH	4 Cyl.	8.2/8.3:1	1984cc	55kW (75)PS	TD4044	686
LT 28-35	04/75→09/83		LT 40-55	04/75→09/83		



		
	08-399700-10 STD 08-399707-10 0.50mm 2.00  CR P 2.50  P 5.00  CR P	







1059	 93.00	Petrol			
AN	4 Cyl.	1795cc	63kW (85)PS	TD5130	
AP	4 Cyl.	1795cc	50-63kW (68-85)PS	TD4991 692	
AT	4 Cyl.	7.5:1	1795cc	55kW (75)PS	TD5131
412	07/73→03/75	411,412	07/73→03/75	TRANSPORTER	11/73→07/75

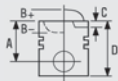

		
	08-398800-00 STD 2.00  P 2.00  P 4.00  CR[52]	







[52] Steel

[52] Stahl

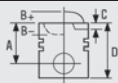
1060	 93.00	Diesel			
AGK	4 Cyl.	2799cc	92kW (125)PS	TD9522	
ATA	4 Cyl.	2799cc	96kW (131)PS	TD13444	
AUH	4 Cyl.	2799cc	116kW (158)PS	TD16450	
BCQ	4 Cyl.	17.8:1	2798cc	116kW (158)PS	TD20509
LT 28-35	02/97→06/06	LT 28-46	06/97→07/06		

		
	08-143000-00 STD 2.50  CR P 2.00  P 3.00  CR P	

1061	 94.00	Petrol			
CJ	Boxer4 Cyl.	7.3:1	1970cc	51kW (70)PS	TD4045 701
CU	Boxer4 Cyl.	7.3:1	1970cc	51kW (70)PS	TD4050 702
CV	Boxer4 Cyl.		1970cc	51kW (70)PS	TD4051 702
DG	Boxer4 Cyl.	8.4:1	1888cc	57kW (77)PS	TD4993 699
GE	4 Cyl.	7.3:1	1970cc	51kW (70)PS	TD3587
GE	Boxer4 Cyl.	7.3:1	1970cc	51kW (70)PS	TD5005 704
SP	Boxer4 Cyl.		1915cc	54kW (73)PS	TD4152 697
TRANSPORTER	08/75→07/92				

		
	08-399100-00 STD 08-399105-00 0.25mm 08-399107-00 0.50mm 08-399111-00 1.00mm 1.75  P 2.00  P 4.00  P	

VW GROUP

1062







 94.00



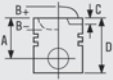





Petrol

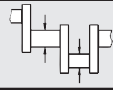
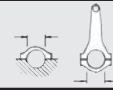

DF	4 Cyl.	8.4:1	1915cc	44kW (60)PS	TD4058	693
DH	Boxer4 Cyl.	8.5:1	1913cc	60kW (81)PS	TD3580	694
DH	Boxer4 Cyl.	8.5:1	1913cc	60kW (81)PS	TD4994	700
GW	Boxer4 Cyl.		1913cc	66kW (89)PS	TD4099	700

TRANSPORTER 08/82 → 07/92

		
	<p>08-399100-00 STD 08-399105-00 0.25mm 08-399107-00 0.50mm 08-399111-00 1.00mm</p> <p>1.75  P 2.00  P 4.00  P</p>	

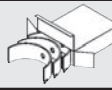
									
BE/PL	4	54.971/54.990	57.800/57.819	17.600	1.397	0.020/0.079	EC	71-1950	71-1950/4 STD 0.25 0.50

1063







 94.00

Petrol

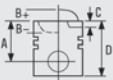









DJ	Boxer4 Cyl.	10.3:1	2109cc	82kW (111)PS	TD4059	696
MV	Boxer4 Cyl.	8.7:1	2109cc	70kW (95)PS	TD4133	696
SR	4 Cyl.		2109cc	64kW (87)PS	TD4153	696
SS	4 Cyl.		2109cc	68kW (92)PS	TD4154	698

TRANSPORTER 08/85 → 07/92

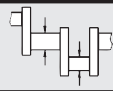
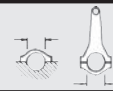
		
	<p>08-990000-00 STD</p> <p>1.75  CR P 2.00  P 3.50  CR[52]</p>	

[52] Steel

[52] Stahl

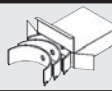
									
BE/PL	4	54.971/54.990	57.800/57.819	17.600	1.397	0.020/0.079	EC	71-1950	71-1950/4 STD 0.25 0.50

		9
07-3089	535	821
07-3089	539	824
07-3089	542	826
07-3089	544	827
07-3089	546	829
07-3089	553	834
07-3089	566	848
07-3089	585	867
07-3089	586	868
07-3089	588	872
07-3089	593	877
07-3089	594	880
07-3089	596	881
07-3089	598	882
07-3089	601	884
07-3089	603	885
07-3089	605	886
07-3089	606	887
07-3089	606	888
07-3089	608	889
07-3089	609	890
07-3089	610	892
07-3089	611	894
07-3089	613	896
07-3089	626	918
07-3089	629	921
07-3089	631	924
07-3089	631	925
07-3089	633	926
07-3089	635	927
07-3089	637	928
07-3089	638	929
07-3089	640	930
07-3089	642	931
07-3089	643	932
07-3089	644	933
07-3089	646	935
07-3089	647	936
07-3089	648	937
07-3089	649	938
07-3089	650	939
07-3089	651	941
07-3089	652	942
07-3089	653	943
07-3089	654	944
07-3089	655	945
07-3089	655	946
07-3089	665	957
07-3089	699	1006
07-3089	700	1007
07-3089	701	1008
07-3089	702	1009
07-3089	702	1010
07-3089	703	1011
07-3089	704	1012
07-3089	704	1013
07-3089	705	1014
07-3089	707	1017

		9
07-3089	709	1020
07-3089	710	1021
07-3089	712	1023
07-3089	714	1029
07-4037	459	730
07-4037	504	792
07-4037	505	793
07-4037	505	794
07-4038	459	730
07-4038	504	792
07-4038	505	793
07-4038	505	794
08-101300-00	442	705
08-101300-00	443	707
08-101300-00	444	709
08-101307-00	442	705
08-101307-00	443	707
08-101307-00	444	709
08-103000-00	501	787
08-103000-00	502	788
08-103000-00	503	789
08-103007-00	501	787
08-103007-00	502	788
08-103007-00	503	789
08-103100-00	460	731
08-103100-00	460	732
08-103100-00	466	738
08-103100-00	479	758
08-103100-00	488	770
08-103100-00	488	771
08-103100-00	490	773
08-105900-00	583	866
08-105900-00	586	869
08-105900-00	587	870
08-105900-00	588	871
08-105900-00	588	872
08-105900-00	588	873
08-105900-00	590	873
08-105900-00	592	876
08-105900-00	592	877
08-105900-00	593	877
08-105900-00	593	878
08-105907-00	583	866
08-105907-00	586	869
08-105907-00	587	870
08-105907-00	588	871
08-105907-00	588	872
08-105907-00	590	873
08-105907-00	592	876
08-105907-00	593	877
08-105907-00	593	878
08-108500-00	444	710
08-108600-00	444	710
08-108700-00	444	710
08-108707-00	444	710
08-108800-00	457	725
08-108807-00	457	725
08-109400-10	610	892
08-109400-10	611	893
08-109400-10	613	896

		9
08-109400-10	633	926
08-109400-10	635	927
08-109400-10	637	928
08-109400-10	638	929
08-109400-10	640	930
08-109400-10	643	932
08-109400-10	644	933
08-109400-10	646	935
08-109400-10	647	936
08-109400-10	648	937
08-109400-10	649	938
08-109400-10	650	939
08-109400-10	651	941
08-109400-10	654	944
08-109400-10	655	946
08-109400-10	676	969
08-109400-10	679	972
08-109407-10	610	892
08-109407-10	611	893
08-109407-10	613	896
08-109407-10	633	926
08-109407-10	635	927
08-109407-10	637	928
08-109407-10	638	929
08-109407-10	640	930
08-109407-10	643	932
08-109407-10	644	933
08-109407-10	646	935
08-109407-10	647	936
08-109407-10	648	937
08-109407-10	649	938
08-109407-10	650	939
08-109407-10	651	941
08-109407-10	654	944
08-109407-10	655	946
08-109407-10	676	969
08-109407-10	679	972
08-109500-00	478	757
08-109500-00	481	762
08-109500-00	482	763
08-109500-00	484	765
08-109500-00	485	766
08-109500-00	486	767
08-109500-00	492	778
08-109500-00	497	783
08-109500-00	498	784
08-109505-00	478	757
08-109505-00	481	762
08-109505-00	482	763
08-109505-00	484	765
08-109505-00	485	766
08-109505-00	486	767
08-109505-00	492	778
08-109505-00	497	783
08-109505-00	498	784
08-109507-00	478	757
08-109507-00	481	762
08-109507-00	482	763

		9
08-109507-00	484	765
08-109507-00	485	766
08-109507-00	486	767
08-109507-00	492	778
08-109507-00	497	783
08-109507-00	498	784
08-109511-00	478	757
08-109511-00	481	762
08-109511-00	482	763
08-109511-00	484	765
08-109511-00	485	766
08-109511-00	486	767
08-109511-00	492	778
08-109511-00	497	783
08-109511-00	498	784
08-109700-00	585	867
08-109700-00	594	880
08-109700-00	598	882
08-109700-00	600	883
08-109700-00	601	884
08-109700-00	603	885
08-109700-00	605	886
08-109700-00	606	887
08-109700-00	606	888
08-109700-00	608	889
08-109700-00	609	890
08-109700-00	612	895
08-109700-00	614	897
08-109700-00	631	925
08-109700-00	651	940
08-109700-00	652	942
08-109700-00	653	943
08-109700-00	655	945
08-109700-00	675	967
08-109700-00	675	968
08-109700-00	677	970
08-109700-00	678	971
08-109700-00	680	973
08-109700-00	681	974
08-109700-00	682	975
08-109700-00	683	977
08-109700-00	684	979
08-109705-00	585	867
08-109705-00	594	880
08-109705-00	598	882
08-109705-00	600	883
08-109705-00	601	884
08-109705-00	603	885
08-109705-00	605	886
08-109705-00	606	887
08-109705-00	606	888
08-109705-00	608	889
08-109705-00	609	890
08-109705-00	612	895
08-109705-00	614	897
08-109705-00	631	925
08-109705-00	651	940
08-109705-00	652	942

			9
08-137400-00	724	1044	
08-137400-00	725	1046	
08-139500-00	658	948	
08-139500-00	659	949	
08-139500-00	660	950	
08-139500-00	661	952	
08-139500-00	662	954	
08-139500-00	664	956	
08-139500-00	665	957	
08-139507-00	658	948	
08-139507-00	659	949	
08-139507-00	660	950	
08-139507-00	661	952	
08-139507-00	662	954	
08-139507-00	664	956	
08-139507-00	665	957	
08-139600-00	726	1050	
08-139600-00	727	1051	
08-139600-00	727	1052	
08-139600-00	728	1053	
08-143000-00	731	1060	
08-148300-00	591	874	
08-148300-00	592	875	
08-148300-00	594	879	
08-390200-00	499	786	
08-390205-00	499	786	
08-390207-10	499	786	
08-394500-00	499	786	
08-394505-00	499	786	
08-394507-00	499	786	
08-394600-00	728	1054	
08-394600-00	729	1055	
08-394600-00	730	1057	
08-394614-10	728	1054	
08-394614-10	729	1055	
08-394614-10	730	1057	
08-394800-00	719	1037	
08-398800-00	731	1059	
08-399100-00	731	1061	
08-399100-00	732	1062	
08-399105-00	731	1061	
08-399105-00	732	1062	
08-399107-00	731	1061	
08-399107-00	732	1062	
08-399111-00	731	1061	
08-399111-00	732	1062	
08-399200-00	508	797	
08-399200-00	509	799	
08-399200-00	510	800	
08-399700-10	730	1058	
08-399707-10	730	1058	
08-404100-00	507	796	
08-404100-00	509	799	
08-404100-00	571	852	
08-404100-00	572	853	
08-404100-00	574	855	
08-404100-00	576	858	
08-404100-00	577	859	

			9
08-404100-00	580	861	
08-404100-00	581	862	
08-404200-00	453	721	
08-404200-00	454	722	
08-404211-00	453	721	
08-404211-00	454	722	
08-404700-10	507	796	
08-404700-10	571	852	
08-404700-10	572	853	
08-404700-10	574	855	
08-404700-10	576	858	
08-404700-10	577	859	
08-404700-10	580	861	
08-404700-10	581	862	
08-404705-10	507	796	
08-404705-10	571	852	
08-404705-10	572	853	
08-404705-10	574	855	
08-404705-10	576	858	
08-404705-10	577	859	
08-404705-10	580	861	
08-404705-10	581	862	
08-404707-10	507	796	
08-404707-10	571	852	
08-404707-10	572	853	
08-404707-10	574	855	
08-404707-10	576	858	
08-404707-10	577	859	
08-404707-10	580	861	
08-404707-10	581	862	
08-405000-00	508	798	
08-405000-00	575	856	
08-405000-00	576	857	
08-405000-00	582	863	
08-405200-00	478	757	
08-405200-00	481	762	
08-405200-00	482	763	
08-405200-00	484	765	
08-405200-00	485	766	
08-405200-00	486	767	
08-405200-00	492	778	
08-405200-00	497	783	
08-405200-00	498	784	
08-405205-00	478	757	
08-405205-00	481	762	
08-405205-00	482	763	
08-405205-00	484	765	
08-405205-00	485	766	
08-405205-00	486	767	
08-405205-00	492	778	
08-405205-00	497	783	
08-405205-00	498	784	
08-405207-00	478	757	
08-405207-00	481	762	
08-405207-00	482	763	
08-405207-00	484	765	
08-405207-00	485	766	
08-405207-00	486	767	

			9
08-405207-00	492	778	
08-405207-00	497	783	
08-405207-00	498	784	
08-405211-00	478	757	
08-405211-00	481	762	
08-405211-00	482	763	
08-405211-00	484	765	
08-405211-00	485	766	
08-405211-00	486	767	
08-405211-00	492	778	
08-405211-00	497	783	
08-405211-00	498	784	
08-405300-10	730	1056	
08-405314-10	730	1056	
08-406200-00	446	712	
08-406200-00	448	715	
08-406200-00	449	716	
08-406200-00	449	717	
08-406200-00	451	719	
08-406207-00	446	712	
08-406207-00	448	715	
08-406207-00	449	716	
08-406207-00	449	717	
08-406207-00	451	719	
08-406211-00	446	712	
08-406211-00	448	715	
08-406211-00	449	716	
08-406211-00	449	717	
08-406211-00	451	719	
08-408700-00	452	720	
08-408700-00	456	724	
08-408707-00	452	720	
08-408707-00	456	724	
08-421000-00	687	983	
08-421000-00	691	989	
08-421000-00	692	991	
08-421000-00	693	992	
08-421000-00	698	1002	
08-421007-00	687	983	
08-421007-00	691	989	
08-421007-00	692	991	
08-421007-00	693	992	
08-421007-00	698	1002	
08-429900-00	475	752	
08-429900-00	476	754	
08-432300-00	660	951	
08-432300-00	668	960	
08-432300-00	669	961	
08-432300-10	671	963	
08-432300-10	673	964	
08-432300-10	673	965	
08-433000-00	554	835	
08-433000-00	554	836	
08-433000-00	556	837	
08-433000-00	557	838	
08-433000-00	557	839	
08-433000-00	559	840	
08-433000-00	560	841	

			9
08-433000-00	561	842	
08-433000-00	562	843	
08-433000-00	564	844	
08-433000-00	564	845	
08-433000-00	565	846	
08-433000-00	566	847	
08-433000-00	566	848	
08-433000-00	568	849	
08-433000-00	569	850	
08-433000-00	569	851	
08-433007-00	554	835	
08-433007-00	554	836	
08-433007-00	556	837	
08-433007-00	557	838	
08-433007-00	557	839	
08-433007-00	559	840	
08-433007-00	561	842	
08-433007-00	562	843	
08-433007-00	564	844	
08-433007-00	564	845	
08-433007-00	565	846	
08-433007-00	566	847	
08-433007-00	566	848	
08-433007-00	568	849	
08-433007-00	569	850	
08-433007-00	569	851	
08-433007-00	569	851	
08-433100-00	698	1004	
08-433100-00	721	1039	
08-433100-00	721	1040	
08-433100-00	722	1041	
08-433100-00	722	1042	
08-433105-00	698	1004	
08-433105-00	721	1039	
08-433105-00	721	1040	
08-433105-00	722	1041	
08-433105-00	722	1042	
08-433107-00	698	1004	
08-433107-00	721	1039	
08-433107-00	721	1040	
08-433107-00	722	1041	
08-433107-00	722	1042	
08-434300-00	698	1003	
08-434300-00	698	1004	
08-434300-00	720	1038	
08-434300-00	721	1040	
08-434300-00	722	1041	
08-434307-00	698	1003	
08-434307-00	698	1004	
08-434307-00	720	1038	
08-434307-00	721	1040	
08-434307-00	722	1041	
08-436900-00	470	744	
08-436900-00	470	745	
08-436900-00	472	748	
08-436900-00	474	750	
08-436900-00	476	753	
08-500600-00	702	1010	

NUMERICAL PARTS LIST

Numerische Teilenummernliste • Elenco riferimenti
Liste des références produits

 9		
08-501200-00	715	1030
08-501500-00	686	981
08-501500-00	687	982
08-501500-00	689	986
08-501500-00	690	988
08-501507-00	686	981
08-501507-00	687	982
08-501507-00	689	986
08-501507-00	690	988
08-501800-00	700	1007
08-501800-00	702	1009
08-501800-00	702	1010
08-501800-00	703	1011
08-501800-00	704	1012
08-501800-00	704	1013
08-501800-00	705	1014
08-501800-00	706	1015
08-501800-00	706	1016
08-501800-00	707	1017
08-501800-00	708	1018
08-501800-00	709	1020
08-501800-00	712	1023
08-501800-00	712	1024
08-501800-00	713	1025
08-501800-00	714	1027
08-501800-00	718	1034
08-501800-00	718	1035
08-501807-00	700	1007
08-501807-00	702	1009
08-501807-00	702	1010
08-501807-00	703	1011
08-501807-00	704	1012
08-501807-00	704	1013
08-501807-00	705	1014
08-501807-00	706	1015
08-501807-00	706	1016
08-501807-00	707	1017
08-501807-00	708	1018
08-501807-00	709	1020
08-501807-00	712	1023
08-501807-00	712	1024
08-501807-00	713	1025
08-501807-00	714	1027
08-501807-00	718	1034
08-501807-00	718	1035
08-501900-00	693	993
08-501900-00	694	994
08-501900-00	695	997
08-501900-00	696	998
08-501900-00	696	999
08-501907-00	693	993
08-501907-00	694	994
08-501907-00	695	997
08-501907-00	696	998
08-501907-00	696	999
08-502000-00	646	934
08-502000-00	657	947
08-502000-00	685	980

 9		
08-502200-00	447	713
08-502200-00	447	714
08-502200-00	450	718
08-502207-00	447	713
08-502207-00	447	714
08-502207-00	450	718
08-502300-00	699	1005
08-502400-00	487	769
08-502800-00	460	731
08-502800-00	460	732
08-502800-00	466	738
08-502800-00	479	758
08-502800-00	488	770
08-502800-00	488	771
08-502800-00	490	773
08-502807-00	460	731
08-502807-00	460	732
08-502807-00	466	738
08-502807-00	479	758
08-502807-00	488	770
08-502807-00	488	771
08-502807-00	490	773
08-502900-00	615	899
08-502900-00	616	900
08-502900-00	617	902
08-502900-00	618	903
08-502900-00	619	904
08-502900-00	620	905
08-502900-00	621	908
08-502900-00	623	911
08-502900-00	624	913
08-502900-00	626	917
08-502900-00	628	920
08-502905-00	615	899
08-502905-00	616	900
08-502905-00	617	902
08-502905-00	618	903
08-502905-00	619	904
08-502905-00	620	905
08-502905-00	621	908
08-502905-00	623	911
08-502905-00	624	913
08-502905-00	626	917
08-502905-00	628	920
08-502907-00	615	899
08-502907-00	616	900
08-502907-00	617	902
08-502907-00	618	903
08-502907-00	619	904
08-502907-00	620	905
08-502907-00	621	908
08-502907-00	623	911
08-502907-00	623	911
08-502907-00	624	913
08-502907-00	624	913
08-502907-00	626	917
08-502907-00	626	917
08-502907-00	628	920
08-962600-00	458	727
08-990000-00	732	1063
08-990100-00	512	802

 9		
08-990100-00	514	805
08-990100-00	515	806
08-990100-00	518	808
08-990100-00	519	809
08-990100-00	519	810
08-990100-00	583	865
08-990105-00	512	802
08-990105-00	514	805
08-990105-00	515	806
08-990105-00	518	808
08-990105-00	519	809
08-990105-00	519	810
08-990105-00	583	865
08-990107-00	512	802
08-990107-00	514	805
08-990107-00	515	806
08-990107-00	518	808
08-990107-00	519	809
08-990107-00	519	810
08-990107-00	583	865
08-990111-00	512	802
08-990111-00	514	805
08-990111-00	515	806
08-990111-00	518	808
08-990111-00	519	809
08-990111-00	519	810
08-990111-00	583	865
08-991000-00	699	1006
08-991000-00	715	1030
08-991300-00	455	723
08-991300-00	458	726
08-991307-00	455	723
08-991307-00	458	726
08-991400-00	715	1031
08-991400-00	716	1032
08-991400-00	717	1033
08-991407-00	715	1031
08-991407-00	716	1032
08-991407-00	717	1033
14-020420-00	686	981
14-020420-00	687	982
14-020420-00	691	989
14-020421-00	686	981
14-020421-00	687	982
14-020421-00	691	989
14-021571-00	460	732
14-021571-00	466	738
14-021571-00	479	758
14-021571-00	480	759
14-021571-00	481	762
14-021571-00	482	763
14-021571-00	483	764
14-021571-00	484	765
14-021571-00	485	766
14-021571-00	486	767
14-021571-00	488	770
14-021571-00	488	771
14-021571-00	490	773

 9		
14-021571-00	492	778
14-021571-00	493	779
14-021571-00	494	780
14-021571-00	496	782
14-021571-00	497	783
14-021571-00	498	784
14-023470-00	477	756
14-023470-00	478	757
14-024670-00	477	756
14-024670-00	478	757
14-025070-00	447	713
14-025070-00	449	716
14-025070-00	450	718
14-025070-00	451	719
14-025070-00	455	723
14-025070-00	458	726
14-027950-00	504	792
14-027950-00	513	804
14-027950-00	514	805
14-027950-00	515	806
14-027950-00	516	807
14-027950-00	518	808
14-027950-00	519	809
14-027950-00	519	810
14-027950-00	520	811
14-027950-00	522	813
14-027950-00	524	814
14-027950-00	525	815
14-027950-00	527	816
14-027950-00	529	817
14-027950-00	531	818
14-027950-00	533	819
14-027950-00	535	821
14-027950-00	537	822
14-027950-00	538	823
14-027950-00	541	825
14-027950-00	542	826
14-027950-00	544	827
14-027950-00	545	828
14-027950-00	546	829
14-027950-00	548	830
14-027950-00	549	831
14-027950-00	551	832
14-027950-00	552	833
14-027950-00	553	834
14-027950-00	554	836
14-027950-00	556	837
14-027950-00	557	839
14-027950-00	559	840
14-027950-00	562	843
14-027950-00	566	848
14-027950-00	568	849
14-027950-00	569	850
14-027950-00	569	851
14-027950-00	583	865
14-028360-00	460	732
14-028360-00	466	738
14-028360-00	477	756

NUMERICAL PARTS LIST

Nummerische Teilenummernliste • Elenco riferimenti
Liste des références produits

 9		
55-3729	661	952
55-3729	662	953
55-3729	686	981
55-3729	687	982
55-3729	690	987
55-3729	690	988
55-4715	471	746
55-4715	472	748
71-1950/4	499	785
71-1950/4	499	786
71-1950/4	719	1037
71-1950/4	723	1043
71-1950/4	728	1054
71-1950/4	729	1055
71-1950/4	732	1062
71-1950/4	732	1063
71-3084	456	724
71-3084	457	725
71-3084	477	755
71-3084	477	756
71-3084	478	757
71-3084	506	795
71-3084	507	796
71-3084	508	798
71-3084	509	799
71-3084	510	800
71-3084	571	852
71-3084	572	853
71-3084	573	854
71-3084	574	855
71-3084	575	856
71-3084	576	857
71-3084	576	858
71-3084	577	859
71-3084	579	860
71-3084	580	861
71-3084	581	862
71-3084	582	863
71-3084	582	864
71-3084	596	881
71-3084	598	882
71-3084	603	885
71-3084	631	924
71-3084	683	976
71-3276/4	444	710
71-3276/4	446	712
71-3276/4	447	713
71-3276/4	447	714
71-3276/4	448	715
71-3276/4	449	716
71-3276/4	449	717
71-3276/4	450	718
71-3276/4	451	719
71-3276/4	453	721
71-3276/4	454	722
71-3276/4	455	723
71-3276/4	458	726
71-3442/4	480	759

 9		
71-3442/4	480	760
71-3442/4	481	761
71-3442/4	481	762
71-3442/4	482	763
71-3442/4	483	764
71-3442/4	484	765
71-3442/4	485	766
71-3442/4	486	767
71-3442/4	512	802
71-3442/4	512	803
71-3442/4	513	804
71-3442/4	514	805
71-3442/4	515	806
71-3442/4	519	810
71-3442/4	524	814
71-3442/4	535	820
71-3442/4	537	822
71-3442/4	553	834
71-3442/5	492	778
71-3442/5	493	779
71-3442/5	583	865
71-3442/6	494	780
71-3442/6	495	781
71-3442/6	496	782
71-3442/6	497	783
71-3442/6	498	784
71-3566/4	596	881
71-3566/4	598	882
71-3566/4	603	885
71-3566/4	608	889
71-3566/4	611	894
71-3566/4	631	925
71-3566/4	633	926
71-3566/4	635	927
71-3566/4	638	929
71-3566/4	640	930
71-3566/4	642	931
71-3566/4	644	933
71-3566/4	648	937
71-3566/4	654	944
71-3566/4	655	946
71-3566/5	503	790
71-3566/5	571	852
71-3566/5	573	854
71-3566/5	574	855
71-3566/5	575	856
71-3566/5	577	859
71-3566/5	579	860
71-3566/5	675	968
71-3566/5	681	974
71-3566/5	682	975
71-3566/5	683	977
71-3566/5	684	978
71-3694/4	452	720
71-3694/4	456	724
71-3694/4	485	766
71-3694/4	583	866
71-3694/4	585	867

 9		
71-3694/4	586	868
71-3694/4	586	869
71-3694/4	587	870
71-3694/4	588	871
71-3694/4	588	872
71-3694/4	590	873
71-3694/4	592	876
71-3694/4	593	877
71-3694/4	594	880
71-3694/4	596	881
71-3694/4	598	882
71-3694/4	600	883
71-3694/4	601	884
71-3694/4	603	885
71-3694/4	605	886
71-3694/4	606	887
71-3694/4	606	888
71-3694/4	608	889
71-3694/4	609	890
71-3694/4	610	891
71-3694/4	610	892
71-3694/4	611	894
71-3694/4	612	895
71-3694/4	613	896
71-3694/4	614	897
71-3694/4	614	898
71-3694/4	615	899
71-3694/4	617	901
71-3694/4	617	902
71-3694/4	620	906
71-3694/4	622	909
71-3694/4	622	910
71-3694/4	628	919
71-3694/4	629	921
71-3694/4	631	925
71-3694/4	633	926
71-3694/4	635	927
71-3694/4	637	928
71-3694/4	638	929
71-3694/4	640	930
71-3694/4	642	931
71-3694/4	643	932
71-3694/4	644	933
71-3694/4	646	935
71-3694/4	647	936
71-3694/4	648	937
71-3694/4	649	938
71-3694/4	650	939
71-3694/4	651	941
71-3694/4	653	943
71-3694/4	654	944
71-3694/4	655	945
71-3694/4	655	946
71-3694/4	657	947
71-3694/4	699	1006
71-3694/4	700	1007
71-3694/4	701	1008
71-3694/4	702	1009

 9		
71-3694/4	702	1010
71-3694/4	703	1011
71-3694/4	704	1012
71-3694/4	704	1013
71-3694/4	705	1014
71-3694/4	706	1015
71-3694/4	706	1016
71-3694/4	707	1017
71-3694/4	708	1018
71-3694/4	710	1021
71-3694/4	712	1023
71-3694/4	714	1029
71-3694/5	503	790
71-3694/5	573	854
71-3694/5	575	856
71-3694/5	675	967
71-3694/5	675	968
71-3694/5	676	969
71-3694/5	677	970
71-3694/5	678	971
71-3694/5	680	973
71-3694/5	681	974
71-3694/5	682	975
71-3694/5	683	977
71-3694/5	684	978
71-3694/5	685	980
71-3694/5	688	985
71-3694/5	715	1030
71-3694/5	715	1031
71-3694/5	716	1032
71-3711/6	694	995
71-3711/6	717	1033
71-3711/6	718	1034
71-3711/6	718	1035
71-3711/6	719	1036
71-3728/4	516	807
71-3728/4	518	808
71-3728/4	519	809
71-3728/4	520	811
71-3728/4	522	812
71-3728/4	524	814
71-3728/4	525	815
71-3728/4	529	817
71-3728/4	533	819
71-3728/4	541	825
71-3728/4	554	835
71-3728/4	554	836
71-3732/4	616	900
71-3732/4	618	903
71-3732/4	619	904
71-3732/4	620	905
71-3732/4	621	908
71-3732/4	623	911
71-3732/4	623	912
71-3732/4	624	913
71-3732/4	625	914
71-3732/4	626	917
71-3732/4	626	918

 9		
71-3732/5	679	972
71-3732/5	684	979
71-3732/5	689	986
71-3765/4	470	744
71-3847/4	461	733
71-3847/4	522	813
71-3847/4	527	816
71-3847/4	535	821
71-3847/4	539	824
71-3847/5	686	981
71-3847/5	687	982
71-3847/5	690	987
71-3847/5	690	988
71-3904	459	730
71-3904	504	792
71-3904	505	793
71-3904	505	794
71-3904	531	818
71-3904	539	824
71-3904	544	827
71-3904	545	828
71-3904	546	829
71-3904	548	830
71-3904	551	832
71-3904	557	839
71-3904	559	840
71-3904	561	842
71-3904	562	843
71-3904	568	849
71-3904	659	949
71-3904	666	958
71-3929/4	522	813
71-3929/4	529	817
71-3929/4	533	819
71-3929/4	583	866
71-3929/4	587	870
71-3929/4	588	872
71-3929/4	590	873
71-3929/4	593	878
71-3929/4	612	895
71-3929/4	622	909
71-3929/4	625	914
71-3929/4	625	915
71-3929/4	625	916
71-3929/4	626	918
71-3929/4	629	921
71-3929/4	630	922
71-3929/4	630	923
71-3929/4	655	946
71-3929/4	707	1017
71-3929/4	708	1018
71-3929/4	709	1019
71-3929/4	709	1020
71-3929/4	710	1021
71-3929/4	711	1022
71-3929/4	712	1023
71-3929/4	712	1024
71-3929/4	713	1026

 9		
71-3929/4	714	1028
71-3930	538	823
71-3930	542	826
71-3930	549	831
71-3930	552	833
71-3930	562	843
71-3930	564	845
71-3930	565	846
71-3930	566	848
71-3930	569	851
71-3930	658	948
71-3930	661	952
71-3930	662	953
71-3930	662	954
71-3930	664	955
71-3930	664	956
71-3930	665	957
71-3930	667	959
71-3930	668	960
71-3930	669	961
71-3930	670	962
71-3930	671	963
71-3930	687	983
71-3930	688	984
71-3930	691	989
71-3930	692	990
71-3930	692	991
71-3932	727	1052
71-3933/8	697	1001
71-3933/8	726	1050
73-4828	687	983
73-4828	688	984
73-4828	691	989
73-4828	698	1002
87-101300-00	442	705
87-101307-00	442	705
87-103000-00	501	787
87-103000-10	501	787
87-103000-30	502	788
87-103000-40	502	788
87-105900-00	583	866
87-105900-00	586	869
87-105900-00	587	870
87-105900-00	588	871
87-105900-00	588	872
87-105900-00	590	873
87-105900-00	592	876
87-105900-00	593	877
87-105900-00	593	878
87-105907-00	583	866
87-105907-00	586	869
87-105907-00	587	870
87-105907-00	588	871
87-105907-00	588	872
87-105907-00	590	873
87-105907-00	592	876
87-105907-00	593	877
87-105907-00	593	878

 9		
87-109400-50	610	892
87-109400-50	611	893
87-109400-50	613	896
87-109400-50	633	926
87-109400-50	635	927
87-109400-50	637	928
87-109400-50	638	929
87-109400-50	640	930
87-109400-50	644	933
87-109400-50	646	935
87-109400-50	648	937
87-109400-50	651	941
87-109400-50	655	946
87-109407-50	610	892
87-109407-50	611	893
87-109407-50	613	896
87-109407-50	633	926
87-109407-50	635	927
87-109407-50	637	928
87-109407-50	638	929
87-109407-50	640	930
87-109407-50	644	933
87-109407-50	646	935
87-109407-50	648	937
87-109407-50	651	941
87-109407-50	655	946
87-109500-00	481	762
87-109500-00	482	763
87-109500-00	484	765
87-109500-00	485	766
87-109500-00	486	767
87-109500-00	492	778
87-109500-00	497	783
87-109500-00	498	784
87-109505-00	481	762
87-109505-00	482	763
87-109505-00	484	765
87-109505-00	485	766
87-109505-00	486	767
87-109505-00	492	778
87-109505-00	497	783
87-109505-00	498	784
87-109507-00	481	762
87-109507-00	482	763
87-109507-00	484	765
87-109507-00	485	766
87-109507-00	486	767
87-109507-00	497	783
87-109507-00	498	784
87-109511-00	481	762
87-109511-00	482	763
87-109511-00	484	765
87-109511-00	485	766
87-109511-00	486	767
87-109511-00	492	778
87-109511-00	497	783
87-109511-00	498	784

 9		
87-109700-00	681	974
87-109700-20	585	867
87-109700-20	594	880
87-109700-20	596	881
87-109700-20	598	882
87-109700-20	600	883
87-109700-20	601	884
87-109700-20	603	885
87-109700-20	605	886
87-109700-20	606	887
87-109700-20	606	888
87-109700-20	608	889
87-109700-20	609	890
87-109700-30	680	973
87-109700-30	682	975
87-109705-30	680	973
87-109705-30	682	975
87-109707-00	681	974
87-109707-10	653	943
87-109707-20	585	867
87-109707-20	594	880
87-109707-20	596	881
87-109707-20	598	882
87-109707-20	600	883
87-109707-20	601	884
87-109707-20	603	885
87-109707-20	605	886
87-109707-20	606	887
87-109707-20	608	889
87-109707-20	609	890
87-109800-10	480	759
87-109800-10	483	764
87-109800-10	493	779
87-109800-10	494	780
87-109800-10	496	782
87-109807-10	480	759
87-109807-10	483	764
87-109807-10	493	779
87-109807-10	494	780
87-109807-10	496	782
87-109811-10	480	759
87-109811-10	483	764
87-109811-10	493	779
87-109811-10	494	780
87-109811-10	496	782
87-114900-05	531	818
87-114900-05	545	828
87-114900-05	546	829
87-114900-05	569	851
87-114900-15	531	818
87-114900-15	545	828
87-114900-15	546	829
87-114900-15	569	851
87-114900-20	524	814
87-114900-20	537	822
87-114900-20	541	825
87-114900-20	553	834

9		
87-114911-60	527	816
87-114911-60	529	817
87-114911-60	533	819
87-114911-60	554	836
87-114911-70	516	807
87-114911-70	520	811
87-114911-70	522	813
87-114911-70	525	815
87-114911-70	527	816
87-114911-70	529	817
87-114911-70	533	819
87-114911-70	554	836
87-114911-90	516	807
87-114911-90	520	811
87-114911-90	522	813
87-114911-90	525	815
87-114911-90	527	816
87-114911-90	529	817
87-114911-90	533	819
87-114911-90	554	836
87-114911-95	516	807
87-114911-95	520	811
87-114911-95	522	813
87-114911-95	525	815
87-114911-95	527	816
87-114911-95	529	817
87-114911-95	533	819
87-114911-95	554	836
87-116100-00	461	733
87-116100-00	463	734
87-116100-00	464	735
87-116100-00	469	743
87-116100-00	472	747
87-116107-00	461	733
87-116107-00	463	734
87-116107-00	464	735
87-116107-00	469	743
87-116107-00	472	747
87-139500-00	658	948
87-139500-10	661	952
87-139500-10	662	954
87-139500-10	665	957
87-139500-20	661	952
87-139500-20	662	954
87-139500-20	665	957
87-139500-30	659	949
87-139500-30	660	950
87-139500-40	659	949
87-139500-40	660	950
87-139507-00	658	948
87-139507-10	661	952
87-139507-10	662	954
87-139507-10	665	957
87-139507-20	661	952
87-139507-20	662	954
87-139507-20	665	957
87-139507-30	659	949
87-139507-30	660	950

9		
87-139507-40	659	949
87-139507-40	660	950
87-421000-10	691	989
87-421000-20	691	989
87-421000-30	692	991
87-421000-30	693	992
87-421007-10	691	989
87-421007-20	691	989
87-421007-30	692	991
87-421007-30	693	992
87-429900-00	475	752
87-429900-00	476	754
87-429907-00	475	752
87-429907-00	476	754
87-432300-00	668	960
87-432300-00	669	961
87-432300-10	671	963
87-432300-10	673	964
87-432300-10	673	965
87-434300-00	720	1038
87-434300-00	722	1041
87-434307-00	720	1038
87-434307-00	722	1041
87-435100-00	711	1022
87-436900-00	470	744
87-436900-00	470	745
87-436900-00	472	748
87-436900-00	474	750
87-436900-00	476	753
87-501500-00	686	981
87-501500-00	687	982
87-501500-10	686	981
87-501500-10	687	982
87-501500-20	689	986
87-501500-30	689	986
87-501500-40	690	988
87-501507-00	686	981
87-501507-10	687	982
87-501507-20	689	986
87-501507-30	689	986
87-501507-40	690	988
87-501800-10	718	1034
87-501800-20	700	1007
87-501800-20	707	1017
87-501800-20	708	1018
87-501800-40	704	1012
87-501800-50	700	1007
87-501800-50	707	1017
87-501800-50	708	1018
87-501807-10	718	1034
87-501807-20	700	1007
87-501807-20	707	1017
87-501807-20	708	1018
87-501807-60	702	1009
87-501807-60	705	1014
87-501900-00	693	993

9		
87-501900-00	695	997
87-501900-00	696	998
87-501907-00	693	993
87-501907-00	695	997
87-501907-00	696	998
87-502800-00	460	732
87-502800-00	466	738
87-502800-10	479	758
87-502800-10	488	770
87-502800-10	488	771
87-502800-10	490	773
87-502807-00	460	732
87-502807-00	466	738
87-502807-10	479	758
87-502807-10	488	770
87-502807-10	488	771
87-502807-10	490	773
87-502900-00	615	899
87-502900-00	617	902
87-502900-10	616	900
87-502900-10	618	903
87-502900-10	619	904
87-502900-10	620	905
87-502900-10	621	908
87-502900-10	623	911
87-502900-10	624	913
87-502900-10	626	917
87-502900-10	628	920
87-502905-10	616	900
87-502905-10	618	903
87-502905-10	619	904
87-502905-10	620	905
87-502905-10	621	908
87-502905-10	623	911
87-502905-10	624	913
87-502905-10	626	917
87-502905-10	628	920
87-502907-00	615	899
87-502907-00	617	902
87-502907-10	616	900
87-502907-10	618	903
87-502907-10	619	904
87-502907-10	620	905
87-502907-10	621	908
87-502907-10	623	911
87-502907-10	624	913
87-502907-10	626	917
87-502907-10	628	920
87-990100-10	518	808
87-990100-10	519	809
87-990100-40	514	805
87-990100-40	515	806
87-990100-40	519	810
87-990100-40	583	865
87-990105-10	518	808
87-990105-10	519	809
87-990105-40	514	805
87-990105-40	515	806

9		
87-990105-40	519	810
87-990105-40	583	865
87-990107-10	518	808
87-990107-10	519	809
87-990107-40	514	805
87-990107-40	515	806
87-990107-40	519	810
87-990107-40	583	865
87-990111-10	518	808
87-990111-10	519	809
87-990111-40	514	805
87-990111-40	515	806
87-990111-40	519	810
87-990111-40	583	865
A123/4	442	705
A123/4	443	707
A123/4	443	708
A123/4	445	711
A123/4	446	712
A123/4	447	713
A123/4	447	714
A123/4	449	716
A123/4	449	717
A123/4	450	718
A123/4	451	719
A123/4	453	721
A123/4	455	723
A123/4	456	724
A123/4	458	726
A123/4	460	731
A123/4	460	732
A123/4	461	733
A123/4	463	734
A123/4	464	735
A123/4	465	736
A123/4	466	737
A123/4	466	738
A123/4	469	742
A123/4	469	743
A123/4	470	744
A123/4	470	745
A123/4	471	746
A123/4	472	747
A123/4	472	748
A123/4	474	751
A123/4	475	752
A123/4	479	758
A123/4	480	759
A123/4	480	760
A123/4	481	761
A123/4	482	763
A123/4	484	765
A123/4	485	766
A123/4	486	767
A123/4	487	768
A123/4	487	769
A123/4	488	770
A123/4	488	771

NUMERICAL PARTS LIST

Nummerische Teilenummernliste • Elenco riferimenti
Liste des références produits

 9		
A123/4	489	772
A123/4	490	773
A123/4	491	774
A123/4	491	775
A123/4	492	776
A123/4	511	801
A123/4	512	802
A123/4	512	803
A123/4	513	804
A123/4	514	805
A123/4	515	806
A123/4	516	807
A123/4	518	808
A123/4	519	809
A123/4	519	810
A123/4	520	811
A123/4	522	812
A123/4	522	813
A123/4	524	814
A123/4	525	815
A123/4	527	816
A123/4	529	817
A123/4	531	818
A123/4	533	819
A123/4	535	820
A123/4	535	821
A123/4	537	822
A123/4	538	823
A123/4	539	824
A123/4	541	825
A123/4	542	826
A123/4	544	827
A123/4	545	828
A123/4	546	829
A123/4	548	830
A123/4	549	831
A123/4	551	832
A123/4	553	834
A123/4	554	835
A123/4	554	836
A123/4	556	837
A123/4	557	839
A123/4	559	840
A123/4	560	841
A123/4	561	842
A123/4	562	843
A123/4	564	845
A123/4	565	846
A123/4	566	848
A123/4	568	849
A123/4	569	851
A123/4	583	866
A123/4	585	867
A123/4	586	868
A123/4	586	869
A123/4	587	870
A123/4	588	871
A123/4	588	872

 9		
A123/4	593	877
A123/4	593	878
A123/4	594	880
A123/4	596	881
A123/4	598	882
A123/4	600	883
A123/4	601	884
A123/4	603	885
A123/4	605	886
A123/4	606	887
A123/4	606	888
A123/4	608	889
A123/4	610	892
A123/4	611	894
A123/4	612	895
A123/4	613	896
A123/4	614	897
A123/4	614	898
A123/4	615	899
A123/4	616	900
A123/4	617	901
A123/4	617	902
A123/4	618	903
A123/4	619	904
A123/4	621	908
A123/4	622	909
A123/4	623	912
A123/4	624	913
A123/4	625	914
A123/4	625	915
A123/4	626	917
A123/4	626	918
A123/4	628	919
A123/4	629	921
A123/4	630	922
A123/4	631	925
A123/4	633	926
A123/4	635	927
A123/4	637	928
A123/4	638	929
A123/4	640	930
A123/4	642	931
A123/4	643	932
A123/4	644	933
A123/4	646	935
A123/4	647	936
A123/4	648	937
A123/4	649	938
A123/4	650	939
A123/4	651	941
A123/4	653	943
A123/4	654	944
A123/4	655	945
A123/4	655	946
A123/4	657	947
A123/4	658	948
A123/4	659	949
A123/4	660	950

 9		
A123/4	661	952
A123/4	662	953
A123/4	662	954
A123/4	664	955
A123/4	664	956
A123/4	665	957
A123/4	666	958
A123/4	667	959
A123/4	668	960
A123/4	669	961
A123/4	670	962
A123/4	671	963
A123/4	673	964
A123/4	674	966
A123/4	699	1006
A123/4	700	1007
A123/4	701	1008
A123/4	702	1009
A123/4	702	1010
A123/4	703	1011
A123/4	704	1012
A123/4	704	1013
A123/4	705	1014
A123/4	706	1015
A123/4	706	1016
A123/4	707	1017
A123/4	708	1018
A123/4	709	1020
A123/4	710	1021
A123/4	712	1023
A123/4	712	1024
A123/4	713	1025
A123/4	713	1026
A123/4	714	1028
A123/4	714	1029
A124/4	492	778
A124/4	493	779
A124/4	494	780
A124/4	495	781
A124/4	496	782
A124/4	497	783
A124/4	498	784
A124/4	503	790
A124/4	571	852
A124/4	572	853
A124/4	573	854
A124/4	574	855
A124/4	575	856
A124/4	576	858
A124/4	577	859
A124/4	579	860
A124/4	581	862
A124/4	582	863
A124/4	582	864
A124/4	583	865
A124/4	610	891
A124/4	675	967
A124/4	675	968

 9		
A124/4	676	969
A124/4	677	970
A124/4	678	971
A124/4	679	972
A124/4	680	973
A124/4	681	974
A124/4	682	975
A124/4	683	976
A124/4	683	977
A124/4	684	978
A124/4	684	979
A124/4	685	980
A124/4	686	981
A124/4	688	985
A124/4	689	986
A124/4	690	987
A124/4	690	988
A124/4	692	990
A124/4	692	991
A124/4	715	1030
A124/4	715	1031
A124/4	716	1032
A138/4	694	995
A138/4	698	1003
A138/4	698	1004
A138/4	717	1033
A138/4	718	1034
A138/4	718	1035
A138/4	719	1036
A138/4	720	1038
A138/4	721	1039
A138/4	721	1040
A138/4	722	1041
A138/4	726	1048
A138/4	726	1050
A138/4	727	1051
A138/4	727	1052
A139/4	693	993
A139/4	694	994
A139/4	695	997
A139/4	696	998
A139/4	696	999
A139/4	697	1000
A139/4	699	1005
A139/4	724	1044
A139/4	725	1045
A292/4	492	778
A292/4	493	779
A292/4	494	780
A292/4	495	781
A292/4	496	782
A292/4	496	782
A292/4	497	783
A292/4	497	783
A292/4	498	784
A292/4	503	790
A292/4	571	852
A292/4	571	852
A292/4	572	853
A292/4	573	854
A292/4	574	855
A292/4	575	856
A292/4	576	858
A292/4	577	859
A292/4	579	860
A292/4	581	862
A292/4	582	863
A292/4	582	864
A292/4	583	865
A292/4	572	853
A292/4	572	853
A292/4	573	854
A292/4	574	855

		9
A292/4	575	856
A292/4	576	858
A292/4	577	859
A292/4	579	860
A292/4	581	862
A292/4	582	863
A292/4	582	864
A292/4	583	865
A292/4	610	891
A292/4	675	967
A292/4	675	968
A292/4	676	969
A292/4	677	970
A292/4	678	971
A292/4	679	972
A292/4	680	973
A292/4	681	974
A292/4	682	975
A292/4	683	976
A292/4	683	977
A292/4	684	978
A292/4	684	979
A292/4	685	980
A292/4	686	981
A292/4	688	985
A292/4	689	986
A292/4	690	987
A292/4	690	988
A292/4	692	990
A292/4	692	991
A292/4	715	1030
A292/4	715	1031
A292/4	716	1032
AA5410	1	1
AA5410	4	4
AA5430	363	553
AA5430	364	554
AA5430	372	568
AA5500	39	66
AB5370	386	585
AB5370	391	590
AB5370	392	592
AB5370	393	594
AB5370	394	597
AB5370	396	600
AB5370	397	601
AB5370	398	602
AB5370	399	603
AB5370	399	604
AB5370	400	605
AB5370	400	606
AB5370	401	608
AB5370	401	609
AB5370	402	610
AB5370	402	611
AB5701	40	67
AB5701	43	70
AB5701	44	72

		9
AB5701	47	76
AB5701	48	77
AB5701	50	79
AB5701	54	86
AB5701	56	90
AB5701	57	91
AC5190	32	54
AC5190	33	55
AC5200	32	54
AC5200	33	55
AC5210	32	54
AC5210	33	55
AC5220	195	303
AC5220	196	304
AC5220	197	305
AC5220	198	306
AC5220	199	308
AC5220	200	309
AC5220	201	310
AC5220	202	311
AC5220	203	312
AC5220	204	313
AC5220	204	314
AC5220	205	317
AC5220	206	318
AC5280	71	111
AC5280	74	115
AC5280	76	117
AC5280	77	118
AC5280	78	119
AC5280	79	120
AC5280	80	122
AC5960	95	150
AC5960	96	151
AC5960	97	152
AC5960	98	153
AC5960	99	154
AC5960	100	155
AC5960	100	156
AC5970	95	150
AC5970	96	151
AC5970	97	152
AC5970	98	153
AC5970	99	154
AC5970	100	155
AC5970	100	156
AC5980	95	150
AC5980	96	151
AC5980	97	152
AC5980	98	153
AC5980	99	154
AC5980	100	155
AC5980	100	156
AD5630	3	3
AD5630	4	6
AD5640	41	68
AD5640	42	69
AD5640	45	73

		9
AD5640	49	78
AD5650	102	159
AD5650	103	160
AD5650	104	161
AD5650	105	162
AD5650	105	163
AD5650	106	164
AD5660	102	159
AD5660	103	160
AD5660	104	161
AD5660	105	162
AD5660	105	163
AD5660	106	164
AD5670	102	159
AD5670	103	160
AD5670	104	161
AD5670	105	162
AD5670	105	163
AD5670	106	164
AF5310	334	506
AF5310	336	511
AF5310	337	512
AF5310	338	513
AF5310	339	514
AF5310	340	515
AF5310	341	516
AF5310	342	517
AF5310	343	518
AF5310	344	519
AF5310	345	520
AF5310	346	521
AF5310	348	523
AF5310	348	524
AF5320	334	506
AF5320	336	511
AF5320	337	512
AF5320	338	513
AF5320	339	514
AF5320	340	515
AF5320	341	516
AF5320	342	517
AF5320	343	518
AF5320	344	519
AF5320	345	520
AF5320	346	521
AF5320	348	523
AF5320	348	524
AF5330	334	506
AF5330	336	511
AF5330	337	512
AF5330	338	513
AF5330	339	514
AF5330	340	515
AF5330	341	516
AF5330	342	517
AF5330	343	518
AF5330	344	519
AF5330	345	520

		9
AF5330	346	521
AF5330	348	523
AF5330	348	524
AF5340	182	285
AF5340	183	286
AF5340	184	287
AF5340	185	288
AF5350	182	285
AF5350	183	286
AF5350	184	287
AF5350	185	288
AF5360	182	285
AF5360	183	286
AF5360	184	287
AF5360	185	288
AF5360	409	630
AF5381	139	219
AF5381	142	223
AF5381	144	226
AF5381	149	231
AF5381	150	232
AF5381	151	233
AF5381	152	234
AF5381	154	237
AF5381	155	238
AF5381	156	239
AF5381	158	243
AF5381	160	247
AF5381	161	249
AF5381	162	250
AF5381	163	252
AF5381	163	253
AF5381	164	254
AF5381	165	256
AF5381	165	257
AF5381	166	258
AF5381	167	259
AF5381	168	260
AF5381	169	261
AF5391	139	219
AF5391	142	223
AF5391	144	226
AF5391	149	231
AF5391	150	232
AF5391	151	233
AF5391	152	234
AF5391	154	237
AF5391	155	238
AF5391	156	239
AF5391	158	243
AF5391	160	247
AF5391	161	249
AF5391	162	250
AF5391	163	252
AF5391	163	253
AF5391	164	254
AF5391	165	256
AF5391	165	257

NUMERICAL PARTS LIST

Nummerische Teilenummernliste • Elenco riferimenti
Liste des références produits

		9
AF5391	166	258
AF5391	167	259
AF5391	168	260
AF5391	169	261
AF5401	139	219
AF5401	142	223
AF5401	144	226
AF5401	149	231
AF5401	150	232
AF5401	151	233
AF5401	152	234
AF5401	154	237
AF5401	155	238
AF5401	156	239
AF5401	158	243
AF5401	160	247
AF5401	161	249
AF5401	162	250
AF5401	163	252
AF5401	163	253
AF5401	164	254
AF5401	165	256
AF5401	165	257
AF5401	166	258
AF5401	167	259
AF5401	168	260
AF5401	169	261
AF5990	34	57
AF5990	36	60
AF5990	36	61
AF5990	37	62
AG5000	359	544
AG5000	364	555
AG5000	365	557
AG5000	366	558
AG5000	367	559
AG5000	368	560
AG7800	354	533
AG8800	289	435
AG8800	292	440
AG8800	293	441
AG8800	294	442
AG8800	296	444
AG8800	298	446
AG8800	299	447
AG8800	300	450
AG8800	301	451
AG8800	302	455
AG8800	303	456
AG8800	303	457
AG8800	304	458
AG8800	305	460
AG8800	308	465
AG8800	369	562
AG8810	390	589
AG8820	347	522
AG8820	352	530
AG8830	290	436

		9
AG8830	290	437
AG8840	33	56
AG8840	35	58
AG8840	35	59
AG8840	37	63
AG8850	51	80
AG8850	52	82
AG8850	53	85
AG8850	81	123
AG8850	82	124
AG8860	371	567
AG8860	422	654
AG8860	424	656
AG8860	425	658
AG8870	371	567
AG8870	422	654
AG8870	424	656
AG8870	425	658
AG8880	371	567
AG8880	422	654
AG8880	424	656
AG8880	425	658
AG8890	371	567
AG8890	422	654
AG8890	424	656
AG8890	425	658
AG8900	371	567
AG8900	422	654
AG8900	424	656
AG8900	425	658
AG8910	371	567
AG8910	422	654
AG8910	424	656
AG8910	425	658
AG8920	347	522
AG8920	352	530
AG8930	334	507
AG8930	347	522
AG8930	351	528
AG8930	351	529
AG8930	352	530
AG8940	290	436
AG8940	290	437
AG8950	290	436
AG8950	290	437
AG8960	289	435
AG8960	292	440
AG8960	293	441
AG8960	294	442
AG8960	296	444
AG8960	298	446
AG8960	299	447
AG8960	300	450
AG8960	301	451
AG8960	302	455
AG8960	303	456
AG8960	303	457
AG8960	304	458
AG8960	305	460
AG8960	308	465
AG8960	369	562

		9
AG8960	305	460
AG8960	308	465
AG8960	369	562
AG8970	289	435
AG8970	292	440
AG8970	293	441
AG8970	294	442
AG8970	296	444
AG8970	298	446
AG8970	299	447
AG8970	300	450
AG8970	301	451
AG8970	302	455
AG8970	303	456
AG8970	303	457
AG8970	304	458
AG8970	305	460
AG8970	308	465
AG8970	369	562
AG9600	393	595
AG9600	395	598
AG9600	404	614
AG9600	405	615
AG9610	426	663
AG9610	427	664
AG9610	428	665
AG9610	428	666
AG9630	162	251
AG9630	291	439
AG9630	295	443
AG9630	297	445
AG9630	299	448
AG9630	300	449
AG9630	301	452
AG9630	302	454
AG9630	304	459
AG9630	309	471
AG9640	162	251
AG9640	291	439
AG9640	295	443
AG9640	297	445
AG9640	299	448
AG9640	300	449
AG9640	301	452
AG9640	302	454
AG9640	304	459
AG9640	309	469
AG9640	309	470
AG9640	309	471
AG9650	162	251
AG9650	291	439
AG9650	295	443
AG9650	297	445
AG9650	299	448
AG9650	300	449
AG9650	301	452
AG9650	302	454
AG9650	304	459
AG9650	309	469
AG9650	309	470
AG9650	309	471

		9
AH5380	287	433
AH5380	373	569
AH5380	375	571
AH5380	395	599
AH5960	30	50
AH5960	53	84
AH5960	55	87
AH5960	55	88
AH5960	56	89
AH5960	56	90
AH5960	57	92
AH5960	82	125
AH5970	349	525
AH5970	350	526
AH5970	350	527
AH5970	353	531
AH5970	353	532
AH5980	349	525
AH5980	350	526
AH5980	350	527
AH5980	353	531
AH5980	353	532
AH5990	349	525
AH5990	350	526
AH5990	350	527
AH5990	353	531
AH5990	353	532
AY061	355	536
AY061	413	636
AY061	414	637
AY061	414	638
AY061	415	640
AY061	416	641
AY930	24	39
AY940	186	292
AY940	192	299
AY940	194	301
AY960	314	481
AY960	320	488
AY960	321	489
AY960	321	490
AY960	322	491
AY960	331	502
AY970	222	343
AY970	224	345
AY970	225	346
AY970	226	347
AY970	227	348
AY970	228	349
AY970	229	350
AY970	230	351
AY970	231	352
AY970	232	353
AY970	232	354
AY970	233	355
AY970	233	356
AY970	235	359
AY970	235	360

			9
AY970	236	361	
AY970	237	362	
AY970	238	363	
AY970	239	364	
AY970	240	365	
AY970	241	366	
AY970	242	367	
AY970	243	368	
AY970	244	369	
AY970	245	370	
AY970	246	371	
AY970	247	372	
AY970	248	373	
AY970	249	374	
AY970	249	375	
AY970	250	376	
AY970	250	377	
AY970	251	378	
AY970	252	379	
AY970	253	380	
AY970	254	382	
AY970	254	383	
AY970	255	384	
AY970	256	386	
AY970	256	387	
AY970	257	392	
AY970	258	394	
AY970	258	395	
AY970	259	397	
BD620	170	265	
BD620	171	268	
BD620	172	269	
BD620	172	270	
BD620	173	271	
BD620	174	272	
BD620	175	273	
BD620	175	274	
BD620	176	275	
BD620	176	276	
BD620	177	277	
BD620	178	278	
BD620	179	279	
BD620	179	280	
BD620	180	281	
BD620	180	282	
BD620	181	283	
BD620	181	284	
BG870	87	137	
BG870	87	138	
BG870	106	165	
BG870	107	166	
BG870	107	167	
BG870	108	168	
BG870	108	169	
BG870	109	170	
BG870	109	171	
BG870	110	172	
BG870	110	173	

			9
BG870	111	174	
BG870	111	175	
BG870	112	176	
BG870	113	178	
BG870	113	179	
BG870	114	181	
BG870	114	182	
BG870	115	183	
BG870	116	184	
BG870	116	185	
BG870	117	186	
BG870	117	187	
BG870	118	188	
BG870	119	189	
BG870	119	190	
BG870	120	191	
BG870	120	192	
BG870	120	193	
BG870	121	195	
BG870	170	267	
BG940	90	142	
BG940	92	144	
BH720	62	102	
BH720	63	103	
BH720	65	105	
BH720	66	106	
BH720	69	109	
BH730	62	102	
BH730	63	103	
BH730	65	105	
BH730	66	106	
BH730	69	109	
BL560	5	7	
BL560	5	8	
BL560	6	9	
BL560	6	10	
BL560	7	11	
BL560	7	12	
BL560	8	13	
BL570	9	16	
BL570	10	17	
BL570	11	18	
BL570	12	19	
BL570	12	20	
BL570	13	21	
BL570	13	22	
BL570	14	23	
BL570	15	24	
BL570	16	25	
BL570	17	27	
BL570	18	28	
BL570	18	29	
BL570	19	30	
BL570	19	31	
BL570	20	32	
BL570	20	33	
BL570	21	34	
BL570	21	35	

			9
BL570	22	36	
BL570	22	37	
BL570	23	38	
BL570	27	44	
BM360	185	289	
BM360	187	293	
BM360	188	294	
BM360	189	295	
BM360	190	296	
BM360	191	297	
BM360	191	298	
BM360	206	319	
BM360	207	320	
BM360	207	321	
BM360	208	322	
BM360	208	323	
BM360	209	324	
BM360	209	325	
BM360	210	326	
BM360	210	327	
BM360	211	328	
BM360	212	329	
BM360	213	330	
BM360	214	331	
BM360	214	332	
BM360	216	335	
BM360	217	336	
BM360	218	337	
BM360	219	338	
BM360	220	339	
BM360	222	342	
BM360	223	344	
BM360	260	400	
BM360	261	401	
BM360	262	402	
BM360	262	403	
BM360	263	404	
BM360	264	405	
BM360	265	406	
BM360	266	407	
BM360	267	408	
BM360	267	409	
BM360	268	410	
BM360	269	411	
BM360	270	412	
BM360	271	413	
BM360	272	414	
BM360	273	415	
BM360	274	416	
BM360	275	417	
BM360	276	418	
BM360	276	419	
BM360	277	420	
BM360	278	421	
BM360	280	423	
BM360	281	425	
BM360	282	426	
BM360	283	427	

			9
BM360	283	428	
BM360	284	429	
BM360	285	430	
BM360	285	431	
BM360	286	432	
BM540	434	686	
BM540	434	687	
BM540	434	688	
BM840	312	477	
BM840	312	478	
BM840	313	479	
BM840	314	480	
BM840	315	482	
BM840	316	483	
BM840	317	484	
BM840	318	485	
BM840	319	486	
BM840	320	487	
BM840	322	492	
BM840	323	493	
BM840	324	494	
BM840	325	495	
BM840	326	496	
BM840	327	497	
BM840	328	498	
BM840	329	499	
BM840	330	500	
BM840	331	501	
BN070	60	99	
BN080	62	102	
BN080	63	103	
BN080	64	104	
BN080	65	105	
BN080	66	106	
BN080	67	107	
BN090	62	102	
BN090	63	103	
BN090	64	104	
BN090	65	105	
BN090	66	106	
BN090	67	107	
BN100	62	102	
BN100	63	103	
BN100	64	104	
BN100	65	105	
BN100	66	106	
BN100	67	107	
BN940	61	101	
BN940	64	104	
BN940	65	105	
BN940	66	106	
BN940	67	107	
BN940	69	109	
BN940	70	110	
BN940	83	126	
BN940	83	128	
BN940	83	129	
BN940	84	130	

NUMERICAL PARTS LIST

Nummerische Teilenummernliste • Elenco riferimenti
Liste des références produits

 9		
BN940	84	131
BN950	61	101
BN950	64	104
BN950	65	105
BN950	66	106
BN950	67	107
BN950	69	109
BN950	70	110
BN950	83	126
BN950	83	128
BN950	83	129
BN950	84	130
BN950	84	131
BN960	61	101
BN960	64	104
BN960	65	105
BN960	66	106
BN960	67	107
BN960	69	109
BN960	70	110
BN960	83	126
BN960	83	128
BN960	83	129
BN960	84	130
BN960	84	131
BT020	62	102
BT020	63	103
BT020	64	104
BT020	67	107
BT020	68	108
BT470	84	132
BT470	85	133
BT470	85	134
BT580	28	46
BT580	29	47
BT580	29	48
BT580	30	51
BT580	31	52
BT580	31	53
BT810	376	572
BT810	377	573
BT810	378	574
BT810	378	575
BT810	379	576
BT810	379	577
BT810	380	578
BT810	381	579
BT810	382	580
BT810	383	581
BT820	410	632
BT820	411	633
BT820	412	634
BV460	25	40
BV460	28	45
BV471	25	40
BV471	28	45
BV481	25	40
BV481	28	45

 9		
BV850	124	201
BV850	125	202
BV850	127	204
BV850	128	205
BV850	128	206
BV850	128	207
BV850	129	208
BV850	129	209
BV850	159	244
BV850	185	290
BV860	124	201
BV860	125	202
BV860	127	204
BV860	128	205
BV860	128	206
BV860	128	207
BV860	129	208
BV860	129	209
BV860	159	244
BV860	185	290
BV870	124	201
BV870	125	202
BV870	127	204
BV870	128	205
BV870	128	206
BV870	128	207
BV870	129	208
BV870	129	209
BV870	159	244
BV870	185	290
BV880	332	503
BV880	333	504
BV880	333	505
BV880	335	508
BV880	335	509
BV880	336	510
BW680	88	140
BW680	89	141
BW680	90	142
BW680	91	143
BW680	92	144
BW680	93	145
BW680	94	146
BW690	88	140
BW690	89	141
BW690	90	142
BW690	91	143
BW690	92	144
BW690	93	145
BW690	94	146
BW700	88	140
BW700	89	141
BW700	90	142
BW700	91	143
BW700	92	144
BW700	93	145
BW700	94	146
BW790	279	422

 9		
BW790	288	434
BX800	122	196
BX800	122	197
BX800	123	198
BX800	123	199
BX800	124	200
BX800	126	203
BX800	130	210
BX800	131	211
BX800	133	213
BX800	137	217
BX800	138	218
BX800	140	220
BX800	147	229
BX800	153	235
BX810	122	197
BX810	123	198
BX810	123	199
BX810	124	200
BX810	126	203
BX810	130	210
BX810	131	211
BX810	132	212
BX810	133	213
BX810	137	217
BX810	138	218
BX810	140	220
BX810	147	229
BX810	153	235
BX820	122	196
BX820	122	197
BX820	123	198
BX820	123	199
BX820	124	200
BX820	126	203
BX820	130	210
BX820	131	211
BX820	132	212
BX820	133	213
BX820	137	217
BX820	138	218
BX820	140	220
BX820	147	229
BX820	153	235
BX820	130	210
BX820	131	211
BX820	132	212
BX820	133	213
BX820	126	203
BX820	130	210
BX820	131	211
BX820	132	212
BX820	133	213
BY620	72	112
BY630	215	334
BY630	281	424
BY750	380	578
BY750	381	579
BY750	384	582
BY750	385	584
BY750	387	586
BY750	388	587
BY750	389	588
BZ010	134	214
BZ010	135	215
BZ010	136	216
BZ010	141	221

 9		
BZ020	134	214
BZ020	135	215
BZ020	136	216
BZ020	141	221
BZ030	134	214
BZ030	135	215
BZ030	136	216
BZ030	141	221
BZ040	134	214
BZ040	135	215
BZ040	136	216
BZ040	141	221
BZ040	143	224
BZ040	143	225
BZ040	145	227
BZ040	146	228
BZ040	148	230
BZ040	153	236
BZ040	157	240
BZ040	157	241
BZ040	158	242
BZ040	161	248
BZ040	169	262
BZ050	134	214
BZ050	135	215
BZ050	136	216
BZ050	141	221
BZ050	143	224
BZ050	143	225
BZ050	145	227
BZ050	146	228
BZ050	148	230
BZ050	153	236
BZ050	157	240
BZ050	157	241
BZ050	158	242
BZ050	161	248
BZ050	169	262
BZ060	134	214
BZ060	135	215
BZ060	136	216
BZ060	141	221
BZ060	143	224
BZ060	143	225
BZ060	145	227
BZ060	146	228
BZ060	148	230
BZ060	153	236
BZ060	157	240
BZ060	157	241
BZ060	158	242
BZ060	161	248
BZ060	169	262
BZ180	38	64
BZ180	38	65
BZ180	44	71
BZ180	46	74
BZ180	46	75

 9		
BZ180	60	100
BZ180	73	113
BZ180	73	114
BZ180	75	116
BZ180	215	333
BZ900	435	691
BZ910	191	298
BZ910	194	302
BZ910	205	315
BZ910	219	338
BZ910	220	339
BZ910	221	340
BZ910	221	341
BZ910	223	344
BZ910	234	357
BZ910	234	358
BZ910	257	389
BZ910	258	393
BZ930	93	145
BZ930	94	146
BZ960	356	538
BZ960	356	539
BZ960	357	540
BZ960	357	541
BZ960	358	542
BZ960	358	543
BZ960	359	545
BZ960	360	547
BZ960	360	548
BZ960	361	550
BZ960	362	551
CA5410	1	1
CA5410	4	4
CA5430	363	553
CA5430	364	554
CA5430	372	568
CA5470	183	286
CA5470	334	506
CA5470	339	514
CA5470	341	516
CA5470	342	517
CA5470	343	518
CA5470	344	519
CA5470	345	520
CA5470	348	523
CA5500	39	66
CAM393	61	101
CAM393	64	104
CAM393	65	105
CAM393	66	106
CAM393	67	107
CAM393	69	109
CAM393	70	110
CAM411	216	335
CAM411	263	404
CAM411	264	405
CAM411	265	406
CAM411	267	408

 9		
CAM411	270	412
CAM411	276	419
CAM411	278	421
CAM411	280	423
CAM411	282	426
CAM411	283	427
CAM411	283	428
CAM440	124	201
CAM440	125	202
CAM440	127	204
CAM440	128	205
CAM440	129	209
CAM441	126	203
CAM441	131	211
CAM441	132	212
CAM441	137	217
CAM441	138	218
CAM441	140	220
CAM441	153	235
CAM442	330	500
CAM442	334	506
CAM442	336	511
CAM442	337	512
CAM442	338	513
CAM442	339	514
CAM442	340	515
CAM442	341	516
CAM442	342	517
CAM442	343	518
CAM442	344	519
CAM442	345	520
CAM442	346	521
CAM442	348	523
CAM447	88	140
CAM447	89	141
CAM447	90	142
CAM447	91	143
CAM447	92	144
CAM447	93	145
CAM447	94	146
CAM630	84	132
CAM630	85	133
CAM630	85	134
CAM630	182	285
CAM630	183	286
CAM630	184	287
CAM630	185	288
CAM668	122	197
CAM668	123	198
CAM668	123	199
CAM668	124	200
CAM668	126	203
CAM668	130	210
CAM668	133	213
CAM670	134	214
CAM670	143	224
CAM670	148	230
CAM670	157	240

 9		
CAM671	135	215
CAM671	136	216
CAM671	141	221
CAM671	146	228
CAM672	139	219
CAM672	142	223
CAM672	144	226
CAM672	149	231
CAM672	150	232
CAM672	151	233
CAM672	152	234
CAM672	154	237
CAM672	155	238
CAM672	156	239
CAM672	158	243
CAM672	160	247
CAM672	163	252
CAM672	167	259
CAM672	168	260
CAM673	102	159
CAM673	103	160
CAM673	104	161
CAM673	105	162
CAM700	95	150
CAM700	96	151
CAM700	98	153
CAM700	100	155
CAM701	95	150
CAM701	96	151
CAM701	98	153
CAM701	100	155
CAM702	95	150
CAM702	96	151
CAM702	98	153
CAM702	100	155
CAM703	95	150
CAM703	96	151
CAM703	98	153
CAM703	100	155
CAM730	347	522
CAM739	222	342
CAM739	378	575
CAM739	381	579
CAM739	384	582
CAM740	222	342
CAM740	378	575
CAM740	381	579
CAM740	384	582
CAM743	224	345
CAM743	227	348
CAM743	228	349
CAM743	229	350
CAM743	230	351
CAM743	231	352
CAM743	233	356
CAM743	236	361
CAM743	238	363
CAM743	239	364

 9		
CAM743	241	366
CAM743	244	369
CAM743	245	370
CAM743	246	371
CAM743	247	372
CAM744	224	345
CAM744	227	348
CAM744	228	349
CAM744	229	350
CAM744	230	351
CAM744	231	352
CAM744	232	353
CAM744	232	354
CAM744	233	356
CAM744	236	361
CAM744	238	363
CAM744	239	364
CAM744	241	366
CAM744	244	369
CAM744	245	370
CAM744	246	371
CAM744	247	372
CAM744	248	373
CAM744	249	374
CAM744	250	377
CAM744	251	378
CAM744	252	379
CAM744	253	380
CAM744	254	383
CAM744	255	384
CAM744	256	386
CAM744	257	392
CAM744	258	395
CAM744	259	397
CAM744	259	398
CAM745	197	305
CAM745	201	310
CAM808	38	65
CAM808	44	71
CAM808	46	74
CAM808	46	75
CAM904	162	250
CAM904	163	253
CAM904	165	256
CAM904	165	257
CAM904	166	258
CAM904	169	261
CAM904	295	443
CAM904	297	445
CAM904	299	448
CAM904	300	449
CAM904	301	452
CAM904	302	454
CAM912	334	507
CAM912	352	530
CAM913	186	292
CAM913	192	299
CAM913	193	300

NUMERICAL PARTS LIST

Nummerische Teilenummernliste • Elenco riferimenti
Liste des références produits

 9		
CAM913	195	303
CAM913	196	304
CAM913	198	306
CAM913	199	308
CAM913	200	309
CAM913	386	585
CAM913	388	587
CAM913	389	588
CAM913	392	593
CAM913	394	596
CAM914	139	219
CAM914	142	223
CAM914	144	226
CAM914	149	231
CAM914	150	232
CAM914	151	233
CAM914	152	234
CAM914	154	237
CAM914	155	238
CAM914	156	239
CAM914	158	243
CAM914	160	247
CAM914	163	252
CAM914	167	259
CAM914	168	260
CAM916	347	522
CAM916	351	528
CAM928	139	219
CAM928	142	223
CAM928	144	226
CAM928	149	231
CAM928	150	232
CAM928	151	233
CAM928	152	234
CAM928	154	237
CAM928	155	238
CAM928	156	239
CAM928	158	243
CAM928	160	247
CAM928	163	252
CAM928	167	259
CAM928	168	260
CB5370	386	585
CB5370	391	590
CB5370	396	600
CB5370	397	601
CB5370	398	602
CB5370	399	603
CB5370	400	606
CB5370	401	608
CB5371	399	604
CB5700	40	67
CB5700	43	70
CB5700	47	76
CB5700	48	77
CB5700	50	79
CB5700	54	86
CB5700	56	90

 9		
CB5700	57	91
CB5700	415	639
CC5190	32	54
CC5190	33	55
CC5220	195	303
CC5220	198	306
CC5221	199	308
CC5221	200	309
CC5222	201	310
CC5222	202	311
CC5222	203	312
CC5222	204	313
CC5222	204	314
CC5222	205	317
CC5222	206	318
CC5223	197	305
CC5230	142	223
CC5230	149	231
CC5230	150	232
CC5230	151	233
CC5230	152	234
CC5230	154	237
CC5230	155	238
CC5230	156	239
CC5230	158	243
CC5230	160	247
CC5230	161	249
CC5230	164	254
CC5231	139	219
CC5231	144	226
CC5231	148	230
CC5231	162	251
CC5231	163	252
CC5231	163	253
CC5231	166	258
CC5231	168	260
CC5231	169	261
CC5231	290	436
CC5231	290	437
CC5231	291	439
CC5231	299	448
CC5231	300	449
CC5231	302	454
CC5231	309	469
CC5231	348	523
CC5280	71	111
CC5280	74	115
CC5281	78	119
CC5281	80	122
CC5282	79	120
CC5960	95	150
CC5960	96	151
CC5960	97	152
CC5960	98	153
CC5960	99	154
CC5960	100	155
CC5960	100	156

 9		
CD5630	3	3
CD5640	41	68
CD5640	42	69
CD5640	45	73
CD5640	49	78
CD5650	102	159
CD5650	103	160
CD5650	104	161
CD5650	105	162
CF5990	34	57
CF5990	36	60
CF5990	36	61
CF5990	37	62
CG5000	364	555
CG5010	365	557
CG5010	366	558
CG5030	367	559
CG7800	354	533
CG8410	289	435
CG8410	292	440
CG8410	293	441
CG8410	294	442
CG8410	295	443
CG8410	296	444
CG8410	298	446
CG8410	299	447
CG8410	300	450
CG8410	301	451
CG8410	302	455
CG8410	303	457
CG8410	304	458
CG8410	308	465
CG8410	369	562
CG8420	390	589
CG8840	33	56
CG8840	35	58
CG8840	35	59
CG8840	37	63
CG8850	51	80
CG8850	52	82
CG8850	53	85
CG8850	81	123
CG8880	371	567
CG8880	422	654
CG8880	424	656
CG8880	424	657
CG8880	425	658
CG9600	393	595
CG9600	395	598
CG9600	404	614
CG9600	405	615
CG9610	426	663
CG9610	427	664
CG9610	428	665
CG9610	428	666
CG9620	354	534
CG9621	355	535
CH5960	30	50

 9		
CH5960	53	84
CH5960	55	87
CH5960	55	88
CH5960	56	89
CH5960	57	92
CV480	94	147
CV480	94	148
CV480	95	149
CV480	421	652
CV480	421	653
CV480	426	661
CY930	24	39
CY941	186	292
CY941	194	301
CY942	192	299
CY960	314	481
CY960	320	488
CY960	321	489
CY960	321	490
CY960	322	491
CY960	331	502
CY970	222	343
CY970	224	345
CY970	225	346
CY970	229	350
CY970	230	351
CY970	233	356
CY970	237	362
CY970	240	365
CY970	242	367
CY970	243	368
CY970	244	369
CY970	249	375
CY971	226	347
CY971	227	348
CY971	228	349
CY971	231	352
CY971	232	353
CY971	232	354
CY971	233	355
CY971	235	359
CY971	236	361
CY971	238	363
CY971	239	364
CY971	241	366
CY971	245	370
CY971	246	371
CY971	247	372
CY971	248	373
CY971	249	374
CY971	250	376
CY971	250	377
CY971	251	378
CY971	252	379
CY971	253	380
CY971	254	383
CY971	255	384
CY971	256	386

			9
CY971	256	387	
CY971	257	392	
CY971	258	394	
CY971	258	395	
CY971	259	397	
CY980	193	300	
CY980	196	304	
DD501	60	99	
DD501	62	102	
DD501	63	103	
DD501	64	104	
DD501	65	105	
DD501	66	106	
DD501	67	107	
DD501	69	109	
DD501	83	129	
DD502	61	101	
DD502	68	108	
DD502	70	110	
DD502	83	126	
DD620	174	272	
DD620	179	279	
DD620	180	281	
DD621	170	265	
DD621	171	268	
DD621	173	271	
DD621	174	272	
DD621	176	275	
DD621	177	277	
DD621	178	278	
DD621	179	279	
DD621	179	280	
DD622	172	269	
DD622	172	270	
DD622	175	273	
DD622	175	274	
DD622	176	276	
DD622	180	282	
DD622	181	283	
DD622	181	284	
DG871	87	137	
DG871	87	138	
DG871	106	165	
DG871	107	166	
DG871	107	167	
DG871	108	168	
DG871	108	169	
DG871	109	170	
DG871	109	171	
DG871	110	172	
DG871	110	173	
DG871	111	174	
DG871	111	175	
DG871	112	176	
DG871	113	178	
DG871	113	179	
DG871	114	181	
DG871	114	182	

			9
DG871	115	183	
DG871	116	184	
DG871	116	185	
DG871	117	186	
DG871	117	187	
DG871	118	188	
DG871	119	189	
DG871	119	190	
DG871	120	191	
DG871	120	192	
DG871	120	193	
DG871	121	195	
DG871	170	267	
DG871	207	321	
DL491	84	132	
DL491	85	133	
DL491	85	134	
DL560	5	7	
DL560	5	8	
DL560	6	9	
DL560	6	10	
DL560	7	11	
DL560	8	13	
DL561	5	7	
DL561	5	8	
DL561	6	9	
DL561	6	10	
DL561	7	11	
DL561	8	13	
DL570	12	20	
DL570	13	21	
DL570	18	29	
DL570	19	31	
DL570	21	34	
DL570	21	35	
DL571	17	27	
DL571	18	28	
DL571	19	30	
DL571	20	32	
DL571	20	33	
DL572	9	16	
DL572	10	17	
DL572	11	18	
DL572	13	22	
DL572	14	23	
DL572	15	24	
DL572	16	25	
DL572	22	36	
DL572	22	37	
DL572	23	38	
DL573	12	19	
DL573	27	44	
DL574	9	16	
DL574	10	17	
DL574	11	18	
DL574	13	22	
DL574	14	23	
DL574	15	24	

			9
DL574	16	25	
DL574	23	38	
DL574	27	44	
DL580	26	42	
DL580	26	43	
DL580	58	93	
DL580	58	95	
DL580	59	96	
DL580	59	97	
DL580	59	98	
DL581	25	41	
DM360	206	319	
DM360	207	320	
DM360	207	321	
DM360	208	322	
DM360	208	323	
DM360	209	324	
DM360	209	325	
DM360	210	326	
DM360	210	327	
DM360	211	328	
DM360	212	329	
DM360	213	330	
DM360	214	332	
DM360	216	335	
DM360	218	337	
DM360	260	400	
DM360	261	401	
DM360	262	402	
DM360	262	403	
DM360	264	405	
DM360	273	415	
DM360	274	416	
DM360	276	418	
DM360	277	420	
DM360	283	428	
DM360	285	430	
DM361	188	294	
DM361	189	295	
DM361	191	297	
DM361	272	414	
DM361	281	425	
DM361	282	426	
DM361	286	432	
DM363	214	331	
DM363	276	419	
DM363	285	431	
DM365	222	342	
DM365	275	417	
DM366	283	428	
DM367	189	295	
DM367	191	297	
DM367	219	338	
DM367	220	339	
DM367	223	344	
DM368	187	293	
DM368	190	296	
DM368	207	321	

			9
DM368	208	322	
DM368	208	323	
DM368	209	324	
DM368	209	325	
DM368	210	326	
DM368	211	328	
DM368	213	330	
DM368	216	335	
DM368	217	336	
DM368	263	404	
DM368	265	406	
DM368	266	407	
DM368	267	408	
DM368	267	409	
DM368	268	410	
DM368	269	411	
DM368	270	412	
DM368	271	413	
DM368	276	418	
DM368	278	421	
DM368	280	423	
DM368	283	427	
DM368	283	428	
DM368	284	429	
DM541	434	686	
DM660	88	140	
DM660	89	141	
DM660	90	142	
DM660	91	143	
DM660	92	144	
DM690	436	693	
DM690	436	694	
DM690	436	695	
DM690	436	696	
DM690	437	697	
DM690	437	698	
DM690	437	699	
DM690	438	700	
DM700	86	135	
DM700	86	136	
DM840	312	477	
DM840	312	478	
DM840	313	479	
DM840	314	480	
DM840	316	483	
DM840	317	484	
DM840	318	485	
DM840	319	486	
DM840	320	487	
DM840	322	492	
DM840	323	493	
DM840	324	494	
DM840	325	495	
DM840	326	496	
DM840	327	497	
DM840	328	498	
DM840	329	499	
DM840	330	500	

NUMERICAL PARTS LIST

Nummerische Teilenummernliste • Elenco riferimenti
Liste des références produits

 9		
DM840	331	501
DT81B	381	579
DT81C	383	581
DT580	28	46
DT580	29	47
DT580	29	49
DT581	30	51
DT581	31	52
DT581	31	53
DT590	121	194
DT660	355	536
DT660	414	637
DT811	377	573
DT812	379	576
DT813	376	572
DT813	378	574
DT813	378	575
DT814	379	577
DT814	380	578
DT814	382	580
DT815	380	578
DT815	383	581
DT816	377	573
DT819	215	334
DT819	281	424
DT820	410	632
DT820	411	633
DT820	412	634
DV460	25	40
DV460	28	45
DV850	124	201
DV850	125	202
DV850	127	204
DV850	128	205
DV850	128	206
DV850	128	207
DV850	129	209
DV850	185	290
DV851	125	202
DV851	128	205
DV851	128	206
DV851	128	207
DV851	129	209
DV851	159	244
DV880	332	503
DV880	333	504
DV880	333	505
DV880	335	508
DV880	335	509
DV880	336	510
DW790	279	422
DW790	288	434
DW830	182	285
DW830	183	286
DW830	184	287
DW860	336	511
DW860	337	512
DW860	338	513

 9		
DW860	340	515
DW861	336	511
DW861	337	512
DW861	338	513
DX800	126	203
DX800	131	211
DX800	132	212
DX800	138	218
DX801	122	196
DX801	122	197
DX801	123	198
DX801	123	199
DX801	124	200
DX801	126	203
DX801	130	210
DX801	131	211
DX801	132	212
DX801	133	213
DX801	137	217
DX801	138	218
DX801	140	220
DX801	147	229
DX801	153	235
DY620	72	112
DY750	380	578
DY751	384	582
DY752	384	582
DY753	385	584
DY753	387	586
DY753	388	587
DY753	389	588
DY850	415	640
DZ010	134	214
DZ010	135	215
DZ010	136	216
DZ010	141	221
DZ010	143	224
DZ010	145	227
DZ010	146	228
DZ160	435	691
DZ180	38	64
DZ180	73	113
DZ181	38	65
DZ181	44	71
DZ181	46	74
DZ181	46	75
DZ181	60	100
DZ181	73	114
DZ181	75	116
DZ181	215	333
DZ910	219	338
DZ910	220	339
DZ910	221	340
DZ910	221	341
DZ910	223	344
DZ910	234	357
DZ910	234	358
DZ960	356	538

 9		
DZ960	356	539
DZ960	357	540
DZ960	357	541
DZ960	358	542
DZ960	358	543
DZ960	359	545
FOL91	25	41
FOL91	62	102
FOL91	63	103
FOL91	90	142
FOL91	91	143
FOL91	92	144
FOL91	113	178
FOL91	115	183
FOL91	170	265
FOL91	171	268
FOL91	173	271
FOL91	175	273
FOL91	176	275
FOL91	177	277
FOL91	178	278
FOL91	179	279
FOL91	180	282
FOL92	9	16
FOL92	10	17
FOL92	11	18
FOL92	12	19
FOL92	13	22
FOL92	14	23
FOL92	15	24
FOL92	16	25
FOL92	21	34
FOL92	22	36
FOL92	22	37
FOL92	23	38
FOL92	24	39
FOL92	25	40
FOL92	28	45
FOL92	61	101
FOL92	64	104
FOL92	65	105
FOL92	66	106
FOL92	67	107
FOL92	69	109
FOL92	70	110
FOL92	72	112
FOL92	84	132
FOL92	85	133
FOL92	85	134
FOL92	86	135
FOL92	88	140
FOL92	89	141
FOL92	90	142
FOL92	91	143
FOL92	92	144
FOL92	93	145
FOL92	94	146
FOL92	122	197

 9		
FOL92	123	198
FOL92	123	199
FOL92	124	200
FOL92	124	201
FOL92	125	202
FOL92	126	203
FOL92	127	204
FOL92	128	205
FOL92	129	209
FOL92	130	210
FOL92	131	211
FOL92	132	212
FOL92	133	213
FOL92	137	217
FOL92	138	218
FOL92	140	220
FOL92	153	235
FOL92	182	285
FOL92	183	286
FOL92	184	287
FOL92	185	288
FOL92	188	294
FOL92	189	295
FOL92	190	296
FOL92	191	297
FOL92	206	319
FOL92	207	320
FOL92	207	321
FOL92	208	323
FOL92	211	328
FOL92	212	329
FOL92	213	330
FOL92	214	331
FOL92	214	332
FOL92	215	334
FOL92	216	335
FOL92	217	336
FOL92	218	337
FOL92	223	344
FOL92	261	401
FOL92	262	402
FOL92	263	404
FOL92	264	405
FOL92	265	406
FOL92	266	407
FOL92	267	408
FOL92	270	412
FOL92	272	414
FOL92	274	416
FOL92	275	417
FOL92	276	418
FOL92	276	419
FOL92	277	420
FOL92	278	421
FOL92	279	422
FOL92	280	423
FOL92	281	424
FOL92	282	426

 9		
FOL92	283	427
FOL92	283	428
FOL92	284	429
FOL92	285	430
FOL92	313	479
FOL92	314	480
FOL92	314	481
FOL92	315	482
FOL92	316	483
FOL92	317	484
FOL92	318	485
FOL92	319	486
FOL92	320	487
FOL92	320	488
FOL92	321	489
FOL92	321	490
FOL92	322	491
FOL92	324	494
FOL92	325	495
FOL92	326	496
FOL92	327	497
FOL92	328	498
FOL92	330	500
FOL92	331	501
FOL92	331	502
FOL92	334	506
FOL92	336	511
FOL92	337	512
FOL92	338	513
FOL92	339	514
FOL92	340	515
FOL92	341	516
FOL92	342	517
FOL92	343	518
FOL92	344	519
FOL92	345	520
FOL92	346	521
FOL92	348	523
FOL92	349	525
FOL92	350	526
FOL92	350	527
FOL92	354	533
FOL92	363	553
FOL92	364	554
FOL92	372	568
FOL92	376	572
FOL92	378	574
FOL92	378	575
FOL92	379	576
FOL92	379	577
FOL92	381	579
FOL92	384	582
FOL92	386	585
FOL92	393	594
FOL92	402	610
FOL92	410	631
FOL92	410	632
FOL92	411	633



 9		
FOL92	412	634
FOL92	416	641
FOL114	32	54
FOL114	33	55
FOL114	102	159
FOL114	103	160
FOL114	104	161
FOL114	105	162
FOL114	105	163
FOL114	164	254
FOL133	222	343
FOL133	224	345
FOL133	225	346
FOL133	226	347
FOL133	227	348
FOL133	228	349
FOL133	229	350
FOL133	230	351
FOL133	231	352
FOL133	232	353
FOL133	232	354
FOL133	233	356
FOL133	235	360
FOL133	236	361
FOL133	237	362
FOL133	238	363
FOL133	239	364
FOL133	241	366
FOL133	242	367
FOL133	243	368
FOL133	244	369
FOL133	245	370
FOL133	246	371
FOL133	247	372
FOL133	248	373
FOL133	249	374
FOL133	249	375
FOL133	250	377
FOL133	251	378
FOL133	252	379
FOL133	253	380
FOL133	254	383
FOL133	255	384
FOL133	256	386
FOL133	257	392
FOL133	258	395
FOL133	259	397
FOL133	259	398
FOL133	252	379
FOL133	253	380
FOL133	254	383
FOL133	255	384
FOL133	256	386
FOL133	257	392
FOL133	258	395
FOL133	259	397
FOL133	259	398
FOL133	356	538
FOL133	356	539
FOL133	357	540
FOL133	357	541
FOL133	358	543
FOL133	359	545
FOL133	360	547
FOL133	360	548
FOL133	361	550
FOL133	390	589



 9		
FOL133	415	639
FOL133	417	642
FOL133	418	644
FOL133	418	645
FOL133	419	646
FOL133	420	648
FOL141	222	343
FOL141	224	345
FOL141	226	347
FOL141	227	348
FOL141	228	349
FOL141	229	350
FOL141	230	351
FOL141	231	352
FOL141	232	353
FOL141	232	354
FOL141	233	356
FOL141	235	360
FOL141	236	361
FOL141	237	362
FOL141	238	363
FOL141	239	364
FOL141	241	366
FOL141	244	369
FOL141	245	370
FOL141	246	371
FOL141	247	372
FOL141	248	373
FOL141	249	374
FOL141	250	377
FOL141	251	378
FOL141	252	379
FOL141	253	380
FOL141	254	383
FOL141	255	384
FOL141	256	386
FOL141	257	392
FOL141	258	395
FOL141	259	397
FOL141	259	398
FOL141	358	543
FOL141	360	547
FOL141	360	548
FOL141	361	550
FOL141	368	561
FOL141	390	589
FOL141	415	639
FOL141	417	642
FOL141	418	644
FOL141	418	645
FOL141	430	673
FOL141	431	675
FOL141	431	676
FOL141	431	677
FOL143	1	1
FOL143	27	44
FOL143	38	64
FOL143	38	65



 9		
FOL143	44	71
FOL143	46	74
FOL143	46	75
FOL143	73	113
FOL143	73	114
FOL143	75	116
FOL143	134	214
FOL143	135	215
FOL143	136	216
FOL143	141	221
FOL143	143	224
FOL143	145	227
FOL143	146	228
FOL143	148	230
FOL143	157	240
FOL143	186	292
FOL143	187	293
FOL143	192	299
FOL143	193	300
FOL143	194	301
FOL143	195	303
FOL143	196	304
FOL143	198	306
FOL143	199	308
FOL143	200	309
FOL143	219	338
FOL143	220	339
FOL143	221	341
FOL143	222	342
FOL143	288	434
FOL143	332	503
FOL143	333	504
FOL143	333	505
FOL143	335	509
FOL143	336	510
FOL143	377	573
FOL143	380	578
FOL143	382	580
FOL143	383	581
FOL143	384	583
FOL143	385	584
FOL143	387	586
FOL143	388	587
FOL143	389	588
FOL143	391	590
FOL143	392	592
FOL143	392	593
FOL143	394	596
FOL143	394	597
FOL143	396	600
FOL143	397	601
FOL143	398	602
FOL143	399	603
FOL143	399	604
FOL143	401	608
FOL143	408	627
FOL143	413	636
FOL143	414	637



NUMERICAL PARTS LIST

Numerische Teilenummernliste • Elenco riferimenti
Liste des références produits

		
FOL143	414	638
FOL143	415	640
FOL143	416	641
FOL154	197	305
FOL154	201	310
FOL154	202	311
FOL154	204	313
FOL154	354	534
FOL154	355	535
FOL154	359	545
FOL154	365	557
FOL154	366	558
FOL154	367	559
FOL154	368	560
FOL154	393	595
FOL154	395	598
FOL154	428	665
FOL154	430	672
FOL158	95	150
FOL158	96	151
FOL158	97	152
FOL158	98	153
FOL158	99	154
FOL158	100	155
FOL159	95	150
FOL159	96	151
FOL159	98	153
FOL159	100	155
FOL166	39	66
FOL167	3	3
FOL167	33	56
FOL167	34	57
FOL167	35	58
FOL167	36	60
FOL167	37	62
FOL167	40	67
FOL167	41	68
FOL167	42	69
FOL167	43	70
FOL167	45	73
FOL167	47	76
FOL167	48	77
FOL167	49	78
FOL167	50	79
FOL167	51	80
FOL167	52	82
FOL167	54	86
FOL167	57	91
FOL167	71	111
FOL167	74	115
FOL167	76	117
FOL167	77	118
FOL167	78	119
FOL167	79	120
FOL167	81	123
FOL167	82	124
FOL170	426	662
FOL170	436	693

		
FOL170	436	696
FOL170	437	698
FOL170	437	699
FOL170	438	700
FOL170	438	702
FOL170	439	704
FOL175	139	219
FOL175	142	223
FOL175	144	226
FOL175	149	231
FOL175	150	232
FOL175	151	233
FOL175	152	234
FOL175	154	237
FOL175	155	238
FOL175	156	239
FOL175	158	243
FOL175	160	247
FOL175	162	250
FOL175	163	252
FOL175	163	253
FOL175	165	256
FOL175	165	257
FOL175	166	258
FOL175	167	259
FOL175	168	260
FOL175	169	261
FOL175	295	443
FOL175	297	445
FOL175	299	448
FOL175	300	449
FOL175	301	452
FOL175	302	454
FOL175	334	507
FOL175	347	522
FOL175	351	528
FOL175	352	530
FOL179	34	57
FOL179	35	58
FOL179	36	60
FOL179	37	62
FOL179	40	67
FOL179	47	76
FOL179	48	77
FOL179	50	79
FOL179	51	80
FOL179	52	82
FOL179	54	86
FOL179	57	91
FOL179	71	111
FOL179	74	115
FOL179	76	117
FOL179	77	118
FOL179	78	119
FOL179	79	120
FOL179	82	124
FV480	94	148
FV500	94	147

		
FV500	95	149
FV500	421	652
FV500	421	653
FV500	426	661
FV500	432	680
FX622	438	702
GM690	436	693
GM690	436	694
GM690	436	695
GM690	436	696
GM690	437	697
GM690	437	698
GM690	437	699
GM690	438	700
H024/5	444	710
H024/5	444	710
H024/5	445	711
H024/5	445	711
H024/5	448	715
H024/5	448	715
H024/5	449	717
H024/5	449	717
H024/5	450	718
H024/5	450	718
H024/5	451	719
H024/5	451	719
H024/5	453	721
H024/5	453	721
H024/5	454	722
H024/5	454	722
H024/5	455	723
H024/5	455	723
H024/5	482	763
H024/5	482	763
H025/5	452	720
H025/5	456	724
H025/5	457	725
H025/5	477	755
H025/5	477	756
H025/5	478	757
H025/5	481	762
H025/5	483	764
H025/5	484	765
H025/5	506	795
H025/5	507	796
H025/5	508	798
H025/5	509	799
H025/5	510	800
H025/5	594	880
H025/5	596	881
H025/5	598	882
H025/5	600	883
H025/5	601	884
H025/5	603	885
H025/5	606	888
H025/5	608	889
H025/5	609	890
H025/5	626	918

		
H025/5	629	921
H025/5	631	924
H025/5	631	925
H025/5	633	926
H025/5	635	927
H025/5	637	928
H025/5	638	929
H025/5	640	930
H025/5	642	931
H025/5	643	932
H026/5	445	711
H026/5	446	712
H026/5	447	713
H026/5	447	714
H026/5	449	716
H026/5	449	717
H026/5	450	718
H026/5	451	719
H026/5	453	721
H026/5	455	723
H026/5	458	726
H026/5	460	731
H026/5	460	732
H026/5	466	738
H026/5	469	742
H026/5	487	769
H026/5	488	770
H026/5	488	771
H027/5	456	724
H027/5	514	805
H027/5	525	815
H027/5	533	819
H027/5	539	824
H027/5	583	866
H027/5	585	867
H027/5	586	868
H027/5	586	869
H027/5	588	871
H027/5	588	872
H027/5	594	880
H027/5	596	881
H027/5	598	882
H027/5	600	883
H027/5	601	884
H027/5	603	885
H027/5	605	886
H027/5	606	887
H027/5	606	888
H027/5	608	889
H027/5	610	892
H027/5	611	894
H027/5	612	895
H027/5	613	896
H027/5	614	897
H027/5	614	898
H027/5	615	899
H027/5	616	900
H027/5	617	901

		9
H027/5	619	904
H027/5	622	909
H027/5	623	912
H027/5	626	918
H027/5	629	921
H027/5	631	925
H027/5	633	926
H027/5	635	927
H027/5	637	928
H027/5	638	929
H027/5	640	930
H027/5	642	931
H027/5	643	932
H027/5	644	933
H027/5	646	935
H027/5	647	936
H027/5	648	937
H027/5	649	938
H027/5	650	939
H027/5	651	941
H027/5	652	942
H027/5	653	943
H027/5	654	944
H027/5	655	945
H027/5	655	946
H027/5	657	947
H027/5	699	1006
H027/5	700	1007
H027/5	701	1008
H027/5	702	1009
H027/5	702	1010
H027/5	703	1011
H027/5	704	1012
H027/5	704	1013
H027/5	705	1014
H027/5	706	1016
H027/5	714	1029
H034/4	501	787
H034/4	501	787
H034/4	502	788
H034/4	502	788
H034/4	503	789
H034/4	503	789
H034/4	717	1033
H034/4	717	1033
H034/4	718	1034
H034/4	718	1034
H034/4	719	1036
H034/4	719	1036
H034/4	726	1048
H034/4	726	1048
H035/7	695	997
H035/7	696	998
H035/7	696	999
H035/7	697	1000
H035/7	699	1005
H035/7	724	1044
H035/7	725	1045

		9
H066/4	695	996
H079/5	504	791
H079/5	511	801
H079/5	538	823
H079/5	542	826
H079/5	549	831
H079/5	551	832
H079/5	556	837
H079/5	557	839
H079/5	559	840
H079/5	560	841
H079/5	561	842
H079/5	562	843
H079/5	564	845
H079/5	565	846
H079/5	658	948
H079/5	659	949
H079/5	660	950
H079/5	661	952
H079/5	662	953
H079/5	662	954
H079/5	664	955
H079/5	664	956
H079/5	665	957
H079/5	666	958
H079/5	667	959
H079/5	668	960
H079/5	669	961
H079/5	670	962
H079/5	671	963
H079/5	674	966
H084/5	461	733
H084/5	479	758
H084/5	480	759
H084/5	480	760
H084/5	481	761
H084/5	484	765
H084/5	485	766
H084/5	486	767
H084/5	488	771
H084/5	512	802
H084/5	512	803
H084/5	513	804
H084/5	514	805
H084/5	515	806
H084/5	516	807
H084/5	518	808
H084/5	519	809
H084/5	519	810
H084/5	520	811
H084/5	522	812
H084/5	522	813
H084/5	524	814
H084/5	525	815
H084/5	527	816
H084/5	529	817
H084/5	531	818
H084/5	533	819

		9
H084/5	535	820
H084/5	535	821
H084/5	537	822
H084/5	539	824
H084/5	541	825
H084/5	544	827
H084/5	545	828
H084/5	546	829
H084/5	548	830
H084/5	553	834
H084/5	554	835
H084/5	554	836
H084/5	566	848
H084/5	568	849
H084/5	569	851
H084/5	583	866
H084/5	587	870
H084/5	588	872
H084/5	593	877
H084/5	593	878
H084/5	615	899
H084/5	616	900
H084/5	617	901
H084/5	617	902
H084/5	618	903
H084/5	621	908
H084/5	623	911
H084/5	624	913
H084/5	625	914
H084/5	626	918
H084/5	629	921
H084/5	630	922
H084/5	630	923
H084/5	644	933
H084/5	649	938
H084/5	651	941
H084/5	653	943
H084/5	655	946
H084/5	706	1016
H084/5	707	1017
H084/5	708	1018
H084/5	709	1020
H084/5	710	1021
H084/5	712	1024
H084/5	713	1026
H084/5	714	1028
H941/6	492	778
H941/6	493	779
H941/6	576	857
H941/6	576	858
H941/6	577	859
H941/6	579	860
H941/6	580	861
H941/6	581	862
H941/6	678	971
H941/7	494	780
H941/7	494	780
H941/7	498	784

		9
H941/7	498	784
H981/6	492	778
H981/6	493	779
H981/6	503	790
H981/6	571	852
H981/6	572	853
H981/6	573	854
H981/6	574	855
H981/6	575	856
H981/6	576	858
H981/6	577	859
H981/6	579	860
H981/6	581	862
H981/6	582	863
H981/6	582	864
H981/6	583	865
H981/6	675	967
H981/6	675	968
H981/6	676	969
H981/6	677	970
H981/6	678	971
H981/6	679	972
H981/6	680	973
H981/6	681	974
H981/6	682	975
H981/6	683	977
H981/6	684	978
H981/6	684	979
H981/6	685	980
H981/6	686	981
H981/6	688	985
H981/6	689	986
H981/6	690	987
H981/6	690	988
H981/6	692	990
H981/6	692	991
H981/6	715	1030
H981/6	715	1031
H981/6	716	1032
H981/7	494	780
H981/7	494	780
H981/7	495	781
H981/7	495	781
H981/7	496	782
H981/7	496	782
H981/7	497	783
H981/7	497	783
H981/7	498	784
H981/7	498	784
H1025/4	499	785
H1025/4	499	786
H1025/4	719	1037
H1025/4	723	1043
H1025/4	728	1054
H1025/4	729	1055
H1294/6	687	983
H1294/6	688	984
H1294/6	691	989

NUMERICAL PARTS LIST

Nummerische Teilenummernliste • Elenco riferimenti
Liste des références produits

 9		
H1300/4	725	1047
H1325/5	442	705
H1325/5	443	707
H1325/5	443	708
H1325/5	444	709
H1325/5	461	733
H1325/5	463	734
H1325/5	464	735
H1325/5	465	736
H1325/5	466	737
H1325/5	466	738
H1325/5	469	743
H1325/5	470	745
H1325/5	471	746
H1325/5	472	748
H1325/5	479	758
H1325/5	487	768
H1325/5	488	771
H1325/5	489	772
H1325/5	490	773
H1325/5	491	774
H1325/5	491	775
H1328/5	511	801
H1328/5	667	959
H1328/5	669	961
H1328/5	671	963
H1328/5	674	966
HBS018	25	40
HBS018	28	45
HBS018	61	101
HBS018	62	102
HBS018	63	103
HBS018	64	104
HBS018	65	105
HBS018	66	106
HBS018	67	107
HBS018	68	108
HBS018	69	109
HBS018	70	110
HBS018	83	126
HBS018	121	194
HBS018	122	197
HBS018	123	198
HBS018	123	199
HBS018	124	200
HBS018	124	201
HBS018	125	202
HBS018	126	203
HBS018	127	204
HBS018	128	205
HBS018	129	209
HBS018	130	210
HBS018	131	211
HBS018	132	212
HBS018	133	213
HBS018	134	214
HBS018	135	215
HBS018	136	216

 9		
HBS018	137	217
HBS018	138	218
HBS018	140	220
HBS018	141	221
HBS018	143	224
HBS018	145	227
HBS018	146	228
HBS018	147	229
HBS018	148	230
HBS018	153	235
HBS018	157	240
HBS018	159	244
HBS018	288	434
HBS018	434	686
HBS021	84	132
HBS021	85	133
HBS021	85	134
HBS021	182	285
HBS021	183	286
HBS021	184	287
HBS021	185	288
HBS021	315	482
HBS021	332	503
HBS021	333	504
HBS021	333	505
HBS021	334	506
HBS021	335	508
HBS021	335	509
HBS021	336	511
HBS021	337	512
HBS021	338	513
HBS021	339	514
HBS021	340	515
HBS021	341	516
HBS021	342	517
HBS021	343	518
HBS021	344	519
HBS021	345	520
HBS021	346	521
HBS021	348	523
HBS021	349	525
HBS021	350	526
HBS021	350	527
HBS021	353	531
HBS021	353	532
HBS022	86	135
HBS022	86	136
HBS022	88	140
HBS022	89	141
HBS022	90	142
HBS022	91	143
HBS022	92	144
HBS022	93	145
HBS022	94	146
HBS024	170	265
HBS024	171	268
HBS024	173	271
HBS024	175	273

 9		
HBS024	176	275
HBS024	177	277
HBS024	178	278
HBS024	179	279
HBS024	179	280
HBS024	180	281
HBS024	180	282
HBS024	181	283
HBS024	312	477
HBS024	313	479
HBS024	314	480
HBS024	315	482
HBS024	316	483
HBS024	317	484
HBS024	318	485
HBS024	319	486
HBS024	320	487
HBS024	322	492
HBS024	323	493
HBS024	324	494
HBS024	325	495
HBS024	326	496
HBS024	327	497
HBS024	328	498
HBS024	329	499
HBS024	330	500
HBS024	331	501
HBS024	410	632
HBS024	411	633
HBS024	412	634
HBS028	222	342
HBS028	275	417
HBS028	378	575
HBS028	379	576
HBS028	381	579
HBS028	384	582
HBS029	6	10
HBS029	7	11
HBS029	12	20
HBS029	13	21
HBS029	20	32
HBS029	25	41
HBS029	26	42
HBS029	59	98
HBS029	106	165
HBS029	111	174
HBS029	111	175
HBS043	5	7
HBS043	5	8
HBS043	6	9
HBS043	6	10
HBS043	7	11
HBS043	7	12
HBS043	8	13
HBS043	9	16
HBS043	10	17
HBS043	11	18
HBS043	12	19

 9		
HBS043	13	22
HBS043	14	23
HBS043	15	24
HBS043	16	25
HBS043	17	27
HBS043	18	28
HBS043	18	29
HBS043	19	30
HBS043	19	31
HBS043	20	32
HBS043	20	33
HBS043	21	34
HBS043	21	35
HBS043	22	36
HBS043	22	37
HBS043	23	38
HBS043	24	39
HBS043	26	43
HBS043	27	44
HBS043	59	96
HBS043	107	166
HBS043	108	168
HBS043	109	170
HBS043	109	171
HBS043	110	172
HBS043	110	173
HBS043	111	175
HBS043	113	178
HBS043	114	181
HBS043	115	183
HBS043	116	184
HBS043	116	185
HBS043	117	186
HBS043	117	187
HBS043	118	188
HBS043	119	189
HBS043	119	190
HBS043	121	195
HBS043	186	292
HBS043	187	293
HBS043	188	294
HBS043	189	295
HBS043	190	296
HBS043	191	297
HBS043	192	299
HBS043	194	301
HBS043	206	319
HBS043	207	321
HBS043	208	322
HBS043	208	323
HBS043	209	324
HBS043	209	325
HBS043	210	326
HBS043	211	328
HBS043	212	329
HBS043	213	330
HBS043	214	331
HBS043	214	332

 9		
HBS043	215	334
HBS043	216	335
HBS043	217	336
HBS043	218	337
HBS043	219	338
HBS043	220	339
HBS043	221	340
HBS043	221	341
HBS043	223	344
HBS043	234	358
HBS043	260	400
HBS043	261	401
HBS043	262	402
HBS043	263	404
HBS043	264	405
HBS043	265	406
HBS043	266	407
HBS043	267	408
HBS043	267	409
HBS043	268	410
HBS043	269	411
HBS043	270	412
HBS043	271	413
HBS043	272	414
HBS043	273	415
HBS043	274	416
HBS043	276	419
HBS043	277	420
HBS043	278	421
HBS043	279	422
HBS043	280	423
HBS043	281	424
HBS043	281	425
HBS043	282	426
HBS043	283	427
HBS043	284	429
HBS043	285	430
HBS043	286	432
HBS043	376	572
HBS043	377	573
HBS043	378	574
HBS043	379	577
HBS043	380	578
HBS043	382	580
HBS043	383	581
HBS043	384	583
HBS043	385	584
HBS043	387	586
HBS043	388	587
HBS043	389	588
HBS043	409	630
HBS064	355	536
HBS064	413	636
HBS064	414	637
HBS064	414	638
HBS064	415	640
HBS064	416	641
HBS068	251	378

 9		
HBS075	38	64
HBS075	38	65
HBS075	44	71
HBS075	46	74
HBS075	46	75
HBS075	60	100
HBS075	72	112
HBS075	73	113
HBS075	73	114
HBS075	75	116
HBS075	215	333
HBS077	363	553
HBS077	364	554
HBS077	365	556
HBS077	372	568
HBS150	435	691
HBS171	222	343
HBS171	224	345
HBS171	225	346
HBS171	227	348
HBS171	229	350
HBS171	233	356
HBS171	237	362
HBS171	242	367
HBS173	28	46
HBS173	29	47
HBS173	29	48
HBS173	29	49
HBS246	65	105
HBS246	193	300
HBS246	195	303
HBS246	196	304
HBS246	197	305
HBS246	198	306
HBS246	199	308
HBS246	200	309
HBS246	201	310
HBS246	202	311
HBS246	203	312
HBS246	204	313
HBS246	204	314
HBS246	205	316
HBS246	205	317
HBS246	206	318
HBS246	386	585
HBS246	391	590
HBS246	392	592
HBS246	394	597
HBS246	396	600
HBS246	397	601
HBS246	398	602
HBS246	399	603
HBS246	399	604
HBS246	400	605
HBS246	400	606
HBS246	401	608
HBS249	1	1
HBS249	4	4

 9		
HBS249	40	67
HBS249	43	70
HBS249	47	76
HBS249	48	77
HBS249	50	79
HBS249	51	80
HBS249	52	82
HBS249	52	83
HBS249	53	85
HBS249	54	86
HBS249	56	90
HBS249	57	91
HBS249	81	123
HBS249	82	124
HBS264	102	159
HBS264	103	160
HBS264	104	161
HBS264	105	162
HBS264	105	163
HBS264	106	164
HBS265	95	150
HBS265	96	151
HBS265	97	152
HBS265	100	155
HBS265	100	156
HBS268	222	343
HBS268	224	345
HBS268	225	346
HBS268	226	347
HBS268	227	348
HBS268	228	349
HBS268	229	350
HBS268	230	351
HBS268	231	352
HBS268	232	353
HBS268	232	354
HBS268	233	355
HBS268	233	356
HBS268	235	359
HBS268	235	360
HBS268	236	361
HBS268	237	362
HBS268	238	363
HBS268	239	364
HBS268	241	366
HBS268	242	367
HBS268	243	368
HBS268	244	369
HBS268	245	370
HBS268	246	371
HBS268	247	372
HBS268	248	373
HBS268	249	374
HBS268	249	375
HBS268	250	376
HBS268	250	377
HBS268	251	378
HBS268	252	379

 9		
HBS268	253	380
HBS268	254	382
HBS268	254	383
HBS268	255	384
HBS268	256	386
HBS268	256	387
HBS268	257	392
HBS268	258	394
HBS268	258	395
HBS268	259	397
HBS268	259	398
HBS269	314	481
HBS269	320	488
HBS269	321	489
HBS269	321	490
HBS269	322	491
HBS269	331	502
HBS269	410	631
HBS270	356	538
HBS270	356	539
HBS270	357	540
HBS270	357	541
HBS270	358	542
HBS270	358	543
HBS270	359	545
HBS270	360	547
HBS270	360	548
HBS270	361	549
HBS270	361	550
HBS270	362	551
HBS270	362	552
HBS270	415	639
HBS270	417	642
HBS270	418	644
HBS270	418	645
HBS270	419	646
HBS270	419	647
HBS300	139	219
HBS300	142	223
HBS300	144	226
HBS300	149	231
HBS300	150	232
HBS300	151	233
HBS300	152	234
HBS300	154	237
HBS300	155	238
HBS300	156	239
HBS300	158	243
HBS300	160	247
HBS300	161	249
HBS300	162	250
HBS300	163	252
HBS300	163	253
HBS300	164	254
HBS300	165	256
HBS300	165	257
HBS300	166	258
HBS300	167	259

NUMERICAL PARTS LIST

Nummerische Teilenummernliste • Elenco riferimenti
Liste des références produits

		9
HBS300	168	260
HBS300	169	261
HBS300	290	436
HBS300	290	437
HBS300	291	439
HBS300	295	443
HBS300	297	445
HBS300	299	448
HBS300	300	449
HBS300	301	452
HBS300	302	454
HBS300	304	459
HBS311	32	54
HBS311	33	55
HBS316	71	111
HBS316	74	115
HBS316	76	117
HBS316	77	118
HBS316	78	119
HBS316	79	120
HBS316	80	122
HBS360	39	66
HBS361	98	153
HBS361	99	154
HBS361	371	567
HBS361	422	654
HBS361	424	656
HBS361	425	658
HBS362	3	3
HBS362	41	68
HBS362	42	69
HBS362	45	73
HBS362	49	78
HBS363	393	595
HBS363	395	598
HBS363	395	599
HBS363	404	614
HBS363	405	615
HBS364	289	435
HBS364	292	440
HBS364	293	441
HBS364	294	442
HBS364	296	444
HBS364	298	446
HBS364	299	447
HBS364	300	450
HBS364	301	451
HBS364	308	465
HBS364	309	467
HBS364	310	472
HBS461	354	533
HBS470	101	157
HBS471	34	57
HBS471	36	60
HBS471	36	61
HBS471	37	62
HBS476	287	433
HBS476	373	569

		9
HBS476	374	570
HBS476	375	571
HBS476	395	599
HBS476	403	612
HBS476	403	613
HBS476	405	617
HBS476	406	619
HBS476	406	620
HBS476	407	622
HBS476	408	626
HBS476	409	628
HBS479	33	56
HBS479	35	58
HBS479	35	59
HBS479	37	63
HBS509	334	507
HBS509	347	522
HBS509	351	528
HBS509	352	530
HBS510	390	589
HBS512	359	546
HBS512	430	672
HBS513	354	534
HBS513	355	535
HBS514	368	561
HBS514	430	673
HBS514	431	675
HBS514	431	676
HBS514	431	677
HBS514	432	678
HBS517	412	635
HBS517	425	660
HBS518	30	50
HBS518	53	84
HBS518	55	87
HBS518	55	88
HBS518	56	89
HBS518	57	92
HBS526	359	544
HBS526	364	555
HBS526	365	557
HBS526	366	558
HBS526	367	559
HBS526	368	560
HL456	26	42
HL456	26	43
HL456	58	93
HL456	58	95
HL456	59	96
HL456	59	97
HL456	59	98
HL456	60	99
HL456	87	137
HL456	87	138
HL456	106	165
HL456	107	166
HL456	107	167
HL456	108	168

		9
HL456	109	170
HL456	109	171
HL456	110	172
HL456	110	173
HL456	111	174
HL456	111	175
HL456	112	176
HL456	112	177
HL456	113	178
HL456	113	179
HL456	114	180
HL456	114	181
HL456	114	182
HL456	115	183
HL456	116	184
HL456	116	185
HL456	117	186
HL456	117	187
HL456	118	188
HL456	119	189
HL456	119	190
HL456	120	191
HL456	120	192
HL456	120	193
HL456	121	195
HL456	170	267
HL457	16	26
HL457	25	41
HL457	60	99
HL457	61	101
HL457	62	102
HL457	63	103
HL457	64	104
HL457	65	105
HL457	66	106
HL457	67	107
HL457	68	108
HL457	69	109
HL457	70	110
HL457	83	126
HL457	83	127
HL457	83	128
HL457	83	129
HL457	84	130
HL457	84	131
HL457	87	137
HL457	87	138
HL457	106	165
HL457	107	166
HL457	107	167
HL457	108	168
HL457	109	170
HL457	109	171
HL457	110	172
HL457	110	173
HL457	111	174
HL457	111	175
HL457	112	176

		9
HL457	113	178
HL457	113	179
HL457	114	181
HL457	114	182
HL457	115	183
HL457	116	184
HL457	116	185
HL457	117	186
HL457	117	187
HL457	118	188
HL457	119	189
HL457	119	190
HL457	120	191
HL457	120	192
HL457	120	193
HL457	121	194
HL457	121	195
HL457	170	267
HL457	185	289
HL457	186	291
HL457	187	293
HL457	188	294
HL457	189	295
HL457	190	296
HL457	191	297
HL457	191	298
HL457	206	319
HL457	207	320
HL457	207	321
HL457	208	322
HL457	208	323
HL457	209	324
HL457	209	325
HL457	210	326
HL457	210	327
HL457	211	328
HL457	212	329
HL457	213	330
HL457	214	331
HL457	214	332
HL457	216	335
HL457	217	336
HL457	218	337
HL457	219	338
HL457	220	339
HL457	223	344
HL457	260	400
HL457	261	401
HL457	262	402
HL457	262	403
HL457	263	404
HL457	264	405
HL457	265	406
HL457	266	407
HL457	267	408
HL457	267	409
HL457	268	410
HL457	269	411

 9		
HL457	270	412
HL457	271	413
HL457	272	414
HL457	273	415
HL457	274	416
HL457	276	418
HL457	276	419
HL457	277	420
HL457	278	421
HL457	279	422
HL457	280	423
HL457	281	425
HL457	282	426
HL457	283	427
HL457	283	428
HL457	284	429
HL457	285	430
HL457	285	431
HL457	286	432
HL457	288	434
HL457	376	572
HL457	378	574
HL457	379	577
HL457	380	578
HL457	382	580
HL460	170	265
HL460	171	268
HL460	172	269
HL460	172	270
HL460	173	271
HL460	174	272
HL460	175	273
HL460	175	274
HL460	176	275
HL460	176	276
HL460	177	277
HL460	178	278
HL460	179	279
HL460	179	280
HL460	180	282
HL460	181	283
HL460	181	284
HL460	312	477
HL460	312	478
HL460	313	479
HL460	314	480
HL460	315	482
HL460	316	483
HL460	317	484
HL460	318	485
HL460	319	486
HL460	320	487
HL460	322	492
HL460	323	493
HL460	324	494
HL460	325	495
HL460	326	496
HL460	327	497

 9		
HL460	328	498
HL460	329	499
HL460	330	500
HL460	331	501
HL460	411	633
HL460	412	634
HL461	434	686
HL461	434	687
HL461	434	688
HL462	84	132
HL463	84	132
HL463	85	133
HL463	85	134
HL469	90	142
HL606	222	342
HL606	275	417
HL606	378	575
HL606	379	576
HL606	381	579
HL606	384	582
HL728	88	140
HL728	89	141
HL728	90	142
HL728	91	143
HL728	92	144
HL728	93	145
HL728	94	146
HL730	314	481
HL730	320	488
HL730	321	489
HL730	321	490
HL730	322	491
HL730	331	502
HL730	410	631
HL731	381	579
HL731	384	582
HL732	222	343
HL732	224	345
HL732	225	346
HL732	226	347
HL732	227	348
HL732	228	349
HL732	229	350
HL732	230	351
HL732	231	352
HL732	232	353
HL732	232	354
HL732	233	355
HL732	233	356
HL732	235	359
HL732	235	360
HL732	236	361
HL732	237	362
HL732	238	363
HL732	239	364
HL732	240	365
HL732	241	366
HL732	242	367

 9		
HL732	243	368
HL732	244	369
HL732	245	370
HL732	246	371
HL732	247	372
HL732	248	373
HL732	249	374
HL732	249	375
HL732	250	376
HL732	250	377
HL732	251	378
HL732	252	379
HL732	253	380
HL732	254	382
HL732	254	383
HL732	255	384
HL732	256	386
HL732	256	387
HL732	257	392
HL732	258	394
HL732	258	395
HL732	259	397
HL5002	33	56
HL5002	35	58
HL5002	35	59
HL5002	37	63
HM5053	16	26
HM5053	25	41
HM5053	60	99
HM5053	61	101
HM5053	62	102
HM5053	63	103
HM5053	64	104
HM5053	65	105
HM5053	66	106
HM5053	67	107
HM5053	68	108
HM5053	69	109
HM5053	70	110
HM5053	83	126
HM5053	87	137
HM5053	107	166
HM5053	110	172
HM5053	110	173
HM5053	111	174
HM5053	113	178
HM5053	114	181
HM5053	114	182
HM5053	115	183
HM5053	116	184
HM5053	116	185
HM5053	117	186
HM5053	117	187
HM5053	118	188
HM5053	119	189
HM5053	119	190
HM5053	120	192
HM5053	120	193

 9		
HM5053	121	194
HM5053	121	195
HM5053	187	293
HM5053	188	294
HM5053	190	296
HM5053	206	319
HM5053	207	320
HM5053	207	321
HM5053	208	322
HM5053	208	323
HM5053	209	324
HM5053	209	325
HM5053	210	326
HM5053	210	327
HM5053	211	328
HM5053	212	329
HM5053	213	330
HM5053	214	331
HM5053	214	332
HM5053	216	335
HM5053	217	336
HM5053	218	337
HM5053	219	338
HM5053	220	339
HM5053	223	344
HM5053	260	400
HM5053	261	401
HM5053	262	402
HM5053	262	403
HM5053	263	404
HM5053	264	405
HM5053	265	406
HM5053	266	407
HM5053	267	408
HM5053	267	409
HM5053	268	410
HM5053	269	411
HM5053	270	412
HM5053	271	413
HM5053	272	414
HM5053	273	415
HM5053	274	416
HM5053	276	418
HM5053	276	419
HM5053	277	420
HM5053	278	421
HM5053	279	422
HM5053	280	423
HM5053	281	425
HM5053	282	426
HM5053	283	427
HM5053	284	429
HM5053	285	430
HM5053	285	431
HM5053	286	432
HM5053	288	434
HM5053	376	572
HM5053	378	574

NUMERICAL PARTS LIST

Nummerische Teilenummernliste • Elenco riferimenti
Liste des références produits

		9
HM5053	379	577
HM5053	380	578
HM5053	382	580
HM5053	383	581
HM5058	124	201
HM5058	125	202
HM5058	127	204
HM5058	128	205
HM5058	129	209
HM5058	159	244
HM5062	1	1
HM5062	12	19
HM5062	27	44
HM5062	38	64
HM5062	38	65
HM5062	42	69
HM5062	44	71
HM5062	45	73
HM5062	46	74
HM5062	46	75
HM5062	60	100
HM5062	72	112
HM5062	73	113
HM5062	73	114
HM5062	75	116
HM5062	187	293
HM5062	215	333
HM5223	95	150
HM5223	96	151
HM5223	97	152
HM5223	98	153
HM5223	99	154
HM5223	100	155
HM5223	100	156
HM5224	356	538
HM5224	356	539
HM5224	357	540
HM5224	357	541
HM5224	358	542
HM5224	358	543
HM5224	359	545
HM5224	359	546
HM5224	360	547
HM5224	360	548
HM5224	361	549
HM5224	361	550
HM5224	362	551
HM5224	362	552
HM5224	415	639
HM5224	417	642
HM5224	418	644
HM5224	419	646
HM5224	419	647
HM5227	317	484
HM5277	170	265
HM5277	171	268
HM5277	172	269
HM5277	172	270

		9
HM5277	173	271
HM5277	174	272
HM5277	175	273
HM5277	175	274
HM5277	176	275
HM5277	176	276
HM5277	177	277
HM5277	178	278
HM5277	179	279
HM5277	179	280
HM5277	180	282
HM5277	181	283
HM5277	181	284
HM5277	312	477
HM5277	312	478
HM5277	313	479
HM5277	314	480
HM5277	315	482
HM5277	316	483
HM5277	318	485
HM5277	319	486
HM5277	320	487
HM5277	322	492
HM5277	323	493
HM5277	324	494
HM5277	325	495
HM5277	326	496
HM5277	327	497
HM5277	328	498
HM5277	329	499
HM5277	330	500
HM5277	331	501
HM5277	411	633
HM5277	412	634
HM5367	122	196
HM5367	122	197
HM5367	123	198
HM5367	123	199
HM5367	124	200
HM5367	126	203
HM5367	130	210
HM5367	131	211
HM5367	132	212
HM5367	133	213
HM5367	137	217
HM5367	138	218
HM5367	140	220
HM5367	147	229
HM5367	153	235
HR280	34	57
HR280	36	60
HR280	36	61
HR280	37	62
HR363	219	338
HR363	376	572
HR363	409	630
HR397	3	3
HR397	8	14

		9
HR397	30	50
HR397	33	56
HR397	34	57
HR397	35	58
HR397	35	59
HR397	36	60
HR397	36	61
HR397	37	62
HR397	37	63
HR397	39	66
HR397	40	67
HR397	41	68
HR397	44	72
HR397	45	73
HR397	46	74
HR397	47	76
HR397	49	78
HR397	50	79
HR397	51	80
HR397	51	81
HR397	52	83
HR397	53	84
HR397	53	85
HR397	54	86
HR397	55	87
HR397	56	89
HR397	56	90
HR397	57	91
HR397	57	92
HR397	71	111
HR397	74	115
HR397	76	117
HR397	77	118
HR397	78	119
HR397	79	120
HR397	79	121
HR397	80	122
HR397	81	123
HR397	82	124
HR397	82	125
HR397	134	214
HR397	168	260
HR397	169	261
HR397	232	354
HR397	287	433
HR397	307	463
HR397	310	472
HR397	310	473
HR397	347	522
HR397	354	533
HR397	354	534
HR397	366	558
HR397	375	571
HR397	399	603
HR569	5	7
HR569	5	8
HR569	6	9
HR569	6	10

		9
HR569	7	11
HR569	7	12
HR569	8	13
HR569	9	16
HR569	10	17
HR569	11	18
HR569	12	20
HR569	13	21
HR569	13	22
HR569	14	23
HR569	15	24
HR569	16	25
HR569	16	26
HR569	17	27
HR569	18	28
HR569	18	29
HR569	19	30
HR569	19	31
HR569	20	32
HR569	20	33
HR569	21	34
HR569	21	35
HR569	22	36
HR569	22	37
HR569	23	38
HR569	25	40
HR569	25	41
HR569	26	42
HR569	26	43
HR569	27	44
HR569	28	45
HR569	28	46
HR569	29	47
HR569	29	48
HR569	60	99
HR569	61	101
HR569	62	102
HR569	63	103
HR569	64	104
HR569	65	105
HR569	66	106
HR569	67	107
HR569	68	108
HR569	69	109
HR569	70	110
HR569	83	126
HR569	87	137
HR569	106	165
HR569	107	166
HR569	108	168
HR569	109	170
HR569	109	171
HR569	110	172
HR569	110	173
HR569	111	174
HR569	111	175
HR569	113	178
HR569	114	181

		9
HR569	114	182
HR569	115	183
HR569	116	184
HR569	116	185
HR569	117	186
HR569	117	187
HR569	118	188
HR569	119	189
HR569	119	190
HR569	120	192
HR569	120	193
HR569	121	194
HR569	121	195
HR569	124	201
HR569	125	202
HR569	126	203
HR569	127	204
HR569	128	205
HR569	129	209
HR569	131	211
HR569	132	212
HR569	138	218
HR569	187	293
HR569	188	294
HR569	189	295
HR569	190	296
HR569	191	297
HR569	194	301
HR569	206	319
HR569	207	320
HR569	207	321
HR569	208	322
HR569	208	323
HR569	209	324
HR569	209	325
HR569	210	326
HR569	210	327
HR569	211	328
HR569	212	329
HR569	213	330
HR569	214	331
HR569	214	332
HR569	215	334
HR569	216	335
HR569	217	336
HR569	218	337
HR569	220	339
HR569	223	344
HR569	260	400
HR569	261	401
HR569	262	402
HR569	262	403
HR569	263	404
HR569	264	405
HR569	265	406
HR569	266	407
HR569	267	408
HR569	267	409

		9
HR569	268	410
HR569	269	411
HR569	270	412
HR569	271	413
HR569	272	414
HR569	273	415
HR569	274	416
HR569	276	418
HR569	276	419
HR569	277	420
HR569	278	421
HR569	279	422
HR569	280	423
HR569	281	424
HR569	281	425
HR569	282	426
HR569	283	427
HR569	283	428
HR569	284	429
HR569	285	430
HR569	285	431
HR569	286	432
HR569	288	434
HR569	376	572
HR569	377	573
HR569	378	574
HR569	379	577
HR569	380	578
HR569	382	580
HR569	383	581
HR569	385	584
HR569	387	586
HR569	389	588
HR569	414	637
HR596	343	518
HR596	344	519
HR596	346	521
HR596	349	525
HR599	30	51
HR599	31	52
HR599	31	53
HR599	46	74
HR599	101	158
HR599	221	341
HR599	275	417
HR599	290	436
HR599	290	437
HR599	291	439
HR599	295	443
HR599	297	445
HR599	299	448
HR599	300	449
HR599	301	452
HR599	302	454
HR599	304	459
HR599	347	522
HR599	351	528
HR599	378	575

		9
HR599	379	576
HR599	381	579
HR599	384	582
HR599	388	587
HR599	394	597
HR599	398	602
HR599	399	604
HR599	400	606
HR599	401	608
HR602	415	640
HR615	84	132
HR615	85	133
HR615	85	134
HR615	170	265
HR615	171	268
HR615	172	269
HR615	172	270
HR615	173	271
HR615	174	272
HR615	175	273
HR615	175	274
HR615	176	275
HR615	176	276
HR615	177	277
HR615	178	278
HR615	179	279
HR615	179	280
HR615	180	281
HR615	180	282
HR615	181	283
HR615	181	284
HR615	182	285
HR615	183	286
HR615	184	287
HR615	185	288
HR615	312	477
HR615	312	478
HR615	313	479
HR615	314	480
HR615	315	482
HR615	316	483
HR615	317	484
HR615	318	485
HR615	319	486
HR615	320	487
HR615	322	492
HR615	323	493
HR615	324	494
HR615	325	495
HR615	326	496
HR615	327	497
HR615	328	498
HR615	329	499
HR615	330	500
HR615	331	501
HR615	332	503
HR615	333	504
HR615	333	505

		9
HR615	334	506
HR615	335	508
HR615	335	509
HR615	336	510
HR615	336	511
HR615	337	512
HR615	338	513
HR615	339	514
HR615	340	515
HR615	341	516
HR615	342	517
HR615	344	519
HR615	345	520
HR615	348	523
HR615	353	531
HR615	410	632
HR615	411	633
HR615	412	634
HR622	365	556
HR642	103	160
HR642	370	566
HR642	400	605
HR646	2	2
HR646	9	15
HR646	128	206
HR646	128	207
HR646	129	208
HR646	141	222
HR646	143	225
HR646	157	241
HR646	158	242
HR646	159	245
HR646	159	246
HR646	162	251
HR646	163	253
HR646	164	255
HR646	169	262
HR646	169	263
HR646	169	264
HR646	191	298
HR646	194	302
HR646	205	315
HR646	257	388
HR646	257	391
HR646	258	393
HR646	259	396
HR646	259	399
HR646	290	436
HR646	290	437
HR646	291	439
HR646	299	448
HR646	300	449
HR646	302	453
HR646	309	469
HR646	309	470
HR646	309	471
HR646	394	597
HR646	396	600

NUMERICAL PARTS LIST

Nummerische Teilenummernliste • Elenco riferimenti
Liste des références produits

 9		
HR646	398	602
HR646	399	604
HR646	400	605
HR646	400	606
HR646	401	607
HR646	401	608
HR646	405	616
HR646	405	618
HR646	407	624
HR646	409	629
HR662	355	536
HR662	363	553
HR662	364	554
HR662	372	568
HR662	413	636
HR662	416	641
HR791	39	66
HR791	40	67
HR791	43	70
HR791	47	76
HR791	48	77
HR791	50	79
HR791	51	80
HR791	52	82
HR791	52	83
HR791	53	84
HR791	53	85
HR791	54	86
HR791	55	87
HR791	55	88
HR791	56	89
HR791	56	90
HR791	57	91
HR791	57	92
HR791	71	111
HR791	74	115
HR791	76	117
HR791	77	118
HR791	78	119
HR791	79	120
HR791	80	122
HR791	81	123
HR791	82	124
HR791	101	157
HR791	287	433
HR791	289	435
HR791	292	440
HR791	293	441
HR791	294	442
HR791	296	444
HR791	298	446
HR791	299	447
HR791	300	450
HR791	301	451
HR791	302	455
HR791	303	456
HR791	303	457
HR791	304	458

 9		
HR791	305	460
HR791	308	464
HR791	308	465
HR791	309	467
HR791	310	474
HR791	373	569
HR791	374	570
HR791	375	571
HR791	393	595
HR791	395	598
HR791	395	599
HR791	403	612
HR791	403	613
HR791	404	614
HR791	405	615
HR791	406	620
HR791	408	626
HR800	359	546
HR805	86	135
HR805	86	136
HR805	89	141
HR805	91	143
HR805	92	144
HR805	93	145
HR805	94	146
HR805	349	525
HR805	353	531
HR816	1	1
HR816	4	4
HR816	9	16
HR816	10	17
HR816	11	18
HR816	12	19
HR816	13	22
HR816	14	23
HR816	15	24
HR816	16	25
HR816	23	38
HR816	24	39
HR816	27	44
HR816	28	45
HR816	38	64
HR816	38	65
HR816	60	100
HR816	73	113
HR816	73	114
HR816	75	116
HR816	101	158
HR816	122	197
HR816	123	198
HR816	123	199
HR816	124	200
HR816	125	202
HR816	126	203
HR816	128	205
HR816	129	209
HR816	130	210
HR816	131	211

 9		
HR816	132	212
HR816	133	213
HR816	134	214
HR816	135	215
HR816	136	216
HR816	137	217
HR816	138	218
HR816	139	219
HR816	140	220
HR816	141	221
HR816	142	223
HR816	143	224
HR816	144	226
HR816	145	227
HR816	146	228
HR816	147	229
HR816	148	230
HR816	149	231
HR816	150	232
HR816	151	233
HR816	152	234
HR816	153	235
HR816	154	237
HR816	155	238
HR816	156	239
HR816	157	240
HR816	158	243
HR816	159	244
HR816	160	247
HR816	161	249
HR816	162	250
HR816	163	252
HR816	163	253
HR816	164	254
HR816	165	256
HR816	165	257
HR816	166	258
HR816	167	259
HR816	168	260
HR816	169	261
HR816	186	292
HR816	191	297
HR816	192	299
HR816	193	300
HR816	195	303
HR816	196	304
HR816	198	306
HR816	199	308
HR816	200	309
HR816	215	333
HR816	219	338
HR816	220	339
HR816	221	340
HR816	221	341
HR816	222	342
HR816	223	344
HR816	234	357
HR816	234	358

 9		
HR816	275	417
HR816	290	436
HR816	290	437
HR816	291	439
HR816	295	443
HR816	297	445
HR816	299	448
HR816	300	449
HR816	301	452
HR816	302	454
HR816	304	459
HR816	321	490
HR816	322	491
HR816	377	573
HR816	378	575
HR816	379	576
HR816	380	578
HR816	381	579
HR816	383	581
HR816	384	582
HR816	384	583
HR816	385	584
HR816	386	585
HR816	387	586
HR816	389	588
HR816	391	590
HR816	392	592
HR816	397	601
HR816	398	602
HR816	399	603
HR816	399	604
HR817	3	3
HR817	41	68
HR817	42	69
HR817	44	71
HR817	45	73
HR817	46	75
HR817	49	78
HR817	79	121
HR817	197	305
HR817	201	310
HR817	202	311
HR817	203	312
HR817	204	313
HR817	204	314
HR817	205	316
HR817	205	317
HR817	206	318
HR822	222	343
HR822	224	345
HR822	225	346
HR822	226	347
HR822	227	348
HR822	228	349
HR822	229	350
HR822	230	351
HR822	231	352
HR822	232	353

 9		
HR822	232	354
HR822	233	355
HR822	233	356
HR822	235	359
HR822	235	360
HR822	236	361
HR822	237	362
HR822	238	363
HR822	239	364
HR822	240	365
HR822	241	366
HR822	242	367
HR822	243	368
HR822	244	369
HR822	245	370
HR822	246	371
HR822	247	372
HR822	248	373
HR822	249	374
HR822	250	376
HR822	250	377
HR822	251	378
HR822	252	379
HR822	253	380
HR822	254	382
HR822	254	383
HR822	255	384
HR822	256	386
HR822	256	387
HR822	257	392
HR822	258	394
HR822	258	395
HR822	259	397
HR822	259	398
HR822	354	534
HR822	355	535
HR5062	95	150
HR5062	96	151
HR5062	97	152
HR5062	98	153
HR5062	99	154
HR5062	100	155
HR5062	100	156
HR5062	359	544
HR5062	365	557
HR5062	366	558
HR5062	367	559
HR5062	368	560
HR5062	371	567
HR5068	32	54
HR5068	33	55
HR5068	102	159
HR5068	103	160
HR5068	104	161
HR5068	105	162
HR5068	105	163
HR5068	106	164
HR5068	413	636

 9		
HR5068	414	638
HR5085	314	481
HR5085	347	522
JA5068	363	553
JA5068	364	554
JA5068	372	568
JA5069	355	537
JA5069	363	553
JA5069	364	554
JA5069	365	556
JA5069	372	568
JB373	94	147
JB373	94	148
JB373	95	149
JB373	421	652
JB373	421	653
JB373	426	661
JB373	426	662
JB373	432	681
JB373	433	682
JC146	86	135
JC146	86	136
JC146	88	140
JC146	89	141
JC146	90	142
JC146	91	143
JC146	92	144
JC146	93	145
JC146	94	146
JC152	16	26
JC152	25	41
JC152	26	42
JC152	26	43
JC152	58	93
JC152	58	95
JC152	59	96
JC152	59	97
JC152	59	98
JC152	60	99
JC152	61	101
JC152	62	102
JC152	63	103
JC152	64	104
JC152	65	105
JC152	66	106
JC152	67	107
JC152	68	108
JC152	69	109
JC152	70	110
JC152	83	126
JC152	83	127
JC152	83	128
JC152	83	129
JC152	84	130
JC152	84	131
JC152	84	132
JC152	85	133
JC152	85	134

 9		
JC152	86	135
JC152	86	136
JC152	87	137
JC152	87	138
JC152	87	139
JC152	88	140
JC152	89	141
JC152	90	142
JC152	91	143
JC152	92	144
JC152	93	145
JC152	94	146
JC152	106	165
JC152	107	166
JC152	107	167
JC152	108	168
JC152	108	169
JC152	109	170
JC152	109	171
JC152	110	172
JC152	110	173
JC152	111	174
JC152	111	175
JC152	112	176
JC152	112	177
JC152	113	178
JC152	113	179
JC152	114	181
JC152	114	182
JC152	115	183
JC152	116	184
JC152	116	185
JC152	117	186
JC152	117	187
JC152	118	188
JC152	119	189
JC152	119	190
JC152	120	191
JC152	120	192
JC152	120	193
JC152	121	194
JC152	121	195
JC152	122	196
JC152	122	197
JC152	123	198
JC152	123	199
JC152	124	200
JC152	124	201
JC152	125	202
JC152	126	203
JC152	127	204
JC152	128	205
JC152	129	209
JC152	130	210
JC152	131	211
JC152	132	212
JC152	133	213
JC152	134	214

 9		
JC152	135	215
JC152	136	216
JC152	137	217
JC152	138	218
JC152	139	219
JC152	140	220
JC152	141	221
JC152	144	226
JC152	145	227
JC152	146	228
JC152	147	229
JC152	148	230
JC152	149	231
JC152	153	235
JC152	169	261
JC152	170	265
JC152	170	267
JC152	171	268
JC152	172	269
JC152	172	270
JC152	173	271
JC152	174	272
JC152	175	273
JC152	175	274
JC152	176	275
JC152	176	276
JC152	177	277
JC152	178	278
JC152	179	279
JC152	179	280
JC152	180	281
JC152	180	282
JC152	181	283
JC152	181	284
JC152	182	285
JC152	183	286
JC152	184	287
JC152	185	288
JC152	185	289
JC152	185	290
JC152	186	291
JC152	187	293
JC152	188	294
JC152	189	295
JC152	190	296
JC152	191	297
JC152	191	298
JC152	195	303
JC152	197	305
JC152	198	306
JC152	206	319
JC152	207	320
JC152	207	321
JC152	208	322
JC152	208	323
JC152	209	324
JC152	209	325
JC152	210	326

NUMERICAL PARTS LIST

Nummerische Teilenummernliste • Elenco riferimenti
Liste des références produits

 9		
JC152	210	327
JC152	211	328
JC152	212	329
JC152	213	330
JC152	214	331
JC152	214	332
JC152	215	334
JC152	216	335
JC152	217	336
JC152	218	337
JC152	219	338
JC152	220	339
JC152	221	341
JC152	234	358
JC152	260	400
JC152	261	401
JC152	262	402
JC152	262	403
JC152	263	404
JC152	264	405
JC152	265	406
JC152	266	407
JC152	267	408
JC152	267	409
JC152	268	410
JC152	269	411
JC152	270	412
JC152	271	413
JC152	272	414
JC152	273	415
JC152	274	416
JC152	276	418
JC152	276	419
JC152	277	420
JC152	278	421
JC152	279	422
JC152	280	423
JC152	281	424
JC152	281	425
JC152	282	426
JC152	283	427
JC152	283	428
JC152	284	429
JC152	285	430
JC152	285	431
JC152	286	432
JC152	288	434
JC152	312	477
JC152	312	478
JC152	313	479
JC152	314	480
JC152	315	482
JC152	316	483
JC152	317	484
JC152	318	485
JC152	319	486
JC152	320	487
JC152	322	492

 9		
JC152	323	493
JC152	324	494
JC152	325	495
JC152	326	496
JC152	327	497
JC152	328	498
JC152	329	499
JC152	330	500
JC152	331	501
JC152	332	503
JC152	333	504
JC152	333	505
JC152	334	506
JC152	335	508
JC152	335	509
JC152	336	510
JC152	336	511
JC152	337	512
JC152	338	513
JC152	339	514
JC152	340	515
JC152	341	516
JC152	342	517
JC152	343	518
JC152	344	519
JC152	345	520
JC152	346	521
JC152	348	523
JC152	376	572
JC152	377	573
JC152	378	574
JC152	378	575
JC152	379	577
JC152	380	578
JC152	382	580
JC152	383	581
JC152	387	586
JC152	388	587
JC152	389	588
JC152	409	630
JC152	410	632
JC152	411	633
JC152	412	634
JC152	436	696
JC152	437	698
JC243	61	101
JC243	64	104
JC243	67	107
JC243	68	108
JC243	70	110
JC243	83	126
JC243	84	130
JC243	84	131
JC259	5	7
JC259	5	8
JC259	6	9
JC259	6	10
JC259	7	11

 9		
JC259	7	12
JC259	8	13
JC259	9	16
JC259	10	17
JC259	11	18
JC259	12	20
JC259	13	21
JC259	13	22
JC259	14	23
JC259	15	24
JC259	16	25
JC259	17	27
JC259	18	28
JC259	18	29
JC259	19	30
JC259	19	31
JC259	20	32
JC259	20	33
JC259	21	34
JC259	21	35
JC259	22	36
JC259	22	37
JC259	23	38
JC259	24	39
JC259	25	40
JC259	27	44
JC259	28	45
JC259	28	46
JC261	84	132
JC261	85	133
JC261	85	134
JC261	170	265
JC261	170	266
JC261	171	268
JC261	172	269
JC261	172	270
JC261	173	271
JC261	175	273
JC261	175	274
JC261	176	275
JC261	176	276
JC261	177	277
JC261	178	278
JC261	179	279
JC261	179	280
JC261	180	281
JC261	180	282
JC261	181	283
JC261	181	284
JC261	312	477
JC261	312	478
JC261	313	479
JC261	314	480
JC261	316	483
JC261	317	484
JC261	318	485
JC261	319	486
JC261	320	487

 9		
JC261	322	492
JC261	323	493
JC261	324	494
JC261	325	495
JC261	326	496
JC261	327	497
JC261	328	498
JC261	329	499
JC261	330	500
JC261	331	501
JC261	411	633
JC478	16	26
JC478	25	41
JC478	26	42
JC478	26	43
JC478	58	93
JC478	58	95
JC478	59	96
JC478	59	97
JC478	59	98
JC478	60	99
JC478	62	102
JC478	63	103
JC478	65	105
JC478	66	106
JC478	69	109
JC478	73	114
JC478	75	116
JC478	83	127
JC478	83	128
JC478	87	137
JC478	87	138
JC478	106	165
JC478	107	166
JC478	107	167
JC478	108	168
JC478	109	170
JC478	109	171
JC478	110	172
JC478	110	173
JC478	111	174
JC478	111	175
JC478	112	176
JC478	113	178
JC478	113	179
JC478	114	181
JC478	114	182
JC478	115	183
JC478	116	184
JC478	116	185
JC478	117	186
JC478	117	187
JC478	118	188
JC478	119	189
JC478	119	190
JC478	120	191
JC478	120	192
JC478	120	193

		9
JC478	121	195
JC478	170	267
JC478	185	289
JC478	186	291
JC478	187	293
JC478	188	294
JC478	189	295
JC478	190	296
JC478	191	297
JC478	191	298
JC478	206	319
JC478	207	320
JC478	207	321
JC478	208	322
JC478	208	323
JC478	209	324
JC478	209	325
JC478	210	326
JC478	210	327
JC478	211	328
JC478	212	329
JC478	213	330
JC478	214	331
JC478	214	332
JC478	215	334
JC478	216	335
JC478	217	336
JC478	218	337
JC478	219	338
JC478	220	339
JC478	223	344
JC478	234	358
JC478	260	400
JC478	261	401
JC478	262	402
JC478	262	403
JC478	263	404
JC478	264	405
JC478	265	406
JC478	266	407
JC478	267	408
JC478	267	409
JC478	268	410
JC478	269	411
JC478	270	412
JC478	271	413
JC478	272	414
JC478	273	415
JC478	274	416
JC478	276	418
JC478	276	419
JC478	277	420
JC478	278	421
JC478	279	422
JC478	280	423
JC478	281	424
JC478	281	425
JC478	282	426

		9
JC478	283	427
JC478	283	428
JC478	284	429
JC478	285	430
JC478	285	431
JC478	286	432
JC478	360	547
JC478	362	551
JC478	436	696
JC478	437	698
JD160	435	691
JD170	122	196
JD170	122	197
JD170	123	198
JD170	123	199
JD170	124	200
JD170	124	201
JD170	125	202
JD170	126	203
JD170	127	204
JD170	128	205
JD170	128	206
JD170	128	207
JD170	129	208
JD170	129	209
JD170	130	210
JD170	131	211
JD170	132	212
JD170	133	213
JD170	134	214
JD170	135	215
JD170	136	216
JD170	137	217
JD170	138	218
JD170	139	219
JD170	140	220
JD170	141	221
JD170	142	223
JD170	143	224
JD170	143	225
JD170	144	226
JD170	145	227
JD170	146	228
JD170	147	229
JD170	148	230
JD170	149	231
JD170	150	232
JD170	151	233
JD170	152	234
JD170	153	235
JD170	153	236
JD170	154	237
JD170	155	238
JD170	156	239
JD170	157	240
JD170	157	241
JD170	158	242
JD170	158	243

		9
JD170	159	244
JD170	160	247
JD170	161	248
JD170	161	249
JD170	162	250
JD170	163	252
JD170	163	253
JD170	164	254
JD170	164	255
JD170	165	256
JD170	165	257
JD170	166	258
JD170	167	259
JD170	168	260
JD170	169	261
JD170	169	262
JD170	185	290
JD170	290	436
JD170	290	437
JD170	291	439
JD170	295	443
JD170	297	445
JD170	299	448
JD170	300	449
JD170	301	452
JD170	302	454
JD170	304	459
JD170	309	471
JD171	315	482
JD171	316	483
JD171	318	485
JD171	332	503
JD171	333	504
JD171	333	505
JD171	335	508
JD171	335	509
JD171	336	510
JD171	410	632
JD171	411	633
JD171	412	634
JD236	436	693
JD236	436	694
JD236	436	695
JD236	436	696
JD236	437	697
JD236	437	698
JD236	437	699
JD236	438	700
JD237	436	693
JD237	436	694
JD237	436	695
JD237	436	696
JD237	437	697
JD237	437	698
JD237	437	699
JD237	438	700
JD246	5	7
JD246	5	8

		9
JD246	6	9
JD246	6	10
JD246	7	11
JD246	7	12
JD246	8	13
JD246	9	16
JD246	10	17
JD246	11	18
JD246	12	19
JD246	12	20
JD246	13	21
JD246	13	22
JD246	14	23
JD246	15	24
JD246	16	25
JD246	17	27
JD246	18	28
JD246	18	29
JD246	19	30
JD246	19	31
JD246	20	32
JD246	20	33
JD246	21	34
JD246	21	35
JD246	22	36
JD246	22	37
JD246	23	38
JD246	24	39
JD246	25	40
JD246	27	44
JD246	28	45
JD246	28	46
JD278	121	194
JD281	222	342
JD281	275	417
JD281	378	575
JD281	379	576
JD281	381	579
JD282	222	342
JD282	275	417
JD282	314	481
JD282	320	488
JD282	321	490
JD282	322	491
JD282	331	502
JD282	378	575
JD282	379	576
JD282	381	579
JD282	384	582
JD282	410	631
JD312	182	285
JD312	183	286
JD312	184	287
JD312	185	288
JD312	334	506
JD312	336	511
JD312	337	512
JD312	338	513

NUMERICAL PARTS LIST

Nummerische Teilenummernliste • Elenco riferimenti
Liste des références produits

 9		
JD312	339	514
JD312	340	515
JD312	341	516
JD312	342	517
JD312	343	518
JD312	344	519
JD312	345	520
JD312	346	521
JD312	348	523
JD312	348	524
JD312	349	525
JD312	350	526
JD312	353	531
JD327	315	482
JD327	316	483
JD327	318	485
JD327	410	632
JD327	411	633
JD327	412	634
JD482	383	581
JD483	194	302
JD483	288	434
JD483	377	573
JD483	379	577
JD483	382	580
JD483	385	584
JD483	387	586
JD483	388	587
JD483	389	588
JD487	38	64
JD487	72	112
JD487	73	113
JD488	12	19
JD488	38	64
JD488	72	112
JD488	73	113
JD597	1	1
JD597	4	4
JD597	38	65
JD597	42	69
JD597	44	71
JD597	45	73
JD597	46	74
JD597	46	75
JD597	49	78
JD597	73	114
JD597	75	116
JD597	215	333
JD597	314	481
JD597	320	488
JD597	321	489
JD597	321	490
JD597	322	491
JD599	186	292
JD599	194	301
JD599	194	302
JD599	384	583
JD600	142	223
JD600	150	232
JD600	151	233
JD600	152	234
JD600	154	237
JD600	155	238

 9		
JD600	156	239
JD600	157	240
JD600	158	243
JD600	160	247
JD600	161	249
JD600	163	252
JD600	163	253
JD600	164	254
JD600	165	256
JD600	166	258
JD600	167	259
JD600	168	260
JD600	186	292
JD600	193	300
JD600	194	301
JD600	196	304
JD600	205	316
JD600	221	340
JD600	234	357
JD600	290	436
JD600	290	437
JD600	291	439
JD600	292	440
JD600	299	448
JD600	300	449
JD600	301	452
JD600	302	454
JD600	304	459
JD600	384	583
JD600	392	593
JD600	394	596
JD600	399	604
JD600	402	611
JD601	1	1
JD601	4	4
JD601	38	65
JD601	44	71
JD601	46	74
JD601	46	75
JD601	60	100
JD601	73	114
JD601	75	116
JD601	215	333
JD602	314	481
JD602	320	488
JD602	321	489
JD602	321	490
JD602	322	491
JD602	331	502
JD602	410	631
JD603	320	488
JD603	321	489
JD603	321	490
JD603	322	491
JD603	331	502
JD604	222	343
JD604	224	345
JD604	225	346

 9		
JD604	227	348
JD604	228	349
JD604	229	350
JD604	230	351
JD604	231	352
JD604	232	353
JD604	232	354
JD604	233	355
JD604	233	356
JD604	235	359
JD604	236	361
JD604	237	362
JD604	238	363
JD604	239	364
JD604	240	365
JD604	241	366
JD604	242	367
JD604	243	368
JD604	244	369
JD604	245	370
JD604	246	371
JD604	247	372
JD604	248	373
JD604	249	374
JD604	250	376
JD604	250	377
JD604	251	378
JD604	252	379
JD604	253	380
JD604	255	384
JD604	255	384
JD604	256	386
JD604	256	387
JD604	257	392
JD604	258	394
JD604	258	395
JD604	259	397
JD605	222	343
JD605	224	345
JD605	225	346
JD605	226	347
JD605	227	348
JD605	228	349
JD605	229	350
JD605	230	351
JD605	231	352
JD605	232	353
JD605	232	354
JD605	233	355
JD605	233	356
JD605	235	359
JD605	235	360
JD605	236	361
JD605	237	362
JD605	238	363
JD605	239	364
JD605	240	365
JD605	241	366

 9		
JD605	242	367
JD605	243	368
JD605	244	369
JD605	245	370
JD605	246	371
JD605	247	372
JD605	248	373
JD605	249	374
JD605	249	375
JD605	250	376
JD605	250	377
JD605	251	378
JD605	252	379
JD605	253	380
JD605	254	382
JD605	254	383
JD605	255	384
JD605	256	386
JD605	256	387
JD605	257	392
JD605	258	394
JD605	258	395
JD605	259	397
JD605	259	398
JD606	141	221
JD606	143	224
JD606	159	244
JD606	194	302
JD606	223	344
JD607	193	300
JD607	196	304
JD607	226	347
JD607	235	360
JD607	254	382
JD5109	355	537
JD5109	363	553
JD5109	364	554
JD5109	365	556
JD5109	372	568
JD5228	39	66
JD5228	40	67
JD5228	43	70
JD5228	44	72
JD5228	48	77
JD5228	50	79
JD5228	54	86
JD5228	56	90
JD5228	57	91
JD5228	57	92
JD5228	78	119
JD5228	80	122
JD5228	82	124
JD5228	82	125
JD5232	220	339
JD5232	363	553
JD5232	372	568
JD5233	39	66
JD5235	219	338

 9		
JD5235	221	340
JD5235	221	341
JD5235	223	344
JD5235	234	357
JD5235	234	358
JD5278	32	54
JD5278	33	55
JD5278	102	159
JD5278	103	160
JD5278	104	161
JD5278	105	162
JD5278	105	163
JD5278	106	164
JD5279	32	54
JD5279	33	55
JD5279	102	159
JD5279	103	160
JD5279	104	161
JD5279	105	162
JD5279	106	164
JD5291	399	603
JD5292	392	592
JD5292	394	597
JD5293	193	300
JD5293	199	308
JD5293	200	309
JD5293	201	310
JD5293	202	311
JD5293	203	312
JD5293	204	313
JD5293	204	314
JD5293	205	317
JD5293	205	318
JD5293	206	318
JD5293	255	385
JD5293	385	584
JD5293	386	585
JD5293	391	590
JD5293	392	592
JD5293	393	594
JD5293	394	597
JD5293	396	600
JD5293	397	601
JD5293	398	602
JD5293	400	605
JD5293	400	606
JD5293	401	608
JD5293	401	609
JD5293	402	610
JD5293	407	623
JD5293	408	627
JD5298	40	67
JD5298	43	70
JD5298	44	72
JD5298	47	76
JD5298	48	77
JD5298	50	79
JD5298	54	86

 9		
JD5298	56	90
JD5298	57	91
JD5298	71	111
JD5298	74	115
JD5298	76	117
JD5298	77	118
JD5298	78	119
JD5298	79	120
JD5298	80	122
JD5314	386	585
JD5314	391	590
JD5314	396	600
JD5314	397	601
JD5314	398	602
JD5318	3	3
JD5318	41	68
JD5318	42	69
JD5318	45	73
JD5318	49	78
JD5318	51	81
JD5318	52	83
JD5318	79	121
JD5340	199	308
JD5340	200	309
JD5340	201	310
JD5340	202	311
JD5340	203	312
JD5340	204	313
JD5340	204	314
JD5340	205	316
JD5340	205	317
JD5340	206	318
JD5340	255	385
JD5340	397	601
JD5340	398	602
JD5340	400	606
JD5340	401	608
JD5341	192	299
JD5341	195	303
JD5341	197	305
JD5341	198	306
JD5341	399	604
JD5373	71	111
JD5373	74	115
JD5373	76	117
JD5373	77	118
JD5766	29	47
JD5766	29	49
JD5805	289	435
JD5805	292	440
JD5805	293	441
JD5805	296	444
JD5805	298	446
JD5805	299	447
JD5805	302	455
JD5805	303	456
JD5805	305	460
JD5805	308	465

 9		
JD5806	289	435
JD5806	292	440
JD5806	293	441
JD5806	294	442
JD5806	296	444
JD5806	298	446
JD5806	299	447
JD5806	300	450
JD5806	301	451
JD5806	302	455
JD5806	303	456
JD5806	303	457
JD5806	304	458
JD5806	305	460
JD5806	308	465
JD5807	33	56
JD5807	35	59
JD5808	35	58
JD5808	35	59
JD5808	37	63
JD5809	30	50
JD5809	47	76
JD5809	51	80
JD5809	52	82
JD5809	53	84
JD5809	53	85
JD5809	55	87
JD5809	55	88
JD5809	56	89
JD5809	79	120
JD5809	81	123
JD5810	95	150
JD5810	96	151
JD5810	97	152
JD5810	98	153
JD5810	99	154
JD5810	100	155
JD5810	100	156
JD5811	34	57
JD5811	36	60
JD5811	36	61
JD5811	37	62
JD5812	30	51
JD5812	31	52
JD5812	31	53
JD5813	232	353
JD5813	390	589
JD5813	393	595
JD5813	395	598
JD5813	404	614
JD5813	405	615
JD5814	51	80
JD5814	52	82
JD5814	53	84
JD5814	53	85
JD5814	55	87
JD5814	81	123
JD5814	82	124

 9		
JD5815	289	435
JD5815	292	440
JD5815	293	441
JD5815	294	442
JD5815	296	444
JD5815	298	446
JD5815	299	447
JD5815	300	450
JD5815	301	451
JD5815	303	457
JD5815	304	458
JD5815	308	464
JD5815	308	465
JD5815	309	467
JD5815	310	474
JD5816	34	57
JD5816	36	60
JD5816	36	61
JD5816	37	62
JD5817	2	2
JD5817	9	15
JD5817	30	51
JD5817	31	52
JD5817	31	53
JD5818	2	2
JD5818	9	15
JD5818	30	51
JD5818	31	52
JD5818	31	53
JD5819	33	56
JD5819	35	58
JD5819	35	59
JD5819	37	63
JD5820	390	589
JD5835	51	81
JD5835	79	121
JD5849	2	2
JD5849	9	15
JD5849	30	51
JD5849	31	52
JD5849	31	53
JD5851	95	150
JD5851	96	151
JD5851	97	152
JD5851	98	153
JD5851	99	154
JD5851	100	155
JD5851	100	156
JD5851	101	157
JD5851	369	563
JD5857	366	558
JD5857	367	559
JD5872	371	567
JD5872	422	654
JD5872	423	655
JD5872	424	656
JD5872	424	657
JD5872	425	658

NUMERICAL PARTS LIST

Numerische Teilenummernliste • Elenco riferimenti
Liste des références produits

		9
JD5872	425	659
JD5873	393	595
JD5873	395	598
JD5873	404	614
JD5873	405	615
JD5874	426	663
JD5874	427	664
JD5874	428	665
JD5874	428	666
JD5927	355	535
JD5928	364	555
JD5936	31	52
JD5936	31	53
JD5948	349	525
JD5948	350	526
JD5948	350	527
JD5948	353	531
JD5948	353	532
JD5955	347	522
JD5955	351	528
JD5956	347	522
JD5956	351	528
JD5957	347	522
JD5957	351	528
JD5992	162	250
JD5992	164	255
JD5992	165	257
JD5992	295	443
JD5992	297	445
JD5992	309	470
JD5992	309	471
JD6005	230	351
JD6005	232	354
JD6005	238	363
JD6005	239	364
JD6005	240	365
JD6005	243	368
JD6005	246	371
JD6005	256	386
JD6005	258	394
JD6005	259	398
JE117	107	166
JE117	116	185
JE117	117	186
JE117	263	404
JE117	265	406
JE117	271	413
JE117	276	418
JE117	278	421
JE138	86	135
JE138	86	136
JE138	87	139
JE138	89	141
JE138	90	142
JE138	92	144
JE138	125	202
JE138	182	285
JE138	184	287

		9
JE138	206	319
JE138	207	320
JE138	212	329
JE138	213	330
JE138	262	402
JE138	262	403
JE138	272	414
JE138	281	425
JE138	282	426
JE138	286	432
JE154	5	7
JE154	5	8
JE154	6	9
JE154	6	10
JE154	7	11
JE154	7	12
JE154	8	13
JE154	12	20
JE154	13	21
JE154	15	24
JE154	19	30
JE154	72	112
JE160	62	102
JE160	63	103
JE160	64	104
JE160	65	105
JE160	66	106
JE160	67	107
JE160	69	109
JE160	124	201
JE160	183	286
JE160	187	293
JE160	190	296
JE160	207	321
JE160	208	322
JE160	208	323
JE160	209	324
JE160	209	325
JE160	210	326
JE160	211	328
JE160	216	335
JE160	217	336
JE160	263	404
JE160	265	406
JE160	266	407
JE160	267	408
JE160	267	409
JE160	268	410
JE160	269	411
JE160	270	412
JE160	271	413
JE160	276	418
JE160	278	421
JE160	279	422
JE160	280	423
JE160	283	427
JE160	283	428
JE160	284	429

		9
JE689	170	265
JE689	171	268
JE689	173	271
JE689	174	272
JE689	176	275
JE689	177	277
JE689	178	278
JE689	179	279
JE689	179	280
JE689	188	294
JE689	189	295
JE689	191	297
JE689	195	303
JE689	198	306
JE689	214	331
JE689	222	343
JE689	224	345
JE689	225	346
JE689	229	350
JE689	230	351
JE689	233	356
JE689	235	359
JE689	237	362
JE689	240	365
JE689	242	367
JE689	243	368
JE689	249	374
JE689	249	375
JE689	264	405
JE689	276	419
JE689	277	420
JE689	285	430
JE689	285	431
JE689	312	477
JE689	312	478
JE689	313	479
JE689	314	480
JE689	315	482
JE689	316	483
JE689	317	484
JE689	318	485
JE689	322	492
JE689	323	493
JE689	324	494
JE689	325	495
JE689	326	496
JE689	327	497
JE689	328	498
JE689	331	501
JE689	376	572
JE689	378	574
JE689	379	577
JE689	382	580
JE689	384	582
JE689	409	630
JE689	434	687
JE689	434	688
JE904	16	26

		9
JE904	25	41
JE904	58	93
JE904	58	95
JE904	59	96
JE904	60	99
JE904	106	165
JE904	108	168
JE904	109	170
JE904	109	171
JE904	110	172
JE904	110	173
JE904	111	174
JE904	111	175
JE904	113	178
JE904	113	179
JE904	114	181
JE904	115	183
JE904	116	184
JE904	117	187
JE904	119	190
JE904	120	191
JE904	121	195
JE904	218	337
JE904	260	400
JE904	261	401
JE904	262	402
JE904	273	415
JE904	274	416
JE5036	32	54
JE5036	33	55
JE5075	153	235
JE5075	244	369
JE5075	252	379
JE5075	300	449
JE5075	302	454
JE5075	303	457
JE5075	304	458
JE5076	3	3
JE5076	71	111
JE5076	74	115
JE5076	76	117
JE5076	77	118
JE5076	78	119
JE5076	80	122
JE5076	122	197
JE5076	123	198
JE5076	125	202
JE5076	127	204
JE5076	129	209
JE5076	130	210
JE5076	134	214
JE5076	143	224
JE5076	157	240
JE5076	219	338
JE5076	220	339
JE5076	221	340
JE5076	234	357
JE5076	234	358

				9
JE5077	364	555		
JF205	186	292		
JF205	194	301		
JF205	221	341		
JF205	226	347		
JF205	227	348		
JF205	228	349		
JF205	231	352		
JF205	232	354		
JF205	233	355		
JF205	235	360		
JF205	239	364		
JF205	245	370		
JF205	246	371		
JF205	248	373		
JF205	250	376		
JF205	254	382		
JF205	275	417		
JF205	276	418		
JF205	281	424		
JF205	283	428		
JF205	377	573		
JF205	379	576		
JF205	381	579		
JF205	384	583		
JF205	385	584		
JF205	387	586		
JF205	388	587		
JF205	389	588		
JF205	392	593		
JF211	193	300		
JF211	196	304		
JM154	5	7		
JM154	5	8		
JM154	6	9		
JM154	6	10		
JM154	7	11		
JM154	8	13		
JM154	12	20		
JM154	13	21		
JM154	17	27		
JM154	18	28		
JM154	18	29		
JM154	19	30		
JM154	19	31		
JM154	20	32		
JM154	20	33		
JM154	21	34		
JM154	21	35		
JM986	94	147		
JM986	94	148		
JM986	95	149		
JM986	421	652		
JM986	421	653		
JM986	426	661		
JM986	426	662		
JM986	432	681		
JM986	433	682		

				9
JM986	436	693		
JM986	436	694		
JM986	436	695		
JM986	436	696		
JM986	437	697		
JM986	437	698		
JM986	437	699		
JM986	438	700		
JM5030	363	553		
JM5030	364	554		
JM5030	365	556		
JM5030	372	568		
JM5099	363	553		
JM5099	365	556		
JM5099	372	568		
JM5103	386	585		
JM5103	391	590		
JM5103	392	592		
JM5103	393	594		
JM5103	394	597		
JM5103	396	600		
JM5103	397	601		
JM5103	398	602		
JM5103	400	605		
JM5103	400	606		
JM5103	401	608		
JM5103	401	609		
JM5103	402	610		
JM5103	407	623		
JM5103	408	627		
JM5120	139	219		
JM5166	355	536		
JM5166	413	636		
JM5166	414	637		
JM5166	414	638		
JM5166	415	640		
JM5166	416	641		
JM5203	142	223		
JM5203	144	226		
JM5203	148	230		
JM5203	149	231		
JM5203	150	232		
JM5203	151	233		
JM5203	152	234		
JM5203	154	237		
JM5203	155	238		
JM5203	156	239		
JM5203	158	243		
JM5203	160	247		
JM5203	161	249		
JM5203	162	251		
JM5203	163	252		
JM5203	163	253		
JM5203	164	254		
JM5203	166	258		
JM5203	167	259		
JM5203	168	260		
JM5203	169	261		

				9
JM5203	290	436		
JM5203	290	437		
JM5203	291	439		
JM5203	299	448		
JM5203	300	449		
JM5203	302	454		
JM5203	309	469		
JM5205	197	305		
JM5205	201	310		
JM5205	202	311		
JM5205	203	312		
JM5205	204	313		
JM5205	204	314		
JM5205	205	316		
JM5205	205	317		
JM5205	206	318		
JM5205	255	385		
JM5234	354	534		
JM5234	355	535		
JM5285	2	2		
JM5285	9	15		
JM5285	28	46		
JM5285	29	47		
JM5285	29	48		
JM5285	29	49		
JM5285	30	51		
JM5285	31	52		
JM5285	31	53		
JM7029	294	442		
JM7029	299	447		
JM7029	300	450		
JM7029	301	451		
JM7029	304	458		
JM7030	390	589		
JM7031	289	435		
JM7031	292	440		
JM7031	293	441		
JM7031	295	443		
JM7031	296	444		
JM7031	298	446		
JM7031	302	455		
JM7031	305	460		
JM7031	308	465		
JM7031	369	562		
JM7032	32	54		
JM7032	33	55		
JM7032	102	159		
JM7032	103	160		
JM7032	104	161		
JM7032	105	162		
JM7032	106	164		
JM7045	359	544		
JM7045	364	555		
JM7045	365	557		
JM7045	366	558		
JM7045	367	559		
JM7045	368	560		
JM7045	426	663		

				9
JM7045	427	664		
JM7045	428	666		
JM7046	371	567		
JM7046	405	617		
JM7046	422	654		
JM7046	423	655		
JM7046	424	656		
JM7046	424	657		
JM7046	425	658		
JM7046	425	659		
JM7047	371	567		
JM7047	405	617		
JM7047	422	654		
JM7047	423	655		
JM7047	424	656		
JM7047	424	657		
JM7047	425	658		
JM7047	425	659		
JM7048	393	595		
JM7048	395	598		
JM7048	405	615		
JM7077	334	506		
JM7077	339	514		
JM7077	341	516		
JM7077	342	517		
JM7077	343	518		
JM7077	344	519		
JM7077	345	520		
JM7077	346	521		
JM7077	348	523		
JM7077	349	525		
JM7077	350	526		
JM7077	350	527		
JM7077	353	532		
JM7078	404	614		
JM7107	162	250		
JM7107	164	255		
JM7107	165	257		
JM7107	295	443		
JM7107	297	445		
JM7107	309	470		
JM7107	309	471		
JM7113	165	256		
JM7113	301	452		
JM7113	304	459		
JN013	433	685		
JN013	435	690		
JN013	435	692		
JN013	438	701		
JN013	438	702		
JN013	439	704		
JN438	170	265		
JN438	171	268		
JN438	172	269		
JN438	172	270		
JN438	173	271		
JN438	174	272		
JN438	175	273		

NUMERICAL PARTS LIST

Numerische Teilenummernliste • Elenco riferimenti
Liste des références produits

		9
JN438	175	274
JN438	176	275
JN438	176	276
JN438	177	277
JN438	178	278
JN438	179	279
JN438	179	280
JN438	180	282
JN438	181	283
JN438	181	284
JN438	312	477
JN438	312	478
JN438	313	479
JN438	314	480
JN438	315	482
JN438	316	483
JN438	318	485
JN438	319	486
JN438	320	487
JN438	322	492
JN438	323	493
JN438	324	494
JN438	325	495
JN438	326	496
JN438	327	497
JN438	328	498
JN438	329	499
JN438	330	500
JN438	331	501
JN438	411	633
JN438	412	634
JN641	9	16
JN641	10	17
JN641	11	18
JN641	13	22
JN641	14	23
JN641	15	24
JN641	16	25
JN641	22	36
JN641	22	37
JN641	23	38
JN641	25	40
JN641	27	44
JN641	28	45
JN641	72	112
JN849	86	135
JN849	86	136
JN849	87	139
JN914	124	201
JN914	125	202
JN914	127	204
JN914	128	205
JN914	129	209
JN915	182	285
JN915	183	286
JN915	184	287
JN915	332	503
JN915	333	504

		9
JN915	333	505
JN915	335	508
JN915	335	509
JN915	336	510
JN915	342	517
JN964	215	334
JN964	281	424
JN967	336	511
JN967	337	512
JN967	338	513
JN967	340	515
JP003	122	197
JP003	123	198
JP003	123	199
JP003	124	200
JP003	126	203
JP003	130	210
JP003	131	211
JP003	132	212
JP003	133	213
JP003	137	217
JP003	138	218
JP003	140	220
JP003	147	229
JP003	153	235
JP024	186	292
JP024	188	294
JP024	189	295
JP024	191	297
JP024	192	299
JP024	193	300
JP024	194	301
JP024	194	302
JP024	195	303
JP024	196	304
JP024	198	306
JP024	199	308
JP024	200	309
JP024	219	338
JP024	220	339
JP024	221	340
JP024	221	341
JP024	234	357
JP024	234	358
JP024	288	434
JP024	377	573
JP024	380	578
JP024	382	580
JP024	383	581
JP024	384	583
JP024	385	584
JP024	387	586
JP024	388	587
JP024	389	588
JP024	391	590
JP024	392	593
JP024	394	596
JP024	397	601

		9
JP024	399	603
JP024	399	604
JP024	401	607
JP024	402	611
JP024	409	630
JP074	1	1
JP074	4	4
JP074	12	19
JP074	27	44
JP074	38	64
JP074	38	65
JP074	42	69
JP074	44	71
JP074	46	74
JP074	46	75
JP074	60	100
JP074	73	113
JP074	73	114
JP074	75	116
JP074	215	333
JP075	24	39
LA5204	386	585
LA5204	400	605
N072/3	499	785
N072/3	499	786
N072/3	719	1037
N072/3	723	1043
N072/3	728	1054
N072/3	729	1055
N118/5	456	724
N118/5	457	725
N118/5	477	755
N118/5	477	756
N118/5	478	757
N118/5	481	761
N118/5	481	762
N118/5	482	763
N118/5	484	765
N118/5	506	795
N118/5	507	796
N118/5	508	798
N118/5	509	799
N118/5	510	800
N118/5	512	803
N118/5	519	810
N118/5	594	879
N118/5	594	880
N118/5	598	882
N118/5	603	885
N118/5	608	889
N118/5	611	894
N118/5	624	913
N118/5	626	918
N118/5	629	921
N118/5	631	924
N118/5	631	925
N118/5	633	926
N118/5	635	927

		9
N118/5	642	931
N118/5	644	933
N118/5	648	937
N118/5	654	944
N139/3	499	785
N139/3	499	786
N147/4	459	730
N147/4	504	792
N147/4	505	793
N147/5	531	818
N147/5	535	821
N147/5	538	823
N147/5	539	824
N147/5	542	826
N147/5	544	827
N147/5	545	828
N147/5	546	829
N147/5	548	830
N147/5	549	831
N147/5	551	832
N147/5	556	837
N147/5	557	839
N147/5	560	841
N147/5	562	843
N147/5	564	844
N147/5	565	846
N147/5	566	848
N147/5	569	850
N147/5	660	950
N147/5	665	957
N147/5	670	962
N147/5	687	983
N147/5	688	984
N147/5	691	989
NA5001	1	1
NA5001	4	4
NA5001	5	7
NA5001	5	8
NA5001	6	9
NA5001	6	10
NA5001	7	11
NA5001	7	12
NA5001	8	13
NA5001	9	16
NA5001	10	17
NA5001	11	18
NA5001	12	19
NA5001	12	20
NA5001	13	21
NA5001	13	22
NA5001	14	23
NA5001	15	24
NA5001	16	25
NA5001	17	27
NA5001	18	28
NA5001	18	29
NA5001	19	30
NA5001	19	31

 9		
NA5001	20	32
NA5001	20	33
NA5001	21	34
NA5001	21	35
NA5001	22	36
NA5001	22	37
NA5001	23	38
NA5001	24	39
NA5001	25	40
NA5001	25	41
NA5001	26	42
NA5001	26	43
NA5001	27	44
NA5001	28	45
NA5001	38	64
NA5001	38	65
NA5001	39	66
NA5001	44	71
NA5001	46	74
NA5001	46	75
NA5001	60	99
NA5001	60	100
NA5001	61	101
NA5001	62	102
NA5001	63	103
NA5001	64	104
NA5001	65	105
NA5001	66	106
NA5001	67	107
NA5001	68	108
NA5001	69	109
NA5001	70	110
NA5001	72	112
NA5001	73	113
NA5001	73	114
NA5001	75	116
NA5001	83	126
NA5001	84	132
NA5001	85	133
NA5001	85	134
NA5001	86	135
NA5001	86	136
NA5001	87	137
NA5001	87	139
NA5001	88	140
NA5001	89	141
NA5001	90	142
NA5001	91	143
NA5001	92	144
NA5001	93	145
NA5001	94	146
NA5001	95	150
NA5001	96	151
NA5001	97	152
NA5001	98	153
NA5001	99	154
NA5001	100	155
NA5001	100	156

 9		
NA5001	101	157
NA5001	101	158
NA5001	106	165
NA5001	107	166
NA5001	108	168
NA5001	109	170
NA5001	109	171
NA5001	110	172
NA5001	111	174
NA5001	111	175
NA5001	113	178
NA5001	114	181
NA5001	114	182
NA5001	115	183
NA5001	116	184
NA5001	116	185
NA5001	117	186
NA5001	117	187
NA5001	118	188
NA5001	119	189
NA5001	119	190
NA5001	120	192
NA5001	120	193
NA5001	121	194
NA5001	121	195
NA5001	122	197
NA5001	123	198
NA5001	123	199
NA5001	124	200
NA5001	124	201
NA5001	125	202
NA5001	126	203
NA5001	127	204
NA5001	128	205
NA5001	129	209
NA5001	130	210
NA5001	131	211
NA5001	132	212
NA5001	133	213
NA5001	134	214
NA5001	135	215
NA5001	136	216
NA5001	137	217
NA5001	138	218
NA5001	140	220
NA5001	141	221
NA5001	143	224
NA5001	145	227
NA5001	146	228
NA5001	147	229
NA5001	148	230
NA5001	153	235
NA5001	157	240
NA5001	170	265
NA5001	171	268
NA5001	172	269
NA5001	172	270
NA5001	173	271

 9		
NA5001	175	273
NA5001	175	274
NA5001	176	275
NA5001	176	276
NA5001	177	277
NA5001	178	278
NA5001	179	279
NA5001	179	280
NA5001	180	281
NA5001	180	282
NA5001	181	283
NA5001	181	284
NA5001	182	285
NA5001	183	286
NA5001	184	287
NA5001	185	288
NA5001	186	292
NA5001	187	293
NA5001	188	294
NA5001	189	295
NA5001	190	296
NA5001	191	297
NA5001	192	299
NA5001	194	301
NA5001	206	319
NA5001	207	320
NA5001	207	321
NA5001	208	322
NA5001	208	323
NA5001	209	324
NA5001	209	325
NA5001	210	326
NA5001	210	327
NA5001	211	328
NA5001	212	329
NA5001	213	330
NA5001	214	331
NA5001	214	332
NA5001	215	333
NA5001	215	334
NA5001	216	335
NA5001	217	336
NA5001	218	337
NA5001	219	338
NA5001	220	339
NA5001	221	340
NA5001	221	341
NA5001	222	342
NA5001	222	343
NA5001	223	344
NA5001	224	345
NA5001	225	346
NA5001	227	348
NA5001	228	349
NA5001	231	352
NA5001	232	354
NA5001	233	355
NA5001	234	357

 9		
NA5001	234	358
NA5001	235	359
NA5001	236	361
NA5001	238	363
NA5001	239	364
NA5001	241	366
NA5001	244	369
NA5001	245	370
NA5001	246	371
NA5001	248	373
NA5001	249	374
NA5001	250	376
NA5001	251	378
NA5001	252	379
NA5001	253	380
NA5001	254	383
NA5001	256	387
NA5001	257	392
NA5001	259	397
NA5001	260	400
NA5001	261	401
NA5001	262	402
NA5001	262	403
NA5001	263	404
NA5001	264	405
NA5001	265	406
NA5001	266	407
NA5001	267	408
NA5001	267	409
NA5001	268	410
NA5001	269	411
NA5001	270	412
NA5001	271	413
NA5001	272	414
NA5001	273	415
NA5001	274	416
NA5001	275	417
NA5001	276	418
NA5001	277	420
NA5001	278	421
NA5001	279	422
NA5001	280	423
NA5001	281	424
NA5001	281	425
NA5001	282	426
NA5001	283	427
NA5001	283	428
NA5001	284	429
NA5001	285	430
NA5001	285	431
NA5001	286	432
NA5001	288	434
NA5001	312	477
NA5001	312	478
NA5001	313	479
NA5001	314	480
NA5001	314	481
NA5001	315	482

NUMERICAL PARTS LIST

Nummerische Teilenummernliste • Elenco riferimenti
Liste des références produits

 9		
NA5001	316	483
NA5001	317	484
NA5001	318	485
NA5001	319	486
NA5001	320	487
NA5001	320	488
NA5001	321	489
NA5001	321	490
NA5001	322	491
NA5001	322	492
NA5001	323	493
NA5001	324	494
NA5001	325	495
NA5001	326	496
NA5001	327	497
NA5001	328	498
NA5001	329	499
NA5001	330	500
NA5001	331	501
NA5001	331	502
NA5001	332	503
NA5001	333	504
NA5001	333	505
NA5001	334	506
NA5001	335	508
NA5001	335	509
NA5001	336	510
NA5001	336	511
NA5001	337	512
NA5001	338	513
NA5001	339	514
NA5001	340	515
NA5001	342	517
NA5001	343	518
NA5001	344	519
NA5001	345	520
NA5001	346	521
NA5001	348	523
NA5001	348	524
NA5001	348	525
NA5001	348	526
NA5001	354	534
NA5001	356	539
NA5001	360	547
NA5001	360	548
NA5001	361	549
NA5001	361	550
NA5001	362	551
NA5001	362	552
NA5001	371	567
NA5001	376	572
NA5001	377	573
NA5001	378	574
NA5001	378	575
NA5001	379	576
NA5001	379	577
NA5001	380	578
NA5001	381	579
NA5001	382	580
NA5001	383	581
NA5001	384	582

 9		
NA5001	384	583
NA5001	385	584
NA5001	387	586
NA5001	388	587
NA5001	389	588
NA5001	409	630
NA5001	410	631
NA5001	410	632
NA5001	411	633
NA5001	412	634
NA5001	413	636
NA5001	414	637
NA5001	414	638
NA5001	415	639
NA5001	415	640
NA5001	416	641
NA5001	417	642
NA5001	417	643
NA5001	418	644
NA5001	418	645
NA5001	419	646
NA5001	419	647
NA5001	422	654
NA5001	423	655
NA5001	424	656
NA5001	425	658
NA5001	434	686
NA5001	434	687
NA5001	434	688
NA5106	354	533
NA5124	32	54
NA5124	33	55
NA5124	102	159
NA5124	103	160
NA5124	104	161
NA5124	105	162
NA5124	105	163
NA5124	106	164
NA5124	139	219
NA5124	142	223
NA5124	144	226
NA5124	148	230
NA5124	149	231
NA5124	150	232
NA5124	151	233
NA5124	152	234
NA5124	154	237
NA5124	155	238
NA5124	156	239
NA5124	158	243
NA5124	159	244
NA5124	160	247
NA5124	161	249
NA5124	162	250
NA5124	163	252
NA5124	163	253
NA5124	164	254
NA5124	165	256

 9		
NA5124	165	257
NA5124	166	258
NA5124	167	259
NA5124	168	260
NA5124	169	261
NA5124	193	300
NA5124	195	303
NA5124	196	304
NA5124	197	305
NA5124	198	306
NA5124	199	308
NA5124	200	309
NA5124	201	310
NA5124	202	311
NA5124	203	312
NA5124	204	313
NA5124	204	314
NA5124	205	316
NA5124	205	317
NA5124	206	318
NA5124	222	343
NA5124	224	345
NA5124	225	346
NA5124	226	347
NA5124	227	348
NA5124	228	349
NA5124	230	351
NA5124	231	352
NA5124	232	353
NA5124	232	354
NA5124	233	355
NA5124	233	356
NA5124	235	359
NA5124	235	360
NA5124	236	361
NA5124	237	362
NA5124	238	363
NA5124	239	364
NA5124	240	365
NA5124	241	366
NA5124	242	367
NA5124	243	368
NA5124	245	370
NA5124	246	371
NA5124	247	372
NA5124	248	373
NA5124	249	374
NA5124	249	375
NA5124	250	376
NA5124	250	377
NA5124	251	378
NA5124	252	379
NA5124	253	380
NA5124	254	382
NA5124	255	384
NA5124	256	386
NA5124	256	387
NA5124	257	392

 9		
NA5124	258	394
NA5124	258	395
NA5124	259	397
NA5124	259	398
NA5124	289	435
NA5124	290	436
NA5124	291	439
NA5124	292	440
NA5124	295	443
NA5124	296	444
NA5124	297	445
NA5124	298	446
NA5124	299	447
NA5124	299	448
NA5124	300	449
NA5124	300	450
NA5124	301	451
NA5124	301	452
NA5124	302	454
NA5124	302	455
NA5124	303	456
NA5124	303	457
NA5124	304	458
NA5124	304	459
NA5124	305	460
NA5124	308	464
NA5124	309	467
NA5124	310	474
NA5124	339	514
NA5124	341	516
NA5124	342	517
NA5124	343	518
NA5124	344	519
NA5124	345	520
NA5124	346	521
NA5124	348	523
NA5124	349	525
NA5124	350	526
NA5124	353	531
NA5124	375	571
NA5124	385	584
NA5124	386	585
NA5124	391	590
NA5124	392	592
NA5124	392	593
NA5124	393	595
NA5124	394	596
NA5124	394	597
NA5124	395	598
NA5124	395	599
NA5124	396	600
NA5124	397	601
NA5124	398	602
NA5124	399	603
NA5124	399	604
NA5124	400	605
NA5124	400	606
NA5124	401	608

 9		
NA5124	403	613
NA5124	404	614
NA5124	405	615
NA5124	407	622
NA5124	408	626
NA5180	40	67
NA5180	43	70
NA5180	44	72
NA5180	47	76
NA5180	48	77
NA5180	50	79
NA5180	54	86
NA5180	56	90
NA5180	57	91
NA5180	71	111
NA5180	74	115
NA5180	76	117
NA5180	77	118
NA5180	78	119
NA5180	79	120
NA5180	80	122
NA5185	3	3
NA5185	41	68
NA5185	42	69
NA5185	44	71
NA5185	45	73
NA5185	49	78
NA5185	51	81
NA5185	52	83
NA5185	75	116
NA5185	78	119
NA5185	79	121
PA096	434	686
PA096	434	687
PA096	434	688
PA459	16	26
PA459	25	41
PA459	187	293
PA459	189	295
PA459	190	296
PA459	191	297
PA459	206	319
PA459	207	320
PA459	207	321
PA459	208	322
PA459	208	323
PA459	209	324
PA459	209	325
PA459	210	326
PA459	210	327
PA459	211	328
PA459	212	329
PA459	213	330
PA459	214	331
PA459	214	332
PA459	216	335
PA459	217	336
PA459	218	337

 9		
PA459	219	338
PA459	220	339
PA459	223	344
PA459	260	400
PA459	261	401
PA459	262	402
PA459	262	403
PA459	263	404
PA459	264	405
PA459	266	407
PA459	267	408
PA459	267	409
PA459	268	410
PA459	269	411
PA459	270	412
PA459	271	413
PA459	272	414
PA459	273	415
PA459	274	416
PA459	277	420
PA459	278	421
PA459	279	422
PA459	280	423
PA459	283	427
PA459	284	429
PA459	285	430
PA459	285	431
PA459	286	432
PA459	380	578
PA5041	3	3
PA5041	4	5
PA5041	4	6
PA5041	8	14
PA5041	30	50
PA5041	33	56
PA5041	34	57
PA5041	35	58
PA5041	35	59
PA5041	36	60
PA5041	36	61
PA5041	37	62
PA5041	37	63
PA5041	39	66
PA5041	40	67
PA5041	41	68
PA5041	42	69
PA5041	43	70
PA5041	44	71
PA5041	44	72
PA5041	45	73
PA5041	47	76
PA5041	48	77
PA5041	49	78
PA5041	50	79
PA5041	51	80
PA5041	51	81
PA5041	52	82
PA5041	52	83

 9		
PA5041	53	84
PA5041	53	85
PA5041	54	86
PA5041	55	87
PA5041	55	88
PA5041	56	89
PA5041	56	90
PA5041	57	91
PA5041	57	92
PA5041	71	111
PA5041	74	115
PA5041	76	117
PA5041	77	118
PA5041	78	119
PA5041	79	120
PA5041	79	121
PA5041	80	122
PA5041	81	123
PA5041	82	124
PA5041	82	125
PA5041	95	150
PA5041	96	151
PA5041	97	152
PA5041	98	153
PA5041	99	154
PA5041	100	155
PA5041	100	156
PA5041	101	157
PA5041	197	305
PA5041	198	307
PA5041	201	310
PA5041	202	311
PA5041	203	312
PA5041	204	313
PA5041	204	314
PA5041	205	316
PA5041	205	317
PA5041	206	318
PA5041	222	343
PA5041	224	345
PA5041	225	346
PA5041	226	347
PA5041	227	348
PA5041	228	349
PA5041	229	350
PA5041	230	351
PA5041	231	352
PA5041	232	353
PA5041	232	354
PA5041	233	355
PA5041	233	356
PA5041	235	359
PA5041	235	360
PA5041	236	361
PA5041	237	362
PA5041	238	363
PA5041	239	364
PA5041	240	365

 9		
PA5041	241	366
PA5041	242	367
PA5041	243	368
PA5041	244	369
PA5041	245	370
PA5041	246	371
PA5041	247	372
PA5041	248	373
PA5041	249	374
PA5041	249	375
PA5041	250	376
PA5041	250	377
PA5041	251	378
PA5041	252	379
PA5041	253	380
PA5041	254	382
PA5041	254	383
PA5041	255	384
PA5041	255	385
PA5041	256	386
PA5041	256	387
PA5041	257	392
PA5041	258	394
PA5041	258	395
PA5041	259	397
PA5041	259	398
PA5041	287	433
PA5041	289	435
PA5041	292	440
PA5041	293	441
PA5041	294	442
PA5041	296	444
PA5041	298	446
PA5041	299	447
PA5041	300	450
PA5041	301	451
PA5041	302	455
PA5041	303	456
PA5041	303	457
PA5041	304	458
PA5041	305	460
PA5041	305	461
PA5041	306	462
PA5041	307	463
PA5041	308	464
PA5041	308	465
PA5041	308	466
PA5041	309	467
PA5041	310	472
PA5041	310	473
PA5041	310	474
PA5041	311	475
PA5041	354	534
PA5041	355	535
PA5041	356	538
PA5041	356	539
PA5041	357	540
PA5041	357	541

NUMERICAL PARTS LIST

Nummerische Teilenummernliste • Elenco riferimenti
Liste des références produits

 9		
PA5041	358	542
PA5041	358	543
PA5041	359	544
PA5041	359	545
PA5041	359	546
PA5041	360	547
PA5041	360	548
PA5041	361	549
PA5041	361	550
PA5041	362	551
PA5041	362	552
PA5041	364	555
PA5041	365	557
PA5041	366	558
PA5041	367	559
PA5041	368	560
PA5041	369	562
PA5041	371	567
PA5041	373	569
PA5041	374	570
PA5041	375	571
PA5041	390	589
PA5041	393	595
PA5041	395	598
PA5041	395	599
PA5041	403	612
PA5041	403	613
PA5041	404	614
PA5041	405	615
PA5041	405	617
PA5041	406	619
PA5041	406	620
PA5041	407	622
PA5041	408	625
PA5041	408	626
PA5041	409	628
PA5041	412	635
PA5041	415	639
PA5041	417	642
PA5041	418	644
PA5041	418	645
PA5041	419	646
PA5041	419	647
PA5041	420	648
PA5041	420	649
PA5041	420	650
PA5041	421	651
PA5041	422	654
PA5041	423	655
PA5041	424	656
PA5041	424	657
PA5041	425	658
PA5041	425	659
PA5041	425	660
PA5041	426	663
PA5041	427	664
PA5041	428	665
PA5041	428	666

 9		
PA5041	428	667
PA5041	429	669
PA5041	429	670
PA5041	429	671
PA5041	430	672
PA5041	430	673
PA5041	430	674
PA5041	431	676
PA5041	431	677
PA5041	432	678
PA5041	433	683
PA5041	433	684
PA5041	435	689
TB101	86	135
TB101	86	136
TB107	5	7
TB107	5	8
TB107	6	9
TB107	7	11
TB107	9	16
TB107	10	17
TB107	11	18
TB107	13	21
TB107	13	22
TB107	14	23
TB107	15	24
TB107	17	27
TB107	18	28
TB107	18	29
TB107	19	30
TB107	19	31
TB107	21	34
TB107	22	36
TB107	22	37
TB107	23	38
TB107	24	39
TB108	25	41
TB108	59	96
TB108	106	165
TB108	107	166
TB108	108	168
TB108	109	170
TB108	109	171
TB108	110	172
TB108	111	174
TB108	113	178
TB108	114	181
TB108	115	183
TB108	116	184
TB108	117	186
TB108	117	187
TB108	118	188
TB108	119	189
TB108	119	190
TB108	187	293
TB108	188	294
TB108	189	295
TB108	190	296

 9		
TB108	191	297
TB108	206	319
TB108	207	321
TB108	208	322
TB108	208	323
TB108	210	326
TB108	211	328
TB108	212	329
TB108	213	330
TB108	214	331
TB108	214	332
TB108	215	334
TB108	216	335
TB108	217	336
TB108	218	337
TB108	219	338
TB108	220	339
TB108	221	340
TB108	223	344
TB108	234	357
TB108	234	358
TB108	260	400
TB108	261	401
TB108	262	402
TB108	263	404
TB108	264	405
TB108	265	406
TB108	266	407
TB108	267	408
TB108	268	410
TB108	269	411
TB108	270	412
TB108	271	413
TB108	272	414
TB108	273	415
TB108	274	416
TB108	277	420
TB108	278	421
TB108	279	422
TB108	280	423
TB108	281	424
TB108	281	425
TB108	282	426
TB108	283	427
TB108	284	429
TB108	285	430
TB108	286	432
TB108	376	572
TB108	378	574
TB108	434	686
TB108	434	687
TB131	84	132
TB131	85	133
TB131	85	134
TB131	88	140
TB131	89	141
TB131	90	142
TB131	91	143

 9		
TB131	92	144
TB131	94	146
TB136	84	132
TB136	85	133
TB136	85	134
TB136	88	140
TB136	89	141
TB136	90	142
TB136	91	143
TB136	92	144
TB136	93	145
TB136	94	146
TB207	171	268
TB207	172	269
TB207	173	271
TB207	174	272
TB207	175	273
TB207	177	277
TB207	179	280
TB207	180	282
TB207	181	283
TB207	312	477
TB207	313	479
TB207	314	480
TB207	316	483
TB207	317	484
TB207	318	485
TB207	322	492
TB207	323	493
TB207	324	494
TB207	325	495
TB207	326	496
TB207	327	497
TB207	328	498
TB207	330	500
TB207	331	501
TB207	411	633
TB225	60	99
TB225	61	101
TB225	62	102
TB225	63	103
TB225	64	104
TB225	65	105
TB225	66	106
TB225	67	107
TB225	68	108
TB225	69	109
TB225	70	110
TB225	83	126
TB225	121	194
TB254	25	40
TB254	28	45
TB255	25	40
TB255	28	45
TB283	9	16
TB283	10	17
TB283	11	18
TB283	13	22

 9		
TB283	14	23
TB283	15	24
TB283	16	25
TB283	23	38
TB283	24	39
TB283	27	44
TB293	182	285
TB293	183	286
TB293	184	287
TB293	185	288
TB318	172	269
TB318	181	283
TB318	315	482
TB318	316	483
TB318	322	492
TB318	329	499
TB318	412	634
TB333	321	489
TB333	321	490
TB373	355	536
TB373	413	636
TB373	414	637
TB373	414	638
TB373	415	640
TB373	416	641
TB374	336	511
TB374	337	512
TB374	338	513
TB374	340	515
TB375	184	287
TB375	332	503
TB375	333	504
TB375	338	513
TB384	122	197
TB384	124	200
TB384	124	201
TB384	125	202
TB384	126	203
TB384	127	204
TB384	128	205
TB384	130	210
TB384	131	211
TB384	132	212
TB384	138	218
TB384	140	220
TB384	153	235
TB440	93	145
TB440	94	146
TB441	381	579
TB442	72	112
TB463	186	292
TB463	192	299
TB463	194	301
TB463	219	338
TB463	220	339
TB463	223	344
TB464	224	345
TB464	225	346

 9		
TB464	229	350
TB465	12	19
TB466	1	1
TB466	2	2
TB466	3	3
TB466	4	4
TB466	38	64
TB466	38	65
TB466	41	68
TB466	42	69
TB466	44	71
TB466	45	73
TB466	46	74
TB466	46	75
TB466	49	78
TB467	60	100
TB467	73	113
TB467	73	114
TB467	75	116
TB467	215	333
TB504	101	158
TB504	314	481
TB504	319	486
TB504	320	487
TB504	320	488
TB504	331	502
TB504	410	631
TB504	410	632
TB504	412	634
TB505	222	342
TB505	275	417
TB505	378	575
TB505	379	576
TB505	384	582
TB506	288	434
TB506	377	573
TB506	379	577
TB506	380	578
TB506	382	580
TB506	383	581
TB506	385	584
TB506	387	586
TB506	388	587
TB506	389	588
TB533	134	214
TB533	135	215
TB533	136	216
TB533	141	221
TB533	143	224
TB533	146	228
TB533	148	230
TB533	157	240
TB552	193	300
TB552	195	303
TB552	196	304
TB552	197	305
TB552	198	306
TB552	199	308

 9		
TB552	200	309
TB552	201	310
TB552	202	311
TB552	203	312
TB552	204	313
TB552	204	314
TB552	386	585
TB552	391	590
TB552	391	591
TB552	392	592
TB552	394	597
TB552	396	600
TB552	397	601
TB552	398	602
TB552	399	603
TB552	399	604
TB552	400	605
TB552	401	608
TB552	401	609
TB552	402	610
TB552	408	627
TB553	39	66
TB554	226	347
TB554	227	348
TB554	228	349
TB554	230	351
TB554	231	352
TB554	232	353
TB554	232	354
TB554	233	355
TB554	235	359
TB554	235	360
TB554	236	361
TB554	238	363
TB554	239	364
TB554	240	365
TB554	241	366
TB554	243	368
TB554	245	370
TB554	246	371
TB554	247	372
TB554	248	373
TB554	249	374
TB554	250	376
TB554	250	377
TB554	251	378
TB554	252	379
TB554	253	380
TB554	253	381
TB554	254	383
TB554	255	384
TB554	256	386
TB554	256	387
TB554	257	392
TB554	258	395
TB554	259	397
TB554	390	589
TB555	222	343

 9		
TB555	224	345
TB555	225	346
TB555	229	350
TB555	233	356
TB555	237	362
TB555	242	367
TB555	244	369
TB556	356	538
TB556	356	539
TB556	357	540
TB556	357	541
TB556	358	542
TB556	358	543
TB556	359	545
TB556	360	547
TB556	360	548
TB556	361	549
TB556	361	550
TB556	415	639
TB556	417	642
TB556	418	644
TB556	418	645
TB556	419	646
TB556	419	647
TB556	431	676
TB557	334	506
TB557	339	514
TB557	341	516
TB557	342	517
TB557	343	518
TB557	344	519
TB557	345	520
TB557	346	521
TB557	348	523
TB602	170	265
TB602	171	268
TB602	172	269
TB602	173	271
TB602	174	272
TB602	175	273
TB602	177	277
TB602	178	278
TB602	179	279
TB602	179	280
TB602	180	281
TB602	180	282
TB602	181	283
TB602	312	477
TB602	313	479
TB602	317	484
TB602	323	493
TB602	325	495
TB602	326	496
TB602	327	497
TB602	330	500
TB602	411	633
TB603	86	135
TB603	86	136

NUMERICAL PARTS LIST

Nummerische Teilenummernliste • Elenco riferimenti
Liste des références produits

 9		
TB604	368	561
TB604	430	673
TB604	431	675
TB604	431	676
TB604	431	677
TB604	432	678
TB634	40	67
TB634	43	70
TB634	47	76
TB634	48	77
TB634	50	79
TB634	54	86
TB634	71	111
TB634	74	115
TB634	76	117
TB634	77	118
TB634	78	119
TB634	79	120
TB634	80	122
TB641	95	150
TB641	96	151
TB641	97	152
TB641	98	153
TB641	99	154
TB641	100	155
TB657	123	198
TB657	123	199
TB657	129	209
TB657	133	213
TB657	147	229
TB658	40	67
TB658	43	70
TB658	47	76
TB658	48	77
TB658	50	79
TB658	54	86
TB658	71	111
TB658	74	115
TB658	76	117
TB658	77	118
TB658	78	119
TB658	79	120
TB658	80	122
TB659	134	214
TB659	135	215
TB659	136	216
TB659	141	221
TB659	143	224
TB659	146	228
TB659	148	230
TB659	157	240
TB680	102	159
TB680	103	160
TB680	104	161
TB680	105	162
TB680	105	163
TB680	106	164
TB680	139	219

 9		
TB680	142	223
TB680	144	226
TB680	149	231
TB680	150	232
TB680	151	233
TB680	152	234
TB680	154	237
TB680	155	238
TB680	156	239
TB680	158	243
TB680	160	247
TB680	161	249
TB680	162	250
TB680	163	252
TB680	163	253
TB680	164	254
TB680	165	256
TB680	165	257
TB680	166	258
TB680	167	259
TB680	168	260
TB680	169	261
TB680	290	436
TB680	290	437
TB680	291	439
TB680	295	443
TB680	297	445
TB680	299	448
TB680	300	449
TB680	301	452
TB680	302	454
TB680	304	458
TB680	304	459
TB726	32	54
TB726	33	55
TB738	95	150
TB738	96	151
TB738	97	152
TB738	98	153
TB738	99	154
TB738	100	155
TB743	289	435
TB743	291	438
TB743	292	440
TB743	293	441
TB743	294	442
TB743	296	444
TB743	298	446
TB743	299	447
TB743	300	450
TB743	301	451
TB743	302	455
TB743	303	456
TB743	303	457
TB743	305	460
TB745	393	595
TB745	395	598
TB753	393	595

 9		
TB753	395	599
TB753	403	612
TB753	403	613
TB753	404	614
TB753	405	615
TB753	405	617
TB753	406	619
TB753	406	620
TB753	406	621
TB753	407	622
TB753	408	626
TB754	420	649
TB754	420	650
TB759	369	563
TB759	420	648
TB760	371	567
TB760	424	656
TB760	425	658
TB785	182	285
TB785	183	286
TB785	185	288
TB785	332	503
TB785	333	504
TB785	333	505
TB785	334	506
TB785	335	508
TB785	335	509
TB785	336	510
TB785	336	511
TB785	337	512
TB785	339	514
TB785	340	515
TB785	341	516
TB785	342	517
TB785	343	518
TB785	344	519
TB785	345	520
TB785	346	521
TB785	348	523
TB797	349	525
TB797	350	526
TB797	350	527
TB797	353	531
TB797	353	532
TBK016	25	41
TBK016	59	96
TBK016	106	165
TBK016	107	166
TBK016	108	168
TBK016	109	170
TBK016	109	171
TBK016	110	172
TBK016	111	174
TBK016	113	178
TBK016	114	181
TBK016	115	183
TBK016	116	184
TBK016	117	186

 9		
TBK016	117	187
TBK016	118	188
TBK016	119	189
TBK016	119	190
TBK016	187	293
TBK016	188	294
TBK016	189	295
TBK016	190	296
TBK016	191	297
TBK016	206	319
TBK016	207	321
TBK016	208	322
TBK016	208	323
TBK016	210	326
TBK016	211	328
TBK016	212	329
TBK016	213	330
TBK016	214	331
TBK016	214	332
TBK016	215	334
TBK016	216	335
TBK016	217	336
TBK016	218	337
TBK016	219	338
TBK016	220	339
TBK016	221	340
TBK016	223	344
TBK016	234	357
TBK016	234	358
TBK016	260	400
TBK016	261	401
TBK016	262	402
TBK016	263	404
TBK016	264	405
TBK016	265	406
TBK016	266	407
TBK016	267	408
TBK016	268	410
TBK016	269	411
TBK016	270	412
TBK016	271	413
TBK016	272	414
TBK016	273	415
TBK016	274	416
TBK016	277	420
TBK016	278	421
TBK016	279	422
TBK016	280	423
TBK016	281	424
TBK016	281	425
TBK016	282	426
TBK016	283	427
TBK016	284	429
TBK016	285	430
TBK016	286	432
TBK016	376	572
TBK016	378	574
TBK016	434	686

			9
TBK016	434	687	
TBK018	60	99	
TBK018	61	101	
TBK018	62	102	
TBK018	63	103	
TBK018	64	104	
TBK018	65	105	
TBK018	66	106	
TBK018	67	107	
TBK018	68	108	
TBK018	69	109	
TBK018	70	110	
TBK018	83	126	
TBK018	121	194	
TBK024	124	201	
TBK024	125	202	
TBK024	127	204	
TBK024	128	205	
TBK025	124	201	
TBK025	125	202	
TBK025	127	204	
TBK025	128	205	
TBK026	124	200	
TBK026	126	203	
TBK026	130	210	
TBK026	131	211	
TBK026	132	212	
TBK026	138	218	
TBK026	140	220	
TBK026	153	235	
TBK044	84	132	
TBK044	85	133	
TBK044	85	134	
TBK044	88	140	
TBK044	89	141	
TBK044	90	142	
TBK044	91	143	
TBK044	92	144	
TBK044	94	146	
TBK048	171	268	
TBK048	173	271	
TBK048	175	273	
TBK048	177	277	
TBK048	179	280	
TBK048	180	282	
TBK048	312	477	
TBK048	313	479	
TBK048	314	480	
TBK048	316	483	
TBK048	317	484	
TBK048	318	485	
TBK048	323	493	
TBK048	324	494	
TBK048	325	495	
TBK048	326	496	
TBK048	327	497	
TBK048	328	498	
TBK048	330	500	

			9
TBK048	331	501	
TBK048	411	633	
TBK066	275	417	
TBK066	378	575	
TBK066	379	576	
TBK066	384	582	
TBK076	288	434	
TBK076	377	573	
TBK076	385	584	
TBK076	387	586	
TBK076	388	587	
TBK076	389	588	
TBK086	186	292	
TBK086	194	301	
TBK086	219	338	
TBK086	220	339	
TBK086	223	344	
TBK087	1	1	
TBK087	2	2	
TBK087	3	3	
TBK087	4	4	
TBK087	38	64	
TBK087	38	65	
TBK087	41	68	
TBK087	42	69	
TBK087	44	71	
TBK087	45	73	
TBK087	46	74	
TBK087	46	75	
TBK087	49	78	
TBK088	60	100	
TBK088	73	113	
TBK088	73	114	
TBK088	75	116	
TBK088	215	333	
TBK093	129	209	
TBK100	193	300	
TBK100	195	303	
TBK100	196	304	
TBK100	197	305	
TBK100	198	306	
TBK100	199	308	
TBK100	200	309	
TBK100	201	310	
TBK100	202	311	
TBK100	203	312	
TBK100	204	313	
TBK100	204	314	
TBK100	386	585	
TBK100	391	590	
TBK100	391	591	
TBK100	392	592	
TBK100	394	597	
TBK100	396	600	
TBK100	397	601	
TBK100	398	602	
TBK100	399	603	
TBK100	399	604	

			9
TBK100	400	605	
TBK100	401	608	
TBK100	401	609	
TBK100	402	610	
TBK100	408	627	
TBK101	226	347	
TBK101	227	348	
TBK101	228	349	
TBK101	230	351	
TBK101	231	352	
TBK101	233	355	
TBK101	235	359	
TBK101	235	360	
TBK101	236	361	
TBK101	238	363	
TBK101	239	364	
TBK101	240	365	
TBK101	243	368	
TBK101	246	371	
TBK101	247	372	
TBK101	248	373	
TBK101	250	376	
TBK101	252	379	
TBK101	253	381	
TBK107	134	214	
TBK107	135	215	
TBK107	136	216	
TBK107	141	221	
TBK107	143	224	
TBK107	146	228	
TBK107	148	230	
TBK107	157	240	
TBK109	379	577	
TBK109	380	578	
TBK109	382	580	
TBK109	383	581	
TBK112	123	198	
TBK112	123	199	
TBK112	133	213	
TBK112	147	229	
TBK115	226	347	
TBK115	227	348	
TBK115	228	349	
TBK115	231	352	
TBK115	232	354	
TBK115	233	355	
TBK115	235	360	
TBK115	236	361	
TBK115	238	363	
TBK115	239	364	
TBK115	241	366	
TBK115	246	371	
TBK115	247	372	
TBK115	248	373	
TBK115	251	378	
TBK115	253	380	
TBK115	253	381	
TBK115	254	383	

			9
TBK115	256	387	
TBK115	258	395	
TBK115	259	397	
TBK119	126	203	
TBK225	102	159	
TBK225	103	160	
TBK225	104	161	
TBK225	139	219	
TBK225	142	223	
TBK225	144	226	
TBK225	149	231	
TBK225	150	232	
TBK225	151	233	
TBK225	152	234	
TBK225	156	239	
TBK225	161	249	
TBK246	40	67	
TBK246	43	70	
TBK246	47	76	
TBK246	48	77	
TBK246	50	79	
TBK246	71	111	
TBK246	74	115	
TBK246	76	117	
TBK246	77	118	
TBK246	78	119	
TBK246	79	120	
TBK246	80	122	
TBK262	289	435	
TBK262	292	440	
TBK262	293	441	
TBK262	294	442	
TBK262	298	446	
TBK262	299	447	
TBK262	300	450	
TBK262	301	451	
TBK262	302	455	
TBK262	303	456	
TBK262	303	457	
TBK262	305	460	
TBK263	40	67	
TBK263	43	70	
TBK263	48	77	
TBK263	50	79	
TBK263	54	86	
TBK263	71	111	
TBK263	74	115	
TBK263	76	117	
TBK263	77	118	
TBK263	78	119	
TBK263	80	122	
TBK269	102	159	
TBK269	103	160	
TBK269	104	161	
TBK269	139	219	
TBK269	142	223	
TBK269	144	226	
TBK269	149	231	

NUMERICAL PARTS LIST

Nummerische Teilenummernliste • Elenco riferimenti
Liste des références produits

				9
TBK269	150	232		
TBK269	151	233		
TBK269	156	239		
TBK269	161	249		
TBK270	102	159		
TBK270	103	160		
TBK270	104	161		
TBK270	105	162		
TBK270	105	163		
TBK270	106	164		
TBK270	142	223		
TBK270	144	226		
TBK270	149	231		
TBK270	150	232		
TBK270	151	233		
TBK270	152	234		
TBK270	154	237		
TBK270	155	238		
TBK270	156	239		
TBK270	158	243		
TBK270	160	247		
TBK270	161	249		
TBK270	162	250		
TBK270	163	252		
TBK270	163	253		
TBK270	164	254		
TBK270	165	256		
TBK270	165	257		
TBK270	166	258		
TBK270	167	259		
TBK270	169	261		
TBK270	290	436		
TBK270	290	437		
TBK270	291	439		
TBK270	295	443		
TBK270	297	445		
TBK270	299	448		
TBK270	300	449		
TBK270	301	452		
TBK270	302	454		
TBK270	304	458		
TBK270	304	459		
TBK272	134	214		
TBK272	135	215		
TBK272	136	216		
TBK272	141	221		
TBK272	143	224		
TBK272	146	228		
TBK272	148	230		
TBK272	157	240		
TBK285	410	632		
TBK285	412	634		
TBK305	122	197		
TBK309	192	299		
TBK320	1	1		
TBK320	2	2		
TBK320	3	3		
TBK320	4	4		

				9
TBK320	41	68		
TBK320	42	69		
TBK330	222	343		
TBK330	224	345		
TBK330	225	346		
TBK330	229	350		
TBK330	233	356		
TBK330	237	362		
TBK330	242	367		
TBK330	244	369		
TBK331	222	343		
TBK331	224	345		
TBK331	225	346		
TBK331	229	350		
TBK331	233	356		
TBK331	237	362		
TBK331	242	367		
TBK331	244	369		
TBK332	222	343		
TBK332	224	345		
TBK332	225	346		
TBK333	222	343		
TBK333	224	345		
TBK333	225	346		
TBK335	137	217		
TBK341	232	353		
TBK341	249	374		
TBK341	250	376		
TBK341	250	377		
TBK341	252	379		
TBK341	256	386		
TBK341	390	589		
TBK348	95	150		
TBK348	96	151		
TBK348	97	152		
TBK348	98	153		
TBK348	99	154		
TBK348	100	155		
TBK353	356	538		
TBK353	356	539		
TBK353	357	540		
TBK353	357	541		
TBK353	358	542		
TBK353	358	543		
TBK353	359	545		
TBK353	360	547		
TBK353	360	548		
TBK353	361	549		
TBK353	361	550		
TBK353	415	639		
TBK353	417	642		
TBK353	418	644		
TBK353	418	645		
TBK353	419	646		
TBK353	419	647		
TBK354	95	150		
TBK354	96	151		
TBK354	97	152		

				9
TBK354	98	153		
TBK354	99	154		
TBK354	100	155		
TBK357	356	538		
TBK357	356	539		
TBK357	357	540		
TBK357	357	541		
TBK357	358	542		
TBK357	358	543		
TBK357	359	545		
TBK357	360	547		
TBK357	360	548		
TBK357	361	549		
TBK357	361	550		
TBK357	415	639		
TBK357	417	642		
TBK357	418	644		
TBK357	418	645		
TBK357	419	646		
TBK357	419	647		
TTP4	95	150		
TTP4	96	151		
TTP4	98	153		
TTP4	100	155		
V33815	426	661		
V33815	426	662		
V33815	432	680		
V33815	432	681		
V33817	426	661		
V33818	58	95		
V33818	95	149		
V34700	113	178		
V34700	115	183		
V35292	60	99		
V35292	63	103		
V90179	62	102		
V90179	63	103		
V90179	121	194		
V90180	62	102		
V90180	63	103		
V90180	84	132		
V90180	90	142		
V90180	92	144		
V90321	84	132		
V90321	90	142		
V90321	92	144		
V90323	5	7		
V90323	6	9		
V90323	6	10		
V90323	8	13		
V90323	17	27		
V90323	18	28		
V90324	5	7		
V90324	6	9		
V90324	6	10		
V90324	7	11		
V90324	7	12		
V90324	17	27		

				9
V90324	18	28		
V90324	20	32		
V90325	5	7		
V90325	6	9		
V90325	6	10		
V90325	7	11		
V90325	7	12		
V90325	17	27		
V90325	18	28		
V90325	20	32		
V90326	12	20		
V90326	18	29		
V90326	21	34		
V90327	12	20		
V90327	18	29		
V90327	21	34		
V91030	170	265		
V91030	171	268		
V91030	173	271		
V91030	175	273		
V91030	176	275		
V91030	177	277		
V91030	178	278		
V91030	179	279		
V91030	180	282		
V91030	207	321		
V91030	208	323		
V91030	210	326		
V91030	210	327		
V91030	260	400		
V91030	261	401		
V91030	263	404		
V91030	266	407		
V91030	273	415		
V91030	313	479		
V91030	314	480		
V91030	317	484		
V91034	170	265		
V91034	171	268		
V91034	173	271		
V91034	175	273		
V91034	176	275		
V91034	177	277		
V91034	178	278		
V91034	179	279		
V91034	180	282		
V91034	210	326		
V91034	210	327		
V91034	260	400		
V91034	261	401		
V91034	266	407		
V91034	273	415		
V91173	64	104		
V91173	68	108		
V91174	64	104		
V91174	68	108		
V91174	85	133		
V91174	90	142		

 9		
V91174	91	143
V91174	92	144
V91174	121	194
V91332	9	16
V91332	11	18
V91332	13	22
V91332	14	23
V91332	15	24
V91332	16	25
V91332	22	36
V91332	23	38
V91332	24	39
V91332	27	44
V91332	87	139
V91334	86	135
V91334	124	201
V91334	125	202
V91334	127	204
V91334	128	205
V91334	129	209
V91334	133	213
V91334	182	285
V91334	183	286
V91334	184	287
V91334	185	288
V91334	336	511
V91334	337	512
V91334	338	513
V91335	65	105
V91335	66	106
V91335	69	109
V91336	85	134
V91336	88	140
V91336	91	143
V91336	93	145
V91336	127	204
V91336	128	205
V91337	86	135
V91337	86	136
V91337	89	141
V91337	92	144
V91337	94	146
V91337	124	201
V91337	125	202
V91337	129	209
V91337	133	213
V91337	182	285
V91337	183	286
V91337	184	287
V91337	185	288
V91338	187	293
V91338	189	295
V91338	190	296
V91338	207	320
V91338	207	321
V91338	208	323
V91338	210	327
V91338	211	328
V91338	212	329
V91338	213	330
V91338	214	331
V91338	214	332
V91338	215	334
V91338	216	335
V91338	210	327
V91338	211	328

 9		
V91338	212	329
V91338	213	330
V91338	214	331
V91338	218	337
V91338	219	338
V91338	220	339
V91338	221	340
V91338	221	341
V91338	223	344
V91338	262	402
V91338	264	405
V91338	267	408
V91338	267	409
V91338	269	411
V91338	270	412
V91338	272	414
V91338	273	415
V91338	274	416
V91338	277	420
V91338	279	422
V91338	281	425
V91338	284	429
V91338	285	430
V91338	286	432
V91338	312	477
V91338	313	479
V91338	314	480
V91338	317	484
V91338	318	485
V91338	322	492
V91338	323	493
V91338	324	494
V91338	325	495
V91338	326	496
V91338	327	497
V91338	328	498
V91338	329	499
V91338	331	501
V91338	387	586
V91340	187	293
V91340	188	294
V91340	189	295
V91340	190	296
V91340	191	297
V91340	194	301
V91340	207	320
V91340	207	321
V91340	208	323
V91340	210	327
V91340	211	328
V91340	212	329
V91340	213	330
V91340	214	331
V91340	214	332
V91340	215	334
V91340	216	335
V91340	217	336
V91340	218	337

 9		
V91340	219	338
V91340	220	339
V91340	221	340
V91340	221	341
V91340	223	344
V91340	262	402
V91340	263	404
V91340	264	405
V91340	265	406
V91340	267	408
V91340	267	409
V91340	268	410
V91340	269	411
V91340	270	412
V91340	272	414
V91340	273	415
V91340	274	416
V91340	276	418
V91340	277	420
V91340	278	421
V91340	279	422
V91340	280	423
V91340	281	424
V91340	281	425
V91340	282	426
V91340	283	427
V91340	283	428
V91340	284	429
V91340	285	430
V91340	286	432
V91340	288	434
V91340	312	477
V91340	313	479
V91340	314	480
V91340	315	482
V91340	316	483
V91340	317	484
V91340	318	485
V91340	322	492
V91340	323	493
V91340	324	494
V91340	325	495
V91340	326	496
V91340	327	497
V91340	328	498
V91340	329	499
V91340	331	501
V91340	332	503
V91340	333	504
V91340	333	505
V91340	335	508
V91340	335	509
V91340	336	510
V91340	376	572
V91340	377	573
V91340	378	574
V91340	379	577
V91340	380	578

 9		
V91340	382	580
V91340	383	581
V91340	387	586
V91340	409	630
V91340	410	632
V91340	411	633
V91340	412	634
V91340	413	636
V91340	414	637
V91340	414	638
V91340	415	640
V91340	416	641
V91343	85	133
V91343	91	143
V91343	121	194
V91367	61	101
V91367	64	104
V91367	67	107
V91367	69	109
V91367	70	110
V91368	61	101
V91368	65	105
V91368	66	106
V91368	69	109
V91368	88	140
V91368	89	141
V91368	92	144
V91368	94	146
V91368	133	213
V91372	275	417
V91372	314	481
V91372	319	486
V91372	320	487
V91372	320	488
V91372	321	489
V91372	321	490
V91372	368	561
V91372	378	575
V91372	379	576
V91372	410	631
V91372	431	675
V91407	188	294
V91407	191	297
V91407	194	301
V91407	215	334
V91407	216	335
V91407	217	336
V91407	263	404
V91407	265	406
V91407	268	410
V91407	273	415
V91407	276	418
V91407	278	421
V91407	280	423
V91407	281	424
V91407	282	426
V91407	283	427
V91407	283	428

NUMERICAL PARTS LIST

Numerische Teilenummernliste • Elenco riferimenti
Liste des références produits

 9		
V91407	288	434
V91407	315	482
V91407	316	483
V91407	332	503
V91407	333	504
V91407	333	505
V91407	335	508
V91407	335	509
V91407	336	510
V91407	376	572
V91407	377	573
V91407	378	574
V91407	379	577
V91407	380	578
V91407	382	580
V91407	383	581
V91407	409	630
V91407	410	632
V91407	411	633
V91407	412	634
V91407	413	636
V91407	414	637
V91407	414	638
V91407	415	640
V91407	416	641
V91409	61	101
V91409	64	104
V91409	67	107
V91409	70	110
V91409	85	134
V91409	88	140
V91409	91	143
V91409	93	145
V91415	16	26
V91415	25	41
V91415	26	42
V91415	26	43
V91415	58	93
V91415	58	94
V91415	59	96
V91415	59	97
V91415	59	98
V91415	106	165
V91415	108	168
V91415	109	171
V91415	110	172
V91415	111	175
V91415	112	177
V91415	113	178
V91415	116	184
V91415	117	187
V91415	121	195
V91416	275	417
V91416	314	481
V91416	319	486
V91416	320	487
V91416	320	488
V91416	321	489

 9		
V91416	321	490
V91416	331	502
V91416	368	561
V91416	378	575
V91416	379	576
V91416	410	631
V91416	431	675
V91473	9	16
V91473	10	17
V91473	11	18
V91473	13	22
V91473	14	23
V91473	15	24
V91473	16	25
V91473	22	36
V91473	23	38
V91473	24	39
V91473	25	40
V91473	27	44
V91473	28	45
V91475	25	40
V91475	28	45
V94010	126	203
V94010	334	506
V94010	339	514
V94010	340	515
V94010	341	516
V94010	342	517
V94010	343	518
V94010	344	519
V94010	345	520
V94010	346	521
V94010	348	523
V94010	349	525
V94010	350	526
V94010	353	531
V94011	126	203
V94011	334	506
V94011	336	511
V94011	337	512
V94011	338	513
V94011	339	514
V94011	340	515
V94011	341	516
V94011	342	517
V94011	343	518
V94011	344	519
V94011	345	520
V94011	346	521
V94011	348	523
V94011	349	525
V94011	350	526
V94011	353	531
V94079	186	292
V94079	192	299
V94079	193	300
V94079	194	301
V94079	195	303

 9		
V94079	196	304
V94079	198	306
V94079	199	308
V94079	200	309
V94079	385	584
V94079	386	585
V94079	389	588
V94079	391	590
V94079	392	592
V94079	392	593
V94079	393	594
V94079	394	596
V94079	394	597
V94079	396	600
V94079	397	601
V94079	398	602
V94079	399	603
V94079	399	604
V94079	400	605
V94079	400	606
V94079	401	609
V94079	402	610
V94079	402	611
V94079	407	623
V94079	413	636
V94080	186	292
V94080	192	299
V94080	193	300
V94080	194	301
V94080	195	303
V94080	196	304
V94080	198	306
V94080	199	308
V94080	200	309
V94080	219	338
V94080	223	344
V94080	234	357
V94080	234	358
V94080	385	584
V94080	386	585
V94080	389	588
V94080	391	590
V94080	392	592
V94080	392	593
V94080	393	594
V94080	394	596
V94080	394	597
V94080	396	600
V94080	397	601
V94080	398	602
V94080	399	603
V94080	399	604
V94080	400	605
V94080	400	606
V94080	401	609
V94080	402	610
V94080	402	611
V94080	407	623

 9		
V94081	222	343
V94081	224	345
V94081	225	346
V94081	226	347
V94081	227	348
V94081	228	349
V94081	229	350
V94081	230	351
V94081	231	352
V94081	232	354
V94081	233	356
V94081	235	360
V94081	236	361
V94081	237	362
V94081	238	363
V94081	239	364
V94081	240	365
V94081	241	366
V94081	242	367
V94081	243	368
V94081	244	369
V94081	245	370
V94081	246	371
V94081	247	372
V94081	248	373
V94081	249	374
V94081	249	375
V94081	251	378
V94081	252	379
V94081	253	380
V94081	254	382
V94081	254	383
V94081	255	384
V94081	256	386
V94081	257	390
V94081	258	395
V94081	356	538
V94081	356	539
V94081	357	540
V94081	357	541
V94081	358	542
V94081	358	543
V94081	359	545
V94081	360	547
V94081	360	548
V94081	361	550
V94081	362	551
V94081	390	589
V94081	415	639
V94081	417	642
V94081	418	644
V94081	418	645
V94081	419	646
V94081	419	647
V94081	420	648
V94081	420	649
V94081	420	650
V94082	224	345

 9		
V94082	227	348
V94082	228	349
V94082	229	350
V94082	231	352
V94082	232	354
V94082	233	356
V94082	236	361
V94082	238	363
V94082	239	364
V94082	241	366
V94082	244	369
V94082	245	370
V94082	246	371
V94082	247	372
V94082	248	373
V94082	251	378
V94082	252	379
V94082	253	380
V94082	254	382
V94082	254	383
V94082	255	384
V94082	256	386
V94082	257	390
V94082	258	395
V94082	356	538
V94082	356	539
V94082	358	542
V94082	360	547
V94082	360	548
V94082	361	550
V94082	362	551
V94083	222	343
V94083	225	346
V94083	226	347
V94083	230	351
V94083	235	360
V94083	237	362
V94083	240	365
V94083	242	367
V94083	243	368
V94083	249	374
V94083	249	375
V94083	357	540
V94083	357	541
V94083	358	543
V94083	359	545
V94083	390	589
V94083	415	639
V94083	417	642
V94083	418	644
V94083	418	645
V94083	419	646
V94083	419	647
V94083	420	648
V94083	420	649
V94083	420	650
V94084	131	211
V94084	132	212



 9		
V94084	135	215
V94084	136	216
V94084	137	217
V94084	138	218
V94084	140	220
V94084	141	221
V94084	145	227
V94084	146	228
V94084	153	235
V94085	131	211
V94085	132	212
V94085	135	215
V94085	136	216
V94085	137	217
V94085	138	218
V94085	140	220
V94085	141	221
V94085	145	227
V94085	146	228
V94085	153	235
V94108	125	202
V94108	129	209
V94108	159	244
V94109	125	202
V94109	127	204
V94109	129	209
V94109	159	244
V94110	322	491
V94110	381	579
V94110	384	582
V94110	431	676
V94110	431	677
V94110	432	678
V94111	381	579
V94111	384	582
V94111	431	676
V94111	431	677
V94111	432	678
V94112	122	197
V94112	123	198
V94112	123	199
V94112	124	200
V94112	130	210
V94112	134	214
V94112	143	224
V94112	145	227
V94112	147	229
V94112	148	230
V94112	157	240
V94113	122	197
V94113	123	198
V94113	123	199
V94113	124	200
V94113	130	210
V94113	134	214
V94113	143	224
V94113	147	229
V94113	148	230



 9		
V94113	157	240
V94114	38	65
V94114	44	71
V94114	46	74
V94114	46	75
V94114	60	100
V94114	72	112
V94114	73	113
V94114	73	114
V94114	75	116
V94115	38	64
V94115	38	65
V94115	44	71
V94115	46	74
V94115	46	75
V94115	60	100
V94115	72	112
V94115	73	113
V94115	73	114
V94115	75	116
V94116	34	57
V94116	36	60
V94116	36	61
V94116	40	67
V94116	43	70
V94116	44	72
V94116	48	77
V94116	50	79
V94116	51	80
V94116	52	82
V94116	53	84
V94116	53	85
V94116	54	86
V94116	55	87
V94116	57	91
V94116	71	111
V94116	74	115
V94116	76	117
V94116	77	118
V94116	78	119
V94116	79	120
V94116	80	122
V94116	81	123
V94116	82	124
V94117	34	57
V94117	36	60
V94117	36	61
V94117	40	67
V94117	43	70
V94117	44	72
V94117	47	76
V94117	48	77
V94117	50	79
V94117	51	80
V94117	52	82
V94117	53	84
V94117	53	85
V94117	54	86



 9		
V94117	55	87
V94117	57	91
V94117	71	111
V94117	74	115
V94117	76	117
V94117	77	118
V94117	78	119
V94117	79	120
V94117	80	122
V94117	81	123
V94117	82	124
V94145	363	553
V94145	365	556
V94145	372	568
V94146	363	553
V94146	365	556
V94147	102	159
V94147	139	219
V94147	142	223
V94147	144	226
V94147	149	231
V94147	150	232
V94147	151	233
V94147	152	234
V94147	155	238
V94147	163	252
V94147	167	259
V94147	168	260
V94147	169	261
V94147	347	522
V94147	369	564
V94148	102	159
V94148	139	219
V94148	142	223
V94148	144	226
V94148	149	231
V94148	150	232
V94148	151	233
V94148	152	234
V94148	155	238
V94148	163	252
V94148	168	260
V94148	169	261
V94148	347	522
V94148	369	564
V94149	1	1
V94149	4	4
V94197	1	1
V94197	4	4
V94212	72	112
V94247	39	66
V94248	39	66
V94251	12	19
V94301	320	487
V94303	200	309
V94303	389	588
V94303	392	593
V94303	393	594



NUMERICAL PARTS LIST

Nummerische Teilenummernliste • Elenco riferimenti
Liste des références produits

		
V94303	394	596
V94303	394	597
V94303	396	600
V94303	398	602
V94303	400	606
V94303	401	609
V94303	402	610
V94303	402	611
V94303	407	623
V94303	413	636
V94304	263	404
V94304	271	413
V94305	9	16
V94305	10	17
V94305	15	24
V94305	23	38
V94305	27	44
V94306	354	533
V94306	372	568
V94307	388	587
V94308	12	19
V94308	27	44
V94309	12	19
V94309	27	44
V94311	38	64
V94374	354	533
V94374	363	553
V94374	364	554
V94374	365	556
V94404	41	68
V94404	42	69
V94404	45	73
V94404	49	78
V94405	33	56
V94405	35	58
V94405	35	59
V94405	41	68
V94405	42	69
V94405	45	73
V94405	49	78
V94406	354	534
V94406	355	535
V94406	364	555
V94406	365	557
V94406	366	558
V94406	367	559
V94406	368	560
V94406	428	665
V94406	428	667
V94406	429	668
V94407	354	534
V94407	355	535
V94407	364	555
V94407	365	557
V94407	366	558
V94407	367	559
V94407	368	560
V94407	428	665

		
V94407	428	667
V94407	429	668
V94409	130	210
V94410	130	210
V94411	426	661
V94411	426	662
V94411	432	680
V94411	432	681
V94415	347	522
V94415	369	564
V94416	32	54
V94417	32	54
V94418	2	2
V94418	28	46
V94418	29	47
V94418	29	48
V94418	31	52
V94418	31	53
V94419	2	2
V94419	28	46
V94419	29	47
V94419	31	52
V94419	31	53
V94420	9	15
V94421	9	15
V94421	220	339
V94423	95	150
V94423	96	151
V94424	197	305
V94424	201	310
V94424	202	311
V94424	203	312
V94424	204	313
V94424	206	318
V94425	197	305
V94425	201	310
V94425	202	311
V94425	203	312
V94425	204	313
V94425	206	318
V94450	219	338
V94450	223	344
V94450	234	357
V94450	234	358
V94546	435	690
V94546	435	692
V94546	438	701
V94546	438	702
V94546	439	703
V94546	439	704
V94547	182	285
V94547	184	287
V94547	336	511
V94547	337	512
V94547	338	513
V94547	345	520
V94547	346	521
V94547	349	525

		
V94547	350	526
V94547	353	531
V94548	436	696
V94548	437	699
V94548	438	700
V94549	436	696
V94549	437	699
V94549	438	700
V94550	64	104
V94580	13	22
V94580	14	23
V94580	23	38
V94580	87	139
V94584	388	587
V94641	354	534
V94641	364	555
V94641	365	557
V94641	366	558
V94641	367	559
V94641	368	560
V94641	428	665
V94641	428	667
V94641	429	668
V94642	354	534
V94642	364	555
V94642	365	557
V94642	366	558
V94642	367	559
V94642	368	560
V94642	428	665
V94642	428	667
V94642	429	668
V94644	3	3
V94645	3	3
V94645	305	461
V94645	306	462
V94645	307	463
V94645	308	464
V94645	308	465
V94645	308	466
V94645	309	467
V94645	309	468
V94645	310	472
V94645	310	473
V94645	310	474
V94645	311	475
V94645	311	476
V94646	33	56
V94646	35	58
V94646	35	59
V94646	79	121
V94647	47	76
V94647	74	115
V94649	102	159
V94649	103	160
V94649	104	161
V94649	105	162
V94649	105	163

		
V94649	106	164
V94649	154	237
V94649	156	239
V94649	160	247
V94649	161	249
V94649	162	250
V94649	164	254
V94649	165	256
V94649	165	257
V94649	166	258
V94649	290	436
V94649	290	437
V94649	291	439
V94649	295	443
V94649	297	445
V94649	301	452
V94649	302	454
V94649	334	507
V94649	352	530
V94649	370	565
V94649	370	566
V94650	102	159
V94650	103	160
V94650	104	161
V94650	105	162
V94650	105	163
V94650	106	164
V94650	154	237
V94650	156	239
V94650	160	247
V94650	161	249
V94650	162	250
V94650	164	254
V94650	165	256
V94650	165	257
V94650	166	258
V94650	167	259
V94650	290	436
V94650	290	437
V94650	291	439
V94650	295	443
V94650	297	445
V94650	301	452
V94650	302	454
V94650	334	507
V94650	352	530
V94650	370	565
V94650	370	566
V94651	32	54
V94651	33	55
V94652	32	54
V94652	33	55
V94653	95	150
V94653	96	151
V94691	393	595
V94691	395	598
V94691	404	614
V94691	405	615

 9		
V94691	407	622
V94691	421	651
V94691	429	671
V94691	430	672
V94691	433	683
V94692	287	433
V94692	359	546
V94692	373	569
V94692	375	571
V94692	393	595
V94692	395	598
V94692	395	599
V94692	403	613
V94692	404	614
V94692	405	615
V94692	406	619
V94692	406	620
V94692	407	622
V94692	408	625
V94692	408	626
V94692	409	628
V94692	412	635
V94692	421	651
V94692	425	660
V94692	429	671
V94692	430	672
V94692	430	674
V94692	432	679
V94692	433	683
V94697	289	435
V94697	292	440
V94697	293	441
V94697	294	442
V94697	296	444
V94697	298	446
V94697	299	447
V94697	300	450
V94697	301	451
V94698	289	435
V94698	292	440
V94698	293	441
V94698	296	444
V94698	298	446
V94698	300	450
V94704	287	433
V94704	359	546
V94704	373	569
V94704	375	571
V94704	393	595
V94704	395	598
V94704	395	599
V94704	403	613
V94704	404	614
V94704	405	615
V94704	406	620
V94704	407	622
V94704	408	625
V94704	408	626

 9		
V94704	409	628
V94704	412	635
V94704	421	651
V94704	425	660
V94704	429	671
V94704	430	672
V94704	430	674
V94704	432	679
V94704	433	683
V94715	10	17
V94715	12	19
V94721	354	533
V94727	127	204
V94727	159	244
V94772	90	142
V95085	427	664
V95085	433	684
V95085	435	689
V95086	427	664
V95086	433	684
V95086	435	689
V95087	158	243
V95087	299	448
V95087	300	449
V95088	158	243
V95088	299	448
V95088	300	449
V95097	359	546
V95098	359	546
V95099	305	461
V95099	306	462
V95099	307	463
V95099	308	464
V95099	308	465
V95099	309	467
V95099	309	468
V95099	310	472
V98007	289	435
V98007	292	440
V98007	293	441
V98007	296	444
V98007	298	446
V98007	300	450
V98008	97	152
V98008	98	153
V98008	99	154
V98008	100	155
V98009	97	152
V98009	98	153
V98009	99	154
V98009	100	155
V98010	371	567
V98010	422	654
V98010	423	655
V98010	424	656
V98011	371	567
V98011	422	654
V98011	423	655

 9		
V98011	424	656
V98097	289	435
V98097	292	440
V98097	293	441
V98097	294	442
V98097	296	444
V98097	298	446
V98097	299	447
V98097	300	450
V98097	301	451
VAG686B	421	653
VAG92061B	5	7
VAG92061B	6	9
VAG92061B	6	10
VAG92061B	7	11
VAG92061B	7	12
VAG92061B	8	13
VAG92061B	9	16
VAG92061B	10	17
VAG92061B	11	18
VAG92061B	13	22
VAG92061B	14	23
VAG92061B	15	24
VAG92061B	16	25
VAG92061B	17	27
VAG92061B	18	28
VAG92061B	20	32
VAG92061B	22	36
VAG92061B	23	38
VAG92061B	24	39
VAG92061B	25	40
VAG92061B	26	42
VAG92061B	26	43
VAG92061B	27	44
VAG92061B	28	45
VAG92061B	58	93
VAG92061B	59	96
VAG92061B	59	97
VAG92061B	59	98
VAG92061B	60	99
VAG92061B	61	101
VAG92061B	62	102
VAG92061B	63	103
VAG92061B	64	104
VAG92061B	65	105
VAG92061B	66	106
VAG92061B	67	107
VAG92061B	68	108
VAG92061B	69	109
VAG92061B	70	110
VAG92061B	84	132
VAG92061B	85	133
VAG92061B	85	134
VAG92061B	86	135
VAG92061B	86	136
VAG92061B	87	139
VAG92061B	88	140
VAG92061B	89	141

 9		
VAG92061B	90	142
VAG92061B	91	143
VAG92061B	92	144
VAG92061B	93	145
VAG92061B	94	146
VAG92061B	106	165
VAG92061B	107	166
VAG92061B	108	168
VAG92061B	109	171
VAG92061B	110	172
VAG92061B	111	175
VAG92061B	113	178
VAG92061B	114	181
VAG92061B	116	185
VAG92061B	117	187
VAG92061B	119	189
VAG92061B	121	194
VAG92061B	121	195
VAG92061B	124	201
VAG92061B	125	202
VAG92061B	126	203
VAG92061B	127	204
VAG92061B	128	205
VAG92061B	129	209
VAG92061B	130	210
VAG92061B	133	213
VAG92061B	170	265
VAG92061B	171	268
VAG92061B	173	271
VAG92061B	175	273
VAG92061B	176	275
VAG92061B	177	277
VAG92061B	178	278
VAG92061B	179	279
VAG92061B	180	282
VAG92061B	182	285
VAG92061B	183	286
VAG92061B	184	287
VAG92061B	185	288
VAG92061B	187	293
VAG92061B	188	294
VAG92061B	189	295
VAG92061B	190	296
VAG92061B	191	297
VAG92061B	194	301
VAG92061B	207	320
VAG92061B	207	321
VAG92061B	208	323
VAG92061B	210	326
VAG92061B	211	328
VAG92061B	212	329
VAG92061B	213	330
VAG92061B	214	331
VAG92061B	214	332
VAG92061B	217	336
VAG92061B	218	337
VAG92061B	219	338
VAG92061B	220	339

NUMERICAL PARTS LIST

Nummerische Teilenummernliste • Elenco riferimenti
Liste des références produits

		9
VAG92061B	221	340
VAG92061B	221	341
VAG92061B	223	344
VAG92061B	262	402
VAG92061B	263	404
VAG92061B	264	405
VAG92061B	265	406
VAG92061B	266	407
VAG92061B	267	408
VAG92061B	267	409
VAG92061B	269	411
VAG92061B	272	414
VAG92061B	273	415
VAG92061B	274	416
VAG92061B	277	420
VAG92061B	278	421
VAG92061B	279	422
VAG92061B	280	423
VAG92061B	281	424
VAG92061B	281	425
VAG92061B	282	426
VAG92061B	283	427
VAG92061B	283	428
VAG92061B	284	429
VAG92061B	285	430
VAG92061B	286	432
VAG92061B	288	434
VAG92061B	312	477
VAG92061B	313	479
VAG92061B	314	480
VAG92061B	315	482
VAG92061B	316	483
VAG92061B	317	484
VAG92061B	318	485
VAG92061B	323	493
VAG92061B	324	494
VAG92061B	326	496
VAG92061B	327	497
VAG92061B	328	498
VAG92061B	329	499
VAG92061B	330	500
VAG92061B	332	503
VAG92061B	333	504
VAG92061B	333	505
VAG92061B	334	506
VAG92061B	335	508
VAG92061B	335	509
VAG92061B	336	510
VAG92061B	336	511
VAG92061B	337	512
VAG92061B	338	513
VAG92061B	339	514
VAG92061B	340	515
VAG92061B	341	516
VAG92061B	342	517
VAG92061B	343	518
VAG92061B	344	519
VAG92061B	345	520

		9
VAG92061B	346	521
VAG92061B	348	523
VAG92061B	349	525
VAG92061B	350	526
VAG92061B	353	531
VAG92061B	377	573
VAG92061B	378	574
VAG92061B	379	577
VAG92061B	380	578
VAG92061B	382	580
VAG92061B	383	581
VAG92061B	387	586
VAG92061B	409	630
VAG92061B	410	632
VAG92061B	411	633
VAG92061B	412	634
VAG92061B	413	636
VAG92061B	414	637
VAG92061B	414	638
VAG92061B	415	640
VAG92061B	416	641
VAG92105B	12	20
VAG92105B	18	29
VAG92105B	21	34
VAG92105B	25	41
VAG92105B	106	165
VAG92105B	107	166
VAG92105B	108	168
VAG92105B	112	177
VAG92105B	116	184
VAG92105B	116	185
VAG92105B	117	187
VAG92105B	119	189
VAG92105B	121	194
VAG92105B	170	265
VAG92105B	171	268
VAG92105B	173	271
VAG92105B	175	273
VAG92105B	176	275
VAG92105B	178	278
VAG92105B	179	279
VAG92105B	180	282
VAG92105B	181	283
VAG92105B	207	320
VAG92105B	207	321
VAG92105B	208	323
VAG92105B	210	326
VAG92105B	210	327
VAG92105B	212	329
VAG92105B	214	331
VAG92105B	260	400
VAG92105B	261	401
VAG92105B	262	402
VAG92105B	263	404
VAG92105B	266	407
VAG92105B	270	412
VAG92105B	271	413
VAG92105B	272	414

		9
VAG92105B	273	415
VAG92105B	274	416
VAG92105B	276	418
VAG92105B	277	420
VAG92105B	278	421
VAG92105B	280	423
VAG92105B	281	425
VAG92105B	282	426
VAG92105B	284	429
VAG92105B	286	432
VAG92105B	312	477
VAG92105B	313	479
VAG92105B	314	480
VAG92105B	317	484
VAG92105B	318	485
VAG92105B	322	492
VAG92105B	323	493
VAG92105B	325	495
VAG92105B	327	497
VAG92105B	331	501
VAG92105B	376	572
VAG92220B	435	690
VAG92220B	436	696
VAG92220B	437	699
VAG92220B	438	701
VAG92220B	438	702
VAG92220B	439	703
VAG92220B	439	704
VAG92382B	275	417
VAG92382B	321	490
VAG96041B	1	1
VAG96041B	2	2
VAG96041B	4	4
VAG96041B	31	52
VAG96041B	32	54
VAG96041B	33	55
VAG96041B	72	112
VAG96041B	73	113
VAG96041B	102	159
VAG96041B	103	160
VAG96041B	104	161
VAG96041B	105	162
VAG96041B	105	163
VAG96041B	106	164
VAG96041B	122	197
VAG96041B	123	198
VAG96041B	123	199
VAG96041B	124	200
VAG96041B	125	202
VAG96041B	127	204
VAG96041B	129	209
VAG96041B	130	210
VAG96041B	131	211
VAG96041B	132	212
VAG96041B	134	214
VAG96041B	135	215
VAG96041B	136	216
VAG96041B	137	217

		9
VAG96041B	138	218
VAG96041B	139	219
VAG96041B	140	220
VAG96041B	141	221
VAG96041B	142	223
VAG96041B	143	224
VAG96041B	144	226
VAG96041B	145	227
VAG96041B	146	228
VAG96041B	147	229
VAG96041B	148	230
VAG96041B	149	231
VAG96041B	150	232
VAG96041B	151	233
VAG96041B	152	234
VAG96041B	153	235
VAG96041B	154	237
VAG96041B	155	238
VAG96041B	156	239
VAG96041B	157	240
VAG96041B	159	244
VAG96041B	160	247
VAG96041B	161	249
VAG96041B	162	250
VAG96041B	163	252
VAG96041B	166	258
VAG96041B	167	259
VAG96041B	168	260
VAG96041B	169	261
VAG96041B	186	292
VAG96041B	192	299
VAG96041B	193	300
VAG96041B	194	301
VAG96041B	195	303
VAG96041B	196	304
VAG96041B	198	306
VAG96041B	199	308
VAG96041B	200	309
VAG96041B	219	338
VAG96041B	223	344
VAG96041B	234	357
VAG96041B	234	358
VAG96041B	290	436
VAG96041B	290	437
VAG96041B	291	439
VAG96041B	295	443
VAG96041B	297	445
VAG96041B	301	452
VAG96041B	302	454
VAG96041B	334	507
VAG96041B	347	522
VAG96041B	352	530
VAG96041B	365	556
VAG96041B	369	564
VAG96041B	381	579
VAG96041B	384	582
VAG96041B	385	584
VAG96041B	386	585

 9		
VAG96041B	388	587
VAG96041B	389	588
VAG96041B	391	590
VAG96041B	392	592
VAG96041B	392	593
VAG96041B	393	594
VAG96041B	394	596
VAG96041B	394	597
VAG96041B	396	600
VAG96041B	397	601
VAG96041B	398	602
VAG96041B	399	603
VAG96041B	399	604
VAG96041B	400	605
VAG96041B	400	606
VAG96041B	401	609
VAG96041B	402	610
VAG96041B	407	623
VAG96062B	1	1
VAG96062B	2	2
VAG96062B	4	4
VAG96062B	31	53
VAG96062B	38	64
VAG96062B	38	65
VAG96062B	44	71
VAG96062B	46	74
VAG96062B	46	75
VAG96062B	60	100
VAG96062B	73	114
VAG96062B	75	116
VAG96073B	3	3
VAG96073B	33	56
VAG96073B	34	57
VAG96073B	35	58
VAG96073B	35	59
VAG96073B	36	60
VAG96073B	36	61
VAG96073B	39	66
VAG96073B	40	67
VAG96073B	41	68
VAG96073B	42	69
VAG96073B	43	70
VAG96073B	44	72
VAG96073B	45	73
VAG96073B	47	76
VAG96073B	48	77
VAG96073B	49	78
VAG96073B	50	79
VAG96073B	51	80
VAG96073B	52	82
VAG96073B	53	84
VAG96073B	53	85
VAG96073B	54	86
VAG96073B	55	87
VAG96073B	57	91
VAG96073B	71	111
VAG96073B	74	115
VAG96073B	76	117

 9		
VAG96073B	77	118
VAG96073B	78	119
VAG96073B	79	120
VAG96073B	80	122
VAG96073B	81	123
VAG96073B	82	124
VAG96073B	197	305
VAG96073B	201	310
VAG96073B	202	311
VAG96073B	204	313
VAG96073B	222	343
VAG96073B	224	345
VAG96073B	225	346
VAG96073B	226	347
VAG96073B	227	348
VAG96073B	228	349
VAG96073B	229	350
VAG96073B	231	352
VAG96073B	232	354
VAG96073B	233	356
VAG96073B	235	360
VAG96073B	236	361
VAG96073B	237	362
VAG96073B	238	363
VAG96073B	239	364
VAG96073B	241	366
VAG96073B	242	367
VAG96073B	244	369
VAG96073B	245	370
VAG96073B	246	371
VAG96073B	247	372
VAG96073B	248	373
VAG96073B	249	374
VAG96073B	249	375
VAG96073B	251	378
VAG96073B	252	379
VAG96073B	253	380
VAG96073B	254	382
VAG96073B	254	383
VAG96073B	255	384
VAG96073B	256	386
VAG96073B	257	390
VAG96073B	258	395
VAG96073B	356	538
VAG96073B	356	539
VAG96073B	357	540
VAG96073B	358	542
VAG96073B	358	543
VAG96073B	359	546
VAG96073B	360	547
VAG96073B	360	548
VAG96073B	361	550
VAG96073B	362	551
VAG96073B	365	557
VAG96073B	366	558
VAG96073B	390	589
VAG96073B	393	595
VAG96073B	395	598

 9		
VAG96073B	404	614
VAG96073B	405	615
VAG96073B	406	620
VAG96073B	407	622
VAG96073B	408	626
VAG96073B	415	639
VAG96073B	417	642
VAG96073B	418	644
VAG96073B	418	645
VAG96073B	419	646
VAG96073B	419	647
VAG96073B	420	648
VAG96073B	420	650
VAG96157B	314	481
VAG96157B	319	486
VAG96157B	320	487
VAG96157B	320	488
VAG96157B	321	489
VAG96157B	322	491
VAG96157B	331	502
VAG96157B	354	533
VAG96157B	363	553
VAG96157B	364	554
VAG96157B	368	561
VAG96157B	372	568
VAG96157B	378	575
VAG96157B	379	576
VAG96157B	410	631
VAG96157B	431	675
VAG96161B	10	17
VAG96161B	12	19
VAG96161B	27	44
VAG96161B	72	112
VAG96228B	436	693
VAG96228B	436	696
VAG96228B	437	699
VAG96228B	438	700
VAG96228B	438	701
VAG96228B	438	702
VAG96228B	439	703
VAG96228B	439	704
VAG96237B	95	150
VAG96237B	97	152
VAG96237B	98	153
VAG96237B	99	154
VAG96237B	100	155
VAG96237B	105	162
VAG96237B	289	435
VAG96237B	292	440
VAG96237B	293	441
VAG96237B	294	442
VAG96237B	296	444
VAG96237B	298	446
VAG96237B	299	447
VAG96237B	300	450
VAG96237B	301	451
VAG96237B	306	462
VAG96237B	307	463

 9		
VAG96237B	308	464
VAG96237B	308	465
VAG96237B	308	466
VAG96237B	309	467
VAG96237B	310	472
VAG96237B	310	474
VAG96265B	95	150
VAG96265B	97	152
VAG96265B	98	153
VAG96265B	99	154
VAG96265B	100	155
VAG96265B	101	157
VAG96265B	105	162

OE		OE		OE		OE		OE	
038 103 483D	JM5203	045 109 119D	TB726	050 109 309A	FOL143	058 109 309A	FOL141	060 198 025A	HL461
038 103 483E	JM5120	045 109 119E	TB726	050 109 309H	FOL143	058 109 309B	FOL133	060 507 55 70	HR646
038 109 101AH	CAM904	045 109 119L	TB726	050 109 309J	FOL143	058 109 309E	FOL141	066 103 483F	JM5234
038 109 101E	CAM670	045 109 601	V94416	050 198 012A	DM360	058 109 309F	FOL133	066 133 237A	JD5927
038 109 101K	CAM671	045 109 601	V94651	050 198 012B	CY942	058 109 309J	FOL133	068 103 383AT	BH710
038 109 101R	CAM672	045 109 611	V94417	050 198 01B	CY942	058 109 309K	FOL141	068 103 383BA	BH720
038 109 101R	CAM914	045 109 611	V94652	051 103 483A	JP024	058 109 601C	V94081	068 103 383BB	BH730
038 109 119	TB533	045 128 717	JD5278	051 103 483E	JP024	058 109 611E	V94082	068 103 383CE	BT020
038 109 119B	TB533	045 129 717	JD5278	051 109 021	CAM739	058 109 611M	V94083	068 103 383CP	BN940
038 109 119D	TB533	045 253 039	JD5279	051 109 021C	CAM739	058 129 717B	JD604	068 103 383CP	BT470
038 109 119M	TB659	046 103 383A	BM540	051 109 022	CAM740	058 129 717C	JD5820	068 103 383CQ	BN950
038 109 119M	TB797	046 103 383B	BM540	051 109 022B	CAM740	058 129 717D	JD6005	068 103 383CR	BN960
038 109 119R	TB797	046 103 383J	BM540	051 109 601B	V94110	058 198 012	CY970	068 103 383DB	BN940
038 109 309A	FOL114	046 103 483A	JN967	051 109 611B	V94111	058 198 025A	HL732	068 103 383DC	BN960
038 109 309C	FOL175	046 109 101K	CAM442	051 198 012A	DT812	058 198 119	TBK330	068 103 383DD	BN950
038 109 601B	V94147	046 109 601G	V94547	051 198 012C	DM367	058 198 119A	TBK332	068 103 383DE	BN940
038 109 601B	V94416	046 109 601J	V94547	051 198 012D	DZ910	058 198 479	TBK331	068 103 383DF	BN950
038 109 601E	V94649	046 109 611F	V94011	051 198 025	HL731	058 198 479A	TBK333	068 103 383DG	BN960
038 109 601F	V95087	046 130 113	TB374	051 198 119	TBK086	058 253 039G	JD605	068 103 383E	BN070
038 109 611B	V94148	046 130 113A	TB374	052 103 383AA	BL560	059 103 383AA	AC5970	068 103 383EF	BT020
038 109 611E	V94650	046 130 113C	TB374	052 103 383AB	BL560	059 103 383AB	AC5980	068 103 383EH	BN940
038 109 611F	V94415	046 198 012A	DW860	052 103 383G	BL560	059 103 383CM	AG8880	068 103 383EJ	BN950
038 109 611G	V95088	046 198 012A	DW861	052 103 383H	BL560	059 103 383CN	AG8860	068 103 383EK	BN960
038 198 012	DZ010	046 198 113	TB374	052 103 383N	BL560	059 103 383CP	AG8890	068 103 383ES	BH710
038 198 119	TBK225	047 103 383E	BT580	052 103 383Q	BL560	059 103 383CQ	AG8900	068 103 383ET	BH720
038 198 119A	TBK270	047 103 383F	BT580	052 103 383R	BL560	059 103 383CR	AG8870	068 103 383FA	BH730
038 198 119C	TBK270	047 103 383J	BT580	052 103 383T	BL560	059 103 383CS	AG8910	068 103 383FD	BN070
038 198 119D	TBK107	047 103 483	JM5285	052 109 119	TB107	059 103 383T	AC5960	068 103 383FE	BT020
038 198 119E	TBK272	047 109 601F	V94420	052 109 611A	V90325	059 103 384	HBS265	068 103 383FM	BT020
039 198 012C	DL491	047 109 611B	V94421	052 129 589	JC259	059 103 483M	JM7047	068 103 383H	BN070
03C 103 383D	AG8850	047 109 611D	V94419	052 198 012AB	DL571	059 103 483N	JM7046	068 103 383L	BH710
03C 103 383R	AH5960	047 129 717E	JD5812	052 198 012AF	DL561	059 109 021BP	CAM700	068 103 383P	BH710
03C 129 717C	JD5809	047 198 601D	V94418	052 198 012E	DL561	059 109 021BQ	CAM701	068 103 383Q	BH720
03C 253 039A	JD5814	047 253 039H	JD5849	052 198 012G	DL571	059 109 021K	CAM700	068 103 383R	BH730
03D 103 383G	AG8840	047 253 039J	JD5818	053 103 383	BT810	059 109 021L	CAM701	068 103 384A	HBS018
03D 129 717A	JD5807	047 253 050	JD5817	053 103 383A	BT810	059 109 021P	CAM701	068 103 384A	HBS021
03D 129 717B	JD5808	047 253 050A	JD5936	053 103 383B	BT810	059 109 021Q	CAM700	068 103 384A	HBS022
03D 253 039B	JD5819	048 103 383B	BT810	053 109 611	V91340	059 109 022BD	CAM702	068 109 101L	CAM393
03E 103 383F	AF5990	048 103 383D	BY750	053 198 012A	DT813	059 109 022K	CAM703	068 109 119E	BT225
03E 129 717B	JD5811	048 109 119C	TB441	053 198 012B	DT813	059 109 022L	CAM702	068 109 601	V35292
03E 253 039	JD5816	048 109 119D	TB506	053 198 012C	DY751	059 109 022P	CAM702	068 109 601C	V90179
03G 103 383A	AG8800	048 109 119G	TB441	053 198 012D	DY752	059 109 022Q	CAM703	068 109 601D	V91173
03G 103 383AA	AG8970	048 109 601A	V91407	053 198 012E	DT813	059 109 075E	TPP4	068 109 601L	V91335
03G 103 383AB	AG8800	048 109 601E	V94450	054 103 383	BT820	059 109 119B	TB738	068 109 601N	V91367
03G 103 383AC	AG8960	048 109 611A	V91340	054 103 383G	BT820	059 109 119C	TB555	068 109 611C	V90180
03G 103 383J	AG9630	048 109 611B	V94080	054 109 119A	TB504	059 109 119D	TB760	068 109 611D	V91174
03G 103 384	HBS364	048 129 717A	JD483	054 109 119G	TB504	059 109 444	FOL159	068 109 611L	V91368
03G 103 483	JM7031	048 129 717B	JD482	055 253 115A	JE117	059 109 521B	FOL158	068 109 611M	V94550
03G 103 483B	JM7029	048 129 717D	JD5235	056 103 489A	HL457	059 109 521C	FOL158	068 129 717A	JC478
03G 103 483D	JM7107	048 198 012	DT814	056 109 119A	TB108	059 109 521E	FOL158	068 129 717E	JC243
03G 103 483F	JM7113	048 198 012A	DT815	056 109 611A	V34700	059 109 601B	V94653	069 103 383CE	BT470
03G 109 601A	V98007	048 198 012B	DT81C	056 129 717	JC478	059 109 601F	V98008	069 103 383CP	BT470
03G 109 601B	V94697	048 198 012C	DY750	056 198 012	DL580	059 109 601G	V98010	069 109 101P	CAM630
03G 109 611B	V94698	048 198 012D	DY750	056 198 025	HL456	059 109 611B	V94423	069 109 119A	TB131
03G 109 611D	V98097	048 198 383D	BY750	056 198 025A	HL457	059 109 611G	V98009	069 109 601	V94772
03G 129 717B	JD5806	049 103 383	BG870	056 198 025B	HL456	059 109 611H	V98011	069 109 601C	V90321
03G 198 119	TBK262	049 103 383A	BG870	056 198 119	TBK016	059 109 611K	V98011	069 109 601D	V91343
03G 253 039A	JD5992	049 103 383D	BG870	057 103 384A	HBS361	059 109 611M	V98011	069 109 601F	V91337
03H 109 611D	V95086	049 103 383E	BG870	057 103 384A	HBS470	059 129 717G	JD5810	069 109 601H	V91336
03L 109 601	V95099	049 103 383K	BG870	057 109 119G	TB759	059 129 717J	JD5872	069 109 611	V91409
043 109 612	V94411	049 103 384B	HBS024	058 103 383K	AY970	059 130 113	TB641	069 130 113A	TB136
044 103 383D	BW790	049 103 384B	HBS043	058 103 383M	AY970	059 130 113A	TB641	069 198 012B	DL491
044 198 012	DW790	049 103 385	HBS029	058 103 383Q	AY970	059 198 001A	CC5960	069 198 012C	DL491
045 103 383C	AC5190	049 103 385A	HBS043	058 103 385A	HBS171	059 198 025	HM5223	069 198 015C	DL491
045 103 383D	AC5200	049 103 419	VAG92105B	058 103 415	VAG96073B	059 198 119	TBK348	069 198 015D	DL491
045 103 383E	AC5210	049 109 601K	V91415	058 109 021B	CAM743	059 198 119A	TBK348	06A 103 383F	AY970
045 103 383F	AD5650	049 129 717A	JC478	058 109 022B	CAM744	059 198 119B	TBK348	06A 103 383AH	AY970
045 103 383G	AD5660	050 103 383	AY940	058 109 119A	TB464	059 253 039B	JD5851	06A 103 383AN	AB5370
045 103 383H	AD5670	050 103 383A	BZ910	058 109 119B	TB555	060 198 012	DM541	06A 103 383F	AY970
045 103 483C	JM7032	050 103 383B	BZ910	058 109 119C	TB555	060 198 012A	DM541	06A 103 383L	AB5370
045 109 101C	CAM673	050 109 101A	CAM913	058 109 119D	TB464	060 198 025	HL461	06A 103 384C	HBS246

OE INTERCHANGE

OE-Vergleichsliste • Intercambio con OE
Références croisées 1ère Monte

OE	OE	OE	OE
06A 103 385A	HBS268	074 103 383AJ	AF5310
06A 103 483C	JM5103	074 103 383M	AF5340
06A 109 119B	TB552	074 103 383N	AF5350
06A 109 119C	TB552	074 103 383P	AF5360
06A 109 119D	TB552	074 103 383R	AF5310
06A 129 717	JD5291	074 103 383T	AF5330
06A 129 717D	LA5204	074 103 469F	JM7077
06A 129 717F	JD5292	074 103 483	JN915
06A 129 717J	JD5314	074 103 483B	JN915
06A 133 398D	JD607	074 109 101B	CAM630
06A 133 398F	JD5340	074 109 101E	CAM442
06A 198 012	CY980	074 109 101J	CAM442
06A 198 012A	CY971	074 109 119	TB318
06A 198 119	TBK100	074 109 119F	TB375
06A 198 119A	TBK101	074 109 119H	TB375
06A 198 119B	TBK115	074 109 611	V91334
06A 253 039L	JD5293	074 129 717	JD312
06B 103 383AE	AC5220	074 130 113	TB293
06B 103 383AF	AG8810	074 198 012	DW830
06B 103 383H	AC5220	074 198 012A	CA5470
06B 103 383T	AC5220	074 253 039	JD5948
06B 103 385 (x10)	HBS510	075 103 383E	BZ930
06B 103 483H	JM7030	075 109 119A	TB131
06B 103 483L	JM5205	075 109 119B	TB131
06B 109 101G	CAM745	075 109 119E	TB131
06B 109 119A	TB554	075 198 012A	DM660
06B 109 119B	TB554	076 103 383C	AH5970
06B 109 119F	TB554	076 103 383C	AH5980
06B 109 601D	V94424	076 103 383E	AH5990
06B 109 611C	V94425	076 109 119A	TB797
06B 129 717A	JD5341	077 109 119B	TB604
06B 198 119	TBK115	077 109 119D	TB604
06B 198 119A	TBK341	077 109 119E	TB604
06B 253 039E	JD5813	078 103 383E	AY061
06C 109 119C	TB754	078 103 383K	BZ960
06D 103 383L	AG9600	078 103 385A	HBS064
06D 103 383M	AG9600	078 103 385F	HBS064
06D 103 385	HBS363	078 103 385K	HBS270
06D 103 385D	HBS476	078 103 483C	JM5166
06D 103 483D	JM7048	078 103 483L	JM5166
06D 103 483E	JM7078	078 109 119A	TB373
06D 109 119	TB745	078 109 119C	TB556
06D 109 119B	TB753	078 109 119D	TB373
06D 109 601K	V94691	078 109 119G	TB556
06D 109 601M	V95098	078 109 119H	TB556
06D 109 611H	V94692	078 109 119J	TB556
06D 109 611K	V94692	078 109 601B	V94079
06D 109 611K	V94704	078 109 611C	V94303
06D 109 611L	V94692	078 198 012D	DZ960
06D 129 717D	JD5873	078 198 025	HM5224
06E 103 385 (x16)	HBS512	078 198 119	TBK357
06E 109 601H	V95097	078 198 479	TBK353
06J 103 383G	AH5380	078 903 119A	TB373
070 103 383J	AG8920	078 903 137H	TB556
070 103 383K	AG8820	079 109 601B	V95098
070 103 383L	AG8930	092 890 7002	PA096
070 103 384 (x12)	HBS509	102 990 0810	HBS150
070 109 101P	CAM730	11 34 9 059 172	HR662
070 109 101P	CAM916	11 34 9 063 193	HR791
070 109 101Q	CAM912	11 34 9 065 438	HR817
070 129 717	JD5955	111 198 005	FV480
070 129 717A	JD5956	111 198 007	FV500
070 129 717B	JD5957	111 251 261B	JB373
071 103 383	AG7800	111 251 261C	JB373
072 129 717A	JC146	113 109 612	V33818
072 198 012	DM660	113 198 011	FV480
072 198 012A	DM660	113 198 101	CV480
073 103 483A	JN849	113 198 101A	CV480
073 109 119C	TB101	114 029 012	HBS173
073 198 012A	DM700	114 095 840	JD5766
074 103 383AG	AF5330	155 253 115	JE5076
		161 253 115	JE160
		161 253 115A	JE160
		171 253 115	JE160
		171 253 117	JE160
		191 253 115F	JE160
		1J0 253 115D	JF211
		1L0 198 002A	TBK026
		311 109 601	V33815
		311 109 612A	V33817
		431 253 115A	JE689
		432 253 115A	JE689
		433 253 115	JE138
		533 253 115C	JF205
		600 001 130	DT580
		605 050 00 58	HR822
		6E0 253 115	JE5036
		6K0 198 001A	TBK087
		6K0 198 001B	TBK086
		6K0 198 001D	TBK088
		6K0 198 002	TBK016
		6K0 198 004	TBK076
		6K0 198 005	TBK024
		6L0 198 002	TBK119
		811 253 115B	JE904
		841 253 115B	JE904
		843 253 115	JE904
		948 103 384B	HBS024
		A271 141 08 80	JD5835
		A6A 109 119C	TB552
		N90 131 602	JD236
		VAG KD 046	TBK285
		VAG KD 076	TBK044
		WHT 000 912 (x10)	HBS518



	F (mm)	G (mm)	E (mm)	
VAG96265B	5.980	10.210	42.000	VG3
VAG96237B	6.015	10.070	42.000	VG3
VAG96073B	6.015	11.059	36.000	VG5
VAG96161B	7.000	11.800	36.500	VG1
VAG96157B	7.000	12.000	38.000	VG5
VAG92382B	7.000	12.050	38.000	VG3
VAG96041B	7.000	12.080	36.500	VG4
VAG96062B	7.020	15.000	33.000	VG4
VAG92105B	7.990	12.080	42.300	VG4
VAG92061B	8.000	12.080	36.700	VG4
VAG92220B	8.980	13.060	66.500	VG1
VAG96228B	9.015	13.049	66.500	VG5



VG1



VG3

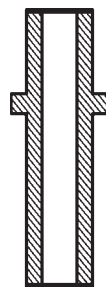













VG4









VG5

CAMSHAFT OIL SEALS

Nockenwellen-Öldichtungen • Paraoli albero a camme
 Bagues d'étanchéité d'arbre à cames
 Retenes de aceite del árbol de levas
 Uszczelnienia olejowe wałka rozrzadu
 Сальники распределительного вала • ممانع تسرب الزيت لعمود الكامنة

						
27.00 x	42.00 x	8.00	FPM	827S RD W		NA5180
32.00 x	42.00 x	6.00 / 7.00	FPM	829S RD W		NA5185
32.00 x	47.00 x	10.00	FPM	827S DD W		NA5001
32.00 x	47.00 x	10.00	PTFE / ACM	827S RD W		NA5124
35.00 x	48.00 x	10.00	PTFE	827S RD W		NA5106

	Component Reference				QTY		
HBS018	HB002-BA	M12	1.75	115.00	10	Ⓐ	
HBS021	HB002-BA	M12	1.75	115.00	12	Ⓐ	
HBS022	HB002-BA	M12	1.75	115.00	14	Ⓐ	
HBS024	HB001-BA	M11	1.50	95.00	12	Ⓐ	
HBS028	HB003-BA	M11	1.50	147.00	10	Ⓐ	
HBS029	HB122-BA	M11	1.50	98.00	10	Ⓐ	✓
HBS043	HB001-BA	M11	1.50	95.00	10	Ⓐ	
HBS064	HB112-BA	M11	1.50	137.00	16	Ⓐ	
HBS068	HB099-BA	M10	1.50	95.00	14	Ⓔ	
HBS075	HB109-BA	M11	1.50	110.00	10	Ⓐ	
HBS077	HB155-BA	M11	1.50	119.00	10	Ⓐ	
HBS077	HB156-BA	M11	1.50	85.00	7	Ⓐ	
HBS077	HB157-BA	M11	1.50	144.00	3	Ⓐ	
HBS150	HB078-BA	M12	1.75	102.00	10	Ⓐ	
HBS171	HB254-BA	M11	1.50	101.00	10	Ⓐ	
HBS173	HB285-BA	M11	1.50	168.00	7	Ⓑ	
HBS173	HB516-BA	M11	1.50	133.00	1	Ⓑ	
HBS173	HB517-BA	M11	1.50	182.00	2	Ⓑ	
HBS246	HB241-BA	M10	1.50	120.00	10	Ⓚ	
HBS249	HB244-BA	M9	1.25	138.00	10	Ⓐ	
HBS264	HB261-BA	M12	1.75	172.00	8	Ⓐ	
HBS265	HB487-BA	M12	1.50	155.00	16	Ⓐ	
HBS268	HB264-BA	M10	1.50	120.00	10	Ⓚ	
HBS269	HB265-BA	M11	1.50	141.50	12	Ⓐ	
HBS270	HB266-BA	M11	1.50	133.00	16	Ⓚ	
HBS300	HB261-BA	M12	1.75	166.00	10	Ⓐ	
HBS311	HB002-BA	M12	1.75	115.00	8	Ⓐ	
HBS316	HB313-BA	M9	1.25	97.00	10	Ⓐ	
HBS360	HB342-BA	M11	1.50	142.00	10	Ⓐ	
HBS361	HB343-BA	M12	1.50	159.00	16	Ⓐ	
HBS362	HB344-BA	M9	1.25	162.00	10	Ⓐ	
HBS363	HB345-BA	M10	1.50	122.00	10	Ⓔ	
HBS364	HB346-BA	M12	1.75	149.00	10	Ⓐ	
HBS461	HB155-BA	M11	1.50	119.00	9	Ⓐ	
HBS461	HB156-BA	M11	1.50	85.00	6	Ⓐ	
HBS461	HB157-BA	M11	1.50	144.00	3	Ⓐ	
HBS470	HB343-BA	M12	1.50	159.00	20	Ⓐ	
HBS471	HB244-BA	M9	1.25	138.00	8	Ⓐ	
HBS476	HB436-BA	M10	1.50	117.00	10	Ⓚ	
HBS479	HB344-BA	M9	1.25	162.00	8	Ⓐ	
HBS509	HB460-BA	M12	1.50	149.50	12	Ⓐ	
HBS510	HB461-BA	M10	1.50	131.00	10	Ⓚ	
HBS512	HB463BA	M10	1.50	172.00	16	Ⓒ	
HBS513	HB464-BA	M11	1.50	100.00	12	Ⓐ	
HBS513	HB465-BA	M11	1.50	131.00	6	Ⓐ	
HBS518	HB542-BA	M9	1.25	105.00	10	Ⓐ	
HBS526	HB464-BA	M11	1.50	100.00	13	Ⓐ	
HBS526	HB465-BA	M11	1.50	131.00	7	Ⓐ	



Ⓐ Male hex

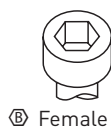

Ⓑ Female hex



Ⓒ Male star



Ⓓ Female star



Ⓔ Male torx



Ⓕ Female torx



Ⓖ Hexagon Collar

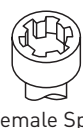

Ⓚ Female Splined (Ribe-CV®)*

*Ribe-CV® is a registered trademark of Richard Bergner GmbH & Co.

1	With Heat Shield
2	Equipment Variant: GT
3	Fitting Position: Left and right
4	Diameter [mm]: 78.5
5	To cylinder 2 - 3
6	To cylinder 4 - 5
8	Equipment Variant: GT, Equipment Variant: 60 PS/hp
9	Centering Diameter [mm]: 8.5
10	Centering Diameter [mm]: 6.5
11	Mechanical
12	Bolt / Nut Version: without plain washer
13	Engine Block Material: Cast Steel
14	With shaft oil seal
15	Without shaft seal
16	Chilled Cast Iron
17	Induction Hardened Cast Iron
19	A = 28.100, D = 50.100
20	A = 28.670, D = 49.670
21	A = 30.500, D = 52.200
22	A = 30.600, D = 51.500
23	A = 30.600, D = 52.600
24	A = 31.700, D = 53.400
25	A = 31.900, D = 62.000
26	A = 35.300, D = 66.500
27	A = 39.400
28	A = 39.550, D = 60.550
29	A = 41.450
30	A = 44.100, D = 70.100
31	A = 45.430
32	A = 45.500, D = 69.500
33	A = 45.550, D = 68.550
34	A = 45.550, D = 71.550
35	Conrod gap 27.50mm
36	For newer design straight injection nozzle
37	For side angled injection nozzle
38	No oil-jet cut out
39	OE 03L 107 065G, Gen 1 engine only
40	OE 03L 107 065S, Gen 2 engine only
41	Phosphated
42	Piston Chamber Volume [ccm] 20.70
43	Piston Chamber Volume [ccm] 22.85
44	Piston Chamber Volume [ccm] 23.30
45	Piston Chamber Volume [ccm] 23.54
46	Piston Chamber Volume [ccm] 23.60
47	Piston Chamber Volume [ccm] 23.75
48	Piston Chamber Volume [ccm] 24.05
49	Piston Chamber Volume [ccm] 24.50
50	Piston Chamber Volume [ccm] 24.60
51	Pistons to be replaced in Engine Sets only
52	Steel
53	To cylinder 1
54	To cylinder 1 - 3
55	To cylinder 1 - 2
56	To cylinder 2
57	To cylinder 3
58	To cylinder 3 - 5
59	To cylinder 3 - 4
60	To cylinder 4
61	To cylinder 4 - 6
62	With recesses on crankshaft side
63	A = 31.90 D = 62.20
64	"SPUTTER" upper half bearing
65	G-149
66	For cracked connecting rod
67	For reworked cylinder heads only
68	The O.E. procedure requires that the intermediate shaft bushings are machined once fitted to optimize clearance, centring, and alignment. We therefore recommend our 'semi' bushings and to follow the same procedure.

Deutsch

1	Mit Hitzeschild
2	Ausstattungsvariante: GT
3	Einbauort: beidseitig
4	Durchmesser [mm]: 78.5
5	zu Motorzylinder: 2 + 3
6	zu Motorzylinder: 4 + 5
8	Ausstattungsvariante: GT, Ausstattungsvariante: 60 PS/hp
9	Zentrierdurchmessers [mm]: 8.5
10	Zentrierdurchmessers [mm]: 6.5
11	Mechanical
12	Schrauben-/Mutterausführung: ohne Unterlegscheibe
13	Motorblockmaterial: Stahlguß
14	mit Wellendichtring
15	ohne Wellendichtring
16	Schalenhartguss
17	Induktionsgehärtetes Gusseisen
19	A = 28.100, D = 50.100
20	A = 28.670, D = 49.670
21	A = 30.500, D = 52.200
22	A = 30.600, D = 51.500
23	A = 30.600, D = 52.600
24	A = 31.700, D = 53.400
25	A = 31.900, D = 62.000
26	A = 35.300, D = 66.500
27	A = 39.400
28	A = 39.550, D = 60.550
29	A = 41.450
30	A = 44.100, D = 70.100
31	A = 45.430
32	A = 45.500, D = 69.500
33	A = 45.550, D = 68.550
34	A = 45.550, D = 71.550
35	Pleuelaugenabstand 27.50mm
36	Für neuere Ausführungen, direkt einspritzende Düsen
37	Nur für schräg angeordnete Einspritzdüsen
38	Ohne Aussparung für Kühllölspritzdüse
39	OE 03L 107 065G, nur für Motoren der Generation 1
40	OE 03L 107 065S, nur für Motoren der Generation 2
41	Phosphated
42	Volumen der Kolbenmulde [ccm] 20.70
43	Volumen der Kolbenmulde [ccm] 22.85
44	Volumen der Kolbenmulde [ccm] 23.30
45	Volumen der Kolbenmulde [ccm] 23.54
46	Volumen der Kolbenmulde [ccm] 23.60
47	Volumen der Kolbenmulde [ccm] 23.75
48	Volumen der Kolbenmulde [ccm] 24.05
49	Volumen der Kolbenmulde [ccm] 24.50
50	Volumen der Kolbenmulde [ccm] 24.60
51	Kolben nur Motorsätzen zu ersetzen
52	Stahl
53	zum Zylinder 1
54	zum Zylinder 1 - 3
55	zum Zylinder 1 - 2
56	zum Zylinder 2
57	zum Zylinder 3
58	zum Zylinder 3 - 5
59	zum Zylinder 3 - 4
60	zum Zylinder 4
61	zum Zylinder 4 - 6
62	Mit kurbelwellenseitigen Aussparungen
63	A = 31.90 D = 62.20
64	"SPUTTER" obere Lagerhälfte
65	G-149
66	Für gebrochene Pleuelstangen
67	Nur für aufbereitete Zylinderköpfe
68	Bei der Erstausrüstung werden die Zwischenwellenbuchsen nach dem Einpressen fertigbearbeitet, um Spiel, Verzug und Flucht zu optimieren. Deshalb empfehlen wir die Verwendung unserer 'Semi' Buchsen und die gleiche Vorgehensweise.

1	con scudo termico
2	Variante di dotazione: GT
3	Lato montaggio: Bilaterale
4	Diametro [mm]: 78.85
5	Al cilindro del motore: 2 + 3
6	Al cilindro del motore: 4 + 5
8	Variante di dotazione: GT; Variante di dotazione: 60 PS/hp
9	diametro centraggio [mm] : 685 mm
10	diametro centraggio [mm] : 6.5 mm
11	meccanico
12	Versione bullone/dado: Senza rondella d'appoggio
13	Materiale blocco motore: Acciaio fuso
14	Con paraolio
15	Senza paraolio
16	ghisa temprata
17	ghisa temprata per induzione
19	A = 28.100, D = 50.100
20	A = 28.670, D = 49.670
21	A = 30.500, D = 52.200
22	A = 30.600, D = 51.500
23	A = 30.600, D = 52.600
24	A = 31.700, D = 53.400
25	A = 31.900, D = 62.000
26	A = 35.300, D = 66.500
27	A = 39.400
28	A = 39.550, D = 60.550
29	A = 41.450
30	A = 44.100, D = 70.10
31	A = 45.430
32	A = 45.500, D = 69.500
33	A = 45.550, D = 68.550
34	A = 45.550, D = 71.550
35	Distanza dalla bille 27.50mm
36	Per la più recente progettazione dell'ugello olio non angolato
37	Per il lato angolato dell'ugello olio
38	Senza passaggio per spruzzatore olio
39	solo motore Generation 1
40	solo motore Generation 2
41	Phosphated
42	Volume camera pistone [cm ³] 20.70
43	Volume camera pistone [cm ³] 22.85
44	Volume camera pistone [cm ³] 23.30
45	Volume camera pistone [cm ³] 23.54
46	Volume camera pistone [cm ³] 23.60
47	Volume camera pistone [cm ³] 23.75
48	Volume camera pistone [cm ³] 24.05
49	Volume camera pistone [cm ³] 24.50
50	Volume camera pistone [cm ³] 24.60
51	Il pistone può essere rimpiazzato solamente completo
52	Acciaio
53	al cilindro 1
54	al cilindro 1 - 3
55	al cilindro 1 - 2
56	al cilindro 2
57	al cilindro 3
58	al cilindro 3 - 5
59	al cilindro 3 - 4
60	al cilindro 4
61	al cilindro 4 - 6
62	Con nicchie sul lato albero motore
63	A = 31.90 D = 62.20
64	Semicuscinetto superiore "SPUTTER"
65	G-149
66	Per bielle fratturate
67	Soltanto per testate rilavorate
68	L'OE suggerisce per l'installazione che le boccole dell'albero intermedio di distribuzione siano lavorate e finite con tolleranza, centratura e l'allineamento corretti. Vi consigliamo le nostre boccole 'semifinite' e di seguire la stessa procedura.

Français

1	Avec bouclier thermique
2	Version d'équipement: GT
3	Endroit d'assemblage: côté conducteur + passager av.
4	Diamètre [mm]: 78.85
5	sous cylindre moteur: 2 + 3
6	sous cylindre moteur: 4 + 5
8	Version d'équipement: GT;Version d'équipement: 60 PS/hp
9	Diamètre de centrage [mm]: 8,5
10	Diamètre de centrage [mm]: 6,5
11	Mécanique
12	Type d'écrou: sans rondelle de calage
13	Matériel pour bloc-moteur: fonte
14	avec bague d'étanchéité
15	sans bague d'étanchéité
16	Fonte (fer) refroidie
17	Fonte (fer) trempée à induction
19	A = 28.100, D = 50.100
20	A = 28.670, D = 49.670
21	A = 30.500, D = 52.200
22	A = 30.600, D = 51.500
23	A = 30.600, D = 52.600
24	A = 31.700, D = 53.400
25	A = 31.900, D = 62.000
26	A = 35.300, D = 66.500
27	A = 39.400
28	A = 39.550, D = 60.550
29	A = 41.450
30	A = 44.100, D = 70.100
31	A = 45.430
32	A = 45.500, D = 69.500
33	A = 45.550, D = 68.550
34	A = 45.550, D = 71.550
35	Distance entre bielle 27.50mm
36	Pour buse d'injection droite à conception plus récente
37	Pour buse d'injection latérale angulaire
38	Sans encoche en bas de jupe pour le passage de la pissette d'huile sous pression
39	N°OE 03L 107 065G, uniquement pour Moteur de génération 1
40	N°OE 03L 107 065S, uniquement pour Moteur de génération 2
41	Phosphated
42	Volume de la cavité du piston [cm³] 20.70
43	Volume de la cavité du piston [cm³] 22.85
44	Volume de la cavité du piston [cm³] 23.30
45	Volume de la cavité du piston [cm³] 23.54
46	Volume de la cavité du piston [cm³] 23.60
47	Volume de la cavité du piston [cm³] 23.75
48	Volume de la cavité du piston [cm³] 24.05
49	Volume de la cavité du piston [cm³] 24.50
50	Volume de la cavité du piston [cm³] 24.60
51	Piston à remplacer dans jeu moteur
52	Acier
53	au cylindre 1
54	sous cylindre 1 - 3
55	sous cylindre 1 - 2
56	au cylindre 2
57	au cylindre 3
58	sous cylindre 3 - 5
59	sous cylindre 3 - 4
60	au cylindre 4
61	sous cylindre 4 - 6
62	Avec évidements côté vilebrequin
63	A = 31.90 D = 62.20
64	Demi-coussinet supérieur "SPUTTER"
65	G-149
66	Pour bielle sécable
67	Uniquement pour culasses réusinées
68	En première monte, les bagues d'arbre intermédiaire sont usinées après montage pour optimiser jeu, centrage, et alignement. De ce fait, nous recommandons d'utiliser nos bagues 'semi' et de suivre la même procédure.

1	Con escudo térmico
2	Variante de equipamiento: GT
3	Lado mont.: ambos lados
4	Diámetro [mm]: 78.85
5	A cilindro de motor: 2 + 3
6	A cilindro de motor: 4 + 5
8	Variante de equipamiento: GT; Variante de equipamiento: 60 PS/hp
9	Diámetro de Centrado [mm]: 8.5
10	Diámetro de Centrado [mm]: 6.5
11	Mecánico
12	Modelo de tornillo/tuerca: sin arandela
13	Material bloque: Acero fundido
14	con anillo retención
15	sin anillo retención
16	Hierro fundido
17	Hierro fundido endurecido por inducción
19	A = 28.100, D = 50.100
20	A = 28.670, D = 49.670
21	A = 30.500, D = 52.200
22	A = 30.600, D = 51.500
23	A = 30.600, D = 52.600
24	A = 31.700, D = 53.400
25	A = 31.900, D = 62.000
26	A = 35.300, D = 66.500
27	A = 39.400
28	A = 39.550, D = 60.550
29	A = 41.450
30	A = 44.100, D = 70.100
31	A = 45.430
32	A = 45.500, D = 69.500
33	A = 45.550, D = 68.550
34	A = 45.550, D = 71.550
35	Distancia del biela 27.50mm
36	Para el más reciente diseño de boquilla de inyección directa
37	Para la boquilla de inyección lateral angular
38	Sin escotadura
39	OE 03L 107 065G, Generación 1 solo motor
40	OE 03L 107 065G, Generación 2 solo motor
41	Phosphated
42	Volumen de cavidad del pistón [cc] 20.70
43	Volumen de cavidad del pistón [cc] 22.85
44	Volumen de cavidad del pistón [cc] 23.30
45	Volumen de cavidad del pistón [cc] 23.54
46	Volumen de cavidad del pistón [cc] 23.60
47	Volumen de cavidad del pistón [cc] 23.75
48	Volumen de cavidad del pistón [cc] 24.05
49	Volumen de cavidad del pistón [cc] 24.50
50	Volumen de cavidad del pistón [cc] 24.60
51	Pistones de repuesto para juegos de motores solamente
52	Acero
53	al cilindro 1
54	A cilindro 1 - 3
55	A cilindro 1 - 2
56	al cilindro 2
57	al cilindro 3
58	A cilindro 3 - 5
59	A cilindro 3 - 4
60	al cilindro 4
61	A cilindro 4 - 6
62	Con escotaduras en la cara del cigüeñal
63	A = 31.90 D = 62.20
64	Medio cojinete superior "SPUTTER"
65	G-149
66	Para biela agrietada
67	Solamente para culatas reconducidas
68	En equipo original, los casquillos del árbol intermedio son terminados en posición para optimizar el juego, el centraje y la alineación. Recomendamos nuestros casquillos 'semi' y el mismo procedimiento.

Polski

1	Z osłoną termiczną
2	Wersja wyposażenia: GT
3	Miejsce montażu: Lewa i prawa
4	Średnica [mm]: 78.5
5	do cylindrów nr: 2 + 3
6	do cylindrów nr: 4 + 5
8	Wersja wyposażenia: GT, Wersja wyposażenia: 60 KM/PS
9	Średnica centrująca [mm]: 8.5
10	Średnica centrująca [mm]: 6.5
11	Mechaniczne
12	Wersja śruby / nakrętki: bez zwykłej podkładki
13	Materiał bloku cylindrów: staliwo
14	Z uszczelnień wału
15	Bez uszczelnień wału
16	Żeliwo białe
17	Żeliwo hartowane indukcyjnie
19	A = 28.100, D = 50.100
20	A = 28.670, D = 49.670
21	A = 30.500, D = 52.200
22	A = 30.600, D = 51.500
23	A = 30.600, D = 52.600
24	A = 31.700, D = 53.400
25	A = 31.900, D = 62.000
26	A = 35.300, D = 66.500
27	A = 39.400
28	A = 39.550, D = 60.550
29	A = 41.450
30	A = 44.100, D = 70.100
31	A = 45.430
32	A = 45.500, D = 69.500
33	A = 45.550, D = 68.550
34	A = 45.550, D = 71.550
35	Otwór korbowodu 27,50 mm
36	Do nowszej, prostej dyszy wtyskiwacza
37	Do skośnej dyszy wtryskiwacza
38	Bez kanałka dyszy olejowej
39	OE 03L 107 065G, Tylko silnik 1 gen.
40	OE 03L 107 065S, Tylko silnik 2 gen
41	Fosforanowane
42	Pojemność komory spalania [cm3] 20,70
43	Pojemność komory spalania [cm3] 22,85
44	Pojemność komory spalania [cm3] 23,30
45	Pojemność komory spalania [cm3] 23,54
46	Pojemność komory spalania [cm3] 23,60
47	Pojemność komory spalania [cm3] 23,75
48	Pojemność komory spalania [cm3] 24,05
49	Pojemność komory spalania [cm3] 24,50
50	Pojemność komory spalania [cm3] 24,60
51	Wymiana tłoków tylko w kompletnych zestawach dla silnika
52	Stalowe
53	do cylindra nr 1
54	do cylindrów nr 1 - 3
55	do cylindrów nr 1 - 2
56	do cylindra nr 2
57	do cylindra nr 3
58	do cylindrów nr 3 - 5
59	do cylindrów nr 3 - 4
60	do cylindra nr 4
61	do cylindrów nr 4 - 6
62	Z wgłębieniem po stronie wału korbowego
63	A = 31.90 D = 62.20
64	Górna półpanewka typu "SPUTTER"
65	G-149
66	Dla łamanych korbowodów
67	Tylko dla ponownie obrabianych głowic cylindrów
68	Procedury OE wymagają, aby tuleje wałka pośredniego były obrabiane po zamontowaniu w celu optymalizacji luzów, centrowania i współosiowości. Z tego powodu my również, dla naszych tulei typu "semi", zalecamy stosowanie tej samej procedury.

1	С теплозащитным экраном
2	Вариант оборудования: GT
3	Положение установки: Слева и справа
4	Диаметр [мм]: 78,5
5	к цилиндру двигателя: 2 + 3
6	к цилиндру двигателя: 4 + 5
8	Вариант оборудования: GT, вариант оборудования: 60 лс
9	Базовый диаметр [мм]: 8,5
10	Базовый диаметр [мм]: 6,5
11	Механический
12	Болт/гайка: без плоской шайбы
13	Материал блока цилиндров: литая сталь
14	С сальником вала
15	Без уплотнения вала
16	Отбеленный чугун
17	Чугун, закаленный ТВЧ
19	A = 28.100, D = 50.100
20	A = 28.670, D = 49.670
21	A = 30.500, D = 52.200
22	A = 30.600, D = 51.500
23	A = 30.600, D = 52.600
24	A = 31.700, D = 53.400
25	A = 31.900, D = 62.000
26	A = 35.300, D = 66.500
27	A = 39.400
28	A = 39.550, D = 60.550
29	A = 41.450
30	A = 44.100, D = 70.100
31	A = 45.430
32	A = 45.500, D = 69.500
33	A = 45.550, D = 68.550
34	A = 45.550, D = 71.550
35	Зазор шатуна 27,50 мм
36	Для прямых форсунок впрыска новой конструкции
37	Для форсунок впрыска сбоку под углом
38	Нет отверстия для масляной форсунки
39	OE 03L 107 065G, только двигатель поколения 1
40	OE 03L 107 065G, только двигатель поколения 2
41	Фосфатирование
42	Объем полости цилиндра [см ³] 20,70
43	Объем полости цилиндра [см ³] 22,85
44	Объем полости цилиндра [см ³] 23,30
45	Объем полости цилиндра [см ³] 23,54
46	Объем полости цилиндра [см ³] 23,60
47	Объем полости цилиндра [см ³] 23,75
48	Объем полости цилиндра [см ³] 24,05
49	Объем полости цилиндра [см ³] 24,50
50	Объем полости цилиндра [см ³] 24,60
51	Поршни следует заменять только в составе ремонтного комплекта двигателя
52	Сталь
53	к цилиндру 1
54	к цилиндру 1 - 3
55	к цилиндру 1 - 2
56	к цилиндру 2
57	к цилиндру 3
58	к цилиндру 3 - 5
59	к цилиндру 3 - 4
60	к цилиндру 4
61	к цилиндру 4 - 6
62	С пазом со стороны коленчатого вала
63	A = 31.90 D = 62.20
64	верхняя составная часть "СПАТТЕРНОГО" вкладыша
65	G-149
66	Для шатунов с крышкой колотого типа
67	Только для восстановленных головок блока цилиндров
68	Процедура установки в соответствии с требованиями автопроизводителя требует, чтобы промежуточные втулки вала, после их установки были подвергнуты механической обработке для оптимизации зазора, центрирования и выравнивания. Поэтому, мы советуем вам использовать наши "полуготовые" втулки и следовать аналогичным рекомендациям по установке от автопроизводителей.

اللغة العربية

1	مع وافي الحرارة
2	مغير المعدة: GT
3	وضع التثبيت: يسار ويمين
4	الفطر [مم]: 78.5
5	إلى اسطوانة المحرك: 3 + 2
6	إلى اسطوانة المحرك: 5 + 4
8	مغير المعدة: GT، مغير المعدة: PS/hp 60
9	قطر السننرة [مم]: 8.5
10	قطر السننرة [مم]: 6.5
11	ميكانيكي
12	نسخة مسمار الربط/الصامولة بدون مساحة عادية
13	مادة كتلة المحرك: صلب مصبوب
14	مع مانع تسريب عمود
15	بدون مانع تسريب عمود
16	الحديد الزهر المبرد
17	الحديد الزهر المعالج للصلابة
19	أ = 28.100 د = 50.100
20	أ = 28.670 د = 50.100
21	أ = 30.500 د = 52.200
22	أ = 30.600 د = 51.500
23	أ = 30.600 د = 52.600
24	أ = 31.700 د = 53.400
25	أ = 31.900 د = 62.000
26	أ = 35.300 د = 66.500
27	أ = 39.400
28	أ = 39.550 د = 60.550
29	أ = 41.450
30	أ = 44.100 د = 70.100
31	أ = 45.430
32	أ = 45.500 د = 69.500
33	أ = 45.550 د = 68.550
34	أ = 45.550 د = 71.550
35	فتحة كونرود 27.50 مم
36	لأحدث تصميم بغوهة حفن مباشر
37	لفوهة الحفن بزواوية واحدة
38	بدون قطع نفث الزيت
39	المعدة الأصلية 03L 107 065G، لمحرك 1 فقط
40	المعدة الأصلية 03L 107 065S، لمحرك 2 فقط
41	بالفوسفات
42	سعة غرفة الكباس [سسم] 20.70
43	سعة غرفة الكباس [سسم] 22.85
44	سعة غرفة الكباس [سسم] 23.30
45	سعة غرفة الكباس [سسم] 23.54
46	سعة غرفة الكباس [سسم] 23.60
47	سعة غرفة الكباس [سسم] 23.75
48	سعة غرفة الكباس [سسم] 24.05
49	سعة غرفة الكباس [سسم] 24.50
50	سعة غرفة الكباس [سسم] 24.60
51	الكباسات المطلوب استبدالها في مجموعة المحركات فقط
52	الصلب
53	إلى اسطوانة المحرك: 1
54	للأسطوانة 3-1
55	للأسطوانة 1 و 2
56	للأسطوانة 2
57	للأسطوانة 3
58	للأسطوانة 3-5
59	للأسطوانة 3 و 4
60	للأسطوانة 4
61	للأسطوانة 4-6
62	مع وجود تجويفات على جانب عمود الكرنك
63	أ = 31.90 د = 62.20
64	محمل النصف العلوي للرشاش "SPUTTER"
65	G-149
66	خاص بقضيب التوصيل المشقوق
67	خاص برووس الأسطوانة التي تم تغييرها فقط
68	يستلزم إجراء المعدلات الأصلية لتصنيع جلب عمود الوسط بمجرد ملاءمتها لضبط مسافة الخلوص واتباع نفس الإجراء. باستخدام الجلب الشبيهة الخاصة بنا والمركز والمحاذة، لذا ننصح

Federal-Mogul ADVANCED ANTI-COUNTERFEIT PROGRAMME

The following features on all engine, gaskets and headbolts packaging prove that the parts inside are Original Quality.



LOOK FOR THE HOLOSPOT®

The Holospot® label features a 4-digit alphanumeric code. Please check it to make sure that:

- The 4-digit code appears in rainbow colours using the light of the magnifier and is different on each pack
- The Federal-Mogul logo also appears in the Holospot®. The last 4 digits of the alphanumeric code have to be the same as the ones in the Holospot®



CHECK THE UNIQUE CODE ONLINE AT www.fmecat.eu

Each Federal-Mogul part has a unique code which is displayed on the labels in an alphanumeric and Data Matrix format. A Data Matrix code is a 2-dimensional (2-D) matrix barcode. The Unique Code can be verified in 3 different ways:

- Typing in the Unique Code
- Reading the 2-D code with a 2-D scanner
- Reading the 2-D code with a mobile phone which is supported by NeoReader™ (www.neoreader.com)

For further details please check www.fmecat.eu



PROTECTION

Special label design means any attempt to remove or swap the label will result in tearing



CRASH LOCK BOX BOTTOM

Prevents any attempt to remove or exchange items as it is impossible to reseal once opened



PERMANENT SELF-ADHESIVE LABEL

Seals the pack with label detail on the front



Verify the Unique Code online at www.fmecat.eu

Federal-Mogul Global Aftermarket EMEA bvba
Prins Boudewijnlaan 5 • B-2550 Kontich • Belgium
Central Distribution Centre
Prins Boudewijnlaan 7 • B-2550 Kontich • Belgium
Phone +32 (0) 3450 83 10 • Fax +32 (0) 3450 83 38



Federal-Mogul Italy Srl
Aftermarket Division
Via Enrico Fermi 8 • 37135 Verona • Italy
Phone +39 045 828 13 11 • Fax +39 045 828 14 00



Federal-Mogul Friction Products GmbH
Federal-Mogul Aftermarket
Klosterstraße 16 • D-51709 Marienheide • Germany
Phone +49 (0) 2264 89 0 • Fax +49 (0) 2264 89 266



Federal-Mogul Aftermarket UK Limited
Greyhound Drive • Bradford • BD7 1NQ • England
Phone +44 (0) 1274 723481 • Fax +44 (0) 1274 848282



Federal-Mogul Ibérica, S.L.
Federal-Mogul Aftermarket España, S.A.
Calle Alcarria, nº 2 • 28823 Coslada • Madrid • Spain
Phone: + 34 91 746 1900 • Fax: + 34 91 746 18 90



Federal-Mogul Aftermarket France
60-62, rue Danjou • 92517 Boulogne-Billancourt Cedex • France
Phone +33 (0) 1 46 94 27 00 • Fax +33 (0) 1 46 94 27 01
Service Commande de stock :
Phone +33 (0) 810 000 029 • Fax +32 34 50 80 26
Service Commande express :
Phone +33 (0) 810 000 029 • Fax +33 (0) 1 46 94 27 01



Federal-Mogul Aftermarket
Southern Africa (PTY) Ltd
33 Western Boulevard • City West • Johannesburg • South Africa
Phone +27 11 630 3000 • Fax +27 11 630 3040



Federal-Mogul Aftermarket Turkey
Meclis-i Mebusan Cad. No: 53 Dereli İş Merkezi 34427 • Fındıklı / İstanbul • Türkiye
Phone +90 212 292 6313 • Fax +90 212 292 6260



BERU® is a Registered Trademark of BorgWarner BERU Systems GmbH. All other logos and trademarks are the property of Federal-Mogul Corporation and its affiliates.

CHECK OUT OUR CATALOGUES



CATAE902



CATAE1101



CATAE1301



CATMX1301

NEW



CATGY1201



CATGT1001



CATNU1201



VISIT www.FMeCat.eu
 Online catalogue website
 Available 24/7



CATPA1001



CATPA1101



CATPA1201



XCD12

YOU CAN OBTAIN THESE CATALOGUES THROUGH YOUR Federal-Mogul SALES REPRESENTATIVE OR THROUGH YOUR LOCAL DISTRIBUTOR