

Niiral[®]

FITTED WITH  GOETZE[®] RINGS

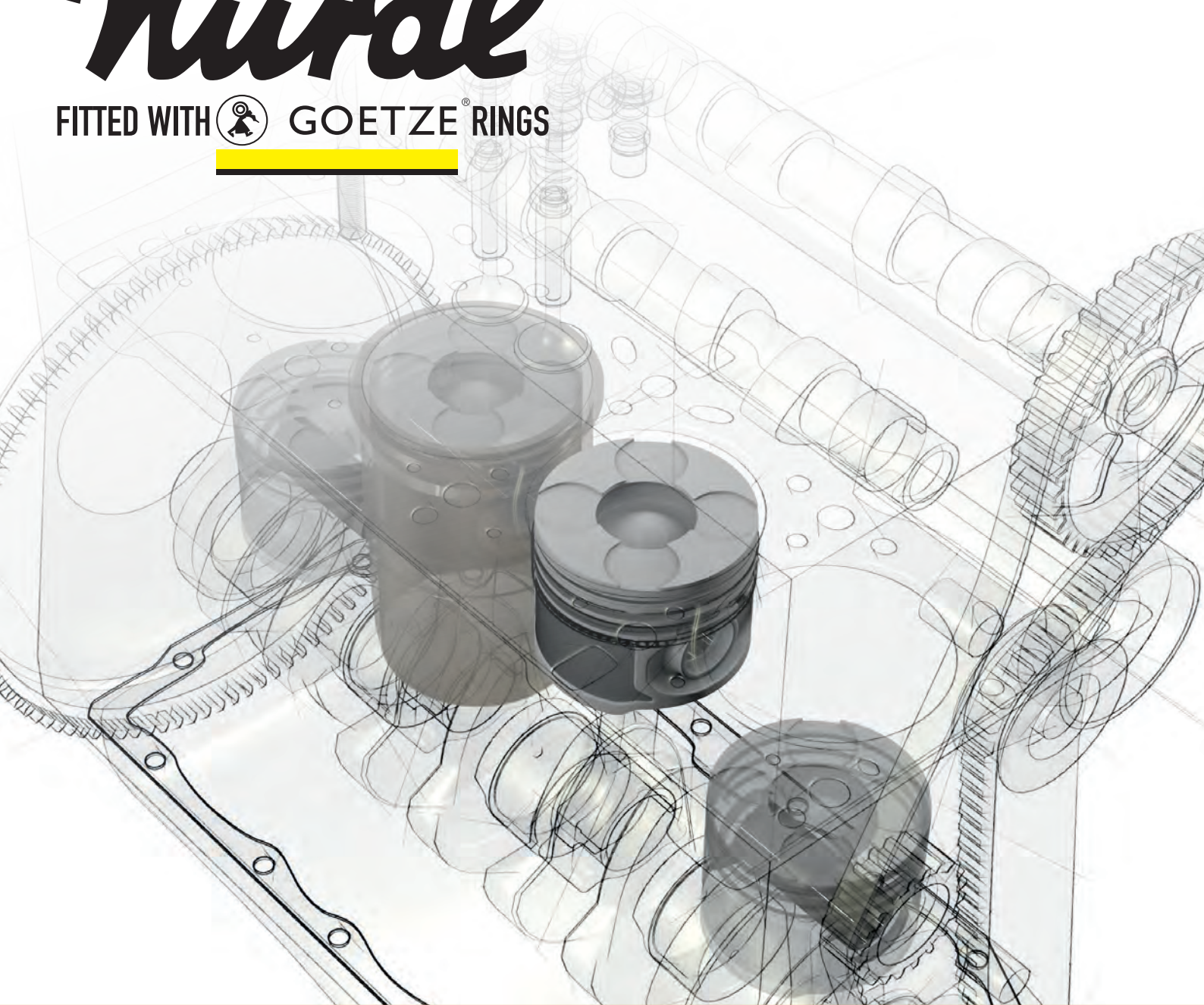

Pistons, Liners and Assemblies

Kolben, Laufbuchsen und Zubehör

Pistoni, Canne e Gruppi Cilindro

Pistons, Chemises et Kits

Pistones, Camisas y Equipos

Тітки, Тілки і Зespoлiв Чзсїци Циліндрових

Поршни, Циліндри і Поршнекомплекты

المكابيس ، القمصان و مجموعات السلندر

CATNU2201



2023-2025

ENGINE EXPERTISE



EXPERTISE INSIDE OUT TOP TO BOTTOM



 **Payen**[®]

 **GOETZE**[®]

Niral[®]

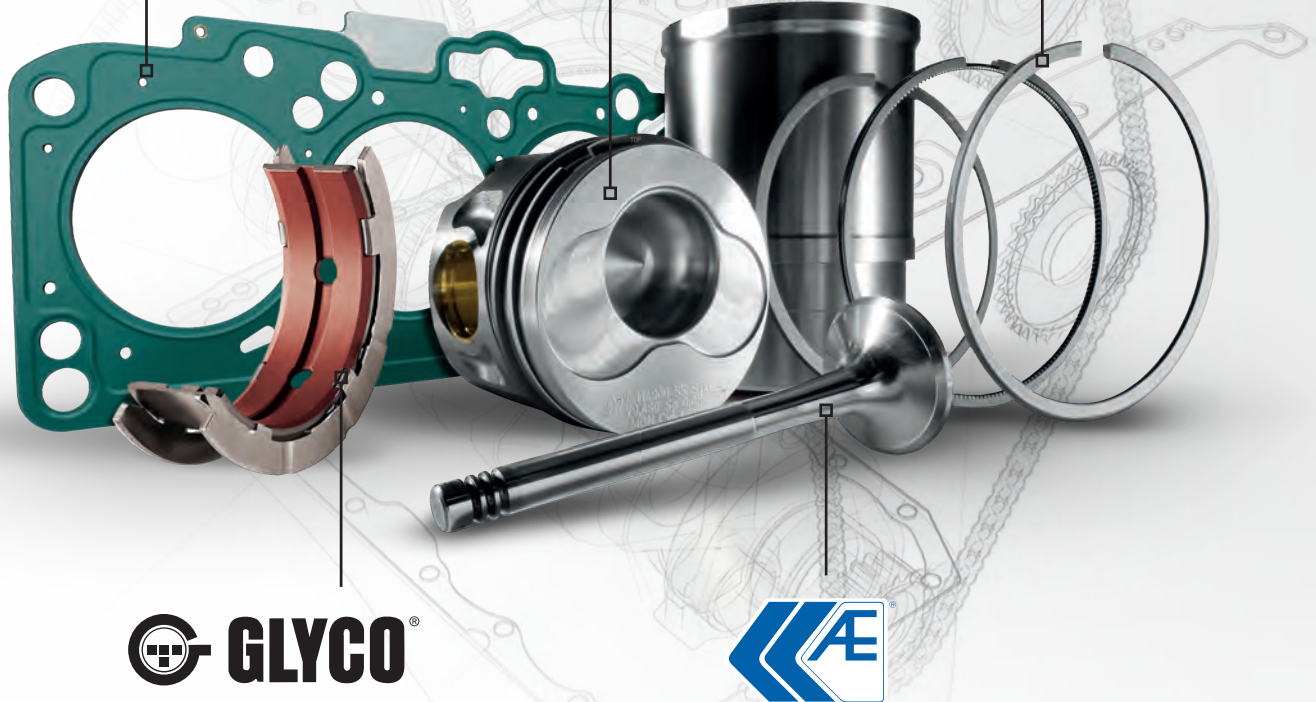

 **GLYCO**[®]



WHY WOULD YOU RELY ON OUR 5 ENGINE BRANDS?

- Market-leading coverage with premium-quality materials and components
- The most comprehensive range of parts on the market
- Take full benefit of the latest engine technologies:
Coriuseal™, Coriusim™, LKZ-Ring®, Carboglide®, IROX® and Durabowl®
- OE quality solutions for the Aftermarket with maximum durability and performance
- Dedicated technical support and training for distributors and repair specialists

ENGINE EXPERTISE



NEW SECURITY SEAL

SCAN TO GET MORE!

Enjoy exclusive benefits in only seconds

We're now including something extra with the majority of Nural® parts – a unique QR code!

By simply scanning the QR code with a smartphone's camera, you can access all you need to know about the product and even learn new skills that will last a lifetime.



THE REAL DEAL!

Scan the code and it gives you the instant peace-of-mind that the product is a genuine Nural® part.

Nural®



SCAN ME GET MORE!



UD10SVG33Y



Learn how to verify the Unique Security Label on the next page

EXTENSIVE PRODUCT DETAILS AT YOUR FINGERTIPS

The QR code also provides access to:

- Product part number, specification and applications
- Warranty conditions
- After sales support
- Direct email for Garage Gurus technical experts

UPDATE YOUR TECHNICAL KNOWLEDGE FOR FREE

Scan the QR code and you can enhance your technical skills for free by enrolling in the Garage Gurus® Online Training Center. Once you've spent a couple of minutes registering, you then enjoy a host of training-based benefits, including:

- e-learning course library
- webinars
- brand information



More info: drivparts.com/en-eu/garagegurus.html

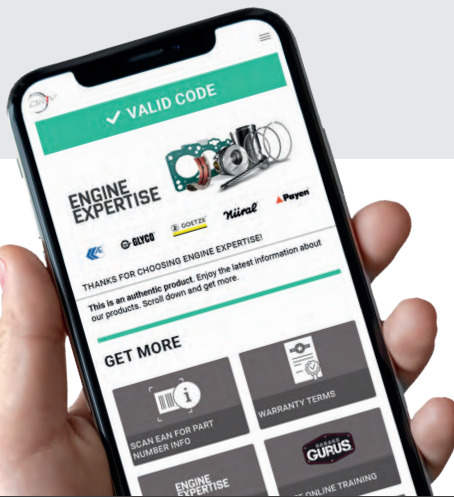

If you see the QR code, scan it - it's as essential as having the right tools for the job!

ENGINE EXPERTISE



CONTENTS



Contents	II-III
Manufacturers list	V
Terms of business	VIII-IX
How to use this catalogue	X-XXV
Garage Gurus	XXVI-XXVII
New parts list	2
Applications by manufacturer	19
Numerical parts list	890
Nüral pistons fitted with Goetze rings	912
Pistons clearance data	917
Piston protrusion data	923
Latest engine & sealing catalogues	XXIX



Contenuti	II-III
Elenco costruttori	V
Condizioni generali	VIII-IX
Come si utilizza il catalogo	X-XXV
Garage Gurus	XXVI-XXVII
Elenco codici nuovi	2
Applicazioni del costruttore	19
Elenco riferimenti	890
Pistoni Nüral con segmenti Goetze	912
Dati sul gioco dei pistoni	917
Dati sporgenza pistone	923
Ultimi cataloghi guarnizioni e motori Tenneco	XXIX



Inhaltsverzeichnis	II-III
Herstellerliste	V
Geschäftsbedingungen	VIII-IX
So benutzen Sie diesen Katalog	X-XXV
Garage Gurus	XXVI-XXVII
Neuaufnahmen	2
Anwendungen nach Hersteller	19
Nummerische Teileliste	890
Nüral-Kolben mit Goetze-Kolbenringen	912
Daten Kolbenspiel	917
Kolbenüberstands-Daten	923
Neueste Motoren- und Dichtungskataloge	XXIX



Contenu	II-III
Liste des constructeurs	V
Conditions générales de vente	VIII-IX
Comment utiliser ce catalogue	X-XXV
Garage Gurus	XXVI-XXVII
Liste des nouvelles références	2
Applications par constructeur	19
Liste numérique des références	890
Pistons Nüral équipés de segments Goetze	912
Jeu de pistons	917
Données de dépassement de piston	923
Catalogues de Tenneco de pièces moteur et étanchéité les plus récents	XXIX



Contenido	II-III
Lista de fabricantes	V
Condiciones de venta	VIII-IX
Cómo utilizar este catálogo	X-XXV
Garage Gurus	XXVI-XXVII
Lista de nuevas referencias	2
Aplicaciones por fabricante	19
Lista de referencias numéricas	890
Pistones Nüral con segmentos Goetze	912
Datos de holgura de pistones	917
Altura del pistón en PMS	923
Últimos catálogos de componentes de sellado y motores	XXIX



Содержание	II-III
Список производителей	V
Условия делового сотрудничества	VIII-IX
Как пользоваться каталогом	X-XXV
Garage Gurus	XXVI-XXVII
Список новой продукции	2
Модели автомобилей, сортировка по производителю	19
Список номеров деталей	890
Поршни Nüral, оснащаемые кольцами Goetze	912
Спецификация зазора поршня	917
Параметры выступления поршня	923
Новейшие каталоги уплотнений и деталей для двигателей Tenneco	XXIX



Zawartość	II-III
Lista producentów	V
Warunki prowadzenia biznesu	VIII-IX
Jak używać tego katalogu	X-XXV
Garage Gurus	XXVI-XXVII
Lista nowych części	2
Lista zastosowań wg producentów	19
Numeryczna lista części	890
Tłoki Nüral wyposażone w pierścienie Goetze	912
Dane dotyczące luzów tłokowych	917
Dane dotyczące wysunięcia tłoka	923
Najnowsze katalogi części silnikowych i uszczelnień	XXIX



المحتويات	III-II
قائمة جهات التصنيع	V
شروط العمل التجاري	XI-VIII
كيفية استخدام هذا الكatalog	XXV-X
Garage Gurus	XXVII-XXVI
قائمة قطع الغيار الجديدة	2
التطبيقات حسب جهة التصنيع	19
قائمة الأجزاء الرقمية	890
يتم تركيب كباسات Nüral باستخدام حلقات Goetze	912
معلومات خلوص المكبس	917
معلومات بروز المكبس	923
أحدث كتالوجات Tenneco للمحركات ومنتجات منع التسرب	XXIX

OUTSTANDING TECHNOLOGIES OE QUALITY FOR THE OM470 ENGINE

Environmentally friendly

Highly durable

OE quality

Monosteel® piston technology

Environmentally friendly

Made for the downsized, fuel efficient and EU6 compliant OM470 engine of the HDEP family for Mercedes-Benz Actros - the biggest selling truck in Europe.*

Highly durable

Fitted with Goetze® rings using GDC® & LKZ® technologies for excellent wear resistance with lower friction and reduced oil consumption.

OE quality

First to aftermarket with outstanding OE technology.

Monosteel® piston technology

Patented German design; double sided friction welded from two steel forgings to create a large, high cooling gallery for maximum efficiency and rigidity.

*TecAlliance GmbH VIO 2020



ENGINE EXPERTISE



MANUFACTURERS LIST

ABARTH _____	>FIAT	LEYLAND _____	358
ALFA ROMEO _____	19	LISTER _____	362
ASTRA _____	> IVECO	LOTUS _____	364
AUDI _____	33	LTI _____	365
AUSTIN MORRIS _____	59	MAN _____	366
AUTOBIANCHI _____	> FIAT / LANCIA	MASSEY-FERGUSEN _____	> PERKINS
BEDFORD _____	65	MAZDA _____	412
BERLIET _____	> RENAULT	MERCEDES-BENZ _____	417
BMW _____	69	MG _____	528
CHEVROLET _____	78	MINI _____	533
CHRYSLER _____	86	MITSUBISHI _____	539
CITROËN _____	89	MORRIS _____	> AUSTIN MORRIS
COMPRESSOR _____	117	MWM _____	545
CUMMINS _____	120	NEW HOLLAND _____	546
DACIA _____	121	NISSAN _____	556
DAEWOO _____	128	OPEL _____	570
DAF _____	131	PERKINS _____	595
DAIMLER _____	> JAGUAR	PEUGEOT _____	605
DAIMLER-BENZ _____	> MERCEDES-BENZ	POLSKI FIAT _____	>FIAT
DEUTZ/KHD _____	143	PUCH _____	> MERCEDES-BENZ
DS _____	> CITROËN	RENAULT _____	635
FIAT _____	159	ROVER _____	683
FIAT ALLIS-HITACHI _____	> IVECO	RVI _____	>RENAULT
FIAT INDUSTRIAL _____	> IVECO	SAAB _____	691
FORD _____	193	SAVIEM _____	>RENAULT
FSO _____	235	SCANIA _____	695
HINO _____	238	SEAT _____	710
HOLDEN _____	> OPEL	SKODA _____	735
HONDA _____	239	SMART _____	754
HYUNDAI _____	242	SSANGYONG _____	757
IHC _____	250	STEYR _____	762
INNOCENTI _____	> FIAT / LANCIA	SUBARU _____	765
ISUZU _____	252	SUZUKI _____	766
IVECO _____	256	TALBOT _____	771
JAGUAR _____	308	TOYOTA _____	774
JEEP _____	313	TRIUMPH _____	779
JOHN DEERE _____	316	TRIUMPH MOTORCYCLE _____	780
KAMAZ _____	319	UTB _____	781
KIA _____	320	VAUXHALL _____	782
KHD _____	> DEUTZ/KHD	VM _____	806
LADA _____	326	VOLVO _____	808
LANCIA _____	329	VOLVO PENTA _____	>VOLVO
LAND ROVER _____	343	VW _____	844
LDV _____	354	ZASTAVA _____	888

Nüral®

FITTED WITH  GOETZE® RINGS

ECOTOUGH®

A TECHNOLOGY COMES TO LIGHT.



ECOTOUGH®

Discover tomorrow today. The Nüral® EcoTough® NG piston skirt coating technology further reduces engine friction, wear and noise while handling the increasingly challenging loads and temperatures of FIAT's Firefly engine.



ENGINE EXPERTISE



STEP INTO THE FUTURE

The EcoTough® NG piston coatings have been specially designed to meet the extreme load conditions of internal combustion engines. Thanks to a metal oxide-reinforced construction with additional embedded solid lubricant particles, they **reduce skirt wear by up to 40%*** when compared to market standards with a surface application of just 15 microns. This also **reduces piston frictional losses by up to 15%***.

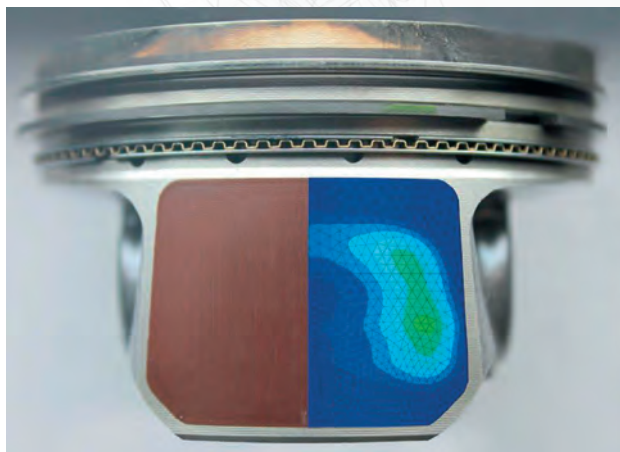

Direct comparison of simulated contact load (right) and EcoTough-New Generation piston skirt coating with no visible wear (left) after testing in a 1.6-litre petrol engine

This means EcoTough® NG significantly **improves fatigue strength** and **increases fuel efficiency** for an environmentally friendly engine that's **more durable and efficient** than ever before. Application of these piston skirt coatings using fully automated, large-scale production processes means the excellent wear and friction properties can be achieved within economical cost targets.



Micro-section of Tenneco Powertrain's EcoTough Generation piston skirt coating for petrol engines, showing individual component materials like reinforcing fibres

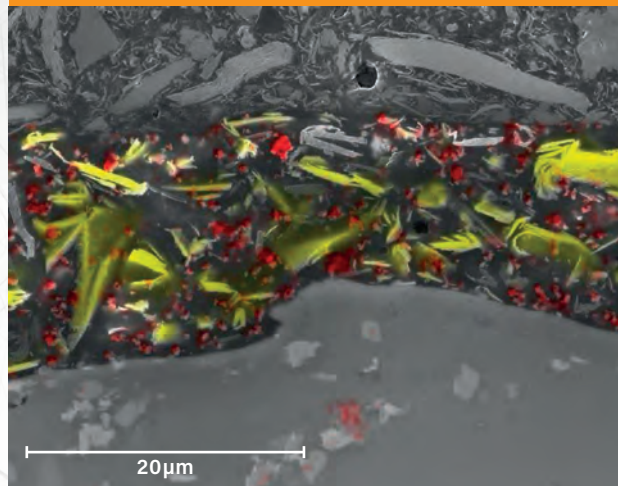

PARTNUMBER NÜRAL ECOTOUGH®: 87-450900-00

OE REFERENCE: 46336793

VEHICLE MANUFACTURER: FIAT

ENGINES: GSE-T3 - FIAT / GSE-T4 - FIAT

*Performance always compared to market standards. Press release by Tenneco Powertrain - New Tenneco Powertrain Piston Skirt Coatings Increase Durability for the Life of Pistons; Nuremberg, Germany, March 30, 2016.

TERMS OF BUSINESS

IMPORTANT

Reproduction of this catalogue or parts thereof is only allowed with our explicit permission in writing. Pictorial representations and design are copyrighted. Claims for damages, of any form whatsoever, resulting from details made in this catalogue or from incorrect use, application, storage or handling, are explicitly excluded. Contractual rights and any resulting or related claims based thereon, irrespective of form, initially come into being on the basis of a separate written agreement, in particular on the basis of our general terms of sale and delivery.

All former statements lose their validity with the publication of this catalogue.

The catalogue is not an operating manual for the use and installation of pistons, liners and assemblies. It does not contain any advice in a legal sense. The catalogue neither replaces the constantly applicable technical regulations – particularly for tolerances – nor the installation and maintenance stipulations of the individual engine manufacturer.

Also, it is not possible to forego the expertise of those carrying out the installation and application. The individual references made in this catalogue for the installation and the application of pistons, liners and assemblies are instructions solely for the technically qualified specialist and are to be checked and verified by them for their suitability in each case. Tenneco accepts no responsibility for application decisions.

The contents of the catalogue are not intended to create or substitute any contractual agreement which has to be reserved exclusively to a separate agreement between 2 identified parties, whereby seller can be only one of our Tenneco entities as mentioned on the inside back cover.

The right is retained to correct errors and alterations, particularly with regard to amendments in the engine manufacturers' details and stipulations.

ZUR BEACHTUNG

Die Reproduktion dieses Katalogs ist nur mit unserer ausdrücklichen Genehmigung gestattet. Bildliche Darstellungen und der Entwurf sind urheberrechtlich geschützt. Schadenersatzansprüche in jedweder Form unter Berufung auf die Angaben in diesem Katalog oder infolge unsachgemäßen Gebrauchs, unsachgemäßer Anwendung, Lagerung oder Handhabung sind ausdrücklich ausgeschlossen. Vertragliche Rechte und etwaige hieraus folgende oder abgeleitete Ansprüche jedweder Art werden erst durch getrennte schriftliche Vereinbarung, im Besonderen auf der Grundlage unserer allgemeinen Verkaufs- und Lieferbedingungen, begründet.

Mit Erscheinen dieses Katalogs verlieren alle früheren Angaben ihre Gültigkeit.

Der Katalog stellt keine Anleitung für den Gebrauch und den Einbau von Kolben, Laufbuchsen und Zubehör dar. Es werden keine Ratschläge im rechtlichen Sinne abgegeben. Der Katalog ersetzt weder die jeweils geltenden technischen Maßgaben – insbesondere für Toleranzen – noch die Einbau- und Wartungsvorschriften des jeweiligen Motorenherstellers.

Auch ist die Sachkenntnis derer, die den Einbau und die Anwendung vornehmen, eine wesentliche Größe. Die Aussagen in diesem Katalog zum Einbau und Einsatz von Kolben, Laufbuchsen und Baugruppen richten sich ausschließlich an den technisch versierten Fachmann und sind von diesem von Fall zu Fall auf Eignung und Gültigkeit zu überprüfen. Tenneco übernimmt keine Verantwortung für Anwendungsentscheidungen.

Der Inhalt des Katalogs begründet oder ersetzt keine vertragliche Vereinbarung, welche ausschließlich einer getrennten Vereinbarung zwischen zwei bestimmten Parteien vorbehalten sein muss, in der die Verkäuferpartei eine unserer innen im Rückdeckel genannten Tenneco Gesellschaften ist.

Das Recht auf Berichtigung von Irrtümern und Abänderungen, insbesondere hinsichtlich geänderter Angaben und Bestimmungen der Motorenhersteller, bleibt vorbehalten.

IMPORTANTE

La riproduzione di questo catalogo, anche parziale, è permessa soltanto in seguito ad una autorizzazione scritta. I grafici ed i disegni sono depositati e coperti da copyright. Reclami per difetti, di qualsiasi natura essi siano, relativi al contenuto di questo catalogo, o all'uso improprio, verranno respinti. Le pretese avanzate o i reclami dovranno essere in conformità con le nostre condizioni generali di vendita.

Il presente catalogo annulla e sostituisce tutte le edizioni precedenti.

Il catalogo non è un manuale per l'utilizzo ed il montaggio di pistoni, canne e gruppi cilindro. Non contiene indicazioni in questo senso. Esso non sostituisce le descrizioni tecniche, sempre prioritarie, in particolare per le tolleranze, né le istruzioni relative al montaggio ed alla manutenzione date dai costruttori dei rispettivi motori. Non può in nessun caso essere paragonato alla conoscenza professionale necessaria per il montaggio e l'utilizzo. Le considerazioni sul montaggio di pistoni, canne e gruppi cilindro, fatte su questo catalogo, sono destinate esclusivamente a professionisti con formazione tecnica i quali verificheranno l'esattezza delle informazioni, in ogni caso. Le responsabilità derivanti dall'utilizzo improprio dello stesso non potranno essere addebitate alla Tenneco.

I contenuti del catalogo non sostituiscono in alcun modo gli accordi contrattuali che sono riservati esclusivamente a due contraenti definiti; come venditore si intende una delle società Tenneco menzionate sul retro del catalogo.

Ci riserviamo di apportare correzioni e modifiche, relative in particolare, a dati o istruzioni ricevute dal costruttore del motore.

IMPORTANT

La reproduction de ce catalogue, même partielle, n'est autorisée qu'avec notre accord préalable et par écrit. Les illustrations graphiques et la présentation font l'objet d'un copyright. Nous excluons toutes réclamations ayant pour objet ce catalogue ou pouvant résulter de son incompréhension, portant sur de mauvaises utilisations, manipulations, manutentions ou mauvais stockage. Des droits contractuels et des droits dérivés, de quelque nature qu'ils soient, ne peuvent résulter que d'un accord écrit, sur la base de nos conditions générales de ventes et de livraisons.

Ce catalogue annule et remplace toute édition antérieure.

Le catalogue n'est pas une notice d'utilisation et de montage des pistons, chemises et kits. Il ne contient pas de directives en tant que telles. Le catalogue ne remplace ni les prescriptions techniques, toujours prioritaires, particulièrement pour les tolérances, ni les prescriptions de montage et d'entretien des fabricants des moteurs figurant dans ce catalogue. Il ne peut en aucun cas remplacer les connaissances professionnelles nécessaires pour le montage et l'utilisation des produits. Les remarques données pour le montage et l'utilisation des pistons, chemises et kits sont exclusivement destinées au professionnel averti et de formation technique, à qui il appartiendra de vérifier la conformité des indications pour chaque cas. La responsabilité quant aux décisions d'utilisation ne peut être prise en charge par Tenneco.

Le contenu de ce catalogue ne peut constituer ou remplacer un contrat qui doit faire l'objet d'un document séparé établi entre 2 parties, dont l'une doit être une entité légale de Tenneco (dont la liste figure sur la couverture arrière).

Nous nous réservons le droit d'apporter toutes corrections d'erreurs et modifications, suite notamment à de nouvelles données fournies par les constructeurs.

TERMS OF BUSINESS

IMPORTANTE

Queda totalmente prohibida la reproducción, total o parcial, del contenido de este catálogo, salvo previa autorización nuestra, realizada por escrito. Están, asimismo, reservados todos los derechos sobre el diseño y presentación del catálogo. No se aceptará ningún tipo de reclamación que esté basada en la interpretación de los datos contenidos en este catálogo, así como en el incorrecto uso, manipulación o almacenaje de nuestras piezas. Únicamente se aceptarán reclamaciones que estén basadas en derechos contractuales o en los motivos arriba indicados, siempre que exista un acuerdo especial y por escrito basado en nuestras condiciones generales de venta y suministro.

Con la edición de este catálogo queda anulada toda la información contenida en catálogos anteriores.

El catálogo no es un manual para el uso e instalación de los pistones, camisas y equipos, y no representa una asesoría técnica en el sentido legal. Los datos del catálogo no sustituyen, en ningún caso, a las especificaciones técnicas, tanto en lo que se refiere a tolerancias como a las instrucciones de instalación y mantenimiento, indicadas por los fabricantes de los motores, especificaciones que serán siempre prioritarias. Se entiende que el uso y montaje de estas piezas está encomendado a personal debidamente cualificado. Las indicaciones sobre uso y montaje de los pistones, camisas y equipos, contenidas en este catálogo, están exclusivamente dirigidas a profesionales con la debida capacitación y formación técnica, que deben decidir en cada caso sobre la exactitud de las mismas. La responsabilidad de estas decisiones no puede ser, en ningún caso atribuidas a Tenneco.

La información facilitada en el catálogo no representa o sustituye ningún tipo de acuerdo, quedando a tal efecto, el acuerdo por separado entre dos partes donde sólo entidades de Tenneco, pueden ser identificadas como la parte vendedora como se menciona en la contraportada.

Los datos e instrucciones contenidos en este catálogo podrán ser corregidos o modificados sin previo aviso.

WAŻNE

Reprodukcja tego katalogu lub jego części jest możliwa tylko za wyraźną zgodą na piśmie. Ilustracje i grafika są chronione prawem autorskim. Roszczenia dotyczące szkód, niezależnie od formy, wynikających z przedstawionych w tym katalogu treści lub z nieprawidłowego użycia, zastosowania, przechowywania lub obsługi są w sposób wyraźny wyłączone. Prawa umowne i inne wynikające lub związane z roszczeniami na nimi opartymi, niezależnie od formy, są tworzone na podstawie oddzielnej umowy pisemnej, w szczególności na podstawie naszych ogólnych warunków sprzedaży i dostawy. Wszystkie wcześniejsze oświadczenia tracą ważność wraz z opublikowaniem tego katalogu.

Katalog nie jest instrukcją obsługi i instalacji tłoków, tulei i zespołów części cylindrowych. Nie zawiera porad w sensie prawnym. Katalog nie zastępuje obowiązujących uregulowań technicznych – zwłaszcza w zakresie tolerancji – ani opisów montażu i konserwacji poszczególnych producentów silników. Nie jest również możliwe pominięcie doświadczenia osób dokonujących doboru i przeprowadzających montaż części. Poszczególne odniesienia zawarte w tym katalogu, a dotyczące doboru, montażu i stosowania tłoków, tulei i zespołów części cylindrowych, są instrukcjami wyłącznie dla wykwalifikowanego technicznie specjalisty, który w każdym przypadku musi je sprawdzić i zweryfikować ich przydatność. Tenneco nie przyjmuje odpowiedzialności za decyzje dotyczące zastosowania.

Zawartość tego katalogu nie stanowi ani nie zastępuje umowy, która może być zawarta jedynie jako oddzielny dokument podpisany przez dwie strony, przy czym sprzedawcą może być tylko jedna z jednostek koncernu Tenneco, zgodnie z opisem na wewnętrznej stronie tylnej okładki.

Zachowane zostaje prawo korygowania błędów i wprowadzania zmian, zwłaszcza odnośnie zmian dotyczących parametrów i warunków pracy określonych przez producentów silników

ВАЖНО

Копирование данного каталога или его частей допускается исключительно при получении нашего разрешения в письменной форме. Иллюстрации и дизайн защищены авторским правом. Требования о возмещении ущерба любой формы, исходя из содержания каталога или из-за неправильного использования, хранения или обращения, абсолютно исключены. Договорные права и любые результирующие или связанные с этим требования, независимо от их формы, должны являться частью отдельного письменного соглашения и основываться на наших общих условиях продаж и поставок.

Все прежние утверждения теряют свою юридическую силу с момента публикации данного каталога.

Каталог не является руководством пользователя и инструкцией по установке поршней, гильз цилиндров и др. комплектующих. Он не содержит советов в юридическом понимании этого слова. Каталог не является заменой для издаваемых производителями двигателей технических инструкций по ремонту, в особенности для допусков технических величин, а также инструкций по монтажу и регламентному обслуживанию. Отдельные ссылки для установки и замены поршней, гильз цилиндров и др. комплектующих, приведенные в этом каталоге, являются инструкциями исключительно для технически компетентного специалиста и в каждом случае должны быть проверены им на предмет их пригодности. Tenneco не несет ответственность за ремонтные работы.

Содержимое каталога не предназначено для создания или замены любого контрактного соглашения, которое может быть оформлено только в виде отдельного соглашения между двумя установленными сторонами, где продавцом может являться только одно из юридических лиц Tenneco, как упомянуто на внутренней стороне обложки каталога. Tenneco оставляет за собой право вносить исправления и изменения в частности в отношении поправок по деталям изготовителей двигателей и их условиям.

هام

لا يُسمح بنسخ هذا الدليل أو أي جزء منه إلا بتصريح كتابي صريح. جميع التمثيلات التصويرية والتصميمات محفوظة بموجب حقوق الطبع والنشر، ولا تتحمل الشركة صراحة أي مطالبات بخسائر، أيًا كانت صورتها، تنشأ عن التفاصيل الواردة في هذا الدليل أو نتيجة لسوء الاستخدام أو التطبيق أو التخزين أو النقل. أي حقوق تعاقدية أو أي مطالبات لها علاقة بتلك الحقوق أو تنشأ تأسيسًا عليها، بغض النظر عن صورتها، تنشأ تأسيسًا على اتفاق كتابي منفصل، وبخاصة تأسيسًا على شروط البيع والتسليم الخاصة بنا. تفقد كل البيانات السابقة صلاحيتها بمجرد نشر هذا الدليل.

هذا الدليل ليس دليلًا للتشغيل لتوضيح استخدام وتركيب المكابس أو البطانة أو التجميع. كما لا يحتوي على أي نصيحة بالمعنى القانوني، ولا يحل هذا الدليل محل القواعد الفنية المطبقة باستمرار خاصة فيما يتعلق بالتحميل، كما لا يحل محل شروط التركيب والصيانة الخاصة بمصنعي المحركات الفردية. كذلك لا يمكن الاستغناء عن خبرة الفنيين الذين يقومون بالتركيب أو التطبيق. وجميع الإشارات الواردة في هذا الدليل والتي تتعلق بتركيب وتطبيق المكابس والبطانة وعمليات التجميع هي إرشادات للمتخصصين الفنيين المؤهلين فحسب ويتم مراجعتها والتأكد من ملاءمتها في كل حالة على حدة. ولا تتحمل شركة Tenneco أي مسؤولية تتعلق بقرارات التطبيق.

ليس المقصود بمحتوى هذا الدليل أن يخلق أو يستبدل أي اتفاقات تعاقدية يتم الاحتفاظ بها حصريًا في اتفاقية منفصلة بين طرفين محددتين، والتي يمكن أن يكون بموجبها أحد الكيانات التابعة لشركة Tenneco هو الطرف البائع كما هو موضح في الوجه الداخلي للغلاف الخارجي. وتحفظ الشركة بحقها في تصحيح أي أخطاء وإجراء أي تعديلات وبخاصة فيما يتعلق بتعديل تفاصيل مصنع المحرك والأحكام المنصوص عليها.

© All trademarks shown directly above are owned by Tenneco Inc., or one or more of its subsidiaries in one or more countries. All other trademarks are the property of their respective owners. All rights reserved.

 is a trademark of DRIV



FITTED WITH  GOETZE RINGS

HOW TO USE

PEUGEOT

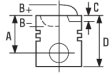

72.00 ²				1 3	
TU1 (H1A/H1B/H3A)	4 Cyl.	1124cc	40kW (54PS)	Petrol	TD2758
TU1M (HDY) ⁴	4 Cyl.	1124cc	40-44kW (54-60PS)	Petrol	¹⁰ TD9404
TU1M (HDZ)	4 Cyl.	1124cc	40kW (54PS)	Petrol	TD4834
106 I 1.1 ³		09/91→04/96		306 1.1	05/93→05/01
205 1.1		08/87→05/97		309 1.1	09/89→10/93
205 I 1.1		08/87→12/94		309 II 1.1	09/89→12/93
205 I 1.1 CJ		10/89→12/94		PARTNER 1.1	06/96→09/05
205 II 1.1		10/87→09/98			

⁵ **87-154300-00** STD

A 40,05
B+ 2,97
D 64,05
20x62 ¹¹



⁶ **08-154300-00** STD
08-154307-00 0,50mm

1.50
2.00
3.00

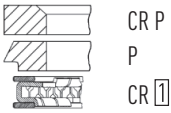

⁷ **14-636470-00** WH ⁸ **B 79.50 C 122.00 D 89.20 E 85.00**

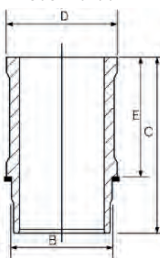

⁹ **88-154300-00**
87-154300-00 +
14-636470-00

¹² Steel
Stahl
Acier
Acciao
Acero

- ¹ Panel No.
- ² Bore size
- ³ Model
- ⁴ Engine
- ⁵ Piston reference
 - A = Compression Height
 - B = Bowl Depth / Crown Height
 - BØ = Bowl Diameter
 - C = Valve Pocket Depth
 - D = Length
 - RT Alfin Insert
 - KK Oil Cooling Gallery
 - AK Oil Jet Cut-out
 - HA Hard Anodised Coating on Crown
 - NB Bronze Pin Bush
 - TP = Trapezoidal Conrod
- ⁶ Ring Set Reference
 - Ring Width
 - Ring Design
 - Ring Surface Treatment and Material
- ⁷ Liner Reference
 - B = Outer Diameter
 - C = Overall Length
 - D = Flange Diameter
 - E = Flange Width
 - F = Firelip Height
- ⁸ Liner Type
 - D = Dry
 - WH = Wet Honed
 - DH = Dry Honed
- ⁹ Assembly reference
- ¹⁰ TecDoc / DRiV engine number
- ¹¹ Piston Image and Casting Number (if applicable)
- ¹² Comment

PART NUMBERING SYSTEM



87 - 114900 - 25	Catalogue reference	Size	Metric	Imperial
87 - 114900 - 25	Piston assembly	00	STD	
88 - 114900 - 25	Kit-set without seals	03	0.125MM	
89 - 114900 - 25	Kit-set with seals	04	0.20MM	
87 - 114900 - 25	Reference	05	0.25MM	.010
87 - 114900 - 25	Size*	06	0.40MM	
87 - 114900 - 25	Version	07	0.50MM	.020
		08	0.60MM	
		09	0.75MM	.030
		10	0.80MM	
		11	1.00MM	.040
		13	1.25MM	
		14	1.50MM	.060
		16	2.00MM	
		17	2.286MM	.090
		20	0.70MM	
		21	0.65MM	
		22	0.30MM	

* If imperial in the past, it continues to be imperial

Feature Codes

RT Alfin Insert	HA Hard Anodized Coating on Crown
KK Oil Cooling Gallery	NB Bronze Pin Bush
AK Oil Jet Cut-out	



PISTON RINGS

08 - 114900 - 00	Catalogue reference
08 - 114900 - 00	Ring set assembly
08 - 114900 - 00	Reference
08 - 114900 - 00	Size* (See Niral pistons table)
08 - 114900 - 00	Version

* If imperial in the past, it continues to be imperial

CYLINDER LINERS

14 - 451160 - 00	Catalogue reference	
14 - 451160 - 00	Cylinder liner	
15 - 451160 - 00	Cylinder liner with seals	01 - 19 = Dry Liner
14 - 451160 - 00	Liner type	20 - 99 = Wet Liner
14 - 451160 - 00	Serial number	
14 - 451160 - 00	Size	0 = STD
14 - 451160 - 00	Version	1 = 1st oversize
		2 = 2nd oversize



COATINGS AND TREATMENT CODES

CR Chromed	P Phosphated
MO Molybdenum inlaid	NT Nitrided
MQL Molybdenum coated	PS Plasma spray coated
CK Chromium-Ceramic-Coated	GDC Goetze Diamond Coated®
PVD Chromium Nitride	DLC Diamond Like Carbon

PISTON RING CROSS SECTIONS

Cross Section	Description
	Plain compression ring
	Plain compression ring (inside bevel - top side)
	Plain compression ring (inside bevel - bottom side)
	Plain compression ring (inside step - top side)
	Plain compression ring (inside step - bottom side)
	Tapered Ring
	Tapered Ring (inside bevel - top side)
	Tapered Ring (inside bevel - bottom side)
	Tapered Ring (inside step - top side)
	Tapered Ring (inside step - bottom side)
	Slightly Tapered Ring
	Slightly Tapered Ring (inside bevel - top side)
	Slightly Tapered Ring (inside bevel - bottom side)
	Slightly Tapered Ring (inside step - top side)
	Slightly Tapered Ring (inside step - bottom side)
	Wedge type compression ring
	Wedge type compression ring (inside bevel - top side)
	Wedge type compression ring (inside bevel - bottom side)
	Wedge type compression ring (inside step - top side)
	Wedge type compression ring (inside step - bottom side)
	Keystone type compression ring
	Keystone type compression ring (inside bevel - top side)
	Keystone type compression ring (inside bevel - bottom side)
	Keystone type compression ring (inside step - top side)
	Keystone type compression ring (inside step - bottom side)
	Taper-faced keystone ring
	Taper-faced keystone ring (inside bevel - top side)
	Taper-faced keystone ring (inside bevel - bottom side)
	Taper-faced keystone ring (inside step - top side)
	Taper-faced keystone ring (inside step - bottom side)
	Single hook scraper
	Single hook scraper (inside bevel - top side)
	Single hook scraper (inside bevel - bottom side)
	Single hook scraper (inside step - top side)
	Single hook scraper (inside step - bottom side)
	Tapered single hook scraper
	Tapered single hook scraper (inside bevel - top side)
	Tapered single hook scraper (inside bevel - bottom side)
	Tapered single hook scraper (inside step - top side)
	Tapered single hook scraper (inside step - bottom side)
	Slotted Oil Scraper ring
	Bevel-edged oil control ring
	Double bevel-edged oil control ring
	Slotted Oil Scraper ring
	Slotted Oil Scraper ring with coil spring
	Bevel-edged oil control ring with coil spring
	Double bevel-edged oil control ring with coil spring
	Slotted Oil Scraper with coil spring
	Steel rail oil control ring with VF spring



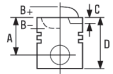

72.00 ²

¹ **3**

TU1 (H1A/H1B/H3A)	4 Cyl.	1124cc	40kW (54PS)	Petrol	TD2758
TU1M (HDY) ⁴	4 Cyl.	1124cc	40-44kW (54-60PS)	Petrol	10 TD9404
TU1M (HDZ)	4 Cyl.	1124cc	40kW (54PS)	Petrol	TD4834
106 I 1.1 ³		09/91→04/96		306 1.1	05/93→05/01
205 1.1		08/87→05/97		309 1.1	09/89→10/93
205 I 1.1		08/87→12/94		309 II 1.1	09/89→12/93
205 I 1.1 CJ		10/89→12/94		PARTNER 1.1	06/96→09/05
205 II 1.1		10/87→09/98			

⁵ **87-154300-00** STD

A 40,05
B+ 2,97
D 64,05
 RT = 20x62

¹¹



☐Stahl ¹²

⁶ **08-154300-00** STD
08-154307-00 0,50mm

1.50 CR P
 2.00 P
 3.00 CR ☐

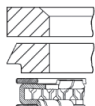

☐Acier

⁷ **14-636470-00** WH ⁸ **B 79.50 C 122.00 D 89.20 E 85.00**

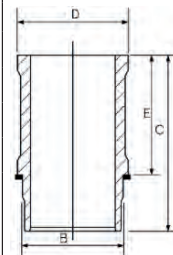

☐Acciao

⁹ **88-154300-00**
 87-154300-00 +
 14-636470-00

☐Acero

- ¹ Infotafel
- ² Bohrung
- ³ Modell
- ⁴ Motor
- ⁵ Artikelnummer Kolben
 - A = Kompressionshöhe
 - B = Muldentiefe / Bodenhöhe
 - BØ = Muldendurchmesser
 - C = Ventiltaschentiefe
 - D = Länge
 - RT = Ringträger
 - KK Ölkühlkanal
 - AK Öldüsenausparung
 - HA Hartanodisierter Kolbenboden
 - NB Bolzenbuchse aus Bronze
 - TP = Trapezpleuel
- ⁶ Artikelnummer Kolbenringsatz
 - Ringhöhe
 - Ringbauart
 - Ringoberflächenbehandlung und Material
- ⁷ Artikelnummer Laufbuchse
 - B = Außendurchmesser
 - C = Gesamtlänge
 - D = Bunddurchmesser
 - E = Bundbreite
 - F = Feuersteghöhe
- ⁸ Laufbuchsentyp
 - D = trocken
 - WH = nass, gehont
 - DH = trocken, gehont
- ⁹ Artikelnummer Assembly
- ¹⁰ TecDoc-Nr. / DRIV-Motornummer
- ¹¹ Kolbenabbildung und Kokille (gegebenenfalls)
- ¹² Kommentar

TEILENUMMERIERUNGSSYSTEM



87 - 114900 - 25	Artikelnummer	Größe	Metrisch	Britische
87 - 114900 - 25	Assembly	00	STD	Maßeinheiten
88 - 114900 - 25	Assembly ohne Abdichtungen	03	0.125MM	
89 - 114900 - 25	Assembly mit Abdichtungen	04	0.20MM	
87 - 114900 - 25	Artikelnummer	05	0.25MM	.010
87 - 114900 - 25	Größe*	06	0.40MM	
87 - 114900 - 25	Version	07	0.50MM	.020
		08	0.60MM	
		09	0.75MM	.030
		10	0.80MM	
		11	1.00MM	.040
		13	1.25MM	
		14	1.50MM	.060
		16	2.00MM	
		17	2.286MM	.090
		20	0.70MM	
		21	0.65MM	
		22	0.30MM	

* Falls Maßangaben bisher nach Britischer Norm waren, werden sie weiterhin so angegeben

Kurzzeichen Ausstattung

RT	Rinträger	HA	Hartanodisierter
KK	Ölkühlkanal		Kolbenboden
AK	Öldüsenausparung	NB	Botzenbuchse aus Bronze



KOLBENRINGE

08 - 114900 - 00	Artikelnummer im Katalog
08 - 114900 - 00	Kolbenringsatz
08 - 114900 - 00	Referenz
08 - 114900 - 00	Größe* (siehe Niral-Kolbentabelle)
08 - 114900 - 00	Version

* Falls Maßangaben bisher nach Britischer Norm waren, werden sie weiterhin so angegeben

ZYLINDERLAUFBUCHSEN

14 - 451160 - 00	Artikelnummer	01 - 19 = Trockene
14 - 451160 - 00	Zylinderlaufbuchse	Zylinderlaufbuchse
15 - 451160 - 00	Zylinderlaufbuchse mit Abdichtung	20 - 99 = Nasse
14 - 451160 - 00	Laufbuchsentyp	Zylinderlaufbuchse
14 - 451160 - 00	Seriennummer	
14 - 451160 - 00	Größe	0 = STD
14 - 451160 - 00	Version	1 = 1. Übergröße
		2 = 2. Übergröße



KURZZEICHEN BESCHICHTUNGEN UND BEHANDLUNGEN

CR	Verchromt	P	Phosphatiert
MO	Lauffläche teilweise mit Molybdän beschichtet	NT	Nitriert
MOL	Molybdän beschichtet	PS	Plasmaspritzbeschichtet
CK	Chrom-Keramik beschichtet	GDC	Goetze Diamond Coated®
PVD	Chromnitrid	DLC	Diamantähnlicher Kohlenstoff

KOLBENRINGQUERSCHNITTE

Querschnitt	Beschreibung
	Rechteckring
	Rechteckring (mit Innenfase an der Oberflanke)
	Rechteckring (mit Innenfase an der Unterflanke)
	Rechteckring (mit Innenwinkel an der Oberflanke)
	Rechteckring (mit Innenwinkel an der Unterflanke)
	Minutenring
	Minutenring (mit Innenfase an der Oberflanke)
	Minutenring (mit Innenfase an der Unterflanke)
	Minutenring (mit Innenwinkel an der Oberflanke)
	Minutenring (mit Innenwinkel an der Unterflanke)
	Schwachminutenring
	Schwachminutenring (mit Innenfase an der Oberflanke)
	Schwachminutenring (mit Innenfase an der Unterflanke)
	Schwachminutenring (mit Innenwinkel an der Oberflanke)
	Schwachminutenring (mit Innenwinkel an der Unterflanke)
	Einseitiger Trapezring
	Einseitiger Trapezring (mit Innenfase an der Oberflanke)
	Einseitiger Trapezring (mit Innenfase an der Unterflanke)
	Einseitiger Trapezring (mit Innenwinkel an der Oberflanke)
	Einseitiger Trapezring (mit Innenwinkel an der Unterflanke)
	Doppeltrapezring
	Doppeltrapezring (mit Innenfase an der Oberflanke)
	Doppeltrapezring (mit Innenfase an der Unterflanke)
	Doppeltrapezring (mit Innenwinkel an der Oberflanke)
	Doppeltrapezring (mit Innenwinkel an der Unterflanke)
	Doppeltrapezring mit konischer Lauffläche
	Doppeltrapezring mit konischer Lauffläche (Innenfase an der Oberflanke)
	Doppeltrapezring mit konischer Lauffläche (Innenfase an der Unterflanke)
	Doppeltrapezring mit konischer Lauffläche (Innenwinkel an der Oberflanke)
	Doppeltrapezring mit konischer Lauffläche (Innenwinkel an der Unterflanke)
	Nasenring
	Nasenring (mit Innenfase an der Oberflanke)
	Nasenring (mit Innenfase an der Unterflanke)
	Nasenring (mit Innenwinkel an der Oberflanke)
	Nasenring (mit Innenwinkel an der Unterflanke)
	Nasen-Minutenring
	Nasen-Minutenring (mit Innenfase an der Oberflanke)
	Nasen-Minutenring (mit Innenfase an der Unterflanke)
	Nasen-Minutenring (mit Innenwinkel an der Oberflanke)
	Nasen-Minutenring (mit Innenwinkel an der Unterflanke)
	Ölschlitzring
	Dachfasenring
	Gleichfasenring
	Ölschlitzring
	Ölschlitzring mit Schlauchfeder
	Dachfasenring mit Schlauchfeder
	Gleichfasenring mit Schlauchfeder
	Ölschlitzring mit Schlauchfeder
	Ölabstreif-Stahlbandring mit VF-Feder



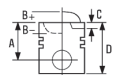

72.00 ² 1 3

TU1 (H1A/H1B/H3A)	4 Cyl.	1124cc	40kW (54PS)	Petrol	TD2758
TU1M (HDY) ⁴	4 Cyl.	1124cc	40-44kW (54-60PS)	Petrol	10 TD9404
TU1M (HDZ)	4 Cyl.	1124cc	40kW (54PS)	Petrol	TD4834

106 I 1.1 ³	09/91→04/96	306 1.1	05/93→05/01
205 1.1	08/87→05/97	309 1.1	09/89→10/93
205 I 1.1	08/87→12/94	309 II 1.1	09/89→12/93
205 I 1.1 CJ	10/89→12/94	PARTNER 1.1	06/96→09/05
205 II 1.1	10/87→09/98		

⁵ **87-154300-00** STD

A 40,05
B+ 2,97
D 64,05
20x62 ¹¹

Steel ¹² Stahl

⁶ **08-154300-00** STD
08-154307-00 0,50mm

1.50
2.00
3.00

Acier

⁷ **14-636470-00** WH ⁸ **B 79.50 C 122.00 D 89.20 E 85.00**

Acciaio

⁹ **88-154300-00**
87-154300-00 +
14-636470-00

Acero

- ¹ N. Pannello
- ² Alesaggio
- ³ Modello
- ⁴ Motore
- ⁵ Codice Pistone
 - A = Altezza di compressione
 - B = Profondità Camera di Combustione/Sporgenza testa
 - BØ = Diametro Camera di Combustione
 - C = Profondità Sedi Valvole
 - D = Lunghezza
 - RT Inserto Alfin
 - KK Galleria di raffreddamento dell'olio
 - AK Getto olio
 - HA Rivestimento di Anodizzazione sulla Testa del Pistone
 - NB Boccola Foro Spinotto in Bronzo
 - TP = Biella Trapezoidale
- ⁶ Codice Set Segmenti
 - Altezza Segmento
 - Forma Segmento
 - Materiale e Trattamento Superficiale Segmento
- ⁷ Codice Canna Cilindro
 - B = Diametro Esterno
 - C = Lunghezza Totale
 - D = Diametro Flangia
 - E = Larghezza Flangia
 - F = Altezza Parafiamma
- ⁸ Tipo Canna Cilindro
 - D = A Secco
 - WH = Riportata in Umido
 - DH = Riportata a Secco
- ⁹ Codice Gruppo
- ¹⁰ TecDoc / DRiV numero motore
- ¹¹ Immagine Pistone e Numero di Fusione (se applicabile)
- ¹² Note

SISTEMA DI CATALOGAZIONE DEI RICAMBI



87 - 114900 - 25
87 - 114900 - 25
88 - 114900 - 25
89 - 114900 - 25
87 - 114900 - 25
87 - 114900 - 25
87 - 114900 - 25

Codice catalogo
Gruppo pistone
Kit-set senza guarnizioni
Kit-set con guarnizioni
Codice
Dimensioni*
Versione

Dimensioni	Metrie	Imperiali
00	STD	
03	0.125MM	
04	0.20MM	
05	0.25MM	.010
06	0.40MM	
07	0.50MM	.020
08	0.60MM	
09	0.75MM	.030
10	0.80MM	
11	1.00MM	.040
13	1.25MM	
14	1.50MM	.060
16	2.00MM	
17	2.286MM	.090
20	0.70MM	
21	0.65MM	
22	0.30MM	

* Se precedentemente indicato in misure imperiali, rimane tale

Codici Caratteristiche

HA	Rivestimento
RT	Inserito Alfin
KK	Galleria di raffreddamento dell'olio
AK	Getto olio
NB	Boccola Foro Spinotto in Bronzo
	Anodizzazione su Testa Pistone



SEGMENTI PISTONE

08 - 114900 - 00
08 - 114900 - 00
08 - 114900 - 00
08 - 114900 - 00
08 - 114900 - 00

Codice catalogo
Assieme set segmenti
Codice
Dimensioni* (Vedi tabella pistoni Niral)
Versione

* Se precedentemente indicato in misure imperiali, rimane tale

CANNE CILINDRO

14 - 451160 - 00
14 - 451160 - 00
15 - 451160 - 00
14 - 451160 - 00
14 - 451160 - 00
14 - 451160 - 00
14 - 451160 - 00

Codice catalogo
Canna cilindro
Canna cilindro con guarnizione
Tipo canna cilindro
Numero di seriale
Dimensioni
Versione

01 - 19 = Canna a secco
20 - 99 = Canna in umido

0 = STD
1 = 1° maggiorazione
2 = 2° maggiorazione



CODICI RIVESTIMENTI E TRATTAMENTI

CR	Cromato	P	Fosfatato
MO	Inserito in molibdeno	NT	Nitrurato
MQL	Rivestimento in molibdeno	PS	Rivestimento a getto di plasma
CK	Nitrato de cromo	GDC	Rivestimento Goetze Diamond Coated®
PVD	Carbonio diamantato	DLC	Carbonio diamantato

SEZIONE SEGMENTI PISTONE

Sezione	Descrizione
	Segmento di compressione rettangolare
	Segmento di compressione rettangolare con smusso interno - lato superiore
	Segmento di compressione rettangolare con smusso interno - lato inferiore
	Segmento di compressione rettangolare con gradino interno - lato superiore
	Segmento di compressione rettangolare con gradino interno - lato inferiore
	Segmento Conico
	Segmento Conico con smusso interno - lato superiore
	Segmento Conico con smusso interno - lato inferiore
	Segmento Conico con gradino interno - lato superiore
	Segmento Conico con gradino interno - lato inferiore
	Segmento Leggermente Conico
	Segmento Leggermente Conico con smusso interno - lato superiore
	Segmento Leggermente Conico con smusso interno - lato inferiore
	Segmento Leggermente Conico con gradino interno - lato superiore
	Segmento Leggermente Conico con gradino interno - lato inferiore
	Segmento di compressione di tipo a cuneo
	Segmento di compressione di tipo a cuneo con smusso interno - lato superiore
	Segmento di compressione di tipo a cuneo con smusso interno - lato inferiore
	Segmento di compressione di tipo a cuneo con gradino interno - lato superiore
	Segmento di compressione di tipo a cuneo con gradino interno - lato inferiore
	Segmento di compressione a sezione trapezoidale
	Segmento di compressione a sezione trapezoidale con smusso interno - lato superiore
	Segmento di compressione a sezione trapezoidale con smusso interno - lato inferiore
	Segmento di compressione a sezione trapezoidale con gradino interno - lato superiore
	Segmento di compressione a sezione trapezoidale con gradino interno - lato inferiore
	Segmento di compressione a sezione trapezoidale con fianchi inclinati
	Segmento di compressione a sezione trapezoidale con fianchi inclinati con smusso interno - lato superiore
	Segmento di compressione a sezione trapezoidale con fianchi inclinati con smusso interno - lato inferiore
	Segmento di compressione a sezione trapezoidale con fianchi inclinati con gradino interno - lato superiore
	Segmento di compressione a sezione trapezoidale con fianchi inclinati con gradino interno - lato inferiore
	Segmento raschiaolio
	Segmento raschiaolio con smusso interno - lato superiore
	Segmento raschiaolio con smusso interno - lato inferiore
	Segmento raschiaolio con gradino interno - lato superiore
	Segmento raschiaolio con gradino interno - lato inferiore
	Segmento raschiaolio conico
	Segmento raschiaolio conico con smusso interno - lato superiore
	Segmento raschiaolio conico con smusso interno - lato inferiore
	Segmento raschiaolio conico con gradino interno - lato superiore
	Segmento raschiaolio conico con gradino interno - lato inferiore
	Segmento raschiaolio con fori
	Segmento raschiaolio con pattini smussati
	Segmento raschiaolio con smussi convergenti
	Segmento raschiaolio con fori
	Segmento raschiaolio con fori e con molla
	Segmento raschiaolio con smussi paralleli e con molla
	Segmento raschiaolio con doppio bordo smussato e con molla
	Segmento raschiaolio con fori e con molla
	Segmento raschiaolio con guida in acciaio e con molla VF

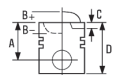

72.00 ²				1 3	
TU1 (H1A/H1B/H3A)	4 Cyl.	1124cc	40kW (54PS)	Petrol	TD2758
TU1M (HDY) ⁴	4 Cyl.	1124cc	40-44kW (54-60PS)	Petrol	10 TD9404
TU1M (HDZ)	4 Cyl.	1124cc	40kW (54PS)	Petrol	TD4834
106 I 1.1 ³		09/91→04/96		306 1.1	05/93→05/01
205 1.1		08/87→05/97		309 1.1	09/89→10/93
205 I 1.1		08/87→12/94		309 II 1.1	09/89→12/93
205 I 1.1 CJ		10/89→12/94		PARTNER 1.1	06/96→09/05
205 II 1.1		10/87→09/98			

⁵
87-154300-00 STD

A 40,05
B+ 2,97
D 64,05
20x62



¹¹

⁶
08-154300-00 STD
08-154307-00 0,50mm

1.50
2.00
3.00



CR P
P
CR ¹

⁷ ⁸
14-636470-00 WH **B 79.50 C 122.00 D 89.20 E 85.00**

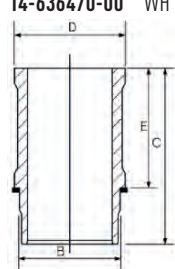

¹² Steel ¹² Stahl ¹² Acier ¹² Acciao ¹² Acero

⁹
88-154300-00
87-154300-00 +
14-636470-00

- ¹ Numéro d'encadré
- ² Alésage
- ³ Modèle
- ⁴ Moteur
- ⁵ Référence du piston
 - A = Hauteur d'axe
 - B = Profondeur de la chambre / Hauteur du bossage
 - BØ = Diamètre de la chambre du piston
 - C = Passage de la soupape
 - D = Longueur totale
 - RT Piston à porte-segments
 - KK Canal de refroidissement
 - AK Dégagement pour gicleur d'huile de refroidissement
 - HA Tête endurcie par oxydation
 - NB Bague en bronze
 - TP = Bielle trapézoïdale
- ⁶ Référence du jeu de segments
 - Largeur de segment
 - Schémas des segments
 - Traitement de surface et matériau
- ⁷ Référence de chemise
 - B = Diamètre extérieur
 - C = Longueur totale
 - D = Diamètre bride
 - E = Largeur de collerette
 - F = Hauteur du parefeu
- ⁸ Type chemise
 - D = Sèche
 - WH = Chemise humide
 - DH = Chemise sèche
- ⁹ Référence du kit (piston+chemise)
- ¹⁰ Numéro moteur DRiV / Numéro TecDoc
- ¹¹ Image piston et numéro coquille (si applicable)
- ¹² Commentaires

SYSTÈME DE CODIFICATION



87 - 114900 - 25	Référence au catalogue	
87 - 114900 - 25	Piston	
88 - 114900 - 25	Kit sans joint	
89 - 114900 - 25	Kit avec joint	
87 - 114900 - 25	Référence	
87 - 114900 - 25	Dimension*	→
87 - 114900 - 25	Version	

* Si la mesure était en pouce auparavant, elle reste en pouce

Codes caractéristiques

RT Piston à porte-segments	HA Tête durcie par oxydation
KK Canal de refroidissement	NB Bague en bronze
AK Dégagement pour gicleur d'huile	

Dim.	Cote métrique	Cote anglaise (en pouces)
00	STD	
03	0.125MM	
04	0.20MM	
05	0.25MM	.010
06	0.40MM	
07	0.50MM	.020
08	0.60MM	
09	0.75MM	.030
10	0.80MM	
11	1.00MM	.040
13	1.25MM	
14	1.50MM	.060
16	2.00MM	
17	2.286MM	.090
20	0.70MM	
21	0.65MM	
22	0.30MM	



SEGMENTS

08 - 114900 - 00	Référence au catalogue	
08 - 114900 - 00	Segments	
08 - 114900 - 00	Référence	
08 - 114900 - 00	Dimension* (Voir tableau des pistons Niral)	
08 - 114900 - 00	Version	

* Si la mesure était en pouce auparavant, elle reste en pouce

CHEMISES DE CYLINDRE

14 - 451160 - 00	Référence au catalogue	
14 - 451160 - 00	Chemise de cylindre	
15 - 451160 - 00	Chemise de cylindre avec joint de chemise	01 - 19 = Chemise sèche 20 - 99 = Chemise humide
14 - 451160 - 00	Type de chemise	→
14 - 451160 - 00	Numéro de série	
14 - 451160 - 00	Dimension	→
14 - 451160 - 00	Version	0 = STD 1 = 1ère cote réparation 2 = 2ème cote réparation



TYPES DE REVÊTEMENTS ET TRAITEMENT DE SURFACE

CR Chromée	P Phosphaté
MO Avec apport de molybdène	NT Nitridé
MOL Revêtement molybdène	PS Revêtement par projection plasma
CK Revêtement chrome-céramique	GDC Revêtement renforcé au diamant GDC®
PVD Nitrure de chrome	DLC Carbone diamant amorphe

SECTIONS SEGMENTS DE PISTON

Section	Description
	Segment rectangulaire
	segment rectangulaire (Chanfrein intérieur - flanc supérieur)
	segment rectangulaire (Chanfrein intérieur - flanc inférieur)
	segment rectangulaire (Angle intérieur - flanc supérieur)
	segment rectangulaire (Angle intérieur - flanc inférieur)
	Segment conique
	Segment conique (Chanfrein intérieur - flanc supérieur)
	Segment conique (Chanfrein intérieur - flanc inférieur)
	Segment conique (Angle intérieur - flanc supérieur)
	Segment conique (Angle intérieur - flanc inférieur)
	Segment faiblement conique
	Segment faiblement conique (Chanfrein intérieur - flanc supérieur)
	Segment faiblement conique (Chanfrein intérieur - flanc inférieur)
	Segment faiblement conique (Angle intérieur - flanc supérieur)
	Segment faiblement conique (Angle intérieur - flanc inférieur)
	Segment semi-trapézoïdal
	Segment semi-trapézoïdal (Chanfrein intérieur - flanc supérieur)
	Segment semi-trapézoïdal (Chanfrein intérieur - flanc inférieur)
	Segment semi-trapézoïdal (Angle intérieur - flanc supérieur)
	Segment semi-trapézoïdal (Angle intérieur - flanc inférieur)
	Segment trapézoïdal
	Segment trapézoïdal (Chanfrein intérieur - flanc supérieur)
	Segment trapézoïdal (Chanfrein intérieur - flanc inférieur)
	Segment trapézoïdal (Angle intérieur - flanc supérieur)
	Segment trapézoïdal (Angle intérieur - flanc inférieur)
	Segment trapézoïdal avec face portante conique
	Segment trapézoïdal avec face portante conique (Chanfrein intérieur - flanc supérieur)
	Segment trapézoïdal avec face portante conique (Chanfrein intérieur - flanc inférieur)
	Segment trapézoïdal avec face portante conique (Angle intérieur - flanc supérieur)
	Segment trapézoïdal avec face portante conique (Angle intérieur - flanc inférieur)
	Racleur à bec d'aigle
	Racleur à bec d'aigle (Chanfrein intérieur - flanc supérieur)
	Racleur à bec d'aigle (Chanfrein intérieur - flanc inférieur)
	Racleur à bec d'aigle (Angle intérieur - flanc supérieur)
	Racleur à bec d'aigle (Angle intérieur - flanc inférieur)
	Racleur conique à bec d'aigle
	Racleur conique à bec d'aigle (Chanfrein intérieur - flanc supérieur)
	Racleur conique à bec d'aigle (Chanfrein intérieur - flanc inférieur)
	Racleur conique à bec d'aigle (Angle intérieur - flanc supérieur)
	Racleur conique à bec d'aigle (Angle intérieur - flanc inférieur)
	Segment racleur à lumières
	Segment racleur à lumières et lèvres chanfreinées symétriques
	Segment racleur à lumières et lèvres chanfreinées parallèles
	Segment racleur à lumières
	Segment racleur à lumières avec ressort spiroïdal
	Segment racleur à lumières et lèvres chanfreinées symétriques avec ressort spiroïdal
	Segment racleur à lumières et lèvres chanfreinées parallèles avec ressort spiroïdal
	Segment racleur à lumières avec ressort spiroïdal
	Segment racleur à lames d'acier avec ressort spiroïdal VF

🇪🇸 CÓMO UTILIZAR ESTE CATÁLOGO

PEUGEOT

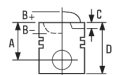

72.00 ²

¹ **3**

TU1 (H1A/H1B/H3A)	4 Cyl.	1124cc	40kW (54PS)	Petrol	TD2758
TU1M (HDY) ⁴	4 Cyl.	1124cc	40-44kW (54-60PS)	Petrol	¹⁰ TD9404
TU1M (HDZ)	4 Cyl.	1124cc	40kW (54PS)	Petrol	TD4834
106 I 1.1 ³		09/91→04/96		306 1.1	05/93→05/01
205 1.1		08/87→05/97		309 1.1	09/89→10/93
205 I 1.1		08/87→12/94		309 II 1.1	09/89→12/93
205 I 1.1 CJ		10/89→12/94		PARTNER 1.1	06/96→09/05
205 II 1.1		10/87→09/98			

⁵ **87-154300-00** STD

A 40,05
B+ 2,97
D 64,05
 BØ 20x62

¹¹



Steel ¹² Stahl

⁶ **08-154300-00** STD
08-154307-00 0,50mm

1.50 CR P
 2.00 P
 3.00 CR ¹

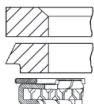

Acier

⁷ **14-636470-00** WH ⁸ **B 79.50 C 122.00 D 89.20 E 85.00**

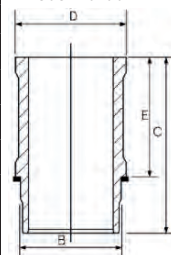

Acciao

⁹ **88-154300-00**
 87-154300-00 +
 14-636470-00

Acero

- ¹ N.º panel
- ² Tamaño del diámetro
- ³ Modelo
- ⁴ Motor
- ⁵ Referencia del pistón
 - A = Altura de compresión
 - B = Profundidad de la cabeza / Altura de la corona
 - BØ = Diámetro de la cabeza
 - C = Profundidad bolsa de válvula
 - D = Longitud
 - RT Inserción alfin
 - KK Conductos de refrigeración de aceite
 - AK Corte del inyector de aceite
 - HA Revestimiento duro anodizado en la corona
 - NB Casquillo de bronce
 - TP = Cabeza de biela trapezoidal
- ⁶ Referencia del conjunto de segmentos
 - Anchura del segmento
 - Diseño del segmento
 - Material y tratamiento de la superficie del segmento
- ⁷ Referencia de la camisa
 - B = Diámetro exterior
 - C = Longitud general
 - D = Diámetro de la brida
 - E = Anchura de la brida
 - F = Altura cortafuego
- ⁸ Tipo de camisa
 - D = Seca
 - WH = Alisada húmeda
 - DH = Alisada seca
- ⁹ Referencia del conjunto
- ¹⁰ Número motor DRiV / TecDoc
- ¹¹ Número de moldeado e imagen del pistón (si procede)
- ¹² Comentario

SISTEMA DE NUMERACIÓN DE REFERENCIAS



87 - 114900 - 25	Referencia del catálogo	Tamaño	Sistema métrico	Imperial
87 - 114900 - 25	Conjunto de pistón	00	STD	
88 - 114900 - 25	Conjunto sin retenes	03	0.125MM	
89 - 114900 - 25	Conjunto con retenes	04	0.20MM	
87 - 114900 - 25	Referencia	05	0.25MM	.010
87 - 114900 - 25	Tamaño* →	06	0.40MM	
87 - 114900 - 25	Versión	07	0.50MM	.020
		08	0.60MM	
		09	0.75MM	.030
		10	0.80MM	
		11	1.00MM	.040
		13	1.25MM	
		14	1.50MM	.060
		16	2.00MM	
		17	2.286MM	.090
		20	0.70MM	
		21	0.65MM	
		22	0.30MM	

* Si anteriormente se utilizó el sistema imperial, sigue siendo el sistema imperial

Códigos de característica	AK	Corte del inyector de aceite	
RT	Inserción alfin	HA	Revestimiento duro
KK	Conductos de refrigeración de aceite	NB	Perno de bronce



SEGMENTOS DE PISTÓN

08 - 114900 - 00	Referencia del catálogo
08 - 114900 - 00	Conjunto de segmentos
08 - 114900 - 00	Referencia
08 - 114900 - 00	Tamaño* (ver la tabla de pistones Niral)
08 - 114900 - 00	Versión

* Si anteriormente se utilizó el sistema imperial, sigue siendo el sistema imperial

CAMISAS

14 - 451160 - 00	Referencia del catálogo	
14 - 451160 - 00	Camisa	
15 - 451160 - 00	Camisa con junta	
14 - 451160 - 00	Tipo de camisa →	01 - 19 = Camisa seca 20 - 99 = Camisa húmeda
14 - 451160 - 00	Número de serie	
14 - 451160 - 00	Tamaño →	0 = Estándar 1 = Primera sobredimensión 2 = Segunda sobredimensión
14 - 451160 - 00	Versión	



CÓDIGOS DE TRATAMIENTO Y REVESTIMIENTO

CR	Cromado	P	Fosfatado
MO	Incrustación de molibdeno	NT	Nitrurado
MOL	Revestimiento de molibdeno	PS	Revestimiento de pulverización de plasma
CK	Revestimiento cerámico de cromo	GDC	Diamond Coated® de Goetze
PVD	Nitruro de cromo	DLC	Carbon adiamantado

SECCIONES TRANSVERSALES DE LOS SEGMENTOS







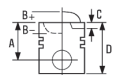

Sección transversal	Descripción
	Segmento de compresión plano
	Segmento de compresión plano (bisel interior, lado superior)
	Segmento de compresión plano (bisel interior, lado inferior)
	Segmento de compresión plano (paso interior, lado superior)
	Segmento de compresión plano (paso interior, lado inferior)
	Segmento cónico
	Segmento cónico (bisel interior, lado superior)
	Segmento cónico (bisel interior, lado inferior)
	Segmento cónico (paso interior, lado superior)
	Segmento cónico (paso interior, lado inferior)
	Segmento ligeramente cónico
	Segmento ligeramente cónico (bisel interior, lado superior)
	Segmento ligeramente cónico (bisel interior, lado inferior)
	Segmento ligeramente cónico (paso interior, lado superior)
	Segmento ligeramente cónico (paso interior, lado inferior)
	Segmento de compresión tipo cuña
	Segmento de compresión tipo cuña (bisel interior, lado superior)
	Segmento de compresión tipo cuña (bisel interior, lado inferior)
	Segmento de compresión tipo cuña (paso interior, lado superior)
	Segmento de compresión tipo cuña (paso interior, lado inferior)
	Segmento de compresión tipo trapecoidal
	Segmento de compresión tipo trapecoidal (bisel interior, lado superior)
	Segmento de compresión tipo trapecoidal (bisel interior, lado inferior)
	Segmento de compresión tipo trapecoidal (paso interior, lado superior)
	Segmento de compresión tipo trapecoidal (paso interior, lado inferior)
	Segmento trapecoidal con superficie de cuña
	Segmento trapecoidal con superficie de cuña (bisel interior, lado superior)
	Segmento trapecoidal con superficie de cuña (bisel interior, lado inferior)
	Segmento trapecoidal con superficie de cuña (paso interior, lado superior)
	Segmento trapecoidal con superficie de cuña (paso interior, lado inferior)
	Rascador de gancho simple
	Rascador de gancho simple (bisel interior, lado superior)
	Rascador de gancho simple (bisel interior, lado inferior)
	Rascador de gancho simple (paso interior, lado superior)
	Rascador de gancho simple (paso interior, lado inferior)
	Rascador de gancho simple cónico
	Rascador de gancho simple cónico (bisel interior, lado superior)
	Rascador de gancho simple cónico (bisel interior, lado inferior)
	Rascador de gancho simple cónico (paso interior, lado superior)
	Rascador de gancho simple cónico (paso interior, lado inferior)
	Rascador de aceite ranurado
	Segmento de control de aceite con lado en bisel
	Segmento de control de aceite con dos lados en bisel
	Rascador de aceite ranurado
	Rascador de aceite ranurado con muelle en espiral
	Segmento de control de aceite con lado en bisel y muelle en espiral
	Segmento de control de aceite con dos lados en bisel y muelle en espiral
	Rascador de aceite ranurado con muelle en espiral
	Segmento de control de aceite y rail de acero con muelle VF

JAK UŻYWAĆ TEGO KATALOGU

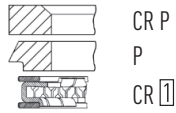
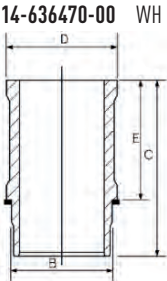
PEUGEOT



72.00 ²				1 3	
TU1 (H1A/H1B/H3A)	4 Cyl.	1124cc	40kW (54PS)	Petrol	TD2758
TU1M (HDY) ⁴	4 Cyl.	1124cc	40-44kW (54-60PS)	Petrol	¹⁰ TD9404
TU1M (HDZ)	4 Cyl.	1124cc	40kW (54PS)	Petrol	TD4834
106 I 1.1 ³		09/91→04/96		306 1.1	05/93→05/01
205 1.1		08/87→05/97		309 1.1	09/89→10/93
205 I 1.1		08/87→12/94		309 II 1.1	09/89→12/93
205 I 1.1 CJ		10/89→12/94		PARTNER 1.1	06/96→09/05
205 II 1.1		10/87→09/98			

⁵ 87-154300-00 STD		⁶ 08-154300-00 STD 08-154307-00 0,50mm		⁷ 14-636470-00 WH		⁸ B 79.50 C 122.00 D 89.20 E 85.00		⁹ 88-154300-00 87-154300-00 + 14-636470-00	
A	40,05								
B+	2,97								
D	64,05								
	20x62								
	¹¹	1.50		CR P					
		2.00		P					
		3.00		CR ¹					
	¹²								

- ¹ Numer panelu
- ² Średnica cylindra
- ³ Model
- ⁴ Silnik
- ⁵ Numer referencyjny tłoka
 - A = wysokość kompresyjna
 - B = Głębokość komory w tłoku/ Wysokość korony
 - BØ = Średnica komory w tłoku
 - C = Głębokość zagłębienie zaworowego
 - D = Długość
 - RT Wkładka alfinowa
 - KK Olejowa galeria chłodząca
 - AK Wycięcie natrysku olejowego
 - HA Warstwa utwardzenia anodowego na koronie
 - NB Tuleja sworznia z brązu
 - TP = Korbowód trapezowy

- ⁶ Numer referencyjny zestawu pierścieni
 - Szerokość pierścienia
 - Konstrukcja pierścienia
 - Obróbka powierzchni pierścienia i rodzaj materiału
- ⁷ Numer referencyjny tulei cylindrowej
 - C = Średnica zewnętrzna
 - C = Długość całkowita
 - D = Średnica kołnierza
 - E = Szerokość kołnierza
 - F = Wysokość odsadzenia
- ⁸ Typ tulei cylindrowej
 - D = Sucha
 - WH = Mokra honowana
 - DH = Sucha honowana
- ⁹ Numer referencyjny zestawu
- ¹⁰ Numer silnika TecDoc/DRIV
- ¹¹ Rysunek tłoka i numer odlewu (jeśli występuje)
- ¹² Uwagi

SYSTEM NUMEROWANIA CZĘŚCI



87 - 114900 - 25	Katalogowy numer referencyjny	Rozmiar	Metryczny	Angielski
87 - 114900 - 25	Zestaw tłoka	00	STD	
88 - 114900 - 25	Zestaw bez uszczelnień	03	0.125MM	
89 - 114900 - 25	Zestaw z uszczelnieniami	04	0.20MM	
87 - 114900 - 25	Numer części	05	0.25MM	.010
87 - 114900 - 25	Wielkość*	06	0.40MM	
87 - 114900 - 25	Wersja	07	0.50MM	.020
		08	0.60MM	
		09	0.75MM	.030
		10	0.80MM	
		11	1.00MM	.040
		13	1.25MM	
		14	1.50MM	.060
		16	2.00MM	
		17	2.286MM	.090
		20	0.70MM	
		21	0.65MM	
		22	0.30MM	

* Jeśli w przeszłości był system angielski, nadal stosowany jest system angielski

Oznaczenia cech charakterystycznych

RT	Wkładka alfinowa	HA	Warstwa utwardzenia
KK	Olejowa galeria chłodząca		anodowego na koronie
AK	Wycięcie natrysku olejowego	NB	Tuleja sworzni z brązu



PIERŚCIEŃ TŁOKOWE

08 - 114900 - 00	Katalogowy numer referencyjny
08 - 114900 - 00	Zestaw pierścieni
08 - 114900 - 00	Numer części
08 - 114900 - 00	Rozmiar* (Patrz tabela tłoków Niral)
08 - 114900 - 00	Wersja

* Jeśli w przeszłości był system angielski, nadal stosowany jest system angielski

TULEJE CYLINDROWE

14 - 451160 - 00	Katalogowy numer referencyjny	
14 - 451160 - 00	Tuleja cylindrowa	
15 - 451160 - 00	Tuleja cylindrowa z uszczelnieniem	01 - 19 = Tuleja sucha
14 - 451160 - 00	Typ tulei	20 - 99 = Tuleja mokra
14 - 451160 - 00	Numer seryjny	
14 - 451160 - 00	Rozmiar	0 = STD (standard)
14 - 451160 - 00	Wersja	1 = pierwszy nadwymiar
		2 = drugi nadwymiar



KODY POKRYĆ I OBRÓBK

CR	Chromowany	P	Fosforanowany
MO	Zawierający cząstki molibdenu	NT	Azotowany
MO-L	Pokryty warstwą molibdenu	PS	Z powłoką napyłaną plazmowo
CK	Z powłoką chromowo-ceramiczną	GDC	Powłoka diamentowa Goetze
PVD	Azotek Chromu	DLC	Diamentopodobne Pokrycie Węgłowe

PRZEKROJE POPRZECZNE PIERŚCIEŃ TŁOKOWYCH

Przekrój poprzeczny	Opis
	Zwykły pierścień kompresyjny
	Zwykły pierścień kompresyjny (wewnętrzna faza - góra)
	Zwykły pierścień kompresyjny (wewnętrzna faza - dół)
	Zwykły pierścień kompresyjny (wewnętrzny stopień - góra)
	Zwykły pierścień kompresyjny (wewnętrzny stopień - dół)
	Pierścień stożkowy
	Pierścień stożkowy (wewnętrzna faza - góra)
	Pierścień stożkowy (wewnętrzna faza - dół)
	Pierścień stożkowy (wewnętrzny stopień - góra)
	Pierścień stożkowy (wewnętrzny stopień - dół)
	Pierścień lekko-stożkowy
	Pierścień lekko-stożkowy (wewnętrzna faza - góra)
	Pierścień lekko-stożkowy (wewnętrzna faza - dół)
	Pierścień lekko-stożkowy (wewnętrzny stopień - góra)
	Pierścień lekko-stożkowy (wewnętrzny stopień - dół)
	Klinowy pierścień kompresyjny
	Klinowy pierścień kompresyjny (wewnętrzna faza - góra)
	Klinowy pierścień kompresyjny (wewnętrzna faza - dół)
	Klinowy pierścień kompresyjny (wewnętrzny stopień - góra)
	Klinowy pierścień kompresyjny (wewnętrzny stopień - dół)
	Pierścień kompresyjny trapezowy dwustronny
	Pierścień kompresyjny trapezowy dwustronny (wewnętrzna faza - góra)
	Pierścień kompresyjny trapezowy dwustronny (wewnętrzna faza - dół)
	Pierścień kompresyjny trapezowy dwustronny (wewnętrzny stopień - góra)
	Pierścień kompresyjny trapezowy dwustronny (wewnętrzny stopień - dół)
	Pierścień trapezowy dwustronny o czole stożkowym
	Pierścień trapezowy dwustronny o czole stożkowym (wewnętrzna faza - góra)
	Pierścień trapezowy dwustronny o czole stożkowym (wewnętrzna faza - dół)
	Pierścień trapezowy dwustronny o czole stożkowym (wewnętrzny stopień - góra)
	Pierścień trapezowy dwustronny o czole stożkowym (wewnętrzny stopień - dół)
	Pierścień zgarniający o przekroju hakowym - pojedynczym
	Pierścień zgarniający o przekroju hakowym - pojedynczym (wewnętrzna faza - góra)
	Pierścień zgarniający o przekroju hakowym - pojedynczym (wewnętrzna faza - dół)
	Pierścień zgarniający o przekroju hakowym - pojedynczym (wewnętrzny stopień - góra)
	Pierścień zgarniający o przekroju hakowym - pojedynczym (wewnętrzny stopień - dół)
	Stożkowy pierścień zgarniający o przekroju hakowym - pojedynczym
	Stożkowy pierścień zgarniający o przekroju hakowym - pojedynczym (wewnętrzna faza - góra)
	Stożkowy pierścień zgarniający o przekroju hakowym - pojedynczym (wewnętrzna faza - dół)
	Stożkowy pierścień zgarniający o przekroju hakowym - pojedynczym (wewnętrzny stopień - góra)
	Stożkowy pierścień zgarniający o przekroju hakowym - pojedynczym (wewnętrzny stopień - dół)
	Szczelinowy olejowy pierścień zgarniający
	Fazowany pierścień olejowy
	Podwójnie fazowany pierścień olejowy
	Szczelinowy olejowy pierścień zgarniający
	Szczelinowy olejowy pierścień zgarniający ze sprężyną spiralną
	Fazowany pierścień olejowy ze sprężyną spiralną
	Podwójnie fazowany pierścień olejowy ze sprężyną spiralną
	Szczelinowy zgarniacz olejowy ze sprężyną spiralną
	Olejowy pierścień z szyną stalową i sprężyną typu VF

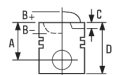

72.00 ²

¹ **3**

TU1 (H1A/H1B/H3A)	4 Cyl.	1124cc	40kW (54PS)	Petrol	TD2758
TU1M (HDY) ⁴	4 Cyl.	1124cc	40-44kW (54-60PS)	Petrol	10 TD9404
TU1M (HDZ)	4 Cyl.	1124cc	40kW (54PS)	Petrol	TD4834
106 I 1.1 ³		09/91→04/96		306 1.1	05/93→05/01
205 1.1		08/87→05/97		309 1.1	09/89→10/93
205 I 1.1		08/87→12/94		309 II 1.1	09/89→12/93
205 I 1.1 CJ		10/89→12/94		PARTNER 1.1	06/96→09/05
205 II 1.1		10/87→09/98			

⁵ **87-154300-00** STD

A 40,05
B+ 2,97
D 64,05
 ВØ 20x62

¹¹



Steel ¹² Stahl

⁶ **08-154300-00** STD
08-154307-00 0,50mm

1.50 CR P
 2.00 P
 3.00 CR ¹

Acier

⁷ **14-636470-00** WH ⁸ **B 79.50 C 122.00 D 89.20 E 85.00**

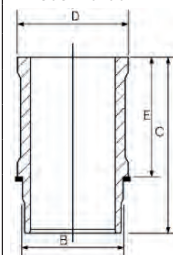

Acciao

⁹ **88-154300-00**
 87-154300-00 +
 14-636470-00

Acero

- ¹ № секции
- ² Диаметр цилиндра
- ³ Модель
- ⁴ Двигатель
- ⁵ Артикул и спецификация поршня
 - A = высота сжатия
 - B = глубина выемки / высота головки
 - BØ = диаметр выемки
 - C = глубина выемки под клапан
 - D = длина
 - RT с усилителем канавки верхнего поршневого кольца Alfin
 - КК с каналом масляного охлаждения
 - АК с пазом/фаской для масляной форсунки
 - НА с головкой с твердым анодированным покрытием
 - NB с бронзовой втулкой поршневого пальца
 - TP = трапецевидный шатун
- ⁶ Информация о комплекте колец
 - Ширина кольца
 - Конструкция кольца
 - Обработка поверхности и материал кольца
- ⁷ Информация о гильзе
 - B = внешний диаметр
 - C = общая длина
 - D = диаметр фланца
 - E = ширина фланца
 - F = высота огнезащитного уплотнения
- ⁸ Тип гильзы
 - D = "сухая"
 - WH = "мокрая" с хонинговкой
 - DH = "сухая" с хонинговкой
- ⁹ Артикул установочного комплекта
- ¹⁰ TecDoc / номер двигателя DRiV
- ¹¹ Изображение поршня и номер отливки (если есть)
- ¹² Комментарии

СИСТЕМА НУМЕРАЦИИ ДЕТАЛЕЙ



87 - 114900 - 25 **Номер детали в каталоге**

87 - 114900 - 25 **Поршень в сборе**

88 - 114900 - 25 **Комплект с гильзой без уплотнений**

89 - 114900 - 25 **Комплект с гильзой с уплотнениями**

87 - 114900 - 25 **код**

87 - 114900 - 25 **Размер***

87 - 114900 - 25 **Версия**

* Если ранее использовалась британская система мер, то она продолжает использоваться

Расшифровка кодов

- RT с усилителем канавки верхнего поршневого кольца Alfin
- KK с каналом масляного охлаждения
- AK с пазом/фаской для масляной форсунки
- HA с головкой с твердым анодированным покрытием
- NB с бронзовой втулкой поршневого пальца

Размер	Метрическая система	Британская система мер
00	STD	
03	0.125MM	
04	0.20MM	
05	0.25MM	.010
06	0.40MM	
07	0.50MM	.020
08	0.60MM	
09	0.75MM	.030
10	0.80MM	
11	1.00MM	.040
13	1.25MM	
14	1.50MM	.060
16	2.00MM	
17	2.286MM	.090
20	0.70MM	
21	0.65MM	
22	0.30MM	



ПОРШНЕВЫЕ КОЛЬЦА

08 - 114900 - 00 **Номер детали в каталоге**

08 - 114900 - 00 **Комплект колец в сборе**

08 - 114900 - 00 **код**

08 - 114900 - 00 **Размер* (см. таблицу поршней Niral)**

08 - 114900 - 00 **Версия**

* Если ранее использовалась британская система мер, то она продолжает использоваться

ГИЛЬЗЫ ЦИЛИНДРОВ

14 - 451160 - 00 **Номер детали в каталоге**

14 - 451160 - 00 **Гильза цилиндра**

15 - 451160 - 00 **Гильза цилиндра с уплотнением**

14 - 451160 - 00 **Тип гильзы**

14 - 451160 - 00 **Серийный номер**

14 - 451160 - 00 **Размер**

14 - 451160 - 00 **Версия**

01 - 19 = "Сухая" гильза
20 - 99 = "Мокрая" гильза

0 = стандартный
1 = 1й ремонтный размер
2 = 2й ремонтный размер



КОДЫ ПОКРЫТИЙ И ВИДОВ ОБРАБОТКИ

CR	С хромовым покрытием	NT	С азотированием поверхности
MO	С молибденовым подслоем	PS	С плазменным напылением
MOL	С молибденовым покрытием	GDC	С алмазо-углеродным покрытием Goetze Diamond®
CK	С хромокерамическим покрытием	DLC	С алмазоподобным покрытием
PVD	С покрытием из нитрида хрома		
P	С фосфатированием поверхности		

СЕЧЕНИЯ ПОРШНЕВЫХ КОЛЕЦ

Сечение	Описание
	Цилиндрическое компрессионное кольцо
	Цилиндрическое компрессионное кольцо (с внутренней фаской сверху)
	Цилиндрическое компрессионное кольцо (с внутренней фаской снизу)
	Цилиндрическое компрессионное кольцо (с внутренним уступом сверху)
	Цилиндрическое компрессионное кольцо (с внутренним уступом снизу)
	Конусообразное кольцо
	Конусообразное кольцо (с внутренней фаской сверху)
	Конусообразное кольцо (с внутренней фаской снизу)
	Конусообразное кольцо (с внутренним уступом сверху)
	Конусообразное кольцо (с внутренним уступом снизу)
	Минутное компрессионное конусообразное кольцо
	Минутное компрессионное конусообразное кольцо (с внутренней фаской сверху)
	Минутное компрессионное конусообразное кольцо (с внутренней фаской снизу)
	Минутное компрессионное конусообразное кольцо (с внутренним уступом сверху)
	Минутное компрессионное конусообразное кольцо (с внутренним уступом снизу)
	Клиновидное компрессионное кольцо
	Клиновидное компрессионное кольцо (с внутренней фаской сверху)
	Клиновидное компрессионное кольцо (с внутренней фаской снизу)
	Клиновидное компрессионное кольцо (с внутренним уступом сверху)
	Клиновидное компрессионное кольцо (с внутренним уступом снизу)
	Трапецевидное компрессионное кольцо
	Трапецевидное компрессионное кольцо (с внутренней фаской сверху)
	Трапецевидное компрессионное кольцо (с внутренней фаской снизу)
	Трапецевидное компрессионное кольцо (с внутренним уступом сверху)
	Трапецевидное компрессионное кольцо (с внутренним уступом снизу)
	Трапецевидное конусообразное кольцо
	Трапецевидное конусообразное кольцо (с внутренней фаской сверху)
	Трапецевидное конусообразное кольцо (с внутренней фаской снизу)
	Трапецевидное конусообразное кольцо (с внутренним уступом сверху)
	Трапецевидное конусообразное кольцо (с внутренним уступом снизу)
	Скребок кольцо с зубом
	Скребок кольцо с зубом (с внутренней фаской сверху)
	Скребок кольцо с зубом (с внутренней фаской снизу)
	Скребок кольцо с зубом (с внутренним уступом сверху)
	Скребок кольцо с зубом (с внутренним уступом снизу)
	Скребок коническое кольцо с зубом
	Скребок коническое кольцо с зубом (с внутренней фаской сверху)
	Скребок коническое кольцо с зубом (с внутренней фаской снизу)
	Скребок коническое кольцо с зубом (с внутренним уступом сверху)
	Скребок коническое кольцо с зубом (с внутренним уступом снизу)
	Маслосъемное коромышечное кольцо с дренажными прорезями
	Маслосъемное коромышечное кольцо со сходящимися фасками
	Маслосъемное коромышечное кольцо с параллельными фасками
	Маслосъемное коромышечное кольцо с дренажными прорезями с витым пружинным расширителем
	Маслосъемное коромышечное кольцо со сходящимися фасками с витым пружинным расширителем
	Маслосъемное коромышечное кольцо с параллельными фасками с витым пружинным расширителем
	Стальное пластинчатое маслосъемное кольцо с пружинным расширителем VF

كيفية استخدام هذا الكتالوج

PEUGEOT

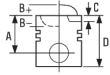

72.00 2

1 3

TU1 (H1A/H1B/H3A)	4 Cyl.	1124cc	40kW (54PS)	Petrol	TD2758
TU1M (HDY) 4	4 Cyl.	1124cc	40-44kW (54-60PS)	Petrol	10 TD9404
TU1M (HDZ)	4 Cyl.	1124cc	40kW (54PS)	Petrol	TD4834
106 I 1.1 3		09/91→04/96		306 1.1	05/93→05/01
205 1.1		08/87→05/97		309 1.1	09/89→10/93
205 I 1.1		08/87→12/94		309 II 1.1	09/89→12/93
205 I 1.1 CJ		10/89→12/94		PARTNER 1.1	06/96→09/05
205 II 1.1		10/87→09/98			

5 87-154300-00 STD

A 40,05
B+ 2,97
D 64,05
20x62



11

6 08-154300-00 STD
08-154307-00 0,50mm

1.50 CR P
2.00 P
3.00 CR 1

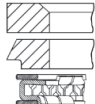

7 8 14-636470-00 WH B 79.50 C 122.00 D 89.20 E 85.00

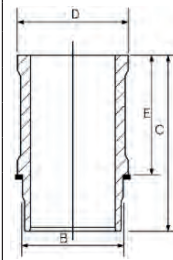

9 88-154300-00
87-154300-00 +
14-636470-00

Steel 12

Stahl

Acier

Acciaio

Acero

- رقم اللوحة
- حجم القطر
- الطرز
- المحرك
- مرجع الكباس
 - A = ارتفاع الضغط
 - B = عمق الغرفة / ارتفاع التاج
 - BØ = قطر الغرفة
 - C = عمق جيب الصمام
 - D = الطول
 - RT إدراج ألفين
 - KK استوديو تبريد الزيت
 - AK قطع نفث الزيت
 - HA بطانة مؤكسدة قوية على التاج
 - NB جلبة بنز برونزي
 - TP = أبعاد شبه المنحرف

- مرجع مجموعة الحلقة
 - عرض الطوق
 - تصميم الحلقة
 - مادة ومعالجة سطح الحلقة
- مرجع البطانة
 - B = القطر الخارجي
 - C = الطول الكلي
 - D = قطر الشفة
 - E = عرض الشفة
 - F = طول شفة الحماية من النيران
- نوع البطانة
 - D = جاف
 - WH = حجر شحذ رطب
 - DH = حجر شحذ جاف
- مرجع المجموعة
- DRiV مستند المواصفات / رقم محرك
- صورة الكباس ورقم السبيكة (إن وجد)
- التعليق

نظام ترقيم القطع

Niral[®]
FITTED WITH **GOETZE** RINGS

الرمز	الوصف	الحجم	مترى الحجم	إمبريالي
87 - 114900 - 25	مرجع الكتالوج	00	STD	
87 - 114900 - 25	مجموعة الكباس	03	0.125MM	
88 - 114900 - 25	مجموعة طقم بدون سدادات	04	0.20MM	
89 - 114900 - 25	مجموعة طقم ذات سدادات	05	0.25MM	.010
87 - 114900 - 25	المرجع	06	0.40MM	
87 - 114900 - 25	*الحجم	07	0.50MM	.020
87 - 114900 - 25		08	0.60MM	
87 - 114900 - 25	الإصدار	09	0.75MM	.030
		10	0.80MM	
		11	1.00MM	.040
		13	1.25MM	
		14	1.50MM	.060
		16	2.00MM	
		17	2.286MM	.090
		20	0.70MM	
		21	0.65MM	
		22	0.30MM	

* إذا كان المقياس إمبريالي في الماضي، يستمر لكي يكون إمبريالي

أكواد المميزات
RT إدراج ألفين
KK استوديو تبريد الزيت
AK قطع نفث الزيت

بطانة مؤكسدة قوية على HA التاج
NB جلبة بنز برونزي

GOETZE[®]

حلقات الكباس

08 - 114900 - 00	مرجع الكتالوج
08 - 114900 - 00	تجميع مجموعة الحلقة
08 - 114900 - 00	المرجع
08 - 114900 - 00	Niral الحجم* (انظر جدول كباسات)
08 - 114900 - 00	الإصدار

* إذا كان المقياس إمبريالي في الماضي، يستمر لكي يكون إمبريالي

بطانات الأسطوانات

14 - 451160 - 00	مرجع الكتالوج	
14 - 451160 - 00	بطانة الاسطوانة	
15 - 451160 - 00	بطانة الاسطوانة ذات مانع التسريب	19 - 01 = بطانة جافة
14 - 451160 - 00	نوع البطانة	99 - 20 = بطانة رطبة
14 - 451160 - 00	الرقم المسلسل	
14 - 451160 - 00	الحجم	0 = قياسي
14 - 451160 - 00	الإصدار	1 = الحجم الزائد الأول
		2 = الحجم الزائد الثاني

GOETZE[®]

أكواد المعالجة والأغذية

CR	ملون بالكروم	P	مصنوع من الفوسفات
MO	مرصع بالموليبدينوم	NT	بالنيتريد
MOL	مكسو بالموليبدينوم	PS	مغطى برشاش البلازما
CK	مكسو بالسيرياميك - الكروميوم	GDC	Goetze® غطاء ماس
PVD	كروم نيتريد	DLC	الماس مثل الكربون

الأقسام المستعرضة لحلقات الكباس

القسم المستعرض	الوصف
	حلقة ضغط بسيطة
	حلقة ضغط بسيطة (الشفة الداخلية - الجانب العلوي)
	حلقة ضغط بسيطة (الشفة الداخلية - الجانب السفلي)
	حلقة ضغط بسيطة (الدرج الداخلي - الجانب العلوي)
	حلقة ضغط بسيطة (الدرج الداخلي - الجانب السفلي)
	حلقة مستدقة
	حلقة مستدقة (الشفة الداخلية - الجانب العلوي)
	حلقة مستدقة (الشفة الداخلية - الجانب السفلي)
	حلقة مستدقة (الدرج الداخلي - الجانب العلوي)
	حلقة مستدقة (الدرج الداخلي - الجانب السفلي)
	الحلقة المستدقة بشكل طفيف
	الحلقة المستدقة بشكل طفيف (الشفة الداخلية - الجانب العلوي)
	الحلقة المستدقة بشكل طفيف (الشفة الداخلية - الجانب السفلي)
	الحلقة المستدقة بشكل طفيف (الدرج الداخلي - الجانب العلوي)
	الحلقة المستدقة بشكل طفيف (الدرج الداخلي - الجانب السفلي)
	حلقة ضغط من نوع الإسفين
	حلقة ضغط من نوع الإسفين (الشفة الداخلية - الجانب العلوي)
	حلقة ضغط من نوع الإسفين (الشفة الداخلية - الجانب السفلي)
	حلقة ضغط من نوع الإسفين (الدرج الداخلي - الجانب العلوي)
	حلقة ضغط من نوع الإسفين (الدرج الداخلي - الجانب السفلي)
	حلقة ضغط من النوع المرتكز
	حلقة ضغط من النوع المرتكز (الشفة الداخلية - الجانب العلوي)
	حلقة ضغط من النوع المرتكز (الشفة الداخلية - الجانب السفلي)
	حلقة ضغط من النوع المرتكز (الدرج الداخلي - الجانب العلوي)
	حلقة ضغط من النوع المرتكز (الدرج الداخلي - الجانب السفلي)
	حلقة مرتكز ذات وجه مستدق
	حلقة مرتكز ذات وجه مستدق (الشفة الداخلية - الجانب العلوي)
	حلقة مرتكز ذات وجه مستدق (الشفة الداخلية - الجانب السفلي)
	حلقة مرتكز ذات وجه مستدق (الدرج الداخلي - الجانب العلوي)
	حلقة مرتكز ذات وجه مستدق (الشفة الداخلية - الجانب السفلي)
	كاشطة منفردة الخطاف
	كاشطة منفردة الخطاف (الشفة الداخلية - الجانب العلوي)
	كاشطة منفردة الخطاف (الشفة الداخلية - الجانب السفلي)
	كاشطة منفردة الخطاف (الدرج الداخلي - الجانب العلوي)
	كاشطة منفردة الخطاف (الدرج الداخلي - الجانب السفلي)
	كاشطة منفردة الخطاف مستدقة
	كاشطة منفردة الخطاف مستدقة (الشفة الداخلية - الجانب العلوي)
	كاشطة منفردة الخطاف مستدقة (الشفة الداخلية - الجانب السفلي)
	كاشطة منفردة الخطاف مستدقة (الدرج الداخلي - الجانب العلوي)
	كاشطة منفردة الخطاف مستدقة (الدرج الداخلي - الجانب السفلي)
	حلقة كاشطة الزيت المثقوبة
	حلقة تحكم زيت مشطوفة الحافة
	حلقة تحكم زيت مشطوفة الحافة مزدوجة
	حلقة كاشطة الزيت المثقوبة
	حلقة كاشطة الزيت المثقوبة مع باي ملفوف
	حلقة تحكم زيت مشطوفة الحافة مع باي ملفوف
	حلقة تحكم زيت مشطوفة الحافة مزدوجة مع باي ملفوف
	كاشطة الزيت المثقوبة مع باي ملفوف
	حلقة تحكم زيت صلبة مع باي VF

Niral[®]
FITTED WITH **GOETZE** RINGS



FOUR DIFFERENT SERVICES, ONE GOAL: TO HELP YOU!

GARAGE GURUS is the technical support service offered by the global aftermarket supplier and OE manufacturer partner, DRiV. Garage Gurus is created to make technicians, garage owners, and distributors' jobs easier.

We provide a high standard of services, including telephone support, in person training, on-the-go visits and online courses, all related to our product categories.



GARAGE GURUS ON-THE-GO TRAINING BRING GARAGE GURUS TO YOU!

Our trainers will come to you in their Garage Gurus On-The-Go technology vans, offering product demonstrations, hands-on equipment training and information on the latest products.



GARAGE GURUS ONSITE TRAINING AT OUR PLACE OR YOURS!

Do you want to take your career to the next level? We can organise a workshop with our Master Technicians at our place or yours that fits your requirements.



GARAGE GURUS ON-CALL SUPPORT GIVE US A CALL!

Need an answer fast? You need Garage Gurus On-Call. Our Master Technicians have a wealth of knowledge at their fingertips and are at the other end of a phone waiting to answer your question. Contact us by e-mail at support@gurusoncall.tech or phone at **+34-911-08-54-08** during EMEA working hours – Monday till Friday 09:00h till 17:00h (UTC+01:00). Available languages: English, French, German and Spanish.



GARAGE GURUS ONLINE TRAINING WHENEVER, WHEREVER!

Garage Gurus Online training platform brings the expertise and knowledge of our Master Trainers to your sofa. Enhance your skills in your own time and for free by registering for our online E-Learning platform at ggemeaenglish.learnupon.com

JOIN OUR TECHNICAL COMMUNITY

GARAGE GURUS will be continuously releasing content including video tutorials, tech tips, articles and courses. We want your input to help determine the content we provide.

We will create a community of like-minded individuals that can share their challenges, successes and questions on part fitting and diagnostics.

SOCIAL MEDIA

Follow us on Twitter & Facebook:

 [@GarageGurus_EU](https://twitter.com/GarageGurus_EU)

 www.facebook.com/GarageGurusEU

And subscribe to our Youtube channel:

 www.youtube.com/c/GarageGurusEU

VISIT OUR NEW WEBSITE

A SUPPORT AND TRAINING PLATFORM FOR MECHANICS



Available in 9 languages: English, German, Italian, French, Spanish, Russian, Polish, Dutch and Czech



Available for desktop and mobiles



Knowledge centre section, where you can enjoy installation and tips & tricks videos as well as download technical data sheets such as installation guides and technical tips



Diagnostics centre section, where you can watch our diagnostics videos and download technical material such as Trouble Tracer Charts



Training courses offer by product category

And much more!

Check it out at www.garagegurus.tech/en-eu

25,000+
issues solved

35,000+
people trained

50+
courses

100+
webinars

*Our achievement
in the last 12 months!*

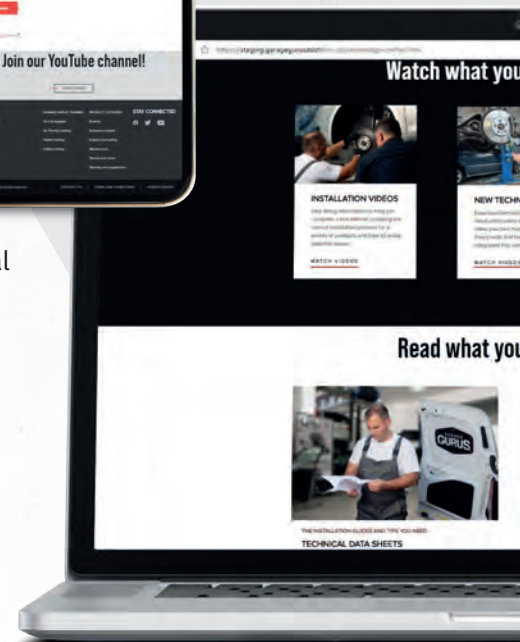

BECOME AN EXPERT IN YOUR FIELD

© All trademarks shown are owned by Tenneco Inc. or one or more of its subsidiaries in one or more countries.

www.garagegurus.tech/en-eu • support@gurusoncall.tech



ON-THE-GO



ONLINE



ON-CALL



ONSITE



www.youtube.com/c/GarageGurusEU







[@GarageGurus_EU](https://twitter.com/GarageGurus_EU)



www.facebook.com/GarageGurusEU

NEW PARTS LIST





Numerische Teilenummernliste • Liste des références produits
Lista de nuevas referencias

						9
87-109700-10	STD	AUDI	4B, DR, JN, MG, PM, RS, RU, SF, SH		48	22
			SEAT	ACC, RP	727	27
			VW	AAM, ACC, ADD, ADF, ANN, JN, RP	871	31
87-109705-10	0.25mm	AUDI	4B, DR, JN, MG, PM, RS, RU, SF, SH		48	22
			SEAT	ACC, RP	727	27
			VW	AAM, ACC, ADD, ADF, ANN, JN, RP	871	31
87-123200-50	STD	VOLVO	D12F390 (Euro 4), D12F430 (Euro 4)		838	50
87-136400-30	STD	MERCEDES-BENZ	OM 646.811, OM 646.812, OM 646.820, OM 646.821		464	26
87-136407-30	0.50mm	MERCEDES-BENZ	OM 646.811, OM 646.812, OM 646.820, OM 646.821		464	26
87-136500-55	STD	MAN	D 0834 LFL60, D 0834 LFL61, D 0834 LFL62, D 0834 LFL63 (Euro 5), D 0834 LFL64 (Euro 5), D 0834 LFL65 (Euro 5), D 0834 LFL66 (Euro 6), D 0834 LFL67 (Euro 6), D 0834 LFL68 (Euro 6), D 0834 LFL75 (Euro 6), D 0834 LOH61 (Euro 5), D 0836 LFL60, D 0836 LFL61, D 0836 LFL62, D 0836 LFL63 (Euro 5), D 0836 LFL64 (Euro 5), D 0836 LFL65 (Euro 5), D 0836 LFL66 (Euro 6), D 0836 LFL67 (Euro 6), D 0836 LFL68 (Euro 6), D 0836 LFL69 (Euro 5), D 0836 LFL70 (Euro 5), D 0836 LFL71 (Euro 5), D 0836 LFL75 (Euro 6), D 0836 LFL76 (Euro 6), D 0836 LFL77 (Euro 6), D 0836 LOH64 (Euro 5), D 0836 LOH65 (Euro 5), D 0836 LOH66 (Euro 6), D 0836 LOH67 (Euro 6), D 0836 LOH70, D 0836 LOH71, D 0836 LOH72 (Euro 6), D 0836 LOH73 (Euro 6), D 0836 LOH74 (Euro 6)		386	8
87-143000-00	STD	VW	AGK, ATA, AUH, BCQ		887	59
87-143007-00	0.50mm	VW	AGK, ATA, AUH, BCQ		887	59
87-143600-60	STD	SCANIA	DSC 14.13 (Euro 2 DSC 14), DSC 14.15 (Euro 3 DS 14)		709	22
87-143600-70	STD	SCANIA	DC 12.15 (DC 12), DC 12.18 (Euro 5 DC 12), DC 12.22 (Euro 5 DC 12), DC 12.23 (Euro 4 DC 12), DC 12.24 (Euro 4 DC 12), DC 12.26 (Euro 4 DC 12), DC 16.09 (Euro 5 DC 16), DT 12.06 (Euro 4 DT 12), DT 12.10 (Euro 4 DT 12)		704	13
87-146400-00	STD	MERCEDES-BENZ	OM 924.913 (Euro 3), OM 924.915 (Euro 3), OM 924.916 (Euro 3), OM 924.919 (Euro 3), OM 924.920 (Euro 3), OM 924.924 (Euro 3), OM 924.928, OM 924.932 (Euro 5), OM 926.913 (Euro 3), OM 926.914 (Euro 2), OM 926.915 (Euro 3), OM 926.917 (Euro 3), OM 926.921 (Euro 3), OM 926.924 (Euro 3), OM 926.926 (Euro 3), OM 926.929 (Euro 3), OM 926.930 (Euro 3), OM 926.932 (Euro 3), OM 926.933 (Euro 3), OM 926.935 (Euro 3), OM 926.938 (Euro 3), OM 926.940, OM 926.941 (Euro 4), OM 926.968, OM 926.969		494	56
87-148105-30	0.25mm	FORD	H9FA (Duratorq), H9FB (Euro 4 Duratorq), JXFA (Duratorq), JXFC (Duratorq)		223	46
		LAND ROVER	DT244 (Duratorq)		348	15
87-148105-40	0.25mm	FORD	PHFA (Duratorq), PHFC (Duratorq)		224	48
87-179300-06	STD	MERCEDES-BENZ	OM 445.920 (Euro 2 OM441 LA), OM 445.921 (Euro 2 OM441 LA), OM 445.922 (Euro 2 OM441 LA), OM 445.923 (Euro 2 OM441 LA), OM 445.924 (Euro 2 OM441 LA), OM 445.925 (Euro 2 OM441 LA), OM 445.926 (Euro 2 OM441 LA), OM 445.927 (Euro 2 OM441 LA), OM 445.929 (Euro 2 OM441 LA), OM 445.930 (Euro 2 OM441 LA), OM 445.931 (Euro 2 OM441 LA), OM 445.933 (Euro 2 OM441 LA), OM 445.934 (Euro 2 OM441 LA), OM 445.935 (Euro 2 OM441 LA), OM 445.936 (Euro 2 OM441 LA), OM 445.937 (Euro 2 OM441 LA), OM 445.938 (Euro 2 OM441 LA), OM 445.939 (Euro 2 OM441 LA), OM 445.940 (Euro 2 OM441 LA), OM 445.941 (Euro 2 OM441 LA), OM 446.920 (Euro 2 OM442 LA), OM 446.922 (Euro 2 OM442 LA), OM 446.923 (OM442 LA), OM 446.924 (Euro 2 OM442 LA), OM 446.925 (Euro 2 OM442 LA), OM 446.926 (Euro 2 OM442 LA), OM 446.927 (Euro 2 OM442 LA), OM 446.928 (Euro 2 OM442 LA), OM 446.929 (Euro 2 OM442 LA), OM 446.930 (Euro 2 OM442 LA), OM 446.931 (Euro 2 OM442 LA), OM 446.932 (Euro 2 OM442 LA), OM 446.933 (Euro 2 OM442 LA), OM 446.934 (Euro 2 OM442 LA), OM 446.935 (Euro 2 OM442 LA), OM 446.936 (Euro 2 OM442 LA), OM 446.938 (Euro 2 OM442 LA), OM 446.939 (Euro 2 OM442 LA), OM 446.940 (Euro 2 OM442 LA), OM 446.941 (Euro 2 OM442 LA), OM 446.942 (Euro 2 OM442 LA), OM 446.943 (Euro 2 OM442 LA), OM 446.945 (Euro 2 OM442 LA), OM 446.946 (Euro 2 OM442 LA), OM 446.948 (Euro 2 OM442 LA)		511	73
87-245500-30	STD	IVECO	8365.25.500, 8365.25.501, 8365.25.502, 8365.25.503, 8365.25.533		295	43
87-246200-00	STD	ISUZU	4JA1T, 4JB1		253	4
87-421600-10	STD	CITROËN	F1CE3481N (F30DTE) (Euro 5), F30DTE (F1CE3481E) (Euro 5)		116	54
		FIAT	F1CE3481E (Euro 5), F1CE3481M (Euro 5), F1CE3481N (Euro 5)		192	75
		IVECO	F1CE3481B, F1CE3481C, F1CE3481D (Euro 5), F1CE3481J (Euro 5), F1CE3481K (Euro 5), F1CE3481L		276	16
		PEUGEOT	F30DTE (F1CE3481E) (Euro 5), F30DTE (F1CE3481N) (Euro 5)		633	61
87-422300-10	STD	RENAULT	F9Q 870, F9Q 872		660	27
87-422307-10	0.50mm	RENAULT	F9Q 870, F9Q 872		660	27
87-422400-10	STD	TOYOTA	1KD-FTV		778	10
87-422407-10	0.50mm	TOYOTA	1KD-FTV		778	10
87-423300-00	STD	MINI	W11 B16 A		536	9
87-423307-00	0.50mm	MINI	W11 B16 A		536	9
87-423900-00	STD	HYUNDAI	G4LC		243	2
		KIA	G4LC		321	2
87-423907-00	0.50mm	HYUNDAI	G4LC		243	2
		KIA	G4LC		321	2

								9	
87-424300-00	STD	FORD	M1CA (EcoBoost), M1CB (EcoBoost), M1DA (Euro 5 EcoBoost), M1JA (EcoBoost), M1JC (Euro 5 EcoBoost), M1JE (EcoBoost), M1JH (EcoBoost), M2DA (Euro 5 EcoBoost), M2GA (Euro 5 EcoBoost), M2GB (Euro 6 EcoBoost), SFCA (EcoBoost), SFCB (EcoBoost), SFCC (EcoBoost), SFCD (EcoBoost), SFDA (Euro 5 EcoBoost), SFJA (EcoBoost), SFJB (EcoBoost), SFJC (EcoBoost), SFJD (EcoBoost), XMJA (EcoBoost), XMJB (EcoBoost), YYJA (EcoBoost), YYJB (EcoBoost), YYJC (EcoBoost), YYJD (EcoBoost)	201	2				
87-424307-00	0.50mm	FORD	M1CA (EcoBoost), M1CB (EcoBoost), M1DA (Euro 5 EcoBoost), M1JA (EcoBoost), M1JC (Euro 5 EcoBoost), M1JE (EcoBoost), M1JH (EcoBoost), M2DA (Euro 5 EcoBoost), M2GA (Euro 5 EcoBoost), M2GB (Euro 6 EcoBoost), SFCA (EcoBoost), SFCB (EcoBoost), SFCC (EcoBoost), SFCD (EcoBoost), SFDA (Euro 5 EcoBoost), SFJA (EcoBoost), SFJB (EcoBoost), SFJC (EcoBoost), SFJD (EcoBoost), XMJA (EcoBoost), XMJB (EcoBoost), YYJA (EcoBoost), YYJB (EcoBoost), YYJC (EcoBoost), YYJD (EcoBoost)	201	2				
87-424400-00	STD	FORD	UEJB (Euro 5 Duratec)	209	16				
87-424407-00	0.50mm	FORD	UEJB (Euro 5 Duratec)	209	16				
87-424500-00	STD	MAZDA	L5-VE	416	11				
87-424507-00	0.50mm	MAZDA	L5-VE	416	11				
87-424600-00	STD	MAZDA	ZJ-VE (Euro 4)	413	3				
87-424607-00	0.50mm	MAZDA	ZJ-VE (Euro 4)	413	3				
87-424700-00	STD	MAZDA	ZY-DE	414	7				
87-424707-00	0.50mm	MAZDA	ZY-DE	414	7				
87-424800-00	STD	HYUNDAI	G4FA (Euro 4)	244	7				
		KIA	G4FA (Euro 4)	322	6				
87-424807-00	0.50mm	HYUNDAI	G4FA (Euro 4)	244	7				
		KIA	G4FA (Euro 4)	322	6				
87-424900-00	STD	FIAT	R9M 408, R9M 413, R9M 450, R9M 452	176	32				
		MERCEDES-BENZ	OM 622.951 (R9M)	449	3				
		NISSAN	R9M, R9M 413, R9M 452	563	14				
		OPEL	R9M 408, R9M 413, R9M 450, R9M 452	584	31				
		RENAULT	R9M 402, R9M 404, R9M 408, R9M 409, R9M 413, R9M 414, R9M 450, R9M 452, R9M 453	661	28				
		VAUXHALL	R9M 408, R9M 413, R9M 450	795	32				
87-424907-00	0.50mm	FIAT	R9M 408, R9M 413, R9M 450, R9M 452	176	32				
		MERCEDES-BENZ	OM 622.951 (R9M)	449	3				
		NISSAN	R9M, R9M 413, R9M 452	563	14				
		OPEL	R9M 408, R9M 413, R9M 450, R9M 452	584	31				
		RENAULT	R9M 402, R9M 404, R9M 408, R9M 409, R9M 413, R9M 414, R9M 450, R9M 452, R9M 453	661	28				
		VAUXHALL	R9M 408, R9M 413, R9M 450	795	32				
87-425608-00	0.60mm	ALFA ROMEO	199 A3.000	21	1				
		FIAT	199 A3.000, 223 A9.000	167	8				
		LANCIA	199 A3.000	332	5				
		OPEL	Z 13 DTH (Euro 4)	574	4				
		VAUXHALL	Z 13 DTH	786	4				
87-426900-00	STD	HYUNDAI	G4FJ	245	8				
		KIA	G4FJ	322	7				
87-426900-10	STD	HYUNDAI	G4FJ	245	8				
		KIA	G4FJ	322	7				
87-426907-00	0.50mm	HYUNDAI	G4FJ	245	8				
		KIA	G4FJ	322	7				
87-426907-10	0.50mm	HYUNDAI	G4FJ	245	8				
		KIA	G4FJ	322	7				
87-427400-60	STD	MERCEDES-BENZ	OM 642.884, OM 642.896, OM 642.898, OM 642.899	454	12				
87-427400-70	STD	MERCEDES-BENZ	OM 642.884, OM 642.896, OM 642.898, OM 642.899	454	12				
87-427400-80	STD	MERCEDES-BENZ	OM 642.820, OM 642.830, OM 642.832, OM 642.836, OM 642.850, OM 642.856, OM 642.870	453	10				
87-427400-90	STD	MERCEDES-BENZ	OM 642.820, OM 642.830, OM 642.832, OM 642.836, OM 642.850, OM 642.856, OM 642.870	453	10				
87-429100-10	STD	MAN	E 0824 E301 (E0824), E 0826 E301 (E0826), E 0834 E302, E 0834 E312, E 0836 E302, E 0836 E312	388	12				
87-429300-10	STD	ALFA ROMEO	940 A3.000, 940 C1.000 (Euro 6), 940 C5.000 (Euro 6), 955 A4.000	23	9				
		CHRYSLER	198 A2.000	87	2				
		FIAT	198 A3.000, 199 B5.000, 263 A3.000, 263 A8.000, 350 A3.000, 552 60 384, 844 A3.000, 940 C1.000, 955 A4.000	174	30				
		JEEP	552 60 384, 552 63 113, EJJ, EJK	314	1				
		LANCIA	944 A3.000, 955 A4.000	335	16				
87-429306-10	0.40mm	ALFA ROMEO	940 A3.000, 940 C1.000 (Euro 6), 940 C5.000 (Euro 6), 955 A4.000	23	9				
		CHRYSLER	198 A2.000	87	2				
		FIAT	198 A3.000, 199 B5.000, 263 A3.000, 263 A8.000, 350 A3.000, 552 60 384, 844 A3.000, 940 C1.000, 955 A4.000	174	30				
		JEEP	552 60 384, 552 63 113, EJJ, EJK	314	1				
		LANCIA	944 A3.000, 955 A4.000	335	16				
87-429500-40	STD	CHEVROLET	A 12 XEL, A 12 XER (Euro 5)	80	5				
		OPEL	A 12 XEL, A 12 XER	575	8				
		VAUXHALL	A 12 XEL, A 12 XER	787	9				

NEW PARTS LIST





Numerische Teilenummernliste • Liste des références produits
Lista de nuevas referencias





						9
87-429507-40	0.50mm	CHEVROLET	A 12 XEL, A 12 XER (Euro 5)	80	5	
		OPEL	A 12 XEL, A 12 XER	575	8	
		VAUXHALL	A 12 XEL, A 12 XER	787	9	
87-429600-10	STD	RENAULT	MACK E.TECH A/46 (Euro 2), MACK E.TECH B/46 (Euro 2), MACK E.TECH C/46 (Euro 2)	678	66	
87-430200-00	STD	JAGUAR	204PT	311	9	
		LAND ROVER	204PT	347	12	
87-430207-00	0.50mm	JAGUAR	204PT	311	9	
		LAND ROVER	204PT	347	12	
87-430300-00	STD	CHEVROLET	B 16 DTH	83	15	
		OPEL	B 16 DTH, D 16 DTH, D 16 DTN	582	27	
		VAUXHALL	B 16 DTH, D 16 DTH, D 16 DTN	794	28	
87-430307-00	STD	CHEVROLET	B 16 DTH	83	15	
		OPEL	B 16 DTH, D 16 DTH, D 16 DTN	582	27	
		VAUXHALL	B 16 DTH, D 16 DTH, D 16 DTN	794	28	
87-430400-00	STD	HYUNDAI	D4EA-V (Euro 4)	247	12	
87-430400-10	STD	HYUNDAI	D4EA	246	11	
		KIA	D4EA (Euro 3)	324	9	
87-430407-00	0.50mm	HYUNDAI	D4EA-V (Euro 4)	247	12	
87-430407-10	0.50mm	HYUNDAI	D4EA	246	11	
		KIA	D4EA (Euro 3)	324	9	
87-430600-00	STD	MERCEDES-BENZ	M 271.860, M 271.861	449	4	
87-430607-00		MERCEDES-BENZ	M 271.860, M 271.861	449	4	
87-431600-10	STD	MAN	E 0834 LE30Z, E 0836 LE20Z, E 0836 LE30Z	389	13	
87-432407-00	0.50mm	CITROËN	DT17ED4, DT17TED4 (UHZ) (Euro 4)	104	27	
		JAGUAR	AJD	309	1	
		LAND ROVER	276DT (Euro 4)	344	3	
		PEUGEOT	DT17TED4	620	29	
87-432500-00	STD	DAF	MX 300 (Euro 4/5), MX 340 (Euro 4/5), MX 375 (Euro 4/5)	140	14	
87-432500-10	STD	DAF	MX 300 (Euro 4/5), MX 340 (Euro 4/5), MX 375 (Euro 4/5)	140	14	
87-433200-00	STD	FIAT	192 B2.000, 843 A1.000 (Euro 4 Fire)	172	24	
		LANCIA	192 B2.000, 843 A1.000	335	14	
		VAUXHALL	843 A1.000	786	5	
87-433206-00	0.40mm	FIAT	192 B2.000, 843 A1.000 (Euro 4 Fire)	172	24	
		LANCIA	192 B2.000, 843 A1.000	335	14	
		VAUXHALL	843 A1.000	786	5	
87-434100-00	STD	IVECO	F3A3681A (Euro 4/5 Cursor 10), F3A3681B (Euro 4/5 Cursor 10), F3A3681Y (Euro 4/5 Cursor 10), F3AE3681D (Euro 4/5 Cursor 10)	299	51	
87-434200-00	STD	HYUNDAI	D4FB (Euro 4), D4FB-5P, D4FB-L (Euro 4)	245	9	
		KIA	D4FB (Euro 4), D4FB-L (Euro 4)	323	8	
87-434207-00	0.50mm	HYUNDAI	D4FB (Euro 4), D4FB-5P, D4FB-L (Euro 4)	245	9	
		KIA	D4FB (Euro 4), D4FB-L (Euro 4)	323	8	
87-434400-30	STD	VOLVO	D13H440 (Euro 5)	840	53	
87-436100-00	STD	NISSAN	YD25DDTI	567	24	
87-436100-30	STD	NISSAN	YD25DDTI	567	24	
87-436107-00	0.50mm	NISSAN	YD25DDTI	567	24	
87-436107-30	0.50mm	NISSAN	YD25DDTI	567	24	
87-436907-00	0.50mm	SEAT	BKY, BXW, CGGB (Euro 5)	717	12	
		SKODA	BKY, BUD, BXW, CDDA, CGGA, CGGB, CLPA	740	9	
		VW	BKR, BKY, BUD, CDDA, CGGA, CGGB, CLPA	856	11	
87-437400-10	STD	CHEVROLET	A 14 NET (Euro 5), B 14 NET (Euro 6), LUJ (Euro 5), LUV (Ecotec)	79	3	
		OPEL	A 14 NEL (Euro 5 ecoFlex), A 14 NET (Euro 5), B 14 NEJ (Euro 6), B 14 NEL (Euro 6), B 14 NET (Euro 6), D 14 NET (Euro 6)	574	6	
		VAUXHALL	A 14 NEL (Euro 5 ecoFlex), A 14 NET (Euro 5), B 14 NEJ (Euro 6), B 14 NEL (Euro 6), B 14 NET (Euro 6), D 14 NET (Euro 6)	786	7	
87-437407-10	0.50mm	CHEVROLET	A 14 NET (Euro 5), B 14 NET (Euro 6), LUJ (Euro 5), LUV (Ecotec)	79	3	
		OPEL	A 14 NEL (Euro 5 ecoFlex), A 14 NET (Euro 5), B 14 NEJ (Euro 6), B 14 NEL (Euro 6), B 14 NET (Euro 6), D 14 NET (Euro 6)	574	6	
		VAUXHALL	A 14 NEL (Euro 5 ecoFlex), A 14 NET (Euro 5), B 14 NEJ (Euro 6), B 14 NEL (Euro 6), B 14 NET (Euro 6), D 14 NET (Euro 6)	786	7	
87-437500-00	STD	DAF	MX 265 (Euro 4/5)	139	13	
87-437700-00	STD	LADA	HR16DE	327	1	
		MAZDA	HR16DE	414	6	
		MITSUBISHI	HR16DE	540	1	
		NISSAN	HR16DE	561	10	
87-437707-00	0.50mm	LADA	HR16DE	327	1	

87-437707-00	0.50mm	MAZDA	HR16DE		414	6			
		MITSUBISHI	HR16DE		540	1			
		NISSAN	HR16DE		561	10			
87-439100-10	STD	CITROËN	DT20C (Euro 5), DT20C (X8C) (Euro 5)		108	34			
		JAGUAR	306DT (Euro 5), AJV6D		309	3			
		LAND ROVER	306DT (Euro 5), 30DDTX		345	5			
		PEUGEOT	DT20C (Euro 5)		623	35			
87-439107-10	0.50mm	CITROËN	DT20C (Euro 5), DT20C (X8C) (Euro 5)		108	34			
		JAGUAR	306DT (Euro 5), AJV6D		309	3			
		LAND ROVER	306DT (Euro 5), 30DDTX		345	5			
		PEUGEOT	DT20C (Euro 5)		623	35			
87-441600-00	STD	MAN	D 2066 LF61 (Euro 6), D 2066 LF67 (Euro 6), D 2066 LF76 (Euro 6), D 2066 LF77 (Euro 6), D 2066 LF80 (Euro 6), D 2066 LF83 (Euro 6), D 2066 LF85 (Euro 6), D 2066 LF92 (Euro 6), D 2066 LOH31 (Euro 6), D 2066 LOH32 (Euro 6), D 2066 LOH30 (Euro 6), D 2066 LOH31 (Euro 6), D 2066 LOH52 (Euro 6), D 2066 LOH53 (Euro 6)		393	19			
87-442300-10	STD	AUDI	CJZA, CJZB (Euro 5), CYVA (Euro 6), CYVB		38	2			
		SEAT	CJZA, CJZB (Euro 5), CJZC, CJZD, CYVA (Euro 6), CYVB		714	3			
		SKODA	CJZA (Euro 6), CJZB (Euro 5), CJZC, CJZD, CYVA (Euro 6), CYVB		738	2			
		VW	CJZA, CJZB (Euro 5), CJZC, CJZD, CYVA (Euro 6), CYVB, CYVC, CYVD		852	2			
87-442900-00	STD	CITROËN	EB2M (HMV), EB2M (HMY)		95	8			
		PEUGEOT	EB2M (HMY)		611	9			
87-442907-00	0.50mm	CITROËN	EB2M (HMV), EB2M (HMY)		95	8			
		PEUGEOT	EB2M (HMY)		611	9			
87-443200-00	STD	MAN	D 2676 LF01 (Euro 4), D 2676 LF02 (Euro 3), D 2676 LF03 (Euro 2), D 2676 LF04 (Euro 2), D 2676 LF05 (Euro 4), D 2676 LF07 (Euro 5), D 2676 LF10 (Euro 4), D 2676 LF12 (Euro 4), D 2676 LF14 (Euro 5), D 2676 LF16 (Euro 5), D 2676 LF18, D 2676 LF20 (Euro 4), D 2676 LF21 (Euro 5), D 2676 LF22 (Euro 5), D 2676 LF25 (Euro 6), D 2676 LF26 (Euro 6), D 2676 LF28 (Euro 5), D 2676 LF31 (Euro 3), D 2676 LF32 (Euro 4), D 2676 LF33 (Euro 4)		397	26			
			D 2676 LF35 (Euro 6), D 2676 LF36 (Euro 6), D 2676 LF45 (Euro 6), D 2676 LF46 (Euro 6), D 2676 LF47 (Euro 6), D 2676 LF48 (Euro 6), D 2676 LF49 (Euro 6), D 2676 LF50 (Euro 6), D 2676 LF54 (Euro 6), D 2676 LF55 (Euro 6), D 2676 LF56 (Euro 6), D 2676 LF57 (Euro 6), D 2676 LF58 (Euro 6), D 2676 LOH31 (Euro 6)		398	28			
			D 2676 LOH01 (Euro 4), D 2676 LOH02 (Euro 4), D 2676 LOH03 (Euro 4), D 2676 LOH04 (Euro 4), D 2676 LOH10 (Euro 3), D 2676 LOH26 (Euro 5), D 2676 LOH27 (Euro 5)		399	29			
87-443800-10	STD	AUDI	CAEA, CAEB, CAED, CAWB, CCTA, CCZA, CCZC, CDNB, CDNC, CESA, CETA, CFKA, CHJA, CPMA, CPMB, CPSA		57	38			
		SEAT	CCZA, CCZB, CDND		733	42			
		SKODA	CCZA		752	32			
		VW	CAWA, CAWB, CCTA, CCZA, CCZB, CCZC, CCZD, CFFA (Euro 4), CJKA, CJKB		885	54			
87-443900-10	STD	AUDI	CBZA, CBZB		38	1			
		SEAT	CBZA, CBZB		714	2			
		SKODA	CBZA, CBZB		738	1			
		VW	CBZA, CBZB		852	1			
87-444100-00	STD	AUDI	CLHA (Euro 6), CRKB (Euro 5/6), CXMA (Euro 6 EA288), CXXB (Euro 6)		48	21			
		SEAT	CLHA (Euro 5), CLHB (Euro 5), CRKB (Euro 5/6), CXMA (Euro 6 EA 288), CXXA (Euro 6), CXXB (Euro 6)		726	25			
		SKODA	CLHA (Euro 5), CLHB (Euro 5), CRKA (Euro 6), CRKB (Euro 5/6), CXMA, CXXA (Euro 6), CXXB (Euro 6), DCXA, DCZA		747	19			
		VW	CLHA (Euro 5), CLHB (Euro 5), CRKA (Euro 6), CRKB (Euro 5/6), CXXA (Euro 6), CXXB (Euro 6), DCXA, DCZA		870	29			
87-444105-00	0.25mm	AUDI	CLHA (Euro 6), CRKB (Euro 5/6), CXMA (Euro 6 EA288), CXXB (Euro 6)		48	21			
		SEAT	CLHA (Euro 5), CLHB (Euro 5), CRKB (Euro 5/6), CXMA (Euro 6 EA 288), CXXA (Euro 6), CXXB (Euro 6)		726	25			
		SKODA	CLHA (Euro 5), CLHB (Euro 5), CRKA (Euro 6), CRKB (Euro 5/6), CXMA, CXXA (Euro 6), CXXB (Euro 6), DCXA, DCZA		747	19			
		VW	CLHA (Euro 5), CLHB (Euro 5), CRKA (Euro 6), CRKB (Euro 5/6), CXXA (Euro 6), CXXB (Euro 6), DCXA, DCZA		870	29			
87-444107-00	0.50mm	AUDI	CLHA (Euro 6), CRKB (Euro 5/6), CXMA (Euro 6 EA288), CXXB (Euro 6)		48	21			
		SEAT	CLHA (Euro 5), CLHB (Euro 5), CRKB (Euro 5/6), CXMA (Euro 6 EA 288), CXXA (Euro 6), CXXB (Euro 6)		726	25			
		SKODA	CLHA (Euro 5), CLHB (Euro 5), CRKA (Euro 6), CRKB (Euro 5/6), CXMA, CXXA (Euro 6), CXXB (Euro 6), DCXA, DCZA		747	19			
		VW	CLHA (Euro 5), CLHB (Euro 5), CRKA (Euro 6), CRKB (Euro 5/6), CXXA (Euro 6), CXXB (Euro 6), DCXA, DCZA		870	29			
87-444200-00	STD	MITSUBISHI	4D56-T		542	8			
87-444200-10	STD	MITSUBISHI	4D56-T		542	8			
87-444207-00	0.50mm	MITSUBISHI	4D56-T		542	8			
87-444207-10	0.50mm	MITSUBISHI	4D56-T		542	8			
87-444500-00	STD	MERCEDES-BENZ	OM 470.903 (Euro 6), OM 470.904 (Euro 6), OM 470.906 (Euro 6), OM 470.908 (Euro 6), OM 470.910 (Euro 6), OM 470.913 (Euro 6), OM 470.921 (Euro 6), OM 470.923 (Euro 6)		501	64			

NEW PARTS LIST





Numerische Teilenummernliste • Liste des références produits
Lista de nuevas referencias





						9
87-444600-00	STD	MERCEDES-BENZ	OM 933.951 (Euro 6 OM934 LA), OM 933.951.952 (OM 934 LA), OM 933.952 (Euro 6 OM934 LA), OM 934.911 (Euro 6), OM 934.913 (Euro 6), OM 934.971 (Euro 6), OM 934.972 (Euro 6), OM 935.911 (Euro 6 OM936), OM 935.911-914,951-954 (OM 936 LA), OM 935.912 (Euro 6 OM936), OM 935.913 (Euro 6 OM936), OM 935.914 (Euro 6 OM936), OM 935.951 (Euro 6 OM936), OM 935.952 (Euro 6 OM936), OM 935.953 (Euro 6 OM936), OM 935.954 (Euro 6 OM936), OM 936.910, OM 936.910 (Euro 6), OM 936.912 (Euro 6), OM 936.915 (Euro 6), OM 936.916 (Euro 6), OM 936.919 (Euro 6), OM 936.919.923, OM 936.923 (Euro 6), OM 936.971 (Euro 6), OM 936.972 (Euro 6), OM 936.973 (Euro 6), OM 936.975, OM 936.975 (Euro 6), OM 936.977, OM 936.977 (Euro 6), OM 936.980 (Euro 6)		496	58
87-444600-10	STD	MERCEDES-BENZ	OM 933.911 (Euro 6 OM934 LA), OM 933.911-913,915,916 (OM 934 LA), OM 933.912 (Euro 6 OM934 LA), OM 933.913 (Euro 6 OM934 LA), OM 933.915 (Euro 6 OM934 LA), OM 933.916 (Euro 6 OM934 LA), OM 934.912, OM 934.912 (Euro 6), OM 934.974 (Euro 6), OM 934.976 (Euro 6), OM 934.976.978, OM 934.978 (Euro 6)		495	57
87-444800-10	STD	CITROËN	EP6 CB (5FK), EP6C (5FS)		101	19
		MINI	N12 B16 A, N16 B16 A		535	5
		PEUGEOT	EP6C (5FH), EP6C (5FS), EP6CB (5FK)		616	20
87-444800-30	STD	MINI	N14 B16 A		535	6
		PEUGEOT	EP6DT (5FR)		617	22
87-444800-40	STD	CITROËN	EP3 (8FN), EP3 (8FP), EP3 (8FR), EP3 (8FS), EP3C (8FR) (Euro 5)		100	17
		MINI	N12 B14 A		534	4
		PEUGEOT	EP3, EP3 (8FR), EP3 (8FS), EP3C		616	18
87-444800-50	STD	BMW	N13 B16 A		70	1
		CITROËN	EP6 (5FW), EP6CDTX (5FU) (Euro 4), EP6DTX (5FU) (Euro 4)		100	18
		MINI	N18 B16 A		535	7
		PEUGEOT	EP6 (5FW), EP6 (Euro 4), EP6CDTX (5FU) (Euro 4)		616	19
87-444807-10	0.50mm	CITROËN	EP6 CB (5FK), EP6C (5FS)		101	19
		MINI	N12 B16 A, N16 B16 A		535	5
		PEUGEOT	EP6C (5FH), EP6C (5FS), EP6CB (5FK)		616	20
87-444807-50	STD	BMW	N13 B16 A		70	1
		CITROËN	EP6 (5FW), EP6CDTX (5FU) (Euro 4), EP6DTX (5FU) (Euro 4)		100	18
		MINI	N18 B16 A		535	7
		PEUGEOT	EP6 (5FW), EP6 (Euro 4), EP6CDTX (5FU) (Euro 4)		616	19
87-445400-00	STD	DAF	FR 103 S1 (Euro 4), FR 118 S1 (Euro 4), FR 136 S1 (Euro 4), FR 152 (Euro 5), GR 165 S1, GR 184 S1 (Euro 4), GR 210 S1 (Euro 4), GR 220 (Euro 4)		136	8
87-446200-00	STD	ISUZU	4HF1-II		254	6
87-446300-00	STD	ISUZU	4HK1-TC (Euro 3/4)		255	8
87-446400-00	STD	HYUNDAI	D4HA		247	14
87-446407-00	0.50mm	HYUNDAI	D4HA		247	14
87-447500-10	STD	AUDI	CRBC, CRBD, CRFA, CRFC, CRLB, CRLC, CRUA, CSUA, CSUB, CSUD, CSUE, CUVC, CUVD, CZHA, DEJA (Euro 6), DEJB (Euro 6), DEUA, DEUB, DEUC		55	34
		SEAT	CKFC (Euro 5), CRBC (Euro 5), CRLB (Euro 6), CRMB (Euro 6), CRVA (Euro 5), CRVC (Euro 5), CUVC (Euro 6), DFLA (Euro 6)		731	37
		SKODA	CKFC (Euro 5), CRLB (Euro 6), CRMB (Euro 6), CRVC, CUUA, CUUB, DFSA, DFSB		751	29
		VW	CKFC (Euro 5), CRBC (Euro 5), CRFD (Euro 5), CRLB (Euro 6), CRLD (Euro 6), CRMB (Euro 6), CRUA, CRVA (Euro 5), CRVC (Euro 5), CUUA, CUUB, CUUD, CUUE, CUUF, CUVA (Euro 6), CUVC (Euro 6), CVCA, DEJA (Euro 6), DEJB (Euro 6), DFLA (Euro 6), DFSB, DFSC, DFSD, DFSE, DFSF		879	43
87-447500-30	STD	VW	CXFA (Euro 6), CXGA (Euro 6), CXGB (Euro 6), CXHA (Euro 6), CXHB (Euro 6), CXHC (Euro 6), DASA, DASB, DASC (Euro 5), DAUA, DAUB, DAVA, DAWA		880	44
87-447507-30	0.50mm	VW	CXFA (Euro 6), CXGA (Euro 6), CXGB (Euro 6), CXHA (Euro 6), CXHB (Euro 6), CXHC (Euro 6), DASA, DASB, DASC (Euro 5), DAUA, DAUB, DAVA, DAWA		880	44
87-447800-00	STD	SEAT	AZO, BME		716	8
		SKODA	AZO, BME		739	6
		VW	AZO, BME		854	7
87-447807-00	0.50mm	SEAT	AZO, BME		716	8
		SKODA	AZO, BME		739	6
		VW	AZO, BME		854	7
87-447900-00	STD	ISUZU	4HG1-T (Euro 2)		254	7
87-448500-00	STD	HYUNDAI	G4LA		243	1
		KIA	G4LA		321	1
87-448507-00	0.50mm	HYUNDAI	G4LA		243	1
		KIA	G4LA		321	1
87-449000-00	STD	FORD	A9A, A9B		203	5
87-449007-00	0.50mm	FORD	A9A, A9B		203	5
87-449500-00	STD	AUDI	CMBA (Euro 5), CXSA (Euro 5), CZCA (Euro 6)		38	3
		SEAT	CMBA (Euro 5), CXSA (Euro 5), CZCA (Euro 6)		715	5
		SKODA	CZCA (Euro 6)		739	4
		VW	CMBA (Euro 5), CXSA (Euro 5), CZCA (Euro 6), CZCB		853	4

						9
87-449700-30	STD	BMW	B37 C15 A (Euro 6)	72	7	
			B47 C20 B, B47 D20 B	72	8	
			MINI	B37 C15 A	536	10
			B47 C20 B (Euro 6)	537	11	
87-449700-40	STD	BMW	B47 C20 B, B47 D20 B	72	8	
		MINI	B47 C20 B (Euro 6)	537	11	
87-449707-30	STD	BMW	B37 C15 A (Euro 6)	72	7	
			B47 C20 B, B47 D20 B	72	8	
			MINI	B37 C15 A	536	10
			B47 C20 B (Euro 6)	537	11	
87-449707-40	STD	BMW	B47 C20 B, B47 D20 B	72	8	
		MINI	B47 C20 B (Euro 6)	537	11	
87-450400-00	STD	DACIA	H5F 402 (Euro 5/6), H5F 404 (Euro 5/6), H5F 408 (Euro 5/6), H5F 410 (Euro 5/6)	122	3	
		RENAULT	H5F 400 (Euro 5/6), H5F 402 (Euro 5/6), H5F 403 (Euro 5/6), H5F 404 (Euro 5/6), H5F 408 (Euro 5/6), H5F 412 (Euro 5/6)	647	6	
87-450400-10	STD	DACIA	H4B 400, H4B 408	122	2	
		NISSAN	H4B 408	558	3	
		RENAULT	H4B 400, H4B 401, H4B 408, H4B 453	647	5	
87-450500-00	STD	ALFA ROMEO	330 A1.000	21	3	
		FIAT	312 A8.000 (Euro 6), 312 B2.000 (Euro 6)	168	10	
87-450600-00	STD	FIAT	F1AE3481D, F1AE3481E, F1AE3481G	188	63	
		IVECO	F1AE3481A, F1AE3481B, F1AE3481C	268	3	
87-450900-00	STD	FIAT	GSE-T3 (Euro 6 FireFly), GSE-T4 (Euro 6 FireFly)	168	12	
87-451700-00	STD	MAN	D 2066 LF25 (Euro 5)	392	17	
87-452400-00	STD	FORD	AEDA (Duratorq), UGCA (Duratorq), UGCB (Duratorq), UGJC, UGJE (Duratorq), XUCA (Duratorq), XUCC (Duratorq), XUCD (Duratorq), XUJA (Euro 6 Duratorq), XUJB (Euro 6 Duratorq), XUJC (Euro 6 Duratorq), XVCA (Duratorq), XVCB (Duratorq), XVCC (Duratorq), XVJA (Duratorq), XVJB (Duratorq), XVJC (Duratorq), XVJD (Duratorq), XWCA (Euro 6 Duratorq), XWCB (Euro 6 Duratorq), XWJA (Euro 5 Duratorq), XXGA (Euro 6 Duratorq)	202	3	
87-452407-00	0.50mm	FORD	AEDA (Duratorq), UGCA (Duratorq), UGCB (Duratorq), UGJC, UGJE (Duratorq), XUCA (Duratorq), XUCC (Duratorq), XUCD (Duratorq), XUJA (Euro 6 Duratorq), XUJB (Euro 6 Duratorq), XUJC (Euro 6 Duratorq), XVCA (Duratorq), XVCB (Duratorq), XVCC (Duratorq), XVJA (Duratorq), XVJB (Duratorq), XVJC (Duratorq), XVJD (Duratorq), XWCA (Euro 6 Duratorq), XWCB (Euro 6 Duratorq), XWJA (Euro 5 Duratorq), XXGA (Euro 6 Duratorq)	202	3	
87-452600-00	STD	NISSAN	YD25DDTI	567	24	
87-452607-00	0.50mm	NISSAN	YD25DDTI	567	24	
87-452700-00	STD	CITROËN	EC5, EC5 (NFP)	102	22	
		PEUGEOT	EC5 (NFP), EC5F, EC5F (NFJ)	618	24	
87-452707-00	STD	CITROËN	EC5, EC5 (NFP)	102	22	
		PEUGEOT	EC5 (NFP), EC5F, EC5F (NFJ)	618	24	
87-452800-10	STD	FORD	BNMA (EcoBoost), M8DA (EcoBoost), M8DB (EcoBoost), M8DD (EcoBoost), M8DE (EcoBoost), M8MA (EcoBoost), M8MB (EcoBoost), M9DA (EcoBoost), M9DB (EcoBoost), M9DG (EcoBoost), M9DH (EcoBoost), M9MA (EcoBoost), M9MC (EcoBoost), UNCA (EcoBoost), UNCB (EcoBoost), UNCC (EcoBoost), UNCD (EcoBoost), UNCE (EcoBoost), UNCF (EcoBoost), UNCG (EcoBoost), UNCH (EcoBoost), UNCI (EcoBoost), UNCJ (EcoBoost), UNCK (EcoBoost), UNCM (EcoBoost), UNCN (Euro 6 EcoBoost)	206	11	
87-452800-30	STD	FORD	JQDA (EcoBoost), JQDB (EcoBoost), JQMA (EcoBoost), JQMB (EcoBoost), JTDA (EcoBoost), JTDB (EcoBoost), JTMA (EcoBoost), JTWA, JTWB	208	15	
		VOLVO	B 4164 T (Euro 5), B 4164 T2 (Euro 5), B 4164 T3 (Euro 5), B 4164 T4 (Euro 5)	815	9	
87-452807-10	0.50mm	FORD	BNMA (EcoBoost), M8DA (EcoBoost), M8DB (EcoBoost), M8DD (EcoBoost), M8DE (EcoBoost), M8MA (EcoBoost), M8MB (EcoBoost), M9DA (EcoBoost), M9DB (EcoBoost), M9DG (EcoBoost), M9DH (EcoBoost), M9MA (EcoBoost), M9MC (EcoBoost), UNCA (EcoBoost), UNCB (EcoBoost), UNCC (EcoBoost), UNCD (EcoBoost), UNCE (EcoBoost), UNCF (EcoBoost), UNCG (EcoBoost), UNCH (EcoBoost), UNCI (EcoBoost), UNCJ (EcoBoost), UNCK (EcoBoost), UNCM (EcoBoost), UNCN (Euro 6 EcoBoost)	206	11	
87-452807-30	0.50mm	FORD	JQDA (EcoBoost), JQDB (EcoBoost), JQMA (EcoBoost), JQMB (EcoBoost), JTDA (EcoBoost), JTDB (EcoBoost), JTMA (EcoBoost), JTWA, JTWB	208	15	
		VOLVO	B 4164 T (Euro 5), B 4164 T2 (Euro 5), B 4164 T3 (Euro 5), B 4164 T4 (Euro 5)	815	9	
87-452900-00	STD	FORD	BKFA (Euro 6 EcoBlue), BKFB (Euro 6 EcoBlue), BKFC (Euro 6 EcoBlue), BKFD (Euro 6 EcoBlue), BKRA (EcoBlue), BKRB (EcoBlue), YMFA (Euro 6 EcoBlue), YMFB (Euro 6 EcoBlue), YMHA (EcoBlue), YMRA (EcoBlue)	216	30	
87-452907-00	0.50mm	FORD	BKFA (Euro 6 EcoBlue), BKFB (Euro 6 EcoBlue), BKFC (Euro 6 EcoBlue), BKFD (Euro 6 EcoBlue), BKRA (EcoBlue), BKRB (EcoBlue), YMFA (Euro 6 EcoBlue), YMFB (Euro 6 EcoBlue), YMHA (EcoBlue), YMRA (EcoBlue)	216	30	
87-453000-00	STD	CITROËN	EP6CDT (5FN), EP6CDT (5FV), EP6DT (5FM) (Euro 4), EP6DT (5FR), EP6DT (5FT), EP6FDT (5GZ) (Euro 4)	101	20	
		PEUGEOT	EP6CDT (5FA), EP6CDT (5FV), EP6DT (5FT), EP6FDT (5GZ) (Euro 4), EP6FDTM (5GY) (Euro 4)	617	21	
87-453007-00	0.50mm	CITROËN	EP6CDT (5FN), EP6CDT (5FV), EP6DT (5FM) (Euro 4), EP6DT (5FR), EP6DT (5FT), EP6FDT (5GZ) (Euro 4)	101	20	
		PEUGEOT	EP6CDT (5FA), EP6CDT (5FV), EP6DT (5FT), EP6FDT (5GZ) (Euro 4), EP6FDTM (5GY) (Euro 4)	617	21	
87-453100-00	STD	CITROËN	DV6FC (BHT), DV6FC (BHU), DV6FC (BHX), DV6FC (BHZ), DV6FD (BHY)	99	16	
		OPEL	B 16 DT (DV6DTEd), B 16 DT (DV6FD), B 16 DTH (DV6FC)	577	14	

NEW PARTS LIST





Nummerische Teilenummernliste • Liste des références produits
Lista de nuevas referencias





						9
87-453100-00	STD	PEUGEOT	DV6FC (BH2), DV6FD (BHY)	615	17	
			VAUXHALL	B 16 DT (DV6FD), B 16 DTH (DV6FC)	790	15
87-453107-00	0.50mm	CITROËN	DV6FC (BHT), DV6FC (BHU), DV6FC (BHX), DV6FC (BHZ), DV6FD (BHY)	99	16	
		OPEL	B 16 DT (DV6TDED), B 16 DT (DV6FD), B 16 DTH (DV6FC)	577	14	
		PEUGEOT	DV6FC (BH2), DV6FD (BHY)	615	17	
		VAUXHALL	B 16 DT (DV6FD), B 16 DTH (DV6FC)	790	15	
87-453200-00	STD	OPEL	B 10 XFL (Euro 6), B 10 XFT (Euro 6), D 10 XFL (Euro 6), F 10 XFL (Euro 6)	577	12	
		VAUXHALL	B 10 XFL (Euro 6), B 10 XFT (Euro 6), D 10 XFL (Euro 6), F 10 XFL (Euro 6)	789	13	
87-453207-00	0.50mm	OPEL	B 10 XFL (Euro 6), B 10 XFT (Euro 6), D 10 XFL (Euro 6), F 10 XFL (Euro 6)	577	12	
		VAUXHALL	B 10 XFL (Euro 6), B 10 XFT (Euro 6), D 10 XFL (Euro 6), F 10 XFL (Euro 6)	789	13	
87-453500-00	STD	AUDI	DADA (Euro 6), DHFA (Euro 6), DPCA (Euro 6)	38	4	
		SEAT	DADA (Euro 6), DHFA (Euro 6), DPCA (Euro 6)	715	6	
		SKODA	DADA (Euro 6), DHFA (Euro 6), DPCA (Euro 6)	739	5	
		VW	DADA (Euro 6), DHFA (Euro 6), DPCA (Euro 6)	853	5	
87-740000-30	STD	MERCEDES-BENZ	OM 354.900 (Euro 2), OM 354.901 (Euro 2 OM364 LA), OM 354.902 (Euro 2 OM364 LA), OM 354.903 (Euro 2 OM364 LA), OM 354.920 (Euro 2 OM364 LA), OM 354.921 (Euro 2 OM364 LA), OM 354.922 (Euro 2 OM364 LA), OM 354.923 (Euro 2 OM364 LA), OM 354.924 (Euro 2 OM364 LA), OM 354.925 (Euro 2 OM364 LA), OM 354.926 (Euro 2), OM 357.900 (OM366 LA), OM 357.901 (OM366 LA), OM 357.902 (OM366 LA), OM 357.903 (OM366 LA), OM 357.904 (OM366 LA), OM 357.906 (OM366 LA), OM 357.907 (OM366 LA), OM 357.908 (OM366 LA), OM 357.909 (OM366 LA), OM 357.910 (OM366 LA), OM 357.915 (OM366 LA), OM 357.916 (OM366 LA), OM 357.917 (OM366 LA), OM 357.918 (OM366 LA), OM 357.919 (OM366 LA), OM 357.920 (OM366 LA), OM 357.921 (OM366 LA), OM 357.922 (OM366 LA), OM 357.924 (Euro 2 OM366 LA), OM 357.925 (OM366 LA), OM 357.926 (OM366 LA), OM 357.927 (OM366 LA), OM 357.929 (OM366 LA), OM 357.930 (OM366 LA), OM 357.931 (Euro 2 OM366 LA), OM 357.932 (OM366 LA), OM 357.933 (OM366 LA), OM 357.934 (OM366 LA), OM 357.935 (OM366 LA), OM 357.936 (Euro 2 OM366 LA), OM 357.937 (Euro 2 OM366 LA), OM 357.938 (Euro 2), OM 357.940 (OM366 LA), OM 357.941 (OM366 LA), OM 357.942 (OM366 LA), OM 357.943 (OM366 LA), OM 357.944 (OM366 LA), OM 357.945 (Euro 2 OM366 LA), OM 357.946 (OM366 LA), OM 357.947 (OM366 LA), OM 357.948 (OM366 LA), OM 357.949 (Euro 2 OM366 LA), OM 357.961 (OM366 LA), OM 357.962 (OM366 LA), OM 357.963 (OM366 LA), OM 364.901, OM 366.956	480	47	
87-741211-10	1.00mm	COMPRESSOR	WESTINGHOUSE (MB OM467/904/906, DAF 825/1160)	118	2	
87-743600-30	STD	MERCEDES-BENZ	OM 604.915, OM 604.917, OM 605.910, OM 605.911, OM 605.912, OM 606.910, OM 606.912	457	16	
87-743607-30	0.50mm	MERCEDES-BENZ	OM 604.915, OM 604.917, OM 605.910, OM 605.911, OM 605.912, OM 606.910, OM 606.912	457	16	

				9
14-011560-10	DAF	FR 103 S1 (Euro 4), FR 118 S1 (Euro 4), FR 136 S1 (Euro 4), FR 152 (Euro 5), GR 165 S1, GR 184 S1 (Euro 4), GR 210 S1 (Euro 4), GR 220 (Euro 4)	136	8
14-020780-00	ISUZU	4HF1-II	254	6
14-021930-00	ISUZU	4HK1-TC (Euro 3/4)	255	8
14-049310-00	PERKINS	1004-40, 1006-60	600	12
14-451030-00	VOLVO	D16A, D16A470 (Euro 2), D16A520, D16B520	842	57
		TAD1630G, TAD1630GE, TAD1630P, TAD1631G, TWD1630G, TWD1630P	842	58
		TD163ES	842	59
14-480070-00	RENAULT	MIDR 06.20.45, MIDR 06.20.45 I41 (Euro 2), MIDS 06.20.30, MIDS 06.20.30 N, MIDS 06.20.30 N1, MIPS 06.20.30	673	55
		MIDR 06.20.45 A, MIDR 06.20.45 C, MIPR 06.20.45 A3, MIPR 06.20.45 C3	673	56
		MIDR 06.20.45 A2, MIDR 06.20.45 C/4 (Euro 2), MIDR 06.20.45 D/41 (Euro 2), MIDR 06.20.45 M41 (Euro 2), MIHR 06.20.45 A41 (Euro 2)	674	57
		MIDR 06.20.45 B3 (Euro 1), MIDR 06.20.45 D3 (Euro 1), MIDR 06.20.45 E, MIDR 06.20.45 E/41 (Euro 2), MIDR 06.20.45 E2 (Euro 1), MIDR 06.20.45 H, MIDS 06.20.45 B	674	58
		MIPS 06.20.45, MIPS 06.20.45 A, MIPS 06.20.45 B, MIPS 06.20.45 C	676	61
14-480080-00	RENAULT	MIDR 06.20.45 A2, MIDR 06.20.45 C/4 (Euro 2), MIDR 06.20.45 D/41 (Euro 2), MIDR 06.20.45 M41 (Euro 2), MIHR 06.20.45 A41 (Euro 2)	674	57
		MIDR 06.20.45 B3 (Euro 1), MIDR 06.20.45 D3 (Euro 1), MIDR 06.20.45 E, MIDR 06.20.45 E/41 (Euro 2), MIDR 06.20.45 E2 (Euro 1), MIDR 06.20.45 H, MIDS 06.20.45 B	674	58
		MIDR 06.20.45 D, MIDR 06.20.45 E3 (Euro 1)	675	59
15-112800-00	SCANIA	DC 11.02 (Euro 3 DC 11), DC 11.04 (Euro 3 DC 11), DC 11.09 (Euro 3 DC 11), DC 9.11 (Euro 3), DC 9.12 (Euro 3), DC 9.13 (Euro 3), DC 9.19 (Euro 3), DC 9.20 (Euro 3 DC 9), DC 9.21 (DC 9)	701	6
		DC 11.01 (Euro 3 DC 11), DC 11.03 (Euro 3 DC 11), DC 11.07 (Euro 2 DC 11), DC 11.08 (Euro 3 DC 11)	702	9
		DC 12.01 (Euro 3 DC 12), DC 12.03 (Euro 3 DC 12), DC 12.09 (Euro 3 DC 12), DC 16.02 (Euro 3 DC 16), DSC 12.01 (Euro 2 DSC 12), DSC 12.02 (Euro 2 DSC 12), DSC 12.03 (Euro 2 DSC 12), DT 12.02 (Euro 3 DT 12)	703	10
		DC 12.02 (Euro 2 DC 12), DC 12.06 (Euro 3 DC 12), DC 12.14 (Euro 3 DC 12), DC 12.17 (Euro 3 DC 12), DC 16.01 (Euro 3 DC 16), DC 16.03 (Euro 3 DC 16), DC 16.04 (Euro 3 DC 16), DSC 12.05 (Euro 2 DSC 12), DT 12.08 (DC 12)	703	11
		DC 16.05 (Euro 4 DC 16), DC 16.06 (Euro 4 DC 16), DC 16.08 (Euro 4 DC 16), DC 16.17 (Euro 5 DC 16), DC 16.18 (Euro 5 DC 16), DC 16.19 (Euro 5 DC 16), DC 16.22 (DC 16)	706	17
15-260050-10	IVECO	F3BE0681A (Euro 3 Cursor 13), F3BE0681B (Euro 3 Cursor 13), F3BE0681C (Euro 3 Cursor 13), F3BE0681D (Euro 3 Cursor 13), F3BE0681E (Euro 3 Cursor 13), F3BE0681F (Euro 3 Cursor 13), F3BE0681G (Euro 3 Cursor 13)	300	55
		F3BE3681A (Euro 4/5 Cursor 13), F3BE3681B (Euro 4/5 Cursor 13), F3BE3681C (Euro 4/5 Cursor 13), F3BE3681D (Euro 4/5 Cursor 13), F3BE3681E (Euro 4/5 Cursor 13), F3BE3681F (Euro 4/5 Cursor 13), F3BE3681G (Euro 4/5 Cursor 13)	301	56
15-260070-00	IVECO	F2BE0681A (Euro 2 Cursor 8), F2BE0681B (Euro 2 Cursor 8), F2BE0681C (Euro 2 Cursor 8), F2BE0681D (Euro 2 Cursor 8), F2BE0681DA (Euro 2 Cursor 8), F2BE0681DB (Euro 2 Cursor 8), F2BE0681E (Euro 2 Cursor 8), F2BE0681F (Euro 2 Cursor 8)	296	44
		F2BE0681A/B/C/D/F (Euro 3), F2BE1682G (Euro 3)	296	45
15-450030-00	MAN	D 2865 LF/260, D 2865 LFR, D 2865 LFR01, D 2866 KF, D 2866 KFZ, D 2866 KOH360, D 2866 KUH/360 (Euro 1), D 2866 KUL, D 2866 LF, D 2866 LF/290, D 2866 LF04, D 2866 LF07, D 2866 LF08, D 2866 LFZ/290, D 2866 LFZ/330, D 2866 LH01, D 2866 LU, D 2866 LU07, D 2866 LU08, D 2866 LU330, D 2866 LUH, D 2866 LUH04 (Euro 1), D 2866 LUH330, D 2866 LUL330, D 2866 LXE40, D 2866 LXE47, D 2866 T, D 2866 TOH, D 2866 TOH/290, D 2866 TOH/310, D 2866 TUH, D 2866 TUH/290, D 2866 TUH01	400	31
		D 2865 LF02, D 2865 LF03, D 2865 LF05 (Euro 1), D 2865 LF06 (Euro 1), D 2865 LF10, D 2865 LF22 (Euro 1), D 2865 LF23 (Euro 1), D 2865 LOH01 (Euro 1), D 2865 LOH02 (Euro 1), D 2865 LOH05 (Euro 1), D 2865 LU01 (Euro 1), D 2865 LU02, D 2865 LU03, D 2865 LU04 (Euro 1), D 2865 LU06 (Euro 1), D 2865 LUH02 (Euro 1), D 2865 LUH03 (Euro 1), D 2865 LUH05 (Euro 1), D 2865 LUH06 (Euro 1), D 2865 LUH08 (Euro 1), D 2865 LXF, D 2865 LXFR, D 2866 LF02, D 2866 LF03, D 2866 LF06, D 2866 LF09 (Euro 1), D 2866 LF10 (Euro 1), D 2866 LF15 (Euro 1), D 2866 LF21 (Euro 1), D 2866 LF22 (Euro 1), D 2866 LFG, D 2866 LFG03 (Euro 1), D 2866 LFG04 (Euro 1), D 2866 LOH, D 2866 LOH02, D 2866 LOH03, D 2866 LOH06 (Euro 1), D 2866 LOH07, D 2866 LOH09 (Euro 1), D 2866 LOH20 (Euro 1), D 2866 LOH21 (Euro 1), D 2866 LOH22 (Euro 1), D 2866 LOH24 (Euro 1), D 2866 LU01, D 2866 LU03 (Euro 1), D 2866 LU04, D 2866 LUH05 (Euro 1), D 2866 LX, D 2866 LXF, D 2866 LXFG, D 2866 LXOH, D 2866 LXU, D 2866 LXUH	401	32
		D 2865 LF09, D 2865 LF21 (Euro 2), D 2865 LF24 (Euro 2), D 2865 LUH07 (Euro 2), D 2865 LUH09 (Euro 2), D 2866 LF14 (Euro 2), D 2866 LF16 (Euro 2), D 2866 LF17 (Euro 2), D 2866 LF20 (Euro 2), D 2866 LF29 (Euro 2), D 2866 LF30 (Euro 2), D 2866 LF34 (Euro 2), D 2866 LF35 (Euro 2), D 2866 LF36 (Euro 2), D 2866 LF37 (Euro 2), D 2866 LOH23 (Euro 2), D 2866 LOH25 (Euro 2), D 2866 LOH26 (Euro 2), D 2866 LUH21 (Euro 2), D 2866 LUH22 (Euro 2), D 2866 LUH26 (Euro 2)	402	33
		D 2865 LOH07 (Euro 2), D 2865 LOH09 (Euro 2), D 2866 F/240, D 2866 FG, D 2866 FR, D 2866 KOH/373, D 2866 LF01, D 2866 LFG05 (Euro 2), D 2866 LOH31 (Euro 2), D 2866 OH, D 2866 U, D 2866 UH, D 2866 UH/240, D 2866 UM, D 2876 LF01 (Euro 2), D 2876 LF05 (Euro 3), D 2876 LF11 (Euro 2), D 2876 LUE604, D 2876 LUE605, D 2876 LUE606	403	34
		D 2866 LF05 (Euro 1)	404	35

NEW PARTS LIST





Nummerische Teilenummernliste • Liste des références produits
Lista de nuevas referencias





				9
15-45030-00	MAN	D 2866 LF23 (Euro 3), D 2866 LF24 (Euro 3), D 2866 LF25 (Euro 3), D 2866 LF26 (Euro 3), D 2866 LF27 (Euro 3), D 2866 LF28 (Euro 3), D 2866 LF607 (Euro 3), D 2866 LOH27 (Euro 3), D 2866 LOH28 (Euro 3), D 2866 LOH29 (Euro 3), D 2866 LOH32 (Euro 3), D 2866 LOH33 (Euro 3), D 2866 LOH34 (Euro 3), D 2866 LOH35 (Euro 3), D 2866 LUH23 (Euro 3), D 2866 LUH24 (Euro 3), D 2866 LUH25 (Euro 3), D 2866 LUH27 (Euro 3), D 2866 LUH28 (Euro 3), D 2866 LUH29 (Euro 3), D 2866 LUH30 (Euro 3), D 2866 LUH51 (Euro 3)	405	36
		D 2866 LF31 (Euro 2), D 2866 LF32 (Euro 2), D 2866 LF39 (Euro 2), D 2866 LF40 (Euro 2), D 2866 LF41 (Euro 2), D 2866 LF42 (Euro 2), D 2866 LF43 (Euro 2)	406	37
		D 2876 LF02 (Euro 2), D 2876 LOH01 (Euro 2), D 2876 LUH01 (Euro 2), D 2876 LUH02 (Euro 2)	407	38
		D 2876 LF03 (Euro 3), D 2876 LF04 (Euro 3), D 2876 LF06 (Euro 2), D 2876 LF07 (Euro 2), D 2876 LF10 (Euro 2), D 2876 LF17, D 2876 LOH02 (Euro 3), D 2876 LOH03 (Euro 3)	407	39
15-450110-00	SCANIA	DS 11.22 (DS 11), DS 11.23 (DS 11), DS 11.75 (DS 11), DSC 11.21 (Euro 1 DSC 11), DSC 11.22 (Euro 1 DSC 11), DSC 11.23 (Euro 1 DSC 11), DSC 11.35 (DSC 11), DSC 11.36 (DSC 11), DSC 11.39 (Euro 1 DSC 11), DSC 11.70 (Euro 2 DSC 11), DSC 11.71 (DSC 11), DSC 11.74 (Euro 1 DSC 11), DSC 11.75 (Euro 1 DSC 11), DSC 11.79 (Euro 2 DSC 11), DSC 11.81 (DSC 11), DTC 11.01 (Euro 1 DTC 11), DTC 11.02 (Euro 2 DTC 11)	705	15
15-450380-00	MERCEDES-BENZ	OM 457.914 (Euro 3), OM 457.915 (Euro 3), OM 457.916 (Euro 3), OM 457.917 (Euro 2/3), OM 457.918 (Euro 3), OM 457.919 (Euro 3), OM 457.920 (Euro 3), OM 457.922 (Euro 3), OM 457.923 (Euro 3), OM 457.924 (Euro 3), OM 457.925 (Euro 3), OM 457.926 (Euro 3), OM 457.927 (Euro 3), OM 457.928 (Euro 3), OM 457.931 (Euro 3), OM 457.932 (Euro 3), OM 458.960 (Euro 3), OM 458.970 (Euro 3), OM 458.980 (Euro 3)	514	77
		OM 457.929 (Euro 3), OM 457.947 (Euro 2), OM 457.955 (Euro 3), OM 457.958 (Euro 2/3), OM 457.960 (Euro 2), OM 457.962 (Euro 3), OM 460.900 (Euro 3), OM 460.901 (Euro 3), OM 460.902 (Euro 3), OM 460.903 (Euro 3), OM 460.904 (Euro 3), OM 460.905 (Euro 3), OM 460.906 (Euro 3), OM 460.907 (Euro 3), OM 460.908 (Euro 3), OM 460.909 (Euro 3), OM 460.910 (Euro 3), OM 460.911 (Euro 3), OM 460.912 (Euro 3), OM 460.913 (Euro 3), OM 460.914 (Euro 3), OM 460.915 (Euro 3), OM 460.916 (Euro 3), OM 460.917 (Euro 3), OM 460.918 (Euro 3), OM 460.919 (Euro 3), OM 460.920 (Euro 3), OM 460.921 (Euro 3), OM 460.922 (Euro 3), OM 460.923 (Euro 3), OM 460.925 (Euro 3), OM 460.929 (Euro 3), OM 460.931 (Euro 3)	515	78
		OM 457.933 (Euro 2/3), OM 457.934 (Euro 2/3), OM 457.935 (Euro 2/3), OM 457.936 (Euro 2), OM 457.937 (Euro 2/3), OM 457.938 (Euro 2), OM 457.939 (Euro 2), OM 457.940 (Euro 2/3), OM 457.941 (Euro 2/3), OM 457.942 (Euro 2/3), OM 457.943 (Euro 2/3), OM 457.944 (Euro 2/3), OM 457.945 (Euro 2), OM 457.946 (Euro 2), OM 457.949 (Euro 2)	516	79
15-450590-00	RENAULT	DXI 12 (Euro 3)	679	68
	VOLVO	D12C340 (Euro 2), D12C380, D12D340 (Euro 3), DH12D340 (Euro 3)	836	48
		D12C420, D12C460, D12D380 (Euro 3), D12D420 (Euro 3), D12D460 (Euro 3), D12D500 (Euro 3)	837	49
		D12F390 (Euro 4), D12F430 (Euro 4)	838	50
		DH12D380 (Euro 3)	840	54
DH12E340, DH12E380 (Euro 4), DH12E420 (Euro 4/5), DH12E460 (Euro 4)	841	56		
15-450790-00	MERCEDES-BENZ	OM 541.953 (Euro 4/5 OM501 LA), OM 541.959 (Euro 4/5 OM501 LA), OM 541.970 (Euro 4 OM501 LA), OM 541.971 (Euro 4/5 OM501 LA), OM 541.972 (Euro 4 OM501 LA), OM 541.973 (Euro 4 OM501 LA), OM 541.974 (Euro 4 OM501 LA), OM 541.975 (Euro 4 OM501 LA), OM 541.976 (Euro 4 OM501 LA), OM 541.977 (Euro 4 OM501 LA), OM 541.978 (Euro 4 OM501 LA), OM 541.979 (Euro 4/5 OM501 LA), OM 541.980 (Euro 4 OM501 LA), OM 541.981 (Euro 4 OM501 LA), OM 541.990 (Euro 5 OM501 LA), OM 541.992 (Euro 5 OM501 LA), OM 541.994 (Euro 5 OM501 LA), OM 541.996 (Euro 5 OM501 LA), OM 541.997 (OM501 LA), OM 541.998 (Euro 5 OM501 LA), OM 541.999 (OM501 LA), OM 542.960 (Euro 5), OM 542.961 (Euro 5), OM 542.962 (Euro 5 OM502 LA), OM 542.963 (Euro 5 OM502 LA), OM 542.964 (Euro 5), OM 542.965, OM 542.966 (Euro 5), OM 542.970 (Euro 5), OM 542.971 (Euro 5), OM 542.972 (Euro 5) OM 541.991 (OM501 LA), OM 941.991 (OM501 LA)	525	90
15-450850-00	SCANIA	D 11 R 23 (D 11), DN 11.01 (DN 11), DN 11.01 B10 (DN 11), DN 11.01 C 09 (DN 11), DN 11.04 B10 (DN 11), DN 11.04 C 01 (DN 11), DN 11.06 (DN 11), DN 11.07 (DN 11), DN 11.08 (DN 11), DN 11.08 B01 (DN 11), DS 11 / D11 (D 11), DS 11.01 (DS 11), DS 11.01 B 06 (DS 11), DS 11.02 (DS 11), DS 11.14 (DS 11), DS 11.15 (DS 11), DS 11.15 B (DS 11), DS 11.18 (DS 11), DS 11.34 (DS 11), DS 11.71 (DS 11), DS 11.71 C (DS 11), DS 11.72 (DS 11), DS 11.73 (DS 11), DS 11.74 (DS 11), DSC 11.01 (DSC 11), DSC 11.02 (DSC 11), DSC 11.04 (DSC 11), DSC 11.12 (DSC 11), DSC 11.13 (DSC 11), DSC 11.16 (DSC 11), DSC 11.17 (DSC 11), DSC 11.18 (DSC 11), DSI 11.01 (DSI 11)	701	8
		DS 11.22 (DS 11), DS 11.23 (DS 11), DS 11.75 (DS 11), DSC 11.21 (Euro 1 DSC 11), DSC 11.22 (Euro 1 DSC 11), DSC 11.23 (Euro 1 DSC 11), DSC 11.35 (DSC 11), DSC 11.36 (DSC 11), DSC 11.39 (Euro 1 DSC 11), DSC 11.70 (Euro 2 DSC 11), DSC 11.71 (DSC 11), DSC 11.74 (Euro 1 DSC 11), DSC 11.75 (Euro 1 DSC 11), DSC 11.79 (Euro 2 DSC 11), DSC 11.81 (DSC 11), DTC 11.01 (Euro 1 DTC 11), DTC 11.02 (Euro 2 DTC 11)		
15-451040-00	MAN	D 2676 LF01 (Euro 4), D 2676 LF02 (Euro 3), D 2676 LF03 (Euro 2), D 2676 LF04 (Euro 2), D 2676 LF05 (Euro 4), D 2676 LF07 (Euro 5), D 2676 LF10 (Euro 4), D 2676 LF12 (Euro 4), D 2676 LF14 (Euro 5), D 2676 LF16 (Euro 5), D 2676 LF18, D 2676 LF20 (Euro 4), D 2676 LF21 (Euro 5), D 2676 LF22 (Euro 5), D 2676 LF25 (Euro 6), D 2676 LF26 (Euro 6), D 2676 LF28 (Euro 5), D 2676 LF31 (Euro 3), D 2676 LF32 (Euro 4), D 2676 LF33 (Euro 4)	397	26
		D 2676 LF06 (Euro 5), D 2676 LF08 (Euro 5), D 2676 LF11 (Euro 4), D 2676 LF13 (Euro 5), D 2676 LF15 (Euro 5), D 2676 LF17, D 2676 LF19 (Euro 4)	398	27

				9
15-451040-00	MAN	D 2676 LOH01 (Euro 4), D 2676 LOH02 (Euro 4), D 2676 LOH03 (Euro 4), D 2676 LOH04 (Euro 4), D 2676 LOH10 (Euro 3), D 2676 LOH26 (Euro 5), D 2676 LOH27 (Euro 5) D 2676 LOH28 (Euro 5)	399	29
15-451160-00	MERCEDES-BENZ	OM 421.905, OM 421.906, OM 421.907, OM 421.908, OM 421.909, OM 421.910, OM 422.905, OM 422.906, OM 422.907, OM 422.908, OM 422.909, OM 422.910, OM 422.911, OM 422.912, OM 422.913, OM 422.914, OM 422.915, OM 422.916, OM 422.917, OM 422.918, OM 422.919, OM 422.920, OM 422.921, OM 422.922, OM 422.923, OM 423.905, OM 423.906, OM 423.907, OM 423.908, OM 423.909, OM 424.900 OM 421.951, OM 422.901, OM 422.951, OM 422.952, OM 422.953, OM 422.954, OM 422.955, OM 422.956, OM 422.957, OM 422.958, OM 422.959, OM 422.963, OM 423.950, OM 424.901, OM 424.901.510 OM 441.950, OM 441.951, OM 441.953, OM 441.960, OM 441.961, OM 441.962, OM 441.981, OM 441.982, OM 441.983, OM 441.985, OM 442.901, OM 442.940, OM 442.941, OM 442.942, OM 442.943, OM 442.944, OM 442.945, OM 442.946, OM 442.951, OM 442.953, OM 442.954, OM 442.955, OM 442.957, OM 442.958, OM 442.959, OM 442.960, OM 442.961, OM 442.963, OM 442.964, OM 442.965, OM 442.966, OM 442.967, OM 442.968, OM 442.970, OM 442.971, OM 442.972, OM 442.976, OM 442.980, OM 442.982, OM 442.983, OM 442.985, OM 442.989, OM 442.991, OM 442.992, OM 442.993, OM 442.994, OM 443.901, OM 443.940, OM 443.980, OM 444.901 OM 423.901, OM 440.948 (OM442 A), OM 440.949 (OM442 A), OM 440.974 (OM442 LA), OM 441.952, OM 442 A, OM 444 LA, OM 481.902, OM 481.904, OM 482.912, OM 482.930, OM 482.940, OM 482.941 OM 440.970 (Euro 1 OM442 LA), OM 440.971 (Euro 1 OM442 LA), OM 440.972 (Euro 1 OM442 LA), OM 440.973 (Euro 1 OM442 LA), OM 440.975 (Euro 1 OM442 LA), OM 440.976 (Euro 1 OM442 LA), OM 440.978 (Euro 1 OM442 LA), OM 440.979 (Euro 1 OM442 LA), OM 440.980 (Euro 1 OM442 LA), OM 440.981 (Euro 1 OM442 LA), OM 440.982 (Euro 1 OM442 LA), OM 440.983 (Euro 1 OM442 LA), OM 440.984 (Euro 1 OM442 LA), OM 440.985 (Euro 1 OM442 LA), OM 440.986 (Euro 1 OM442 LA), OM 440.987 (Euro 1 OM442 LA), OM 440.988 (Euro 1 OM442 LA), OM 440.989 (Euro 1 OM442 LA), OM 440.990 (Euro 1 OM442 LA), OM 440.991 (Euro 1 OM442 LA), OM 441.980, OM 441.986 (Euro 1), OM 441.987 (Euro 1), OM 441.988 (Euro 1), OM 441.989 (Euro 1), OM 441.990 (Euro 1), OM 441.991 (Euro 1), OM 441.992 (Euro 1), OM 441.993 (Euro 1), OM 441.994 (Euro 1), OM 441.995 (Euro 1), OM 441.996 (Euro 1), OM 441.997 (Euro 1), OM 441.998 (Euro 1), OM 441.999 (Euro 1), OM 442.995 (Euro 1), OM 442.996 (Euro 1), OM 442.997 (Euro 1), OM 442.998 (Euro 1), OM 442.999 (Euro 1) OM 445.920 (Euro 2 OM441 LA), OM 445.921 (Euro 2 OM441 LA), OM 445.922 (Euro 2 OM441 LA), OM 445.923 (Euro 2 OM441 LA), OM 445.924 (Euro 2 OM441 LA), OM 445.925 (Euro 2 OM441 LA), OM 445.926 (Euro 2 OM441 LA), OM 445.927 (Euro 2 OM441 LA), OM 445.929 (Euro 2 OM441 LA), OM 445.930 (Euro 2 OM441 LA), OM 445.931 (Euro 2 OM441 LA), OM 445.933 (Euro 2 OM441 LA), OM 445.934 (Euro 2 OM441 LA), OM 445.935 (Euro 2 OM441 LA), OM 445.936 (Euro 2 OM441 LA), OM 445.937 (Euro 2 OM441 LA), OM 445.938 (Euro 2 OM441 LA), OM 445.939 (Euro 2 OM441 LA), OM 445.940 (Euro 2 OM441 LA), OM 445.941 (Euro 2 OM441 LA), OM 446.920 (Euro 2 OM442 LA), OM 446.922 (Euro 2 OM442 LA), OM 446.923 (OM442 LA), OM 446.924 (Euro 2 OM442 LA), OM 446.925 (Euro 2 OM442 LA), OM 446.926 (Euro 2 OM442 LA), OM 446.927 (Euro 2 OM442 LA), OM 446.928 (Euro 2 OM442 LA), OM 446.929 (Euro 2 OM442 LA), OM 446.930 (Euro 2 OM442 LA), OM 446.931 (Euro 2 OM442 LA), OM 446.932 (Euro 2 OM442 LA), OM 446.933 (Euro 2 OM442 LA), OM 446.934 (Euro 2 OM442 LA), OM 446.935 (Euro 2 OM442 LA), OM 446.936 (Euro 2 OM442 LA), OM 446.938 (Euro 2 OM442 LA), OM 446.939 (Euro 2 OM442 LA), OM 446.940 (Euro 2 OM442 LA), OM 446.941 (Euro 2 OM442 LA), OM 446.942 (Euro 2 OM442 LA), OM 446.943 (Euro 2 OM442 LA), OM 446.945 (Euro 2 OM442 LA), OM 446.946 (Euro 2 OM442 LA), OM 446.948 (Euro 2 OM442 LA) OM 440.940 (OM442 A), OM 440.941 (OM442 A), OM 440.942 (OM442 A), OM 440.943 (OM442 A) OM 440.945 (Euro 1 OM442 A), OM 442 A (Euro 1), OM 442.977, OM 442.978 OM 442.950, OM 442.952, OM 442.962	505	68
			511	73
			518	82
			518	83
			519	84
15-451190-00	RENAULT	DXI 13 (Euro 4/5)	680	69
	VOLVO	D13A360 (Euro 5), D13A400 (Euro 5), D13A440 (Euro 5), D13A480 (Euro 5), D13A520 (Euro 5) D13C380 (Euro 5), D13C420 (Euro 5), D13C460 (Euro 5), D13C500 (Euro 5), D13C540 (Euro 5)	839	51
			839	52
15-451270-00	RENAULT	DXI 12 (Euro 3)	679	68
	VOLVO	D12C340 (Euro 2), D12C380, D12D340 (Euro 3), DH12D340 (Euro 3) D12C420, D12C460, D12D380 (Euro 3), D12D420 (Euro 3), D12D460 (Euro 3), D12D500 (Euro 3) D12F390 (Euro 4), D12F430 (Euro 4) DH12D380 (Euro 3) DH12D420 (Euro 3) DH12E340, DH12E380 (Euro 4), DH12E420 (Euro 4/5), DH12E460 (Euro 4)	836	48
			837	49
			838	50
			840	54
			841	55
			841	56
15-452030-00	MERCEDES-BENZ	OM 421.905, OM 421.906, OM 421.907, OM 421.908, OM 421.909, OM 421.910, OM 422.905, OM 422.906, OM 422.907, OM 422.908, OM 422.909, OM 422.910, OM 422.911, OM 422.912, OM 422.913, OM 422.914, OM 422.915, OM 422.916, OM 422.917, OM 422.918, OM 422.919, OM 422.920, OM 422.921, OM 422.922, OM 422.923, OM 423.905, OM 423.906, OM 423.907, OM 423.908, OM 423.909, OM 424.900 OM 421.951, OM 422.901, OM 422.951, OM 422.952, OM 422.953, OM 422.954, OM 422.955, OM 422.956, OM 422.957, OM 422.958, OM 422.959, OM 422.963, OM 423.950, OM 424.901, OM 424.901.510	505	68
			506	69

NEW PARTS LIST





Numerische Teilenummernliste • Liste des références produits
Lista de nuevas referencias





				9		
15-452030-00	MERCEDES-BENZ	OM 441.950, OM 441.951, OM 441.953, OM 441.960, OM 441.961, OM 441.962, OM 441.981, OM 441.982, OM 441.983, OM 441.985, OM 442.901, OM 442.940, OM 442.941, OM 442.942, OM 442.943, OM 442.944, OM 442.945, OM 442.946, OM 442.951, OM 442.953, OM 442.954, OM 442.955, OM 442.957, OM 442.958, OM 442.959, OM 442.960, OM 442.961, OM 442.963, OM 442.964, OM 442.965, OM 442.966, OM 442.967, OM 442.968, OM 442.970, OM 442.971, OM 442.972, OM 442.976, OM 442.980, OM 442.982, OM 442.983, OM 442.985, OM 442.989, OM 442.991, OM 442.992, OM 442.993, OM 442.994, OM 443.901, OM 443.940, OM 443.980, OM 444.901	507	70		
		OM 423.901, OM 440.948 (OM442 A), OM 440.949 (OM442 A), OM 440.974 (OM442 LA), OM 441.952, OM 442 A, OM 444 LA, OM 481.902, OM 481.904, OM 482.912, OM 482.930, OM 482.940, OM 482.941	509	71		
		OM 440.970 (Euro 1 OM442 LA), OM 440.971 (Euro 1 OM442 LA), OM 440.972 (Euro 1 OM442 LA), OM 440.973 (Euro 1 OM442 LA), OM 440.975 (Euro 1 OM442 LA), OM 440.976 (Euro 1 OM442 LA), OM 440.978 (Euro 1 OM442 LA), OM 440.979 (Euro 1 OM442 LA), OM 440.980 (Euro 1 OM442 LA), OM 440.981 (Euro 1 OM442 LA), OM 440.982 (Euro 1 OM442 LA), OM 440.983 (Euro 1 OM442 LA), OM 440.984 (Euro 1 OM442 LA), OM 440.985 (Euro 1 OM442 LA), OM 440.986 (Euro 1 OM442 LA), OM 440.987 (Euro 1 OM442 LA), OM 440.988 (Euro 1 OM442 LA), OM 440.989 (Euro 1 OM442 LA), OM 440.990 (Euro 1 OM442 LA), OM 440.991 (Euro 1 OM442 LA), OM 441.980, OM 441.986 (Euro 1), OM 441.987 (Euro 1), OM 441.988 (Euro 1), OM 441.989 (Euro 1), OM 441.990 (Euro 1), OM 441.991 (Euro 1), OM 441.992 (Euro 1), OM 441.993 (Euro 1), OM 441.994 (Euro 1), OM 441.995 (Euro 1), OM 441.996 (Euro 1), OM 441.997 (Euro 1), OM 441.998 (Euro 1), OM 441.999 (Euro 1), OM 442.995 (Euro 1), OM 442.996 (Euro 1), OM 442.997 (Euro 1), OM 442.998 (Euro 1), OM 442.999 (Euro 1)	510	72		
		OM 445.920 (Euro 2 OM441 LA), OM 445.921 (Euro 2 OM441 LA), OM 445.922 (Euro 2 OM441 LA), OM 445.923 (Euro 2 OM441 LA), OM 445.924 (Euro 2 OM441 LA), OM 445.925 (Euro 2 OM441 LA), OM 445.926 (Euro 2 OM441 LA), OM 445.927 (Euro 2 OM441 LA), OM 445.929 (Euro 2 OM441 LA), OM 445.930 (Euro 2 OM441 LA), OM 445.931 (Euro 2 OM441 LA), OM 445.933 (Euro 2 OM441 LA), OM 445.934 (Euro 2 OM441 LA), OM 445.935 (Euro 2 OM441 LA), OM 445.936 (Euro 2 OM441 LA), OM 445.937 (Euro 2 OM441 LA), OM 445.938 (Euro 2 OM441 LA), OM 445.939 (Euro 2 OM441 LA), OM 445.940 (Euro 2 OM441 LA), OM 445.941 (Euro 2 OM441 LA), OM 446.920 (Euro 2 OM442 LA), OM 446.922 (Euro 2 OM442 LA), OM 446.923 (OM442 LA), OM 446.924 (Euro 2 OM442 LA), OM 446.925 (Euro 2 OM442 LA), OM 446.926 (Euro 2 OM442 LA), OM 446.927 (Euro 2 OM442 LA), OM 446.928 (Euro 2 OM442 LA), OM 446.929 (Euro 2 OM442 LA), OM 446.930 (Euro 2 OM442 LA), OM 446.931 (Euro 2 OM442 LA), OM 446.932 (Euro 2 OM442 LA), OM 446.933 (Euro 2 OM442 LA), OM 446.934 (Euro 2 OM442 LA), OM 446.935 (Euro 2 OM442 LA), OM 446.936 (Euro 2 OM442 LA), OM 446.938 (Euro 2 OM442 LA), OM 446.939 (Euro 2 OM442 LA), OM 446.940 (Euro 2 OM442 LA), OM 446.941 (Euro 2 OM442 LA), OM 446.942 (Euro 2 OM442 LA), OM 446.943 (Euro 2 OM442 LA), OM 446.945 (Euro 2 OM442 LA), OM 446.946 (Euro 2 OM442 LA), OM 446.948 (Euro 2 OM442 LA)	511	73		
		OM 440.940 (OM442 A), OM 440.941 (OM442 A), OM 440.942 (OM442 A), OM 440.943 (OM442 A)	518	82		
		OM 440.945 (Euro 1 OM442 A), OM 442 A (Euro 1), OM 442.977, OM 442.978	518	83		
		OM 442.950, OM 442.952, OM 442.962	519	84		
		15-452920-00	MAN	D 2865 LF260, D 2865 LFR, D 2865 LFR01, D 2866 KF, D 2866 KFZ, D 2866 KOH360, D 2866 KUJ/360 (Euro 1), D 2866 KUL, D 2866 LF, D 2866 LF290, D 2866 LF290, D 2866 LF04, D 2866 LF07, D 2866 LFO8, D 2866 LFZ/290, D 2866 LFZ/330, D 2866 LH01, D 2866 LU, D 2866 LU07, D 2866 LU08, D 2866 LU330, D 2866 LUH, D 2866 LUH04 (Euro 1), D 2866 LUH330, D 2866 LUL330, D 2866 LXE40, D 2866 LXE47, D 2866 T, D 2866 TOH, D 2866 TOH/290, D 2866 TOH/310, D 2866 TUH, D 2866 TUH/290, D 2866 TUH01	400	31
		D 2865 LF02, D 2865 LF03, D 2865 LFO5 (Euro 1), D 2865 LF06 (Euro 1), D 2865 LF10, D 2865 LF22 (Euro 1), D 2865 LF23 (Euro 1), D 2865 LOH01 (Euro 1), D 2865 LOH02 (Euro 1), D 2865 LOH05 (Euro 1), D 2865 LU01 (Euro 1), D 2865 LU02, D 2865 LU03, D 2865 LU04 (Euro 1), D 2865 LU06 (Euro 1), D 2865 LUH02 (Euro 1), D 2865 LUH03 (Euro 1), D 2865 LUH05 (Euro 1), D 2865 LUH06 (Euro 1), D 2865 LUH08 (Euro 1), D 2865 LXF, D 2865 LXF, D 2865 LXF, D 2866 LFO2, D 2866 LFO3, D 2866 LFO6, D 2866 LFO9 (Euro 1), D 2866 LF10 (Euro 1), D 2866 LF15 (Euro 1), D 2866 LF21 (Euro 1), D 2866 LF22 (Euro 1), D 2866 LFG, D 2866 LFG03 (Euro 1), D 2866 LFG04 (Euro 1), D 2866 LOH, D 2866 LOH02, D 2866 LOH03, D 2866 LOH06 (Euro 1), D 2866 LOH07, D 2866 LOH09 (Euro 1), D 2866 LOH20 (Euro 1), D 2866 LOH21 (Euro 1), D 2866 LOH22 (Euro 1), D 2866 LOH24 (Euro 1), D 2866 LU01, D 2866 LU03 (Euro 1), D 2866 LU04, D 2866 LUH05 (Euro 1), D 2866 LX, D 2866 LXF, D 2866 LXFG, D 2866 LXOH, D 2866 LXU, D 2866 LXUH	401	32		
		D 2865 LFO9, D 2865 LF21 (Euro 2), D 2865 LF24 (Euro 2), D 2865 LUH07 (Euro 2), D 2865 LUH09 (Euro 2), D 2866 LF14 (Euro 2), D 2866 LF16 (Euro 2), D 2866 LF17 (Euro 2), D 2866 LF20 (Euro 2), D 2866 LF29 (Euro 2), D 2866 LF30 (Euro 2), D 2866 LF34 (Euro 2), D 2866 LF35 (Euro 2), D 2866 LF36 (Euro 2), D 2866 LF37 (Euro 2), D 2866 LOH23 (Euro 2), D 2866 LOH25 (Euro 2), D 2866 LOH26 (Euro 2), D 2866 LUH21 (Euro 2), D 2866 LUH22 (Euro 2), D 2866 LUH26 (Euro 2)	402	33		
D 2865 LOH07 (Euro 2), D 2865 LOH09 (Euro 2), D 2866 F/240, D 2866 FG, D 2866 FR, D 2866 KOH/373, D 2866 LFO1, D 2866 LFG05 (Euro 2), D 2866 LOH31 (Euro 2), D 2866 OH, D 2866 U, D 2866 UH, D 2866 UH/240, D 2866 UM, D 2876 LFO1 (Euro 2), D 2876 LFO5 (Euro 3), D 2876 LF11 (Euro 2), D 2876 LUE604, D 2876 LUE605, D 2876 LUE606	403	34				
D 2866 LFO5 (Euro 1)	404	35				

				9		
15-452920-00	MAN	D 2866 LF23 (Euro 3), D 2866 LF24 (Euro 3), D 2866 LF25 (Euro 3), D 2866 LF26 (Euro 3), D 2866 LF27 (Euro 3), D 2866 LF28 (Euro 3), D 2866 LF607 (Euro 3), D 2866 LOH27 (Euro 3), D 2866 LOH28 (Euro 3), D 2866 LOH29 (Euro 3), D 2866 LOH32 (Euro 3), D 2866 LOH33 (Euro 3), D 2866 LOH34 (Euro 3), D 2866 LOH35 (Euro 3), D 2866 LUH23 (Euro 3), D 2866 LUH24 (Euro 3), D 2866 LUH25 (Euro 3), D 2866 LUH27 (Euro 3), D 2866 LUH28 (Euro 3), D 2866 LUH29 (Euro 3), D 2866 LUH30 (Euro 3), D 2866 LUH51 (Euro 3)	405	36		
		D 2866 LF31 (Euro 2), D 2866 LF32 (Euro 2), D 2866 LF39 (Euro 2), D 2866 LF40 (Euro 2), D 2866 LF41 (Euro 2), D 2866 LF42 (Euro 2), D 2866 LF43 (Euro 2)	406	37		
		D 2876 LF02 (Euro 2), D 2876 LOH01 (Euro 2), D 2876 LUH01 (Euro 2), D 2876 LUH02 (Euro 2)	407	38		
		D 2876 LF03 (Euro 3), D 2876 LF04 (Euro 3), D 2876 LF06 (Euro 2), D 2876 LF07 (Euro 2), D 2876 LF10 (Euro 2), D 2876 LF17, D 2876 LOH02 (Euro 3), D 2876 LOH03 (Euro 3)	407	39		
		D 2865 LF260, D 2865 LFR, D 2865 LFRD1, D 2866 KF, D 2866 KFZ, D 2866 KOH360, D 2866 KUH/360 (Euro 1), D 2866 KUL, D 2866 LF, D 2866 LF/290, D 2866 LF04, D 2866 LF07, D 2866 LF08, D 2866 LFZ/290, D 2866 LFZ/330, D 2866 LH01, D 2866 LU, D 2866 LU07, D 2866 LU08, D 2866 LU330, D 2866 LUH, D 2866 LUH04 (Euro 1), D 2866 LUH330, D 2866 LUL330, D 2866 LXE40, D 2866 LXE47, D 2866 T, D 2866 TOH, D 2866 TOH/290, D 2866 TOH/310, D 2866 TUH, D 2866 TUH/290, D 2866 TUH01	400	31		
15-452930-00	MAN	D 2865 LF02, D 2865 LF03, D 2865 LF05 (Euro 1), D 2865 LF06 (Euro 1), D 2865 LF10, D 2865 LF22 (Euro 1), D 2865 LF23 (Euro 1), D 2865 LOH01 (Euro 1), D 2865 LOH02 (Euro 1), D 2865 LOH05 (Euro 1), D 2865 LU01 (Euro 1), D 2865 LU02, D 2865 LU03, D 2865 LU04 (Euro 1), D 2865 LU06 (Euro 1), D 2865 LUH02 (Euro 1), D 2865 LUH03 (Euro 1), D 2865 LUH05 (Euro 1), D 2865 LUH06 (Euro 1), D 2865 LUH08 (Euro 1), D 2865 LXF, D 2865 LXFR, D 2866 LF02, D 2866 LF03, D 2866 LF06, D 2866 LF09 (Euro 1), D 2866 LF10 (Euro 1), D 2866 LF15 (Euro 1), D 2866 LF21 (Euro 1), D 2866 LF22 (Euro 1), D 2866 LFG, D 2866 LFG03 (Euro 1), D 2866 LFG04 (Euro 1), D 2866 LOH, D 2866 LOH02, D 2866 LOH03, D 2866 LOH06 (Euro 1), D 2866 LOH07, D 2866 LOH09 (Euro 1), D 2866 LOH20 (Euro 1), D 2866 LOH21 (Euro 1), D 2866 LOH22 (Euro 1), D 2866 LOH24 (Euro 1), D 2866 LU01, D 2866 LU03 (Euro 1), D 2866 LU04, D 2866 LUH05 (Euro 1), D 2866 LX, D 2866 LXF, D 2866 LXFG, D 2866 LXOH, D 2866 LXU, D 2866 LXUH	401	32		
		D 2865 LF09, D 2865 LF21 (Euro 2), D 2865 LF24 (Euro 2), D 2865 LUH07 (Euro 2), D 2865 LUH09 (Euro 2), D 2866 LF14 (Euro 2), D 2866 LF16 (Euro 2), D 2866 LF17 (Euro 2), D 2866 LF20 (Euro 2), D 2866 LF29 (Euro 2), D 2866 LF30 (Euro 2), D 2866 LF34 (Euro 2), D 2866 LF35 (Euro 2), D 2866 LF36 (Euro 2), D 2866 LF37 (Euro 2), D 2866 LOH23 (Euro 2), D 2866 LOH25 (Euro 2), D 2866 LOH26 (Euro 2), D 2866 LUH21 (Euro 2), D 2866 LUH22 (Euro 2), D 2866 LUH26 (Euro 2)	402	33		
		D 2865 LOH07 (Euro 2), D 2865 LOH09 (Euro 2), D 2866 F/240, D 2866 FG, D 2866 FR, D 2866 KOH/373, D 2866 LF01, D 2866 LF605 (Euro 2), D 2866 LOH31 (Euro 2), D 2866 OH, D 2866 U, D 2866 UH, D 2866 UH/240, D 2866 UM, D 2876 LF01 (Euro 2), D 2876 LF05 (Euro 3), D 2876 LF11 (Euro 2), D 2876 LUE604, D 2876 LUE605, D 2876 LUE606, D 2866 LF05 (Euro 1)	403	34		
		D 2866 LF23 (Euro 3), D 2866 LF24 (Euro 3), D 2866 LF25 (Euro 3), D 2866 LF26 (Euro 3), D 2866 LF27 (Euro 3), D 2866 LF28 (Euro 3), D 2866 LF607 (Euro 3), D 2866 LOH27 (Euro 3), D 2866 LOH28 (Euro 3), D 2866 LOH29 (Euro 3), D 2866 LOH32 (Euro 3), D 2866 LOH33 (Euro 3), D 2866 LOH34 (Euro 3), D 2866 LOH35 (Euro 3), D 2866 LUH23 (Euro 3), D 2866 LUH24 (Euro 3), D 2866 LUH25 (Euro 3), D 2866 LUH27 (Euro 3), D 2866 LUH28 (Euro 3), D 2866 LUH29 (Euro 3), D 2866 LUH30 (Euro 3), D 2866 LUH51 (Euro 3)	404	35		
		D 2866 LF31 (Euro 2), D 2866 LF32 (Euro 2), D 2866 LF39 (Euro 2), D 2866 LF40 (Euro 2), D 2866 LF41 (Euro 2), D 2866 LF42 (Euro 2), D 2866 LF43 (Euro 2)	405	36		
		D 2876 LF02 (Euro 2), D 2876 LOH01 (Euro 2), D 2876 LUH01 (Euro 2), D 2876 LUH02 (Euro 2)	407	38		
		D 2876 LF03 (Euro 3), D 2876 LF04 (Euro 3), D 2876 LF06 (Euro 2), D 2876 LF07 (Euro 2), D 2876 LF10 (Euro 2), D 2876 LF17, D 2876 LOH02 (Euro 3), D 2876 LOH03 (Euro 3)	407	39		
		15-456330-00	MERCEDES-BENZ	OM 440.907 (Euro 1 OM442), OM 440.908 (Euro 1 OM442), OM 440.910 (Euro 1 OM442), OM 440.911 (Euro 1 OM442), OM 441, OM 441 (Euro 1), OM 441.922 (Euro 1), OM 441.933 (Euro 1), OM 442, OM 442 (Euro 1), OM 442.931, OM 443.900	519	85
				OM 440.909 (OM442), OM 441.905, OM 441.906, OM 441.907, OM 441.908, OM 441.909, OM 441.911, OM 441.912, OM 441.913, OM 441.914, OM 441.915, OM 441.916, OM 441.917, OM 441.918, OM 441.919, OM 441.920, OM 441.923, OM 441.924, OM 441.925, OM 441.926, OM 441.927, OM 441.932, OM 442.905, OM 442.906, OM 442.907, OM 442.908, OM 442.909, OM 442.910, OM 442.911, OM 442.914, OM 442.915, OM 442.916, OM 442.917, OM 442.918, OM 442.919, OM 442.920, OM 442.921, OM 442.922, OM 442.923, OM 442.924, OM 442.925, OM 442.926, OM 442.927, OM 442.928, OM 442.929, OM 442.930, OM 442.932, OM 442.933, OM 442.934, OM 442.935, OM 442.939, OM 443.905, OM 444	520	86

NEW PARTS LIST





Nummerische Teilenummernliste • Liste des références produits
Lista de nuevas referencias

				9
15-456980-00	MERCEDES-BENZ	M 476.921 (M 447 G), M 476.925 (M 447 HG), M 476.926 (M 447 HG), M 476.927 (M 447 HG), M 476.930 (Euro 2 M447 hLAG), OM 427 A, OM 427 LA, OM 427.905, OM 427.910, OM 427.911, OM 427.950, OM 427.951, OM 427.952, OM 429.951, OM 429.952, OM 429.953, OM 429.955, OM 447, OM 447 A/LA, OM 447 LA, OM 447.900, OM 447.905, OM 447.906, OM 447.907, OM 447.908, OM 447.910, OM 447.911, OM 447.912, OM 447.913 (Euro 1), OM 447.914 (Euro 1), OM 447.915, OM 447.916, OM 447.947 (Euro 1), OM 447.948 (Euro 2), OM 447.949 (Euro 2), OM 447.950, OM 447.951, OM 447.952 (Euro 1), OM 447.953 (Euro 1), OM 447.960 (Euro 1), OM 475.950 (OM449 A), OM 475.951 (OM449 A), OM 475.952 (OM449 A), OM 475.953 (OM449 A), OM 475.954 (OM449 A), OM 475.974 (OM449 LA), OM 475.976 (OM449 LA), OM 475.977 (OM449 LA), OM 475.978 (OM449 LA), OM 475.979 (OM449 LA), OM 475.982 (OM449 LA), OM 475.984 (OM449 LA), OM 475.985 (OM449 LA), OM 475.986 (OM449 LA), OM 475.989 (OM449 LA), OM 475.991 (OM449 LA), OM 475.994 (OM449 LA), OM 475.997 (OM449 LA), OM 475.998 (OM449 LA), OM 476.916 (OM447 A), OM 476.917 (OM447 LA), OM 476.950 (OM447 A), OM 476.971 (Euro 2 OM447 LA), OM 476.972 (Euro 2 OM447 LA), OM 476.973 (Euro 2 OM447 LA), OM 476.977 (Euro 2 OM447 LA), OM 476.978 (Euro 2 OM447 LA), OM 476.979 (Euro 2 OM447 LA), OM 476.980 (Euro 2 OM447 LA), OM 476.981 (OM447 LA), OM 476.982 (OM447 LA), OM 476.983 (Euro 2 OM447 LA), OM 476.985 (Euro 1 OM447 LA), OM 476.988 (OM447 LA), OM 476.991 (OM447 LA), OM 476.992 (OM447 LA), OM 485.980, OM 489.960 (Euro 1), OM 489.961 (Euro 1)	502	65
		OM 447.954 (Euro 1), OM 447.955 (Euro 1), OM 447.956 (Euro 1), OM 447.957 (Euro 1), OM 447.958 (Euro 1), OM 447.959 (Euro 1), OM 447.980 (Euro 1), OM 447.981 (Euro 1), OM 447.982 (Euro 1), OM 447.983 (Euro 1), OM 447.984 (Euro 1), OM 447.985 (Euro 1), OM 447.986 (Euro 1), OM 447.987 (Euro 1), OM 447.995 (Euro 1)	512	74
		OM 447.970 (Euro 2), OM 447.971 (Euro 2), OM 447.972 (Euro 2), OM 447.973 (Euro 2), OM 447.974 (Euro 2), OM 447.975 (Euro 1), OM 447.976 (Euro 2), OM 447.977 (Euro 2), OM 447.978, OM 447.979 (Euro 2), OM 447.988 (Euro 2), OM 447.990 (Euro 2), OM 447.991 (Euro 2), OM 447.992 (Euro 2), OM 447.993 (Euro 2), OM 447.994 (Euro 2), OM 447.996 (Euro 2), OM 447.998 (Euro 2), OM 447.999 (Euro 2)	513	75
15-458110-00	MERCEDES-BENZ	OM 401.905, OM 401.906, OM 401.907, OM 401.908, OM 401.909, OM 401.912, OM 401.913, OM 401.914, OM 401.915, OM 401.916, OM 401.917, OM 401.918, OM 401.919, OM 401.921, OM 401.922, OM 401.923, OM 401.925, OM 401.926, OM 401.927, OM 401.928, OM 402.905, OM 402.906, OM 402.907, OM 402.910, OM 402.912, OM 402.913, OM 402.914, OM 402.916, OM 402.917, OM 402.919, OM 402.921, OM 402.923, OM 402.924, OM 402.925, OM 402.926, OM 402.927, OM 402.928, OM 403.915, OM 403.916, OM 403.917, OM 403.918, OM 403.919, OM 403.930, OM 403.931, OM 403.932, OM 403.934, OM 404	498	60
		OM 401.970, OM 401.972, OM 401.973, OM 401.984, OM 401.985, OM 401.986, OM 401.987, OM 401.989, OM 401.990, OM 401.991, OM 401.992, OM 401.993, OM 401.994, OM 402.984 (Euro 1)	499	61
		OM 401.974 (Euro 1), OM 401.975 (Euro 1), OM 401.977 (Euro 1), OM 401.978 (Euro 1), OM 401.979 (Euro 1), OM 401.980 (Euro 1), OM 401.981 (Euro 1), OM 401.982 (Euro 1), OM 402.970 (Euro 1), OM 402.971 (Euro 1), OM 402.972 (Euro 1), OM 402.973 (Euro 1), OM 402.974 (Euro 1), OM 402.975 (Euro 1), OM 402.977 (Euro 1), OM 402.978 (Euro 1), OM 402.982 (Euro 1), OM 402.983 (Euro 1), OM 402.985 (Euro 1), OM 402.986 (Euro 1), OM 402.987 (Euro 1), OM 402.989 (Euro 1), OM 402.990 (Euro 1), OM 402.996 (Euro 1)	500	62
		OM 401.983, OM 402.995, OM 403.910, OM 403.933, OM 403.935, OM 404 A	501	63
15-458180-00	VOLVO	TAMD120A, TAMD120B, TAMD121, TD120A, TD120C, TD120D, TD120E, TD120F, TD120FA, TD120FB, TD120FC, TD120FTQ, TD120G, TD120GA, TD120GG, TD121F, TD121FD, TD121FK, TD121G, TD121GD, TD122ED, TD122FAQ, TD122FBQ, TD122FCQ, TD122FH (Euro 1), TD122FL, TD122KBE, TID120F, TMD120A	832	40
		TD121FH	833	41
		TD122, TD122F, TD122FA, TD122FK, TD122FR, TD122FS, TD122KE	833	42
15-458190-00	SCANIA	D 11 R 23 (D 11), DN 11.01 (DN 11), DN 11.01 B10 (DN 11), DN 11.01 C 09 (DN 11), DN 11.04 B10 (DN 11), DN 11.04 C 01 (DN 11), DN 11.06 (DN 11), DN 11.07 (DN 11), DN 11.08 (DN 11), DN 11.08 B01 (DN 11), DS 11 / D11 (D 11), DS 11.01 (DS 11), DS 11.01 B 06 (DS 11), DS 11.02 (DS 11), DS 11.14 (DS 11), DS 11.15 (DS 11), DS 11.15 B (DS 11), DS 11.18 (DS 11), DS 11.34 (DS 11), DS 11.71 (DS 11), DS 11.71 C (DS 11), DS 11.72 (DS 11), DS 11.73 (DS 11), DS 11.74 (DS 11), DSC 11.01 (DSC 11), DSC 11.02 (DSC 11), DSC 11.04 (DSC 11), DSC 11.12 (DSC 11), DSC 11.13 (DSC 11), DSC 11.16 (DSC 11), DSC 11.17 (DSC 11), DSC 11.18 (DSC 11), DSI 11.01 (DSI 11)	701	8
		DS 11 AGR/IND 1978>	705	14
		DSC 11.08 (DSC 11), DSC 11.10 (DSC 11), DSC 11.70 N (Euro 2), DSC 11.70 S (Euro 2)	706	16

				9
15-458580-00	MERCEDES-BENZ	OM 521.940 (Euro 2 OM501 LA), OM 521.950 (Euro 2 OM501 LA), OM 521.951 (Euro 2 OM501 LA), OM 522.940 (Euro 2 OM502 LA), OM 522.941 (Euro 2 OM502 LA), OM 522.942 (Euro 2 OM502 LA), OM 522.943 (Euro 2 OM502 LA), OM 522.950 (Euro 2 OM502 LA), OM 541.920 (Euro 2 OM501 LA), OM 541.921 (Euro 2 OM501 LA), OM 541.922 (Euro 2 OM501 LA), OM 541.923 (Euro 2 OM501 LA), OM 541.924 (Euro 2 OM501 LA), OM 541.925 (Euro 2 OM501 LA), OM 541.926 (Euro 2 OM501 LA), OM 541.927 (Euro 2 OM501 LA), OM 541.928 (Euro 2 OM501 LA), OM 541.940 (Euro 2/3 OM501 LA), OM 541.941 (Euro 2/3 OM501 LA), OM 541.951 (Euro 2/3 OM501 LA), OM 541.952 (Euro 2/3 OM501 LA), OM 541.960 (Euro 2 OM501 LA), OM 542.920 (OM502 LA), OM 542.921 (OM502 LA), OM 542.922 (OM502 LA), OM 542.923 (OM502 LA), OM 542.924 (OM502 LA), OM 542.925 (Euro 2 OM502 LA), OM 542.926 (OM502 LA), OM 542.947 (OM502 LA), OM 542.958 (Euro 3 OM502 LA), OM 941.910 (Euro 2 OM501 LA), OM 941.920 (Euro 2 OM501 LA), OM 941.921 (Euro 2 OM501 LA), OM 941.929 (Euro 2 OM501 LA), OM 941.930 (Euro 2 OM501 LA), OM 941.940 (Euro 2 OM501 LA), OM 941.960 (Euro 2 OM501 LA), OM 941.970 (Euro 2 OM501 LA), OM 941.980 (Euro 2 OM501 LA), OM 941.981 (Euro 2 OM501 LA), OM 941.990 (Euro 2 OM501 LA), OM 942.900 (Euro 2 OM502 LA), OM 942.910 (Euro 2 OM502 LA), OM 942.911 (Euro 2 OM502 LA), OM 942.912 (Euro 2 OM502 LA), OM 942.925 (Euro 2 OM502 LA), OM 942.930 (Euro 2 OM502 LA), OM 942.960 (Euro 2 OM502 LA), OM 942.967 (Euro 2 OM502 LA), OM 942.970 (Euro 2 OM502 LA), OM 942.980 (Euro 2 OM502 LA), OM 942.990 (Euro 2 OM502 LA)	521	87
		OM 541.942 (Euro 3 OM501 LA), OM 541.943 (Euro 3 OM501 LA), OM 541.944 (Euro 3 OM501 LA), OM 541.945 (Euro 3 OM501 LA), OM 541.946 (Euro 3 OM501 LA), OM 541.947 (Euro 3 OM501 LA), OM 541.948 (Euro 3 OM501 LA), OM 541.949 (Euro 3 OM501 LA), OM 541.950 (Euro 3 OM501 LA), OM 541.995 (OM501 LA), OM 542.940 (Euro 3 OM502 LA), OM 542.941 (Euro 3 OM502 LA), OM 542.942 (Euro 3 OM502 LA), OM 542.943 (Euro 3 OM502 LA), OM 542.944 (Euro 3 OM502 LA), OM 542.945 (Euro 3 OM502 LA), OM 542.948 (Euro 3 OM502 LA), OM 542.956 (Euro 3 OM502 LA), OM 522 LA (Euro 2)	523	88
		OM 522 LA (Euro 2)	526	91
15-459040-00	VOLVO	D10A320, D10A360, D10B320 (Euro 2), D10B360 (Euro 2), DH10A (Euro 2), DH10A245 (Euro 2), DH10A285 (Euro 2), DH10A360 (Euro 2), TD102FAQ, TD102FCQ, TD102FEQ, TD102F6Q, TD102FL (Euro 1), TD102FM, TD102FQ, TD102FS, TD102FT, THD102KD	824	28
		TD102F, TD102FD (Euro 1), TD102FDQ, TD102FF, TD102FH	828	33
		TD102FBQ	829	34
		TD103D10 (Euro 2)	829	35
		TD103E (Euro 1), TD103EA (Euro 1), TD103ES (Euro 1), TD103KBE (Euro 1), TD103KF (Euro 1), THD103KB, THD103KD	829	36
15-480230-00	VOLVO	D9A260 (Euro 3), D9A300 (Euro 3), D9A340 (Euro 3), D9A380 (Euro 3)	822	25
15-480440-00	RENAULT	DXI 11 (Euro 3/4)	677	64
	VOLVO	D11A430 (Euro 3), D11B430 (Euro 4/5), D11C330 (Euro 5), D11C370 (Euro 5), D11C410 (Euro 5)	831	39
15-570030-00	SCANIA	DC 12.15 (DC 12), DC 12.18 (Euro 5 DC 12), DC 12.22 (Euro 5 DC 12), DC 12.23 (Euro 4 DC 12), DC 12.24 (Euro 4 DC 12), DC 12.26 (Euro 4 DC 12), DC 16.09 (Euro 5 DC 16), DT 12.06 (Euro 4 DT 12), DT 12.10 (Euro 4 DT 12)	704	13
15-570090-00	SCANIA	DC 13.05 (Euro 5 DC 13), DC 13.06 (Euro 5 DC 13), DC 13.07 (Euro 5 DC 13), DC 13.10 (Euro 5 DC 13)	709	23
15-610060-00	MERCEDES-BENZ	OM 471.900 (Euro 6), OM 471.902 (Euro 6), OM 471.906 (Euro 6), OM 471.909 (Euro 6), OM 471.915 (Euro 6), OM 471.919 (Euro 6), OM 471.922 (Euro 6), OM 471.926 (Euro 6), OM 471.937 (Euro 6), OM 471.944 (Euro 6), OM 471.946 (Euro 6)	526	92
15-634910-00	CITROËN	159B, 171C, B6E, D2E, XU51C (B1E), XU52C, XU5CP (BAY/BAZ), XU5J (180A/B6D), XU5J/J2/JA, XU5JA (B6D), XU5M (BDY/B8A), XU5M (BDZ), XU7JB (LFX), XU7JP (LFW/LFZ), XU7JP4 (LFY), XU92C (D2A), XU92C (D2C), XU92C (D2F), XU9J1 (DFZ), XU9J2 (D6A), XU9J4 (D6C/DFW), XU9J4 (DFW), XU9JA (D6E), XU9JA (DKZ), XU9M (DDZ), XU9S (159A)	105	30
		XU5 (171A), XU5 (B1AA), XU5J (180Z), XU5JP (BFZ), XU5S (171B), XU5S (171D)	106	31
	FIAT	LFW (XU7 JP) (Euro 2)	181	44
	PEUGEOT	XU51C (B1A), XU5JP (BFZ), XU5S (171)	621	31
		XU51C (B1D), XU51C (B1E), XU52C/K (B2A), XU5CP (BAZ), XU5J (180), XU5J (180A), XU5J (B6B), XU5M (BDZ), XU5M2Z (BDY), XU5M3Z (BDY), XU7JB (LFX), XU7JP (LFW), XU7JP (LFZ), XU7JP4 (LFY), XU92C, XU92C (D2A), XU92C (D2C), XU9J1 (DFZ), XU9J2 (D6A), XU9J4 (D6C/DFW), XU9J4 (DFW), XU9JA (D6B), XU9JAZ (DKZ), XU9M (DDZ), XU9S (D2B)	621	32
15-636600-00	CITROËN	K1B, K1G, KAZ, TU3 (K3A), TU3A (K1H), TU3A (K6D), TU3A (K6E), TU3A (K6F), TU3A (KFT) (Euro 5), TU3A (KFV) (Euro 5), TU3A (KFW), TU3A (KFX), TU3CP (KAY), TU3F2 (K1F), TU3F2 (K2B), TU3FJ2 (K2D), TU3FJ2 (KFY), TU3FJ2/Z (KFZ), TU3FM (K2A), TU3FM (KDY), TU3M (KDX), TU3M (KDY), TU3M/Z (K0Z)	96	10
		TU3JP (KFW), TU3JP (KFX), TU3JP-L4 (KFV)	97	11
		XY8 (150B)	97	12
	PEUGEOT	TU3 (K5A), TU32, TU3A (K1D), TU3A (K6D), TU3A (K6E), TU3A (K6F), TU3A (KFT), TU3A (KFV), TU3A (KFW), TU3CP (KAY), TU3FJ2/Z (KFZ), TU3M (KDY), TU3M (K0Z), TU3MC (KDX), TU3S (K2B)	611	10
		TU3JP (KFW), TU3JP (KFX)	612	11
		TU3JP-L4	613	12
		XY8 (150B)	613	13
	TALBOT	XY8	772	2
15-670050-00	MAN	D 2876 LF12 (Euro 3), D 2876 LF13 (Euro 3), D 2876 LF25 (Euro 2), D 2876 LOH20 (Euro 3), D 2876 LOH21 (Euro 3)	408	40
15-670070-00	SCANIA	DSC 14.13 (Euro 2 DSC 14), DSC 14.15 (Euro 3 DS 14)	709	22
15-673200-00	VOLVO	TD100A, TD100AHC, TD100ARC, THD100B, THD100D, THD101B, TMD100A	824	29
		TD100B, TD100BG	825	30

NEW PARTS LIST

Nummerische Teilenummernliste • Liste des références produits
Lista de nuevas referencias

				
15-673200-00	VOLVO	TD100CHC, TD100F, TD100G, TD100GA, TD100GG, TD101F, TD101FA, TD101FC, TD101FD, TD101G, TD101GA, TD101GB, TD101GE	826	31
		TD100GB, TD101, THD101, THD101KF, TID100	827	32
		THD100DB, THD100DC, THD100DD, THD100E, THD100EA, THD100EB, THD100EC, THD100ED, THD100EE, THD100EK, THD101G, THD101GB, THD101GC, THD101GD, THD101KB, THD101KC, THD101KE	830	37
		15-676420-00	ALFA ROMEO	VM 07 B, VM 08 B, VM 31 B, VM 32 B, VM 4HT 2.4, VM 81 A, VM 82 A, VM 84 A, VM 96 A
CHRYSLER	M00 (HR 425 CL), VM 425HR (M51), VM 425HS (M52)	88	5	
FORD	SCB, SCC	226	53	
JEEP	VM 425HR (M51), VM 425HS (M52)	315	5	
LAND ROVER	11 A (VM492HT)	352	22	
OPEL	25 TDS (VM41B)	593	56	
ROVER	492 4 SHIRG, HR 492 HI, HR 492 HT, VM-HR 492.4	690	18	
VAUXHALL	25TDS (VM41B)	804	56	
VM	HR492HTI, VM 392 HT, VM 492 HR, VM 492 HS, VM 492 HT	807	2	

								9	
88-429600-10	RENAULT	MACK E.TECH A/46 (Euro 2), MACK E.TECH B/46 (Euro 2), MACK E.TECH C/46 (Euro 2)	678	66					
89-123200-10	RENAULT	DXI 12 (Euro 3)	679	68					
	VOLVO	D12C340 (Euro 2), D12C380, D12D340 (Euro 3), DH12D340 (Euro 3)	836	48					
		D12C420, D12C460, D12D380 (Euro 3), D12D420 (Euro 3), D12D460 (Euro 3), D12D500 (Euro 3)	837	49					
		DH12D380 (Euro 3)	840	54					
		DH12D420 (Euro 3)	841	55					
89-123200-30	VOLVO	D12 (Euro 2)	835	44					
89-123200-35	RENAULT	DXI 12 (Euro 3)	679	68					
	VOLVO	D12A340 (Euro 2)	835	45					
		D12C420, D12C460, D12D380 (Euro 3), D12D420 (Euro 3), D12D460 (Euro 3), D12D500 (Euro 3)	837	49					
89-141900-00	VOLVO	D7C215 (Euro 2), D7C250 (Euro 2), D7C275 (Euro 2), D7C290 (Euro 2), D7C310 (Euro 2)	821	22					
89-143600-60	SCANIA	DSC 14.13 (Euro 2 DSC 14), DSC 14.15 (Euro 3 DS 14)	709	22					
89-143600-70	SCANIA	DC 12.15 (DC 12), DC 12.18 (Euro 5 DC 12), DC 12.22 (Euro 5 DC 12), DC 12.23 (Euro 4 DC 12), DC 12.24 (Euro 4 DC 12), DC 12.26 (Euro 4 DC 12), DC 16.09 (Euro 5 DC 16), DT 12.06 (Euro 4 DT 12), DT 12.10 (Euro 4 DT 12)	704	13					
89-346500-10	RENAULT	797-20, 797-21, 797-26	670	49					
89-428000-00	IVECO	F3BE3681A (Euro 4/5 Cursor 13), F3BE3681B (Euro 4/5 Cursor 13), F3BE3681C (Euro 4/5 Cursor 13), F3BE3681D (Euro 4/5 Cursor 13), F3BE3681E (Euro 4/5 Cursor 13), F3BE3681F (Euro 4/5 Cursor 13), F3BE3681G (Euro 4/5 Cursor 13)	301	56					
89-428600-00	MAN	D 2066 LF17 (Euro 5), D 2066 LF18 (Euro 5), D 2066 LF19 (Euro 5), D 2066 LF20 (Euro 5), D 2066 LF21 (Euro 5), D 2066 LF22 (Euro 5), D 2066 LF23 (Euro 5), D 2066 LF24 (Euro 5), D 2066 LF26 (Euro 5), D 2066 LF27 (Euro 5), D 2066 LF28 (Euro 5), D 2066 LF40 (Euro 5), D 2066 LF41 (Euro 5), D 2066 LF42 (Euro 5), D 2066 LF43 (Euro 5), D 2066 LF44 (Euro 5), D 2066 LF45 (Euro 5), D 2066 LF46 (Euro 5), D 2066 LF47 (Euro 5), D 2066 LF51 (Euro 5), D 2066 LF52 (Euro 5), D 2066 LF53 (Euro 5), D 2066 LOH28 (Euro 5), D 2066 LUH32 (Euro 5), D 2066 LUH33 (Euro 5), D 2066 LUH34 (Euro 5)	391	16					
		D 2066 LF25 (Euro 5)	392	17					
89-434100-00	IVECO	F3A3681A (Euro 4/5 Cursor 10), F3A3681B (Euro 4/5 Cursor 10), F3A3681Y (Euro 4/5 Cursor 10), F3AE3681D (Euro 4/5 Cursor 10)	299	51					



CCM

x



9

4.108 (Perkins)	Diesel	1760	4	79.37	8
160 D100	Diesel	1929	4	82.60	18
182 B9.000 (Euro 3)	Diesel	1910	4	82.00	14
192 A5.000 (Euro 3)	Diesel	1910	4	82.00	15
192 B1.000	Diesel	1910	4	82.00	15
198 A5.000	Diesel	1956	4	83.00	23
199 A3.000	Diesel	1248	4	69.60	1
199 B1.000 (Euro 5)	Diesel	1248	4	69.60	2
199 B4.000 (Euro 5)	Diesel	1248	4	69.60	2
330 A1.000	Diesel	1248	4	69.60	3
350 A1.000 (Euro 4/5)	Petrol	1368	4	72.00	4
839 A6.000 (Euro 3)	Diesel	2387	5	82.00	14
841 C.000 (Euro 3)	Diesel	2387	5	82.00	14
841 G.000 (Euro 3)	Diesel	2387	5	82.00	15
841 M.000	Diesel	2387	5	82.00	15
841 N.000	Diesel	2387	5	82.00	15
844 A2.000	Diesel	1956	4	83.00	23
932 A2.000	Petrol	1970	4	83.00	20
937 A1.000	Petrol	1970	4	83.00	20
937 A2.000 (Euro 3)	Diesel	1910	4	82.00	14
937 A4.000 (Euro 3)	Diesel	1910	4	82.00	15
937 A5.000	Diesel	1910	4	82.00	15
937 A6.000	Diesel	1910	4	82.00	16
937 A7.000	Diesel	1910	4	82.00	14
939 A1.000	Diesel	1910	4	82.00	14
939 A2.000	Diesel	1910	4	82.00	15
939 A3.000 (Euro 4)	Diesel	2387	5	82.00	15
939 B3.000	Diesel	1956	4	83.00	23
939 B4.000	Diesel	1956	4	83.00	23
939 B5.000	Diesel	1956	4	83.00	23
940 A3.000	Diesel	1598	4	79.50	9
940 A4.000	Diesel	1956	4	83.00	23
940 A5.000 (Euro 5)	Diesel	1956	4	83.00	23
940 A7.000 (Euro 5)	Diesel	1956	4	83.00	23
940 A8.000 (Euro 5)	Diesel	1956	4	83.00	23
940 C1.000 (Euro 6)	Diesel	1598	4	79.50	9
940 C5.000 (Euro 6)	Diesel	1598	4	79.50	9
955 A4.000	Diesel	1598	4	79.50	9
8140.27R/S.2700 (Sofim)	Diesel	2499	4	93.00	32
8140.21.200 (SOFIM 2.4TD)	Diesel	2445	4	93.00	31
8140.61.200	Diesel	2445	4	93.00	33
8144.21.220 (Sofim)	Diesel	2445	4	93.00	31
8144.61.200	Diesel	2445	4	93.00	33
8144.67.220	Diesel	2500	4	93.00	33
AR 00512 (Twin Cam)	Petrol	1962	4	84.00	24
AR 00526	Petrol	1570	4	78.00	6
AR 00530	Petrol	1290	4	74.00	5
AR 00536	Petrol	1570	4	78.00	6
AR 00548	Petrol	1779	4	80.00	10
AR 01544	Petrol	1962	4	84.00	24
AR 01588	Petrol	1962	4	84.00	25
AR 01600	Petrol	1567	4	78.00	6
AR 01608	Petrol	1779	4	80.00	10
AR 01608 X	Petrol	1779	4	80.00	10
AR 01623	Petrol	1962	4	84.00	24
AR 01655	Petrol	1962	4	84.00	26
AR 01678	Petrol	1779	4	80.00	10
AR 01713	Petrol	1962	4	84.00	24
AR 06100	Petrol	1567	4	78.00	6
AR 06166	Petrol	1962	4	84.00	24

ENGINE INDEX

Motorverzeichnis • Index de moteur • Índice de Motor
 Indeks silnika • Модель Двигателя • دليل المحرك



CCM

x



9

AR 06168	Petrol	1779	4	80.00	10
AR 06202	Petrol	1779	4	80.00	10
AR 06212	Petrol	1962	4	84.00	26
AR 06224	Petrol	1962	4	84.00	25
AR 06416	Petrol	1962	4	84.00	24
AR 06420	Petrol	1962	4	84.00	24
AR 06476	Petrol	1995	4	84.00	27
AR 10512	Petrol	1962	4	84.00	24
AR 11633	Petrol	1962	4	84.00	28
AR 11634	Petrol	1962	4	84.00	28
AR 11671	Petrol	1962	4	84.00	24
AR 16201	Petrol	1970	4	83.00	21
AR 19510	Petrol	1962	4	84.00	24
AR 32103	Petrol	1598	4	82.00	11
AR 32104 (Euro 3)	Petrol	1598	4	82.00	11
AR 32201	Petrol	1747	4	82.00	12
AR 32205	Petrol	1747	4	82.00	12
AR 32301	Petrol	1970	4	83.00	21
AR 32302 (Euro 2)	Diesel	1910	4	82.00	17
AR 32310 (Euro 3/4)	Petrol	1970	4	83.00	22
AR 32501 (Euro 2)	Diesel	2387	5	82.00	17
AR 33601	Diesel	1929	4	82.60	18
AR 34103	Petrol	1970	4	83.00	21
AR 34202 (Euro 2)	Diesel	2387	5	82.00	17
AR 36202 (Euro 3)	Diesel	2387	5	82.00	14
AR 36301	Petrol	1970	4	83.00	22
AR 37101 (Euro 3)	Diesel	1910	4	82.00	14
AR 37203 (Euro 3)	Petrol	1598	4	82.00	13
AR 38401	Petrol	1747	4	82.00	12
AR 61101	Petrol	1567	4	78.00	7
AR 61102	Petrol	1779	4	80.00	10
AR 61201	Petrol	1779	4	80.00	10
AR 64103	Petrol	1995	4	84.00	24
AR 67106	Petrol	1747	4	82.00	12
AR 67201	Petrol	1995	4	84.00	24
AR 67202	Petrol	1995	4	84.00	24
AR 67203	Petrol	1995	4	84.00	29
AR 67204	Petrol	1970	4	83.00	21
AR 67501	Diesel	1929	4	82.60	18
AR 67502	Diesel	1929	4	82.60	19
M 722 BT 24.T (Euro 2)	Diesel	2387	5	82.00	17
VM 4HT 2.4	Diesel	2393	4	92.00	30
VM 07 B	Diesel	2499	4	92.00	30
VM 08 B	Diesel	2499	4	92.00	30
VM 31 B	Diesel	2499	4	92.00	30
VM 32 B	Diesel	2499	4	92.00	30
VM 81 A	Diesel	2393	4	92.00	30
VM 82 A	Diesel	1779	3	92.00	30
VM 84 A	Diesel	2499	4	92.00	30
VM 96 A	Diesel	1779	3	92.00	30



69.60

1

199 A3.000	4cyl.	1248cc	66kW (90PS)	Diesel	Turbo Intercooled	TD23450
MITO 1.3 MultiJet		08/08→08/10				

87-425600-00 STD
 87-425606-00 0.40mm
 87-425608-00 0.60mm

A 40.43
 B- 12.41
 BØ 38.00
 C 0.91
 C 0.91
 D 62.43
 23x55
 (06933)
 AK KK RT TP

08-425600-00 STD
 08-425606-00 0.40mm
 08-425608-00 0.60mm

2.00 CK P
 1.50 NT
 2.00 CR P

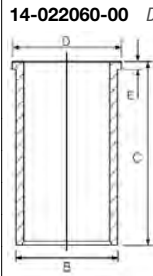

B 72.50 C 142.00 D 74.00 E 5.00

69.60

2

199 B1.000 (Euro 5)	4cyl.	1248cc	70kW (95PS)	Diesel	Turbo Intercooled	TD24590
199 B4.000 (Euro 5)	4cyl.	1248cc	62kW (84PS)	Diesel	Turbo Intercooled	TD24938
MITO 1.3 MultiJet		09/09→10/18				

87-435700-00 STD ①
 87-435706-00 0.40mm ①
 07/12→

A 40.43
 B- 12.70
 BØ 37.00
 C 1.15
 C 0.90
 D 62.43
 23x57
 AK KK RT

08-435700-00 STD
 08-435706-00 0.40mm

1.50 GDC P
 1.50 P
 2.00 CR P

GDC LKZ-Ring

① With Stop/Start Technology ① Für Fahrzeuge mit Start/Stop Funktion ① Pour véhicules équipé du start & stop ① Para vehículos con función start-stop ① Per veicoli con la funzione Start-Stop

69.60

3

330 A1.000	4cyl.	1248cc	70kW (95PS)	Diesel	Turbo Intercooled	TD33158
MITO 1.3 MultiJet		09/09→10/18				

87-450500-00 STD ①

A 40.43
 B- 12.70
 BØ 37.00
 C 0.55
 C 0.30
 D 62.43
 23x56
 (06935-354)
 AK KK RT TP

08-450500-00 STD ②

1.50 GDC P
 1.50 P
 2.00 CR P

GDC LKZ-Ring

ECOTOUGH

① Bowl capacity 15.840cm³ ① Volumen der Kolbenmulde 15.840cm³ ① Volume de la cavité du piston 15.840cm³ ① Vol. cavidad pistón 15.840cm³ ① Volume camera pistone 15.840cm³
 ② Euro 6

72.00

4

350 A1.000 (Euro 4/5)	4cyl.	1368cc	57kW (78PS)	Petrol	TD26416
-----------------------	-------	--------	-------------	--------	---------





MITO 1.4 03/11→10/18

87-436800-00 STD
87-436806-00 0.40mm

A 26.00
B- 4.75
C 2.05
D 49.00
① 18x49



08-436800-00 STD
08-436806-00 0.40mm

1.00 NT①
1.20 P
2.00 CR P



① Steel ① Stahl ① Acier ① Acero ① Acciaio

74.00 **5**

AR 00530	4cyl.	1290cc	64-65kW (87-89PS)	Petrol	TD23
GIULIA 1300 Super			01/74→12/78	SPIDER 1300	01/68→12/77
GT 1300 Junior			01/66→12/77		

87-530400-00 STD

A 32.50
B- 13.60
D 79.10
① 20x64

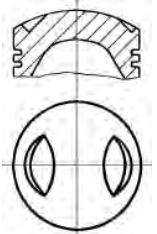

08-530400-00 STD

1.50
1.75
4.00

15-632500-00 WH ①

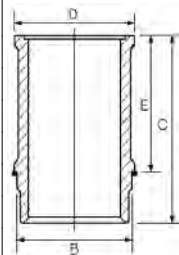

B 80.50 C 139.00 D 90.00 E 89.20

89-530400-00 ①
87-530400-00 +
15-632500-00

① Includes seals ① Schließt Dichtungen ein ① Inclut des joints ① Incluye los sellos ① Comprende le guarnizioni

78.00 **6**

AR 00526	4cyl.	1570cc	71-81kW (97-110PS)	Petrol	TD22
AR 00536	4cyl.	1570cc	80kW (109PS)	Petrol	TD24
AR 01600	4cyl.	1567cc	78-80kW (106-109PS)	Petrol	TD32
AR 06100	4cyl.	1567cc	81kW (110PS)	Petrol	TD47
75 1.6			05/85→09/89	GIULIETTA 1.6	10/77→04/85
ALFETTA 1.6			01/75→12/84	GT 1600	01/66→12/77
ALFETTA GT 1.6			01/76→09/82	SPIDER 1600	03/66→12/90
GIULIA 1600 Super			06/64→12/78		

87-527200-00 STD

A 33.70
B- 15.80
D 82.50
① 22x68

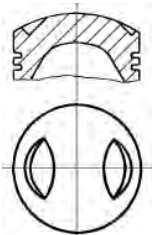

08-527200-00 STD

1.50 CR P
1.75 P
4.00 P

② B 84.00 C 150.00 D 94.00 E 95.50

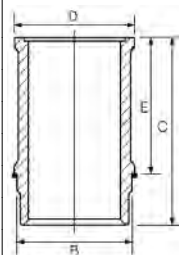

89-527200-00 ①
87-527200-00





① Includes seals ② Liner available in Kit Set only ① Schließt Dichtungen ein ② Zylinderlaufbuchse nur in Assemblies verfügbar ① Inclut des joints ② Chemise disponible en kit seulement ① Incluye los sellos ② Camisas disponible en conjuntos solamente. ① Comprende le guarnizioni ② Cilindro disponibile solo in kit motore

78.00 **7**

AR 61101	4cyl.	1567cc	76-81kW (103-110PS)	Petrol	TD102
75 1.6			05/85→09/89	75 1.6 Cat	05/89→02/92

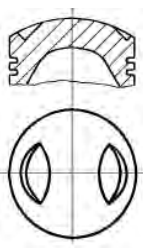



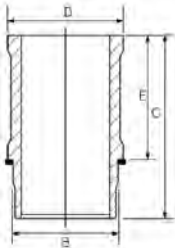

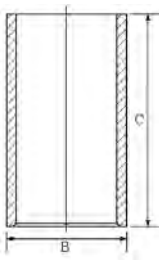

<p>1</p> <p>A 33.70 B- 16.70 D 82.90  22x68</p> 	<p>08-527300-10 STD 2</p> <p>1.50  PS 1.75  P 3.50  CR 3</p> <p>1 Kolben nur im Assembly erhältlich 2 Alternative Spezifikation 3 Stahl 4 Schließt Dichtungen ein</p>	<p>15-632100-00 WH 4</p>  <p>1 Piston disponible en kit seulement 2 Spécification alternative 3 Acier 4 Inclut des joints</p>	<p>B 84.00 C 150.00 D 94.00 E 95.50</p> <p>89-527300-00 15-632100-00</p> <p>1 Pistón disponible en conjuntos solamente. 2 Especificación alternativa 3 Acero 4 Incluye los sellos</p> <p>1 I pistoni sono disponibili solo in kit motore 2 Specifica alternativa 3 Acciaio 4 Comprende le guarnizioni</p>
--	---	--	--

79.37						8
4.108 (Perkins)	4cyl.	1760cc	37-38kW (50-52PS)	Diesel		TD141
GIULIA 1.8 D		06/76→12/78				

<p>14-010900-00 D</p>  <p>B 82.63 C 165.10</p>

79.50						9
940 A3.000	4cyl.	1598cc	77kW (105PS)	Diesel	Turbo Intercooled	TD23923
940 C1.000 (Euro 6)	4cyl.	1598cc	88kW (120PS)	Diesel	Turbo Intercooled	TD32099
940 C5.000 (Euro 6)	4cyl.	1598cc	85-88kW (116-120PS)	Diesel	Turbo Intercooled	TD32093
955 A4.000	4cyl.	1598cc	85kW (115PS)	Diesel	Turbo Intercooled	TD23451
GIULIETTA 1.6 JTDM		04/10→12/20		MITO 1.6 JTDM		08/08→08/15

<p>87-429300-10 STD 1 2 87-429306-10 0.40mm 1 2</p> <p>A 43.95 B- 13.80 BØ 41.70 C 1.01 C 1.03 D 68.95  26x63 (792A-765) AK RT TP</p> 	<p>08-429300-10 STD 3 08-429306-10 0.40mm 3</p> <p>1.50  GDC P 1.50  P 2.00  CR P</p> <p>GDC LKZ-Ring</p> <p>1 Pistons to be replaced in Engine Sets only 2 Bowl capacity 19.65cm³ 3 Euro 6</p> <p>1 Kolben nur in Motorsätzen zu ersetzen 2 Volumen der Kolbenmulde 19.65cm³</p> <p>1 Piston à remplacer dans jeu moteur 2 Volume de la cavité du piston 19.65cm³</p> <p>1 Pistones de repuesto para juegos de motores solamente 2 Vol. cavidad pistón 19.65cm³</p> <p>1 Il pistone può essere rimpiazzato solamente completo 2 Volume camera pistone 19.65cm³</p>
---	--

80.00						10
AR 00548	4cyl.	1779cc	83-97kW (113-132PS)	Petrol		TD18
AR 01608	4cyl.	1779cc	87-89kW (118-121PS)	Petrol		TD5340
AR 01608 X	4cyl.	1779cc	85kW (115PS)	Petrol		TD33
AR 01678	4cyl.	1779cc	88-90kW (120-122PS)	Petrol		TD38





AR 06168	4cyl.	1779cc	88kW (120PS)	Petrol	TD54
AR 06202	4cyl.	1779cc	85-89kW (116-121PS)	Petrol	TD55
AR 61102	4cyl.	1779cc	88kW (120PS)	Petrol	TD10149
AR 61201	4cyl.	1779cc	90kW (122PS)	Petrol	TD103
75 1.8			09/85→02/92	BERLINA 1750	09/68→12/72
90 1.8			10/84→07/87	GIULIETTA 1.8	04/79→07/85
1750-2000 1750			03/68→10/72	GT V 1750	01/67→12/72
ALFETTA 1.8			07/74→12/84	SPIDER 1750	01/67→12/71
ALFETTA GT 1.8			01/74→12/76		

87-528500-00 STD

A 33.25
B- 13.35
D 80.10
 E 22x69

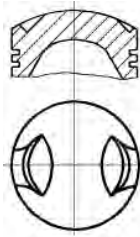

08-528500-00 STD

1.50 CR P
1.75 P
3.50 P

15-632600-00 WH **B** 85.00 **C** 152.00 **D** 98.00 **E** 107.50

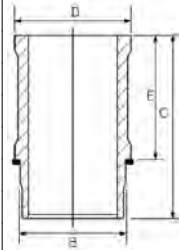

89-528500-00

87-528500-00 +
15-632600-00

Includes seals

Schließt Dichtungen ein

Inclut des joints

Incluye los sellos

Comprende le guarnizioni

82.00

11

AR 32103	4cyl.	1598cc	81-88kW (110-120PS)	Petrol	TD15389
AR 32104 (Euro 3)	4cyl.	1598cc	88kW (120PS)	Petrol	TD15388
147 1.6 16V T.Spark			01/01→03/10	156 1.6 16V T.Spark	09/97→05/06
147 1.6 LPG			03/01→12/09		

87-145400-30 STD

87-145406-30 0.40mm

A 28.47
B+ 0.20
C 1.88
D 50.47
 E 20x52

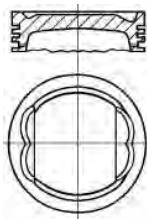

08-145400-00 STD

08-145406-00 0.40mm

1.20 NT
1.20 P
2.00 P

Steel

Stahl

Acier

Acero

Acciaio

82.00

12

AR 32201	4cyl.	1747cc	106kW (144PS)	Petrol	TD9462
AR 32205	4cyl.	1747cc	103kW (140PS)	Petrol	TD15390
AR 38401	4cyl.	1747cc	103kW (140PS)	Petrol	TD9755
AR 67106	4cyl.	1747cc	103kW (140PS)	Petrol	TD5070
145 1.8 i.e. 16V			03/98→01/01	156 1.8 16V T.Spark	02/97→05/06
145 1.8 i.e. 16V T.Spark			12/96→12/98	GT 1.8 TS	11/03→09/10
146 1.8 i.e. 16V T.Spark			11/96→01/01	GTV 1.8 16V	05/98→10/05
155 1.7 T.Spark			05/96→12/97	SPIDER 1.8 16V	05/98→04/05

87-118006-00 0.40mm

A 36.15
B- 0.50
D 60.15
 E 20x52



08-118000-00 STD

08-118006-00 0.40mm

08-118008-00 0.60mm

1.19 NT
1.20 P
2.00 P

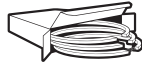

82.00

13

AR 37203 (Euro 3)	4cyl.	1598cc	77kW (105PS)	Petrol	TD15508
147 1.6 16V T.Spark			01/01→03/10	147 1.6 LPG	01/09→03/10

87-145400-00 STD

A 28.47
B- 0.30
D 50.47
20x51



08-145400-00 STD

08-145406-00 0.40mm

1.20 NT
1.20 P
2.00



Steel

Stahl

Acier

Acero

Acciaio

82.00

14

182 B9.000 (Euro 3)	4cyl.	1910cc	74-77kW (101-105PS)	Diesel	Turbo Intercooled	TD18312
839 A6.000 (Euro 3)	5cyl.	2387cc	103kW (140PS)	Diesel	Turbo Intercooled	TD18819
841 C.000 (Euro 3)	5cyl.	2387cc	110kW (150PS)	Diesel	Turbo Intercooled	TD16383
937 A2.000 (Euro 3)	4cyl.	1910cc	81-88kW (110-120PS)	Diesel	Turbo Intercooled	TD16382
937 A7.000	4cyl.	1910cc	85kW (115PS)	Diesel	Turbo Intercooled	TD20933
939 A1.000	4cyl.	1910cc	88kW (120PS)	Diesel	Turbo Intercooled	TD18915
AR 36202 (Euro 3)	5cyl.	2387cc	103kW (140PS)	Diesel	Turbo Intercooled	TD15636
AR 37101 (Euro 3)	4cyl.	1910cc	81kW (110PS)	Diesel	Turbo Intercooled	TD15510
147 1.9 JTD			10/00→03/10	159 1.9 JTDM 8V		09/05→11/11
156 1.9 JTD			10/00→05/06	166 2.4 JTD		10/00→06/07
156 2.4 JTD			10/00→05/06			

87-124000-30 STD

87-124008-30 0.60mm

A 46.50
B- 17.45
BØ 37.55
C 0.65
D 72.50
26x61



NB RT

08-124000-00 STD

08-124008-00 0.60mm

2.00 CK P
2.00 P
2.00 CR P



14-021051-00 D

14-028960-00 D

B 85.57 C 155.00 D 88.53 E 4.00

B 85.00 C 155.00 D 88.00 E 4.50

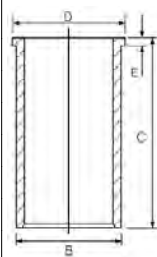

82.00

15

192 A5.000 (Euro 3)	4cyl.	1910cc	103kW (140PS)	Diesel	Turbo Intercooled	TD17981
192 B1.000	4cyl.	1910cc	100kW (136PS)	Diesel	Turbo Intercooled	TD19061
841 G.000 (Euro 3)	5cyl.	2387cc	129kW (175PS)	Diesel	Turbo Intercooled	TD18292
841 M.000	5cyl.	2387cc	120-147kW (163-200PS)	Diesel	Turbo Intercooled	TD20934
841 N.000	5cyl.	2387cc	120-147kW (163-200PS)	Diesel	Turbo Intercooled	TD22510
937 A4.000 (Euro 3)	4cyl.	1910cc	93-103kW (126-140PS)	Diesel	Turbo Intercooled	TD18844
937 A5.000	4cyl.	1910cc	110kW (150PS)	Diesel	Turbo Intercooled	TD18078
939 A2.000	4cyl.	1910cc	110kW (150PS)	Diesel	Turbo Intercooled	TD18473
939 A3.000 (Euro 4)	5cyl.	2387cc	147-154kW (200-209PS)	Diesel	Turbo Intercooled	TD18474
147 1.9 JTD 16V			11/02→03/10	159 1.9 JTDM 16V		09/05→11/11
147 1.9 JTDM 16V			09/04→03/10	159 2.4 JTDM		09/05→11/11
156 1.9 JTD			11/02→05/06	166 2.4 JTD		10/03→06/07
156 1.9 JTD 16V			11/02→05/06	BRERA 2.4 JTDM 20V		01/06→03/11
156 1.9 JTD 16V Q4			07/04→05/06	GT 1.9 JTD		11/03→09/10
156 2.4 JTD			06/03→05/06	SPIDER 2.4 JTDM		03/06→03/11



87-146100-00 STD
87-146108-00 0.60mm

A 46.50
B- 15.40
BØ 41.50
C 1.03
D 72.50
 26x61

(08256-102)

AK KK NB RT TP



08-146100-00 STD
08-146106-00 0.40mm
08-146108-00 0.60mm

2.00  CK P
 2.00  P
 2.00  CK P

14-021051-00 D
14-028960-00 D
B 85.57 **C** 155.00 **D** 88.53 **E** 4.00
B 85.00 **C** 155.00 **D** 88.00 **E** 4.50

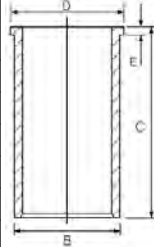

82.00

16

937 A6.000	4cyl.	1910cc	125kW (170PS)	Diesel	Turbo Intercooled	TD24643
147 1.9 JTD M 16V			06/08→03/10	GT 1.9 JTD		05/08→09/10

87-146100-10 STD
87-146106-10 0.40mm

A 46.50
B- 15.40
BØ 41.50
C 1.07
C 1.02
D 72.50
 30x67

(08269-503)

AK KK RT TP



08-146100-00 STD
08-146106-00 0.40mm
08-146108-00 0.60mm

2.00  CK P
 2.00  P
 2.00  CK P

14-021051-00 D
14-028960-00 D
B 85.57 **C** 155.00 **D** 88.53 **E** 4.00
B 85.00 **C** 155.00 **D** 88.00 **E** 4.50

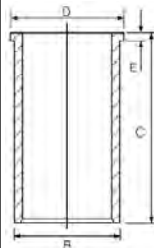

82.00

17

AR 32302 (Euro 2)	4cyl.	1910cc	77kW (105PS)	Diesel	Turbo Intercooled	TD9769
AR 32501 (Euro 2)	5cyl.	2387cc	99-100kW (135-136PS)	Diesel	Turbo Intercooled	TD9770
AR 34202 (Euro 2)	5cyl.	2387cc	100kW (136PS)	Diesel	Turbo Intercooled	TD11604
M 722 BT 24.T (Euro 2)	5cyl.	2387cc	96-100kW (131-136PS)	Diesel	Turbo Intercooled	TD22434
145 1.9 JTD			02/99→01/01	156 2.4 JTD		09/97→09/03
146 1.9 JTD			02/99→01/01	166 2.4 JTD		09/98→10/00
156 1.9 JTD			09/97→10/00			

82.60

18

160 D100	4cyl.	1929cc	51kW (69PS)	Diesel		TD10307
AR 33601	4cyl.	1929cc	66-68kW (90-92PS)	Diesel	Turbo Intercooled	TD5069
AR 67501	4cyl.	1929cc	66-68kW (90-92PS)	Diesel	Turbo Intercooled	TD140
145 1.9 TD			10/94→02/99	155 1.9 TD		04/93→12/97
146 1.9 TD			12/94→02/99	AR 6 1.9 D		04/85→12/89





<p>87-783800-30 STD 87-783808-30 0.60mm</p> <p>A 42.40 B+ 2.50 D 76.00 26x69</p> <p>HA RT</p>	<p>08-783800-00 STD 08-783808-00 0.60mm</p> <p>3.00 2.00 3.00</p> <p>MOL P P CR P</p>	<p>14-014730-00 D</p> <p>B 86.09 C 154.00</p>	
		<p>14-021311-00 D B 86.06 C 154.00 D 89.00 E 4.50 14-023560-00 D B 86.00 C 154.00 D 89.00 E 4.50 14-023751-00 D B 87.00 C 154.00 D 89.00 E 4.55</p>	

82.60 **19**

AR 67502	4cyl.	1929cc	66-68kW (90-92PS)	Diesel	Turbo Intercooled	TD21140
155 1.9 TD		04/93→04/96				

		<p>14-014730-00 D</p> <p>B 86.09 C 154.00</p>	
		<p>14-021311-00 D B 86.06 C 154.00 D 89.00 E 4.50 14-023560-00 D B 86.00 C 154.00 D 89.00 E 4.50 14-023751-00 D B 87.00 C 154.00 D 89.00 E 4.55</p>	

83.00 **20**

932 A2.000	4cyl.	1970cc	110-121kW (150-165PS)	Petrol	TD18076
937 A1.000	4cyl.	1970cc	119-122kW (162-166PS)	Petrol	TD16381
147 2.0			07/02→05/05	GT 2.0 JTS	11/03→09/10
156 2.0 JTS			03/01→05/06	GTV 2.0 JTS	04/03→10/05





GT 2.0 09/06→12/08 SPIDER 2.0 JTS 04/03→04/05

87-145206-00 0.40mm

A 31.00
B- 5.15
B+ 3.05
C 1.76
D 51.30
 20x52



08-145200-00 STD
08-145206-00 0.40mm

1.20 NT
1.20 P
2.00 NT

Steel

Stahl

Acier

Acero

Acciaio

83.00 **21**

AR 16201	4cyl.	1970cc	110kW (150PS)	Petrol	TD4188
AR 32301	4cyl.	1970cc	114kW (155PS)	Petrol	TD9463
AR 34103	4cyl.	1970cc	114kW (155PS)	Petrol	TD11599
AR 67204	4cyl.	1970cc	110kW (150PS)	Petrol	TD4190

145 2.0 16V	03/98→01/01	156 2.0 16V T.Spark	09/97→06/02
145 2.0 16V T.Spark	10/95→01/01	166 2.0 T.Spark	09/98→10/00
146 2.0 16V	03/97→10/01	GTV 2.0 16V T.Spark	06/95→10/05
146 2.0 16V T.Spark	10/95→01/01	SPIDER 2.0 16V T.Spark	06/95→04/05
155 2.0 16V T.Spark	03/95→12/97		

87-110900-00 STD
87-110906-00 0.40mm

A 32.00
B- 3.10
D 56.00
 20x52



08-110900-00 STD
08-110906-00 0.40mm

1.20 CR
1.50 P
3.00 CR P

Steel

Stahl

Acier

Acero

Acciaio

83.00 **22**

AR 32310 (Euro 3/4)	4cyl.	1970cc	110-114kW (150-155PS)	Petrol	TD15391
AR 36301	4cyl.	1970cc	110kW (150PS)	Petrol	TD15392

147 2.0 16V T.Spark	01/01→03/10	GTV 2.0 16V T.Spark	06/95→10/05
156 2.0 16V T.Spark	09/97→06/02	SPIDER 2.0 16V T.Spark	06/95→04/05
166 2.0 T.Spark	10/00→06/07		

87-145300-00 STD
87-145306-00 0.40mm

A 31.30
B- 3.80
BØ 69.00
D 51.30
 20x52



08-145300-00 STD
08-145306-00 0.40mm

1.20 NT
1.20 P
2.00 P

Steel

Stahl

Acier

Acero

Acciaio

83.00 **23**

198 A5.000	4cyl.	1956cc	121kW (165PS)	Diesel	Turbo Intercooled	TD24647
-------------------	-------	---------------	----------------------	---------------	--------------------------	----------------





844 A2.000	4cyl.	1956cc	120kW (163PS)	Diesel	Turbo Intercooled	TD24594
939 B3.000	4cyl.	1956cc	125kW (170PS)	Diesel	Turbo Intercooled	TD23107
939 B4.000	4cyl.	1956cc	100kW (136PS)	Diesel	Turbo Intercooled	TD24644
939 B5.000	4cyl.	1956cc	125kW (170PS)	Diesel	Turbo Intercooled	TD24645
940 A4.000	4cyl.	1956cc	125kW (170PS)	Diesel	Turbo Intercooled	TD23924
940 A5.000 (Euro 5)	4cyl.	1956cc	103kW (140PS)	Diesel	Turbo Intercooled	TD24578
940 A7.000 (Euro 5)	4cyl.	1956cc	120kW (163PS)	Diesel	Turbo Intercooled	TD24793
940 A8.000 (Euro 5)	4cyl.	1956cc	100kW (136PS)	Diesel	Turbo Intercooled	TD25424

159 2.0 JTDM	05/09→11/11	GIULIETTA 2.0 JTDM	04/10→12/20
BRERA 2.0 JTDM	03/08→06/10	SPIDER 2.0 JTDM	04/09→03/11

87-436500-00 STD

87-436506-00 0.40mm

A 46.63
B- 15.80
BØ 43.50
D 72.63
 30x66

(08344A406)

AK KK RT TP



08-436500-00 STD

08-436506-00 0.40mm

1.50  GDC P
 1.50  P
 2.00  CR P



84.00

24

AR 00512 (Twin Cam)	4cyl.	1962cc	96kW (131PS)	Petrol	TD75
AR 01544	4cyl.	1962cc	85kW (116PS)	Petrol	TD28
AR 01623	4cyl.	1962cc	82-90kW (112-122PS)	Petrol	TD34
AR 01713	4cyl.	1962cc	94-97kW (128-132PS)	Petrol	TD41
AR 06166	4cyl.	1962cc	107kW (146PS)	Petrol	TD53
AR 06416	4cyl.	1962cc	102-106kW (138-144PS)	Petrol	TD62
AR 06420	4cyl.	1962cc	105-109kW (143-148PS)	Petrol	TD63
AR 10512	4cyl.	1962cc	96kW (131PS)	Petrol	TD5351
AR 11671	4cyl.	1962cc	96kW (131PS)	Petrol	TD70
AR 19510	4cyl.	1962cc	104-109kW (142-148PS)	Petrol	TD23344
AR 64103	4cyl.	1995cc	106kW (144PS)	Petrol	TD129
AR 67201	4cyl.	1995cc	104-106kW (141-144PS)	Petrol	TD136
AR 67202	4cyl.	1995cc	104-106kW (141-144PS)	Petrol	TD137

75 2.0 T.Spark	01/87→02/92	ALFETTA 2.0	09/74→12/84
90 2.0 i.e.	10/84→07/87	ALFETTA GT 2.0	07/78→01/86
155 2.0 T.Spark	02/92→05/95	GIULIETTA 2.0	06/80→04/85
164 2.0	06/87→09/98	SPIDER 2000	01/71→12/90
164 2.0 T.Spark	06/87→09/98	SPORT 2.0	09/77→12/79
164 2.0 Twin Spark	07/90→10/92		

15-632000-00 WH  **B 89.00 C 152.00 D 98.00 E 107.50**

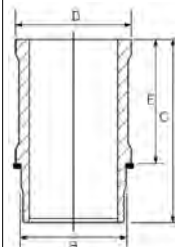

 Includes seals

 Schließt Dichtungen ein

 Inclut des joints



 Incluye los sellos

 Comprende le guarnizioni



84.00 **25**

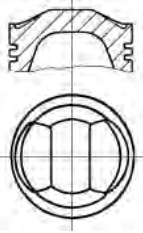

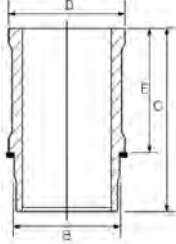
AR 01588	4cyl.	1962cc	86-88kW (120PS)	Petrol	TD30
AR 06224	4cyl.	1962cc	107-109kW (146-148PS)	Petrol	TD58
75 2.0 T.Spark			01/87→02/92	SPIDER 2.0	09/82→12/93
75 2.0 T.Spark Cat			05/85→02/92	SPIDER 2000	01/90→12/93

A 32.75 B- 12.85 D 79.10  22x71		08-110200-00 STD	 CR P P P		15-632000-00 WH ² B 89.00 C 152.00 D 98.00 E 107.50	89-110200-40 ² 15-632000-00
		1.50 1.50 3.50			89-110200-40 ² 15-632000-00	

¹ Piston available in Kit Set only
 ¹ Kolben nur im Assembly erhältlich
 ¹ Piston disponible en kit seulement
 ¹ Pistón disponible en conjuntos solamente.
 ¹ I pistoni sono disponibili solo in kit motore
² Includes seals
 ² Schließt Dichtungen ein
 ² Inclut des joints
 ² Incluye los sellos
 ² Comprende le guarnizioni

84.00 **26**

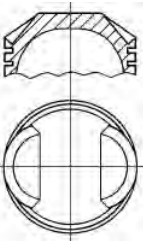
AR 01655	4cyl.	1962cc	96kW (131PS)	Petrol	TD37
AR 06212	4cyl.	1962cc	94-96kW (128-131PS)	Petrol	TD57
75 2.0			05/85→10/88	ALFETTA GT 2.0	06/77→12/84
90 2.0 i.e.			10/84→07/87	GIULIETTA 2.0	06/80→04/85
ALFETTA 2.0			07/78→12/84	GTV 2.0	07/78→01/86

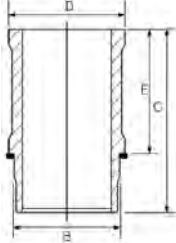
A 33.20 B- 18.80 D 85.50  22x71		08-107100-10 STD	 CR P P P		15-632000-00 WH ¹ B 89.00 C 152.00 D 98.00 E 107.50	89-107100-40 ¹ 87-107100-40 + 15-632000-00
		1.50 1.75 4.00			89-107100-40 ¹ 87-107100-40 + 15-632000-00	

¹ Includes seals
 ¹ Schließt Dichtungen ein
 ¹ Inclut des joints
 ¹ Incluye los sellos
 ¹ Comprende le guarnizioni

84.00 **27**

AR 06476	4cyl.	1995cc	128-129kW (174-175PS)	Petrol	Turbo Intercooled	TD65
164 2.0 Turbo			10/87→09/98			

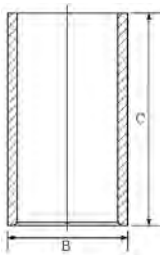
		14-011041-00 D B 88.06 C 152.00	
			

84.00 **28**

AR 11633	4cyl.	1962cc	82-96kW (112-131PS)	Petrol	TD22398
AR 11634	4cyl.	1962cc	82kW (112PS)	Petrol	TD68
ALFETTA GT 2.0			09/74→12/77	SPRINT 2.0	09/76→12/79





87-107100-30 STD

A 32.75
B- 14.75
D 81.00
 22x71

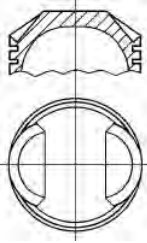



08-107100-00 STD

1.50  CR P
 1.75  P
 4.50  P

15-632000-00 WH 

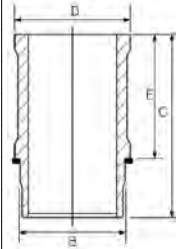
B 89.00 **C** 152.00 **D** 98.00 **E** 107.50





89-107100-30 
 87-107100-30 +
 15-632000-00

 Includes seals

 Schließt Dichtungen ein

 Inclut des joints

 Incluye los sellos

 Comprende le guarnizioni

84.00

29

AR 67203	4cyl.	1995cc	137-140kW (186-190PS)	Petrol	Turbo Intercooled	TD138
155 2.0 16V Turbo Q4		01/92→12/97				

87-142400-00 STD

87-142406-00 0.40mm

A 39.00
B- 6.00
BØ 72.00
C 2.00
D 69.00
 22x69

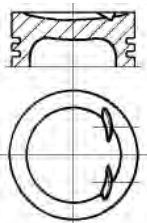

08-142400-00 STD

08-142406-00 0.40mm

1.50  CK
 1.50  P
 3.00  P

14-011041-00 D

B 88.06 **C** 152.00

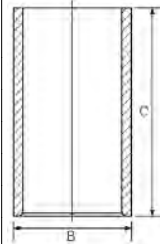

AK

92.00

30

VM 4HT 2.4	4cyl.	2393cc	69-70kW (94-95PS)	Diesel	Turbo	TD159
VM 07 B	4cyl.	2499cc	92kW (125PS)	Diesel	Turbo	TD149
VM 08 B	4cyl.	2499cc	92kW (125PS)	Diesel	Turbo	TD9771
VM 31 B	4cyl.	2499cc	92-125kW (125-170PS)	Diesel	Turbo	TD9768
VM 32 B	4cyl.	2499cc	92kW (125PS)	Diesel	Turbo	TD127
VM 81 A	4cyl.	2393cc	81kW (110PS)	Diesel	Turbo	TD152
VM 82 A	3cyl.	1779cc	54kW (73PS)	Diesel	Turbo	TD153
VM 84 A	4cyl.	2499cc	84kW (114PS)	Diesel	Turbo	TD154
VM 96 A	3cyl.	1779cc	62kW (84PS)	Diesel	Turbo	TD155
33 1.8 TD			01/86→09/94	155 2.5 TD		04/93→12/97
75 2.4 TD			01/89→02/92	164 2.5 TD		06/87→09/98
90 2.4 TD			10/84→07/87	ALFETTA 2.4 TD		04/83→12/84

15-676420-00 WH 
14-676420-00 WH

B 101.50 **C** 166.80 **D** 110.00 **E** 8.90 **F** 1.20
B 101.50 **C** 166.80 **D** 110.00 **E** 8.90 **F** 1.20

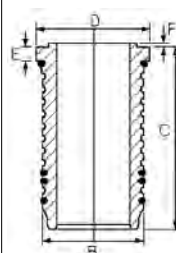

 Includes seals

 Schließt Dichtungen ein

 Inclut des joints

 Incluye los sellos

 Comprende le guarnizioni

93.00

31

8140.21.200 (SOFIM 2.4TD)	4cyl.	2445cc	68kW (92PS)	Diesel	Turbo	TD143
8144.21.220 (Sofim)	4cyl.	2445cc	68kW (92PS)	Diesel	Turbo	TD145





AR 6 2.4 TD		09/86→12/89	AR 8 2.4 TD	04/85→12/89
87-245200-30 STD		08-245200-00 STD 08-245208-00 0.60mm	14-021371-00 D 14-021372-00 D	B 96.01 C 171.00 D 98.92 E 5.00 B 96.05 C 171.00 D 98.92 E 5.00
A 59.65 B- 14.80 BØ 51.90 D 97.65 32x75 RT		3.00 CR P 2.00 P 3.00 CR P		

93.00					32
8140.27R/S.2700 (Sofim)	4cyl.	2499cc	Diesel	Turbo	MP9102
AR 8 2.5D					

87-245200-40 STD		08-245200-00 STD 08-245208-00 0.60mm	14-021371-00 D 14-021372-00 D	B 96.01 C 171.00 D 98.92 E 5.00 B 96.05 C 171.00 D 98.92 E 5.00
A 58.75 B- 17.90 BØ 38.00 D 96.75 32x75 RT		3.00 CR P 2.00 P 3.00 CR P		

93.00					33
8140.61.200	4cyl.	2445cc	53kW (72PS)	Diesel	TD144
8144.61.200	4cyl.	2445cc	53kW (72PS)	Diesel	TD146
8144.67.220	4cyl.	2500cc	55kW (75PS)	Diesel	TD147
AR 6 2.4 D		04/85→02/86	AR 8 2.4 D		04/78→08/86
AR 6 2.5 D		03/86→12/89	AR 8 2.5 D		09/86→12/89

14-022560-00 D **B 96.00 C 167.30 D 98.90 E 5.00**
14-028930-00 D **B 97.50 C 167.00 D 100.90 E 5.00**
14-028931-00 D **B 97.58 C 167.00 D 100.90 E 5.00**
14-028932-00 D **B 97.70 C 167.00 D 100.90 E 5.00**

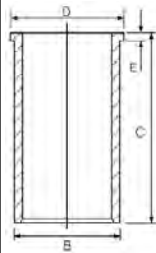



CCM

x



9

1Y	Diesel	1896	4	79.50	13
1Z	Diesel	1896	4	79.50	14
3D	Diesel	2370	5	79.50	13
4B	Petrol	1781	4	81.00	22
AAH	Petrol	2771	V6	82.50	40
AAS	Diesel	2370	5	79.50	13
AAZ	Diesel	1896	4	79.50	15
ABK	Petrol	1984	4	82.50	35
ADE	Diesel	1896	4	79.50	15
ADP	Petrol	1595	4	81.00	23
ADR	Petrol	1781	4	81.00	24
AEB	Petrol	1781	4	81.00	25
AEH	Petrol	1595	4	81.00	23
AEJ	Petrol	2771	V6	82.50	40
AFC	Petrol	2771	V6	82.50	40
AFF	Diesel	1896	4	79.50	14
AFN	Diesel	1896	4	79.50	14
AGN	Petrol	1781	4	81.00	24
AGR	Diesel	1896	4	79.50	14
AGU	Petrol	1781	4	81.00	25
AHF	Diesel	1896	4	79.50	14
AHH	Diesel	1896	4	79.50	14
AHL	Petrol	1595	4	81.00	26
AHU	Diesel	1896	4	79.50	14
AJL	Petrol	1781	4	81.00	25
AJM	Diesel	1896	4	79.50	16
AJP	Petrol	1781	4	81.00	24
AJQ	Petrol	1781	4	81.00	25
AKL	Petrol	1595	4	81.00	23
ALH	Diesel	1896	4	79.50	14
ALZ	Petrol	1595	4	81.00	27
AMB	Petrol	1781	4	81.00	28
AMF	Diesel	1422	3	79.50	11
ANA	Petrol	1595	4	81.00	27
ANB	Petrol	1781	4	81.00	25
ANU	Diesel	1896	4	79.50	17
APF	Petrol	1595	4	81.00	23
APG	Petrol	1781	4	81.00	24
APP	Petrol	1781	4	81.00	25
APT	Petrol	1781	4	81.00	24
APU	Petrol	1781	4	81.00	25
AQA	Petrol	1781	4	81.00	25
AQE	Petrol	1781	4	81.00	24
ARG	Petrol	1781	4	81.00	24
ARH	Petrol	1781	4	81.00	24
ARK	Petrol	1781	4	81.00	25
ARM	Petrol	1595	4	81.00	23
ARX	Petrol	1781	4	81.00	28
ARY	Petrol	1781	4	81.00	28
ARZ	Petrol	1781	4	81.00	25
ASB	Diesel	2967	V6	83.00	41
ASV	Diesel	1896	4	79.50	14
ASZ	Diesel	1896	4	79.50	18
ATC	Petrol	1781	4	81.00	28
ATD	Diesel	1896	4	79.50	17
ATJ	Diesel	1896	4	79.50	16
ATL	Diesel	1422	3	79.50	12
AUA	Petrol	1390	4	76.50	5
AUM	Petrol	1781	4	81.00	28
AUQ	Petrol	1781	4	81.00	28

ENGINE INDEX

Motorverzeichnis • Index de moteur • Índice de Motor
 Indeks silnika • Модель Двигателя • دليل المحرك

CCM

9

AVB	Diesel	1896	4	79.50	17
AVF	Diesel	1896	4	79.50	18
AVG	Diesel	1896	4	79.50	14
AVJ	Petrol	1781	4	81.00	28
AVU	Petrol	1595	4	81.00	27
AVV	Petrol	1781	4	81.00	24
AWA	Petrol	1984	4	82.50	36
AWM	Petrol	1781	4	81.00	28
AWP	Petrol	1781	4	81.00	28
AWT	Petrol	1781	4	81.00	28
AWX	Diesel	1896	4	79.50	18
AXR	Diesel	1896	4	79.50	17
AXW	Petrol	1984	4	82.50	36
AXX	Petrol	1984	4	82.50	37
AZV	Diesel	1968	4	81.00	30
BBY	Petrol	1390	4	76.50	5
BEX	Petrol	1781	4	81.00	28
BFB	Petrol	1781	4	81.00	28
BFQ	Petrol	1595	4	81.00	27
BGB	Petrol	1984	4	82.50	37
BGU (Euro 4)	Petrol	1595	4	81.00	27
BHC	Diesel	1422	3	79.50	11
BKC	Diesel	1896	4	79.50	17
BKD	Diesel	1968	4	81.00	30
BKE	Diesel	1896	4	79.50	14
BKN	Diesel	2967	V6	83.00	41
BLB	Diesel	1968	4	81.00	30
BLR	Petrol	1984	4	82.50	36
BLS	Diesel	1896	4	79.50	17
BLX	Petrol	1984	4	82.50	36
BLY	Petrol	1984	4	82.50	36
BMB	Petrol	1984	4	82.50	36
BMK	Diesel	2967	V6	83.00	41
BMM	Diesel	1968	4	81.00	31
BMN	Diesel	1968	4	81.00	30
BNA	Diesel	1968	4	81.00	30
BNG	Diesel	2967	V6	83.00	41
BPG	Petrol	1984	4	82.50	37
BPJ	Petrol	1984	4	82.50	37
BPW	Diesel	1968	4	81.00	31
BPY	Petrol	1984	4	82.50	37
BRB	Diesel	1896	4	79.50	19
BRC	Diesel	1968	4	81.00	31
BRD	Diesel	1968	4	81.00	30
BRE	Diesel	1968	4	81.00	30
BRF	Diesel	1968	4	81.00	30
BSE (Euro 4/5)	Petrol	1595	4	81.00	27
BSF	Petrol	1595	4	81.00	27
BUG	Diesel	2967	V6	83.00	41
BUL	Petrol	1984	4	82.50	37
BUN	Diesel	2967	V6	83.00	41
BUY	Diesel	1968	4	81.00	30
BVA	Diesel	1968	4	81.00	30
BVF	Diesel	1968	4	81.00	30
BVG	Diesel	1968	4	81.00	30
BVP	Petrol	1781	4	81.00	28
BVR	Petrol	1781	4	81.00	28
BVY	Petrol	1984	4	82.50	36
BVZ	Petrol	1984	4	82.50	36
BWA	Petrol	1984	4	82.50	37



CCM

x



9

BWE	Petrol	1984	4	82.50	37
BWT	Petrol	1984	4	82.50	37
BXE	Diesel	1896	4	79.50	17
BYK	Petrol	1984	4	82.50	37
CAEA	Petrol	1984	4	82.50	38
CAEB	Petrol	1984	4	82.50	38
CAED	Petrol	1984	4	82.50	38
CAGA	Diesel	1968	4	81.00	32
CAGB	Diesel	1968	4	81.00	32
CAGC	Diesel	1968	4	81.00	32
CAHA	Diesel	1968	4	81.00	32
CAHB	Diesel	1968	4	81.00	32
CAVG	Petrol	1390	4	76.50	6
CAWB	Petrol	1984	4	82.50	38
CAXA (Euro 5)	Petrol	1390	4	76.50	7
CAXC	Petrol	1390	4	76.50	7
CAYB	Diesel	1598	4	79.50	20
CAYC	Diesel	1598	4	79.50	20
CBAA	Diesel	1968	4	81.00	32
CBAB	Diesel	1968	4	81.00	32
CBBB	Diesel	1968	4	81.00	32
CBZA	Petrol	1197	4	71.00	1
CBZB	Petrol	1197	4	71.00	1
CCTA	Petrol	1984	4	82.50	38
CCZA	Petrol	1984	4	82.50	38
CCZC	Petrol	1984	4	82.50	38
CDAA	Petrol	1798	4	82.50	39
CDHA	Petrol	1798	4	82.50	39
CDHB	Petrol	1798	4	82.50	39
CDNB	Petrol	1984	4	82.50	38
CDNC	Petrol	1984	4	82.50	38
CESA	Petrol	1984	4	82.50	38
CETA	Petrol	1984	4	82.50	38
CFFA	Diesel	1968	4	81.00	33
CFFB	Diesel	1968	4	81.00	33
CFGB	Diesel	1968	4	81.00	33
CFGC	Diesel	1968	4	81.00	33
CFGD	Diesel	1968	4	81.00	33
CFHB	Diesel	1968	4	81.00	33
CFHD	Diesel	1968	4	81.00	33
CFKA	Petrol	1984	4	82.50	38
CGLA	Diesel	1968	4	81.00	33
CGLB	Diesel	1968	4	81.00	33
CGLC	Diesel	1968	4	81.00	33
CGLD	Diesel	1968	4	81.00	33
CGLE	Diesel	1968	4	81.00	33
CHJA	Petrol	1984	4	82.50	38
CJCA	Diesel	1968	4	81.00	33
CJCB	Diesel	1968	4	81.00	33
CJCC	Diesel	1968	4	81.00	33
CJCD	Diesel	1968	4	81.00	33
CJZA	Petrol	1197	4	71.00	2
CJZB (Euro 5)	Petrol	1197	4	71.00	2
CLHA (Euro 6)	Diesel	1598	4	79.50	21
CLJA	Diesel	1968	4	81.00	33
CLLB	Diesel	1968	4	81.00	33
CMBA (Euro 5)	Petrol	1395	4	74.50	3
CMFA	Diesel	1968	4	81.00	33
CMFB	Diesel	1968	4	81.00	33
CMGA	Diesel	1968	4	81.00	33

ENGINE INDEX

Motorverzeichnis • Index de moteur • Índice de Motor
 Indeks silnika • Модель Двигателя • دليل المحرك

CCM
x

9

CMGB	Diesel	1968	4	81.00	33
CMSA	Petrol	1390	4	76.50	7
CN	Diesel	1986	5	76.50	9
CNVA	Petrol	1390	4	76.50	7
CPMA	Petrol	1984	4	82.50	38
CPMB	Petrol	1984	4	82.50	38
CPSA	Petrol	1984	4	82.50	38
CR	Diesel	1588	4	76.50	9
CRBC	Diesel	1968	4	81.00	34
CRBD	Diesel	1968	4	81.00	34
CRFA	Diesel	1968	4	81.00	34
CRFC	Diesel	1968	4	81.00	34
CRKB (Euro 5/6)	Diesel	1598	4	79.50	21
CRLB	Diesel	1968	4	81.00	34
CRLC	Diesel	1968	4	81.00	34
CRUA	Diesel	1968	4	81.00	34
CSUA	Diesel	1968	4	81.00	34
CSUB	Diesel	1968	4	81.00	34
CSUD	Diesel	1968	4	81.00	34
CSUE	Diesel	1968	4	81.00	34
CTHG	Petrol	1390	4	76.50	6
CTJA	Petrol	1390	4	76.50	6
CUVC	Diesel	1968	4	81.00	34
CUVD	Diesel	1968	4	81.00	34
CXMA (Euro 6 EA288)	Diesel	1598	4	79.50	21
CXSA (Euro 5)	Petrol	1395	4	74.50	3
CXXB (Euro 6)	Diesel	1598	4	79.50	21
CY	Diesel	1588	4	76.50	10
CYVA (Euro 6)	Petrol	1197	4	71.00	2
CYVB	Petrol	1197	4	71.00	2
CZCA (Euro 6)	Petrol	1395	4	74.50	3
CZHA	Diesel	1968	4	81.00	34
DADA (Euro 6)	Petrol	1495	4	74.50	4
DE	Diesel	1986	5	76.50	10
DEJA (Euro 6)	Diesel	1968	4	81.00	34
DEJB (Euro 6)	Diesel	1968	4	81.00	34
DEUA	Diesel	1968	4	81.00	34
DEUB	Diesel	1968	4	81.00	34
DEUC	Diesel	1968	4	81.00	34
DHFA (Euro 6)	Petrol	1498	4	74.50	4
DPCA (Euro 6)	Petrol	1495	4	74.50	4
DR	Petrol	1781	4	81.00	22
DS	Petrol	1781	4	81.00	29
DZ	Petrol	1781	4	81.00	29
JK	Diesel	1588	4	76.50	9
JN	Petrol	1781	4	81.00	22
JV	Petrol	1781	4	81.00	29
MG	Petrol	1781	4	81.00	22
MU	Petrol	1781	4	81.00	29
NC	Diesel	1986	5	76.50	10
NE	Petrol	1781	4	81.00	29
PH	Petrol	1781	4	81.00	29
PM	Petrol	1781	4	81.00	22
PV	Petrol	1781	4	81.00	29
RA	Diesel	1588	4	76.50	10
RS	Petrol	1781	4	81.00	22
RU	Petrol	1781	4	81.00	22
SB	Diesel	1588	4	76.50	10
SF	Petrol	1781	4	81.00	22
SH	Petrol	1781	4	81.00	22

Motorverzeichnis • Index de moteur • Índice de Motor
 Indeks silnika • Модель ДВИгателя • دليل المحرك

ENGINE INDEX



CCM

x





9

YJ	Petrol	1471	4	76.50	8
ZB	Petrol	1471	4	76.50	8
ZC	Petrol	1471	4	76.50	8





71.00 **1**

CBZA	4cyl.	1197cc	63kW (86PS)	Petrol	Turbo Intercooled	TD24385
CBZB	4cyl.	1197cc	77kW (105PS)	Petrol	Turbo Intercooled	TD23907
A1 1.2 TFSI			05/10→04/15	A3 1.2 TSI		04/10→03/13
A3 1.2 TFSI			03/10→05/13			

<p>87-443900-10 STD</p> <p>A 28.90 D 45.00 19x42</p> <p>HA</p> 	<p>08-443900-00 STD</p> <p>1.00 NT ① 1.20 P 2.00 NT ①</p> 	<p>① Steel ② Stahl ③ Acier ④ Acero ⑤ Acciaio</p>
--	--	--



71.00 **2**

CJZA	4cyl.	1197cc	77kW (105PS)	Petrol	Turbo Intercooled	TD27151
CJZB (Euro 5)	4cyl.	1197cc	63kW (86PS)	Petrol	Turbo Intercooled	TD27188
CYVA (Euro 6)	4cyl.	1197cc	63kW (86PS)	Petrol	Turbo Intercooled	TD34746
CYVB	4cyl.	1197cc	81kW (110PS)	Petrol	Turbo Intercooled	TD29301
A3 1.2 TFSI			02/13→			

<p>87-442300-10 STD ① ②</p> <p>A 28.00 B+ 0.70 C 3.52 C 3.52 D 44.50 17x49 (07124A101) AK HA TP</p> 	<p>08-442300-10 STD ③</p> <p>1.20 NT ④ 1.20 CR P 2.00 NT ④</p> 	<p>① Earlier pistons to be replaced in Engine sets only ② Elastoval ® ③ For Nüral OE piston ④ Steel</p> <p>① Frühere Kolben nur in Motorsätzen zu ersetzen ③ Für OE-Kolben von Nüral ④ Stahl</p> <p>① Premier piston à remplacer dans le jeu moteur ③ Pour les pistones d'origine Nüral ④ Acier</p> <p>① Pistones más antiguos para ser reemplados en juego de motore s solamente ③ Para pistones originales Nüral ④ Acero</p> <p>① Con i pistone di vecchia versione è necessario sostituire tu tta la serie ③ Per pistoni Nüral OE ④ Acciaio</p>
--	---	--

74.50 **3**

CMBA (Euro 5)	4cyl.	1395cc	90kW (122PS)	Petrol	Turbo Intercooled	TD26718
CXSA (Euro 5)	4cyl.	1395cc	90kW (122PS)	Petrol	Turbo Intercooled	TD28200
CZCA (Euro 6)	4cyl.	1395cc	92kW (125PS)	Petrol	Turbo Intercooled	TD29303
A1 1.4 TFSI			11/14→10/18	A3 1.4 TFSI		04/12→

<p>87-449500-00 STD</p> <p>A 31.00 B- 1.25 BØ 53.07 C 2.90 C 4.40 19x47 TP</p> 	<p>08-449500-00 STD</p> <p>1.20 NT ① 1.20 CR P 2.00 NT ①</p> 	<p>① Steel ② Stahl ③ Acier ④ Acero ⑤ Acciaio</p>
---	---	--

74.50 **4**

DADA (Euro 6)	4cyl.	1495cc	110kW (150PS)	Petrol	Turbo Intercooled	TD34767
----------------------	-------	---------------	----------------------	---------------	--------------------------	----------------





DHFA (Euro 6)	4cyl.	1498cc	96kW (131PS)	Petrol	Turbo Intercooled	TD37243
DPCA (Euro 6)	4cyl.	1495cc	110kW (150PS)	Petrol	Turbo Intercooled	TD38451
A1 35 TFSI			09/18→	A3 35 TFSI		10/18→
A1 Carver 35 TFSI			07/19→	Q2 35 TFSI		07/18→
A3 1.5 TFSI			05/17→10/18	Q3 35 TFSI		08/18→
A3 30 g-tron			11/18→			

87-453500-00 STD

- A 30.80mm
- B- 5.00mm
- BØ 61.70mm
- C 2.30mm
- C 3.50mm
- D 48.90mm
- RT TP 19.00x50.00



08-453500-00 STD

- 1.20 PVD 1
- 1.20mm CR
- 2.00mm NT 1



1 Steel

1 Stahl

1 Acier

1 Acero

1 Acciaio

76.50

5

AUA	4cyl.	1390cc	55kW (75PS)	Petrol	TD15248
BBY	4cyl.	1390cc	55kW (75PS)	Petrol	TD16414
A2 1.4			02/00→08/05		

87-116100-00 STD

87-116107-00 0.50mm 1

- A 28.92
- B- 1.98
- BØ 61.90
- C 2.32
- D 49.92
- RT 17x54



08-116100-00 STD

08-116107-00 0.50mm

- 1.20 NT 2
- 1.50 P
- 2.50 CR 2



1 A = 28.670, D = 49.670

2 Steel

2 Stahl

2 Acier

2 Acero

2 Acciaio

76.50

6

CAVG	4cyl.	1390cc	136kW (185PS)	Petrol	Turbo Intercooled	TD24937
CTHG	4cyl.	1390cc	136kW (185PS)	Petrol	Turbo Intercooled	TD25659
CTJA	4cyl.	1390cc	136kW (185PS)	Petrol	Turbo & Supercharged	TD25660
A1 1.4 TFSI			01/11→04/15			

87-433900-10 STD 1 2

87-433907-10 0.50mm 1 2

- A 29.00
- B- 6.40
- B+ 1.85
- C 1.00
- C 3.80
- D 48.00
- RT 19x54



08-433900-00 STD

08-433907-00 0.50mm

- 1.20 NT 3
- 1.50 P
- 2.00 NT 3



1 Pistons to be replaced in Engine Sets only

1 Kolben nur in Motorsätzen zu ersetzen

1 Piston à remplacer dans jeu moteur

1 Pistones de repuesto para juegos de motores solamente

1 Il pistone può essere rimpiazzato solamente completo

2 Elastoval ®

3 Steel

3 Stahl

3 Acier

3 Acero

3 Acciaio



76.50 **7**

CAXA (Euro 5)	4cyl.	1390cc	90kW (122PS)	Petrol	Turbo Intercooled	TD24386
CAXC	4cyl.	1390cc	92kW (125PS)	Petrol	Turbo Intercooled	TD20715
CMSA	4cyl.	1390cc	92kW (125PS)	Petrol	Turbo Intercooled	TD23936
CNVA	4cyl.	1390cc	90kW (122PS)	Petrol	Turbo Intercooled	TD24951

A1 1.4 TFSI 05/10→04/15 A3 1.4 TFSI 09/07→05/13

<p>87-429900-00 STD ①</p> <p>87-429907-00 0.50mm ①</p>	<p>08-429900-00 STD</p> <p>08-429907-00 0.50mm</p>	
<p>A 29.20</p> <p>B- 4.50</p> <p>C 3.60</p> <p>D 48.20</p> <p> 19x52</p> <p>HA</p>	<p>1.20</p> <p>1.20</p> <p>2.00</p>	<p>NT②</p> <p>P</p> <p>NT②</p>

① Elastoval® ② Steel ② Stahl ② Acier ② Acero ② Acciaio

76.50 **8**

YJ	4cyl.	1471cc	55kW (75PS)	Petrol	TD4213
ZB	4cyl.	1471cc	55kW (75PS)	Petrol	TD366
ZC	4cyl.	1471cc	63kW (85PS)	Petrol	TD367

80 B1 1.5 05/72→07/76

	<p>14-021571-00 D B 79.56 C 142.00 D 82.50 E 4.50</p> <p>14-023470-00 D ① B 79.50 C 142.00 D 82.50 E 4.70</p> <p>14-024670-00 D B 79.50 C 145.00 D 81.50 E 4.70</p> <p>14-028360-00 D ② B 79.50 C 145.00 D 81.50 E 4.70</p>

① Phosphated ① Phosphatiert ① Phosphaté ① Fosfatado ① Fosfatato

② With recesses on crankshaft side ② Mit kurbelwellenseitigen Aussparungen ② Avec évidements côté vilebrequin ② Con escotaduras en la cara del cigüeñal ② Con nicchie sul lato albero motore

76.50 **9**

CN	5cyl.	1986cc	51kW (69PS)	Diesel	TD247
CR	4cyl.	1588cc	40kW (54PS)	Diesel	TD248
JK	4cyl.	1588cc	40kW (54PS)	Diesel	TD269

80 B2 1.6 D 08/80→08/86 100 C2 2.0 D 08/78→02/83

80 B3 1.6 D 02/87→07/89 100 C3 2.0 D 08/82→11/90





87-109500-00 STD ①
 87-109505-00 0.25mm ①
 87-109507-00 0.50mm ① ②
 87-109511-00 1.00mm ① ②

A 41.70
 B- 1.60
 D 71.70
 24x64

(07633)

RT



08-109500-00 STD
 08-109505-00 0.25mm
 08-109507-00 0.50mm
 08-109511-00 1.00mm

1.75  CR P
 2.00  P
 3.00  CR P

14-021571-00 D B 79.56 C 142.00 D 82.50 E 4.50
 14-028360-00 D ③ B 79.50 C 145.00 D 81.50 E 4.70

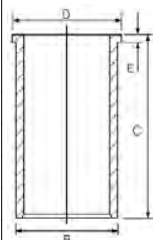

① No oil-jet cut out

① Ohne Aussparung für Kühllölspritzdüse

① Sans encoche en bas de jupe pour le passage de la pissette d'huile sous pression

① Sin escotadura

① Senza passaggio per spruzzatore olio

② A = 41.450

③ With recesses on crankshaft side

③ Mit kurbelwellenseitigen Aussparungen

③ Avec évidements côté vilebrequin

③ Con escotaduras en la cara del cigüeñal

③ Con nicchie sul lato albero motore

76.50

10

CY	4cyl.	1588cc	51kW (70PS)	Diesel	Turbo Intercooled	TD4205
DE	5cyl.	1986cc	64-66kW (87-90PS)	Diesel	Turbo Intercooled	TD251
NC	5cyl.	1986cc	74kW (100PS)	Diesel	Turbo Intercooled	TD299
RA	4cyl.	1588cc	59kW (80PS)	Diesel	Turbo Intercooled	TD313
SB	4cyl.	1588cc	59kW (80PS)	Diesel	Turbo Intercooled	TD4211

80 B2 1.6 TD	08/81→05/86	100 C3 2.0 D	01/83→07/85
80 B3 1.6 TD	09/86→08/91	100 C3 2.0 D Turbo	08/82→11/90
90 B2 1.6 TD	10/85→01/87	100 C3 2.0 TD	03/83→11/90
90 B3 1.6 TD	04/87→09/91		

87-109800-10 STD
 87-109807-10 0.50mm ①
 87-109811-10 1.00mm ①

A 41.70
 B- 1.60
 D 71.70
 24x64

AK HA RT TP



08-109800-00 STD
 08-109807-00 0.50mm
 08-109811-00 1.00mm

1.75  CR P
 2.00  CR P
 3.00  CR P

14-021571-00 D B 79.56 C 142.00 D 82.50 E 4.50
 14-028360-00 D ② B 79.50 C 145.00 D 81.50 E 4.70

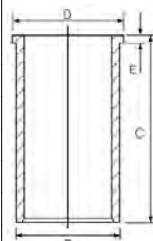

① A = 41.450

② With recesses on crankshaft side

② Mit kurbelwellenseitigen Aussparungen

② Avec évidements côté vilebrequin

② Con escotaduras en la cara del cigüeñal

② Con nicchie sul lato albero motore

79.50

11

AMF	3cyl.	1422cc	55kW (75PS)	Diesel	Turbo Intercooled	TD17156
BHC	3cyl.	1422cc	55kW (75PS)	Diesel	Turbo Intercooled	TD18133

A2 1.4 TDI	02/00→08/05		
------------	-------------	--	--

87-114900-80 STD ① ②
 87-114907-80 0.50mm ①

A 45.80
 B- 17.65
 BØ 38.00
 C 1.10
 D 69.80
 26x63

AK KK NB RT TP



08-114900-00 STD
 08-114907-00 0.50mm
 08-114911-00 1.00mm

1.75  CK P
 2.00  P
 3.00  CR P

14-027950-00 D B 82.50 C 152.00 D 85.50 E 4.70

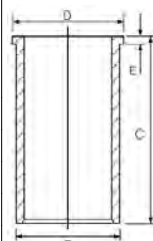



87-114900-85 STD ② ③
87-114907-85 0.50mm ③

A 45.80
B- 17.65
BØ 38.00
C 1.10
D 69.80
 26x63



AK KK NB RT TP

08-114900-00 STD
08-114907-00 0.50mm
08-114911-00 1.00mm

1.75  CK P
 2.00  P
 3.00  CR P

① To cylinder 1 & 2
 ② Bowl capacity 23.75cm³
 ③ To cylinder 3

① an Zylinder 1 & 2
 ② Volumen der Kolbenmulde 23.75cm³
 ③ an Zylinder 3

① sur cylindre 1 & 2
 ② Volume de la cavité du piston 23.75cm³
 ③ sur cylindre 3

① en el cilindro 1 & 2
 ② Vol. cavidad pistón 23.75cm³
 ③ en el cilindro 3

① a cilindro 1 & 2
 ② Volume camera pistone 23.75cm³
 ③ a cilindro 3

79.50

12

ATL	3cyl.	1422cc	66kW (90PS)	Diesel	Turbo Intercooled	TD17071
A2 1.4 TDI		11/03→08/05				

14-027950-00 D **B 82.50 C 152.00 D 85.50 E 4.70**

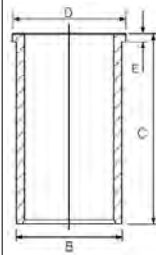

79.50

13

1Y	4cyl.	1896cc	50kW (68PS)	Diesel	TD213
3D	5cyl.	2370cc	60kW (82PS)	Diesel	TD218
AAS	5cyl.	2370cc	60kW (82PS)	Diesel	TD227
80 B3 1.9 D		08/89→08/91	100 C4 2.4 D		12/90→07/94
100 C3 2.4 D		08/89→07/91			

14-027950-00 D **B 82.50 C 152.00 D 85.50 E 4.70**

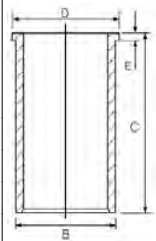

87-990100-40 STD
87-990105-40 0.25mm
87-990107-40 0.50mm ①
87-990111-40 1.00mm ①

A 39.65
B- 1.90
D 65.70
 24x64
 (07945)
AK RT



08-990100-00 STD
08-990105-00 0.25mm
08-990107-00 0.50mm
08-990111-00 1.00mm

1.75  CR P
 2.00  P
 3.00  CR P

① A = 39.400

79.50

14

1Z	4cyl.	1896cc	66kW (90PS)	Diesel	Turbo Intercooled	TD214
AFF	4cyl.	1896cc	55kW (75PS)	Diesel	Turbo Intercooled	TD11597
AFN	4cyl.	1896cc	81kW (110PS)	Diesel	Turbo Intercooled	TD4202
AGR	4cyl.	1896cc	66kW (90PS)	Diesel	Turbo Intercooled	TD5076
AHF	4cyl.	1896cc	81kW (110PS)	Diesel	Turbo Intercooled	TD9371
AHH	4cyl.	1896cc	66kW (90PS)	Diesel	Turbo Intercooled	TD16413









AHU	4cyl.	1896cc	66kW (90PS)	Diesel	Turbo Intercooled	TD10814
ALH	4cyl.	1896cc	66kW (90PS)	Diesel	Turbo Intercooled	TD11595
ASV	4cyl.	1896cc	81kW (110PS)	Diesel	Turbo Intercooled	TD15354
AVG	4cyl.	1896cc	81kW (110PS)	Diesel	Turbo Intercooled	TD13774
BKE	4cyl.	1896cc	85kW (116PS)	Diesel	Turbo Intercooled	TD17596
80 B4 1.9 TDI			09/91→01/96	A4 B7 1.9 TDI		11/04→06/08
A3 1.9 TDI			09/96→07/01	A6 C4 1.9 TDI		06/94→12/97
A4 B5 1.9			03/98→06/00	A6 C5 1.9 TDI		04/97→04/01
A4 B5 1.9 TDI			01/95→09/01	CABRIOLET B3 1.9 TDI		06/95→08/00
A4 B6 1.9 TDI			06/04→12/04			

87-114900-60 STD ① ②
87-114907-60 0.50mm ① ② ③

A 45.80
B- 17.65
BØ 38.00
C 1.10
D 68.80
 26x66
 (07987)
AK KK NB RT



08-114900-00 STD
08-114907-00 0.50mm
08-114911-00 1.00mm

1.75  CK P
 2.00  P
 3.00  CR P

14-027950-00 D **B 82.50 C 152.00 D 85.50 E 4.70**

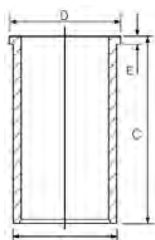



87-114900-70 STD ② ④
87-114907-70 0.50mm ② ③ ④

A 45.80
B- 17.65
BØ 38.00
C 1.10
D 68.80
 26x66
 (07987A)
AK KK NB RT



08-114900-00 STD
08-114907-00 0.50mm
08-114911-00 1.00mm



1.75  CK P
 2.00  P
 3.00  CR P

87-114900-90 STD ①
87-114907-90 0.50mm ① ⑤
87-114900-95 STD ④
87-114907-95 0.50mm ④ ⑤

A 45.80
B- 17.65
BØ 38.00
C 1.10
D 71.80
 26x66
AK NB RT



08-114900-00 STD
08-114907-00 0.50mm
08-114911-00 1.00mm

1.75  CK P
 2.00  P
 3.00  CR P

- ① To cylinder 1 & 2
- ② Bowl capacity 23.54cm³
- ③ A = 45.550, D = 68.550
- ④ To cylinder 3 & 4
- ⑤ A = 45.550, D = 71.550

- ① an Zylinder 1 & 2
- ② Volumen der Kolbenmulde 23.54cm³
- ④ an Zylinder 3 & 4

- ① sur cylindre 1 & 2
- ② Volume de la cavité du piston 23.54cm³
- ④ sur cylindre 3 & 4

- ① en el cilindro 1 & 2
- ② Vol. cavidad pistón 23.54cm³
- ④ en el cilindro 3 & 4

- ① a cilindro 1 & 2
- ② Volume camera pistone 23.54cm³
- ④ a cilindro 3 & 4

79.50						15
AAZ	4cyl.	1896cc	55kW (75PS)	Diesel	Turbo	TD229
ADE	4cyl.	1896cc	55kW (75PS)	Diesel	Turbo Intercooled	TD22656
80 B4 1.9 TD			09/91→12/94			





87-990100-10 STD
87-990107-10 0.50mm ①
87-990111-10 1.00mm ①

A 45.65
B- 1.90
D 71.70
 26x66



AK HA RT

08-990100-00 STD
08-990105-00 0.25mm
08-990107-00 0.50mm
08-990111-00 1.00mm

1.75 CR P
 2.00 P
 3.00 CR P

14-027950-00 D **B 82.50 C 152.00 D 85.50 E 4.70**

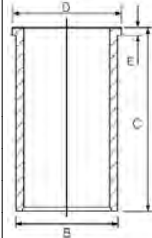

① A = 45.430

79.50

16

AJM	4cyl.	1896cc	85kW (115PS)	Diesel	Turbo Intercooled	TD11527
ATJ	4cyl.	1896cc	85kW (115PS)	Diesel	Turbo Intercooled	TD15989
A4 B5 1.9 TDI		03/00 → 09/01		A6 C5 1.9 TDI		07/00 → 01/05

87-114900-05 STD ① ②
87-114907-05 0.50mm ① ② ③
 →09/02

A 45.80
B- 17.80
BØ 38.00
C 1.30
D 68.80
 26x66



(07969L-101)
AK KK NB RT TP

08-114900-00 STD
08-114907-00 0.50mm
08-114911-00 1.00mm

1.75 CK P
 2.00 P
 3.00 CR P

14-027950-00 D **B 82.50 C 152.00 D 85.50 E 4.70**

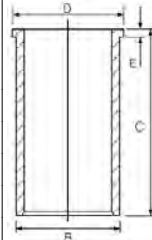

87-114900-15 STD ① ④
87-114907-15 0.50mm ① ③ ④
 →09/02

A 45.80
B- 17.80
BØ 38.00
C 1.30
D 68.80
 26x66



(07969L-102)
AK KK NB RT TP

08-114900-00 STD
08-114907-00 0.50mm
08-114911-00 1.00mm

1.75 CK P
 2.00 P
 3.00 CR P

87-114900-55 STD ② ⑤ ⑥
87-114907-55 0.50mm ② ③ ⑤
 09/02 →

A 45.80
B- 17.60
BØ 38.00
C 1.10
D 68.80
 26x66



(07901D101)
AK KK NB RT TP

08-114900-00 STD
08-114907-00 0.50mm
08-114911-00 1.00mm

1.75 CK P
 2.00 P
 3.00 CR P





87-114900-56 STD ④ ⑤ ⑥
87-114907-56 0.50mm ③ ④ ⑤
 09/02→

A 45.80
B- 17.60
BØ 38.00
C 1.10
D 68.60
 26x66



(07901D102)
AK KK NB RT TP

08-114900-00 STD
08-114907-00 0.50mm
08-114911-00 1.00mm

1.75  CK P
 2.00  P
 3.00  CR P

① For side angled injection nozzle

① Nur für schräg angeordnete Einspritzdüsen

① Pour buse d'injection latérale angulaire

① Para la boquilla de inyección lateral angular

① Per il lato angolato dell'ugello olio

② To cylinder 1 & 2

② an Zylinder 1 & 2

② sur cylindre 1 & 2

② en el cilindro 1 & 2

② a cilindro 1 & 2

③ A = 45.550, D = 68.550

③ an Zylinder 3 & 4

③ sur cylindre 3 & 4

③ en el cilindro 3 & 4

③ a cilindro 3 & 4

④ To cylinder 3 & 4

④ Für neuere Ausführungen, direkt einspritzende Düsen

④ Pour buse d'injection droite à conception plus récente

④ Para el más reciente diseño de boquilla de inyección directa

④ Per la più recente progettazione dell'ugello olio non ango lato

⑥ Bowl capacity 23.60cm³

⑥ Volumen der Kolbenmulde 23.60cm³

⑥ Volume de la cavité du piston 23.60cm³

⑥ Vol. cavidad pistón 23.60cm³

⑥ Volume camera pistone 23.60cm³

79.50

17

ANU	4cyl.	1896cc	66kW (90PS)	Diesel	Turbo Intercooled	TD11596
ATD	4cyl.	1896cc	74kW (101PS)	Diesel	Turbo Intercooled	TD16028
AVB	4cyl.	1896cc	74kW (101PS)	Diesel	Turbo Intercooled	TD16518
AXR	4cyl.	1896cc	74kW (100PS)	Diesel	Turbo Intercooled	TD16416
BKC	4cyl.	1896cc	77kW (105PS)	Diesel	Turbo Intercooled	TD17026
BLS	4cyl.	1896cc	77kW (105PS)	Diesel	Turbo Intercooled	TD20823
BXE	4cyl.	1896cc	77kW (105PS)	Diesel	Turbo Intercooled	TD22657

A3 1.9 TDI

10/00→05/10

A4 B6 1.9 TDI

05/01→12/04

87-114900-65 STD ① ②
87-114907-65 0.50mm ① ③

A 45.80
B- 17.20
BØ 38.00
C 1.10
D 68.80
 26x66



(07901D-301)
AK KK NB RT TP

08-114900-00 STD
08-114907-00 0.50mm
08-114911-00 1.00mm

1.75  CK P
 2.00  P
 3.00  CR P

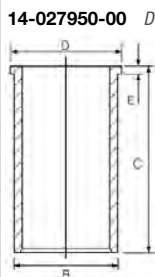

B 82.50 C 152.00 D 85.50 E 4.70

87-114900-66 STD ② ④
87-114907-66 0.50mm ③ ④

A 45.80
B- 17.20
BØ 38.00
C 1.10
D 68.80
 26x66



(07901D-302)
AK KK NB RT TP

08-114900-00 STD
08-114907-00 0.50mm
08-114911-00 1.00mm

1.75  CK P
 2.00  P
 3.00  CR P

① To cylinder 1 & 2

① an Zylinder 1 & 2

① sur cylindre 1 & 2

① en el cilindro 1 & 2

① a cilindro 1 & 2

② Bowl capacity 22.85cm³

② Volumen der Kolbenmulde 22.85cm³

② Volume de la cavité du piston 22.85cm³

② Vol. cavidad pistón 22.85cm³

② Volume camera pistone 22.85cm³

③ A = 45.550, D = 68.550

④ To cylinder 3 & 4

④ sur cylindre 3 & 4

④ en el cilindro 3 & 4

④ a cilindro 3 & 4



79.50 **18**

ASZ	4cyl.	1896cc	96kW (130PS)	Diesel	Turbo Intercooled	TD15351
AVF	4cyl.	1896cc	96kW (130PS)	Diesel	Turbo Intercooled	TD15348
AWX	4cyl.	1896cc	96kW (130PS)	Diesel	Turbo Intercooled	TD16133

A3 1.9 TDI	08/00→05/03	A6 C5 1.9 TDI	08/01→01/05
A4 B6 1.9 TDI	11/00→12/04		

87-114900-25 STD ① ②
87-114907-25 0.50mm ① ③
 →09/02

A 45.80
B- 17.90
BØ 38.00
C 1.10
D 68.80
 26x66
 (07969K101)
AK KK NB RT TP



08-114900-00 STD
08-114907-00 0.50mm
08-114911-00 1.00mm

- 1.75  CK P
- 2.00  P
- 3.00  CR P

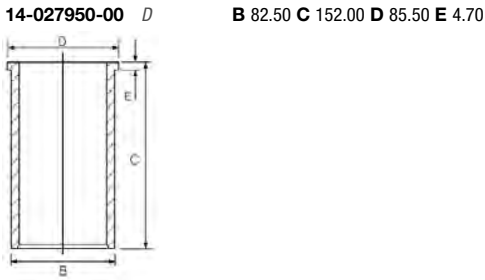

87-114900-35 STD ② ④
87-114907-35 0.50mm ③ ④
 →09/02

A 45.80
B- 17.90
BØ 38.00
C 1.10
D 68.80
 26x66
 (07969K102)
AK KK NB RT TP





08-114900-00 STD
08-114907-00 0.50mm
08-114911-00 1.00mm

- 1.75  CK P
- 2.00  P
- 3.00  CR P

87-114900-45 STD ① ⑤
87-114907-45 0.50mm ① ③
 09/02→

A 45.80
B- 17.50
BØ 38.00
C 1.10
D 68.80
 26x66
 (07901C105)
AK KK NB RT TP

08-114900-00 STD
08-114907-00 0.50mm
08-114911-00 1.00mm

- 1.75  CK P
- 2.00  P
- 3.00  CR P





87-114900-46 STD ④ ⑤
87-114907-46 0.50mm ③ ④
 09/02→

A 45.80
B- 17.50
BØ 38.00
C 1.10
D 68.80
 26x66



(07901C106)

AK KK NB RT TP

08-114900-00 STD
08-114907-00 0.50mm
08-114911-00 1.00mm

1.75  CK P
 2.00  P
 3.00  CR P

- ① To cylinder 1 & 2
- ② Bowl capacity 24.60cm³
- ③ A = 45.550, D = 68.550
- ④ To cylinder 3 & 4
- ⑤ Bowl capacity 24.05cm³

- ① an Zylinder 1 & 2
- ② Volumen der Kolbenmulde 24.60cm³
- ④ an Zylinder 3 & 4
- ⑤ Volumen der Kolbenmulde 24.05cm³

- ① sur cylindre 1 & 2
- ② Volume de la cavité du piston 24.60cm³
- ④ sur cylindre 3 & 4
- ⑤ Volume de la cavité du piston 24.05cm³

- ① en el cilindro 1 & 2
- ② Vol. cavidad pistón 24.60cm³
- ④ en el cilindro 3 & 4
- ⑤ Vol. cavidad pistón 24.05cm³

- ① a cilindro 1 & 2
- ② Volume camera pistone 24.60cm³
- ④ a cilindro 3 & 4
- ⑤ Volume camera pistone 24.05cm³

79.50

19

BRB	4cyl.	1896cc	85kW (116PS)	Diesel	Turbo Intercooled	TD20492
A4 B7 1.9 TDI						
11/04→06/08						

87-114900-55 STD ① ② ③
87-114907-55 0.50mm ① ② ④

A 45.80
B- 17.60
BØ 38.00
C 1.10
D 68.80
 26x66



(07901D101)

AK KK NB RT TP

08-114900-00 STD
08-114907-00 0.50mm
08-114911-00 1.00mm

1.75  CK P
 2.00  P
 3.00  CR P

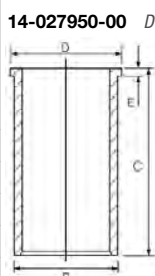

14-027950-00 D **B** 82.50 **C** 152.00 **D** 85.50 **E** 4.70

87-114900-56 STD ① ③ ⑤
87-114907-56 0.50mm ① ④ ⑤

A 45.80
B- 17.60
BØ 38.00
C 1.10
D 68.60
 26x66



(07901D102)

AK KK NB RT TP

08-114900-00 STD
08-114907-00 0.50mm
08-114911-00 1.00mm

1.75  CK P
 2.00  P
 3.00  CR P

- ① For newer design straight injection nozzle
- ② To cylinder 1 & 2
- ③ Bowl capacity 23.60cm³
- ④ A = 45.550, D = 68.550
- ⑤ To cylinder 3 & 4

- ① Für neuere Ausführungen, direkt einspritzende Düsen
- ② an Zylinder 1 & 2
- ③ Volumen der Kolbenmulde 23.60cm³
- ⑤ an Zylinder 3 & 4

- ① Pour buse d'injection droite à conception plus récente
- ② sur cylindre 1 & 2
- ③ Volume de la cavité du piston 23.60cm³
- ⑤ sur cylindre 3 & 4

- ① Para el más reciente diseño de boquilla de inyección directa
- ② en el cilindro 1 & 2
- ③ Vol. cavidad pistón 23.60cm³
- ⑤ en el cilindro 3 & 4

- ① Per la più recente progettazione dell'ugello olio non ango lato
- ② a cilindro 1 & 2
- ③ Volume camera pistone 23.60cm³
- ⑤ a cilindro 3 & 4

79.50

20

CAYB	4cyl.	1598cc	66kW (90PS)	Diesel	Turbo Intercooled	TD22661
CAYC	4cyl.	1598cc	77kW (105PS)	Diesel	Turbo Intercooled	TD22662
A1 1.6 TDI						
05/10→04/15						
A3 1.6 TDI						
05/09→05/13						





87-432900-00 STD 1
87-432905-00 0.25mm
87-432907-00 0.50mm

A 45.30
B- 10.70
B- 4.70
BØ 49.00
D 67.80
 26x66
 (0790MA-104)
KK RT TP



08-432900-00 STD
08-432905-00 0.25mm
08-432907-00 0.50mm

1.75  GDC P
 2.00  P
 3.00  CR P



1 Bowl capacity 19.75cm³

1 Volumen der Kolbenmulde 19.75cm³

1 Volume de la cavité du piston 19.75cm³

1 Vol. cavidad pistón 19.75cm³

1 Volume camera pistone 19.75cm³

79.50

21

CLHA (Euro 6)	4cyl.	1598cc	77kW (105PS)	Diesel	Turbo Intercooled	TD26721
CRKB (Euro 5/6)	4cyl.	1598cc	81kW (110PS)	Diesel	Turbo Intercooled	TD28311
CXMA (Euro 6 EA288)	4cyl.	1598cc	85kW (115PS)	Diesel	Turbo Intercooled	TD29749
CXXB (Euro 6)	4cyl.	1598cc	81kW (110PS)	Diesel	Turbo Intercooled	TD31334

A1 1.6 TDI

11/14→10/18

A3 1.6 TDI

10/12→

87-444100-00 STD
87-444105-00 0.25mm
87-444107-00 0.50mm

A 45.30
B- 11.00
BØ 49.00
D 68.30
 26x66
AK KK RT TP



08-444100-00 STD
08-444105-00 0.25mm
08-444107-00 0.50mm

1.75  GDC P
 2.00  P
 2.00  CR P



81.00

22

4B	4cyl.	1781cc	66kW (90PS)	Petrol	TD219
DR	4cyl.	1781cc	55kW (75PS)	Petrol	TD252
JN	4cyl.	1781cc	66-68kW (90-93PS)	Petrol	TD4208
MG	4cyl.	1781cc	76-79kW (103-107PS)	Petrol	TD297
PM	4cyl.	1781cc	66kW (90PS)	Petrol	TD306
RS	4cyl.	1781cc	55kW (75PS)	Petrol	TD317
RU	4cyl.	1781cc	55kW (75PS)	Petrol	TD320
SF	4cyl.	1781cc	65-66kW (88-90PS)	Petrol	TD325
SH	4cyl.	1781cc	65-66kW (88-90PS)	Petrol	TD326

80 B2 1.8

01/83→12/86

100 C3 1.8

08/82→07/90

80 B2 1.8 CC

08/85→08/86

100 C3 1.8 Cat

03/85→11/90

80 B3 1.8

10/86→01/90

COUPE B2 1.8 GT

01/85→10/88

80 B3 1.8 S

08/86→10/91





87-109700-10 STD
87-109705-10 0.25mm
87-109707-10 0.50mm

A 32.20
B- 8.10
BØ 56.80
B+ 1.10
D 62.30
 20x54



(08131-122)

08-109700-00 STD
08-109705-00 0.25mm
08-109707-00 0.50mm

1.50  CR P
 1.75  P
 3.00  CR P

81.00

23

ADP	4cyl.	1595cc	74kW (100PS)	Petrol	TD4198
AEH	4cyl.	1595cc	74kW (101PS)	Petrol	TD5074
AKL	4cyl.	1595cc	74kW (101PS)	Petrol	TD9990
APF	4cyl.	1595cc	74kW (101PS)	Petrol	TD11588
ARM	4cyl.	1595cc	74kW (100PS)	Petrol	TD14148
A3 1.6		09/96→05/03		A4 B5 1.6	11/94→09/01

87-105900-00 STD
87-105907-00 0.50mm ¹

A 32.00
B- 2.30
BØ 61.40
B+ 0.70
D 53.70
 20x57



08-105900-00 STD
08-105907-00 0.50mm

1.20  NT ²
 1.50  P
 2.00  CR ²

¹ A = 31.700, D = 53.400

² Steel

² Stahl

² Acier

² Acero

² Acciaio

81.00

24

ADR	4cyl.	1781cc	92-95kW (125-129PS)	Petrol	TD241
AGN	4cyl.	1781cc	92kW (125PS)	Petrol	TD5073
AJP	4cyl.	1781cc	92kW (125PS)	Petrol	TD9518
APG	4cyl.	1781cc	92kW (125PS)	Petrol	TD11589
APT	4cyl.	1781cc	92kW (125PS)	Petrol	TD13775
AQE	4cyl.	1781cc	92kW (125PS)	Petrol	TD14029
ARG	4cyl.	1781cc	92kW (125PS)	Petrol	TD13776
ARH	4cyl.	1781cc	92kW (125PS)	Petrol	TD15329
AVV	4cyl.	1781cc	92kW (125PS)	Petrol	TD16412
A3 1.8		09/96→05/03		A6 C5 1.8	07/97→01/05
A4 B5 1.8		11/94→09/01		CABRIOLET B3 1.8	01/97→08/00
A6 C4 1.8		12/95→12/97			





87-502900-00 STD ①
87-502907-00 0.50mm ① ②

A 32.55
C 3.60
D 56.55
 20x59
 (08192)



08-502900-00 STD
08-502905-00 0.25mm
08-502907-00 0.50mm

1.50  CK P
 1.75  P
 2.00  CR P

AK

① Conrod gap 27.50mm ① Pleuelaugenabstand 27.50mm ① Distance entre bielle 27.50mm ① Distancia del biela 27.50mm ① Distanza dalla bielle 27.50mm
 ② A = 32.250, D = 56.250

81.00 **25**

AEB	4cyl.	1781cc	110-112kW (150-152PS)	Petrol	Turbo Intercooled	TD4199
AGU	4cyl.	1781cc	110kW (150PS)	Petrol	Turbo Intercooled	TD5075
AJL	4cyl.	1781cc	132kW (180PS)	Petrol	Turbo Intercooled	TD9470
AJQ	4cyl.	1781cc	132kW (180PS)	Petrol	Turbo Intercooled	TD11347
ANB	4cyl.	1781cc	110kW (150PS)	Petrol	Turbo Intercooled	TD13949
APP	4cyl.	1781cc	132kW (180PS)	Petrol	Turbo Intercooled	TD11591
APU	4cyl.	1781cc	110kW (150PS)	Petrol	Turbo Intercooled	TD13950
AQA	4cyl.	1781cc	110kW (150PS)	Petrol	Turbo Intercooled	TD11592
ARK	4cyl.	1781cc	110kW (150PS)	Petrol	Turbo Intercooled	TD13929
ARZ	4cyl.	1781cc	110kW (150PS)	Petrol	Turbo Intercooled	TD11593

A3 1.8 T 12/96→05/03 A6 C5 1.8 T 01/97→01/05
 A4 B5 1.8 T 01/95→09/01 TT 1.8 T 10/98→06/06

87-502900-10 STD
87-502905-10 0.25mm
87-502907-10 0.50mm

A 32.70
B- 2.05
BØ 70.00
D 53.70
 20x59



08-502900-00 STD
08-502905-00 0.25mm
08-502907-00 0.50mm

1.50  CK P
 1.75  P
 2.00  CR P

AK

81.00 **26**

AHL	4cyl.	1595cc	74kW (100PS)	Petrol	TD10816
------------	-------	---------------	---------------------	---------------	----------------

A4 B5 1.6 11/94→09/01

87-105900-00 STD
87-105907-00 0.50mm ①
 →Eng.8D X 400 000

A 32.00
B- 2.30
BØ 61.40
B+ 0.70
D 53.70
 20x57



08-105900-00 STD
08-105907-00 0.50mm

1.20  NT ②
 1.50  P
 2.00  CR ②

AK





87-148300-00 STD
87-148307-00 0.50mm
 Eng.8D X 400 001→

A 29.08
B- 2.70
BØ 62.30
D 50.70
 19x42



TP

08-148300-00 STD
08-148307-00 0.50mm

1.00  NT^②
 1.20  P
 2.00  CR P

① A = 31.700, D = 53.400
 ② Steel

② Stahl

② Acier

② Acero

② Acciaio

81.00

27

ALZ	4cyl.	1595cc	75kW (102PS)	Petrol	TD15748
ANA	4cyl.	1595cc	74kW (100PS)	Petrol	TD14128
AVU	4cyl.	1595cc	75kW (102PS)	Petrol	TD15350
BFQ	4cyl.	1595cc	75kW (102PS)	Petrol	TD17166
BGU (Euro 4)	4cyl.	1595cc	75kW (102PS)	Petrol	TD16871
BSE (Euro 4/5)	4cyl.	1595cc	75kW (102PS)	Petrol	TD20711
BSF	4cyl.	1595cc	75kW (102PS)	Petrol	TD20712
A3 1.6			08/00→03/13	A4 B6 1.6	11/00→12/04
A4 B5 1.6			11/94→09/01	A4 B7 1.6	11/04→06/08

87-148300-00 STD
87-148307-00 0.50mm

A 29.08
B- 2.70
BØ 62.30
D 50.70
 19x42



TP

08-148300-00 STD
08-148307-00 0.50mm

1.00  NT^①
 1.20  P
 2.00  CR P

① Steel

① Stahl

① Acier

① Acero

① Acciaio

81.00

28

AMB	4cyl.	1781cc	125-127kW (170-173PS)	Petrol	Turbo Intercooled	TD17864
ARX	4cyl.	1781cc	110kW (150PS)	Petrol	Turbo Intercooled	TD15988
ARY	4cyl.	1781cc	132kW (180PS)	Petrol	Turbo Intercooled	TD15352
ATC	4cyl.	1781cc	132kW (180PS)	Petrol	Turbo Intercooled	TD15357
AUM	4cyl.	1781cc	110kW (150PS)	Petrol	Turbo Intercooled	TD15629
AUQ	4cyl.	1781cc	132kW (180PS)	Petrol	Turbo Intercooled	TD15353
AVJ	4cyl.	1781cc	110kW (150PS)	Petrol	Turbo Intercooled	TD15349
AWM	4cyl.	1781cc	125-127kW (170-173PS)	Petrol	Turbo Intercooled	TD29751
AWP	4cyl.	1781cc	132-134kW (180-182PS)	Petrol	Turbo Intercooled	TD15356
AWT	4cyl.	1781cc	110kW (150PS)	Petrol	Turbo Intercooled	TD15335
BEX	4cyl.	1781cc	140kW (190PS)	Petrol	Turbo Intercooled	TD16730
BFB	4cyl.	1781cc	120kW (163PS)	Petrol	Turbo Intercooled	TD16728
BVP	4cyl.	1781cc	120kW (163PS)	Petrol	Turbo Intercooled	TD18490
BVR	4cyl.	1781cc	140kW (190PS)	Petrol	Turbo Intercooled	TD18493
A3 1.8 T			12/96→05/03	A4 B8 1.8 T	07/08→05/10	
A4 B5 1.8 T			01/95→12/01	A6 C5 1.8 T	01/97→01/05	





A4 B6 1.8 T	11/00→12/05	TT 1.8 T	10/98→06/06
A4 B7 1.8 T	11/04→03/09		

87-502900-30 STD
87-502907-30 0.50mm

08-502900-00 STD
08-502905-00 0.25mm
08-502907-00 0.50mm

A 32.70
C 1.90
D 53.70
 19x49



1.50 CK P
 1.75 P
 2.00 CR P

TP

81.00					29
DS	4cyl.	1781cc	66kW (90PS)	Petrol	TD253
DZ	4cyl.	1781cc	82kW (112PS)	Petrol	TD256
JV	4cyl.	1781cc	66kW (90PS)	Petrol	TD278
MU	4cyl.	1781cc	82kW (112PS)	Petrol	TD298
NE	4cyl.	1781cc	66kW (90PS)	Petrol	TD4210
PH	4cyl.	1781cc	66kW (90PS)	Petrol	TD305
PV	4cyl.	1781cc	79-81kW (107-110PS)	Petrol	TD311

80 B2 1.8	01/83→08/86	90 B3 1.8 E	08/89→08/91
80 B2 1.8 CC	08/84→08/86	100 C3 1.8	08/83→07/89
80 B2 1.8 GTE	08/84→08/86	100 C3 1.8 Cat	03/85→11/90
80 B3 1.8 E	06/86→08/91	COUPE B2 1.8 GT	09/82→10/88
80 B3 1.8 S	09/86→10/91	COUPE B3 1.8	08/89→07/91

87-109400-50 STD ①
87-109407-50 0.50mm ① ②

08-109400-10 STD
08-109407-10 0.50mm

A 32.20
B- 4.40
BØ 55.70
B+ 1.30
D 62.50
 20x57
 (08130E-101)



1.50 PS P
 1.75 P
 3.00 CR P

① Pistons to be replaced in Engine Sets only ① Kolben nur in Motorsätzen zu ersetzen ① Piston à remplacer dans jeu moteur ① Pistones de repuesto para juegos de motores solamente ① Il pistone può essere rimpiazzato solamente completo

② A = 31.900, D = 62.200

81.00					30
AZV	4cyl.	1968cc	100kW (136PS)	Diesel Turbo Intercooled	TD17027
BKD	4cyl.	1968cc	103kW (140PS)	Diesel Turbo Intercooled	TD17025
BLB	4cyl.	1968cc	103kW (140PS)	Diesel Turbo Intercooled	TD17377
BMN	4cyl.	1968cc	125kW (170PS)	Diesel Turbo Intercooled	TD18991
BNA	4cyl.	1968cc	100kW (136PS)	Diesel Turbo Intercooled	TD18009
BRD	4cyl.	1968cc	125kW (170PS)	Diesel Turbo Intercooled	TD20402
BRE	4cyl.	1968cc	103kW (140PS)	Diesel Turbo Intercooled	TD18029
BRF	4cyl.	1968cc	100kW (136PS)	Diesel Turbo Intercooled	TD18748
BUY	4cyl.	1968cc	120kW (163PS)	Diesel Turbo Intercooled	TD20403
BVA	4cyl.	1968cc	120kW (163PS)	Diesel Turbo Intercooled	TD20529
BVF	4cyl.	1968cc	93kW (126PS)	Diesel Turbo Intercooled	TD20497
BVG	4cyl.	1968cc	89kW (121PS)	Diesel Turbo Intercooled	TD20496

A3 2.0 TDI	05/03→03/13	A4 B7 2.0 TDI 16V	11/04→06/08
------------	-------------	-------------------	-------------





A3 2.0 TDI 16V A4 B7 2.0 TDI	05/03→03/13 11/04→06/08	A6 C6 2.0 TDI	07/04→08/11
---------------------------------	----------------------------	---------------	-------------

87-139500-00 STD ①
87-139507-00 0.50mm ②

08-139500-00 STD
08-139507-00 0.50mm

A 45.83
B- 17.80
BØ 38.00
D 68.80
26x66



1.75 CK P
2.00 P
3.00 CR P



(07901J)

AK KK NB RT TP

① Bowl capacity 23.75cm³
② A = 45.550, D = 68.550

① Volumen der Kolbenmulde 23.75cm³

① Volume de la cavité du piston 23.75cm³

① Vol. cavidad pistón 23.75cm³

① Volume camera pistone 23.75cm³

81.00

31

BMM	4cyl.	1968cc	103kW (140PS)	Diesel	Turbo Intercooled	TD18203
BPW	4cyl.	1968cc	103kW (140PS)	Diesel	Turbo Intercooled	TD18010
BRC	4cyl.	1968cc	100kW (136PS)	Diesel	Turbo Intercooled	TD20672

A3 2.0 TDI	06/05→06/08	A4 B7 2.0 TDI	11/04→03/09
------------	-------------	---------------	-------------

87-139500-10 STD ① ②
87-139507-10 0.50mm ① ③

08-139500-00 STD
08-139507-00 0.50mm

A 45.83
B- 17.50
BØ 38.00
C 0.70
D 68.80
26x66



1.75 CK P
2.00 P
3.00 CR P



(07901D833)

AK KK NB RT TP

87-139500-20 STD ② ④
87-139507-20 0.50mm ③ ④

08-139500-00 STD
08-139507-00 0.50mm

A 45.83
B- 17.50
BØ 38.00
C 0.70
D 68.80
26x66



1.75 CK P
2.00 P
3.00 CR P



(07901D834)

AK KK NB RT TP

① To cylinder 1 & 2
② Bowl capacity 23.30cm³
③ A = 45.550
④ To cylinder 3 & 4

① an Zylinder 1 & 2
② Volumen der Kolbenmulde 23.30cm³
④ an Zylinder 3 & 4

① sur cylindre 1 & 2
② Volume de la cavité du piston 23.30cm³
④ sur cylindre 3 & 4

① en el cilindro 1 & 2
② Vol. cavidad pistón 23.30cm³
④ en el cilindro 3 & 4

① a cilindro 1 & 2
② Volume camera pistone 23.30cm³
④ a cilindro 3 & 4

81.00

32

CAGA	4cyl.	1968cc	105kW (143PS)	Diesel	Turbo Intercooled	TD20597
CAGB	4cyl.	1968cc	100kW (136PS)	Diesel	Turbo Intercooled	TD20598
CAGC	4cyl.	1968cc	88kW (120PS)	Diesel	Turbo Intercooled	TD21118
CAHA	4cyl.	1968cc	125kW (170PS)	Diesel	Turbo Intercooled	TD20602
CAHB	4cyl.	1968cc	120kW (163PS)	Diesel	Turbo Intercooled	TD20864
CBAA	4cyl.	1968cc	100kW (136PS)	Diesel	Turbo Intercooled	TD20825
CBAB	4cyl.	1968cc	103kW (140PS)	Diesel	Turbo Intercooled	TD20828





CBBB	4cyl.	1968cc	125kW (170PS)	Diesel	Turbo Intercooled	TD20939
A3 2.0 TDI			05/03→05/13	A6 C6 2.0 TDI		07/04→08/11
A3 2.0 TDI 16V			05/03→03/13	Q5 2.0 TDI		11/08→05/17
A4 B8 2.0 TDI			11/07→05/16	TT 2.0 TDI		06/08→06/14
A5 2.0 TDI			08/08→01/17			

87-432300-00 STD
 87-432307-00 0.50mm

08-432300-00 STD
 08-432307-00 0.50mm

A 45.80
 B- 12.70
 BØ 50.88
 D 68.80
 26x66



1.75 GDC P
 2.00 P
 3.00 CR P



(07901G202)

AK KK NB RT TP

OE 03L 107 065G, Gen 1 engine only

OE 03L 107 065G, nur für Motoren der Generation 1

N°OE 03L 107 065G, uniquement pour Moteur de génération 1

OE 03L 107 065G, Generación 1 solo motor

Solo motore Generation 1

08-432300-00 OE: 03L198151A

81.00 **33**

CFFA	4cyl.	1968cc	100kW (136PS)	Diesel	Turbo Intercooled	TD23858
CFFB	4cyl.	1968cc	103kW (140PS)	Diesel	Turbo Intercooled	TD23859
CFGB	4cyl.	1968cc	125kW (170PS)	Diesel	Turbo Intercooled	TD23857
CFGC	4cyl.	1968cc	130kW (177PS)	Diesel	Turbo Intercooled	TD25727
CFGD	4cyl.	1968cc	120kW (163PS)	Diesel	Turbo Intercooled	TD25728
CFHB	4cyl.	1968cc	100kW (136PS)	Diesel	Turbo Intercooled	TD25662
CFHD	4cyl.	1968cc	105kW (143PS)	Diesel	Turbo Intercooled	TD24939
CGLA	4cyl.	1968cc	120kW (163PS)	Diesel	Turbo Intercooled	TD24406
CGLB	4cyl.	1968cc	125kW (170PS)	Diesel	Turbo Intercooled	TD24948
CGLC	4cyl.	1968cc	130kW (177PS)	Diesel	Turbo Intercooled	TD24870
CGLD	4cyl.	1968cc	120kW (163PS)	Diesel	Turbo Intercooled	TD24943
CGLE	4cyl.	1968cc	100kW (136PS)	Diesel	Turbo Intercooled	TD26329
CJCA	4cyl.	1968cc	105kW (143PS)	Diesel	Turbo Intercooled	TD24949
CJCB	4cyl.	1968cc	100kW (136PS)	Diesel	Turbo Intercooled	TD24941
CJCC	4cyl.	1968cc	88kW (120PS)	Diesel	Turbo Intercooled	TD26713
CJCD	4cyl.	1968cc	110kW (150PS)	Diesel	Turbo Intercooled	TD27985
CLJA	4cyl.	1968cc	103kW (140PS)	Diesel	Turbo Intercooled	TD23938
CLLB	4cyl.	1968cc	130kW (177PS)	Diesel	Turbo Intercooled	TD25729
CMFA	4cyl.	1968cc	105kW (143PS)	Diesel	Turbo Intercooled	TD26714
CMFB	4cyl.	1968cc	110kW (150PS)	Diesel	Turbo Intercooled	TD28002
CMGA	4cyl.	1968cc	125kW (170PS)	Diesel	Turbo Intercooled	TD25767
CMGB	4cyl.	1968cc	130kW (177PS)	Diesel	Turbo Intercooled	TD24871

A1 2.0 TDI			09/11→04/15	A6 C7 2.0 TDI		03/11→09/18
A3 2.0 TDI			05/03→05/13	Q3 2.0 TDI		06/11→10/18
A3 2.0 TDI 16V			05/03→03/13	Q5 2.0 TDI		11/08→05/17
A4 B8 2.0 TDI			11/07→05/16	TT 2.0 TDI		06/08→06/14
A5 2.0 TDI			08/08→01/17			





87-432300-10 STD 1 2
87-432307-10 0.50mm 1 2

A 45.80
B- 13.10
BØ 50.88
D 68.80
26x66



(07901G220)
AK KK NB RT TP

08-432300-10 STD 3 4
08-432307-10 0.50mm 3 4

1.75 GDC P
2.00 MO P
3.00 CR P



1 OE 03L 107 065S, Gen 2 engine only

1 OE 03L 107 065S, nur für Motoren der Generation 2

1 N°OE 03L 107 065S, uniquement pour Moteur de génération 2

1 OE 03L 107 065G, Generación 2 solo motor

1 Solo motore Generation 2

2 A = 45.500

3 Only fit to pistons equivalent to OE 03L 107065 AG, 03L 1070 65 S

3 Nur für OE Kolben 03L 107065 AG und 03L 107065 S

3 Seulement adapté aux pistons équivalents à OE 03L 107065 AG et 03L 107065 S

3 Cabido solamente a los pistones equivalentes a OE 03L 107065 AG y 03L 107065 S

3 Adattato soltanto ai pistoni equivalenti OE a 03L 107065 AG e 03L 107065 S

4 08-432300-10 OE: 03L198151C

81.00 34

CRBC	4cyl.	1968cc	110kW (150PS)	Diesel	Turbo Intercooled	TD26724
CRBD	4cyl.	1968cc	100kW (136PS)	Diesel	Turbo Intercooled	TD28036
CRFA	4cyl.	1968cc	81kW (110PS)	Diesel	Turbo Intercooled	TD26722
CRFC	4cyl.	1968cc	105kW (143PS)	Diesel	Turbo Intercooled	TD26723
CRLB	4cyl.	1968cc	110kW (150PS)	Diesel	Turbo Intercooled	TD26725
CRLC	4cyl.	1968cc	100kW (136PS)	Diesel	Turbo Intercooled	TD29305
CRUA	4cyl.	1968cc	110kW (150PS)	Diesel	Turbo Intercooled	TD29213
CSUA	4cyl.	1968cc	110kW (150PS)	Diesel	Turbo Intercooled	TD30651
CSUB	4cyl.	1968cc	100kW (136PS)	Diesel	Turbo Intercooled	TD30650
CSUD	4cyl.	1968cc	110kW (150PS)	Diesel	Turbo Intercooled	TD29836
CSUE	4cyl.	1968cc	100kW (136PS)	Diesel	Turbo Intercooled	TD30797
CUVC	4cyl.	1968cc	110kW (150PS)	Diesel	Turbo Intercooled	TD30258
CUVD	4cyl.	1968cc	88kW (120PS)	Diesel	Turbo Intercooled	TD30929
CZHA	4cyl.	1968cc	110kW (150PS)	Diesel	Turbo Intercooled	TD32031
DEJA (Euro 6)	4cyl.	1968cc	110kW (150PS)	Diesel	Turbo Intercooled	TD33133
DEJB (Euro 6)	4cyl.	1968cc	81kW (110PS)	Diesel	Turbo Intercooled	TD33132
DEUA	4cyl.	1968cc	110kW (150PS)	Diesel	Turbo Intercooled	TD32032
DEUB	4cyl.	1968cc	100kW (136PS)	Diesel	Turbo Intercooled	TD32035
DEUC	4cyl.	1968cc	90kW (122PS)	Diesel	Turbo Intercooled	TD32838

A3 2.0 TDI	04/12→	A5 35 TDI	01/17→02/20
A4 B8 2.0 TDI	11/07→05/16	A6 C7 2.0 TDI	01/12→09/18
A4 B9 2.0 TDI	05/15→11/19	Q2 2.0 TDI	11/16→10/20
A4 B9 30 TDI	05/16→11/19	Q3 2.0 TDI	11/14→10/18
A4 B9 35 TDI	08/15→	Q5 2.0 TDI	08/09→11/20
A5 2.0 TDI	09/09→02/20		

87-447500-10 STD 1

A 45.80
B- 12.90
BØ 50.88
D 68.80
26x66



AK KK NB RT TP

08-447500-00 STD 2 3
08-447507-00 0.50mm 2 3

1.75 GDC P
2.00 P
2.00 CR NT



1 OE 04L 107 065A
2 EA288 Engine family
3 2014>

1 OE 04L 107 065A
2 EA288 Motorenfamilie

1 OE 04L 107 065A
2 Famille de moteurs EA288

1 OE 04L 107 065A
2 Familia de motores EA288

1 OE 04L 107 065A
2 Motori famiglia EA288



82.50 **35**

ABK	4cyl.	1984cc	85kW (115PS)	Petrol	TD233
80 B4 2.0 E			09/91→01/96	CABRIOLET B3 2.0 E	01/93→07/98
100 C4 2.0 E			12/90→07/94	COUPE B3 2.0	05/89→12/96
A6 C4 2.0			06/94→12/97		

87-501800-20 STD
87-501807-20 0.50mm

A 30.90
 B- 5.70
 BØ 64.00
 B+ 0.90
 D 51.80
 21x55
 (08241B-103)

08-501800-00 STD
08-501807-00 0.50mm

1.20 PS
 1.50 P
 2.00 CR P

A = 30.600, D = 51.500

82.50 **36**

AWA	4cyl.	1984cc	110kW (150PS)	Petrol	TD17035
AXW	4cyl.	1984cc	110kW (150PS)	Petrol	TD16872
BLR	4cyl.	1984cc	110kW (150PS)	Petrol	TD18199
BLX	4cyl.	1984cc	110kW (150PS)	Petrol	TD17404
BLY	4cyl.	1984cc	110kW (150PS)	Petrol	TD17405
BMB	4cyl.	1984cc	110kW (150PS)	Petrol	TD17406
BVY	4cyl.	1984cc	110kW (150PS)	Petrol	TD18200
BVZ	4cyl.	1984cc	110kW (150PS)	Petrol	TD18201
A3 2.0 FSI			05/03→06/08	A4 B6 2.0 FSI	07/02→12/04

87-435100-00 STD

A 29.38
 B+ 12.46
 D 59.85
 19x44
 (08240B301)
 TP

08-435100-10 STD

1.20 PVD NT
 1.50
 2.00 CR

Elastoval®

Steel Stahl Acier Acero Acciaio

82.50 **37**

AXX	4cyl.	1984cc	147kW (200PS)	Petrol	Turbo Intercooled	TD17450
BGB	4cyl.	1984cc	147kW (200PS)	Petrol	Turbo Intercooled	TD18008
BPG	4cyl.	1984cc	147kW (200PS)	Petrol	Turbo Intercooled	TD20530
BPJ	4cyl.	1984cc	125kW (170PS)	Petrol	Turbo Intercooled	TD18486
BPY	4cyl.	1984cc	147kW (200PS)	Petrol	Turbo Intercooled	TD20704
BUL	4cyl.	1984cc	162kW (220PS)	Petrol	Turbo Intercooled	TD18484
BWA	4cyl.	1984cc	147kW (200PS)	Petrol	Turbo Intercooled	TD19199
BWE	4cyl.	1984cc	147kW (200PS)	Petrol	Turbo Intercooled	TD18968
BWT	4cyl.	1984cc	147-149kW (200-203PS)	Petrol	Turbo Intercooled	TD19705
BYK	4cyl.	1984cc	125kW (170PS)	Petrol	Turbo Intercooled	TD20404
A3 2.0 TFSI			09/04→03/13	A6 C6 2.0 TFSI		06/05→08/11
A4 B7 2.0 TFSI			11/04→03/09	TT 2.0 TFSI		08/06→06/10
A4 B7 2.0 TFSI 16V			01/06→03/09			





87-438500-00 STD
87-438507-00 0.50mm

A 29.50
B- 6.10
BØ 49.52
C 1.36
C 1.36
D 50.50
20x59



08-438500-00 STD
08-438507-00 0.50mm

1.20 PVD
1.50 P
2.00 CR P

AK RT TP

Steel Stahl Acier Acero Acciaio

82.50 **38**

CAEA	4cyl.	1984cc	132kW (180PS)	Petrol	Turbo Intercooled	TD21115
CAEB	4cyl.	1984cc	155-164kW (211-223PS)	Petrol	Turbo Intercooled	TD21116
CAED	4cyl.	1984cc	162kW (220PS)	Petrol	Turbo Intercooled	TD28001
CAWB	4cyl.	1984cc	147kW (200PS)	Petrol	Turbo Intercooled	TD20714
CCTA	4cyl.	1984cc	147-149kW (200-203PS)	Petrol	Turbo Intercooled	TD22666
CCZA	4cyl.	1984cc	147kW (200PS)	Petrol	Turbo Intercooled	TD22170
CCZC	4cyl.	1984cc	125kW (170PS)	Petrol	Turbo Intercooled	TD25726
CDNB	4cyl.	1984cc	132kW (180PS)	Petrol	Turbo Intercooled	TD20936
CDNC	4cyl.	1984cc	155kW (211PS)	Petrol	Turbo Intercooled	TD20937
CESA	4cyl.	1984cc	155kW (211PS)	Petrol	Turbo Intercooled	TD24753
CETA	4cyl.	1984cc	155kW (211PS)	Petrol	Turbo Intercooled	TD24754
CFKA	4cyl.	1984cc	132kW (180PS)	Petrol	Turbo Intercooled	TD23856
CHJA	4cyl.	1984cc	155kW (211PS)	Petrol	Turbo Intercooled	TD25428
CPMA	4cyl.	1984cc	155kW (211PS)	Petrol	Turbo Intercooled	TD26715
CPMB	4cyl.	1984cc	162kW (220PS)	Petrol	Turbo Intercooled	TD26891
CPSA	4cyl.	1984cc	155kW (211PS)	Petrol	Turbo Intercooled	TD25730

A3 2.0 TFSI	09/04→05/13	A8 D4 2.0 TFSI hybrid	02/12→11/15
A4 B8 2.0 TFSI	06/08→05/16	Q3 2.0 TFSI	06/11→10/18
A4 B8 2.0 TFSI flexible fuel	11/09→12/15	Q5 2.0 TFSI	11/08→05/17
A5 2.0 TFSI	06/08→01/17	TT 2.0 TFSI	08/06→06/14
A6 C7 2.0 TFSI	03/11→09/18		

87-443800-10 STD

A 29.60
B- 6.15
BØ 49.60
C 3.60
D 50.00
23x51



08-443800-00 STD
08-443807-00 0.50mm

1.20 PVD NT
1.20 P
2.00 CR P

RT



Steel Stahl Acier Acero Acciaio

82.50 **39**

CDA A	4cyl.	1798cc	118kW (160PS)	Petrol	Turbo Intercooled	TD20938
CDHA	4cyl.	1798cc	88kW (120PS)	Petrol	Turbo Intercooled	TD21113
CDHB	4cyl.	1798cc	118kW (160PS)	Petrol	Turbo Intercooled	TD21114

A3 1.8 TFSI	11/06→05/13	A5 1.8 TFSI	05/09→03/12
A4 B8 1.8 TFSI	11/07→12/15	TT 1.8 TFSI	06/08→06/14





87-443800-00 STD
87-443807-00 0.50mm

08-443800-00 STD
08-443807-00 0.50mm

- A 29.85
- B- 4.70
- B- 5.65
- B+ 5.65
- C 2.00
- D 56.00
- 23x54



- 1.20 PVD NT
- 1.20 P
- 2.00 CR P



RT TP

Steel Stahl Acier Acero Acciaio

82.50					40
AAH	V6cyl.	2771cc	128kW (174PS)	Petrol	TD224
AEJ	V6cyl.	2771cc	120-128kW (163-174PS)	Petrol	TD9541
AFC	V6cyl.	2771cc	120-128kW (163-174PS)	Petrol	TD246
80 B4 2.8			09/91→01/96	A8 D2 2.8	03/94→03/96
100 C4 2.8 E			12/90→07/94	CABRIOLET B3 2.8	11/92→08/00
A4 B5 2.8			01/95→07/97	COUPE B3 2.8	08/91→12/96
A6 C4 2.8			06/94→12/97		

87-501800-10 STD
87-501807-10 0.50mm

08-501800-00 STD
08-501807-00 0.50mm

- A 30.80
 - B- 4.25
 - BØ 61.00
 - B+ 0.70
 - D 52.50
 - 21x55
- (08245-103)



- 1.20 PS
- 1.50 P
- 2.00 CR P

Pistons to be replaced in Engine Sets only Kolben nur in Motorsätzen zu ersetzen Piston à remplacer dans jeu moteur Pistones de repuesto para juegos de motores solamente Il pistone può essere rimpiazzato solamente completo

A = 30.500, D = 52.200

83.00					41
ASB	V6cyl.	2967cc	171kW (233PS)	Diesel Turbo Intercooled	TD17336
BKN	V6cyl.	2967cc	150kW (204PS)	Diesel Turbo Intercooled	TD18027
BMK	V6cyl.	2967cc	165kW (225PS)	Diesel Turbo Intercooled	TD17845
BNG	V6cyl.	2967cc	155kW (211PS)	Diesel Turbo Intercooled	TD17337
BUG	V6cyl.	2967cc	171kW (233PS)	Diesel Turbo Intercooled	TD18996
BUN	V6cyl.	2967cc	155kW (211PS)	Diesel Turbo Intercooled	TD19881
A4 B7 3.0 TDI			11/04→03/09	A8 D3 3.0 TDI	08/03→07/10
A6 C6 3.0 TDI			05/04→08/11	Q7 3.0 TDI	03/06→05/10

87-434300-00 STD
87-434307-00 0.50mm

08-434300-00 STD
08-434307-00 0.50mm

- A 46.30
- B- 15.10
- BØ 45.00
- D 70.80
- 30x68



- 2.00 CK
- 2.00
- 3.00 CR

AK KK RT



CCM

x



9

10 H	Petrol	1098	4	64.56	1
12CC	Petrol	1275	4	70.62	5
12 HA85AA	Petrol	1275	4	70.62	4
18HH	Petrol	1798	4	80.25	8
18HL	Petrol	1798	4	80.25	8
19 J	Diesel	2495	4	90.47	11
22 UA	Diesel	2178	4	82.55	9
A+ SERIES (12 A)	Petrol	1275	4	70.62	5
A+ SERIES (12 H)	Petrol	1275	4	70.62	6
A+ SERIES (12 H999)	Petrol	1275	4	70.62	5
A+ SERIES (12 HA)	Petrol	1275	4	70.62	5
A+ SERIES (12 HC)	Petrol	1275	4	70.62	5
A+ SERIES (12 HE)	Petrol	1275	4	70.62	6
A+ SERIES (12 HL)	Petrol	1275	4	70.62	6
A + SERIES (99H)	Petrol	998	4	64.56	2
A+ SERIES (99H)	Petrol	998	4	64.56	2
A+ SERIES (99H)	Petrol	998	4	64.56	3
A+ SERIES (99H)	Petrol	998	4	64.56	2
A/A+ SERIES (99H)	Petrol	998	4	64.56	3
A SERIES (10A)	Petrol	1098	4	64.56	1
A SERIES (10C)	Petrol	1098	4	64.56	1
A SERIES (10G)	Petrol	1098	4	64.56	1
A SERIES (10H)	Petrol	1098	4	64.56	1
A SERIES (10V)	Petrol	1098	4	64.56	1
A SERIES (12H)	Petrol	1275	4	70.62	5
A SERIES (12H)	Petrol	1275	4	70.62	6
A SERIES (12 H)	Petrol	1275	4	70.62	5
A SERIES (12 H)	Petrol	1275	4	70.62	6
A SERIES (12 HB)	Petrol	1275	4	70.62	5
A SERIES (12 HD)	Petrol	1275	4	70.62	5
A SERIES (12 L)	Petrol	1275	4	70.62	6
A SERIES (Overbored to 1380)	Petrol	1380	4	73.50	7
B SERIES (18 G)	Petrol	1798	4	80.25	8
B SERIES (18 H)	Petrol	1798	4	80.25	8
B SERIES (18 V, 18 C)	Petrol	1798	4	80.25	8
C SERIES	Petrol	2912	6	83.32	10

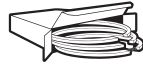

64.56					1
10 H	4cyl.	1098cc	33-36kW (45-49PS)	Petrol	TD32226
A SERIES (10A)	4cyl.	1098cc	33-36kW (45-49PS)	Petrol	MP2941-1
A SERIES (10C)	4cyl.	1098cc	33-36kW (45-49PS)	Petrol	MP2941
A SERIES (10G)	4cyl.	1098cc	33-36kW (45-49PS)	Petrol	MP78
A SERIES (10H)	4cyl.	1098cc	33-38kW (45-52PS)	Petrol	TD384
A SERIES (10V)	4cyl.	1098cc	33-36kW (45-49PS)	Petrol	MP78-1
1000-Series MK II MK II			10/62→09/67	ALLEGRO I 1.1	05/73→12/81
1100 1.1			01/66→12/69	MINI 1100	01/76→08/81
1100 Countryman			01/62→12/74	MINI II 1100	01/76→08/81
1100 MklI			01/62→12/74	MINOR 1000	01/63→12/69
A35 6cwt.			01/62→12/67	MINOR 1100	01/63→12/69
A40 MklII 1100			01/62→12/67		

87-522307-00 .020 ①
 87-522309-00 .030 ①
 87-522314-00 .060 ①

08-522300-10 STD
 08-522307-10 .020
 08-522309-10 .030
 08-522314-10 .060

A 30.33
 B- 5.28
 D 50.05
 16x56

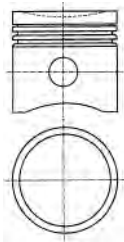

1.60  CR P
 1.58  P
 1.58  P
 3.17  P

① Pistons to be replaced in Engine Sets only ① Kolben nur in Motorsätzen zu ersetzen ① Piston à remplacer dans jeu moteur ① Pistones de repuesto para juegos de motores solamente ① Il pistone può essere rimpiazzato solamente completo

64.56					2
A + SERIES (99H)	4cyl.	998cc	35kW (48PS)	Petrol	TD383
A+ SERIES (99H)	4cyl.	998cc	31kW (42PS)	Petrol	TD5472
A+ SERIES (99H)	4cyl.	998cc	30kW (41PS)	Petrol	TD5471
A+ SERIES (99H)	4cyl.	998cc	31kW (42PS)	Petrol	TD5474
METRO I 1.0			10/80→04/90	MINI II 1000 Mayfair	08/82→06/93

87-524307-10 .020 ① ②
 87-524311-10 .040 ① ②
 87-524314-10 .060 ① ②

08-524300-10 STD
 08-524307-10 .020
 08-524311-10 .040
 08-524314-10 .060

A 33.86
 D 53.79
 16x51



1.50  CK P
 1.50  P
 3.00  P

① Pistons to be replaced in Engine Sets only ① Kolben nur in Motorsätzen zu ersetzen ① Piston à remplacer dans jeu moteur ① Pistones de repuesto para juegos de motores solamente ① Il pistone può essere rimpiazzato solamente completo
 ② Piston pin press fit in conrod ② Kolbenbolzen in Pleuel eingepreßt ② Axe serré sur bielle ② Bulón del pistón montado a presión en la biela ② Spinotto inserto a spinta nella biella

64.56					3
A+ SERIES (99H)	4cyl.	998cc	31kW (42PS)	Petrol	TD5473
A/A+ SERIES (99H)	4cyl.	998cc	28-41kW (38-56PS)	Petrol	TD4215
ALLEGRO I 1.0			01/80→10/83	MINI I Cooper	01/61→12/67
METRO I 1.0			10/80→04/90	MINI II 1000	10/67→09/84
MINI 1000			01/69→08/81	MINI II 1000 Mayfair	08/82→06/93
MINI I 1000			01/69→12/80		



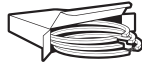

87-522400-00 STD ① ②

A 34.09
B- 4.93
D 65.77
 16x56



08-522400-00 STD
08-522407-00 .020

1.58  P
 1.58  P
 4.00  CR P

- ① Pistons to be replaced in Engine Sets only ① Kolben nur in Motorsätzen zu ersetzen ① Piston à remplacer dans jeu moteur ① Pistones de repuesto para juegos de motores solamente ① Il pistone può essere rimpiazzato solamente completo
 ② Pin retained by circlips ② Bolzen mit Sicherungsclips gehalten ② Axe retenu par circlips ② Bulón retenido por anillos de retención ② Spinotto trattenuto da fermi

70.62						4
12 HA85AA	4cyl.	1275cc	66kW (90PS)	Petrol	Turbo	TD5469
METRO I 1.3 Turbo		10/83→04/90				

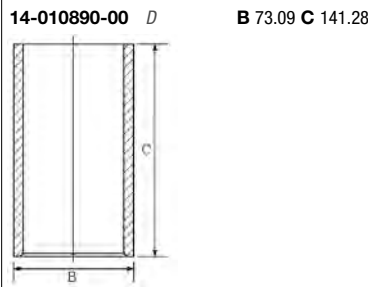

70.62						5
12CC	4cyl.	1275cc	48kW (65PS)	Petrol	TD22427	
A+ SERIES (12 A)	4cyl.	1275cc	52kW (71PS)	Petrol	TD13429	
A+ SERIES (12 H999)	4cyl.	1275cc	46kW (63PS)	Petrol	TD5458	
A+ SERIES (12 HA)	4cyl.	1275cc	51kW (69PS)	Petrol	TD5468	
A+ SERIES (12 HC)	4cyl.	1275cc	46-55kW (63-75PS)	Petrol	TD5459	
A SERIES (12H)	4cyl.	1275cc	43-48kW (58-65PS)	Petrol	TD21773	
A SERIES (12 H)	4cyl.	1275cc	53-69kW (72-94PS)	Petrol	TD22493	
A SERIES (12 HB)	4cyl.	1275cc		Petrol	MP85	
A SERIES (12 HD)	4cyl.	1275cc		Petrol	MP85-1	
1275 GT			01/67→12/73	METRO I 1.3	10/80→04/90	
1300			01/71→12/74	MINI 1.3	01/85→	
1300 1.3			01/68→10/71	MINI Cooper	01/90→	
1300 1.3 TC			10/71→10/73	MINI Cooper S	01/64→12/71	
1300 GT			01/67→12/73	MINI COOPER S	01/64→12/71	
MAESTRO 1.3			03/83→12/92	MINI II 1.3	09/69→09/80	
MARINA 1300			01/72→12/80	SPRITE MK.IV 1.3	03/66→10/71	
METRO 1.3			01/82→12/88			





87-524100-00 STD

87-524107-00 .020

87-524111-00 .040

87-524114-00 .060

08-524100-00 STD

08-524107-00 .020

08-524111-00 .040

08-524114-00 .060

14-010890-00 D B 73.09 C 141.28

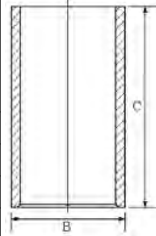

A 38.74

B- 5.74

D 58.74

21x56



1.50 NT

1.50 P

3.00 P

Pistons to be replaced in Engine Sets only Kolben nur in Motorsätzen zu ersetzen Piston à remplacer dans jeu moteur Pistones de repuesto para juegos de motores solamente Il pistone può essere rimpiazzato solamente completo

70.62					6
A+ SERIES (12 H)	4cyl.	1275cc	44kW (60PS)	Petrol	TD5470
A+ SERIES (12 HE)	4cyl.	1275cc	50-55kW (68-75PS)	Petrol	TD22435
A+ SERIES (12 HL)	4cyl.	1275cc	46-51kW (63-69PS)	Petrol	TD16446
A SERIES (12H)	4cyl.	1275cc	41-42kW (56-57PS)	Petrol	TD22166
A SERIES (12 H)	4cyl.	1275cc	39-70kW (53-95PS)	Petrol	TD381
A SERIES (12 L)	4cyl.	1275cc	43kW (58PS)	Petrol	TD22494
ALLEGRO I 1.3			02/73→12/84	METRO I 1.3 L, HLE, S	10/80→04/90
AMERICA 1.3			09/67→12/72	MINI II 1.3	04/74→12/91
MAESTRO 1.3			03/83→12/92	MINI II 1275 GT	10/69→08/80
MAESTRO 1.3 LS			03/83→08/90	MINOR 1.3	09/64→12/71
MARINA II 1.3			11/75→10/80	MONTEGO 1.3	04/84→10/88
METRO I 1.3			10/80→04/90		

87-521700-00 STD

87-521707-00 .020

87-521711-00 .040

87-521714-00 .060

08-521700-00 STD

08-521707-00 .020

08-521711-00 .040

08-521714-00 .060

14-010890-00 D B 73.09 C 141.28

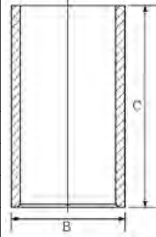

A 37.24

B- 5.74

D 57.24

21x56



1.48 P

1.48 P

4.00 P

Pistons to be replaced in Engine Sets only Kolben nur in Motorsätzen zu ersetzen Piston à remplacer dans jeu moteur Pistones de repuesto para juegos de motores solamente Il pistone può essere rimpiazzato solamente completo

73.50					7
A SERIES (Overbored to 1380)	4cyl.	1380cc		Petrol	MP1180
METRO 1275				MINI 1275	

87-526600-00 STD

08-526600-00 STD

A 37.78

B- 6.21

D 58.36

21x64



1.50 CR P

1.50 P

4.00 CR P

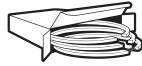

80.25

8

18HH	4cyl.	1798cc	71kW (97PS)	Petrol	TD21772
18HL	4cyl.	1798cc	64kW (87PS)	Petrol	TD21771
B SERIES (18 G)	4cyl.	1798cc		Petrol	MP2953-1
B SERIES (18 H)	4cyl.	1798cc	60kW (82PS)	Petrol	TD5478
B SERIES (18 V, 18 C)	4cyl.	1798cc		Petrol	MP2951-1
18/85 1.8			08/69→12/72	1800 MkII	01/68→12/71
18/85 1.8 S			01/70→12/72	1800S MkII	01/71→12/72
1800 1.8			01/73→12/75	MARINA 1.8	01/71→12/78
1800 Mk II/III			01/64→12/75	PRINCESS 1800 HL	04/76→09/78

87-521907-00 .020 ① ②
87-521911-00 .040 ① ②

A 42.11
B- 3.76
D 61.06
 21x57

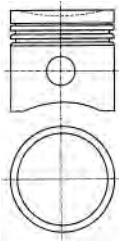

1.58
 1.58
 1.58
 3.96



87-525900-00 STD ③
87-525907-00 .020 ③
87-525909-00 .030 ③
87-525911-00 .040 ③
87-525914-00 .060 ③

A 42.16
B- 3.76
BØ 64.50
D 61.11
 21x57

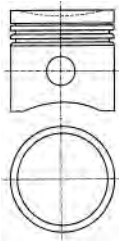

08-525907-00 .020
08-525909-00 .030
08-525911-00 .040
08-525914-00 .060

1.59 P
 1.59 P
 4.00 P



- ① Short skirt design
- ② Pin retained by circlips
- ③ Piston pin press fit in conrod

- ① Kurzschaftausführung
- ② Bolzen mit Sicherungsclips gehalten
- ③ Kolbenbolzen in Pleuel eingepreßt

- ① A jupe courte
- ② Axe retenu par circlips
- ③ Axe serré sur bielle

- ① Diseño de falda corta
- ② Bulón retenido por anillos de retención
- ③ Bulón del pistón montado a presión en la biela
- ① A mantello corto
- ② Spinotto trattenuto da fermi
- ③ Spinotto inserto a spinta nella biella

82.55

9

22 UA	4cyl.	2178cc		Diesel	MP101
GYPSY SERIES 2 1-1.5 ton			01/60→12/68	TAXICAB FX3D/FX4	01/55→12/71

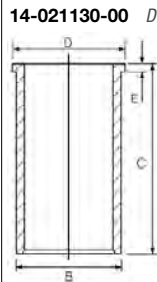

14-021130-00 D
B 86.59 **C** 193.68 **D** 89.61 **E** 4.70



83.32

10

C SERIES	6cyl.	2912cc		Petrol	MP1186
3 LITRE			01/68→12/72		









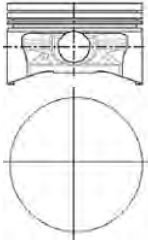

87-530100-00 STD 
 87-530107-00 .020 
 87-530109-00 .030 

08-530100-00 STD
 08-530107-00 .020
 08-530109-00 .030

A 47.73
 D 87.31
 22x72





1.98  P
 1.98  P
 1.98  P
 4.74  P
 4.76  P

 Pistons to be replaced in Engine Sets only

 Kolben nur in Motorsätzen zu ersetzen

 Piston à remplacer dans jeu moteur

 Pistones de repuesto para juegos de motores solamente

 Il pistone può essere rimpiazzato solamente completo

90.47

11

19 J 4cyl. 2495cc Diesel Turbo MP3829

METROPOLITAN Taxi 01/83 →

14-010920-00 D B 94.50 C 191.36

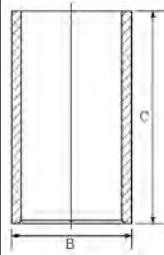

14-024710-00 D B 94.52 C 191.36 D 99.70 E 4.76

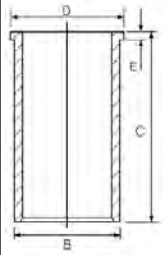

Motorverzeichnis • Index de moteur • Índice de Motor
 Indeks silnika • Модель Двигателя • دليل المحرك

ENGINE INDEX



CCM

x



9

4.108	Diesel	1760	4	79.38	4
13 S	Petrol	1297	4	75.00	1
14 NV	Petrol	1389	4	77.60	2
16 D	Diesel	1598	4	80.00	5
16 DA	Diesel	1598	4	80.00	5
16 SV	Petrol	1598	4	79.00	3
21 D	Diesel	2068	4	88.00	7
23 D	Diesel	2260	4	92.00	9
220	Diesel	3614	4	103.19	10
330	Diesel	5420	6	103.19	10
C190	Diesel	1951	4	86.00	6
C223	Diesel	2238	4	88.00	8



75.00 **1**

13 S 4cyl. **1297cc** **42-55kW** (57-75PS) **Petrol** **TD410**

ASTRAMAX 1.3 12/86 → 06/90 ASTRA VAN 1.3 09/84 → 09/89

87-306307-00 0.50mm
87-306311-00 1.00mm

08-306300-00 STD
08-306307-00 0.50mm
08-306311-00 1.00mm

A 35.80
B- 3.60
C 5.30
C 5.30
D 62.40
 20x65



1.50 CR P
 1.50 P
 4.00 CR P

Pistons to be replaced in Engine Sets only Kolben nur in Motorsätzen zu ersetzen Piston à remplacer dans jeu moteur Pistones de repuesto para juegos de motores solamente Il pistone può essere rimpiazzato solamente completo

77.60 **2**

14 NV 4cyl. **1389cc** **44-56kW** (60-76PS) **Petrol** **TD411**

ASTRAMAX 1.4 09/89 → 06/90 ASTRA VAN 1.4 09/89 → 08/91

87-307100-20 STD
87-307107-20 0.50mm

08-307100-00 STD
08-307107-00 0.50mm

A 32.10
B- 3.40
D 52.50
 18x55



1.50 CR P
 1.50 P
 3.00 CR

Steel Stahl Acier Acero Acciaio

79.00 **3**

16 SV 4cyl. **1598cc** **60-66kW** (82-90PS) **Petrol** **TD413**

ASTRA VAN 1.6 09/84 → 08/91

87-306900-10 STD
87-306907-10 0.50mm

08-306900-00 STD
08-306907-00 0.50mm

A 28.00
B- 1.60
BØ 59.00
B+ 0.40
D 48.40
 18x55



1.20 CR
 1.50 P
 3.00 CR

Steel Stahl Acier Acero Acciaio

79.38 **4**

4.108 4cyl. **1760cc** **Diesel** **MP1346**

CF220 01/69 → 12/76 CF250 01/69 → 12/76



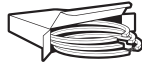

14-010900-00 *D*

B 82.63 C 165.10

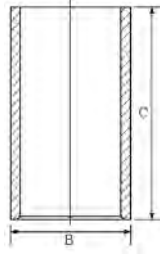

80.00

5

16 D	4cyl.	1598cc	39-40kW (53-54PS)	Diesel	TD412
16 DA	4cyl.	1598cc	40-42kW (54-57PS)	Diesel	TD26851
ASTRAMAX 1.6 D			09/85→08/88	ASTRA VAN 1.6 D	07/82→08/89

14-023520-00 *D*

B 83.00 C 143.50 D 84.90 E 4.50

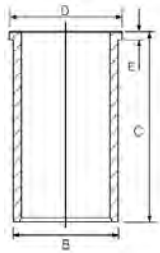

86.00

6

C190	4cyl.	1951cc	34-36kW (46-49PS)	Diesel	TD32778
KB 2.0 D			05/72→12/88		

14-021180-00 *D*

B 90.13 C 178.50 D 94.00 E 4.00

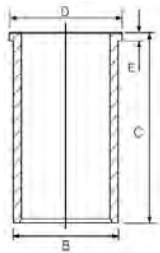

88.00

7

21 D	4cyl.	2068cc	44kW (60PS)	Diesel	TD9935
BLITZ 2.1 D			09/81→10/87	CF 2.1 D	10/69→04/84

14-024160-00 *D*

B 92.00 C 172.00 D 93.90 E 4.55

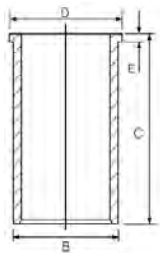

88.00

8

C223	4cyl.	2238cc	39-54kW (53-73PS)	Diesel	TD34465
-------------	-------	---------------	--------------------------	---------------	----------------





BRAVA 2.2 D 12/88 → 02/90

14-021190-00 D **B 92.13 C 163.50 D 95.00 E 4.00**

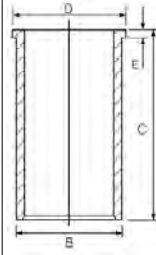

92.00 **9**

23 D **TD418**
 4cyl. **2260cc** **46-52kW (63-71PS)** **Diesel**

BLITZ 2.3 D 08/69 → 12/88
 01/73 → 10/87 CF 2.3 D

14-024100-00 D **B 95.00 C 172.00 D 97.00 E 4.70**

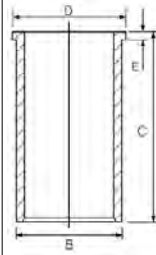

103.19 **10**

220 **TD6483**
 4cyl. **3614cc** **48-52kW (65-71PS)** **Diesel**

330 **TD6485**
 6cyl. **5420cc** **72-99kW (98-135PS)** **Diesel Turbo**

TRUCK

87-126300-10 STD
87-126311-10 .040

A 71.50
B- 21.46
BØ 52.70
D 118.24
35x88



08-126307-10 .020
08-126311-10 .040

2.38 **P**
 2.38 **P**
 2.38 **P**
 4.74 **P**
 4.74 **P**

14-021140-00 D **B 108.05 C 216.15 D 111.04 E 4.76**

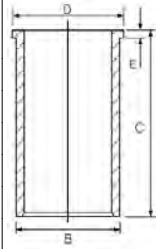

1 Push fit cast iron liner to replace original steel liner

1 Ausdrückbare Laufbuchse aus Gusseisen als Ersatz der original Stahlbuchse

1 Chemise fonte à emménagement gras remplaçant la chemise acie d'origine.

1 Ajustar a presión la camisa de hierro fundido para reemplaza camisa original de acero

1 Cilindri in ghisa piantati a pressione, in sostituzione di q in acciaio

CCM
x

9

B37 C15 A (Euro 6)	Diesel	1496	3	84.00	7
B47 C20 B	Diesel	1995	4	84.00	8
B47 D20 B	Diesel	1995	4	84.00	8
M43 B18 (184E2)	Petrol	1796	4	84.00	3
M47 D20 (204D1)	Diesel	1951	4	84.00	9
M47 D20 (204D4)	Diesel	1995	4	84.00	10
M47 TUD20 (Euro 4)	Diesel	1995	4	84.00	11
M54 B22 (226S1)	Petrol	2171	6	80.00	2
M54 B25 (256S3)	Petrol	2494	6	84.00	6
M54 B25 (256S5)	Petrol	2494	6	84.00	6
M57 D30 (306D1)	Diesel	2926	6	84.00	13
M57 D30 (306D2)	Diesel	2993	6	84.00	14
M57 D30 (306D3)	Diesel	2993	6	84.00	14
N13 B16 A	Petrol	1598	4	77.00	1
N20 B20 A	Petrol	1997	4	84.00	4
N20 B20 B	Petrol	1997	4	84.00	5
N47 D20 A	Diesel	1995	4	84.00	12
N47 D20 B	Diesel	1995	4	84.00	12
N57 306 D2 (Euro 4)	Diesel	2993	6	84.00	11



77.00 **1**

N13 B16 A 4cyl. **1598cc** **75-130kW** (102-177PS) **Petrol** **Turbo Intercooled** **TD26581**

1 (F20) 114 i	07/12→02/15	1 (F21) 118 i	07/12→
1 (F20) 116 i	07/11→02/15	1 (F21) 120 i	03/15→
1 (F20) 118 i	07/11→06/15	3 (F30, F80) 316 i	07/12→08/16
1 (F20) 120 i	03/15→06/16	3 (F30, F80) 320 i	11/12→06/16
1 (F21) 114 i	12/11→	3 (F31) 316 i	03/13→06/15
1 (F21) 116 i	12/11→		

87-444800-50 STD
87-444807-50 STD

08-444800-10 STD
08-444807-10 0.50mm

- A 28.50
- B- 3.50
- B+ 2.70
- C 3.50
- C 3.50
- D 51.20
- 20x48



- 1.20 PVD P
- 1.50 P
- 2.00 NT

HA RT TP

Steel Stahl Acier Acero Acciaio

80.00 **2**

M54 B22 (226S1) 6cyl. **2171cc** **120-125kW** (163-170PS) **Petrol** **TD28215**

3 (E46) 320 Ci	01/00→12/07	5 (E60) 520 i	07/03→03/10
3 (E46) 320 i	09/00→02/05	Z3 (E36) 2.2 i	08/00→01/03
5 (E39) 520 i	09/00→12/03	Z4 (E85) 2.2 i	10/03→10/05

87-422200-10 STD
87-422207-10 0.50mm

08-422200-00 STD
08-422207-00 0.50mm

- A 29.60
- C 2.90
- C 3.40
- D 49.50
- 22x51



- 1.20 CK
- 1.50 P
- 2.00 P

Steel Stahl Acier Acero Acciaio

84.00 **3**

M43 B18 (184E2) 4cyl. **1796cc** **83-85kW** (113-116PS) **Petrol** **TD28372**

3 (E36) 318 i	09/93→11/99	5 (E34) 518 i	05/94→07/96
5 (E34) 518 g	02/96→07/96	Z3 (E36) 1.8 i	10/95→10/98

87-704200-10 STD
87-704207-10 0.50mm

08-704200-00 STD
08-704207-00 0.50mm

- A 31.65
- B- 3.03
- BØ 70.30
- D 57.65
- 22x54



- 1.50 CR P
- 1.50 P
- 2.00 CR

Steel Stahl Acier Acero Acciaio

84.00 **4**

N20 B20 A 4cyl. **1997cc** **110-205kW** (150-279PS) **Petrol** **Turbo Intercooled** **TD25629**





1 (F20) 125 i	03/12→11/17	5 (F10) 520 i	09/11→10/16
1 (F21) 125 i	12/11→	5 (F10) 528 i	09/11→10/16
2 (F22, F87) 220 i	10/13→	5 (F11) 520 i	10/10→02/17
2 (F22, F87) 228 i	01/14→	5 (F11) 528 i	09/11→02/17
2 (F23) 220 i	04/14→07/16	X1 (E84) 20 i	09/11→06/15
2 (F23) 228 i	11/14→	X1 (E84) 28 i	03/11→06/15
3 (F30, F80) 320 i	03/12→10/18	X3 (F25) 20 i	10/11→08/17
3 (F30, F80) 328 i	11/11→10/18	X3 (F25) 28 i	04/12→08/17
3 (F30, F80) 328i	11/11→06/15	X4 (F26) 20 i	04/14→03/18
3 (F31) 328 i	07/12→06/16	X4 (F26) 28 i	04/14→03/18
3 (F34) 320 i	11/12→06/16	X5 (F15, F85) 28 i	06/15→07/18
3 (F34) 328 i	03/13→06/16	X5 (F15, F85) 40e	08/15→07/18
4 (F32, F82) 420 i	11/13→02/17	X6 (F16, F86) 28 i	06/15→07/19
4 (F32, F82) 428 i	07/13→02/17	Z4 (E89) 18 i	04/13→08/16
4 (F33, F83) 428 i	11/13→02/17	Z4 (E89) 20 i	09/11→08/16
4 (F36) 428 i	03/14→06/16	Z4 (E89) 28 i	09/11→08/16
5 (F07) 528 i	07/13→02/17		

87-434600-00 STD

A 32.40
B- 3.72
BØ 52.50
C 3.09
C 3.16
D 51.10
22x51

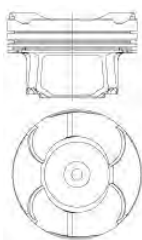

(0843EA408)

TP

ECOTOUGH

Steel

Stahl

Acier

Acero

Acciaio

08-434600-00 STD

1.20 NT
1.50 P
2.00 NT



84.00

5

N20 B20 B	4cyl.	1997cc	120-135kW (163-184PS)	Petrol	Turbo Intercooled	TD26908
2 (F22, F87) 220 i			10/13→	4 (F32, F82) 420 i		11/13→02/17
2 (F23) 220 i			04/14→07/16	4 (F33, F83) 420 i		07/14→02/16
3 (F30, F80) 320 i			03/12→10/18	4 (F36) 420 i		03/14→02/17
3 (F31) 320 i			11/12→06/15	5 (F10) 520 i		09/11→10/16
3 (F34) 320 i			11/12→06/16	5 (F11) 520 i		10/10→02/17

87-434600-10 STD

A 32.40
B- 4.20
BØ 47.63
C 3.16
C 3.09
D 51.10
22x48

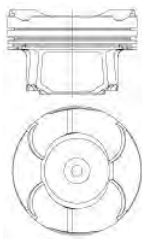

(0843EB308)

TP

ECOTOUGH

Steel

Stahl

Acier

Acero

Acciaio

84.00

6

M54 B25 (256S3)	6cyl.	2494cc	141kW (192PS)	Petrol	TD28216
M54 B25 (256S5)	6cyl.	2494cc	137-141kW (186-192PS)	Petrol	TD28217





3 (E46) 325 Ci	09/00→12/06	5 (E61) 525 i	06/04→12/10
3 (E46) 325 i	09/00→04/05	X3 (E83) 2.5 i	01/04→12/06
3 (E46) 325 xi	09/00→04/05	Z3 (E36) 2.5 i	10/00→08/02
3 (E46) 325 ti	04/01→12/04	Z4 (E85) 2.5 i	12/02→12/05
5 (E39) 525 i	09/00→05/04	Z4 (E86) 2.5 i	11/06→04/08
5 (E60) 525 i	07/03→12/09		

87-425300-00 STD
87-425307-00 0.50mm

A 27.60
C 2.60
D 47.60
 22x56



08-425300-00 STD
08-425307-00 0.50mm

1.20 NT 1
1.50 P
2.00 P

1 Steel 1 Stahl 1 Acier 1 Acero 1 Acciaio

84.00

7

B37 C15 A (Euro 6)	3cyl.	1496cc	70-85kW (95-116PS)	Diesel	Turbo Intercooled	TD29839
1 (F40) 116 d			07/19→	2 (F46) 214 d		07/15→02/18
2 (F44) 216 d			03/20→	2 (F46) 216 d		08/14→
2 (F45) 214 d			07/14→02/18	X1 (F48) 16 d		11/14→
2 (F45) 216 d			03/14→	X2 (F39) 16 d		11/18→

87-449700-30 STD 1
87-449707-30 STD

A 42.50
B- 14.15
BØ 47.50
D 65.50
 26x60



08-449700-10 STD

1.50 GDC 2
1.50 P
2.00 CR

1 BMW B47 UL TUE1 - OE 8580462.06 1 BMW B47 UL TUE1 - OE 8580462.06 1 BMW B47 UL TUE1 - OE 8580462.06 1 BMW B47 UL TUE1 - OE 8580462.06 1 BMW B47 UL TUE1 - OE 8580462.06
2 Steel 2 Stahl 2 Acier 2 Acero 2 Acciaio

84.00

8

B47 C20 B	4cyl.	1995cc	100-170kW (136-231PS)	Diesel	Turbo Intercooled	TD31366
B47 D20 B	4cyl.	1995cc	85-170kW (116-231PS)	Diesel	Turbo Intercooled	TD30401
1 (F20) 125 d			03/12→06/19	4 (G22, G82) 420 d Mild-Hybrid		07/20→
1 (F21) 125 d			03/15→	4 (G23, G83) 420 d Mild-Hybrid		11/20→
1 (F40) 118 d			07/19→	4 (G26) 420 d Mild-Hybrid		07/21→
1 (F40) 120 d			07/19→	5 (G30, F90) 518 d		07/18→06/20
2 (F22, F87) 225 d			07/15→	5 (G30, F90) 518 d Mild-Hybrid		07/20→
2 (F23) 225 d			07/15→	5 (G30, F90) 520 d		09/16→
2 (F44) 218 d			11/19→	5 (G30, F90) 520 d Mild-Hybrid		11/19→
2 (F44) 220 d			11/19→	5 (G30, F90) 523 D XDRIVE MILD-HYBRID		07/20→
2 (F45) 218 d			11/13→	5 (G30, F90) 525 d		07/17→06/19
2 (F45) 220 d			03/14→	5 (G31) 518 d		07/18→06/20
2 (F46) 218 d			07/14→	5 (G31) 518 d Mild-Hybrid		07/20→
2 (F46) 220 d			07/14→	5 (G31) 520 d		03/17→
2 (G42) 220 d Mild-Hybrid			08/21→	5 (G31) 520 d Mild-Hybrid		11/19→
2 (U06) 218d			11/21→	5 (G31) 525 d		07/17→06/19
2 (U06) 223 d			07/22→	6 (G32) 620 d		07/18→06/20
3 (F30, F80) 325 d			03/16→02/18	6 (G32) 620 d Mild-Hybrid		07/20→
3 (F31) 325 d			03/16→02/18	7 (G11, G12) 725 d, Ld		07/16→02/19





3 (F34) 325 d	07/16→02/18	X1 (F48) 18 d	11/14→
3 (G20, G80, G28) 316 d	03/20→	X1 (F48) 20 d	07/15→
3 (G20, G80, G28) 316 d Mild-Hybrid	08/20→	X1 (F48) 25 d	11/14→
3 (G20, G80, G28) 318 d	03/19→03/20	X2 (F39) 18 d	03/18→
3 (G20, G80, G28) 318 d Mild-Hybrid	04/20→	X2 (F39) 20 d	11/17→
3 (G20, G80, G28) 320 d	11/18→	X2 (F39) 25 d	11/17→
3 (G20, G80, G28) 320 d Mild-Hybrid	03/20→	X3 (G01) 18 d	04/18→
3 (G21) 320 d	07/19→02/20	X3 (G01) 20 d	08/17→
3 (G21) 320 d Mild-Hybrid	03/20→	X3 (G01, F97) 18 d	04/18→06/20
3 (G21, G81) 316 d	11/20→	X3 (G01, F97) 18 d Mild-Hybrid	07/20→
3 (G21, G81) 316 d Mild-Hybrid	07/20→	X3 (G01, F97) 20 d	08/17→03/20
3 (G21, G81) 318 d	11/19→07/20	X3 (G01, F97) 20 d Mild-Hybrid	04/20→
3 (G21, G81) 318 d Mild-Hybrid	08/20→	X3 (G01, F97) 25 d	04/18→
3 (G21, G81) 320 d	07/19→02/20	X4 (G02, F98) 20 d	04/18→03/20
3 (G21, G81) 320 d Mild-Hybrid	03/20→	X4 (G02, F98) 20 d Mild-Hybrid	04/20→
4 (F32, F82) 425 d	03/16→10/17	X4 (G02, F98) 25 d	04/18→
4 (F33, F83) 425 d	03/16→02/18	X5 (F15, F85) 25 d	12/13→07/18
4 (F36) 425 d	03/16→02/18	X5 (G05, F95) 25 d	08/19→

87-449700-30 STD ①
87-449707-30 STD

A 42.50
B- 14.15
BØ 47.50
D 65.50
 26x60

AK KK RT TP

08-449700-10 STD

1.50 GDC ②
 1.50 P
 2.00 CR

87-449700-40 STD
87-449707-40 STD

A 42.50
B- 14.15
BØ 47.50
D 65.50
 26x60

AK KK RT TP

08-449700-10 STD

1.50 GDC ②
 1.50 P
 2.00 CR

① BMW B47 UL TUE1 - OE 8580462.06 ① BMW B47 UL TUE1 - OE 8580462.06 ① BMW B47 UL TUE1 - OE 8580462.06 ① BMW B47 UL TUE1 - OE 8580462.06 ① BMW B47 UL TUE1 - OE 8580462.06
 ② Steel ② Stahl ② Acier ② Acero ② Acciaio

84.00						9
M47 D20 (204D1)	4cyl.	1951cc	85-100kW (116-136PS)	Diesel	Turbo Intercooled	TD28374
3 (E46) 318 d			09/01→03/03	5 (E39) 520 d		02/00→09/03
3 (E46) 320 d			02/98→09/01			

87-114400-00 STD
87-114405-00 0.25mm
 →02/01

A 47.00
B- 15.05
BØ 41.70
C 1.30
D 71.00
 30x66
 (08452-L160)



KK RT

08-114400-00 STD ①
08-114405-00 0.25mm

3.00 CK P
 2.00 P
 3.00 CR P





87-114400-30 STD 
87-114405-30 0.25mm 
 03/01→



A 44.87
B- 13.50
BØ 46.90
C 1.40
D 70.62
 30x66

(08408-F105)
AK KK NB RT



08-114400-00 STD 
08-114405-00 0.25mm

3.00  CK P
 2.00  P
 3.00  CR P

 OE 1125 224 7383
 Euro 3

84.00 **10**

M47 D20 (204D4)	4cyl.	1995cc	85-120kW (116-163PS)	Diesel	Turbo Intercooled	TD27472
1 (E87) 118 d			06/04→02/07	3 (E90) 318 d		03/05→08/07
1 (E87) 120 d			06/04→06/11	3 (E90) 320 d		12/04→10/11
3 (E46) 318 d			03/03→02/05	3 (E91) 318 d		09/05→08/07
3 (E46) 318 td			03/03→02/05	3 (E91) 320 d		12/04→06/12
3 (E46) 320 Cd			11/03→12/07	5 (E60) 520 d		09/05→12/09
3 (E46) 320 d			09/01→05/05	5 (E61) 520 d		04/05→05/10
3 (E46) 320 td			09/01→02/05	X3 (E83) 2.0 d		09/04→08/07

87-114400-60 STD
87-114405-60 0.25mm
 06/06→01/08

A 44.87
B- 14.50
BØ 47.50
C 1.48
D 70.37
 30x66

(08487 E103)
AK KK RT TP



08-114400-40 STD
08-114405-40 0.25mm

3.00  CK P
 2.00  P
 2.00  CK P

87-114400-65 STD 
 01/08→

A 44.87
B- 14.50
BØ 47.50
C 1.48
D 1.36
D 70.37
 30x68

(0840C-105)
AK KK RT TP



08-114400-45 STD 

3.00  CK P
 2.00  P
 2.00  CR P



 Bowl capacity 24.43cm³
 OE 1125 779 8882

 Volumen der Kolbenmulde 24.43cm³

 Volume de la cavité du piston 24.43cm³

 Vol. cavidad pistón 24.43cm³

 Volume camera pistone 24.43cm³

84.00 **11**

M47 TUD20 (Euro 4)	4cyl.	1995cc		Diesel	Turbo Intercooled	MP19230
N57 306 D2 (Euro 4)	6cyl.	2993cc	160kW (218PS)	Diesel	Turbo Intercooled	TD18307
320 d			01/01→			





87-114400-40 STD 1
87-114405-40 0.25mm 1
 →06/06

A 44.87
B- 14.50
BØ 47.50
C 1.00
D 70.62
 30x66



(08408U105)
AK KK NB RT

08-114400-40 STD
08-114405-40 0.25mm

3.00  CK P
 2.00  P
 2.00  CK P

1 Only for engines with parallel conrod 1 Nur für Motoren mit Parallelpleuel 1 Uniquement pour les moteurs à bielle parallèle 1 Solo para motores con cabezal de biela paralela 1 Solo per motori con biella parallela

84.00 **12**

N47 D20 A	4cyl.	1995cc	66-145kW (90-197PS)	Diesel	Turbo Intercooled	TD19922
N47 D20 B	4cyl.	1995cc	150kW (204PS)	Diesel	Turbo Intercooled	TD20845
1 (E81) 116 d			11/08→12/11	1 (E88) 123 d		09/08→12/13
1 (E81) 118 d			09/06→12/11	3 (E90) 318 d		02/07→10/11
1 (E81) 120 d			03/07→12/11	3 (E90) 320 d		12/04→10/11
1 (E81) 123 d			03/07→12/11	3 (E91) 318 d		07/07→06/12
1 (E82) 120 d			09/07→10/13	3 (E91) 320 d		06/05→06/12
1 (E82) 123 d			10/07→10/13	3 (E92) 320 d		09/06→06/13
1 (E87) 116 d			03/09→06/11	3 (E93) 320 d		09/07→02/10
1 (E87) 118 d			03/07→06/11	5 (E60) 520 d		09/05→12/09
1 (E87) 120 d			06/04→06/11	5 (E61) 520 d		04/05→05/10
1 (E87) 123 d			03/07→06/11	X3 (E83) 2.0 sd		09/07→08/08
1 (E88) 118 d			09/08→12/13	X3 (E83) 2.0 d		09/08→08/10
1 (E88) 120 d			03/08→12/13			

87-432200-00 STD
87-432205-00 0.25mm
87-432207-00 0.50mm

A 47.00
B- 14.50
BØ 47.50
D 73.00
 32x63



(0840BB)
AK KK RT TP

08-432200-00 STD 1
08-432205-00 0.25mm
08-432207-00 0.50mm

1.75  GDC P
 1.75  P
 2.00  CR



1 OE 1125 781 2636

84.00 **13**

M57 D30 (306D1)	6cyl.	2926cc	135-142kW (184-193PS)	Diesel	Turbo Intercooled	TD27992
3 (E46) 330 d			10/99→02/05	7 (E38) 730 d		08/98→11/01
3 (E46) 330 xd			01/00→03/03	X5 (E53) 3.0 d		04/01→09/03
5 (E39) 530 d			08/98→05/04			





87-114400-10 STD
87-114405-10 0.25mm

A 47.00
B- 16.55
BØ 41.60
C 1.40
D 71.10
 30x66

(08452-L165)
AK KK RT



08-114400-00 STD
08-114405-00 0.25mm

3.00 CK P
 2.00 P
 3.00 CR P

OE 1125 224 7383

84.00

14

M57 D30 (306D2)	6cyl.	2993cc	150-160kW (204-218PS)	Diesel	Turbo Intercooled	TD27248
M57 D30 (306D3)	6cyl.	2993cc	135-173kW (184-235PS)	Diesel	Turbo Intercooled	TD27267
3 (E46) 330 Cd			03/03→12/07	5 (E60) 530 d		09/02→12/09
3 (E46) 330 d			03/03→02/05	5 (E60) 530 xd		02/05→08/07
3 (E46) 330 xd			08/02→05/05	5 (E61) 525 d		03/07→05/10
3 (E90) 325 d			09/06→02/10	5 (E61) 525 xd		09/07→09/08
3 (E90) 330 d			09/05→12/11	5 (E61) 530 d		03/04→05/10
3 (E90) 330 xd			09/05→08/08	5 (E61) 530 xd		02/05→08/07
3 (E91) 325 d			09/06→06/12	7 (E65, E66, E67) 730 d		06/02→08/08
3 (E91) 330 d			12/04→05/12	7 (E65, E66, E67) 730 Ld		07/05→08/08
3 (E91) 330 xd			09/05→06/12	X3 (E83) 3.0 d		01/04→08/08
3 (E92) 325 d			02/07→02/10	X3 (E83) 30 d		09/08→08/10
3 (E92) 330 d			03/06→08/08	X5 (E53) 3.0 d		10/03→09/06
3 (E92) 330 xd			03/06→08/08	X5 (E70) 3.0 3.0d		02/07→09/08
3 (E93) 325 d			03/07→12/10	X5 (E70) 3.0 d		12/06→09/08
3 (E93) 330 d			03/07→12/13	X5 (E70) 30 d		10/08→07/13
5 (E60) 525 d			01/07→03/10	X6 (E71, E72) 30 d		04/08→03/10
5 (E60) 525 xd			11/06→08/07			

87-114400-40 STD
87-114405-40 0.25mm
 →06/06

A 44.87
B- 14.50
BØ 47.50
C 1.00
D 70.62
 30x66

(08408U105)
AK KK NB RT



08-114400-40 STD
08-114405-40 0.25mm

3.00 CK P
 2.00 P
 2.00 CK P





87-114400-60 STD
87-114405-60 0.25mm
 06/06→

A 44.87
B- 14.50
BØ 47.50
C 1.48
D 70.37
 30x66



(08487 E103)
AK KK RT TP

08-114400-40 STD
08-114405-40 0.25mm

3.00  CK P
 2.00  P
 2.00  CK P

 Only for engines with parallel conrod

 Nur für Motoren mit Parallelpleuel

 Uniquement pour les moteurs à bielle parallèle

 Solo para motores con cabezal de biela paralela

 Solo per motori con biella parallela

ENGINE INDEX

Motorverzeichnis • Index de moteur • Índice de Motor
 Indeks silnika • Модель Двигателя • دليل المحرك

CCM
x

9

A 12 XEL	Petrol	1229	4	73.40	5
A 12 XER (Euro 5)	Petrol	1229	4	73.40	5
A 14 NET (Euro 5)	Petrol	1364	4	72.50	3
A 14 XER	Petrol	1398	4	73.40	6
B 14 NET (Euro 6)	Petrol	1364	4	72.50	3
B 16 DTH	Diesel	1598	4	79.70	15
C 14 NZ	Petrol	1389	4	77.60	8
C 16 SE	Petrol	1598	4	79.00	10
C 16 XE (Ecotec)	Petrol	1598	4	79.00	11
C 20 NE	Petrol	1998	4	86.00	20
LDE (Euro 5)	Petrol	1598	4	79.00	12
LSF (Euro 4)	Diesel	1248	4	69.60	1
LUJ (Euro 5)	Petrol	1364	4	72.50	3
LUV (Ecotec)	Petrol	1364	4	72.50	3
RHZ	Diesel	1997	4	85.00	19
X 14 YEH	Petrol	1389	4	77.60	8
X 16 XE (Ecotec)	Petrol	1598	4	79.00	11
X 18 XE1	Petrol	1796	4	80.50	16
Y 17 DT	Diesel	1686	4	79.00	14
Y 17 DTL	Diesel	1686	4	79.00	14
Y 20 DTH	Diesel	1995	4	84.00	18
Z 12 XE (Ecotec)	Petrol	1199	4	72.50	4
Z 13 DT	Diesel	1248	4	69.60	2
Z 14 XE (Ecotec)	Petrol	1389	4	77.60	9
Z 14 XEP (Ecotec)	Petrol	1364	4	73.40	7
Z 16 SE	Petrol	1598	4	79.00	13
Z 16 XE (Ecotec)	Petrol	1598	4	79.00	13
Z 18 XE (Ecotec)	Petrol	1796	4	80.50	16
Z 18 XEL (Ecotec)	Petrol	1796	4	80.50	16
Z 20 DM	Diesel	1991	4	83.00	17
Z 20 DMH	Diesel	1991	4	83.00	17
Z 20 S	Diesel	1991	4	83.00	17
Z 20 S1	Diesel	1991	4	83.00	17
Z 22 SE (Ecotec)	Petrol	2198	4	86.00	21



69.60 1

LSF (Euro 4) 4cyl. **1248cc** **70kW (95PS)** Diesel Turbo Intercooled **TD26189**

AVEO 1.3 D 07/11→12/15

87-435700-00 STD ①
87-435706-00 0.40mm ①

A 40.43
B- 12.70
BØ 37.00
C 1.15
C 0.90
D 62.43
E 23x57



AK KK RT

08-435700-00 STD
08-435706-00 0.40mm

1.50 GDC P
1.50 P
2.00 CR P



① With Stop/Start Technology ② Für Fahrzeuge mit StartStop Funktion ③ Pour véhicules équipé du start & stop ④ Para vehiculos con función start-stop ⑤ Per veicoli con la funzione Start-Stop

69.60 2

Z 13 DT 4cyl. **1248cc** **55kW (75PS)** Diesel Turbo Intercooled **TD32912**

87-137600-00 STD
87-137606-00 0.40mm

A 40.43
B- 12.40
BØ 37.00
C 1.00
C 1.20
D 63.43
E 23x57



AK RT TP

08-137600-00 STD
08-137606-00 0.40mm

2.00 CK P
1.50 P
2.00 P

① CarboGlide® ② Steel ③ Stahl ④ Acier ⑤ Acero ⑥ Acciaio

72.50 3

A 14 NET (Euro 5) 4cyl. **1364cc** **103kW (140PS)** Petrol Turbo Intercooled **TD29268**

B 14 NET (Euro 6) 4cyl. **1364cc** **103kW (140PS)** Petrol Turbo Intercooled **TD29269**

LUJ (Euro 5) 4cyl. **1364cc** **103kW (140PS)** Petrol Turbo Intercooled **TD26818**

LUV (Ecotec) 4cyl. **1364cc** **103kW (140PS)** Petrol Turbo Intercooled **TD28519**

AVEO 1.4 09/11→ ORLANDO 1.4 06/12→
AVEO 1.4 Turbo 08/13→ TRAX 1.4 12/12→
CRUZE 1.4 09/10→ TRAX 1.4 LPG 04/13→

87-437400-10 STD
87-437407-10 0.50mm

A 25.87
B- 2.90
BØ 54.78
C 2.10
C 1.87
D 44.18
E 18x48



HA RT TP

08-437400-00 STD ①
08-437407-00 0.50mm ①

1.20 DLC NT ②
1.20 P
2.00 NT ②

72.50 4

Z 12 XE (Ecotec) 4cyl. **1199cc** **57-63kW (77-86PS)** Petrol **TD26428**

SAIL 1.2 01/12→ SPARK 1.2 12/09→





87-102700-10 STD
87-102707-10 0.50mm

08-102700-00 STD
08-102707-00 0.50mm

A 24.00
C 1.25
D 45.00
 18x51



1.20 NT
1.50 P
2.00 CR

Steel Stahl Acier Acero Acciaio

73.40					5
A 12 XEL	4cyl.	1229cc	51kW (69PS)	Petrol	TD25432
A 12 XER (Euro 5)	4cyl.	1229cc	63kW (86PS)	Petrol	TD26084
AVEO 1.3					03/11→

87-429500-40 STD
87-429507-40 0.50mm

08-429500-00 STD
08-429507-00 0.50mm

A 26.90
BØ 54.60
B+ 0.65
C 1.35
C 3.95
D 48.55
 18x53



1.20 NT
1.20 P
2.00 CR

HA TP

Steel Stahl Acier Acero Acciaio

73.40					6
A 14 XER	4cyl.	1398cc	74kW (101PS)	Petrol	TD25431
AVEO 1.4					07/11→

87-429500-30 STD
87-429507-30 0.50mm

08-429500-00 STD
08-429507-00 0.50mm

A 25.80
B- 1.60
C 1.90
C 3.83
D 46.80
 18x53



1.20 NT
1.20 P
2.00 CR

TP

Steel Stahl Acier Acero Acciaio

73.40					7
Z 14 XEP (Ecotec)	4cyl.	1364cc	66kW (90PS)	Petrol	TD36787





87-429500-00 STD ①
87-429507-00 0.50mm ①

08-429500-00 STD
08-429507-00 0.50mm

A 23.00
B- 1.25
BØ 53.50
C 1.33
C 1.35
D 44.00
 18x49



1.20  NT ②
 1.20  P
 2.00  CR ②

① Elastoval®
 ② Steel

② Stahl

② Acier

② Acero

② Acciaio

77.60

8

C 14 NZ	4cyl.	1389cc	44-66kW (60-90PS)	Petrol	TD19861
X 14 YE	4cyl.	1389cc	68-77kW (92-105PS)	Petrol	TD26868

MONTANA 1.4

01/11→

87-307100-20 STD
87-307107-20 0.50mm

08-307100-00 STD
08-307107-00 0.50mm

A 32.10
B- 3.40
D 52.50
 18x55



1.50  CR P
 1.50  P
 3.00  CR ①

① Steel

① Stahl

① Acier

① Acero

① Acciaio

77.60

9

Z 14 XE (Ecotec)	4cyl.	1389cc	66kW (90PS)	Petrol	TD28086
CHEVY 1.4			06/95→09/06	CORSA 1.4	09/01→09/06

87-144200-00 STD
87-144207-00 0.50mm

08-144200-00 STD
08-144207-00 0.50mm

A 31.30
B+ 2.45
D 55.75
 18x55



1.20  NT ①
 1.50  P
 2.00  CR ①

① Steel

① Stahl

① Acier

① Acero

① Acciaio

79.00

10

C 16 SE	4cyl.	1598cc	74kW (100PS)	Petrol	TD28280
TIGRA 1.6			08/97→12/99		





87-306900-10 STD
87-306907-10 0.50mm

08-306900-00 STD
08-306907-00 0.50mm

A 28.00
B- 1.60
BØ 59.00
B+ 0.40
D 48.40
 18x55



1.20 CR
1.50 P
3.00 CR

Steel Stahl Acier Acero Acciaio

79.00					11
C 16 XE (Ecotec)	4cyl.	1598cc	80kW (109PS)	Petrol	TD23209
X 16 XE (Ecotec)	4cyl.	1598cc	74-80kW (102-108PS)	Petrol	TD19866

87-307800-10 STD
87-307807-10 0.50mm

08-307800-00 STD
08-307807-00 0.50mm
08-307811-00 1.00mm

A 28.00
B- 0.80
BØ 60.20
C 1.90
C 2.15
D 48.00
 18x55



1.20 CR
1.50 P
2.50 CR

Steel Stahl Acier Acero Acciaio

79.00					12
LDE (Euro 5)	4cyl.	1598cc	83-91kW (113-124PS)	Petrol	TD26188
AVEO 1.6			03/11→	TRAX 1.6	12/12→
CRUZE 1.6			05/09→		

87-435300-00 STD
87-435307-00 0.50mm

08-435300-00 STD
08-435307-00 0.50mm

A 26.70
BØ 52.96
B+ 1.20
C 1.90
C 2.70
D 49.90
 19x46



1.20 NT
1.20 P
2.00 NT

Steel Stahl Acier Acero Acciaio

79.00					13
Z 16 SE	4cyl.	1598cc	62-67kW (84-91PS)	Petrol	TD19869
Z 16 XE (Ecotec)	4cyl.	1598cc	74kW (101PS)	Petrol	TD27250
CHEVY 1.6			08/02→	CORSA 1.6	08/01→12/11





87-125600-00 STD
87-125607-00 0.50mm

08-125600-00 STD
08-125607-00 0.50mm

A 27.20
D 50.20
 18x55



1.20  NT 
 1.50  P
 2.50  CR 

 Steel

 Stahl

 Acier

 Acero

 Acciaio

79.00

14

Y 17 DT	4cyl.	1686cc	55kW (75PS)	Diesel	Turbo Intercooled	TD19867
Y 17 DTL	4cyl.	1686cc	44-48kW (60-65PS)	Diesel	Turbo Intercooled	TD32256
ASTRA 1.7 Di			08/00→08/03	CORSA 1.7 DTi		08/01→12/11

87-307600-40 STD
87-307607-40 0.50mm

08-307600-00 STD
08-307607-00 0.50mm

A 39.75
B- 14.00
BØ 38.70
C 1.10
D 84.00
 27x64



2.00  CR P
 1.50  CR P
 3.00  CR P

RT

79.70

15

B 16 DTH	4cyl.	1598cc	99kW (135PS)	Diesel	Turbo Intercooled	TD35144
CRUZE CDTi			11/15→	ORLANDO 1.6 D		01/13→
ORLANDO 1.5 D			01/13→			

87-430300-00 STD
87-430307-00 STD

08-430300-00 STD
08-430307-00 0.50mm

A 45.80
B- 13.50
BØ 45.00
C 1.10
C 1.00
D 70.80
 29x63



1.50  CK
 1.50  P
 2.00  CR

AK KK RT TP

80.50

16

X 18 XE1	4cyl.	1796cc	90kW (122PS)	Petrol	TD32954
Z 18 XE (Ecotec)	4cyl.	1796cc	90-92kW (122-125PS)	Petrol	TD21857
Z 18 XEL (Ecotec)	4cyl.	1796cc	81kW (110PS)	Petrol	TD32261
ASTRA 1.8			08/02→06/05	NIVA 1.8	01/07→12/09
CRUZE 1.8				VIVA 1.8	09/03→03/08
Flex 1.8			08/02→12/10	ZAFIRA 1.8	07/00→06/05
MERIVA 1.8			05/03→05/08		





87-141200-00 STD
87-141207-00 0.50mm

08-141200-00 STD
08-141207-00 0.50mm

A 24.10
D 44.70
 18x55



1.20 NT
1.20 P
2.00 CR

TP

Steel Stahl Acier Acero Acciaio

83.00

17

Z 20 DM	4cyl.	1991cc	89kW (121PS)	Diesel	Turbo Intercooled	TD21856
Z 20 DMH	4cyl.	1991cc	92-110kW (125-150PS)	Diesel	Turbo Intercooled	TD28118
Z 20 S	4cyl.	1991cc	89-110kW (121-150PS)	Diesel	Turbo Intercooled	TD21855
Z 20 S1	4cyl.	1991cc	92-110kW (125-150PS)	Diesel	Turbo Intercooled	TD24614

CAPTIVA 2.0 TD	10/06→	NUBIRA 2.0 D	01/05→
CRUZE 2.0 CDI	05/09→	OPTRA 2.0 TCDI	01/07→
EPICA 2.0 D	01/07→		

87-879200-00 STD
87-879207-00 0.50mm

08-879200-00 STD
08-879207-00 0.50mm

A 46.35
B- 13.95
BØ 46.70
D 72.35
 28x67



2.00 CR P
2.00 P
3.00 NT

AK KK RT TP

Steel Stahl Acier Acero Acciaio

84.00

18

Y 20 DTH	4cyl.	1995cc	74kW (101PS)	Diesel	Turbo Intercooled	TD19868
-----------------	-------	---------------	---------------------	---------------	--------------------------	----------------

ASTRA 2.0 DTI	08/02→		
---------------	--------	--	--

87-126000-00 STD
87-126007-00 0.50mm

08-126000-00 STD
08-126007-00 0.50mm

A 45.85
B- 14.68
BØ 41.00
C 1.05
D 70.80
 29x68



1.75 CK P
1.75 P
3.00 CR P

AK KK RT TP

85.00

19

RHZ	4cyl.	1997cc	79-80kW (108-109PS)	Diesel	Turbo Intercooled	TD32916
------------	-------	---------------	----------------------------	---------------	--------------------------	----------------





87-114700-00 STD
87-114708-00 0.60mm

A 46.75
B- 18.30
BØ 38.00
C 1.00
D 80.75
 E 28x70



AK RT TP

08-114700-00 STD
08-114708-00 0.60mm

3.50 CK P
 2.00 P
 3.00 CR P

86.00

20

C 20 NE 4cyl. **1998cc** **80-96kW** (109-130PS) **Petrol** **TD28278**

87-306800-30 STD

A 30.40
B- 5.00
BØ 57.00
D 50.40
 E 21x62



TP

08-306800-00 STD
08-306807-00 0.50mm
08-306811-00 1.00mm

1.50 CR P
 1.50 P
 3.00 CR

Steel

Stahl

Acier

Acero

Acciaio

86.00

21

Z 22 SE (Ecotec) 4cyl. **2198cc** **108-110kW** (147-150PS) **Petrol** **TD21854**

ASTRA 2.2 08/00→08/04 ZAFIRA 2.2 09/01→12/05

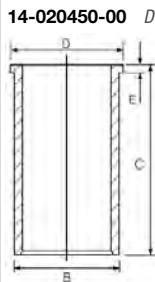

14-020450-00 D **B** 89.02 **C** 137.25 **D** 95.45 **E** 4.63

ENGINE INDEX

Motorverzeichnis • Index de moteur • Índice de Motor
 Indeks silnika • Модель Двигателя • دليل المحرك



CCM

x



9

198 A2.000	Diesel	1598	4	79.50	2
198 A5.000	Diesel	1956	4	83.00	3
199 B1.000 (Euro 5)	Diesel	1248	4	69.60	1
EDK	Diesel	2499	4	92.00	4
ENJ	Diesel	2499	4	92.00	4
M00 (HR 425 CL)	Diesel	2500	4	92.00	5
R425	Diesel	2499	4	92.00	4
VM 425HR (M51)	Diesel	2499	4	92.00	5
VM 425HS (M52)	Diesel	2499	4	92.00	5



69.60

1

199 B1.000 (Euro 5) 4cyl. **1248cc** **70kW (95PS)** **Diesel Turbo Intercooled** **TD26556**

YPSILON 1.3 Multijet 05/11→

87-435700-00 STD ①
87-435706-00 0.40mm ①

A 40.43
B- 12.70
BØ 37.00
C 1.15
C 0.90
D 62.43
 23x57



AK KK RT

08-435700-00 STD
08-435706-00 0.40mm

1.50  GDC P
1.50  P
2.00  CR P



① With Stop/Start Technology ① Für Fahrzeuge mit StartStop Funktion ① Pour véhicules équipé du start & stop ① Para vehículos con función start-stop ① Per veicoli con la funzione Start-Stop

79.50

2

198 A2.000 4cyl. **1598cc** **88kW (120PS)** **Diesel Turbo Intercooled** **TD26557**

DELTA 1.6 D Multijet 08/11→

87-429300-10 STD ① ②
87-429306-10 0.40mm ① ②



A 43.95
B- 13.80
BØ 41.70
C 1.01
C 1.03
D 68.95
 26x63



(792A-765)

AK RT TP

08-429300-10 STD ③
08-429306-10 0.40mm ③

1.50  GDC P
1.50  P
2.00  CR P



① Pistons to be replaced in Engine Sets only ① Kolben nur in Motorsätzen zu ersetzen ① Piston à remplacer dans jeu moteur ① Pistones de repuesto para juegos de motores solamente ① Il pistone può essere rimpiazzato solamente completo
② Bowl capacity 19.65cm³ ② Volumen der Kolbenmulde 19.65cm³ ② Volume de la cavité du piston 19.65cm³ ② Vol. cavidad pistón 19.65cm³ ② Volume camera pistone 19.65cm³
③ Euro 6

83.00

3

198 A5.000 4cyl. **1956cc** **121kW (165PS)** **Diesel Turbo Intercooled** **TD26560**

DELTA 2.0 D Multijet 08/11→

87-436500-00 STD
87-436506-00 0.40mm

A 46.63
B- 15.80
BØ 43.50
D 72.63
 30x66



(08344A406)
AK KK RT TP

08-436500-00 STD
08-436506-00 0.40mm

1.50  GDC P
1.50  P
2.00  CR P



92.00

4

EDK 4cyl. **2499cc** **88kW (120PS)** **Diesel Turbo Intercooled** **TD21953**

ENJ 4cyl. **2499cc** **105kW (143PS)** **Diesel Turbo Intercooled** **TD18323**

R425 4cyl. **2499cc** **Diesel Turbo Intercooled** **MP12303**

RAM VAN 2.5 CRD 01/06→04/08 VOYAGER / GRAND VOYAGER IV 2.5 CRD 01/01→02/08

VOYAGER 2.5D 08/05→ VOYAGER IV 2.5 CRD 02/00→12/08



87-429200-00 STD

- A 55.00
- B- 18.00
- BØ 44.00
- D 83.00
-  32x68



AK KK RT TP

08-429200-00 STD

- 2.50  GDC P
- 1.50  P
- 2.00  NT



92.00

5

M00 (HR 425 CL)	4cyl.	2500cc	85-87kW (116-118PS)	Diesel	Turbo	TD4253
VM 425HR (M51)	4cyl.	2499cc	85-89kW (115-121PS)	Diesel	Turbo	TD4257
VM 425HS (M52)	4cyl.	2499cc	85kW (115PS)	Diesel	Turbo	TD535
VOYAGER II 2.5 TD						
01/92 → 09/95						

15-676420-00 WH **B** 101.50 **C** 166.80 **D** 110.00 **E** 8.90 **F** 1.20
14-676420-00 WH **B** 101.50 **C** 166.80 **D** 110.00 **E** 8.90 **F** 1.20

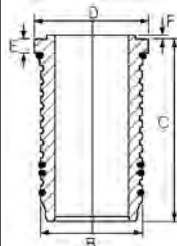

Includes seals

Schließt Dichtungen ein

Inclut des joints

Incluye los sellos

Comprende le guarnizioni



CCM



9

129/5	Petrol	1219	4	75.00	9
159B	Petrol	1905	4	83.00	30
171C	Petrol	1580	4	83.00	30
8140.43N (Euro 3 Sofim)	Diesel	2800	4	94.40	52
8140.43S (Euro 3 Sofim)	Diesel	2800	4	94.40	52
B6E	Petrol	1580	4	83.00	30
B25637	Diesel	2500	4	93.00	49
C1A	Petrol	954	4	70.00	1
CRD93B	Diesel	2500	4	93.00	49
D2E	Petrol	1905	4	83.00	30
DJ5 (T9A)	Diesel	2446	4	92.00	47
DJ5T (T8A)	Diesel	2446	4	92.00	48
DJ5T (THZ)	Diesel	2446	4	92.00	48
DK5ATE (THY)	Diesel	2446	4	92.00	48
DT17ED4	Diesel	2720	V6	81.00	27
DT17TED4 (UHZ) (Euro 4)	Diesel	2720	V6	81.00	27
DT20C (Euro 5)	Diesel	2993	V6	84.00	34
DT20C (X8C) (Euro 5)	Diesel	2993	V6	84.00	34
DV4C (8HR)	Diesel	1398	4	73.70	5
DV4TD (8HT)	Diesel	1398	4	73.70	6
DV4TD (8HX) (Euro 3/4)	Diesel	1398	4	73.70	6
DV4TD (8HZ)	Diesel	1398	4	73.70	6
DV4TED (8HS) (Euro 4)	Diesel	1398	4	73.70	7
DV4TED4 (8HY)	Diesel	1398	4	73.70	7
DV6ATED4 (9HX) (Euro 4)	Diesel	1560	4	75.00	13
DV6BTED4 (9HT) (Euro 4)	Diesel	1560	4	75.00	14
DV6BTED4 (9HW) (Euro 4)	Diesel	1560	4	75.00	14
DV6BUTED4 (9HT) (Euro 4)	Diesel	1560	4	75.00	14
DV6C (9HC)	Diesel	1560	4	75.00	14
DV6C (9HD)	Diesel	1560	4	75.00	14
DV6C (9HL)	Diesel	1560	4	75.00	14
DV6C (9HR)	Diesel	1560	4	75.00	14
DV6DBM (9HE) (Euro 4)	Diesel	1560	4	75.00	15
DV6DTED (9HF) (Euro 4)	Diesel	1560	4	75.00	14
DV6DTED (9HP) (Euro 4)	Diesel	1560	4	75.00	14
DV6DTEDM (9HJ) (Euro 4)	Diesel	1560	4	75.00	14
DV6DUM (9HH)	Diesel	1560	4	75.00	14
DV6ETED (9HN) (Euro 4)	Diesel	1560	4	75.00	15
DV6ETED (9HW) (Euro 4)	Diesel	1560	4	75.00	14
DV6ETEDM (9HK) (Euro 4)	Diesel	1560	4	75.00	14
DV6FC (BHT)	Diesel	1560	4	75.00	16
DV6FC (BHU)	Diesel	1560	4	75.00	16
DV6FC (BHX)	Diesel	1560	4	75.00	16
DV6FC (BHZ)	Diesel	1560	4	75.00	16
DV6FD (BHY)	Diesel	1560	4	75.00	16
DV6TED4 (9HY)	Diesel	1560	4	75.00	13
DV6TED4 (9HZ) (Euro 4)	Diesel	1560	4	75.00	13
DV6UC (9HM)	Diesel	1560	4	75.00	14
DV6UTED4 (9HU)	Diesel	1560	4	75.00	13
DW8 (WJZ);DW8B (WJY)	Diesel	1868	4	82.20	28
DW8B (WJX)	Diesel	1868	4	82.20	28
DW8B (WJY)	Diesel	1868	4	82.20	28
DW10ATED (RHS)	Diesel	1997	4	85.00	36
DW10ATED (RHZ)	Diesel	1997	4	85.00	36
DW10ATED4 (RHM)	Diesel	1997	4	85.00	37
DW10ATED4 (RHT)	Diesel	1997	4	85.00	37
DW10ATED4 (RHW)	Diesel	1997	4	85.00	37
DW10BTED (RHX)	Diesel	1997	4	85.00	36
DW10BTED (RHZ)	Diesel	1997	4	85.00	36
DW10BTED+ (RHZ)	Diesel	1997	4	85.00	36

ENGINE INDEX

Motorverzeichnis • Index de moteur • Índice de Motor
 Indeks silnika • Модель Двигателя • دليل المحرك

CCM
x

9

DW10BTED4 (RHF)	Diesel	1997	4	85.00	38
DW10BTED4 (RHJ) (Euro 4)	Diesel	1997	4	85.00	38
DW10BTED4 (RHR) (Euro 4)	Diesel	1997	4	85.00	38
DW10CB (RHD) (Euro 4)	Diesel	1997	4	85.00	35
DW10 C HYBRID (RHC) (Euro 5)	Diesel	1997	4	85.00	35
DW10CTED (RHZ)	Diesel	1997	4	85.00	36
DW10CTED+ (RHZ)	Diesel	1997	4	85.00	36
DW10CTED4 (RHD) (Euro 4)	Diesel	1997	4	85.00	35
DW10CTED4 (RHE)	Diesel	1997	4	85.00	35
DW10CTED4 (RHH) (Euro 5)	Diesel	1997	4	85.00	35
DW10FC (AHW) (Euro 5)	Diesel	1997	4	85.00	39
DW10FD (AHR) (Euro 5)	Diesel	1997	4	85.00	39
DW10FD (AHX) (Euro 5)	Diesel	1997	4	85.00	39
DW10FDD (AHV) (Euro 5)	Diesel	1997	4	85.00	39
DW10TD (RHV)	Diesel	1997	4	85.00	36
DW10TD (RHY)	Diesel	1997	4	85.00	36
DW10UTD (RHV)	Diesel	1997	4	85.00	36
DW10UTED4 (RHK) (Euro 4)	Diesel	1997	4	85.00	38
DW12BTED4 (4HP) (Euro 4)	Diesel	2179	4	85.00	40
DW12BTED4 (4HR) (Euro 4)	Diesel	2179	4	85.00	40
DW12BTED4 (4HT) (Euro 4)	Diesel	2179	4	85.00	40
DW12C (4HL)	Diesel	2179	4	85.00	41
DW12MTED4 (4HN)	Diesel	2179	4	85.00	40
DW12TED4 (4HW)	Diesel	2179	4	85.00	42
DW12TED4/FAP (4HX)	Diesel	2179	4	85.00	42
E1A	Petrol	1118	4	72.00	2
EB2M (HMV)	Petrol	1199	3	75.00	8
EB2M (HMY)	Petrol	1199	3	75.00	8
EC5	Petrol	1587	4	78.50	22
EC5 (NFP)	Petrol	1587	4	78.50	22
EP3 (8FN)	Petrol	1397	4	77.00	17
EP3 (8FP)	Petrol	1397	4	77.00	17
EP3 (8FR)	Petrol	1397	4	77.00	17
EP3 (8FS)	Petrol	1397	4	77.00	17
EP3C (8FR) (Euro 5)	Petrol	1397	4	77.00	17
EP6 (5FW)	Petrol	1598	4	77.00	18
EP6C (5FS)	Petrol	1598	4	77.00	19
EP6 CB (5FK)	Petrol	1598	4	77.00	19
EP6CDT (5FN)	Petrol	1598	4	77.00	20
EP6CDT (5FV)	Petrol	1598	4	77.00	20
EP6CDTX (5FU) (Euro 4)	Petrol	1598	4	77.00	18
EP6DT (5FM) (Euro 4)	Petrol	1598	4	77.00	20
EP6DT (5FR)	Petrol	1598	4	77.00	20
EP6DT (5FT)	Petrol	1598	4	77.00	20
EP6DTX (5FU) (Euro 4)	Petrol	1598	4	77.00	18
EP6FDT (5GZ) (Euro 4)	Petrol	1598	4	77.00	20
F1CE3481N (F30DTE) (Euro 5)	Diesel	2999	4	95.80	54
F28D (8140.63) (Euro 2 Sofim)	Diesel	2800	4	94.40	53
F28TDCR (Euro 3 SOFIM 2800 HDI)	Diesel	2800	4	94.40	52
F30DT (F1CE0481D) (Euro 4)	Diesel	2999	4	95.80	55
F30DTE (F1CE3481E) (Euro 5)	Diesel	2999	4	95.80	54
K1B	Petrol	1360	4	75.00	10
K1G	Petrol	1360	4	75.00	10
KAZ	Petrol	1360	4	75.00	10
M22-629	Diesel	2500	4	93.00	49
M25-629	Diesel	2500	4	93.00	49
M25-637	Diesel	2500	4	93.00	49
M25-648	Diesel	2500	4	93.00	50
M25-660	Diesel	2500	4	93.00	49
M25-661	Diesel	2500	4	93.00	49



CCM



9

M25-669	Diesel	2500	4	93.00	50
M705	Diesel	1930	4	82.60	29
P22DTE (4HG)	Diesel	2198	4	86.00	43
P22DTE (4HH)	Diesel	2198	4	86.00	43
P22DTE (4HJ)	Diesel	2198	4	86.00	43
P22DTE (4HU)	Diesel	2198	4	86.00	44
P22DTE (4HV)	Diesel	2198	4	86.00	45
TU1 (H1B)	Petrol	1124	4	72.00	3
TU1A (HFX)	Petrol	1124	4	72.00	4
TU1CP (HAZ)	Petrol	1124	4	72.00	3
TU1JP (HFX) (Euro 5)	Petrol	1124	4	72.00	4
TU1 K (H1A)	Petrol	1124	4	72.00	3
TU1M (HDZ)	Petrol	1124	4	72.00	3
TU1M+ (HDY)	Petrol	1124	4	72.00	3
TU3 (K3A)	Petrol	1360	4	75.00	10
TU3A (K1H)	Petrol	1360	4	75.00	10
TU3A (K6D)	Petrol	1360	4	75.00	10
TU3A (K6E)	Petrol	1360	4	75.00	10
TU3A (K6F)	Petrol	1360	4	75.00	10
TU3A (KFT) (Euro 5)	Petrol	1360	4	75.00	10
TU3A (KFV) (Euro 5)	Petrol	1360	4	75.00	10
TU3A (KFW)	Petrol	1360	4	75.00	10
TU3A (KFX)	Petrol	1360	4	75.00	10
TU3CP (KAY)	Petrol	1360	4	75.00	10
TU3F2 (K1F)	Petrol	1360	4	75.00	10
TU3F2 (K2B)	Petrol	1360	4	75.00	10
TU3FJ2 (K2D)	Petrol	1360	4	75.00	10
TU3FJ2 (KFY)	Petrol	1360	4	75.00	10
TU3FJ2/Z (KFZ)	Petrol	1360	4	75.00	10
TU3FM (K2A)	Petrol	1360	4	75.00	10
TU3FM (KDY)	Petrol	1360	4	75.00	10
TU3JP (KFW)	Petrol	1360	4	75.00	11
TU3JP (KFX)	Petrol	1360	4	75.00	11
TU3JP-L4 (KFV)	Petrol	1360	4	75.00	11
TU3M (KDX)	Petrol	1360	4	75.00	10
TU3M (KDY)	Petrol	1360	4	75.00	10
TU3M/Z (KDZ)	Petrol	1360	4	75.00	10
TU5J4 (NFX)	Petrol	1587	4	78.50	23
TU5JP (NFT)	Petrol	1587	4	78.50	23
TU5JP (NFV)	Petrol	1587	4	78.50	24
TU5JP (NFZ)	Petrol	1587	4	78.50	24
TU5JP4 (N6A)	Petrol	1587	4	78.50	24
TU5JP4 (NFU)	Petrol	1587	4	78.50	23
TU5JP4B (NFR)	Petrol	1587	4	78.50	23
TU9	Petrol	954	4	70.00	1
TU9 (CDY)	Petrol	954	4	70.00	1
TU9M (CDY/CDZ)	Petrol	954	4	70.00	1
TUD5 (VJY)	Diesel	1527	4	77.00	21
TUD5 (VJZ)	Diesel	1527	4	77.00	21
U25/661 (CRD93L)	Diesel	2500	4	93.00	49
U25/673 (CRD93LS)	Diesel	2500	4	93.00	50
XD3/P	Diesel	2498	4	94.00	51
XN1T (170A)	Petrol	1971	4	88.00	46
XN1T (170B)	Petrol	1971	4	88.00	46
XN1T (170C)	Petrol	1971	4	88.00	46
XU5 (171A)	Petrol	1580	4	83.00	31
XU5 (B1AA)	Petrol	1580	4	83.00	31
XU5CP (BAY/BAZ)	Petrol	1580	4	83.00	30
XU5J (180A/B6D)	Petrol	1580	4	83.00	30
XU5J (180Z)	Petrol	1580	4	83.00	31

ENGINE INDEX

Motorverzeichnis • Index de moteur • Índice de Motor
 Indeks silnika • Модель Двигателя • دليل المحرك

CCM

9

Engine Model	Fuel Type	CCM	Cylinders	Stroke (mm)	Power (kW)
XU5JA (B6D)	Petrol	1580	4	83.00	30
XU5J/J2/JA	Petrol	1580	4	83.00	30
XU5JP (BFZ)	Petrol	1580	4	83.00	31
XU5M (BDY/B4A)	Petrol	1580	4	83.00	30
XU5M (BDZ)	Petrol	1580	4	83.00	30
XU5S (171B)	Petrol	1580	4	83.00	31
XU5S (171D)	Petrol	1580	4	83.00	31
XU7JB (LFX)	Petrol	1762	4	83.00	30
XU7JP (LFW/LFZ)	Petrol	1762	4	83.00	30
XU7JP4 (LFY)	Petrol	1762	4	83.00	30
XU9J1 (DFZ)	Petrol	1905	4	83.00	30
XU9J2 (D6A)	Petrol	1905	4	83.00	30
XU9J4 (D6C/DFW)	Petrol	1905	4	83.00	30
XU9J4 (DFW)	Petrol	1905	4	83.00	30
XU9JA (D6E)	Petrol	1905	4	83.00	30
XU9JA (DKZ)	Petrol	1905	4	83.00	30
XU9M (DDZ)	Petrol	1905	4	83.00	30
XU9S (159A)	Petrol	1905	4	83.00	30
XU51C (B1E)	Petrol	1580	4	83.00	30
XU52C	Petrol	1580	4	83.00	30
XU92C (D2A)	Petrol	1905	4	83.00	30
XU92C (D2C)	Petrol	1905	4	83.00	30
XU92C (D2F)	Petrol	1905	4	83.00	30
XUD7 (161) (XUD7)	Diesel	1769	4	80.00	25
XUD7 (161A) (XUD7)	Diesel	1769	4	80.00	25
XUD7 (A9A/161A) (XUD7)	Diesel	1769	4	80.00	25
XUD7TE (A8A) (XUD7)	Diesel	1769	4	80.00	26
XUD7TE (AJZ) (XUD7)	Diesel	1769	4	80.00	26
XUD9 (162)	Diesel	1905	4	83.00	32
XUD9 (D9A)	Diesel	1905	4	83.00	32
XUD9 (DJZ)	Diesel	1905	4	83.00	32
XUD9A (DJY)	Diesel	1905	4	83.00	32
XUD9A/L (D9B) (XUD9)	Diesel	1905	4	83.00	32
XUD9A/U (D9B) (XUD9)	Diesel	1905	4	83.00	32
XUD9BSD (D9V) (XUD9)	Diesel	1905	4	83.00	33
XUD9BTF (D9X)	Diesel	1905	4	83.00	33
XUD9SD (D9W)	Diesel	1905	4	83.00	33
XUD9TE (D9Y)	Diesel	1905	4	83.00	33
XUD9TF (D8B)	Diesel	1905	4	83.00	33
XUD9UTF (D8C)	Diesel	1905	4	83.00	33
XW7 (109/5)	Petrol	1124	4	72.00	2
XW7 (109/5E)	Petrol	1124	4	72.00	2
XW7 (109/5F)	Petrol	1124	4	72.00	2
XW7 (109K)	Petrol	1124	4	72.00	2
XY8 (150B)	Petrol	1360	4	75.00	12



70.00

1

C1A	4cyl.	954cc	32-34kW (44-46PS)	Petrol	TD6559
TU9	4cyl.	954cc	33kW (45PS)	Petrol	TD18545
TU9 (CDY)	4cyl.	954cc	33-37kW (45-50PS)	Petrol	TD5095
TU9M (CDY/CDZ)	4cyl.	954cc	33-37kW (45-50PS)	Petrol	TD10787

AX 10	07/86→12/98	SAXO 1.0 X	05/96→06/03
SAXO 1.0	10/97→06/03		

87-154200-00 *STD*
 87-154206-00 0.40mm
 87-154208-00 0.60mm

08-154200-00 *STD*
 08-154206-00 0.40mm
 08-154208-00 0.60mm

A 33.90
B- 0.50
BØ 55.00
D 57.40
 18x53



1.50 CR P
 1.50 P
 3.00 CR

Steel

Stahl

Acier

Acero

Acciaio

72.00

2

E1A	4cyl.	1118cc	35-40kW (48-54PS)	Petrol	TD648
XW7 (109/5)	4cyl.	1124cc	37-42kW (50-57PS)	Petrol	TD564
XW7 (109/5E)	4cyl.	1124cc	33-37kW (45-50PS)	Petrol	TD565
XW7 (109/5F)	4cyl.	1124cc	33-37kW (45-50PS)	Petrol	TD566
XW7 (109K)	4cyl.	1124cc	34-36kW (48-50PS)	Petrol	TD563

C15 1.1	10/84→12/96	VISA 11 E	09/78→03/91
LNA 1.1	07/82→04/85	VISA 11 RE	03/83→10/88

14-636470-00 *WH* **B 79.50 C 122.00 D 89.20 E 85.00**

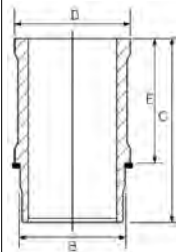

72.00

3

TU1 (H1B)	4cyl.	1124cc	40-44kW (55-60PS)	Petrol	TD658
TU1CP (HAZ)	4cyl.	1124cc	40kW (54PS)	Petrol	TD5083
TU1 K (H1A)	4cyl.	1124cc	40-44kW (54-60PS)	Petrol	TD6562
TU1M (HDZ)	4cyl.	1124cc	40-44kW (55-60PS)	Petrol	TD661
TU1M+ (HDY)	4cyl.	1124cc	40kW (54PS)	Petrol	TD26411

AX 11	09/86→12/97	C15 1.1 i	07/88→12/96
AX 11 Cat	09/88→12/89	SAXO 1.1	07/00→06/03
BERLINGO 1.1 i	07/96→05/08	SAXO 1.1 X, SX	05/96→09/03
BX 11	10/86→06/92	ZX 1.1	03/91→06/97
C15 1.1	08/88→07/96		





87-154300-00 STD

A 40.05
B+ 2.97
D 64.05
 20x62



08-154300-00 STD
08-154307-00 0.50mm

1.50  CR P
2.00  P
3.00  CR 

14-636470-00 WH **B** 79.50 **C** 122.00 **D** 89.20 **E** 85.00

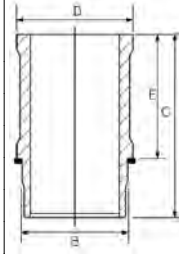

88-154300-00
87-154300-00 +
14-636470-00

 Steel  Stahl  Acier  Acero  Acciaio

72.00 **4**

TU1A (HFX)	4cyl.	1124cc	44kW (60PS)	Petrol	TD30658
TU1JP (HFX) (Euro 5)	4cyl.	1124cc	44kW (60PS)	Petrol	TD14730
BERLINGO 1.1 i			07/96→05/08	C3 II 1.1	11/10→
C2 1.1			09/03→09/12	C3 II 1.1 i	09/09→01/13
C3 I 1.1 i			02/02→	SAXO 1.1 X, SX	05/96→09/03
C3 I 1.1 LPG			06/06→12/09		

87-426300-00 STD

A 27.70
B+ 0.10
D 47.50
 18x55



08-426300-00 STD

1.50  NT
1.50  P
2.50  P

73.70 **5**

DV4C (8HR)	4cyl.	1398cc	50kW (68PS)	Diesel	Turbo Intercooled	TD25061
C3 II 1.4 HDi			06/10→09/16	DS3 1.4 HDi 70		04/10→07/15
C3 II 1.4 HDi 70			11/09→			

14-020760-00 D **B** 76.95 **C** 136.00 **D** 78.45 **E** 5.25
14-020761-00 D **B** 76.95 **C** 136.00 **D** 78.45 **E** 5.25

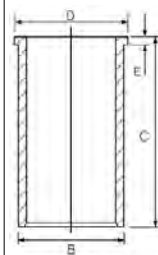

73.70 **6**

DV4TD (8HT)	4cyl.	1398cc	40kW (54PS)	Diesel	Turbo Intercooled	TD25062
DV4TD (8HX) (Euro 3/4)	4cyl.	1398cc	50-55kW (68-75PS)	Diesel	Turbo Intercooled	TD16425
DV4TD (8HZ)	4cyl.	1398cc	50-52kW (68-71PS)	Diesel	Turbo Intercooled	TD23773
C1 1.4 HDi			06/05→09/14	C3 I 1.4 HDi		02/02→
C2 1.4 HDi			07/03→12/09	C3 II 1.4 HDi 70		11/09→
C3 1.4 HDi			04/04→	XSARA 1.4 HDi		01/03→08/05





87-135300-00 STD
87-135307-00 0.50mm

A 42.94
B- 14.70
BØ 37.16
C 1.55
D 65.44
 25x60



AK RT TP

08-135300-00 STD
08-135305-00 0.25mm
08-135307-00 0.50mm

2.50  CK P
 1.95  P
 2.50  CR P

14-020760-00 D
14-020761-00 D

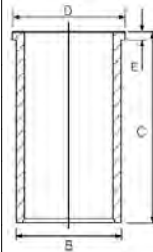

B 76.95 **C** 136.00 **D** 78.45 **E** 5.25
B 76.95 **C** 136.00 **D** 78.45 **E** 5.25

73.70

7

DV4TED (8HS) (Euro 4)	4cyl.	1398cc	50kW (68PS)	Diesel	Turbo Intercooled	TD25063
DV4TED4 (8HY)	4cyl.	1398cc	66kW (90PS)	Diesel	Turbo Intercooled	TD16426

C3 I 1.4 16V HDi	02/02→	NEMO 1.4 HDi	02/08→
------------------	--------	--------------	--------

87-135300-10 STD

A 42.94
B- 14.40
BØ 37.15
C 1.15
C 1.15
D 65.44
 25x60



KK RT TP

08-135300-00 STD
08-135305-00 0.25mm
08-135307-00 0.50mm

2.50  CK P
 1.95  P
 2.50  CR P

75.00

8

EB2M (HMY)	3cyl.	1199cc	53kW (72PS)	Petrol	TD32339
EB2M (HMY)	3cyl.	1199cc	53kW (72PS)	Petrol	TD32339

C-ELYSEE 1.2 VTi 72	11/12→01/17
---------------------	-------------

87-442900-00 STD
87-442907-00 0.50mm

A 28.85
B+ 2.70
C 2.65
C 1.55
D 46.85
 17x51



HA

08-442900-00 STD
08-442907-00 0.50mm

1.00  NT 
 1.00  P
 2.00  CR P

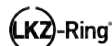

 Steel

 Stahl

 Acier

 Acero

 Acciaio

75.00

9

129/5	4cyl.	1219cc	47kW (64PS)	Petrol	TD574
VISA II Super X	07/80→06/82				





15-636700-00 WH **B 79.50 C 122.00 D 89.20 E 82.50**

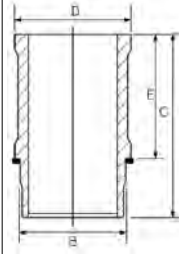

Includes seals

Schließt Dichtungen ein

Inclut des joints

Incluye los sellos

Comprende le guarnizioni

75.00

10

K1B	4cyl.	1360cc	44kW (61PS)	Petrol	TD665
K1G	4cyl.	1360cc	51-52kW (69-71PS)	Petrol	TD6567
KAZ	4cyl.	1360cc	40-55kW (54-75PS)	Petrol	TD6566
TU3 (K3A)	4cyl.	1360cc	40-46kW (54-63PS)	Petrol	TD6569
TU3A (K1H)	4cyl.	1360cc	47-55kW (64-75PS)	Petrol	TD4272
TU3A (K6D)	4cyl.	1360cc	53kW (72PS)	Petrol	TD25067
TU3A (K6E)	4cyl.	1360cc	53-54kW (72-73PS)	Petrol	TD25069
TU3A (K6F)	4cyl.	1360cc	53kW (72PS)	Petrol	TD25068
TU3A (KFT) (Euro 5)	4cyl.	1360cc	54kW (73PS)	Petrol	TD25070
TU3A (KFV) (Euro 5)	4cyl.	1360cc	54kW (73PS)	Petrol	TD23774
TU3A (KFW)	4cyl.	1360cc	55kW (75PS)	Petrol	TD25066
TU3A (KFX)	4cyl.	1360cc	55kW (75PS)	Petrol	TD25074
TU3CP (KAY)	4cyl.	1360cc	44kW (60PS)	Petrol	TD9546
TU3F2 (K1F)	4cyl.	1360cc	44-49kW (60-67PS)	Petrol	TD666
TU3F2 (K2B)	4cyl.	1360cc	62-65kW (85-89PS)	Petrol	TD669
TU3FJ2 (K2D)	4cyl.	1360cc	55kW (75PS)	Petrol	TD6568
TU3FJ2 (KFY)	4cyl.	1360cc	66kW (90PS)	Petrol	TD5078
TU3FJ2/Z (KFZ)	4cyl.	1360cc	69-74kW (94-100PS)	Petrol	TD45612
TU3FM (K2A)	4cyl.	1360cc	61-65kW (84-88PS)	Petrol	TD668
TU3FM (KDY)	4cyl.	1360cc	55-58kW (75-79PS)	Petrol	TD4277
TU3M (KDX)	4cyl.	1360cc	55kW (75PS)	Petrol	TD5080
TU3M (KDY)	4cyl.	1360cc	55-58kW (75-79PS)	Petrol	TD5160
TU3M/Z (KDZ)	4cyl.	1360cc	55-59kW (75-80PS)	Petrol	TD683
AX 1.4			09/86→04/94	C3 I 1.4	12/05→07/12
AX 1.4 GTi			06/91→12/96	C3 I 1.4 i	02/02→11/10
AX 14			12/86→04/97	C3 II 1.4	11/09→09/16
AX 14 GT			01/89→12/91	C3 II 1.4 LPG	07/10→
BERLINGO 1.4 i			07/96→12/11	C15 1.4	05/87→12/96
BX 1.4			01/87→01/92	C15 1.4 E	07/87→12/96
BX 14			10/82→02/93	C15 1.4 i	05/91→12/96
BX 14 E			04/83→07/89	NEMO 1.4	02/08→
C2 1.4			09/03→12/09	ZX 1.4	03/91→06/97
C3 1.4			05/03→	ZX 1.4 i	03/91→10/97





87-154400-00 STD

A 40.50
B- 1.10
BØ 62.00
D 64.50
 20x62



08-154400-00 STD
08-154407-00 0.50mm

1.75 CR P
 2.00 P
 3.00 P

15-636600-00 WH ¹
14-636600-00 WH

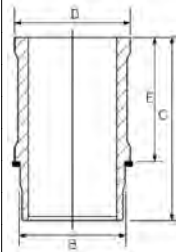

B 79.50 **C** 134.50 **D** 89.20 **E** 90.00
B 79.50 **C** 134.50 **D** 89.20 **E** 90.00

88-154400-00
 87-154400-00 +
 14-636600-00

¹ Includes seals

¹ Schließt Dichtungen ein

¹ Inclut des joints

¹ Incluye los sellos

¹ Comprende le guarnizioni

75.00

11

TU3JP (KFW)	4cyl.	1360cc	47-57kW (64-77PS)	Petrol	TD14731
TU3JP (KFX)	4cyl.	1360cc	53-57kW (72-77PS)	Petrol	TD6554
TU3JP-L4 (KFW)	4cyl.	1360cc	54-60kW (73-82PS)	Petrol	TD16464
BERLINGO 1.4			07/96→12/11	SAXO 1.4 VTS	05/96→06/03
BERLINGO 1.4 i			07/96→12/11	XSARA 1.4	05/98→03/05
C2 1.4			09/03→12/09	XSARA 1.4 i	04/97→08/05
C3 1.4			05/03→	XSARA 1.4 LPG	05/98→08/00
C3 I 1.4			09/08→12/09	ZX 1.4 i	03/91→10/97
C3 I 1.4 i			02/02→		

87-138900-10 STD
 →01/04

A 27.75
B- 1.30
BØ 65.00
D 49.75
 18x58



08-138900-00 STD

1.50 CK P
 1.50 P
 2.50 P

15-636600-00 WH ¹
14-636600-00 WH

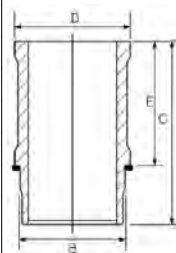

B 79.50 **C** 134.50 **D** 89.20 **E** 90.00
B 79.50 **C** 134.50 **D** 89.20 **E** 90.00

88-138900-10
 87-138900-10 +
 14-636600-00

87-138900-30 STD ²
 01/04→

A 27.75
B+ 0.18
D 49.75
 18x56



08-138900-00 STD

1.50 CK P
 1.50 P
 2.50 P

15-636600-00 WH ¹
14-636600-00 WH

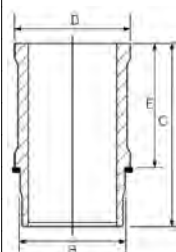

B 79.50 **C** 134.50 **D** 89.20 **E** 90.00
B 79.50 **C** 134.50 **D** 89.20 **E** 90.00

88-138900-30
 87-138900-30 +
 14-636600-00

¹ Includes seals

¹ Schließt Dichtungen ein

¹ Inclut des joints

¹ Incluye los sellos

¹ Comprende le guarnizioni

² Euro 4

75.00

12

XY8 (150B)	4cyl.	1360cc	55-59kW (75-80PS)	Petrol	TD577
BX 1.4			09/82→12/86	VISA 14 GT	03/82→03/91
BX 14 E			10/85→05/89		





15-636600-00 WH **B 79.50 C 134.50 D 89.20 E 90.00**
14-636600-00 WH **B 79.50 C 134.50 D 89.20 E 90.00**

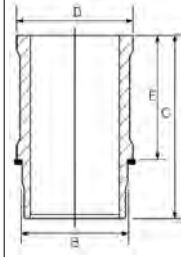

Includes seals

Schließt Dichtungen ein

Inclut des joints

Incluye los sellos

Comprende le guarnizioni

75.00

13

DV6ATED4 (9HX) (Euro 4)	4cyl.	1560cc	66-68kW (90-92PS)	Diesel	Turbo Intercooled	TD19913
DV6TED4 (9HY)	4cyl.	1560cc	80-85kW (109-116PS)	Diesel	Turbo Intercooled	TD19911
DV6TED4 (9HZ) (Euro 4)	4cyl.	1560cc	80kW (109PS)	Diesel	Turbo Intercooled	TD19824
DV6UTED4 (9HU)	4cyl.	1560cc	66kW (90PS)	Diesel	Turbo Intercooled	TD24692
BERLINGO 1.6 HDi 90			07/05→12/11	C4 1.6 HDi		11/04→07/11
BERLINGO 1.6 HDi 90 16V			04/08→	C4 GRAND PICASSO I 1.6 HDi		10/06→06/11
BERLINGO 1.6 HDi 110			04/08→	C4 I 1.6 HDi		11/04→07/11
BERLINGO MULTISPACE 1.6 HDi 90			04/08→	C4 PICASSO I 1.6 HDi		02/07→08/13
BERLINGO MULTISPACE 1.6 HDi 110			04/08→	C5 1.6 HDi		09/04→01/08
C2 1.6 HDi			09/05→12/09	C5 II 1.6 HDi		09/04→01/08
C3 I 1.6 16V HDi			09/05→	C5 III 1.6 HDi 110		02/08→
C3 II 1.6 HDi 90			11/09→	JUMPY 1.6 HDi 90 16V		01/07→03/16
C3 PICASSO 1.6 HDi			02/09→	XSARA PICASSO 1.6 HDi		05/04→12/11

87-424000-00 STD
87-424008-00 0.60mm

A 41.70
B- 13.25
BØ 41.80
C 1.20
D 65.30
 26x61



AK KK RT TP

08-424000-00 STD
08-424007-00 0.50mm
08-424008-00 0.60mm

3.00  CK P
 1.95  P
 2.50  CR P

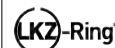

14-020900-00 D **B 78.00 C 142.00 D 79.50 F 5.00**

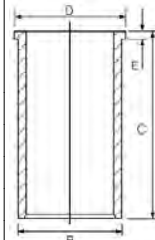

75.00

14

DV6BTED4 (9HT) (Euro 4)	4cyl.	1560cc	55kW (75PS)	Diesel	Turbo Intercooled	TD21321
DV6BTED4 (9HW) (Euro 4)	4cyl.	1560cc	55kW (75PS)	Diesel	Turbo Intercooled	TD27840
DV6BUTED4 (9HT) (Euro 4)	4cyl.	1560cc	55kW (75PS)	Diesel	Turbo Intercooled	TD21322
DV6C (9HC)	4cyl.	1560cc	82-85kW (112-116PS)	Diesel	Turbo Intercooled	TD31490
DV6C (9HD)	4cyl.	1560cc	84kW (114PS)	Diesel	Turbo Intercooled	TD29578
DV6C (9HL)	4cyl.	1560cc	82kW (111PS)	Diesel	Turbo Intercooled	TD26985
DV6C (9HR)	4cyl.	1560cc	82kW (111PS)	Diesel	Turbo Intercooled	TD25690
DV6DTED (9HF) (Euro 4)	4cyl.	1560cc	66kW (90PS)	Diesel	Turbo Intercooled	TD25094
DV6DTED (9HP) (Euro 4)	4cyl.	1560cc	68-69kW (92-94PS)	Diesel	Turbo Intercooled	TD25092
DV6DTEDM (9HJ) (Euro 4)	4cyl.	1560cc	68kW (92PS)	Diesel	Turbo Intercooled	TD25093
DV6DUM (9HH)	4cyl.	1560cc	66kW (90PS)	Diesel	Turbo Intercooled	TD29698
DV6ETED (9HW) (Euro 4)	4cyl.	1560cc	55kW (75PS)	Diesel	Turbo Intercooled	TD25632
DV6ETEDM (9HK) (Euro 4)	4cyl.	1560cc	55kW (75PS)	Diesel	Turbo Intercooled	TD25097
DV6UC (9HM)	4cyl.	1560cc	66kW (90PS)	Diesel	Turbo Intercooled	TD28622
BERLINGO 1.6 HDi 75			04/08→	C4 GRAND PICASSO II 1.6 HDi 90		09/13→





BERLINGO 1.6 HDi 75	07/05→12/11	C4 II 1.6 HDi	11/09→
BERLINGO 1.6 HDi 90	07/10→	C4 II 1.6 HDi 90	11/09→
BERLINGO 1.6 HDi 92	11/09→12/10	C4 II 1.6 HDi 110	11/09→
BERLINGO 1.6 HDi 92	07/10→12/17	C4 II 1.6 HDi 115	07/12→
BERLINGO 1.6 HDi 110	07/10→	C4 PICASSO I 1.6 HDi 110	09/10→08/13
BERLINGO 1.6 HDi 115	07/10→	C4 PICASSO II 1.6 HDi	02/13→
BERLINGO MULTISPACE 1.6 HDi 75 16V	04/08→	C4 PICASSO II 1.6 HDi 90	02/13→
BERLINGO MULTISPACE 1.6 HDi 90	07/10→	C4 PICASSO II e-HDi	02/13→
BERLINGO MULTISPACE 1.6 HDi 110	07/10→	C4 PICASSO II HDi / e-HDi	02/13→
BERLINGO MULTISPACE 1.6 HDi 115	07/10→	C4 SPACETOURER 1.6 HDi 115	04/18→
C3 II 1.6	04/15→	C5 III 1.6 HDi 110	07/10→
C3 II 1.6 HDi	11/09→09/16	C5 III 1.6 HDi 115	01/12→
C3 II 1.6 HDi 92	10/17→	C-ELYSEE 1.6 HDi 92	11/12→
C3 II 1.6 HDi 110	11/09→	DS3 1.6 HDi 90	11/09→07/15
C3 II 1.6 HDi 115	09/12→	DS3 1.6 HDi 110	11/09→07/15
C3 III 1.6 HDi 92	11/17→	DS3 1.6 HDi 115	08/12→07/15
C3 PICASSO 1.6 HDi 90	07/10→	DS4 1.6 HDi 90	05/11→07/15
C3 PICASSO 1.6 HDi 110	05/10→	DS4 1.6 HDi 110	04/11→07/15
C3 PICASSO 1.6 HDi 115	01/13→	DS4 1.6 HDi 115	08/12→07/15
C4 1.6 HDi 115	04/12→	DS5 1.6 HDi 110	11/11→07/15
C4 CACTUS 1.6 HDi 90	09/14→	DS5 1.6 HDi 115	06/12→07/15
C4 GRAND PICASSO I 1.6 HDi 110	09/10→08/13	GRAND C4 SPACETOURER 1.6 HDi 115	04/18→
C4 GRAND PICASSO II 1.6 HDi	09/13→	JUMPY 1.6 HDi 90 8V	01/07→03/16



87-433600-00 STD
87-433607-00 0.50mm

A 41.75
B- 13.85
BØ 45.00
D 65.20
 26x61

AK KK RT TP



08-433600-00 STD
08-433607-00 0.50mm

2.50  CK P
 1.95  P
 2.00  CR P

LKZ-Ring®

14-020900-00 D **B 78.00 C 142.00 D 79.50 F 5.00**

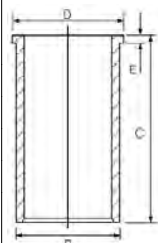

75.00						15
DV6DBM (9HE) (Euro 4)	4cyl.	1560cc	66kW (90PS)	Diesel	Turbo Intercooled	TD25095
DV6ETED (9HN) (Euro 4)	4cyl.	1560cc	55kW (75PS)	Diesel	Turbo Intercooled	TD25096
BERLINGO 1.6 HDi			07/10→	BERLINGO 1.6 HDi 90		07/10→12/17
BERLINGO 1.6 HDi 75			02/12→	BERLINGO MULTISPACE 1.6 HDi 75		04/08→

14-020900-00 D **B 78.00 C 142.00 D 79.50 F 5.00**

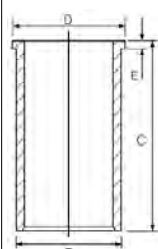

75.00						16
DV6FC (BHT)	4cyl.	1560cc	88kW (120PS)	Diesel	Turbo	TD33790
DV6FC (BHU)	4cyl.	1560cc	85kW (116PS)	Diesel	Turbo	TD33788
DV6FC (BHX)	4cyl.	1560cc	85kW (115PS)	Diesel	Turbo Intercooled	TD28551
DV6FC (BHZ)	4cyl.	1560cc	88kW (120PS)	Diesel	Turbo Intercooled	TD28612
DV6FD (BHY)	4cyl.	1560cc	73-75kW (99-102PS)	Diesel	Turbo Intercooled	TD31067
BERLINGO 1.6 100			12/14→	C4 II 1.6 120		02/15→





BERLINGO 1.6 120	12/14→	C4 PICASSO II 1.6 100	12/14→
BERLINGO MULTISPACE 1.6 100	12/14→	C4 PICASSO II 1.6 120	07/14→
BERLINGO MULTISPACE 1.6 120	12/14→	C4 PICASSO II 1.6 HDi	02/13→
C3 II 1.6	06/17→	C4 SPACETOURER 1.6 100	04/18→
C3 II 1.6 100	07/14→	C4 SPACETOURER 1.6 120	04/18→
C3 II 1.6 120	07/17→	C4 SPACETOURER 120	05/19→
C3 II 1.6 BlueHDi 100	05/19→	C-ELYSEE 1.6 100	11/14→
C3 III 1.6 100	07/16→	DS3 1.6	10/13→07/15
C3 III 100	03/19→	DS3 1.6 100	07/14→07/15
C3 PICASSO 1.6 100	01/15→	DS3 1.6 120	10/13→07/15
C4 CACTUS 1.6 100	09/14→	DS3 1.6 HDi 115	10/13→07/15
C4 CACTUS 100	05/19→	DS4 1.6	07/14→07/15
C4 GRAND PICASSO II 1.6 100	01/15→	DS4 1.6 120	07/14→07/15
C4 GRAND PICASSO II 1.6 120	07/14→	DS5 1.6 120	07/14→07/15
C4 GRAND PICASSO II 1.6 HDi	09/13→	DS5 1.6 HDi	11/13→07/15
C4 II 1.6	07/14→	GRAND C4 SPACETOURER 1.6 100	04/18→
C4 II 1.6 100	07/14→	GRAND C4 SPACETOURER 1.6 120	04/18→

87-453100-00 STD
87-453107-00 0.50mm

A 41.70
B- 13.15
BØ 45.50
D 63.70



AK KK RT TP

08-453100-00 STD
08-453107-00 0.50mm

2.00 CK
1.95 P
2.00 CR



77.00

17

EP3 (8FN)	4cyl.	1397cc	70kW (95PS)	Petrol	TD29266
EP3 (8FP)	4cyl.	1397cc	70kW (95PS)	Petrol	TD25076
EP3 (8FR)	4cyl.	1397cc	72kW (98PS)	Petrol	TD25077
EP3 (8FS)	4cyl.	1397cc	70kW (95PS)	Petrol	TD24725
EP3C (8FR) (Euro 5)	4cyl.	1397cc	70-72kW (95-98PS)	Petrol	TD38494

C3 II 1.4 LPG	06/13→	C4 II 1.4 VTi 95	11/09→
C3 II 1.4 VTi	11/09→	DS3 1.4 VTi 95	04/10→07/15
C3 II 1.4 VTi 95	11/09→	DS3 1.4 VTi 95 LPG	08/12→07/15
C3 PICASSO 1.4 VTi 95	02/09→	DS3 1.4 VTi 98	11/09→07/15
C3 PICASSO 1.4 VTi 95 LPG	01/12→		

87-444800-40 STD

A 30.80
B- 3.10
BØ 55.33
B+ 3.20
C 5.88
C 3.54
D 50.85
Ø 18.00x43.00

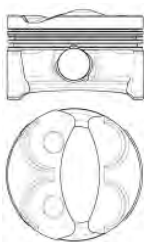

TP

08-444800-10 STD
08-444807-10 0.50mm

1.20 PVD P
1.50 P
2.00 NT



Steel Stahl Acier Acero Acciaio

77.00

18

EP6 (5FW)	4cyl.	1598cc	88kW (120PS)	Petrol	TD24724
EP6CDTX (5FU) (Euro 4)	4cyl.	1598cc	147kW (200PS)	Petrol Turbo Intercooled	TD27048
EP6DTX (5FU) (Euro 4)	4cyl.	1598cc	147kW (200PS)	Petrol Turbo Intercooled	TD25084





C3 PICASSO 1.6 VTi 120	02/09→	C4 PICASSO I 1.6 VTi 120	07/08→08/13
C4 1.6 VTi 120	07/08→07/11	DS4 1.6 THP 200	04/11→07/15
C4 GRAND PICASSO I 1.6 VTi 120	07/08→08/13	DS5 1.6 THP 200	11/11→07/15
C4 I 1.6 VTi 120	07/08→07/11		

87-444800-50 STD
87-444807-50 STD

08-444800-10 STD
08-444807-10 0.50mm

A 28.50
B- 3.50
B+ 2.70
C 3.50
C 3.50
D 51.20
20x48



1.20 PVD P
1.50 P
2.00 NT

HA RT TP

Steel Stahl Acier Acero Acciaio

77.00

19

EP6C (5FS)	4cyl.	1598cc	88kW (120PS)	Petrol	TD24934
EP6 CB (5FK)	4cyl.	1598cc	72kW (98PS)	Petrol	TD25065
BERLINGO 1.6 VTi 95			07/10→	C4 II 1.6 VTi 120	11/09→12/16
BERLINGO 1.6 VTi 120			11/09→	C4 II 1.6 VTi 120 LPG	09/11→
BERLINGO MULTISPACE 1.6 VTi 95			07/10→	C4 PICASSO II 1.6 VTi 120	02/13→
BERLINGO MULTISPACE 1.6 VTi 120			11/09→	C4 PICASSO II VTi 120	02/13→
C3 II 1.6 VTi 120			11/09→	C5 III 1.6 VTi 120	07/10→
C3 PICASSO 1.6 VTi 120			02/09→	C5 III 1.6 VTi 120	07/10→
C4 GRAND PICASSO II 1.6 VTi 120			09/13→	DS3 1.6 VTi 120	04/10→07/15
C4 II 1.6			01/13→	DS4 1.6 VTi 120	04/11→07/15

87-444800-10 STD
87-444807-10 0.50mm

08-444800-10 STD
08-444807-10 0.50mm

A 27.50
B- 2.00
BØ 57.50
C 3.97
C 5.95
D 47.50
18x43

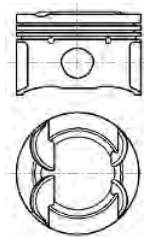

1.20 PVD P
1.50 P
2.00 NT

TP

Steel Stahl Acier Acero Acciaio

77.00

20

EP6CDT (5FN)	4cyl.	1598cc	110kW (150PS)	Petrol	Turbo Intercooled	TD28249
EP6CDT (5FV)	4cyl.	1598cc	115kW (156PS)	Petrol	Turbo Intercooled	TD24936
EP6DT (5FM) (Euro 4)	4cyl.	1598cc	120-128kW (163-173PS)	Petrol	Turbo Intercooled	TD25081
EP6DT (5FR)	4cyl.	1598cc	115kW (156PS)	Petrol	Turbo Intercooled	TD24933
EP6DT (5FT)	4cyl.	1598cc	103kW (140PS)	Petrol	Turbo Intercooled	TD24694
EP6FDT (5GZ) (Euro 4)	4cyl.	1598cc	121kW (165PS)	Petrol	Turbo Intercooled	TD31763
C4 1.6 THP			06/08→07/11	C5 III 1.6	03/11→	
C4 GRAND PICASSO I 1.6 16V			07/08→12/10	C5 III 1.6 THP 150	04/09→	
C4 GRAND PICASSO I 1.6 THP 155			09/10→08/13	C5 III 1.6 THP 155	04/09→	
C4 GRAND PICASSO II 1.6 THP 155			09/13→	DS3 1.6 THP 150	01/10→07/15	
C4 GRAND PICASSO II 1.6 THP 165			07/14→	DS3 1.6 THP 155	04/10→07/15	
C4 I 1.6 THP 140			07/08→07/11	DS3 1.6 THP160	01/12→07/15	
C4 II 1.6 THP 155			11/09→12/16	DS3 1.6 THP 165	10/14→07/15	
C4 PICASSO I 1.6 THP 140			07/08→08/13	DS4 1.6 THP 155	04/11→07/15	





C4 PICASSO I 1.6 THP 155	09/10→08/13	DS4 1.6 THP 165	01/12→07/15
C4 PICASSO II 1.6 THP 155	02/13→	DS5 1.6 THP 155	11/11→07/15
C4 PICASSO II 1.6 THP 165	07/14→	DS5 1.6 THP 165	01/12→07/15
C4 PICASSO II THP 155	02/13→	GRAND C4 SPACETOUREUR 1.6 THP 165	04/18→
C4 SPACETOUREUR 1.6 THP 165	04/18→		

87-453000-00 STD
87-453007-00 0.50mm

A 30.18
B- 3.30
D 50.13
20x48
(88850)



08-453000-00 STD
08-453007-00 0.50mm

1.20 PVD ①
1.20 P
2.00 CR



① Steel ① Stahl ① Acier ① Acero ① Acciaio

77.00 21

TUD5 (VJY)	4cyl.	1527cc	40-43kW (54-58PS)	Diesel	TD11890
TUD5 (VJZ)	4cyl.	1527cc	42-43kW (57-58PS)	Diesel	TD4296
AX 15 D			08/94→12/97	XSARA 1.5 D	04/97→09/00
SAXO 1.5 D			09/96→04/04	ZX 1.5 D	06/96→02/98

87-325800-00 STD
87-325806-00 0.40mm

A 40.37
B- 1.65
D 66.32
23x60
AK RT



08-325800-00 STD
08-325806-00 0.40mm

2.00 CK P
1.75 P
3.00 CR P



78.50 22

EC5	4cyl.	1587cc	85-90kW (116-122PS)	Petrol	TD37116
EC5 (NFP)	4cyl.	1587cc	85kW (116PS)	Petrol	TD28573
C3 II 1.6 VTi			10/16→	C4 II 1.6	01/13→
C3 III 1.6 VTi			02/17→	C-ELYSEE 1.6 VTi 115	11/12→

87-452700-00 STD ①
87-452707-00 STD ①
07/11→

A 32.35
B+ 1.40
C 2.45
D 53.75
20x57
TP



08-452700-00 STD
08-452707-00 0.50mm

1.00 CK ②
1.20 P
2.00 CR P



① 85kW→ ② Steel ② Stahl ② Acier ② Acero ② Acciaio

78.50 23

TU5J4 (NFX)	4cyl.	1587cc	80-88kW (109-120PS)	Petrol	TD10788
TU5JP (NFT)	4cyl.	1587cc	72-74kW (98-101PS)	Petrol	TD32684





TU5JP4 (NFU)	4cyl.	1587cc	80-90kW (109-122PS)	Petrol	TD15308
TU5JP4B (NFR)	4cyl.	1587cc	66kW (90PS)	Petrol	TD21320
BERLINGO 1.6			04/08→	C4 I 1.6	03/11→
BERLINGO 1.6 16V			10/00→12/11	C4 I 1.6 16V	11/04→07/11
BERLINGO MULTISPACE 1.6			04/08→	SAXO 1.6	02/96→04/04
C2 1.6			07/03→10/10	SAXO 1.6 VTR	05/96→07/99
C3 1.6			05/03→	SAXO 1.6 VTS	06/96→09/03
C3 I 1.6			06/05→12/13	XSARA 1.6 16V	09/00→08/05
C3 I 1.6 16V			02/02→08/10	XSARA PICASSO 1.6 16V	06/05→12/11
C4 1.6 16V			11/04→07/11		

87-139400-00 STD
87-139407-00 0.50mm

A 32.35
B+ 1.30
D 51.30
 20x57



08-139400-00 STD
08-139406-00 0.40mm
08-139407-00 0.50mm

1.20 CK P
 1.50 P
 2.50 P

78.50 **24**

TU5JP (NFV)	4cyl.	1587cc	70-74kW (95-101PS)	Petrol	TD23392
TU5JP (NFZ)	4cyl.	1587cc	65-67kW (88-91PS)	Petrol	TD9458
TU5JP4 (N6A)	4cyl.	1587cc	78-83kW (106-113PS)	Petrol	TD21504
SAXO 1.6			02/96→06/03	XSARA 1.6 i	04/97→09/00
SAXO 1.6 VTL, VTR			05/96→06/03	XSARA PICASSO 1.6	12/99→12/10

87-103800-00 STD
87-103806-00 0.40mm

A 32.25
B- 1.50
BØ 68.50
D 57.50
 20x62



08-103800-00 STD
08-103806-00 0.40mm

1.50 CK P
 1.50 P
 3.00 CR P

80.00 **25**

XUD7 (161) (XUD7)	4cyl.	1769cc	44kW (60PS)	Diesel	TD586
XUD7 (161A) (XUD7)	4cyl.	1769cc	43-44kW (58-60PS)	Diesel	TD4258
XUD7 (A9A/161A) (XUD7)	4cyl.	1769cc	43-44kW (58-60PS)	Diesel	TD6555
BERLINGO 1.8 D			07/96→10/02	VISA 17 D	04/84→03/91
BX 1.8 D			10/85→09/93	XSARA 1.8 D	04/97→09/00
BX 18 D			10/85→09/93	ZX 1.8 D	06/93→10/97
C15 1.8 D			07/86→12/00		





87-321500-10 STD
87-321507-10 0.50mm
87-321510-10 0.80mm

A 46.80
B- 2.00
D 84.50
 25x70



08-321500-00 STD
08-321507-00 0.50mm
08-321510-00 0.80mm

2.00 CR P
2.00 P
3.00 CR P

14-024740-00 D B 83.50 C 154.00 D 85.70 E 4.60
14-024830-00 D B 83.00 C 154.00 D 86.00 E 4.50

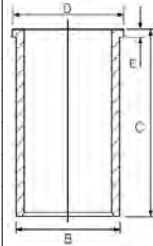

80.00

26

XUD7TE (A8A) (XUD7)	4cyl.	1769cc	66kW (90PS)	Diesel	Turbo Intercooled	TD602
XUD7TE (AJZ) (XUD7)	4cyl.	1769cc	66kW (90PS)	Diesel	Turbo Intercooled	TD604
BX TRD Turbo		03/88→12/94				

87-323607-00 0.50mm

A 46.80
B- 2.20
D 84.50
 28x68



AK RT

08-323600-00 STD
08-323607-00 0.50mm

3.00 MOL P
2.00 P
3.00 CR P

14-024740-00 D B 83.50 C 154.00 D 85.70 E 4.60
14-024830-00 D B 83.00 C 154.00 D 86.00 E 4.50

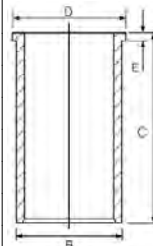

81.00

27

DT17ED4	V6cyl.	2720cc	150kW (204PS)	Diesel	Bi-Turbo Intercooled	TD19827
DT17TED4 (UHZ) (Euro 4)	V6cyl.	2720cc	150kW (204PS)	Diesel	Bi-Turbo Intercooled	TD24868
C5 III 2.7 HDi		02/08→		C6 2.7 HDi		09/05→12/11

87-432400-00 STD
87-432407-00 0.50mm

A 47.00
B- 14.05
BØ 44.00
C 0.50
D 71.00
 29x62



(8165E-108)

AK KK RT TP

08-432400-00 STD
08-432407-00 0.50mm

2.00 CK P
2.00 P
2.00 P

82.20

28

DW8 (WJZ);DW8B (WJY)	4cyl.	1868cc	51-52kW (69-70PS)	Diesel		TD10708
DW8B (WJX)	4cyl.	1868cc	44kW (60PS)	Diesel		TD26981
DW8B (WJY)	4cyl.	1868cc	51-52kW (69-70PS)	Diesel		TD15310
BERLINGO 1.9 D			07/98→10/05	JUMPY 1.9 D 70		04/98→10/06
BERLINGO 1.9 D 70			07/98→12/11	JUMPY 1.9 TD		11/00→10/06
C15 1.9 D			01/00→12/05	XSARA 1.9 D		07/98→08/05





<p>87-104000-00 STD 87-104008-00 0.60mm</p> <p>A 46.80 B- 1.30 D 78.00 25x65</p>	<p>08-104000-00 STD 08-104008-00 0.60mm</p> <p>2.00 2.00 3.00</p> <p>CK P P CR P</p>	<p>14-020290-00 D</p> <p>B 85.00 C 154.00 D 87.00 E 5.00</p>	<p>88-104000-00 87-104000-00 + 14-020290-00</p>
---	--	---	--

82.60						29
M705	4cyl.	1930cc	60kW (82PS)	Diesel	Turbo	TD6574
C25 1.9 DT			10/91→01/94	C25 1.9 TD		04/92→02/94

		<p>14-014730-00 D</p> <p>B 86.09 C 154.00</p>	
		<p>14-021311-00 D</p> <p>14-023560-00 D</p> <p>14-023751-00 D</p> <p>B 86.06 C 154.00 D 89.00 E 4.50 B 86.00 C 154.00 D 89.00 E 4.50 B 87.00 C 154.00 D 89.00 E 4.55</p>	

83.00						30
159B	4cyl.	1905cc	74kW (101PS)	Petrol		TD21529
171C	4cyl.	1580cc	66-68kW (90-92PS)	Petrol		TD593
B6E	4cyl.	1580cc	85kW (116PS)	Petrol		TD21866
D2E	4cyl.	1905cc	78-79kW (107-108PS)	Petrol		TD22449
XU5CP (BAY/BAZ)	4cyl.	1580cc	55kW (75PS)	Petrol		TD9550
XU5J (180A/B6D)	4cyl.	1580cc	76kW (103PS)	Petrol		TD596
XU5JA (B6D)	4cyl.	1580cc	83-85kW (113-116PS)	Petrol		TD4262
XU5J/J2/JA	4cyl.	1580cc	55kW (75PS)	Petrol		TD9551
XU5M (BDY/B4A)	4cyl.	1580cc	65-66kW (88-90PS)	Petrol		TD5097
XU5M (BDZ)	4cyl.	1580cc	65kW (89PS)	Petrol		TD615
XU7JB (LFX)	4cyl.	1762cc	58-66kW (90PS)	Petrol		TD9457
XU7JP (LFW/LFZ)	4cyl.	1762cc	73-76kW (99-103PS)	Petrol		TD5116
XU7JP4 (LFY)	4cyl.	1762cc	76-85kW (110-116PS)	Petrol		TD4279
XU9J1 (DFZ)	4cyl.	1905cc	75kW (102PS)	Petrol		TD9548
XU9J2 (D6A)	4cyl.	1905cc	90-92kW (122-125PS)	Petrol		TD631





XU9J4 (D6C/DFW)	4cyl.	1905cc	116-118kW (158-160PS)	Petrol	TD632
XU9J4 (DFW)	4cyl.	1905cc	108-110kW (147-150PS)	Petrol	TD640
XU9JA (D6E)	4cyl.	1905cc	93-96kW (126-131PS)	Petrol	TD22622
XU9JA (DKZ)	4cyl.	1905cc	88kW (120PS)	Petrol	TD647
XU9M (DDZ)	4cyl.	1905cc	80kW (109PS)	Petrol	TD639
XU9S (159A)	4cyl.	1905cc	75-77kW (102-105PS)	Petrol	TD584
XU51C (B1E)	4cyl.	1580cc	53-59kW (72-80PS)	Petrol	TD607
XU52C	4cyl.	1580cc	65-85kW (88-116PS)	Petrol	TD14648
XU92C (D2A)	4cyl.	1905cc	75-77kW (102-105PS)	Petrol	TD628
XU92C (D2C)	4cyl.	1905cc	70kW (95PS)	Petrol	TD629
XU92C (D2F)	4cyl.	1905cc	80kW (109PS)	Petrol	TD630

BERLINGO 1.8 i	04/97→10/02	XANTIA 1.8 i	03/93→04/03
BX 1.6	01/87→01/92	XANTIA 1.8 i 16V	06/95→04/03
BX 1.9	10/85→06/94	XSARA 1.8	07/97→08/00
BX 1.9 TZI	02/92→12/94	XSARA 1.8 i	04/97→09/00
BX 15	01/87→05/92	XSARA 1.8 i 16V	04/97→09/00
BX 16	10/82→12/94	XSARA 1.8 LPG	01/98→08/00
BX 16 E	05/89→02/93	XSARA PICASSO 1.8 SX	06/00→08/05
BX 19	09/84→12/94	ZX 1.6	07/94→10/97
BX 19 Cat	07/86→12/94	ZX 1.6 i	03/91→10/97
BX 19 E	06/88→02/93	ZX 1.8	03/91→10/97
BX 19 GTi	10/84→06/94	ZX 1.8 i	07/92→10/97
BX 19 GTi 16V	09/87→02/93	ZX 1.8 i 16V	01/96→02/98
EVASION 1.8	02/96→07/02	ZX 1.9	03/91→06/97
VISA 16 GTi	01/85→03/91	ZX 1.9 i	03/91→06/97

15-634910-00 WH ① **B 88.00 C 141.00 D 97.00 E 95.13**
14-634910-00 WH ② **B 88.00 C 141.00 D 97.00 E 95.13**

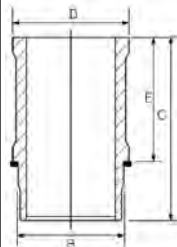

① Includes seals
 ② Use also 1 NB O-Ring HR566

① Schließt Dichtungen ein
 ② Mitverwenden: 1 NB O-Ring HR566

① Inclut des joints
 ② A utiliser aussi: 1 joint toriques HR566

① Incluye los sellos
 ② Utilizar también: 1 NB junta toricas HR566

① Comprende le guarnizioni
 ② Usare anche: 1 NB O-Ring HR566

83.00					31
XU5 (171A)	4cyl.	1580cc	66-67kW (90-92PS)	Petrol	TD591
XU5 (B1AA)	4cyl.	1580cc	58-59kW (79-80PS)	Petrol	TD12428
XU5J (180Z)	4cyl.	1580cc	76kW (103PS)	Petrol	TD597
XU5JP (BFZ)	4cyl.	1580cc	65-66kW (88-90PS)	Petrol	TD5101
XU5S (171B)	4cyl.	1580cc	66-70kW (90-95PS)	Petrol	TD592
XU5S (171D)	4cyl.	1580cc	64kW (87PS)	Petrol	TD594

BX 16	10/82→12/94	ZX 1.6	07/94→10/97
XANTIA 1.6 i	03/93→03/01	ZX 1.6 i	03/91→10/97





<p>1</p> <p>A 37.55 B- 2.10 D 67.50 22x66</p>	<p>08-151200-00 STD</p> <p>1.75 CR P 1.75 P 4.00 CR 2</p>	<p>15-634910-00 WH 3 B 88.00 C 141.00 D 97.00 E 95.13 14-634910-00 WH 4 B 88.00 C 141.00 D 97.00 E 95.13</p>	<p>89-151200-00 3 15-634910-00</p>
<p>1 Piston available in Kit Set only 2 Steel 3 Includes seals 4 Use also 1 NB O-Ring HR566</p>	<p>1 Kolben nur im Assembly erhältlich 2 Stahl 3 Schließt Dichtungen ein 4 Mitverwenden: 1 NB O-Ring HR566</p>	<p>1 Piston disponible en kit seulement 2 Acier 3 Inclut des joints 4 A utiliser aussi: 1 joint toriques HR566</p>	<p>1 Pistón disponible en conjuntos solamente. 2 Acero 3 Incluye los sellos 4 Utilizar también: 1 NB junta toricas HR566</p> <p>1 I pistoni sono disponibili solo in kit motore 2 Acciaio 3 Comprende le guarnizioni 4 Usare anche: 1 NB O-Ring HR566</p>

83.00	32
XUD9 (162)	4cyl. 1905cc 47kW (65PS) Diesel TD587
XUD9 (D9A)	4cyl. 1905cc 47kW (64PS) Diesel TD4265
XUD9 (DJZ)	4cyl. 1905cc 47-50kW (65-68PS) Diesel TD646
XUD9A (DJY)	4cyl. 1905cc 50-52kW (68-71PS) Diesel TD6556
XUD9A/L (D9B) (XUD9)	4cyl. 1905cc 50-52kW (68-71PS) Diesel TD4267
XUD9A/U (D9B) (XUD9)	4cyl. 1905cc 50-53kW (68-72PS) Diesel TD4266
BERLINGO 1.9 D	07/96→12/03 C25 1.9 D 1400 01/88→01/94
BX 1.9 19 D	03/87→02/93 JUMPER 1.9 D 02/94→04/02
BX 1.9 D	01/87→01/92 JUMPY 1.9 D 10/95→08/98
BX 1.9 RD	01/87→01/92 XANTIA 1.9 D 06/94→01/98
BX 19 D	09/83→12/94 XSARA 1.9 D 04/97→09/00
C25 1.9 D	07/87→02/94 ZX 1.9 D 03/91→07/99

<p>87-152000-10 STD 87-152007-10 0.50mm 87-152010-10 0.80mm</p> <p>A 46.80 B- 2.20 D 84.30 25x72</p>	<p>08-152000-00 STD 08-152003-00 0.125mm 08-152007-00 0.50mm 08-152010-00 0.80mm</p> <p>2.00 CR P 2.00 P 3.00 CR P</p>	<p>14-020530-00 D B 85.60 C 153.50 D 88.50 E 3.90</p>	
---	---	--	--

83.00	33
XUD9BSD (DHV) (XUD9)	4cyl. 1905cc 55kW (75PS) Diesel Turbo TD22991
XUD9BTF (DHX)	4cyl. 1905cc 66-68kW (90-92PS) Diesel Turbo Intercooled TD4268
XUD9SD (DHW)	4cyl. 1905cc 50-55kW (68-75PS) Diesel Turbo Intercooled TD10689
XUD9TE (DHY)	4cyl. 1905cc 65-68kW (88-92PS) Diesel Turbo Intercooled TD4269
XUD9TF (D8B)	4cyl. 1905cc 66-68kW (90-92PS) Diesel Turbo Intercooled TD5046
XUD9UTF (D8C)	4cyl. 1905cc 66-68kW (90-92PS) Diesel Turbo Intercooled TD4264
EVASION 1.9 TD	11/94→07/02 XSARA 1.9 D 01/98→09/00
JUMPER 1.9 TD	02/94→04/02 XSARA 1.9 SD 01/98→09/00
JUMPY 1.9 TD	10/95→11/03 XSARA 1.9 TD 04/97→09/00
XANTIA 1.9 SD	02/96→04/03 ZX 1.9 DT 06/92→10/97
XANTIA 1.9 Turbo D	05/93→04/03 ZX 1.9 TD 07/92→10/97





87-105500-00 STD
87-105507-00 0.50mm

A 46.75
B- 3.50
D 75.00
 28x68

AK HA RT TP



08-105500-00 STD
08-105507-00 0.50mm

3.00  CK
 2.00  NT
 3.00  CR P

14-020530-00 D

B 85.60 **C** 153.50 **D** 88.50 **E** 3.90

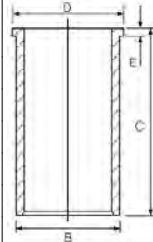

84.00

34

DT20C (Euro 5)	V6cyl.	2993cc	155-177kW (211-241PS)	Diesel	Bi-Turbo Intercooled	TD23526
DT20C (X8C) (Euro 5)	V6cyl.	2993cc	177kW (241PS)	Diesel	Bi-Turbo Intercooled	TD24869
C5 III 3.0 HDi 240			04/09→10/14	C6 3.0 HDi		04/09→12/12

87-439100-10 STD ① ②
87-439107-10 0.50mm ① ②

A 46.00
B- 15.35
BØ 47.62
D 70.00
 30x63

(0849D-408A)

AK KK RT TP



08-439100-10 STD ③
08-439107-10 0.50mm ③

1.75  GDC P
 1.75  P
 2.00  CR P



ECOTOUGH

① Gen 2 piston can be retrofitted in Gen 1 engines

① Kolben der 2. Generation können in Motoren der 1. Generation nachgerüstet werden

① Les pistons de 2ème génération peuvent être montés sur des moteurs de 1ème génération

① El pistón de la segunda generación se puede montar en los motores de primera generación

① il pistone di seconda generazione può essere montato nei motori di prima generazione

② Euro 6

③ For Gen 2 engines

③ Für Motoren der 2. Generation

③ Pour moteurs de 2ème génération

③ Para motores de segunda generación

③ Per i motori di seconda generazione

85.00



35

DW10CB (RHD) (Euro 4)	4cyl.	1997cc	100kW (136PS)	Diesel	Turbo Intercooled	TD29779
DW10 C HYBRID (RHC) (Euro 5)	4cyl.	1997cc	120kW (163PS)	Diesel	Turbo Intercooled	TD28242
DW10CTED4 (RHD) (Euro 4)	4cyl.	1997cc	100kW (136PS)	Diesel	Turbo Intercooled	TD29706
DW10CTED4 (RHE)	4cyl.	1997cc	110kW (150PS)	Diesel	Turbo Intercooled	TD24935
DW10CTED4 (RHH) (Euro 5)	4cyl.	1997cc	120kW (163PS)	Diesel	Turbo Intercooled	TD23770

C4 GRAND PICASSO I 2.0 HDi 150	07/09→08/13	C5 III 2.0 HDi 150	04/09→02/15
C4 GRAND PICASSO I 2.0 HDi 165	09/10→08/13	C5 III 2.0 HDi 165	04/09→
C4 GRAND PICASSO II 2.0	09/13→	C8 2.0 HDi 135	03/06→
C4 II 2.0 HDi	11/09→	C8 2.0 HDi 165	03/06→
C4 II 2.0 HDi / 160	10/10→	DS4 2.0 HDi	09/11→07/15
C4 PICASSO I 2.0 HDi 150	07/09→08/13	DS4 2.0 HDi 165	04/11→07/15
C4 PICASSO I 2.0 HDi 165	09/10→08/13	DS5 2.0 HDi 135	11/11→07/15
C4 PICASSO II 2.0	09/13→	DS5 2.0 HDi 165	11/11→07/15
C5 III 2.0 HDi	02/08→	JUMPY 2.0 HDi 165	07/10→03/16





87-443100-00 STD 
87-443108-00 0.60mm 

08-443100-00 STD
08-443108-00 0.60mm

A 46.70
B- 13.71
BØ 50.40
C 0.45
D 74.71
 30x68
 (0850H-228)
AK KK RT TP





2.00  GDC P
 2.00  P
 2.00  CR P



 Bowl capacity 26.32cm³

 Volumen der Kolbenmulde 26.32cm³

 Volume de la cavité du piston 26.32cm³

 Vol. cavidad pistón 26.32cm³

 Volume camera pistone 26.32cm³

85.00 **36**

DW10ATED (RHS)	4cyl.	1997cc	79kW (107PS)	Diesel	Turbo Intercooled	TD20782
DW10ATED (RHZ)	4cyl.	1997cc	79-81kW (107-110PS)	Diesel	Turbo Intercooled	TD12829
DW10BTED (RHX)	4cyl.	1997cc	69kW (94PS)	Diesel	Turbo Intercooled	TD21039
DW10BTED (RHZ)	4cyl.	1997cc	80kW (109PS)	Diesel	Turbo Intercooled	TD33718
DW10BTED+ (RHZ)	4cyl.	1997cc	80kW (109PS)	Diesel	Turbo Intercooled	TD33720
DW10CTED (RHZ)	4cyl.	1997cc	80kW (109PS)	Diesel	Turbo Intercooled	TD33717
DW10CTED+ (RHZ)	4cyl.	1997cc	80kW (109PS)	Diesel	Turbo Intercooled	TD33719
DW10TD (RHV)	4cyl.	1997cc	62kW (84PS)	Diesel	Turbo Intercooled	TD24877
DW10TD (RHY)	4cyl.	1997cc	66kW (90PS)	Diesel	Turbo Intercooled	TD15311
DW10UTD (RHV)	4cyl.	1997cc	62kW (84PS)	Diesel	Turbo Intercooled	TD16739

BERLINGO 2.0 HDi	11/02→10/05	JUMPY 2.0 HDi 110	03/00→10/06
BERLINGO 2.0 HDi 90	12/99→12/11	XANTIA 2.0 HDi	06/99→04/03
C4 I 2.0 HDi	04/07→07/08	XANTIA 2.0 HDi 90	03/99→04/03
C5 2.0 HDi	06/02→08/04	XANTIA 2.0 HDi 109	02/99→04/03
C5 I 2.0 HDi	03/01→08/04	XSARA 2.0 HDi	09/00→03/05
EVASION 2.0 HDi	08/99→07/02	XSARA 2.0 HDi 90	02/99→03/05
EVASION HDi	09/99→10/02	XSARA 2.0 HDi 90	02/99→08/05
JUMPER 2.0 HDi	04/02→06/06	XSARA 2.0 HDi 109	05/01→08/05
JUMPER 2.0 HDi	11/01→04/02	XSARA PICASSO 2.0 HDi	12/99→12/11
JUMPY 2.0 HDi 95	10/99→10/06		

87-114700-00 STD
87-114708-00 0.60mm

08-114700-00 STD
08-114708-00 0.60mm

A 46.75
B- 18.30
BØ 38.00
C 1.00
D 80.75
 28x70
AK RT TP



3.50  CK P
 2.00  P
 3.00  CR P

85.00 **37**

DW10ATED4 (RHM)	4cyl.	1997cc	76-79kW (103-107PS)	Diesel	Turbo Intercooled	TD20786
DW10ATED4 (RHT)	4cyl.	1997cc	79-81kW (107-110PS)	Diesel	Turbo Intercooled	TD20785
DW10ATED4 (RHW)	4cyl.	1997cc	79-80kW (107-109PS)	Diesel	Turbo Intercooled	TD20784

C8 2.0 HDi	07/02→	JUMPY 2.0 HDi 110	03/00→10/06
C8 HDi 110	11/03→12/09	JUMPY 2.0 HDi 110 16V	12/03→10/06
EVASION 2.0 HDi 16V	09/99→07/02	XSARA PICASSO 2.0 HDi	10/05→12/11
EVASION HDi	09/99→10/02		





87-114700-10 STD
87-114708-10 0.60mm

A 46.73
B- 18.80
BØ 39.80
C 1.67
D 72.70
 28x68

(08517-103)

AK KK RT TP



08-114700-00 STD
08-114708-00 0.60mm

3.50  CK P
2.00  P
3.00  CR P

85.00

38

DW10BTED4 (RHF)	4cyl.	1997cc	100-103kW (136-140PS)	Diesel	Turbo Intercooled	TD26795
DW10BTED4 (RHJ) (Euro 4)	4cyl.	1997cc	100kW (136PS)	Diesel	Turbo Intercooled	TD19825
DW10BTED4 (RHR) (Euro 4)	4cyl.	1997cc	100-101kW (136-138PS)	Diesel	Turbo Intercooled	TD19912
DW10UTED4 (RHK) (Euro 4)	4cyl.	1997cc	79-88kW (107-120PS)	Diesel	Turbo Intercooled	TD20787
C4 2.0 HDi			11/04→07/11		C5 III 2.0 HDi 140	11/08→
C4 GRAND PICASSO I 2.0 HDi 138			10/06→12/13		C8 2.0 HDi	07/06→
C4 I 2.0 HDi			11/04→07/11		C8 2.0 HDi 135	03/06→
C4 PICASSO I 2.0 HDi 138			10/06→08/13		JUMPY 2.0 HDi	01/09→03/16
C5 2.0 HDi			09/04→01/08		JUMPY 2.0 HDi 120	01/07→03/16
C5 II 2.0 HDi			09/04→		JUMPY 2.0 HDi 140	01/07→03/16
C5 III 2.0 HDi			02/08→			

87-114700-40 STD
87-114708-40 0.60mm

A 46.70
B- 15.40
BØ 44.80
C 0.57
D 72.71
 28x70

(08570-109)

AK KK RT TP



08-114700-00 STD
08-114708-00 0.60mm

3.50  CK P
2.00  P
3.00  CR P

85.00

39

DW10FC (AHW) (Euro 5)	4cyl.	1997cc	133kW (181PS)	Diesel	Turbo Intercooled	TD28616
DW10FD (AHR) (Euro 5)	4cyl.	1997cc	110kW (150PS)	Diesel	Turbo Intercooled	TD31846
DW10FD (AHX) (Euro 5)	4cyl.	1997cc	110kW (150PS)	Diesel	Turbo Intercooled	TD28615
DW10FDD (AHV) (Euro 5)	4cyl.	1997cc	100kW (136PS)	Diesel	Turbo Intercooled	TD28617
C4 GRAND PICASSO II 2.0			06/13→		DS4 2.0	07/14→07/15
C4 II 2.0 HDi			11/09→		DS4 2.0 HDi	09/11→07/15
C4 PICASSO II			09/13→		DS5 2.0	08/13→07/15
C4 PICASSO II 2.0			09/13→		GRAND C4 SPACETOURER 2.0	04/18→
C4 SPACETOURER 2.0			04/18→		JUMPY 2.0	04/16→
C5 III 2.0 HDi 150			04/09→02/15		SPACETOURER 2.0	04/16→
C5 III 2.0 HDi 180			03/15→			





87-443100-10 STD
87-443108-10 0.60mm

A 46.60
B- 12.71
B- 4.90
BØ 51.30
D 72.00
 30x72



AK KK RT TP

08-443100-00 STD
08-443108-00 0.60mm

2.00 GDC P
 2.00 P
 2.00 CR P



Bowl capacity 23.18cm³

Volumen der Kolbenmulde 23.18cm³

Volume de la cavité du piston 23.18cm³

Vol. cavidad pistón 23.18cm³

Volume camera pistone 23.18cm³

85.00

40

DW12BTED4 (4HP) (Euro 4)	4cyl.	2179cc	120kW (163PS)	Diesel	Turbo Intercooled	TD29271
DW12BTED4 (4HR) (Euro 4)	4cyl.	2179cc	120kW (163PS)	Diesel	Turbo Intercooled	TD29272
DW12BTED4 (4HT) (Euro 4)	4cyl.	2179cc	120-125kW (163-170PS)	Diesel	Turbo Intercooled	TD20812
DW12MTED4 (4HN)	4cyl.	2179cc	115kW (156PS)	Diesel	Turbo Intercooled	TD24713
C5 II 2.2 HDi			04/06→08/08	C6 2.2 HDi		06/06→12/12
C5 III 2.2 HDi			02/08→12/11	C8 2.2 HDi		06/06→
C5 III 2.2 HDi 165			02/08→	C-CROSSER 2.2 HDi		02/07→

87-436700-10 STD
87-436708-10 0.60mm

A 48.70
B- 13.47
BØ 52.40
C 0.38
D 74.71
 30x68



(0850HA127)

AK KK RT TP

08-436700-00 STD
08-436708-00 0.60mm

2.50 GDC P
 2.00 P
 2.00 CK



For pistons with a 24.3mm con rod gap measured at pin centre line

Für Kolben mit einem Pleuelaugenabstand von 24,3 MM, gemessen an der Kolbenbolzen-Mitte

Pour pistons avec un écart de bielle de 24,3 mm mesuré au centre de l'axe bielle-piston

Para pistones con una distancia de paso de biela en el centro del bulón de 24,3mm

Per pistoni con passaggio biella di 24,3 mm misurato sull' a sse foro spinotto

85.00

41

DW12C (4HL)	4cyl.	2179cc	150kW (204PS)	Diesel	Turbo Intercooled	TD26899
C5 III 2.2 HDi 200			07/10→			

87-436700-00 STD
87-436708-00 0.60mm

A 48.60
B- 15.12
BØ 50.40
C 0.38
D 74.61
 30x68



(0850HA324)

AK KK RT TP

08-436700-00 STD
08-436708-00 0.60mm

2.50 GDC P
 2.00 P
 2.00 CK



For pistons with a 24.3mm con rod gap measured at pin centre line

Für Kolben mit einem Pleuelaugenabstand von 24,3 MM, gemessen an der Kolbenbolzen-Mitte

Pour pistons avec un écart de bielle de 24,3 mm mesuré au centre de l'axe bielle-piston

Para pistones con una distancia de paso de biela en el centro del bulón de 24,3mm

Per pistoni con passaggio biella di 24,3 mm misurato sull' a sse foro spinotto

85.00

42

DW12TED4 (4HW)	4cyl.	2179cc	94kW (128PS)	Diesel	Turbo Intercooled	TD20024
DW12TED4/FAP (4HX)	4cyl.	2179cc	98kW (133PS)	Diesel	Turbo Intercooled	TD16165





C5 I 2.2 HDi	03/01→08/04	C8 2.2 HDi	07/02→
C5 II 2.2 HDi	09/04→	C8 HDi	11/03→07/06

87-114700-30 STD

A 48.70
B- 18.00
BØ 40.80
C 0.40
C 0.40
D 77.70
 30x68



AK KK RT

08-114700-00 STD

08-114708-00 0.60mm

3.50 CK P
2.00 P
3.00 CR P

86.00

43

P22DTE (4HG)	4cyl.	2198cc	81kW (110PS)	Diesel	Turbo Intercooled	TD32329
P22DTE (4HH)	4cyl.	2198cc	96kW (130PS)	Diesel	Turbo Intercooled	TD30660
P22DTE (4HJ)	4cyl.	2198cc	110kW (150PS)	Diesel	Turbo Intercooled	TD32330

JUMPER 2.2 HDi 110	07/11→	JUMPER 2.2 HDi 150	07/11→
JUMPER 2.2 HDi 130	07/11→		

87-427700-50 STD

87-427707-50 0.50mm

A 48.42
B- 16.17
BØ 49.04
D 74.82
 30x67

(08683-607)

AK KK RT TP



08-427700-00 STD

08-427705-00 0.25mm

08-427707-00 0.50mm

2.00 CK P
2.00 P
2.00 NT

*** CAUTION - CHECK BOWL DIAMETER *** *** ACHTUNG - MULDEN DURCHMESSER ÜBERPRÜFEN ***

** Attention & veuillez vérifier le diamètre du bol**

** Precaución - verifica el diámetro del bulón **

** attenzione & controllare diametro camera di combustione **

Steel

Stahl

Acier

Acero

Acciaio

86.00

44

P22DTE (4HU)	4cyl.	2198cc	88kW (120PS)	Diesel	Turbo Intercooled	TD24538
--------------	-------	--------	--------------	--------	-------------------	---------

JUMPER 2.2 HDi 120	04/06→		
--------------------	--------	--	--

87-427700-10 STD

87-427707-10 0.50mm

A 43.42
B- 15.85
BØ 46.90
D 69.82
 30x67

(8648B105)

KK RT TP



08-427700-00 STD

08-427705-00 0.25mm

08-427707-00 0.50mm

2.00 CK P
2.00 P
2.00 NT

14-021120-00 D

B 89.00 C 156.00 D 90.90 E 5.00

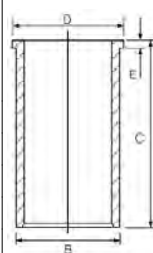

Steel

Stahl

Acier

Acero

Acciaio

86.00

45

P22DTE (4HV)	4cyl.	2198cc	74kW (101PS)	Diesel	Turbo Intercooled	TD24537
--------------	-------	--------	--------------	--------	-------------------	---------

JUMPER 2.2 HDi 100	04/06→		
--------------------	--------	--	--





87-427700-30 STD
87-427707-30 0.50mm

A 43.42
B- 15.85
BØ 46.90
D 69.82
 30x67
 (08650A105)
RT TP



08-427700-00 STD
08-427705-00 0.25mm
08-427707-00 0.50mm

2.00  CK P
 2.00  P
 2.00  NT ¹

14-021120-00 D

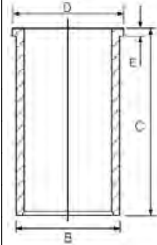

B 89.00 **C** 156.00 **D** 90.90 **E** 5.00

¹ Steel

¹ Stahl

¹ Acier

¹ Acero

¹ Acciaio

88.00

46

XN1T (170A)	4cyl.	1971cc	57-58kW (78-79PS)	Petrol	TD5164
XN1T (170B)	4cyl.	1971cc	57-62kW (78-84PS)	Petrol	TD589
XN1T (170C)	4cyl.	1971cc	62kW (84PS)	Petrol	TD590

C25 2.0

11/81→03/94

C25 2.0 E

09/81→03/94

A 38.25
B+ 0.65
D 71.85
 23x74



08-316900-00 STD
08-316907-00 0.50mm

1.50  CR P
 2.00  P
 4.00  CR ²

14-636500-00 WH

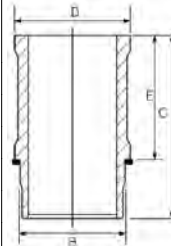

B 93.00 **C** 135.70 **D** 101.90 **E** 89.98

89-316900-00 ³
 14-636500-00

¹ Piston available in Kit Set only

² Steel

³ Includes seals

¹ Kolben nur im Assembly erhältlich

² Stahl

³ Schließt Dichtungen ein

¹ Piston disponible en kit seulement

² Acier

³ Inclut des joints

¹ Pistón disponible en conjuntos solamente.

² Acero

³ Incluye los sellos

¹ I pistoni sono disponibili solo in kit motore

² Acciaio

³ Comprende le guarnizioni

92.00

47

DJ5 (T9A)	4cyl.	2446cc	63kW (86PS)	Diesel	TD4293
------------------	-------	---------------	--------------------	---------------	---------------

JUMPER 2.5 D

03/94→04/02

87-112400-00 STD
87-112407-00 0.50mm

A 49.90
B- 3.00
D 80.00
 34x58



08-112400-00 STD
08-112407-00 0.50mm

2.25  CK P
 2.00  P
 2.00  CR P

AK TP

92.00

48

DJ5T (T8A)	4cyl.	2446cc	76kW (103PS)	Diesel	Turbo Intercooled	TD4292
DJ5T (THZ)	4cyl.	2446cc	76kW (103PS)	Diesel	Turbo Intercooled	TD6585
DK5ATE (THY)	4cyl.	2446cc	95kW (129PS)	Diesel	Turbo Intercooled	TD4294

JUMPER 2.5 DT

10/96→08/97

XM 2.5 TD

05/94→10/00

JUMPER 2.5 TD

03/94→04/02





87-326300-00 STD
87-326307-00 0.50mm

A 49.84
B- 2.30
D 82.00
 34x68



AK HA KK RT TP

08-326300-00 STD
08-326307-00 0.50mm

3.00 PS P
 1.75 CR P
 3.50 CR P

A = 49.470, B = 81.600

93.00					49
B25637	4cyl.	2500cc	51kW (69PS)	Diesel	TD6895
CRD93B	4cyl.	2500cc	50kW (70PS)	Diesel	TD6577
M22-629	4cyl.	2500cc	55kW (75PS)	Diesel	TD23453
M25-629	4cyl.	2500cc	55kW (75PS)	Diesel	TD693
M25-637	4cyl.	2500cc	55kW (75PS)	Diesel	TD23454
M25-660	4cyl.	2500cc	54kW (75PS)	Diesel	TD696
M25-661	4cyl.	2500cc	55kW (75PS)	Diesel	TD23455
U25/661 (CRD93L)	4cyl.	2500cc	54-55kW (73-75PS)	Diesel	TD625
C25 2.5 D			11/81→07/94	CX I 2500 D	02/78→08/85
C35 2.5 D			02/80→01/94	CX II 25 D	08/85→12/92

87-152700-00 STD
87-152707-00 0.50mm

A 52.75
B- 7.30
D 87.75
 30x78



08-152700-00 STD
08-152707-00 0.50mm

2.50 MOL P
 2.00 P
 4.00 CR P

14-013481-00 D **B 96.10 C 163.00**

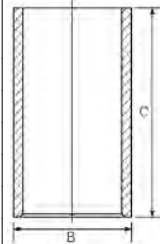

93.00					50
M25-648	4cyl.	2500cc	70kW (95PS)	Diesel Turbo	TD694
M25-669	4cyl.	2500cc	88kW (120PS)	Diesel Turbo Intercooled	TD702
U25/673 (CRD93LS)	4cyl.	2500cc	70kW (95PS)	Diesel Turbo	TD626
C25 2.5 DT			01/87→01/94	CX II 25 D Turbo	08/85→12/92
C25 2.5 D Turbo			08/87→02/94	CX II 25 D Turbo 2	01/87→12/92
CX I 25 D Turbo			04/83→08/85	CX II 2500 D Turbo	08/85→12/86
CX I 2500 D Turbo			04/83→08/85		

14-013481-00 D **B 96.10 C 163.00**

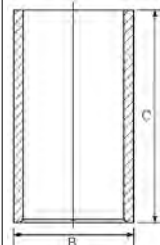



94.00

51

XD3/P 4cyl. **2498cc** **Diesel** **MP2303**

C35 2.5D 01/74→12/92

87-318700-10 STD
87-318706-10 0.40mm
 →12/93

A 54.00
B- 1.80
D 96.42
 30x79



08-318700-10 STD
08-318706-10 0.40mm
08-318708-10 0.60mm
08-318711-10 1.00mm

2.00  CR P
 2.00  P
 4.00  CR P

14-020660-00 D
14-021520-00 D

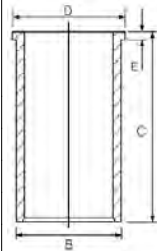

B 97.00 **C** 170.60 **D** 99.50 **E** 4.00
B 98.00 **C** 170.60 **D** 100.00 **E** 6.00

87-318700-30 STD
87-318710-30 0.80mm
 01/94→

A 54.00
B- 1.75
D 91.42
 30x79



08-318700-10 STD
08-318706-10 0.40mm
08-318708-10 0.60mm
08-318711-10 1.00mm

2.00  CR P
 2.00  P
 4.00  CR P

94.40

52

8140.43N (Euro 3 Sofim) 4cyl. **2800cc** **107kW** (145PS) **Diesel Turbo Intercooled** **TD18297**

8140.43S (Euro 3 Sofim) 4cyl. **2800cc** **94kW** (128PS) **Diesel Turbo Intercooled** **TD17849**

F28TDCR (Euro 3 SOFIM 2800 HDI) 4cyl. **2800cc** **94kW** (128PS) **Diesel Turbo Intercooled** **TD16741**

JUMPER 2.8 HDi 09/00→06/06

87-122200-00 STD
87-122208-00 0.60mm

A 58.70
B- 21.30
BØ 39.40
D 87.60
 32x72
AK KK RT TP



08-122200-00 STD
08-122208-00 0.60mm

2.50  CK P
 2.00  P
 2.50  CR P

14-021321-00 D
14-028930-00 D
14-028931-00 D
14-028932-00 D

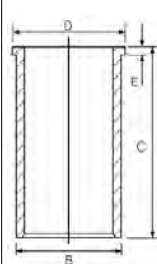

B 97.54 **C** 167.00 **D** 100.90 **E** 5.00
B 97.50 **C** 167.00 **D** 100.90 **E** 5.00
B 97.58 **C** 167.00 **D** 100.90 **E** 5.00
B 97.70 **C** 167.00 **D** 100.90 **E** 5.00

94.40

53

F28D (8140.63) (Euro 2 Sofim) 4cyl. **2800cc** **64kW** (87PS) **Diesel** **TD24977**

JUMPER 2.8 D 01/99→02/02





87-108200-00 STD
87-108208-00 0.60mm

A 55.00
 B- 2.80
 D 90.00
 32x68



AK HA RT TP

08-108200-00 STD
08-108208-00 0.60mm

3.00 CR P
 2.00 P
 2.50 CR P

14-021321-00 D B 97.54 C 167.00 D 100.90 E 5.00
14-028930-00 D B 97.50 C 167.00 D 100.90 E 5.00
14-028931-00 D B 97.58 C 167.00 D 100.90 E 5.00
14-028932-00 D B 97.70 C 167.00 D 100.90 E 5.00

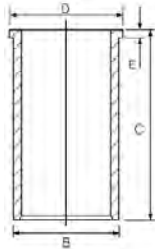

95.80

54

F1CE3481N (F30DTE) (Euro 5)	4cyl.	2999cc	107kW (146PS)	Diesel	Turbo	TD38534
F30DTE (F1CE3481E) (Euro 5)	4cyl.	2999cc	130kW (177PS)	Diesel	Turbo Intercooled	TD33859

JUMPER 3.0 HDi 145

07/10→

JUMPER 3.0 HDi 180

07/11→

87-421600-10 STD

A 63.00
 B- 16.00
 BØ 53.20
 D 93.40
 36x80



AK KK RT TP

08-421600-10 STD

2.50 GDC P
 2.00 P
 2.50 CK P



95.80

55

F30DT (F1CE0481D) (Euro 4)	4cyl.	2999cc	115-130kW (156-177PS)	Diesel	Turbo Intercooled	TD24616
-----------------------------------	-------	--------	-----------------------	--------	-------------------	---------

JUMPER 3.0 HDi 155

07/10→

JUMPER 3.0 HDi 160

09/06→

87-421600-00 STD

A 63.00
 B- 16.00
 BØ 50.50
 D 93.50
 36x80



AK KK RT TP

08-421600-00 STD

08-421606-00 0.40mm

2.50 CK P
 2.00 P
 2.50 CR P

Motorverzeichnis • Index de moteur • Índice de Motor
 Indeks silnika • Модель ДВИгателя • دليل المحرك

ENGINE INDEX



CCM

x



9

MAN (D25/28)	1/2	90.00	3
MERCEDES-BENZ (OM360/400/420/440)	1/2	90.00	4
MERCEDES-BENZ (OM402/501/502/541/542/LA)	1	100.00	5
WESTINGHOUSE (MB OM457/904/906, DAF 825/1160)	1	85.00	2
WESTINGHOUSE WB15 (Volvo TD100)	2	75.00	1



75.00

1

WESTINGHOUSE WB15 (Volvo TD100)

2cyl.

MP1846

87-990707-00 0.50mm

A 32.20
D 52.65
16x60



08-990700-00 STD

08-990705-00 0.25mm

08-990707-00 0.50mm

2.38 P

2.38 P

3.94 P



85.00

2

WESTINGHOUSE (MB OM457/904/906, DAF 825/1160)

1cyl.

MP15572-1

87-741200-10 STD

87-741207-10 0.50mm

87-741211-10 1.00mm

A 33.30
D 59.15
19.05x60



08-741200-00 STD

08-741204-00 0.20mm

08-741207-00 0.50mm

2.00 P

2.00 P

4.00 P



90.00

3

MAN (D25/28)

1/2cyl.

MP5548

14-000230-00 DH ①

B 95.00 C 104.00 D 127.00 E 94.00

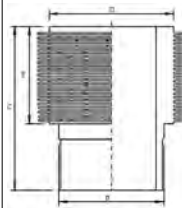

14-000240-00 WH ②

B 95.00 C 104.00 D 140.00 E 94.00

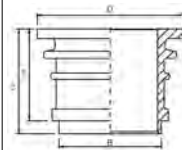

① Air cooled
② Water cooled

① luftgekühlt
② Wassergekühlt

① refroidi par air
② Refroidi par eau

① refrigerado por aire
② Refrigerado por agua

① Raffreddato ad aria
② Raffreddamento ad acqua

90.00

4

MERCEDES-BENZ (OM360/400/420/440)

1/2cyl.

MP5572





<p>87-404500-00 STD 87-404511-00 1.00mm</p> <p>A 35.00 D 57.50 20x60</p>	<p>08-404500-00 STD</p> <p>2.50 2.50 4.00</p> <p>P P CR 1</p>	<p>14-000240-00 WH 2</p> <p>B 95.00 C 104.00 D 140.00 E 94.00</p>	<p>88-404500-00 87-404500-00 + 14-000240-00</p>
		<p>14-000230-00 DH 3</p> <p>B 95.00 C 104.00 D 127.00 E 94.00</p>	<p>88-404500-10 87-404500-00 + 14-000230-00</p>

- 1 Steel
- 2 Water cooled
- 3 Air cooled

- 1 Stahl
- 2 Wassergekühlt
- 3 luftgekühlt

- 1 Acier
- 2 Refroidi par eau
- 3 refroidi par air

- 1 Acero
- 2 Refrigerado por agua
- 3 refrigerado por aire

- 1 Acciaio
- 2 Raffreddamento ad acqua
- 3 Raffreddato ad aria

100.00 **5**

MERCEDES-BENZ 1cyl. **MP15603**
(OM402/501/502/541/542/LA)

<p>87-140500-00 STD</p> <p>A 30.40 D 52.20 20x50</p>	<p>08-140500-00 STD</p> <p>2.50 2.50 4.00</p> <p>P P CR</p>	<p>14-000350-00 DH 1</p> <p>B 115.00 C 102.00 D 131.00 E 94.00 B 106.00 C 101.00 D 130.00 E 94.00</p>	<p>88-140500-00 87-140500-00 88-140500-10 87-140500-00 + 14-000350-00</p>
---	--	--	--

1 Liner available in Kit Set only

1 Zylinderlaufbuchse nur in Assemblies verfügbar

1 Chemise disponible en kit seulement

1 Camisas disponible en conjuntos solamente.

1 Cilindro disponibile solo in kit motore



102.00 **1**

6 BT	6cyl.	5880cc	118-173kW (160-235PS)	Diesel	Turbo	TD6966
6 BT5.9	6cyl.	5883cc	74-154kW (101-210PS)	Diesel	Turbo	TD6613
6 BTA-5.9	6cyl.	5883cc	115-118kW (156-160PS)	Diesel	Turbo Intercooled	TD7047

ELITE	01/79→	SB	01/99→
GLOBUS	03/08→12/16	SE	11/03→02/17
LP	02/02→	Series 2500	01/08→
LPK	11/03→	Series 3100	11/13→
LPO	10/03→	SIGNA	02/16→03/18
LPS	09/07→	SK	11/03→12/04
LPT	11/03→	STARBUS	03/11→

14-020610-00 D **B 106.12 C 204.85 D 108.91 E 4.10 F 0.84**

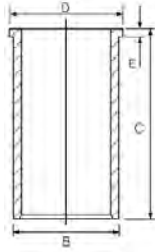

CCM
x

9

D4F 732	Petrol	1149	4	69.00	1
F8Q 600	Diesel	1870	4	80.00	14
F8Q 630	Diesel	1870	4	80.00	15
H4B 400	Petrol	898	3	72.20	2
H4B 408	Petrol	898	3	72.20	2
H5F 402 (Euro 5/6)	Petrol	1198	4	72.20	3
H5F 404 (Euro 5/6)	Petrol	1198	4	72.20	3
H5F 408 (Euro 5/6)	Petrol	1197	4	72.20	3
H5F 410 (Euro 5/6)	Petrol	1198	4	72.20	3
K4M 606	Petrol	1598	4	79.50	10
K4M 690	Petrol	1598	4	79.50	10
K4M 694	Petrol	1598	4	79.50	10
K4M 696	Petrol	1598	4	79.50	10
K7J 710	Petrol	1390	4	79.50	11
K7J 714	Petrol	1390	4	79.50	11
K7M 710	Petrol	1598	4	79.50	12
K7M 732 (Euro 4)	Petrol	1598	4	79.50	13
K9K 612	Diesel	1461	4	76.00	4
K9K 626	Diesel	1461	4	76.00	4
K9K 790	Diesel	1461	4	76.00	5
K9K 792 (Euro 4)	Diesel	1461	4	76.00	6
K9K 796	Diesel	1461	4	76.00	7
K9K 846	Diesel	1461	4	76.00	8
K9K 856 (Euro 5)	Diesel	1461	4	76.00	9
K9K 858 (Euro 5)	Diesel	1461	4	76.00	9
K9K 884 (Euro 5)	Diesel	1461	4	76.00	4
K9K 892	Diesel	1461	4	76.00	9
K9K 894	Diesel	1461	4	76.00	9
K9K 896	Diesel	1461	4	76.00	9
K9K 898	Diesel	1461	4	76.00	9

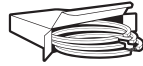

69.00

1

D4F 732	4cyl.	1149cc	54-55kW (73-75PS)	Petrol	TD23529
LOGAN 1.2 16V			02/06→	SANDERO 1.2 16V	11/08→
LOGAN II 1.2			10/12→	SANDERO 1.2 16V LPG	11/08→
LOGAN MCV II 1.2			02/13→	SANDERO II 1.2	10/12→

87-450000-00 STD
87-450007-00 0.50mm

08-450000-10 STD
08-450007-10 0.50mm

A 26.70
B- 1.10
BØ 60.30
D 44.70
18x54



1.20 NT
1.50 P
2.50 CR



Steel

Stahl

Acier

Acero

Acciaio

72.20

2

H4B 400	3cyl.	898cc	66kW (90PS)	Petrol	Turbo Intercooled	TD31427
H4B 408	3cyl.	898cc	66kW (90PS)	Petrol	Turbo Intercooled	TD34589
LOGAN II TCe 90			10/12→	SANDERO II TCe 90		10/12→
LOGAN MCV II TCe 90			02/13→			

87-450400-10 STD

08-450400-00 STD

A 31.247mm
B- 4.704mm
BØ 61.54mm
C 2.927mm
C 0.457mm
D 48.74
19.99x43.00

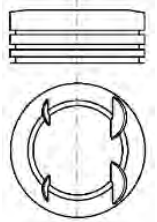

1.20 PVD NT
1.50 P
2.00 NT



Steel

Stahl

Acier

Acero

Acciaio

72.20

3

H5F 402 (Euro 5/6)	4cyl.	1198cc	84-85kW (115-116PS)	Petrol	Turbo Intercooled	TD27174
H5F 404 (Euro 5/6)	4cyl.	1198cc	92kW (125PS)	Petrol	Turbo Intercooled	TD31424
H5F 408 (Euro 5/6)	4cyl.	1197cc	74-97kW (101-132PS)	Petrol	Turbo Intercooled	TD35727
H5F 410 (Euro 5/6)	4cyl.	1198cc	92kW (125PS)	Petrol	Turbo Intercooled	TD33469
DOKKER 1.2 TCe			11/12→	DUSTER 1.2 TCe 125		10/13→
DOKKER Express 1.2 TCe 115			12/12→	LODGY 1.2 TCe		03/12→

87-450400-00 STD
03/12→

08-450400-00 STD

A 31.25
B- 5.00
BØ 57.00
C 2.50
C 1.18
D 49.00
20x47



1.20 PVD NT
1.50 P
2.00 NT



92kW→

Steel

Stahl

Acier

Acero

Acciaio



76.00

4

K9K 612	4cyl.	1461cc	55-66kW (75-90PS)	Diesel	Turbo Intercooled	TD28005
K9K 626	4cyl.	1461cc	55-66kW (75-90PS)	Diesel	Turbo Intercooled	TD34129
K9K 884 (Euro 5)	4cyl.	1461cc	66kW (90PS)	Diesel	Turbo Intercooled	TD31046
DOKKER 1.5 dCi			11/12→	LOGAN II 1.5 dCi		10/12→
DOKKER 1.5 dCi / Blue dCi 75			11/12→	LOGAN II 1.5 dCi / Blue dCi 75		10/12→
DOKKER Express 1.5 dCi			12/12→	LOGAN MCV II 1.5 dCi		02/13→
DOKKER Express 1.5 dCi 75 / Blue dCi 75			12/12→	SANDERO II 1.5 dCi		10/12→
DUSTER 1.5 dCi			10/10→	SANDERO II 1.5 dCi 75 / Blue dCi 75		10/12→
LODGY 1.5 dCi			03/12→			

87-123400-40 STD
87-123407-40 0.50mm

- A** 41.70
- B-** 13.50
- BØ** 47.00
- C** 0.43
- C** 0.25
- D** 66.00
-  26x60
- (7657-701)
- AK KK RT TP**



08-123400-30 STD
08-123405-30 0.25mm
08-123407-30 0.50mm

- 2.00  CK P
- 2.00  P
- 2.50  CR P

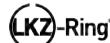

14-020650-00 D **B 79.10 C 142.00 D 81.00 E 5.00**

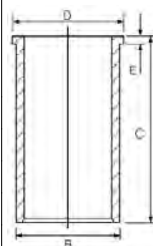

76.00

5

K9K 790	4cyl.	1461cc	48kW (65PS)	Diesel	Turbo Intercooled	TD18514
LOGAN 1.5 dCi			09/05→	SANDERO 1.5 dCi		11/08→
LOGAN MCV 1.5 dCi			04/08→06/13			

87-123400-00 STD
87-123407-00 0.50mm

- A** 41.69
- B-** 13.70
- BØ** 39.70
- C** 0.60
- D** 66.05
-  25x60
- RT TP**



08-123400-00 STD
08-123407-00 0.50mm

- 2.00  CK P
- 2.00  P
- 2.50  NT

14-020650-00 D **B 79.10 C 142.00 D 81.00 E 5.00**

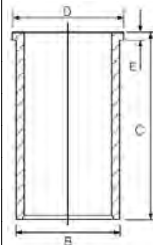

87-123400-10 STD
87-123407-10 0.50mm

- A** 41.82
- B-** 13.70
- BØ** 39.70
- C** 0.60
- D** 66.05
-  26x60
- (557.503)
- RT TP**



08-123400-00 STD
08-123407-00 0.50mm

- 2.00  CK P
- 2.00  P
- 2.50  NT

76.00

6

K9K 792 (Euro 4)	4cyl.	1461cc	50kW (68PS)	Diesel	Turbo Intercooled	TD19223
LOGAN 1.5 dCi			01/06→	SANDERO 1.5 dCi		11/08→
LOGAN MCV 1.5 dCi			02/07→			





87-123400-10 STD
87-123407-10 0.50mm

A 41.82
B- 13.70
BØ 39.70
C 0.60
D 66.05
 26x60
(557.503)
RT TP



08-123400-00 STD
08-123407-00 0.50mm

2.00 CK P
2.00 P
2.50 NT

14-020650-00 D **B 79.10 C 142.00 D 81.00 E 5.00**

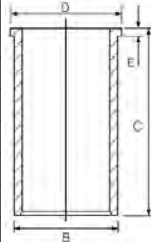

76.00

7

K9K 796	4cyl.	1461cc	63kW (86PS)	Diesel	Turbo Intercooled	TD22403
DUSTER 1.5 dCi			04/10→01/18	LOGAN MCV 1.5 dCi		09/07→12/12
LOGAN 1.5 dCi			09/07→	SANDERO 1.5 dCi		11/08→

87-123400-20 STD
87-123407-20 0.50mm

A 41.70
B- 14.00
BØ 39.70
C 0.43
C 0.25
D 66.00
 26x60
(07657-101)
AK KK RT TP



08-123400-00 STD
08-123407-00 0.50mm

2.00 CK P
2.00 P
2.50 NT

14-020650-00 D **B 79.10 C 142.00 D 81.00 E 5.00**

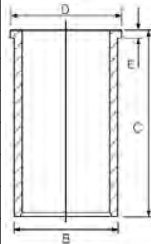

76.00

8

K9K 846	4cyl.	1461cc	79-81kW (107-110PS)	Diesel	Turbo Intercooled	TD31425
LODGY 1.5 dCi			03/12→			

87-123400-40 STD
87-123407-40 0.50mm

A 41.70
B- 13.50
BØ 47.00
C 0.43
C 0.25
D 66.00
 26x60
(7657-701)
AK KK RT TP



08-123400-30 STD
08-123405-30 0.25mm
08-123407-30 0.50mm

2.00 CK P
2.00 P
2.50 CR P



14-020650-00 D **B 79.10 C 142.00 D 81.00 E 5.00**

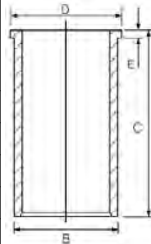



87-123400-50 STD
87-123407-50 0.50mm

A 41.74
B- 13.50
BØ 47.00
C 0.43
C 0.25
D 66.00
 26x60



(7658-502)
AK RT TP

08-123400-30 STD
08-123405-30 0.25mm
08-123407-30 0.50mm

2.00  CK P
 2.00  P
 2.50  CR P



76.00

9

K9K 856 (Euro 5)	4cyl.	1461cc	80-81kW (109-110PS)	Diesel	Turbo Intercooled	TD28611
K9K 858 (Euro 5)	4cyl.	1461cc	80-81kW (109-110PS)	Diesel	Turbo Intercooled	TD28610
K9K 892	4cyl.	1461cc	55-66kW (75-90PS)	Diesel	Turbo Intercooled	TD24780
K9K 894	4cyl.	1461cc	66-67kW (90-91PS)	Diesel	Turbo Intercooled	TD24783
K9K 896	4cyl.	1461cc	79-81kW (107-110PS)	Diesel	Turbo Intercooled	TD24784
K9K 898	4cyl.	1461cc	79-81kW (107-110PS)	Diesel	Turbo Intercooled	TD24785

DUSTER 1.5 dCi 06/10→ LOGAN MCV 1.5 dCi 05/10→
 LOGAN 1.5 dCi 05/10→ SANDERO 1.5 dCi 05/10→

14-020650-00 D **B 79.10 C 142.00 D 81.00 E 5.00**

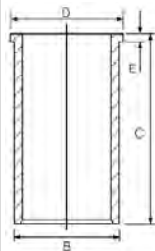

79.50

10

K4M 606	4cyl.	1598cc	77kW (105PS)	Petrol	TD24782
K4M 690	4cyl.	1598cc	77kW (105PS)	Petrol	TD20941
K4M 694	4cyl.	1598cc	77kW (105PS)	Petrol	TD24876
K4M 696	4cyl.	1598cc	77kW (105PS)	Petrol	TD24781

DUSTER 1.6 16V 04/10→ LOGAN MCV 1.6 16V 02/07→
 LOGAN 1.6 16V 02/06→ SANDERO 1.6 16V 01/11→

87-104200-30 STD

A 31.70
B- 1.30
C 1.60
D 55.00
 20x62



08-104200-00 STD
08-104207-00 0.50mm

1.50  CR P
 1.50  P
 2.50  CR 

 Steel

 Stahl

 Acier

 Acero

 Acciaio

79.50

11

K7J 710	4cyl.	1390cc	55kW (75PS)	Petrol	TD18140
K7J 714	4cyl.	1390cc	53-55kW (72-75PS)	Petrol	TD23531





LOGAN 1.4	09/04→	SANDERO 1.4	06/08→
LOGAN 1.4 LPG	02/06→12/12	SANDERO 1.4 LPG	01/09→
LOGAN MCV 1.4	02/07→		

87-104200-40 STD
87-104207-40 0.50mm

A 35.83
D 58.00
19x62



08-104200-00 STD
08-104207-00 0.50mm

1.50 CR P
1.50 P
2.50 CR 1



1 Steel 1 Stahl 1 Acier 1 Acero 1 Acciaio

79.50 **12**

K7M 710 4cyl. **1598cc** **64kW (87PS)** **Petrol** **TD18141**

LOGAN 1.6	09/04→	SANDERO 1.6	06/08→
LOGAN MCV 1.6	02/07→		

87-104200-00 STD 1
87-104207-00 0.50mm 1

A 31.80
B+ 2.55
D 56.30
19x63



08-104200-00 STD
08-104207-00 0.50mm

1.50 CR P
1.50 P
2.50 CR 2



87-104200-10 STD 3
87-104207-10 0.50mm 3

A 31.80
B+ 2.55
D 56.30
19x63



08-104200-00 STD
08-104207-00 0.50mm

1.50 CR P
1.50 P
2.50 CR 2



1 To cylinder 1 & 2 1 an Zylinder 1 & 2 1 sur cylindre 1 & 2 1 en el cilindro 1 & 2 1 a cilindro 1 & 2
2 Steel 2 Stahl 2 Acier 2 Acero 2 Acciaio
3 To cylinder 3 & 4 3 an Zylinder 3 & 4 3 sur cylindre 3 & 4 3 en el cilindro 3 & 4 3 a cilindro 3 & 4

79.50 **13**

K7M 732 (Euro 4) 4cyl. **1598cc** **64kW (87PS)** **Petrol** **TD23533**

LOGAN 1.6	09/04→	SANDERO 1.6	06/08→12/12
-----------	--------	-------------	-------------





87-443700-00 STD
87-443707-00 0.50mm

A 28.31
D 52.81
 19x62



08-443700-00 STD
08-443707-00 0.50mm

1.50 CK P
 1.50 P
 2.50 CR

Steel

Stahl

Acier

Acero

Acciaio

80.00

14

F8Q 600 4cyl. **1870cc** **44-48kW** (60-65PS) **Diesel** **TD22200**

SOLENZA 1.9 D 06/03 →

87-336500-00 STD
87-336507-00 0.50mm

A 42.35
B- 0.70
D 70.50
 24x63

RT



08-336500-00 STD
08-336505-00 0.25mm
08-336507-00 0.50mm

2.00 MO P
 2.00 P
 3.00 CR P

80.00

15

F8Q 630 4cyl. **1870cc** **46-48kW** (63-65PS) **Diesel** **TD22401**

1310 1.9 D 01/03 → 07/04 SOLENZA 1.9 D 02/03 →

87-336500-10 STD
87-336507-10 0.50mm

A 42.25
B- 1.58
D 70.50
 24x63



08-336500-00 STD
08-336505-00 0.25mm
08-336507-00 0.50mm

2.00 MO P
 2.00 P
 3.00 CR P

ENGINE INDEX

Motorverzeichnis • Index de moteur • Índice de Motor
 Indeks silnika • Модель Двигателя • دليل المحرك



CCM

x



9

C20NE	Petrol	1998	4	86.00	2
M 104.992	Petrol	3199	6	89.90	3
M 104.995	Petrol	3199	6	89.90	3
M 111.970	Petrol	2295	4	90.90	4
M 161.970	Petrol	2295	4	90.90	4
M 161.974	Petrol	2295	4	90.90	4
Z 20 DMH	Diesel	1991	4	83.00	1



83.00

1

Z 20 DMH 4cyl. **1991cc** **110kW** (150PS) **Diesel** **Turbo Intercooled** **TD26675**

TOSCA 2.0 TDCi 02/06→

87-879200-00 *STD*
87-879207-00 *0.50mm*

A 46.35
B- 13.95
BØ 46.70
D 72.35
 28x67



08-879200-00 *STD*
08-879207-00 *0.50mm*

2.00  CR P
2.00  P
3.00  NT ①

① Steel ① Stahl ① Acier ① Acero ① Acciaio

86.00

2

C20NE 4cyl. **1998cc** **85kW** (115PS) **Petrol** **TD21445**

ESPERO 2.0 09/93→10/94

87-306800-30 *STD*

A 30.40
B- 5.00
BØ 57.00
D 50.40
 21x62



08-306800-00 *STD*
08-306807-00 *0.50mm*
08-306811-00 *1.00mm*

1.50  CR P
1.50  P
3.00  CR ①

① Steel ① Stahl ① Acier ① Acero ① Acciaio

89.90

3

M 104.992 6cyl. **3199cc** **162kW** (220PS) **Petrol** **TD22988**

M 104.995 6cyl. **3199cc** **154-156kW** (209-212PS) **Petrol** **TD22990**

KORANDO 3.2 01/99→ MUSSO 3.2 01/99→

87-287500-30 *STD* ①
87-287505-30 *0.25mm* ①
87-287507-30 *0.50mm* ①

A 31.12
B- 1.20
BØ 74.00
C 1.60
C 2.50
D 56.10
 22x56
(09024)



08-287500-00 *STD*
08-287505-00 *0.25mm*
08-287507-00 *0.50mm*

1.50  NT ②
1.75  P
3.00  CR P

① Elastoval® ② Steel ② Stahl ② Acier ② Acero ② Acciaio

90.90

4

M 111.970 4cyl. **2295cc** **103-110kW** (140-150PS) **Petrol** **TD22989**

M 161.970 4cyl. **2295cc** **103-110kW** (140-150PS) **Petrol** **TD26690**

M 161.974 4cyl. **2295cc** **110kW** (150PS) **Petrol** **TD26679**

KORANDO 2.3 01/99→ REXTON 2.3 RX230 05/02→

MUSSO 2.3 01/99→



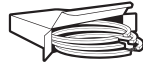

87-109100-10 STD
87-109107-10 0.50mm

08-109100-00 STD
08-109107-00 0.50mm

A 30.00
B- 1.10
BØ 70.00
C 0.85
D 55.00
 22x56
 (09130)



1.50  NT
 1.75  NT
 3.00  NT

Steel

Stahl

Acier

Acero

Acciaio



CCM



9

110E	Petrol	1108	4	70.00	1
110F	Petrol	1108	4	70.00	1
110G	Petrol	1108	4	70.00	1
DF 615	Diesel	6150	6	104.18	5
DH 825	Diesel	8250	6	118.00	9
DHB 825	Diesel	8250	6	118.00	9
DHR 825	Diesel	8250	6	118.00	9
DHS 825	Diesel	8250	6	118.00	9
DHS 825SM	Diesel	8250	6	118.00	9
DHT 825	Diesel	8250	6	118.00	9
DHTD 825	Diesel	8250	6	118.00	9
DHU 825	Diesel	8250	6	118.00	9
DJ5T	Diesel	2446	4	92.00	2
DK 1160	Diesel	11630	6	130.00	10
DKA 1160	Diesel	11600	6	130.00	10
DKB 1160	Diesel	11600	6	130.00	10
DKCL 1160	Diesel	11630	6	130.00	11
DKD 1160	Diesel	11630	6	130.00	10
DKDL 1160	Diesel	11630	6	130.00	10
DKFL 1160	Diesel	11630	6	130.00	11
DKL 1160	Diesel	11630	6	130.00	10
DKS 1160	Diesel	11600	6	130.00	11
DKS 1160 E	Diesel	11600	6	130.00	11
DKSB 1160	Diesel	11630	6	130.00	11
DKSE 1160	Diesel	11630	6	130.00	12
DKT 1160	Diesel	11600	6	130.00	11
DKTD 1160	Diesel	11600	6	130.00	11
DKTL 1160	Diesel	11600	6	130.00	11
DKV 1160	Diesel	11600	6	130.00	12
DKVL 1160	Diesel	11600	6	130.00	11
DKX 1160	Diesel	11600	6	130.00	11
DKX 1160 ATI	Diesel	11600	6	130.00	12
DKXE 1160	Diesel	11600	6	130.00	12
DKXE 1160 ATI	Diesel	11630	6	130.00	12
DKZ 1160	Diesel	11630	6	130.00	12
DKZ 1160 ATI	Diesel	11600	6	130.00	12
DNS 620	Diesel	6240	6	104.18	6
DNT 620	Diesel	6240	6	104.18	6
DNTD 620	Diesel	6240	6	104.18	6
DT 615	Diesel	6150	6	104.18	5
DTD 615	Diesel	6150	6	104.18	5
DU 825	Diesel	8250	6	118.00	9
EN 55	Diesel	2498	4	94.00	3
ET 70	Diesel	2498	4	94.00	4
FR 103 S1 (Euro 4)	Diesel	4460	4	107.00	8
FR 118 S1 (Euro 4)	Diesel	4460	4	107.00	8
FR 136 S1 (Euro 4)	Diesel	4460	4	107.00	8
FR 152 (Euro 5)	Diesel	4460	4	107.00	8
GR 165 S1	Diesel	6690	6	107.00	8
GR 184 S1 (Euro 4)	Diesel	6690	6	107.00	8
GR 210 S1 (Euro 4)	Diesel	6690	6	107.00	8
GR 220 (Euro 4)	Diesel	6690	6	107.00	8
HS 200	Diesel	8250	6	118.00	9
HS 825	Diesel	8250	6	118.00	9
HT 168	Diesel	8250	6	118.00	9
HT 825	Diesel	8250	6	118.00	9
KT 191	Diesel	11600	6	130.00	11
LT 160	Diesel	11630	6	130.00	11
LT 195 1160	Diesel	11600	6	130.00	11
LT 210	Diesel	11630	6	130.00	11

ENGINE INDEX

Motorverzeichnis • Index de moteur • Índice de Motor
 Indeks silnika • Модель Двигателя • دليل المحرك



CCM

x



9

MX-13 303 (Euro 6)	Diesel	12903	6	130.00	15
MX-13 340 (Euro 6)	Diesel	12902	6	130.00	15
MX-13 375 (Euro 6)	Diesel	12902	6	130.00	15
MX 265 (Euro 4/5)	Diesel	12902	6	130.00	13
MX 300 (Euro 4/5)	Diesel	12902	6	130.00	14
MX 340 (Euro 4/5)	Diesel	12902	6	130.00	14
MX 375 (Euro 4/5)	Diesel	12902	6	130.00	14
NS 156	Diesel	6240	6	104.18	7
NT 133	Diesel	6240	6	104.18	7
PE 183 C (Euro 3)	Diesel	9200	6	118.00	9
PE 212 C (Euro 3)	Diesel	9200	6	118.00	9
PE 235 C (Euro 3)	Diesel	9200	6	118.00	9
PF 183 M (Euro 2)	Diesel	9200	6	118.00	9
PF 212 M (Euro 2)	Diesel	9200	6	118.00	9
PF 235 M (Euro 2)	Diesel	9200	6	118.00	9
RS 180	Diesel	8650	6	118.00	9
RS 180 L (Euro 1)	Diesel	8650	6	118.00	9
RS 180 M (Euro 2)	Diesel	8650	6	118.00	9
RS 200	Diesel	8650	6	118.00	9
RS 200 L (Euro 1)	Diesel	8650	6	118.00	9
RS 200 M (Euro 2)	Diesel	8650	6	118.00	9
RS 222	Diesel	8650	6	118.00	9
RS 222 L (Euro 1)	Diesel	8650	6	118.00	9
RS 222 M (Euro 2)	Diesel	8650	6	118.00	9
WS 222 G	Diesel	11600	6	130.00	16
WS 222 L	Diesel	11600	6	130.00	10
WS 222 M	Diesel	11630	6	130.00	10
WS 225	Diesel	11600	6	130.00	10
WS 225 ATI	Diesel	11630	6	130.00	10
WS 242	Diesel	11600	6	130.00	10
WS 242 G	Diesel	11600	6	130.00	10
WS 242 L (Euro 1)	Diesel	11600	6	130.00	16
WS 242 M (Euro 2)	Diesel	11600	6	130.00	17
WS 259	Diesel	11600	6	130.00	10
WS 259 ATI	Diesel	11630	6	130.00	10
WS 268	Diesel	11600	6	130.00	10
WS 268 G	Diesel	11600	6	130.00	10
WS 268 L (Euro 1)	Diesel	11600	6	130.00	16
WS 268 M (Euro 2)	Diesel	11600	6	130.00	17
WS 282	Diesel	11600	6	130.00	10
WS 282 ATI	Diesel	11630	6	130.00	10
WS 282 L	Diesel	11630	6	130.00	10
WS 295	Diesel	11600	6	130.00	10
WS 295 G	Diesel	11600	6	130.00	10
WS 295 L (Euro 1)	Diesel	11600	6	130.00	16
WS 295 M (Euro 2)	Diesel	11600	6	130.00	17
WS 295 M ATI	Diesel	11627	6	130.00	10
WS 315	Diesel	11600	6	130.00	10
WS 315 G	Diesel	11600	6	130.00	10
WS 315 L (Euro 1)	Diesel	11600	6	130.00	16
WS 315 M (Euro 2)	Diesel	11600	6	130.00	17
XD 3P	Diesel	2498	4	94.00	3
XD 3T	Diesel	2497	4	94.00	4
XE 250 C (Euro 3)	Diesel	12580	6	130.00	10
XE 280 C (Euro 3)	Diesel	12580	6	130.00	10
XE 280 C1 (Euro 3)	Diesel	12580	6	130.00	18
XE 315 C (Euro 3)	Diesel	12580	6	130.00	10
XE 315 C1 (Euro 3)	Diesel	12580	6	130.00	18
XE 355 C (Euro 3)	Diesel	12580	6	130.00	10
XE 355 C1 (Euro 3)	Diesel	12580	6	130.00	10

Motorverzeichnis • Index de moteur • Índice de Motor
 Indeks silnika • Модель ДВИгателя • دليل المحرك

ENGINE INDEX



CCM

x



9

XE 390 C (Euro 3)	Diesel	12580	6	130.00	10
XE 390 C1 (Euro 3)	Diesel	12580	6	130.00	10
XF 250 M (Euro 2)	Diesel	12580	6	130.00	19
XF 280 M (Euro 2)	Diesel	12580	6	130.00	19
XF 315 M (Euro 2)	Diesel	12580	6	130.00	19
XF 355 M (Euro 2)	Diesel	12580	6	130.00	19



70.00 **1**

110E	4cyl.	1108cc	35kW (48PS)	Petrol	TD21909
110F	4cyl.	1108cc	40kW (54PS)	Petrol	TD21910
110G	4cyl.	1108cc	40kW (54PS)	Petrol	TD21911

55 1.1 MARATHON	12/71→09/72	66 1.1 MARATHON	10/72→08/75
66 1.1	10/72→08/75	66 1.1 SL	10/72→08/75

<p>A 40.00 D 68.00 18x62</p>	<p>08-334600-00 STD</p> <p>1.75 CR P 2.00 P 3.50 CR ②</p>	<p>WH ④ B 75.50 C 135.00 D 85.70 E 94.80</p>	<p>89-334600-00 ③</p>
	<p>① Piston available in Kit Set only ② Steel ③ Includes seals ④ Liner available in Kit Set only</p>	<p>① Kolben nur im Assembly erhältlich ② Stahl ③ Schließt Dichtungen ein ④ Zylinderlaufbuchse nur in Assemblies verfügbar</p>	<p>① Piston disponibile in kit seulement ② Acier ③ Inclut des joints ④ Chemise disponible en kit seulement</p>

- ① Piston available in Kit Set only
- ② Steel
- ③ Includes seals
- ④ Liner available in Kit Set only
- ① Kolben nur im Assembly erhältlich
- ② Stahl
- ③ Schließt Dichtungen ein
- ④ Zylinderlaufbuchse nur in Assemblies verfügbar
- ① Piston disponibile in kit seulement
- ② Acier
- ③ Inclut des joints
- ④ Chemise disponible en kit seulement
- ① Pistón disponible en conjuntos solamente.
- ② Acero
- ③ Incluye los sellos
- ④ Camisas disponible en conjuntos solamente.
- ① I pistonni sono disponibili solo in kit motore
- ② Acciaio
- ③ Comprende le guarnizioni
- ④ Cilindro disponibile solo in kit motore

92.00 **2**

DJ5T	4cyl.	2446cc	76-96kW (103-131PS)	Diesel	Turbo Intercooled	TD22210
-------------	-------	---------------	----------------------------	---------------	--------------------------	----------------

<p>87-326300-00 STD 87-326307-00 0.50mm ①</p> <p>A 49.84 B- 2.30 D 82.00 34x68</p> <p>AK HA KK RT TP</p>	<p>08-326300-00 STD 08-326307-00 0.50mm</p> <p>3.00 PS P 1.75 CR P 3.50 CR P</p>		
--	--	--	--

① A = 49.470, B = 81.600

94.00 **3**

EN 55	4cyl.	2498cc	53kW (72PS)	Diesel	TD763
XD 3P	4cyl.	2498cc	51-58kW (70-79PS)	Diesel	TD22215

400 2.5 D	04/89→12/94	400-Serie 428-435 2.5 D	04/89→08/93
400-Serie 2.5 D	04/89→12/94		

<p>87-318700-10 STD 87-318706-10 0.40mm →12/93</p> <p>A 54.00 B- 1.80 D 96.42 30x79</p>	<p>08-318700-10 STD 08-318706-10 0.40mm 08-318708-10 0.60mm 08-318711-10 1.00mm</p> <p>2.00 CR P 2.00 P 4.00 CR P</p>	<p>14-020660-00 D 14-021520-00 D</p>	<p>B 97.00 C 170.60 D 99.50 E 4.00 B 98.00 C 170.60 D 100.00 E 6.00</p>
--	---	--	---





87-318700-30 STD
87-318710-30 0.80mm
 01/94→

A 54.00
B- 1.75
D 91.42
 30x79



08-318700-10 STD
08-318706-10 0.40mm
08-318708-10 0.60mm
08-318711-10 1.00mm

2.00  CR P
 2.00  P
 4.00  CR P

94.00

4

ET 70	4cyl.	2498cc	71kW (96PS)	Diesel	Turbo Intercooled	TD764
XD 3T	4cyl.	2497cc	70kW (95PS)	Diesel	Turbo Intercooled	TD22216
400 2.5 TD			04/89→01/97	400-Serie 428-435 2.5 TD		04/89→08/93
400-Serie 2.5 TD			04/89→01/97			

14-020660-00 D **B 97.00 C 170.60 D 99.50 E 4.00**
14-021520-00 D **B 98.00 C 170.60 D 100.00 E 6.00**

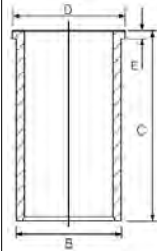

104.18

5

DF 615	6cyl.	6150cc	85kW (115PS)	Diesel		TD6601
DT 615	6cyl.	6150cc	111kW (151PS)	Diesel	Turbo	TD6602
DTD 615	6cyl.	6150cc	101-123kW (137-167PS)	Diesel	Turbo	TD6616
F 900			11/81→11/88	F 1600		01/70→08/91
F 1100			11/81→11/88	F 1800		01/70→08/91
F 1300			07/78→02/90	F 2100		07/78→09/86
F 1500			07/78→08/91			



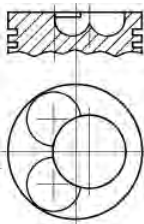

87-179000-10 STD

A 81.97
B- 23.15
C 2.20
C 2.20
D 132.72
 38x88

RT



08-179000-10 STD

2.50  CR P
 2.50  P
 2.50  P
 6.00  P
 6.00  P

14-025530-00 DH **B 109.00 C 239.00 D 117.06 E 8.09**

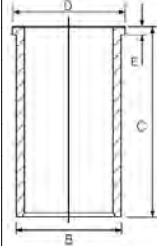

104.18

6

DNS 620	6cyl.	6240cc	156kW (212PS)	Diesel	Turbo Intercooled	TD6617
DNT 620	6cyl.	6240cc	132kW (180PS)	Diesel	Turbo	TD6615
DNTD 620	6cyl.	6240cc	116kW (158PS)	Diesel	Turbo	TD6614
F 1100			12/86→11/90	F 1700		12/86→02/95
F 1300			12/86→12/92	F 1900		12/86→09/93





87-741600-00 STD

A 80.00
B- 23.50
BØ 60.00
D 124.00
42x88



RT



08-741600-00 STD

3.00 CR P
2.50 CR P
4.00 CR P



14-025530-00 DH

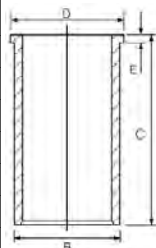

B 109.00 C 239.00 D 117.06 E 8.09

104.18

7

NS 156	6cyl.	6240cc	156kW (212PS)	Diesel	Turbo Intercooled	TD12928
NT 133	6cyl.	6240cc	133kW (181PS)	Diesel	Turbo	TD12909
F 1300		12/86→12/92		F 1900		12/86→09/93
F 1700		12/86→02/95				

14-025530-00 DH

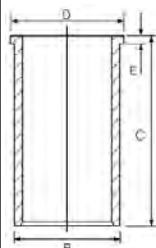

B 109.00 C 239.00 D 117.06 E 8.09

107.00

8

FR 103 S1 (Euro 4)	4cyl.	4460cc	103kW (140PS)	Diesel	Turbo Intercooled	TD18957
FR 118 S1 (Euro 4)	4cyl.	4460cc	118kW (160PS)	Diesel	Turbo Intercooled	TD18958
FR 136 S1 (Euro 4)	4cyl.	4460cc	136kW (185PS)	Diesel	Turbo Intercooled	TD18959
FR 152 (Euro 5)	4cyl.	4460cc	152kW (207PS)	Diesel	Turbo Intercooled	TD26696
GR 165 S1	6cyl.	6690cc	165kW (224PS)	Diesel	Turbo Intercooled	TD18960
GR 184 S1 (Euro 4)	6cyl.	6690cc	184kW (250PS)	Diesel	Turbo Intercooled	TD19699
GR 210 S1 (Euro 4)	6cyl.	6690cc	210kW (286PS)	Diesel	Turbo Intercooled	TD19700
GR 220 (Euro 4)	6cyl.	6690cc	220kW (300PS)	Diesel	Turbo Intercooled	TD26630
CF 65		05/06→05/13		LF 45		03/06→
KW-SERIES		01/06→		LF 55		05/06→

87-445400-00 STD

A 69.36
B- 19.53
BØ 58.93
D 103.12
40x90



AK KK RT TP



08-445400-00 STD

3.00 CK
2.50 P
3.50 CR P



14-011560-10 DH

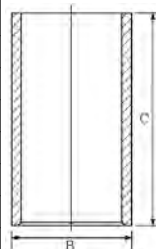

B 109.80 C 200.00

118.00

9

DH 825	6cyl.	8250cc	115-121kW (156-165PS)	Diesel		TD6603
DHB 825	6cyl.	8250cc	148kW (201PS)	Diesel	Turbo	TD13229
DHR 825	6cyl.	8250cc	150kW (204PS)	Diesel	Turbo	TD6619
DHS 825	6cyl.	8250cc	182-195kW (247-265PS)	Diesel	Turbo Intercooled	TD6625
DHS 825SM	6cyl.	8250cc	217kW (294PS)	Diesel	Turbo Intercooled	TD6626





DHT 825	6cyl.	8250cc	162-167kW (220-228PS)	Diesel	Turbo	TD6620
DHTD 825	6cyl.	8250cc	151kW (205PS)	Diesel	Turbo	TD6621
DHU 825	6cyl.	8250cc	169kW (230PS)	Diesel	Turbo	TD6623
DU 825	6cyl.	8250cc	159kW (216PS)	Diesel	Turbo	TD6618
HS 200	6cyl.	8250cc	200kW (272PS)	Diesel	Turbo Intercooled	TD6628
HS 825	6cyl.	8250cc	200kW (272PS)	Diesel	Turbo Intercooled	TD12890
HT 168	6cyl.	8250cc	168kW (228PS)	Diesel	Turbo	TD6624
HT 825	6cyl.	8250cc	168kW (228PS)	Diesel	Turbo	TD12891
PE 183 C (Euro 3)	6cyl.	9200cc	183kW (249PS)	Diesel	Turbo Intercooled	TD13328
PE 212 C (Euro 3)	6cyl.	9200cc	212kW (288PS)	Diesel	Turbo Intercooled	TD13329
PE 235 C (Euro 3)	6cyl.	9200cc	235kW (320PS)	Diesel	Turbo Intercooled	TD13330
PF 183 M (Euro 2)	6cyl.	9200cc	183kW (249PS)	Diesel	Turbo Intercooled	TD11909
PF 212 M (Euro 2)	6cyl.	9200cc	191-212kW (260-288PS)	Diesel	Turbo Intercooled	TD11910
PF 235 M (Euro 2)	6cyl.	9200cc	235kW (320PS)	Diesel	Turbo Intercooled	TD11911
RS 180	6cyl.	8650cc	180kW (245PS)	Diesel	Turbo Intercooled	TD12553
RS 180 L (Euro 1)	6cyl.	8650cc	180kW (245PS)	Diesel	Turbo Intercooled	TD6654
RS 180 M (Euro 2)	6cyl.	8650cc	180kW (245PS)	Diesel	Turbo Intercooled	TD6655
RS 200	6cyl.	8650cc	200kW (272PS)	Diesel	Turbo Intercooled	TD12554
RS 200 L (Euro 1)	6cyl.	8650cc	200kW (272PS)	Diesel	Turbo Intercooled	TD6656
RS 200 M (Euro 2)	6cyl.	8650cc	200kW (272PS)	Diesel	Turbo Intercooled	TD6657
RS 222	6cyl.	8650cc	222kW (302PS)	Diesel	Turbo Intercooled	TD12555
RS 222 L (Euro 1)	6cyl.	8650cc	222kW (302PS)	Diesel	Turbo Intercooled	TD6658
RS 222 M (Euro 2)	6cyl.	8650cc	222kW (302PS)	Diesel	Turbo Intercooled	TD6659
75			07/92→02/98	F 2300		07/78→10/93
75 CF			02/98→12/00	F 2500		02/82→08/91
CF 75			01/01→05/13	F 2700		01/90→10/93
DB			01/91→	SB		05/80→
F2000			01/70→12/79	URBINO		01/99→
F 2100			07/78→08/91	X-Series		10/99→
F 2200			01/71→11/80			

14-024070-00 DH

B 123.50 C 262.00 D 133.60 E 10.05

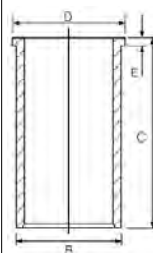

130.00						10
DK 1160	6cyl.	11630cc	156kW (212PS)	Diesel	Turbo Intercooled	TD6606
DKA 1160	6cyl.	11600cc	169kW (230PS)	Diesel		TD6608
DKB 1160	6cyl.	11600cc	226kW (308PS)	Diesel	Turbo	TD6627
DKD 1160	6cyl.	11630cc	121kW (165PS)	Diesel	Turbo	TD6605
DKDL 1160	6cyl.	11630cc	121kW (164PS)	Diesel	Turbo Intercooled	TD6640
DKL 1160	6cyl.	11630cc	148-151kW (201-205PS)	Diesel	Turbo Intercooled	TD6641
WS 222 L	6cyl.	11600cc	222kW (302PS)	Diesel	Turbo Intercooled	TD6660
WS 222 M	6cyl.	11630cc	222kW (302PS)	Diesel	Turbo Intercooled	TD6661
WS 225	6cyl.	11600cc	225kW (306PS)	Diesel	Turbo Intercooled	TD6668
WS 225 ATI	6cyl.	11630cc	225kW (306PS)	Diesel	Turbo Intercooled	TD7517
WS 242	6cyl.	11600cc	242kW (330PS)	Diesel	Turbo Intercooled	TD6669





WS 242 G	6cyl.	11600cc	242kW (330PS)	Diesel	Turbo Intercooled	TD22214
WS 259	6cyl.	11600cc	259kW (352PS)	Diesel	Turbo Intercooled	TD6670
WS 259 ATI	6cyl.	11630cc	259kW (352PS)	Diesel	Turbo Intercooled	TD7518
WS 268	6cyl.	11600cc	268kW (365PS)	Diesel	Turbo Intercooled	TD6671
WS 268 G	6cyl.	11600cc	268kW (364PS)	Diesel	Turbo Intercooled	TD6672
WS 282	6cyl.	11600cc	282kW (384PS)	Diesel	Turbo Intercooled	TD11907
WS 282 ATI	6cyl.	11630cc	282kW (383PS)	Diesel	Turbo Intercooled	TD7519
WS 282 L	6cyl.	11630cc	282kW (383PS)	Diesel	Turbo Intercooled	TD6674
WS 295	6cyl.	11600cc	295kW (401PS)	Diesel	Turbo Intercooled	TD6675
WS 295 G	6cyl.	11600cc	295kW (401PS)	Diesel	Turbo Intercooled	TD6676
WS 295 M ATI	6cyl.	11627cc	295kW (401PS)	Diesel	Turbo Intercooled	TD6666
WS 315	6cyl.	11600cc	315kW (428PS)	Diesel	Turbo Intercooled	TD11908
WS 315 G	6cyl.	11600cc	315kW (428PS)	Diesel	Turbo	TD6679
XE 250 C (Euro 3)	6cyl.	12580cc	250kW (340PS)	Diesel	Turbo Intercooled	TD13331
XE 280 C (Euro 3)	6cyl.	12580cc	280kW (381PS)	Diesel	Turbo Intercooled	TD13332
XE 315 C (Euro 3)	6cyl.	12580cc	315kW (428PS)	Diesel	Turbo Intercooled	TD13333
XE 355 C (Euro 3)	6cyl.	12580cc	355kW (483PS)	Diesel	Turbo Intercooled	TD13334
XE 355 C1 (Euro 3)	6cyl.	12580cc	355kW (483PS)	Diesel	Turbo Intercooled	TD22219
XE 390 C (Euro 3)	6cyl.	12580cc	390kW (530PS)	Diesel	Turbo Intercooled	TD13335
XE 390 C1 (Euro 3)	6cyl.	12580cc	390kW (530PS)	Diesel	Turbo Intercooled	TD22220

85	07/92→02/98	Magiq	10/99→
85 CF	02/98→12/00	SB	01/74→
95	09/87→01/98	Skyliner	09/92→
95 XF	01/97→09/02	Spaceliner	09/92→
CF 85	01/01→05/13	Synergy	09/04→
Cityliner	09/92→	Transliner	09/92→
F 2600	02/72→12/73	VACANZA	06/02→12/06
F 2800	01/74→11/80	XF 95	01/02→12/06
Futura	07/94→09/06	X-Series	10/99→
Jetliner	09/92→09/93		

14-021410-00 DH B 136.02 C 288.30 D 143.60 E 10.05

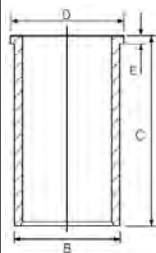

130.00 **11**

DKCL 1160	6cyl.	11630cc	156kW (212PS)	Diesel	Turbo Intercooled	TD20105
DKFL 1160	6cyl.	11630cc	191kW (260PS)	Diesel	Turbo Intercooled	TD20107
DKS 1160	6cyl.	11600cc	228kW (310PS)	Diesel	Turbo	TD6629
DKS 1160 E	6cyl.	11600cc	206kW (280PS)	Diesel	Turbo Intercooled	TD6630
DKSB 1160	6cyl.	11630cc	228kW (310PS)	Diesel	Turbo Intercooled	TD20106
DKT 1160	6cyl.	11600cc	213kW (290PS)	Diesel	Turbo	TD6631
DKTD 1160	6cyl.	11600cc	188-191kW (256-260PS)	Diesel	Turbo	TD6632
DKTL 1160	6cyl.	11600cc	185kW (252PS)	Diesel	Turbo	TD6642
DKVL 1160	6cyl.	11600cc	206kW (280PS)	Diesel	Turbo	TD13288
DKX 1160	6cyl.	11600cc	243kW (330PS)	Diesel	Turbo Intercooled	TD6637
KT 191	6cyl.	11600cc	256kW (348PS)	Diesel	Turbo Intercooled	MP5278





LT 160	6cyl.	11630cc	160-170kW (218-231PS)	Diesel	Turbo Intercooled	TD24104
LT 195 1160	6cyl.	11600cc	195kW (265PS)	Diesel		MP5310
LT 210	6cyl.	11630cc	206-210kW (280-286PS)	Diesel	Turbo Intercooled	TD7173
F 2800			01/74→09/91	N 3300		01/81→09/91
F 3300			06/81→09/86	N-Serie		01/83→
INDUSTRIAL				SB		01/84→
N 2800			01/81→09/91			

87-174100-00 STD

- A 101.00
- B- 29.30
- BØ 74.50
- C 3.00
- D 169.50
- E 48x111

AK HA RT



08-174100-10 STD

- 3.16 CR P
- 3.16 CR P
- 6.33 CR P

14-021410-00 DH

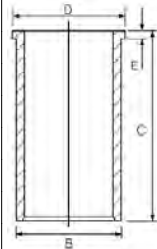

B 136.02 C 288.30 D 143.60 E 10.05

130.00

12

DKSE 1160	6cyl.	11630cc	206kW (280PS)	Diesel	Turbo Intercooled	TD22211
DKV 1160	6cyl.	11600cc	212kW (280PS)	Diesel	Turbo	TD6633
DKX 1160 ATI	6cyl.	11600cc	260kW (354PS)	Diesel	Turbo Intercooled	TD6638
DKXE 1160	6cyl.	11600cc	212kW (280PS)	Diesel	Turbo Intercooled	TD6634
DKXE 1160 ATI	6cyl.	11630cc	139-274kW (189-373PS)	Diesel	Turbo Intercooled	TD22212
DKZ 1160	6cyl.	11630cc	139-274kW (189-373PS)	Diesel	Turbo Intercooled	TD22213
DKZ 1160 ATI	6cyl.	11600cc	274kW (373PS)	Diesel	Turbo Intercooled	TD6639
F 2800			01/80→09/91	F 3600		06/85→09/91
F 3300			06/85→09/91	SB		01/84→12/03

87-174100-30 STD

- A 101.00
- B- 29.10
- BØ 74.50
- C 4.00
- D 169.50
- E 52x106

AK HA RT



08-174100-10 STD

- 3.16 CR P
- 3.16 CR P
- 6.33 CR P

14-021410-00 DH

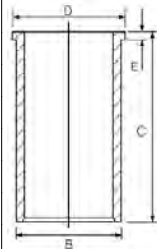

B 136.02 C 288.30 D 143.60 E 10.05

88-174100-30
87-174100-30 +
14-021410-00

130.00

13

MX 265 (Euro 4/5)	6cyl.	12902cc	265kW (360PS)	Diesel	Turbo Intercooled	TD20056
CF 85			10/06→05/13			

87-437500-00 STD

- A 82.00
- B- 17.49
- BØ 90.82
- C 0.90
- C 2.00
- D 126.00
- E 55x106

AK HA KK NB RT
TP



08-437500-00 STD ①

- 3.00 GDC ②
- 2.50 P
- 3.00 GDC P



15-451230-00 WH ③ ④

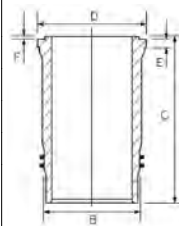

B 146.00 C 268.00 D 157.60 E 12.00 F 0.95

① For Aluminium piston
② Steel
③ Includes Anti-Polish Ring (Fire Ring)
④ Includes seals

① Für Aluminiumkolben
② Stahl
③ Enthält Ölschlitzring
④ Schließt Dichtungen ein

① Pour piston en aluminium
② Acier
③ Contient le segment racleur
④ Inclut des joints

① Para pistón de aluminio
② Acero
③ Incluye el segmento rascador
④ Incluye los sellos

① Per pistone in alluminio
② Acciaio
③ Include anello raschiaolio
④ Comprende le guarnizioni



130.00 **14**

MX 300 (Euro 4/5)	6cyl.	12902cc	300kW (408PS)	Diesel	Turbo Intercooled	TD18902
MX 340 (Euro 4/5)	6cyl.	12902cc	340kW (462PS)	Diesel	Turbo Intercooled	TD18903
MX 375 (Euro 4/5)	6cyl.	12902cc	375kW (510PS)	Diesel	Turbo Intercooled	TD18904

CF 85	10/05→05/13	SAFIR	10/09→
Futura	09/10→	SAFIR PLUS	10/09→
i6	09/14→	Synergy	07/07→
Jonkheere	08/07→	T-Serie	10/05→
Magiq	10/06→	VACANZA	10/05→
PB	10/09→	XF 105	10/05→
SAFARI	10/10→	X-Series	07/08→



87-432500-00 STD ①

A 81.90
B- 17.50
BØ 91.00
C 0.80
C 2.00
D 120.40
 55x82

KK TP



08-432500-00 STD ②

4.00  GDC P
 3.16  NT
 4.00  CR P

GDC 

15-451230-00 WH ③ ④ **B** 146.00 **C** 268.00 **D** 157.60 **E** 12.00 **F** 0.95

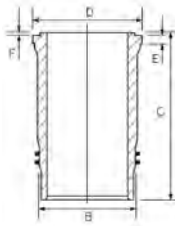



87-432500-10 STD ①

A 81.90
B- 17.50
C 0.80
C 2.00
 55x82

KK TP



08-432500-00 STD ②

4.00  GDC P
 3.16  NT
 4.00  CR P

GDC 

- ① MonoSteel ®
- ② For Steel piston
- ③ Includes Anti-Polish Ring (Fire Ring)
- ④ Includes seals
- ② Für Stahlkolben
- ③ Enthält Ölschlitzring
- ④ Schließt Dichtungen ein
- ② Pour piston en acier
- ③ Contient le segment racleur
- ④ Inclut des joints
- ② Para pistón de acero
- ③ Incluye el segmento rascador
- ④ Incluye los sellos
- ② Per pistone in acciaio
- ③ Include anello raschiaolio
- ④ Comprende le guarnizioni

130.00 **15**

MX-13 303 (Euro 6)	6cyl.	12903cc	300-303kW (408-412PS)	Diesel	Turbo Intercooled	TD28147
MX-13 340 (Euro 6)	6cyl.	12902cc	340kW (462PS)	Diesel	Turbo Intercooled	TD28148
MX-13 375 (Euro 6)	6cyl.	12902cc	375kW (510PS)	Diesel	Turbo Intercooled	TD28149

ACRON	10/15→	Futura	09/10→
ALTANO	10/15→	i3	03/17→
ASTROMEGA	01/15→	i4	03/17→
ASTRON	10/15→	i6	09/14→
ASTRONEF	01/15→	i8	01/16→
CF	05/13→	T-Series	01/11→
EX-Series	09/14→	XF	10/12→

15-451230-00 WH ① ② **B** 146.00 **C** 268.00 **D** 157.60 **E** 12.00 **F** 0.95



① Enthält Ölschlitzring
 ② Schließt Dichtungen ein

① Contient le segment racleur
 ② Inclut des joints

① Incluye el segmento rascador
 ② Incluye los sellos

① Include anello raschiaolio
 ② Comprende le guarnizioni

- ① Includes Anti-Polish Ring (Fire Ring)
- ② Includes seals
- ① Enthält Ölschlitzring
- ② Schließt Dichtungen ein
- ① Contient le segment racleur
- ② Inclut des joints
- ① Incluye el segmento rascador
- ② Incluye los sellos
- ① Include anello raschiaolio
- ② Comprende le guarnizioni



130.00 **16**

WS 222 G	6cyl.	11600cc	222kW (302PS)	Diesel	Turbo Intercooled	TD6667
WS 242 L (Euro 1)	6cyl.	11600cc	242kW (330PS)	Diesel	Turbo Intercooled	TD6662
WS 268 L (Euro 1)	6cyl.	11600cc	268kW (365PS)	Diesel	Turbo Intercooled	TD6664
WS 295 L (Euro 1)	6cyl.	11600cc	295kW (401PS)	Diesel	Turbo Intercooled	TD6677
WS 315 L (Euro 1)	6cyl.	11600cc	315kW (428PS)	Diesel	Turbo Intercooled	TD6680

85 07/92→02/98 F-Series 01/92→12/98
 95 08/90→01/98

87-743400-40 STD

- A 101.00
- B- 24.75
- BØ 75.00
- C 0.80
- D 155.00
- 52x106



RT

08-743400-00 STD

- 4.00 PS P
- 3.16 CR P
- 4.00 CR P

14-021410-00 DH

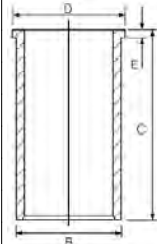

B 136.02 C 288.30 D 143.60 E 10.05

88-743400-40

87-743400-40 +
14-021410-00

130.00 **17**

WS 242 M (Euro 2)	6cyl.	11600cc	242kW (330PS)	Diesel	Turbo Intercooled	TD6663
WS 268 M (Euro 2)	6cyl.	11600cc	268kW (365PS)	Diesel	Turbo Intercooled	TD6665
WS 295 M (Euro 2)	6cyl.	11600cc	295kW (401PS)	Diesel	Turbo Intercooled	TD6678
WS 315 M (Euro 2)	6cyl.	11600cc	315kW (428PS)	Diesel	Turbo Intercooled	TD6681

85 07/92→02/98 95 08/90→01/98

87-743400-50 STD

- A 101.00
- B- 21.15
- BØ 82.00
- D 155.00
- 52x106



RT

08-743400-00 STD

- 4.00 PS P
- 3.16 CR P
- 4.00 CR P

14-021410-00 DH

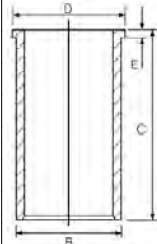

B 136.02 C 288.30 D 143.60 E 10.05

88-743400-50

87-743400-50 +
14-021410-00

130.00 **18**

XE 280 C1 (Euro 3)	6cyl.	12580cc	280kW (381PS)	Diesel	Turbo Intercooled	TD22217
XE 315 C1 (Euro 3)	6cyl.	12580cc	315kW (428PS)	Diesel	Turbo Intercooled	TD22218

85 CF 02/98→12/00

87-433300-00 STD

- A 95.00
- B- 15.44
- BØ 99.60
- C 1.00
- D 143.00
- 52x106



AK RT TP

08-433300-00 STD

- 4.00 CK
- 3.16
- 4.00 CR P

14-021410-00 DH

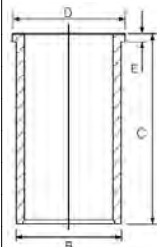

B 136.02 C 288.30 D 143.60 E 10.05

88-433300-00

87-433300-00 +
14-021410-00

130.00 **19**

XF 250 M (Euro 2)	6cyl.	12580cc	250kW (340PS)	Diesel	Turbo Intercooled	TD11912
XF 280 M (Euro 2)	6cyl.	12580cc	280kW (381PS)	Diesel	Turbo Intercooled	TD11913
XF 315 M (Euro 2)	6cyl.	12580cc	315kW (428PS)	Diesel	Turbo Intercooled	TD11914
XF 355 M (Euro 2)	6cyl.	12580cc	355kW (483PS)	Diesel	Turbo Intercooled	TD11915





85 CF	02/98→12/00	CF 85	01/01→05/13
95 XF	01/97→09/02	XF 95	01/02→12/06

87-743400-30 STD

- A** 95.00
- B-** 21.75
- BØ** 82.00
- C** 1.00
- D** 143.00
-  52x106



RT TP

08-743400-00 STD

- 4.00  PSP
- 3.16  CR P
- 4.00  CR P

14-021410-00 DH

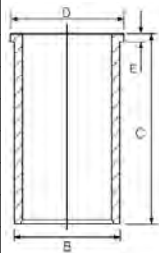

B 136.02 **C** 288.30 **D** 143.60 **E** 10.05

88-743400-30
87-743400-30 +
14-021410-00



CCM

x



9

8360.05.670 (Magirus-Deutz)	Diesel	8100	6	115.00	26
BF 2L 912	Diesel	1884	2	100.00	9
BF 3L 912	Diesel	2826	3	100.00	9
BF 3L 914	Diesel	3236	3	102.00	12
BF 3L 2011	Diesel	2332	3	94.00	5
BF 3M 2011	Diesel	2332	3	94.00	5
BF 4L 912	Diesel	3768	4	100.00	9
BF 4L 913	Diesel	4086	4	102.00	15
BF 4L 913 C	Diesel	4086	4	102.00	15
BF 4L 913 T	Diesel	4086	4	102.00	16
BF 4L 914	Diesel	4314	4	102.00	12
BF 4L 1011 F	Diesel	2731	4	91.00	3
BF 4L 1011 FT	Diesel	2732	4	91.00	3
BF 4L 2011	Diesel	3110	4	94.00	5
BF 4M 1012 (Euro 1)	Diesel	3192	4	94.00	6
BF 4M 1012 C (Euro 1)	Diesel	3192	4	94.00	6
BF 4M 1012 E (Euro 2)	Diesel	3192	4	94.00	6
BF 4M 1012 EC	Diesel	3192	4	94.00	6
BF 4M 1013 (Euro 1)	Diesel	4764	4	108.00	19
BF 4M 1013 C (Euro 1)	Diesel	4764	4	108.00	19
BF 4M 1013 E (Euro 2)	Diesel	4764	4	108.00	20
BF 4M 1013 EC (Euro 2)	Diesel	4764	4	108.00	21
BF 4M 1013 FC (Euro 2/3)	Diesel	4764	4	108.00	21
BF 4M 2011	Diesel	3110	4	94.00	5
BF 4M 2012 (Euro 2)	Diesel	4038	4	101.00	11
BF 4M 2012 C (Euro 2)	Diesel	4038	4	101.00	11
BF 4M 2013 C	Diesel	3802	4	98.00	7
BF 5L 912	Diesel	4710	5	100.00	9
BF 6L 413 FR	Diesel	9572	V6	125.00	30
BF 6L 513	Diesel	9572	V6	125.00	30
BF 6L 513 C	Diesel	9572	V6	125.00	30
BF 6L 912	Diesel	5655	6	100.00	9
BF 6L 913	Diesel	6128	6	102.00	15
BF 6L 913 C	Diesel	6128	6	102.00	15
BF 6L 913 T	Diesel	6128	6	102.00	16
BF 6L 914	Diesel	6472	6	102.00	12
BF 6L 914 C	Diesel	6472	6	102.00	18
BF 6M 1012 (Euro 1)	Diesel	4788	6	94.00	6
BF 6M 1012 C (Euro 1)	Diesel	4788	6	94.00	6
BF 6M 1012 E	Diesel	4788	6	94.00	6
BF 6M 1012 EC	Diesel	4788	6	94.00	6
BF 6M 1013 (Euro 1)	Diesel	7146	6	108.00	19
BF 6M 1013 C (Euro 1)	Diesel	7146	6	108.00	19
BF 6M 1013 CP (Euro 1)	Diesel	7146	6	108.00	23
BF 6M 1013 E (Euro 2)	Diesel	7146	6	108.00	24
BF 6M 1013 EC (Euro 2)	Diesel	7146	6	108.00	21
BF 6M 1013 ECP (Euro 3)	Diesel	7146	6	108.00	21
BF 6M 1013 FC (Euro 2/3)	Diesel	7146	6	108.00	25
BF 6M 1015	Diesel	11905	V6	132.00	31
BF 6M 1015 C (Euro 2)	Diesel	11905	V6	132.00	32
BF 6M 1015 CP	Diesel	11905	V6	132.00	31
BF 6M 2012 C (Euro 2)	Diesel	6057	6	101.00	11
BF 6M 2013	Diesel	5702	6	98.00	7
BF 6M 2013 C	Diesel	5702	6	98.00	7
BF 8L 413 F	Diesel	12763	V8	125.00	30
BF 8L 513	Diesel	12763	V8	125.00	30
BF 8L 513 C	Diesel	13738	8	125.00	30
BF 8M 1015 (1015)	Diesel	15874	V8	132.00	31
BF 8M 1015 C (Euro 2)	Diesel	15874	V8	132.00	32
BF 8M 1015 CP	Diesel	15874	V8	132.00	31

ENGINE INDEX

Motorverzeichnis • Index de moteur • Índice de Motor
 Indeks silnika • Модель Двигателя • دليل المحرك

CCM
x

9

BF 10L 413 F	Diesel	15953	V10	125.00	30
BF 10L 513	Diesel	15954	V10	125.00	30
BF 10L 513 C	Diesel	15954	V10	125.00	30
BF 10L 513 F	Diesel	15945	V10	125.00	30
BF 12L 413 F	Diesel	19144	V12	125.00	30
BF 12L 513	Diesel	19144	V12	125.00	30
BF 12L 513 C	Diesel	19144	V12	125.00	30
BF 12L 513 F	Diesel	19144	V12	125.00	30
F 1L 511 D	Diesel	825	1	100.00	8
F 2L 511 D	Diesel	1650	2	100.00	8
F 2L 912 (FL912)	Diesel	1885	2	100.00	10
F 2L 912 D	Diesel	1885	2	100.00	10
F 2L 912 W	Diesel	1884	2	100.00	9
F 2L 1011 F	Diesel	1366	2	91.00	1
F 2L 2011	Diesel	1554	2	94.00	4
F 2M 1011	Diesel	1366	2	91.00	2
F 2M 2011	Diesel	1555	2	94.00	4
F 3L 912 D	Diesel	2826	3	100.00	10
F 3L 912 W	Diesel	2826	3	100.00	9
F 3L 913	Diesel	3064	3	102.00	13
F 3L 913 G	Diesel	3064	3	102.00	14
F 3L 1011 F	Diesel	2049	3	91.00	1
F 3L 2011	Diesel	2332	3	94.00	4
F 3M 1011 F	Diesel	2185	3	91.00	2
F 3M 2011	Diesel	2332	3	94.00	4
F 4L 413 FR	Diesel	6381	4	125.00	29
F 4L 912 D	Diesel	3770	4	100.00	10
F 4L 912 F	Diesel	4086	4	102.00	17
F 4L 912 W	Diesel	3770	4	100.00	9
F 4L 913	Diesel	4086	4	102.00	13
F 4L 913 D	Diesel	4086	4	102.00	17
F 4L 1011 F	Diesel	2732	4	91.00	1
F 4L 2011	Diesel	3110	4	94.00	4
F 4M 1011 F	Diesel	2732	4	91.00	2
F 4M 2011	Diesel	3110	4	94.00	4
F 5L 413	Diesel	7070	5	120.00	27
F 5L 413 FR	Diesel	7976	5	125.00	29
F 5L 912 D	Diesel	4712	5	100.00	10
F 5L 912 F	Diesel	5107	5	102.00	17
F 5L 912 W	Diesel	4710	5	100.00	9
F 6L 413	Diesel	8478	V6	120.00	28
F 6L 413 F	Diesel	9572	V6	125.00	29
F 6L 413 FR	Diesel	9572	V6	125.00	29
F 6L 413 FW	Diesel	9572	V6	125.00	30
F 6L 413 L	Diesel	8482	V6	120.00	27
F 6L 912 D	Diesel	5655	6	100.00	10
F 6L 912 F	Diesel	6128	6	102.00	17
F 6L 912 W	Diesel	5655	6	100.00	9
F 6L 913	Diesel	6128	6	102.00	13
F 6L 913 D	Diesel	6128	6	102.00	17
F 8L 413	Diesel	11310	V8	120.00	28
F 8L 413 F	Diesel	12763	V8	125.00	29
F 8L 413 FW	Diesel	12763	V8	125.00	30
F 8L 413 L	Diesel	11310	V8	120.00	27
F 10L 413	Diesel	14140	V10	120.00	28
F 10L 413 F	Diesel	15953	V10	125.00	29
F 10L 413 FW	Diesel	15953	V10	125.00	30
F 10L 413 L	Diesel	14137	V10	120.00	27
F 12L 413	Diesel	16960	V12	120.00	28
F 12L 413 F	Diesel	19144	V12	125.00	29



CCM

x



9

F 12L 413 FW	Diesel	19144	V12	125.00	30
TCD 2013 L4 2V (Euro 2)	Diesel	4764	4	108.00	20
TCD 2013 L4 4V (Euro 4)	Diesel	4764	4	108.00	22
TCD 2013 L6 2V (Euro 2)	Diesel	7146	6	108.00	20
TCD 2013 L06 4V (Euro 4)	Diesel	7146	6	108.00	22
TCD 2013 L6 4V (Euro 4)	Diesel	7146	6	108.00	22



91.00 1



F 2L 1011 F	2cyl.	1366cc	20-22kW (27-30PS)	Diesel	TD17224
F 3L 1011 F	3cyl.	2049cc	16-33kW (22-45PS)	Diesel	TD17225
F 4L 1011 F	4cyl.	2732cc	24-47kW (33-64PS)	Diesel	TD17227

87-252500-10 STD
87-252507-10 0.50mm

A 55.37
 B- 19.80
 BØ 40.00
 D 86.37
 26x65



08-252500-00 STD
08-252507-00 0.50mm

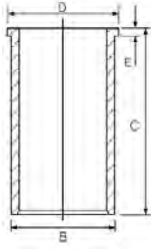

2.00  CR P
 2.00  P
 3.00  P

14-029750-00 DH **B 94.01 C 175.50 D 98.90 E 4.55**



91.00 2



F 2M 1011	2cyl.	1366cc	21-23kW (29-31PS)	Diesel	TD17231
F 3M 1011 F	3cyl.	2185cc	17-36kW (23-49PS)	Diesel	TD17232
F 4M 1011 F	4cyl.	2732cc	24-48kW (33-65PS)	Diesel	TD18488

87-252500-30 STD 
87-252507-30 0.50mm 

A 51.70
 B- 10.00
 B- 19.20
 BØ 42.00
 D 80.30
 26x65



08-252500-10 STD
08-252507-10 0.50mm

2.00  CR P
 2.00  P
 3.00  P

14-029750-00 DH **B 94.01 C 175.50 D 98.90 E 4.55**

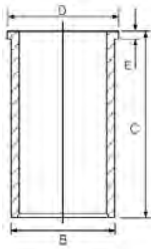

 Bowl capacity 29.10cm³  Volumen der Kolbenmulde 29.10cm³  Volume de la cavité du piston 29.10cm³  Vol. cavidad pistón 29.10cm³  Volume camera pistone 29.10cm³

91.00 3

BF 4L 1011 F	4cyl.	2731cc	28-55kW (38-75PS)	Diesel Turbo	TD17230
BF 4L 1011 FT	4cyl.	2732cc	46kW (63PS)	Diesel Turbo	TD17228



87-103200-00 STD
87-103207-00 0.50mm

A 55.20
 B- 18.00
 BØ 45.00
 D 86.15
 30x68

RT



08-103200-00 STD
08-103207-00 0.50mm

3.00  MO P
 2.00  P
 3.00  P

14-029750-00 DH **B 94.01 C 175.50 D 98.90 E 4.55**

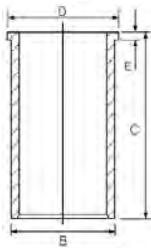

88-103200-00
 87-103200-00 +
 14-029750-00

94.00 4

F 2L 2011	2cyl.	1554cc	21-23kW (29-31PS)	Diesel	TD17387
F 2M 2011	2cyl.	1555cc	23-24kW (31-33PS)	Diesel	TD17382
F 3L 2011	3cyl.	2332cc	34-36kW (46-49PS)	Diesel	TD17388
F 3M 2011	3cyl.	2332cc	34-37kW (46-50PS)	Diesel	TD17383
F 4L 2011	4cyl.	3110cc	45-48kW (61-65PS)	Diesel	TD17390
F 4M 2011	4cyl.	3110cc	46-49kW (63-67PS)	Diesel	TD17385





87-146500-00 STD
87-146507-00 0.50mm

A 51.70
B- 19.00
BØ 46.00
D 81.65
 26x65



08-146500-00 STD
08-146507-00 0.50mm

2.00  CR
 2.00  P
 3.00  P

94.00

5

BF 3L 2011	3cyl.	2332cc	42-45kW (57-61PS)	Diesel	Turbo	TD17389
BF 3M 2011	3cyl.	2332cc	46-49kW (63-67PS)	Diesel	Turbo	TD17384
BF 4L 2011	4cyl.	3110cc	55-58kW (75-79PS)	Diesel	Turbo	TD17391
BF 4M 2011	4cyl.	3110cc	62-65kW (84-88PS)	Diesel	Turbo	TD17386

87-142100-00 STD
87-142107-00 0.50mm

A 51.70
B- 17.60
BØ 52.00
D 81.65
 30x68



KK RT

08-142100-00 STD
08-142107-00 0.50mm

3.00  CK P
 2.00  P
 3.00  CR P

94.00

6

BF 4M 1012 (Euro 1)	4cyl.	3192cc	58-65kW (79-88PS)	Diesel	Turbo Intercooled	TD17235
BF 4M 1012 C (Euro 1)	4cyl.	3192cc	74-82kW (101-112PS)	Diesel	Turbo Intercooled	TD17236
BF 4M 1012 E (Euro 2)	4cyl.	3192cc	50-68kW (68-92PS)	Diesel	Turbo	TD17239
BF 4M 1012 EC	4cyl.	3192cc	60-84kW (81-114PS)	Diesel	Turbo Intercooled	TD17233
BF 6M 1012 (Euro 1)	6cyl.	4788cc	73-98kW (99-133PS)	Diesel	Turbo Intercooled	TD17237
BF 6M 1012 C (Euro 1)	6cyl.	4788cc	111-123kW (151-167PS)	Diesel	Turbo Intercooled	TD17238
BF 6M 1012 E	6cyl.	4788cc	70-100kW (95-136PS)	Diesel	Turbo	TD17240
BF 6M 1012 EC	6cyl.	4788cc	113-125kW (154-170PS)	Diesel	Turbo Intercooled	TD17234

AGROPLUS	01/98→12/04	Farmer	01/97→
AGROTRON	01/95→12/04		

87-252800-00 STD 

A 61.20
B- 18.36
BØ 49.65
D 98.00
 34x78



RT TP

08-252800-00 STD

3.00  CR P
 2.00  P
 3.00  CR P

14-020490-00 DH

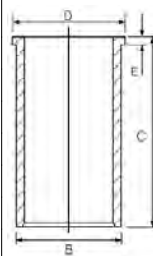

B 98.50 C 196.00 D 102.60 E 5.00

88-252800-00
 87-252800-00 +
 14-020490-00

 Bowl capacity 37.00cm³

 Volumen der Kolbenmulde 37.00cm³

 Volume de la cavité du piston 37.00cm³

 Vol. cavidad pistón 37.00cm³

 Volume camera pistone 37.00cm³

98.00

7

BF 4M 2013 C	4cyl.	3802cc	125kW (170PS)	Diesel	Turbo Intercooled	TD17316
BF 6M 2013	6cyl.	5702cc	92kW (125PS)	Diesel	Turbo	TD17318
BF 6M 2013 C	6cyl.	5702cc	118-190kW (160-258PS)	Diesel	Turbo Intercooled	TD17317





Favorit 01/06 →

87-127800-00 STD

- A 50.65
- B- 17.50
- BØ 61.06
- D 86.15
- 38x76

(09837-)
AK RT TP



08-127800-00 STD

- 3.00 CK P
- 2.00 P
- 3.00 NT

100.00

8

F 1L 511 D	1cyl.	825cc	11-13kW (15-18PS)	Diesel	TD17869
F 2L 511 D	2cyl.	1650cc	22-26kW (30-35PS)	Diesel	TD17872

87-741807-20 0.50mm

- A 56.75
- B- 21.44
- BØ 50.00
- B+ 5.70
- D 95.95
- 35x75

(10005)



08-741800-00 STD

08-741807-00 0.50mm

- 2.94 CR P
- 2.55 P
- 5.00 CR P

100.00

9

BF 2L 912	2cyl.	1884cc		Diesel Turbo	MP6110
BF 3L 912	3cyl.	2826cc		Diesel Turbo	MP6111
BF 4L 912	4cyl.	3768cc		Diesel Turbo	MP6112
BF 5L 912	5cyl.	4710cc		Diesel Turbo	MP6113
BF 6L 912	6cyl.	5655cc	88-100kW (120-136PS)	Diesel Turbo	TD18348
F 2L 912 W	2cyl.	1884cc	22kW (30PS)	Diesel	MP6565
F 3L 912 W	3cyl.	2826cc	25-43kW (34-58PS)	Diesel	TD19019
F 4L 912 W	4cyl.	3770cc	38-49kW (52-67PS)	Diesel	TD19022
F 5L 912 W	5cyl.	4710cc	61kW (82PS)	Diesel	MP6566
F 6L 912 W	6cyl.	5655cc	57-74kW (78-101PS)	Diesel	TD19024

14-Serie 01/70 → 12/70 INDUSTRIAL
D06 01/72 →

14-900080-00 DH

B 110.00 C 222.30 D 120.00 E 137.30

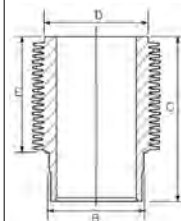

100.00

10

F 2L 912 (FL912)	2cyl.	1885cc	16-28kW (22-38PS)	Diesel	TD18128
F 2L 912 D	2cyl.	1885cc	21-28kW (29-38PS)	Diesel	MP7020
F 3L 912 D	3cyl.	2826cc	24-44kW (33-60PS)	Diesel	TD19020
F 4L 912 D	4cyl.	3770cc	38-62kW (52-84PS)	Diesel	TD19021





F 5L 912 D	5cyl.	4712cc	58-78kW (79-106PS)	Diesel	TD19023
F 6L 912 D	6cyl.	5655cc	42-92kW (57-125PS)	Diesel	TD19030
14-Serie			01/70→12/70	D07	01/82→
AGRICULTURAL				KL-Serie	01/66→12/70
D06			01/68→		

87-172500-00 STD 87-172511-00 1.00mm A 71.90 B- 21.40 BØ 55.00 B+ 5.70 D 123.60 35x80 AK	08-172500-00 STD 08-172507-00 0.50mm 08-172511-00 1.00mm 3.00 CR P 2.50 P 2.50 P 5.00 CR P	14-900080-00 DH 	B 110.00 C 222.30 D 120.00 E 137.30 88-172500-00 87-172500-00 + 14-900080-00
--	---	--------------------------------	--

87-741800-00 STD 87-741807-00 0.50mm A 71.90 B- 21.40 BØ 55.00 B+ 5.70 C 1.10 D 123.60 35x80 AK RT	08-741800-00 STD 08-741807-00 0.50mm 2.94 CR P 2.55 P 5.00 CR P		
--	--	--	--



87-744600-00 STD 87-744611-00 1.00mm A 71.90 B- 21.40 BØ 55.00 B+ 5.70 C 1.10 D 123.60 35x80 (10091D) AK	08-744600-00 STD 08-744607-00 0.50mm 08-744611-00 1.00mm 2.94 CR P 2.00 P 3.50 CR P	14-900080-00 DH 	B 110.00 C 222.30 D 120.00 E 137.30 88-744600-00 87-744600-00 + 14-900080-00
---	--	--------------------------------	--

Bowl capacity 45.40cm³ Volumen der Kolbenmulde 45.40cm³ Volume de la cavité du piston 45.40cm³ Vol. cavidad pistón 45.40cm³ Volume camera pistone 45.40cm³

101.00						11
BF 4M 2012 (Euro 2)	4cyl.	4038cc	74-75kW (101-102PS)	Diesel	Turbo Intercooled	TD17258
BF 4M 2012 C (Euro 2)	4cyl.	4038cc	68-103kW (92-140PS)	Diesel	Turbo Intercooled	TD17259
BF 6M 2012 C (Euro 2)	6cyl.	6057cc	140-155kW (190-211PS)	Diesel	Turbo Intercooled	TD17261
AGROTRON K			09/05→12/07	Farmer		01/03→12/08





87-127900-00 STD 
87-127907-00 0.50mm 

08-127900-00 STD
08-127907-00 0.50mm

A 50.65
B- 18.00
BØ 61.03
D 86.15
 38x76
 (10102C)
AK RT TP





2.50  CK P
 2.00  P
 3.00  CR P

 Bowl capacity 43.70cm³

 Volumen der Kolbenmulde 43.70cm³

 Volume de la cavité du piston 43.70cm³

 Vol. cavidad pistón 43.70cm³

 Volume camera pistone 43.70cm³

102.00

12

BF 3L 914	3cyl.	3236cc	44-56kW (60-76PS)	Diesel	Turbo	TD17215
BF 4L 914	4cyl.	4314cc	63-75kW (86-102PS)	Diesel	Turbo	TD17216
BF 6L 914	6cyl.	6472cc	80-116kW (109-158PS)	Diesel	Turbo	TD17217

Farmer 01/03→

87-442400-10 STD
87-442407-10 0.50mm

08-442400-00 STD
08-442407-00 0.50mm

A 65.60
B- 16.90
B- 5.20
BØ 70.10
B+ 6.00
D 117.10
 35x80
AK KK RT



2.94  CR
 3.00  CR
 3.00  CR

102.00

13

F 3L 913	3cyl.	3064cc	25-44kW (34-60PS)	Diesel	TD17201
F 4L 913	4cyl.	4086cc	50-78kW (68-106PS)	Diesel	TD7277
F 6L 913	6cyl.	6128cc	96kW (130PS)	Diesel	TD7451

AGROLUX	01/01→12/06	DX	01/84→
AGROPLUS	01/96→12/04	Farmer	01/74→12/96
AGROXTRA	01/91→12/95	GT	01/84→12/96
D07	01/80→		

87-740900-00 STD 

08-740900-10 STD

A 69.10
B- 16.60
BØ 56.10
B+ 5.00
D 123.60
 35x80
 (10234)
AK



2.94mm  CK
 2.55  P
 5.00  CR P

14-900100-00 DH **B** 109.90 **C** 222.30 **D** 120.00 **E** 137.30
14-900060-00 DH  **B** 109.90 **C** 222.30 **D** 120.00 **E** 136.80

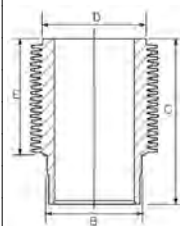

88-740900-00
 87-740900-00 +
 14-900100-00





87-740900-30 STD

- A 69.10
- B- 19.50
- BØ 56.00
- B+ 6.00
- D 123.60
- 35x80



AK KK RT

08-740900-10 STD

- 2.94mm CK
- 2.55 P
- 5.00 CR P



- 1 Bowl capacity 49.50cm³
- 2 Hone-Lapped

- 1 Volumen der Kolbenmulde 49.50cm³
- 2 Hongeläppt

- 1 Volume de la cavité du piston 49.50cm³
- 2 Rodée à la pierre

- 1 Vol. cavidad pistón 49.50cm³
- 2 Lapeado buñido

- 1 Volume camera pistone 49.50cm³
- 2 Parzialmente rodati

102.00

14

F 3L 913 G	3cyl.	3064cc	25-44kW (34-60PS)	Diesel	MP6601
AGRICULTURAL					

14-900100-00 DH

B 109.90 C 222.30 D 120.00 E 137.30

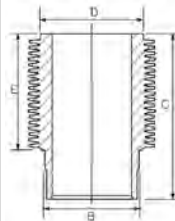

102.00

15

BF 4L 913	4cyl.	4086cc	47-81kW (64-110PS)	Diesel	Turbo	TD17203
BF 4L 913 C	4cyl.	4086cc	78-92kW (106-125PS)	Diesel	Turbo Intercooled	TD21059
BF 6L 913	6cyl.	6128cc	70-125kW (95-170PS)	Diesel	Turbo	TD17205
BF 6L 913 C	6cyl.	6128cc	81-162kW (110-220PS)	Diesel	Turbo Intercooled	TD17206
AGROPRIMA		01/89→12/95	Gondola			01/87→12/00
AGROSTAR		01/90→12/95	SERIE 6			01/05→
AGROXTRA		01/91→12/95	STARK			01/95→12/99
DX		01/78→				

- 14-900060-00** DH 1
- 14-900100-00** DH
- 14-900110-00** DH

B 109.90 C 222.30 D 120.00 E 136.80
B 109.90 C 222.30 D 120.00 E 137.30
B 109.90 C 220.40 D 124.50 E 134.90

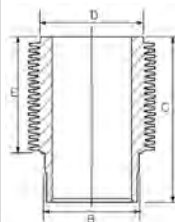

- 1 Hone-Lapped

- 1 Hongeläppt

- 1 Rodée à la pierre

- 1 Lapeado buñido

- 1 Parzialmente rodati

102.00

16

BF 4L 913 T	4cyl.	4086cc	60-78kW (82-106PS)	Diesel	Turbo	TD18347
BF 6L 913 T	6cyl.	6128cc	85-112kW (115-152PS)	Diesel	Turbo	TD18350
AGROSTAR		01/90→12/96	GT			01/98→
DX		01/82→	STARK			01/95→08/01





87-174600-30 STD
87-174607-30 0.50mm
 01/81→12/96

A 69.10
B- 17.60
BØ 58.00
B+ 6.00
D 123.60
 35x80



AK KK RT

08-174600-10 STD
08-174607-10 0.50mm

3.00 MO P
 2.50 P
 2.50 P
 5.00 CR P

14-900060-00 DH **B** 109.90 **C** 222.30 **D** 120.00 **E** 136.80
14-900110-00 DH **B** 109.90 **C** 220.40 **D** 124.50 **E** 134.90

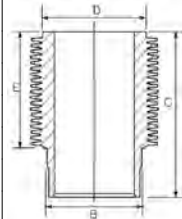

87-174600-00 STD

A 69.10
B- 23.60
BØ 58.00
B+ 6.00
D 123.60
 40x80



(10214-)

AK KK RT

08-174600-10 STD
08-174607-10 0.50mm

3.00 MO P
 2.50 P
 2.50 P
 5.00 CR P

14-900100-00 DH **B** 109.90 **C** 222.30 **D** 120.00 **E** 137.30

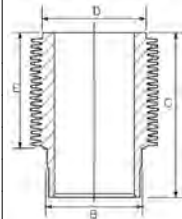

88-174600-00
 87-174600-00 +
 14-900100-00

Hone-Lapped

Hongeläppt

Rodée à la pierre

Lapeado buñido

Parzialmente rodati

102.00

17

F 4L 912 F	4cyl.	4086cc		Diesel	MP5922
F 4L 913 D	4cyl.	4086cc	34-66kW (46-90PS)	Diesel	TD17202
F 5L 912 F	5cyl.	5107cc		Diesel	MP5925
F 6L 912 F	6cyl.	6128cc		Diesel	MP5926
F 6L 913 D	6cyl.	6128cc	51-101kW (69-138PS)	Diesel	TD17204
AGROLUX			01/00→12/08	D-Series	01/71→12/87
AGROPLUS			01/96→12/04	DX	01/80→
AGROPRIMA			01/89→12/95	Farmer	01/83→
AGROSTAR			01/90→12/95	GT	01/84→
AGROXTRA			01/91→12/95	INDUSTRIAL	
D07			01/81→12/84	SERIE 6	01/05→

Hone-Lapped

Hongeläppt

Rodée à la pierre

Lapeado buñido

Parzialmente rodati

102.00

18

BF 6L 914 C	6cyl.	6472cc	107-147kW (145-200PS)	Diesel	Turbo Intercooled	TD17218
--------------------	-------	---------------	------------------------------	---------------	--------------------------	----------------

14-900060-00 DH **B** 109.90 **C** 222.30 **D** 120.00 **E** 136.80
14-900100-00 DH **B** 109.90 **C** 222.30 **D** 120.00 **E** 137.30

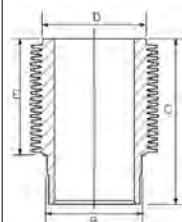



87-442400-00 STD
87-442407-00 0.50mm

A 65.60
B- 17.00
Bø 65.15
B+ 6.00
D 117.10
 40x80



AK KK RT

08-442400-00 STD
08-442407-00 0.50mm

2.94  CR
 3.00  CR
 3.00  CR

108.00

19

BF 4M 1013 (Euro 1)	4cyl.	4764cc	84-93kW (114-126PS)	Diesel	Turbo	TD17246
BF 4M 1013 C (Euro 1)	4cyl.	4764cc	104-115kW (141-156PS)	Diesel	Turbo Intercooled	TD17247
BF 6M 1013 (Euro 1)	6cyl.	7146cc	126-141kW (171-192PS)	Diesel	Turbo	TD17248
BF 6M 1013 C (Euro 1)	6cyl.	7146cc	153-170kW (208-231PS)	Diesel	Turbo Intercooled	TD17249

AGROTRON 01/03→12/04

87-136900-00 STD

A 71.15
B- 16.60
Bø 71.00
D 108.00
 42x86



AK RT

08-136900-00 STD ¹

3.00  CK P
 2.00  P
 3.50  CR P

15-480040-00 WH ²
14-480040-00 WH

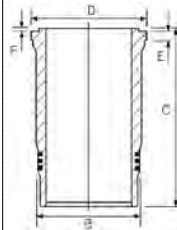

B 120.00 C 229.10 D 128.50 E 9.00 F 1.10
B 120.00 C 229.10 D 128.50 E 9.00 F 1.10

88-136900-00
 87-136900-00 +
 14-480040-00

¹ Euro 2

² Includes seals

² Schließt Dichtungen ein

² Inclut des joints

² Incluye los sellos

² Comprende le guarnizioni

108.00

20

BF 4M 1013 E (Euro 2)	4cyl.	4764cc	77-95kW (105-129PS)	Diesel	Turbo Intercooled	TD17244
TCD 2013 L4 2V (Euro 2)	4cyl.	4764cc	120kW (163PS)	Diesel	Turbo Intercooled	TD20766
TCD 2013 L6 2V (Euro 2)	6cyl.	7146cc	139-200kW (189-272PS)	Diesel	Turbo Intercooled	TD19988

AGROTRON L 05/08→

87-136900-10 STD ¹

A 71.15
B- 19.60
Bø 64.00
D 108.00
 42x86



AK RT TP

08-136900-00 STD ²

3.00  CK P
 2.00  P
 3.50  CR P

15-480040-00 WH ³
14-480040-00 WH

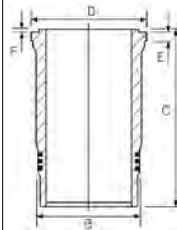

B 120.00 C 229.10 D 128.50 E 9.00 F 1.10
B 120.00 C 229.10 D 128.50 E 9.00 F 1.10

89-136900-10 ³
 87-136900-10 +
 15-480040-00

¹ Bowl capacity 54.00cm³

² Euro 2

³ Includes seals

¹ Volumen der Kolbenmulde 54.00cm³

¹ Volume de la cavité du piston 54.00cm³

¹ Vol. cavidad pistón 54.00cm³

¹ Volume camera pistone 54.00cm³

³ Schließt Dichtungen ein

³ Inclut des joints

³ Incluye los sellos

³ Comprende le guarnizioni

108.00





21





BF 4M 1013 EC (Euro 2)	4cyl.	4764cc	92-125kW (125-170PS)	Diesel	Turbo Intercooled	TD17241
BF 4M 1013 FC (Euro 2/3)	4cyl.	4764cc	105-157kW (143-214PS)	Diesel	Turbo Intercooled	TD20767
BF 6M 1013 EC (Euro 2)	6cyl.	7146cc	139-191kW (189-260PS)	Diesel	Turbo Intercooled	TD17242
BF 6M 1013 ECP (Euro 3)	6cyl.	7146cc	176-195kW (239-265PS)	Diesel	Turbo Intercooled	TD17243



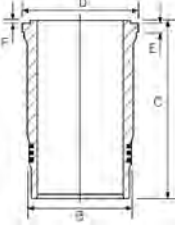

AGROTRON	01/97→12/07	NAVIGO	09/02→
AGROTRON TTV	01/01→12/03	Serie 170	01/05→
AS 950	09/04→	Serie 200	01/05→
D10.5	04/06→		





87-136900-10 STD ① A 71.15 B- 19.60 BØ 64.00 D 108.00  42x86 AK RT TP 	08-136900-00 STD ② 3.00  CK P 2.00  P 3.50  CR P	15-480040-00 WH ③ 14-480040-00 WH 	B 120.00 C 229.10 D 128.50 E 9.00 F 1.10 B 120.00 C 229.10 D 128.50 E 9.00 F 1.10 89-136900-10 ③ 87-136900-10 + 15-480040-00
--	---	---	---

87-136900-30 STD ④ A 71.75 B- 19.85 B- 10.25 BØ 63.00 D 108.00  42x87 AK RT TP 	08-136900-00 STD ② 3.00  CK P 2.00  P 3.50  CR P		
--	---	--	--

- ① Bowl capacity 54.00cm³ ② Volumen der Kolbenmulde 54.00cm³ ③ Volume de la cavité du piston 54.00cm³ ④ Vol. cavidad pistón 54.00cm³ ⑤ Volume camera pistone 54.00cm³
- ⑥ Euro 2 ⑦ Schließt Dichtungen ein ⑧ Inclut des joints ⑨ Incluye los sellos ⑩ Comprende le guarnizioni
- ⑪ Bowl capacity 50.70cm³ ⑫ Volumen der Kolbenmulde 50.70cm³ ⑬ Volume de la cavité du piston 50.70cm³ ⑭ Vol. cavidad pistón 50.70cm³ ⑮ Volume camera pistone 50.70cm³

108.00						22
TCD 2013 L4 4V (Euro 4)	4cyl.	4764cc	140-161kW (190-219PS)	Diesel	Turbo Intercooled	TD20769
TCD 2013 L06 4V (Euro 4)	6cyl.	7146cc	147-243kW (200-330PS)	Diesel	Turbo Intercooled	TD29652
TCD 2013 L6 4V (Euro 4)	6cyl.	7146cc	147-243kW (200-330PS)	Diesel	Turbo Intercooled	TD20765

AGROTRON X	01/06→	Serie 200	01/05→
AVANCITY	10/08→	TERRITO	09/10→
KENT	09/09→	VECTIO	04/07→
LEMBERG	01/12→	VIVACITY	09/08→

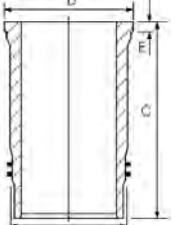
87-430000-00 STD A 70.90 B- 19.60 BØ 64.50 D 107.80  45x86 KK RT TP 	08-430000-00 STD 3.00  CK 2.00  P 3.50  CR	15-480450-00 WH ① 	B 120.00 C 228.00 D 131.70 E 8.06 89-430000-00 ① 87-430000-00 + 15-480450-00
--	---	---	--

- ① Includes seals ② Schließt Dichtungen ein ③ Inclut des joints ④ Incluye los sellos ⑤ Comprende le guarnizioni

108.00						23
BF 6M 1013 CP (Euro 1)	6cyl.	7146cc	171-190kW (233-258PS)	Diesel	Turbo Intercooled	TD17250





<p>87-136900-00 STD</p> <p>A 71.15 B- 16.60 BØ 71.00 D 108.00 42x86</p> <p>AK RT</p>	<p>08-136900-00 STD ①</p> <p>3.00 CK P 2.00 P 3.50 CR P</p>	<p>15-480040-00 WH ② 14-480040-00 WH</p>	<p>B 120.00 C 229.10 D 128.50 E 9.00 F 1.10 B 120.00 C 229.10 D 128.50 E 9.00 F 1.10</p>	<p>88-136900-00 87-136900-00 + 14-480040-00</p>
<p>87-136900-30 STD ③</p> <p>A 71.75 B- 19.85 B- 10.25 BØ 63.00 D 108.00 42x87</p> <p>AK RT TP</p>	<p>08-136900-00 STD ①</p> <p>3.00 CK P 2.00 P 3.50 CR P</p>			

- ① Euro 2
- ② Includes seals
- ③ Bowl capacity 50.70cm³
- ② Schließt Dichtungen ein
- ③ Volumen der Kolbenmulde 50.70cm³
- ② Inclut des joints
- ③ Volume de la cavité du piston 50.70cm³
- ② Incluye los sellos
- ③ Vol. cavidad pistón 50.70cm³
- ② Comprende le guarnizioni
- ③ Volume camera pistone 50.70cm³

108.00 **24**

BF 6M 1013 E (Euro 2)	6cyl.	7146cc	85-145kW (115-197PS)	Diesel	Turbo Intercooled	TD17245
AGROTRON			01/95→12/04	AGROTRON TTV		01/01→12/03

<p>87-136900-00 STD</p> <p>A 71.15 B- 16.60 BØ 71.00 D 108.00 42x86</p> <p>AK RT</p>	<p>08-136900-00 STD ①</p> <p>3.00 CK P 2.00 P 3.50 CR P</p>	<p>15-480040-00 WH ② 14-480040-00 WH</p>	<p>B 120.00 C 229.10 D 128.50 E 9.00 F 1.10 B 120.00 C 229.10 D 128.50 E 9.00 F 1.10</p>	<p>88-136900-00 87-136900-00 + 14-480040-00</p>
<p>87-136900-10 STD ③</p> <p>A 71.15 B- 19.60 BØ 64.00 D 108.00 42x86</p> <p>AK RT TP</p>	<p>08-136900-00 STD ①</p> <p>3.00 CK P 2.00 P 3.50 CR P</p>	<p>15-480040-00 WH ② 14-480040-00 WH</p>	<p>B 120.00 C 229.10 D 128.50 E 9.00 F 1.10 B 120.00 C 229.10 D 128.50 E 9.00 F 1.10</p>	<p>89-136900-10 ② 87-136900-10 + 14-480040-00</p>

- ① Euro 2
- ② Includes seals
- ③ Bowl capacity 54.00cm³
- ② Schließt Dichtungen ein
- ③ Volumen der Kolbenmulde 54.00cm³
- ② Inclut des joints
- ③ Volume de la cavité du piston 54.00cm³
- ② Incluye los sellos
- ③ Vol. cavidad pistón 54.00cm³
- ② Comprende le guarnizioni
- ③ Volume camera pistone 54.00cm³





108.00 **25**

BF 6M 1013 FC (Euro 2/3)	6cyl.	7146cc	147-210kW (200-286PS)	Diesel	Turbo Intercooled	TD20768
AGROTRON			01/98→	D12MEDIS		01/08→12/17







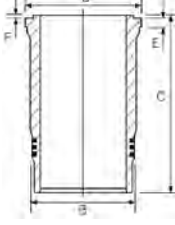

COBRA	05/04→	D13.2MEDIS	01/10→12/12
D12	01/06→12/16	Heavy Series	01/02→
D12F	01/09→12/12	Serie 100	01/96→

87-136900-30 STD ① A 71.75 B- 19.85 B- 10.25 BØ 63.00 D 108.00   AK RT TP	08-136900-00 STD ② 3.00  CK P 2.00  P 3.50  CR P	15-480040-00 WH ③ 14-480040-00 WH 	B 120.00 C 229.10 D 128.50 E 9.00 F 1.10 B 120.00 C 229.10 D 128.50 E 9.00 F 1.10
--	--	---	--

- ① Bowl capacity 50.70cm³
- ② Euro 2
- ③ Includes seals
- ① Volumen der Kolbenmulde 50.70cm³
- ② Schließt Dichtungen ein
- ③ Schließt Dichtungen ein
- ① Volume de la cavité du piston 50.70cm³
- ② Includ des joints
- ③ Includ des joints
- ① Vol. cavidad pistón 50.70cm³
- ② Incluye los sellos
- ③ Incluye los sellos
- ① Volume camera pistone 50.70cm³
- ② Comprende le guarnizioni
- ③ Comprende le guarnizioni

115.00					26
8360.05.670 (Magirus-Deutz)	6cyl.	8100cc	119kW (162PS)	Diesel	TD7572

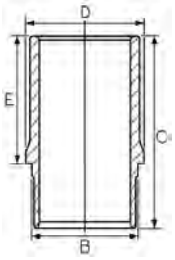
87-523000-00 STD A 76.50 B- 29.40 BØ 54.00 D 140.50   RT	08-523000-00 STD 2.50  CR P 2.50  P 4.00  CR P	14-684840-00 WH 14-633860-00 WH 	B 122.00 C 235.00 D 129.70 E 167.00 B 122.00 C 235.00 D 129.90 E 167.00	88-523000-00 87-523000-00 + 14-684840-00
--	--	--	--	---

120.00					27
F 5L 413	5cyl.	7070cc		Diesel	MP6143
F 6L 413 L	V6cyl.	8482cc	137kW (186PS)	Diesel	MP5381
F 8L 413 L	V8cyl.	11310cc	179kW (243PS)	Diesel	MP5382
F 10L 413 L	V10cyl.	14137cc	198-224kW (270-305PS)	Diesel	MP5383

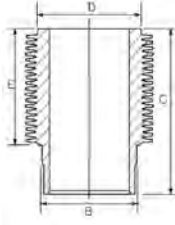
INDUSTRIAL					
			14-900070-00 DH 	B 131.60 C 255.50 D 144.90 E 170.08	

120.00					28
F 6L 413	V6cyl.	8478cc	99-130kW (135-177PS)	Diesel	TD18362
F 8L 413	V8cyl.	11310cc	169kW (230PS)	Diesel	TD18363
F 10L 413	V10cyl.	14140cc	167-224kW (227-305PS)	Diesel	TD18352
F 12L 413	V12cyl.	16960cc	250kW (340PS)	Diesel	TD18354





87-167600-00 STD ①
87-167607-00 0.50mm
87-167611-00 1.00mm

A 90.16
B- 39.46
BØ 46.00
B+ 5.09
D 145.25



AK RT

08-167600-10 STD
08-167611-10 1.00mm

3.00 CR P
 3.00 P
 3.00 P
 6.00 CR P



14-900070-00 DH

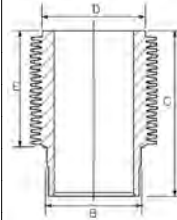

B 131.60 **C** 255.50 **D** 144.90 **E** 170.08

① Bowl capacity 63.00cm³

① Volumen der Kolbenmulde 63.00cm³

① Volume de la cavité du piston 63.00cm³

① Vol. cavidad pistón 63.00cm³

① Volume camera pistone 63.00cm³

125.00

29

F 4L 413 FR	4cyl.	6381cc	94kW (128PS)	Diesel	TD18340
F 5L 413 FR	5cyl.	7976cc	94-118kW (128-160PS)	Diesel	TD17882
F 6L 413 F	V6cyl.	9572cc	104-188kW (141-256PS)	Diesel	TD18341
F 6L 413 FR	V6cyl.	9572cc	112-141kW (152-192PS)	Diesel	TD21274
F 8L 413 F	V8cyl.	12763cc	147-188kW (200-256PS)	Diesel	TD18342
F 10L 413 F	V10cyl.	15953cc	235kW (320PS)	Diesel	TD18353
F 12L 413 F	V12cyl.	19144cc	224-282kW (305-384PS)	Diesel	TD18355

87-740300-00 STD

A 87.40
B- 47.65
BØ 48.00
B+ 5.25
C 1.00
C 1.20
D 138.65
 45x102



(12544)

HA RT

08-740300-10 STD
08-740307-10 0.50mm

3.00 CK P
 2.50 P
 4.00 CR P



14-900050-00 DH ①

14-900030-00 DH ②

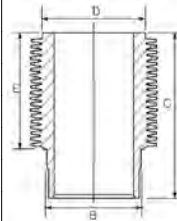

B 139.00 **C** 250.76 **D** 150.00 **E** 169.50

B 139.00 **C** 250.80 **D** 154.00 **E** 169.50

88-740300-00
 87-740300-00 +
 14-900050-00

88-740300-10
 87-740300-00 +
 14-900030-00

① Phosphated
 ② Hone-Lapped

① Phosphatiert
 ② Hongeläppt

① Phosphaté
 ② Rodée à la pierre

① Fosfatado
 ② Lapeado buñido

① Fosfatato
 ② Parzialmente rodati

125.00

30

BF 6L 413 FR	V6cyl.	9572cc	143-177kW (194-241PS)	Diesel	Turbo	TD19028
BF 6L 513	V6cyl.	9572cc	141-210kW (192-286PS)	Diesel	Turbo	TD19240
BF 6L 513 C	V6cyl.	9572cc	112-177kW (152-241PS)	Diesel	Turbo Intercooled	TD21275
BF 8L 413 F	V8cyl.	12763cc	212-235kW (288-320PS)	Diesel	Turbo	TD18351
BF 8L 513	V8cyl.	12763cc	235-250kW (320-340PS)	Diesel	Turbo	TD18495
BF 8L 513 C	8cyl.	13738cc	265kW (360PS)	Diesel	Turbo Intercooled	TD26618
BF 10L 413 F	V10cyl.	15953cc	265-294kW (360-400PS)	Diesel	Turbo	TD18344
BF 10L 513	V10cyl.	15954cc	218-305kW (296-415PS)	Diesel	Turbo	TD18127
BF 10L 513 C	V10cyl.	15954cc	265-294kW (360-400PS)	Diesel	Turbo Intercooled	TD21060
BF 10L 513 F	V10cyl.	15945cc	253-294kW (344-400PS)	Diesel	Turbo	TD19241
BF 12L 413 F	V12cyl.	19144cc	268-353kW (364-480PS)	Diesel	Turbo	TD18346
BF 12L 513	V12cyl.	19144cc	353-367kW (480-499PS)	Diesel	Turbo	TD18496
BF 12L 513 C	V12cyl.	19144cc	386-405kW (525-551PS)	Diesel	Turbo Intercooled	TD18498
BF 12L 513 F	V12cyl.	19144cc	282-353kW (384-480PS)	Diesel	Turbo	TD19029
F 6L 413 FW	V6cyl.	9572cc	96-121kW (131-165PS)	Diesel		TD17883
F 8L 413 FW	V8cyl.	12763cc	129-150kW (175-204PS)	Diesel		TD17885



F 10L 413 FW	V10cyl.	15953cc	161-202kW (219-275PS)	Diesel	TD17886
F 12L 413 FW	V12cyl.	19144cc	193-243kW (262-330PS)	Diesel	TD17888
AGROSTAR		01/93→12/96	DX		01/80→

14-900030-00 DH ① **B 139.00 C 250.80 D 154.00 E 169.50**
14-900050-00 DH ② **B 139.00 C 250.76 D 150.00 E 169.50**

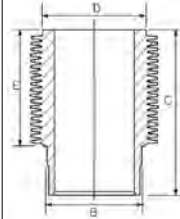

① Hone-Lapped
 ② Phosphated

① Hongeläppt
 ② Phosphatiert

① Rodée à la pierre
 ② Phosphaté

① Lapeado buñido
 ② Fosfatado

① Parzialmente rodati
 ② Fosfatato

132.00						31
BF 6M 1015	V6cyl.	11905cc	195-250kW (265-340PS)	Diesel Turbo	TD17254	
BF 6M 1015 CP	V6cyl.	11905cc	300-384kW (408-522PS)	Diesel Turbo Intercooled	TD17255	
BF 8M 1015 (1015)	V8cyl.	15874cc	290kW (394PS)	Diesel	TD18499	
BF 8M 1015 CP	V8cyl.	15874cc	399-517kW (543-703PS)	Diesel Bi-Turbo Intercooled	TD17256	

14-450960-00 WH **B 147.00 C 268.50 D 158.00 E 9.00 F 1.25**

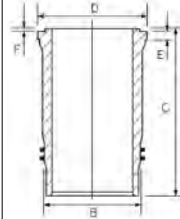

132.00						32
BF 6M 1015 C (Euro 2)	V6cyl.	11905cc	250-345kW (340-469PS)	Diesel Turbo Intercooled	TD17252	
BF 8M 1015 C (Euro 2)	V8cyl.	15874cc	333-459kW (453-624PS)	Diesel Bi-Turbo Intercooled	TD17253	

65226	05/04→	Gondola	01/91→12/97
-------	--------	---------	-------------

87-123900-10 STD

A 86.80
 B- 18.80
 BØ 84.00
 D 133.80
 52x110



AK KK RT TP

08-123900-10 STD

3.50  CK
 2.45  CR
 4.00  CR

LKZ-Ring

14-450960-00 WH **B 147.00 C 268.50 D 158.00 E 9.00 F 1.25**

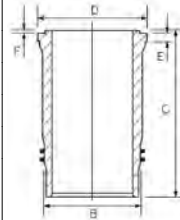

88-123900-10
 87-123900-10 +
 14-450960-00

CCM
x

9

4HP	Diesel	2179	4	85.00	51
4HR	Diesel	2179	4	85.00	51
4HS (Euro 4)	Diesel	2179	4	85.00	51
4HT (DW12BTED4) (Euro 4)	Diesel	2179	4	85.00	51
4HU (P22 DTE PUMA)	Diesel	2198	4	86.00	57
4HV (Euro 4)	Diesel	2198	4	86.00	58
4HW (DW12ATED4)	Diesel	2179	4	85.00	52
4HX (DW12TED4)	Diesel	2179	4	85.00	52
9HM (DV6UC)	Diesel	1560	4	75.00	26
9HU	Diesel	1560	4	75.00	27
100 G.000	Petrol	843	4	65.00	1
100 G.002	Petrol	843	4	65.00	1
100 GC.000	Petrol	843	4	65.00	1
100 GF 000	Petrol	903	4	65.00	1
100 GL.000	Petrol	903	4	65.00	1
100 GL.048	Petrol	903	4	65.00	1
100 GL3.000	Petrol	903	4	65.00	1
110 D.000	Petrol	499	2	70.00	11
110 F.000	Petrol	499	2	67.40	6
120.000	Petrol	499	2	67.40	6
124 B.000	Petrol	1438	4	80.00	31
125 A.000	Petrol	1608	4	80.00	31
125 B.000	Petrol	1608	4	80.00	31
126 A.000	Petrol	594	2	73.50	25
126 A1.000	Petrol	652	2	77.00	29
126 A1.048	Petrol	652	2	77.00	29
126 A2.000	Petrol	704	2	80.00	31
126 A2.048	Petrol	704	2	80.00	31
127 A.000	Petrol	903	4	65.00	1
127 A5.000	Diesel	1301	4	76.00	28
128 A.000	Petrol	1116	4	80.00	31
128 A.048	Petrol	1116	4	80.00	31
128 A 064	Petrol	1116	4	80.00	31
128 AC5.000	Petrol	1116	4	80.00	31
132 AC1.000	Petrol	1756	4	84.00	49
132 BB OA O	Petrol	1592	4	80.00	31
132 C3.031	Petrol	1995	4	84.00	49
132 DB.2A-828BC	Petrol	1995	4	84.00	49
138 AE 0A.0	Petrol	1116	4	80.00	31
138 B.000	Petrol	1116	4	80.00	31
138 C.000	Diesel	1698	4	82.60	40
141 B.000	Petrol	770	4	65.00	3
146 A.000	Petrol	903	4	65.00	4
146 A.048	Petrol	903	4	65.00	1
146 A1.000	Petrol	903	4	65.00	4
146 B1.000	Diesel	1301	4	76.00	28
146 B2.000	Diesel	1698	4	82.60	40
146 D7.000	Diesel	1698	4	82.60	41
149 A1.000	Diesel	1929	4	82.60	42
149 B1.000	Diesel	1929	4	82.60	42
149 B3.000	Diesel	1698	4	82.60	40
149 B4.000	Diesel	1698	4	82.60	40
149 B4.046	Diesel	1698	4	82.60	40
149 B5.046	Diesel	1929	4	82.60	42
154 A1.000	Petrol	1995	4	84.00	49
154 A2.000	Petrol	1995	4	84.00	49
154 B.000	Diesel	1929	4	82.60	42
154 C3.046	Petrol	1995	4	84.00	49
154 C4.046	Petrol	1995	4	84.00	49
154 C6.000	Diesel	1929	4	82.60	42

ENGINE INDEX

Motorverzeichnis • Index de moteur • Índice de Motor
 Indeks silnika • Модель Двигателя • دليل المحرك

CCM
x

9

154 D1.000	Diesel	1929	4	82.60	42
154 E1.000	Petrol	1995	4	84.00	49
156 A2.000 (Fire)	Petrol	999	4	70.00	13
156 A2.0157 (Fire)	Petrol	999	4	70.00	14
156 A2.050 (Fire)	Petrol	999	4	70.00	14
156 A2.100 (Fire)	Petrol	999	4	70.00	13
156 A2.246 (Fire)	Petrol	999	4	70.00	15
156 A3.000 (Fire)	Petrol	999	4	70.00	13
156 A4.000 (Fire)	Petrol	770	4	65.00	3
156 A4.048 (Fire)	Petrol	770	4	65.00	3
156 A5.000	Diesel	1301	4	76.00	28
156 C.046 (Fire)	Petrol	1108	4	70.00	15
159 A4.000	Petrol	1756	4	84.00	49
159 A4.046	Petrol	1756	4	84.00	49
159 A6.046	Petrol	1995	4	84.00	49
160 A3.000 (Fire)	Petrol	1108	4	70.00	16
160 A6.000	Diesel	1929	4	82.60	43
160 A6.046	Diesel	1929	4	82.60	43
160 A7.000	Diesel	1929	4	82.60	42
160 B6.046	Diesel	1929	4	82.60	43
160 D1.000	Diesel	1929	4	82.60	43
169 A1.000	Diesel	1248	4	69.60	7
170 A.000	Petrol	704	2	80.00	31
170 A.046	Petrol	704	2	80.00	31
170 A1.000	Petrol	903	4	65.00	2
170 A1.046	Petrol	903	4	65.00	2
170 B	Petrol	1971	4	88.00	59
170 D	Petrol	1971	4	88.00	59
175 A1.000	Petrol	1995	4	84.00	50
176 A5.000	Diesel	1698	4	82.60	41
176 A6.000 (Fire)	Petrol	1108	4	70.00	17
176 A7.000 (Fire)	Petrol	1242	4	70.80	18
176 A8.000 (Fire)	Petrol	1242	4	70.80	19
176 B1.000	Petrol	1242	4	70.80	19
176 B2.000 (Euro 2 Fire)	Petrol	1108	4	70.00	17
176 B3.000	Diesel	1698	4	82.60	40
176 B4.000 (Fire)	Petrol	1242	4	70.80	19
176 B7.000	Diesel	1698	4	82.60	41
176 B9.000 (Fire)	Petrol	1242	4	70.80	20
178 B5.000 (Euro 3 Fire)	Petrol	1242	4	70.80	19
178 E2.000 (Fire)	Petrol	1242	4	70.80	19
178 E8.011 (Fire)	Petrol	1242	4	70.80	21
178 E9.011 (Fire)	Petrol	1242	4	70.80	21
178 F3.011	Petrol	1368	4	72.00	23
182 A2.000 (Euro 2)	Petrol	1747	4	82.00	34
182 A7.000	Diesel	1910	4	82.00	35
182 A8.000	Diesel	1910	4	82.00	35
182 B2.000 (Fire)	Petrol	1242	4	70.80	20
182 B4.000 (Euro 2)	Diesel	1910	4	82.00	35
182 B6.000 (Euro 3)	Petrol	1596	4	80.50	33
182 B9.000 (Euro 3)	Diesel	1910	4	82.00	36
183 A1.000 (Euro 2)	Petrol	1747	4	82.00	34
185 A2.000	Diesel	2387	5	82.00	35
185 A6.000 (Euro 2)	Diesel	2387	5	82.00	35
186 A6.000 (Euro 3)	Diesel	1910	4	82.00	35
186 A8.000	Diesel	1910	4	82.00	36
186 A9.000	Diesel	1910	4	82.00	36
187 A1.000 (Euro 3 Fire)	Petrol	1108	4	70.00	17
188 A2.000 (Euro 3)	Diesel	1910	4	82.00	35
188 A3.000	Diesel	1910	4	82.00	37

CCM
x

9

188 A4.000 (Euro 3 Fire)	Petrol	1242	4	70.80	19
188 A5.000 (Euro 3 Fire)	Petrol	1242	4	70.80	22
188 A7.000 (Euro 3)	Diesel	1910	4	82.00	35
188 A8.000	Diesel	1248	4	69.60	7
188 A9.000	Diesel	1248	4	69.60	7
188 B2.000	Diesel	1910	4	82.00	36
192 A1.000	Diesel	1910	4	82.00	36
192 A3.000 (Euro 3)	Diesel	1910	4	82.00	35
192 A5.000	Diesel	1910	4	82.00	38
192 A8.000	Diesel	1910	4	82.00	36
192 B1.000	Diesel	1910	4	82.00	38
192 B2.000	Petrol	1368	4	72.00	24
198 A3.000	Diesel	1598	4	79.50	30
198 A5.000	Diesel	1956	4	83.00	45
199 A2.000	Diesel	1248	4	69.60	7
199 A3.000	Diesel	1248	4	69.60	8
199 A5.000	Diesel	1910	4	82.00	36
199 B1.000 (Euro 5)	Diesel	1248	4	69.60	9
199 B5.000	Diesel	1598	4	79.50	30
200 B/BF/CF/CP1/CZ1	Petrol	903	4	65.00	5
223 A5.000 (Euro 3 Fire)	Petrol	1242	4	70.80	19
223 A6.000 (Euro 3)	Diesel	1910	4	82.00	37
223 A7.000	Diesel	1910	4	82.00	36
223 A9.000	Diesel	1248	4	69.60	8
230 A2.000	Diesel	1929	4	82.60	42
230 A3.000	Diesel	1929	4	82.60	43
230 A4.000 (Euro 2)	Diesel	1929	4	82.60	43
250 A1.000 (Euro 5)	Diesel	1956	4	83.00	45
263 A1.000 (Euro 5)	Diesel	1956	4	83.00	45
263 A2.000	Diesel	1248	4	69.60	9
263 A3.000	Diesel	1598	4	79.50	30
263 A8.000	Diesel	1598	4	79.50	30
280 A1.000	Diesel	1929	4	82.60	43
312 A4.000 (TwinAir)	Petrol	964	2	83.50	48
312 A6.000 (TwinAir)	Petrol	964	2	83.50	48
312 A8.000 (Euro 6)	Diesel	1248	4	69.60	10
312 B2.000 (Euro 6)	Diesel	1248	4	69.60	10
350 A1.000 (Euro 4/5)	Petrol	1368	4	72.00	23
350 A3.000	Diesel	1598	4	79.50	30
552 60 384	Diesel	1598	4	79.50	30
831 D1.000	Diesel	1929	4	82.60	42
834 B.000	Petrol	1995	4	84.00	49
834 B.048	Petrol	1995	4	84.00	49
834 B.146	Petrol	1995	4	84.00	49
834 C.146	Petrol	1995	4	84.00	49
835 C2.000	Petrol	1756	4	84.00	49
835 C4.000	Petrol	1756	4	84.00	49
836 A3.000	Petrol	1995	4	84.00	49
836 A5.000	Petrol	1756	4	84.00	49
836 A6.000	Petrol	1756	4	84.00	49
839 A5.000 (Euro 2)	Diesel	2387	5	82.00	35
843 A1.000 (Euro 4 Fire)	Petrol	1368	4	72.00	24
844 A2.000	Diesel	1956	4	83.00	45
844 A3.000	Diesel	1598	4	79.50	30
937 A4.000	Diesel	1910	4	82.00	38
937 A5.000	Diesel	1910	4	82.00	38
937 A7.000	Diesel	1910	4	82.00	36
939 A1.000	Diesel	1910	4	82.00	36
939 A2.000	Diesel	1910	4	82.00	38
939 A3.000	Diesel	2387	5	82.00	38

ENGINE INDEX

Motorverzeichnis • Index de moteur • Índice de Motor
 Indeks silnika • Модель Двигателя • دليل المحرك



CCM

x



9

939 B5.000	Diesel	1956	4	83.00	45
940 A5.000 (Euro 5)	Diesel	1956	4	83.00	45
940 C1.000	Diesel	1598	4	79.50	30
955 A4.000	Diesel	1598	4	79.50	30
1170 A1.046	Petrol	899	4	65.00	2
8140.07	Diesel	2500	4	93.00	65
8140.212/214/29 (Sofim)	Diesel	2445	4	93.00	66
8140.27 (Sofim)	Diesel	2500	4	93.00	67
8140.27R/S.2700 (Sofim)	Diesel	2500	4	93.00	67
8140.27S.3700 (Euro 1)	Diesel	2500	4	93.00	68
8140.43 (Euro 2 Sofim)	Diesel	2800	4	94.40	71
8140.43N (Euro 3 Sofim)	Diesel	2800	4	94.40	72
8140.43S (Euro 3 Sofim)	Diesel	2800	4	94.40	72
8140.47	Diesel	2500	4	93.00	68
8140.47R (Sofim)	Diesel	2500	4	93.00	68
8140.47R.2210	Diesel	2500	4	93.00	68
8140.61	Diesel	2445	4	93.00	69
8140.63 (Euro 2 Sofim)	Diesel	2800	4	94.40	73
8140.67	Diesel	2500	4	93.00	65
8140.97Y (Sofim)	Diesel	2500	4	93.00	65
8142.61	Diesel	2445	4	93.00	69
8144.21 (Sofim)	Diesel	2445	4	93.00	66
8144.61	Diesel	2445	4	93.00	69
8144.67	Diesel	2500	4	93.00	69
8144.97 (Sofim)	Diesel	2500	4	93.00	65
8144.97 S (Sofim)	Diesel	2500	4	93.00	65
8144.97 Y (Sofim)	Diesel	2500	4	93.00	65
8140.21.201-203 (Sofim)	Diesel	2445	4	93.00	66
8140.27.2100	Diesel	2500	4	93.00	67
8140.47.3700	Diesel	2500	4	93.00	68
8140.61.204	Diesel	2445	4	93.00	69
8140.67.2700	Diesel	2500	4	93.00	65
8140.67.X230 (Sofim)	Diesel	2500	4	93.00	65
8144.21.220	Diesel	2445	4	93.00	66
8144.61.200 (SOFIM)	Diesel	2445	4	93.00	69
8144.61.500.81	Diesel	2445	4	93.00	69
8144.67.220	Diesel	2500	4	93.00	69
8144.81.2000	Diesel	2500	4	93.00	69
8144.91.2000	Diesel	2445	4	93.00	69
8144.97.2200	Diesel	2500	4	93.00	69
8144.97.2400	Diesel	2500	4	93.00	65
8144.97.2500	Diesel	2500	4	93.00	69
A 112 B2	Petrol	903	4	65.00	5
B 25.637	Diesel	2500	4	93.00	70
CRD93L (U25-661)	Diesel	2500	4	93.00	70
D8B	Diesel	1905	4	83.00	46
D9B (XUD9A) (XUD9)	Diesel	1905	4	83.00	47
D9B (XUD9/A/B/L/Y) (XUD9)	Diesel	1905	4	83.00	47
D19AA	Diesel	1910	4	82.00	36
DHX (XUD9TE)	Diesel	1905	4	83.00	46
DHX (XUD9TF/L)	Diesel	1905	4	83.00	46
DJY (XUD9)	Diesel	1905	4	83.00	47
DJY (XUD9A)	Diesel	1905	4	83.00	47
DW10 (RHX)	Diesel	1997	4	85.00	53
DW10 (RHZ)	Diesel	1997	4	85.00	53
DW10ATED4 (RHM)	Diesel	1997	4	85.00	54
DW10ATED4 (RHS)	Diesel	1997	4	85.00	54
DW10BTED4	Diesel	1997	4	85.00	55
F1AE0481C (Euro 3)	Diesel	2287	4	88.00	61
F1AE0481D (Euro 4)	Diesel	2287	4	88.00	62

CCM
x

9

F1AE3481D	Diesel	2287	4	88.00	63
F1AE3481E	Diesel	2287	4	88.00	63
F1AE3481G	Diesel	2287	4	88.00	63
F1CE0481D (Euro 4)	Diesel	2999	4	95.80	74
F1CE3481E (Euro 5)	Diesel	2999	4	95.80	75
F1CE3481M (Euro 5)	Diesel	2999	4	95.80	75
F1CE3481N (Euro 5)	Diesel	2999	4	95.80	75
GSE-T3 (Euro 6 FireFly)	Petrol	999	3	70.00	12
GSE-T4 (Euro 6 FireFly)	Petrol	1332	4	70.00	12
LFW (XU7 JP) (Euro 2)	Petrol	1761	4	83.00	44
M204 A.A.11 (Fire)	Petrol	1108	4	70.00	16
M401 LG.20.0	Petrol	1995	4	84.00	49
M601 HA.20.0	Petrol	1995	4	84.00	49
M619 AA 2.0	Petrol	1995	4	84.00	49
R9M 408	Diesel	1598	4	80.00	32
R9M 413	Diesel	1598	4	80.00	32
R9M 450	Diesel	1598	4	80.00	32
R9M 452	Diesel	1598	4	80.00	32
RH02	Diesel	1997	4	85.00	56
RHH (Euro 5)	Diesel	1997	4	85.00	56
RHK	Diesel	1997	4	85.00	55
RHK (DW10UTED4) (Euro 4)	Diesel	1997	4	85.00	55
RHR	Diesel	1997	4	85.00	55
RHV	Diesel	1997	4	85.00	53
THY (DK5ATE)	Diesel	2446	4	92.00	64
WJY (DW8)	Diesel	1868	4	82.20	39
WJY (DW8B)	Diesel	1868	4	82.20	39
WJZ (DW8)	Diesel	1868	4	82.20	39
XN 1T	Petrol	1971	4	88.00	60



65.00					1
100 G.000	4cyl.	843cc	25kW (34PS)	Petrol	TD863
100 G.002	4cyl.	843cc	27kW (37PS)	Petrol	TD864
100 GC.000	4cyl.	843cc	38kW (52PS)	Petrol	TD868
100 GF 000	4cyl.	903cc	26kW (35PS)	Petrol	TD6939
100 GL.000	4cyl.	903cc	30-33kW (41-45PS)	Petrol	TD870
100 GL3.000	4cyl.	903cc	33kW (45PS)	Petrol	TD869
100 GL.048	4cyl.	903cc	29kW (40PS)	Petrol	TD4413
127 A.000	4cyl.	903cc	34--kW (46--PS)	Petrol	TD887
146 A.048	4cyl.	903cc	33kW (45PS)	Petrol	TD934
127 0.9			06/71→12/84	FIORINO 900	10/77→10/86
127 1.0			01/77→12/86	FIORINO 1050	01/80→12/87
147 1.0			10/76→12/95	FIORINO Pick up 1.0	06/82→10/87
850 0.8			07/64→10/72	PANDA 0.9 Fire S	10/80→04/86
900T/E 0.9			01/78→01/86	PANDA 900	10/80→06/94
FIORINO 1.0			01/80→12/87	UNO 0.9	02/84→08/89

87-209800-00 STD
 87-209806-00 0.40mm
 87-209808-00 0.60mm

A 30.75
 D 61.25
 20x54

08-209800-00 STD
 08-209806-00 0.40mm
 08-209808-00 0.60mm

1.75
 2.00
 3.94

CR P
 P
 P

14-011001-00 D B 68.04 C 115.00

65.00					2
170 A1.000	4cyl.	903cc	30kW (41PS)	Petrol	TD15810
170 A1.046	4cyl.	903cc	30kW (41PS)	Petrol	TD15811
1170 A1.046	4cyl.	899cc	29kW (39PS)	Petrol	TD872
CINQUECENTO 0.9			07/91→12/93	CINQUECENTO VAN 0.9 iE	07/91→02/98
CINQUECENTO 0.9 i.e.			07/91→09/94	PANDA 900	04/92→12/96
CINQUECENTO 0.9 i.e. S			07/91→07/99	SEICENTO / 600 0.9	11/97→01/10

87-145100-00 STD
 87-145106-00 0.40mm
 87-145108-00 0.60mm

A 31.25
 D 54.25
 20x54

08-145100-00 STD
 08-145106-00 0.40mm
 08-145108-00 0.60mm

1.50
 1.50
 3.00

NT
 P
 P

14-011001-00 D B 68.04 C 115.00

65.00					3
141 B.000	4cyl.	770cc	25kW (34PS)	Petrol	TD4370
156 A4.000 (Fire)	4cyl.	770cc	25kW (34PS)	Petrol	TD11307
156 A4.048 (Fire)	4cyl.	770cc	25kW (34PS)	Petrol	TD11308
PANDA 750			01/86→10/03		





14-011001-00 D

B 68.04 C 115.00

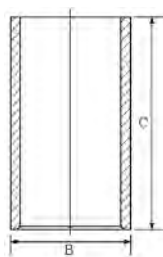

65.00

4

146 A.000	4cyl.	903cc	33kW (45PS)	Petrol	TD4371
146 A1.000	4cyl.	903cc	33kW (45PS)	Petrol	TD4372
PANDA 900			10/80→06/94	UNO 45 0.9	03/83→07/96

87-209800-10 STD
87-209806-10 0.40mm
87-209808-10 0.60mm

08-209800-00 STD
08-209806-00 0.40mm
08-209808-00 0.60mm

14-011001-00 D

B 68.04 C 115.00

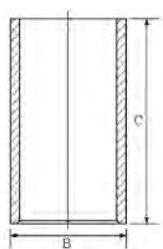

A 31.25
D 61.75
 20x54



1.75 CR P
 2.00 P
 3.94 P

Without circlips

Ohne Sicherungsclips

Sans circlips

Sin anillos de retención

Pistone con spinotto montato a caldo

65.00

5

200 B/BF/CF/CP1/CZ1	4cyl.	903cc	Petrol	MP3952
A 112 B2	4cyl.	903cc	Petrol	MP514
850 0.9		01/65→12/76	900T 0.9	01/76→12/80
850T 0.9		01/77→12/80	A112 0.9	07/75→
900E 0.9		01/77→12/80		

87-209800-00 STD
87-209806-00 0.40mm
87-209808-00 0.60mm

08-209800-00 STD
08-209806-00 0.40mm
08-209808-00 0.60mm

14-011001-00 D

B 68.04 C 115.00

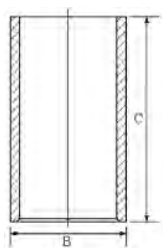

A 30.75
D 61.25
 20x54



1.75 CR P
 2.00 P
 3.94 P





87-209800-10 STD
 87-209806-10 0.40mm
 87-209808-10 0.60mm

08-209800-00 STD
 08-209806-00 0.40mm
 08-209808-00 0.60mm

A 31.25
 D 61.75
 20x54



1.75 CR P
 2.00 P
 3.94 P

Without circlips

Ohne Sicherungsclips

Sans circlips

Sin anillos de retención

Pistone con spinotto montato a caldo

67.40

6

110 F.000	2cyl.	499cc	13kW (18PS)	Petrol	TD871
120.000	2cyl.	499cc	13kW (18PS)	Petrol	TD873
500 0.5			01/60→12/75		

87-527600-00 STD
 87-527606-00 0.40mm
 87-527608-00 0.60mm

08-527600-00 STD
 08-527606-00 0.40mm
 08-527608-00 0.60mm

A 37.95
 B+ 2.75
 D 74.70
 20x55



2.00 CR P
 2.00 P
 2.00 P
 3.96 P

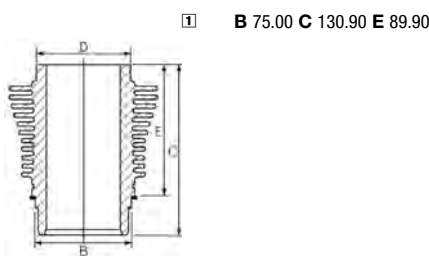

88-527600-00
 87-527600-00

Liner available in Kit Set only

Zylinderlaufbuche nur in Assemblies verfügbar

Chemise disponible en kit seulement

Camisas disponible en conjuntos solamente.

Cilindro disponibile solo in kit motore

69.60

7

169 A1.000	4cyl.	1248cc	55kW (75PS)	Diesel	Turbo Intercooled	TD20236
188 A8.000	4cyl.	1248cc	51kW (70PS)	Diesel	Turbo Intercooled	TD23866
188 A9.000	4cyl.	1248cc	51-66kW (70-90PS)	Diesel	Turbo Intercooled	TD17456
199 A2.000	4cyl.	1248cc	55-68kW (75-93PS)	Diesel	Turbo Intercooled	TD20240

500 1.3 D Multijet	10/07→	LINEA 1.3 JTD Multijet	01/08→
500 C 1.3 D Multijet	09/09→	PALIO 1.3 D Multijet	03/08→11/11
AVVENTURA 1.3 JTD Multijet	10/14→07/16	PALIO 1.3 JTD Multijet	06/03→01/12
DOBLO 1.3 D Multijet	10/05→01/10	PANDA 1.3 D Multijet	09/03→
DOBLO 1.3 JTD	05/05→	PANDA 1.3 JTD Multijet	09/10→08/13
DOBLO 1.3 JTD 16V	05/04→12/06	PUNTO 1.3 D Multijet	04/08→
FIORINO 1.3 D Multijet	11/07→	PUNTO 1.3 JTD	06/03→10/05
FIORINO 1.3 JTD Multijet	11/07→	PUNTO 1.3 JTD 16V	06/03→03/12
GRANDE PUNTO 1.3 D Multijet	10/05→	PUNTO EVO 1.3 D Multijet	03/09→
GRANDE PUNTO 1.3 JTD Multijet	02/06→06/13	QUBO 1.3 D Multijet	02/08→
IDEA 1.3 D Multijet	01/04→	SIENA 1.3 JTD	09/03→12/09
IDEA JTD Multijet	10/04→12/11		





87-137600-00 STD
87-137606-00 0.40mm

A 40.43
B- 12.40
BØ 37.00
C 1.00
C 1.20
D 63.43
 23x57

AK RT TP

08-137600-00 STD
08-137606-00 0.40mm

2.00 CK P
 1.50 P
 2.00 P

14-022060-00 D **B 72.50 C 142.00 D 74.00 E 5.00**

69.60						8
199 A3.000	4cyl.	1248cc	63-70kW (86-95PS)	Diesel	Turbo Intercooled	TD20241
223 A9.000	4cyl.	1248cc	62kW (84PS)	Diesel	Turbo Intercooled	TD20243
DOBLO 1.3 D Multijet			10/05→	IDEA JTD Multijet		04/05→12/10
DOBLO 1.3 JTD 16V Multijet			08/06→	LINEA 1.3 D Multijet		06/07→
GRANDE PUNTO 1.3 D Multijet			10/05→	LINEA 1.3 JTD Multijet		10/06→
GRANDE PUNTO 1.3 JTD Multijet			02/06→08/10	PUNTO EVO 1.3 D Multijet		03/09→
IDEA 1.3 D Multijet			10/05→	STRADA 1.3 D Multijet		05/06→

87-425600-00 STD
87-425606-00 0.40mm
87-425608-00 0.60mm

A 40.43
B- 12.41
BØ 38.00
C 0.91
C 0.91
D 62.43
 23x55
 (06933)

AK KK RT TP

08-425600-00 STD
08-425606-00 0.40mm
08-425608-00 0.60mm

2.00 CK P
 1.50 NT
 2.00 CR P

14-022060-00 D **B 72.50 C 142.00 D 74.00 E 5.00**

69.60						9
199 B1.000 (Euro 5)	4cyl.	1248cc	64-70kW (87-95PS)	Diesel	Turbo Intercooled	TD23574
263 A2.000	4cyl.	1248cc	66kW (90PS)	Diesel	Turbo Intercooled	TD24796
500 1.3 D Multijet			12/09→	PANDA 1.3 D Multijet		04/15→
500 C 1.3 D Multijet			09/09→	PUNTO 1.3 D Multijet		03/09→
DOBLO 1.3 D Multijet			02/10→	PUNTO EVO 1.3 D Multijet		03/09→02/12
FIORINO 1.3 D Multijet			07/09→	QUBO 1.3 D Multijet		07/10→
FIORINO 1.3 JTD Multijet			01/11→	STRADA 1.3 D Multijet		10/10→
IDEA 1.3 D Multijet			05/08→12/12	TIPO 1.3 D		10/15→10/20
LINEA 1.3 D Multijet			09/09→			

87-435700-00 STD
87-435706-00 0.40mm

A 40.43
B- 12.70
BØ 37.00
C 1.15
C 0.90
D 62.43
 23x57

AK KK RT

08-435700-00 STD
08-435706-00 0.40mm

1.50 GDC P
 1.50 P
 2.00 CR P

GDC **LKZ-Ring**

With Stop/Start Technology
 Für Fahrzeuge mit StartStop Funktion
 Pour véhicules équipé du start & stop
 Para vehiculos con función start-stop
 Per veicoli con la funzione Start-Stop



69.60 **10**



312 A8.000 (Euro 6)	4cyl.	1248cc	59kW (80PS)	Diesel	Turbo Intercooled	TD29720
312 B2.000 (Euro 6)	4cyl.	1248cc	59kW (80PS)	Diesel	Turbo	TD32630
PANDA 1.3 D Multijet			06/14 →	PANDA VAN 1.3 D Multijet		12/15 →



87-450500-00 STD ①

A 40.43
B- 12.70
BØ 37.00
C 0.55
C 0.30
D 62.43
 23x56
 (06935-354)
AK KK RT TP



08-450500-00 STD ②

1.50  GDC P
 1.50  P
 2.00  CR P

GDC  **LKZ-Ring** 

ECOTOUGH

① Bowl capacity 15.840cm³ ① Volumen der Kolbenmulde 15.840cm³ ① Volume de la cavité du piston 15.840cm³ ① Vol. cavidad pistón 15.840cm³ ① Volume camera pistone 15.840cm³
 ② Euro 6

70.00 **11**



110 D.000	2cyl.	499cc	13kW (18PS)	Petrol	TD23456
500 0.5			01/60 → 12/74		

87-528300-00 STD
87-528306-00 0.40mm

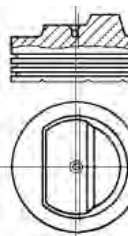
A 39.80
B+ 4.00
D 72.30
 20x58



08-528300-00 STD
08-528306-00 0.40mm

2.00  CR P
 2.00  P
 3.50  P

① **B** 75.00 **C** 130.00 **E** 90.00

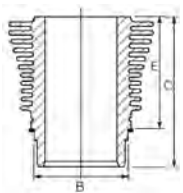

88-528300-00
 87-528300-00

① Liner available in Kit Set only ① Zylindertaufbuchse nur in Assemblies verfügbar ① Chemise disponible en kit seulement ① Camisas disponible en conjuntos solamente. ① Cilindro disponibile solo in kit motore

70.00 **12**

GSE-T3 (Euro 6 FireFly)	3cyl.	999cc	88kW (120PS)	Petrol	Turbo Intercooled	TD35499
GSE-T4 (Euro 6 FireFly)	4cyl.	1332cc	118-132kW (160-179PS)	Petrol	Turbo Intercooled	TD35500
500X 1.3			09/18 →	UNO 1.0 EVO		09/16 →
ARGO 1.0			09/16 →			

87-450900-00 STD ①

A 28.00
B- 3.40
BØ 44.97
C 2.02
D 45.50
 18x46
 (070N310AD01)
HA KK TP



1.20  NT ③
 1.20  P
 2.00  NT ③

ECOTOUGH

① Bowl capacity 4.190cm³ ① Volumen der Kolbenmulde 4.190cm³ ① Volume de la cavité du piston 4.190cm³ ① Vol. cavidad pistón 4.190cm³ ① Volume camera pistone 4.190cm³
 ② CarboGlide & DuroGlide technology ② CarboGlide & DuroGlide technology ② CarboGlide & DuroGlide technology ② CarboGlide & DuroGlide technology ② CarboGlide & DuroGlide technology
 ③ Steel ③ Stahl ③ Acier ③ Acero ③ Acciaio



70.00 **13**

156 A2.000 (Fire)	4cyl.	999cc	31-37kW (42-50PS)	Petrol	TD16230
156 A2.100 (Fire)	4cyl.	999cc	32-33kW (44-45PS)	Petrol	TD4387
156 A3.000 (Fire)	4cyl.	999cc	37kW (50PS)	Petrol	TD16209

PANDA 1000	01/85→12/92	UNO 45 1.0	06/86→12/93
UNO 1.0	06/89→02/92	UNO 45 i.e. 1.0	10/84→10/95

87-154200-00 STD
87-154206-00 0.40mm
87-154208-00 0.60mm

08-154200-00 STD
08-154206-00 0.40mm
08-154208-00 0.60mm

14-010991-00 D **B 73.02 C 116.00**

A 33.90
B- 0.50
BØ 55.00
D 57.40
 18x53



1.50 CR P
 1.50 P
 3.00 CR 1

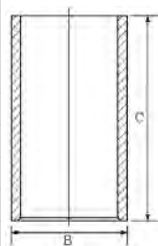

1 Steel 1 Stahl 1 Acier 1 Acero 1 Acciaio

70.00 **14**

156 A2.050 (Fire)	4cyl.	999cc	33kW (45PS)	Petrol	TD22228
156 A2.0157 (Fire)	4cyl.	999cc	33kW (45PS)	Petrol	TD22227

UNO 45 1.0	07/85→03/94
------------	-------------

14-010991-00 D **B 73.02 C 116.00**

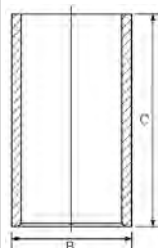

70.00 **15**

156 A2.246 (Fire)	4cyl.	999cc	33-40kW (45-54PS)	Petrol	TD994
156 C.046 (Fire)	4cyl.	1108cc	37-43kW (50-58PS)	Petrol	TD4389

FIORINO 1.0 iE	11/92→04/96	PANDA 1100	05/91→07/04
PANDA 1.1	05/91→03/95	UNO 1.0 iE	05/98→08/00
PANDA 1000	05/86→12/94	UNO 1.0 Mille Fire	06/01→12/03
PANDA 1000 i.e	08/92→02/04	UNO 45 i.e. 1.0	10/84→10/95
PANDA 1000 i.e. Cat	10/87→08/98	UNO 50 1.1	01/90→12/93

87-154200-10 STD
87-154206-10 0.40mm

08-154200-00 STD
08-154206-00 0.40mm
08-154208-00 0.60mm

14-010991-00 D **B 73.02 C 116.00**

A 33.90
B- 1.50
D 57.40
 18x53



1.50 CR P
 1.50 P
 3.00 CR 1

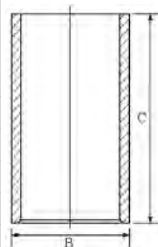

1 Steel 1 Stahl 1 Acier 1 Acero 1 Acciaio

70.00 **16**

160 A3.000 (Fire)	4cyl.	1108cc	36-43kW (56-58PS)	Petrol	TD10189
M204 A.A.11 (Fire)	4cyl.	1108cc	40kW (54PS)	Petrol	MP9125





PANDA 1100	01/93→	UNO 1.1	04/86→06/06
TIPO 1.1	01/88→10/91	UNO 60 1.1	04/89→

87-154200-30 STD
87-154206-30 0.40mm
87-154208-30 0.60mm

08-154200-00 STD
08-154206-00 0.40mm
08-154208-00 0.60mm

14-010991-00 D B 73.02 C 116.00

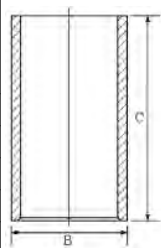

A 30.00
B- 1.80
D 54.00
18x53



1.50 CR P
1.50 P
3.00 CR 1

Steel Stahl Acier Acero Acciaio

70.00 **17**

176 A6.000 (Fire)	4cyl.	1108cc	40kW (54PS)	Petrol	TD1036
176 B2.000 (Euro 2 Fire)	4cyl.	1108cc	40kW (54PS)	Petrol	TD4396
187 A1.000 (Euro 3 Fire)	4cyl.	1108cc	40-42kW (54-57PS)	Petrol	TD17847

CINQUECENTO 1.1	10/94→01/98	PANDA 1100	02/95→07/04
CINQUECENTO VAN 1.1 iE	10/94→02/98	PUNTO 1.1	04/96→02/00
PALIO 1.1	06/06→11/11	PUNTO 55 1.1	09/93→09/99
PANDA 1.1	09/00→	SEICENTO / 600 1.1	01/98→01/10

87-142300-00 STD
87-142306-00 0.40mm
87-142308-00 0.60mm

08-142300-00 STD
08-142306-00 0.40mm
08-142308-00 0.60mm

14-010991-00 D B 73.02 C 116.00

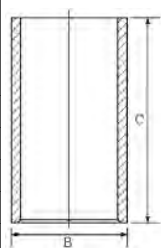

A 30.00
B- 1.80
BØ 60.00
D 50.00
18x53



1.20 CR P
1.20 P
2.50 P

70.80 **18**

176 A7.000 (Fire)	4cyl.	1242cc	43-44kW (58-60PS)	Petrol	TD1037
-------------------	-------	--------	-------------------	--------	--------

PUNTO 60 1.2	01/94→06/00
--------------	-------------

87-138400-10 STD
87-138406-10 0.40mm
87-138408-10 0.60mm

08-138400-00 STD
08-138406-00 0.40mm
08-138408-00 0.60mm

A 28.00
B- 2.50
D 47.50
18x53



1.19 NT P
1.20 P
2.50 P

70.80 **19**

176 A8.000 (Fire)	4cyl.	1242cc	54kW (73PS)	Petrol	TD1038
176 B1.000	4cyl.	1242cc	44kW (60PS)	Petrol	TD1032
176 B4.000 (Fire)	4cyl.	1242cc	44kW (60PS)	Petrol	TD1076





178 B5.000 (Euro 3 Fire)	4cyl.	1242cc	50-55kW (68-75PS)	Petrol	TD10188
178 E2.000 (Fire)	4cyl.	1242cc	50-54kW (68-73PS)	Petrol	TD16737
188 A4.000 (Euro 3 Fire)	4cyl.	1242cc	38-44kW (52-60PS)	Petrol	TD12790
223 A5.000 (Euro 3 Fire)	4cyl.	1242cc	48kW (65PS)	Petrol	TD15828
DOBLO 1.2			03/01→	PUNTO 1.2 60	09/99→12/10
FIORINO 1.2			01/04→	PUNTO 60 1.2	09/93→06/00
PALIO 1.2			04/96→	PUNTO 75 1.2	10/93→09/99
PANDA 1.2			09/03→	SIENA 1.3	09/98→12/12
PANDA 1.2 LPG			04/09→	STRADA 1.2	06/99→
PUNTO 1.2			08/01→03/12	UNO 1.2	08/00→08/09

87-138400-40 STD
87-138406-40 0.40mm

- A** 28.00
 - B-** 1.80
 - C** 1.10
 - D** 48.00
- 18x53



08-138400-00 STD
08-138406-00 0.40mm
08-138408-00 0.60mm

- 1.19 NT P
- 1.20 P
- 2.50 P

14-021080-00 D **B 73.80 C 128.00 D 75.00 E 5.00**

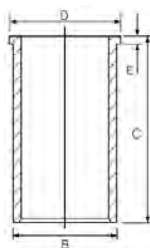

70.80

20

176 B9.000 (Fire)	4cyl.	1242cc	63kW (86PS)	Petrol	TD9727
182 B2.000 (Fire)	4cyl.	1242cc	60-64kW (82-87PS)	Petrol	TD11807
BRAVA 1.2 16V 80			12/98→12/02	PUNTO 1.2 16V	04/97→09/99
BRAVO I 1.2 16V 80			12/98→10/00	PUNTO 85 16V 1.2	04/97→06/00
MAREA 1.2 16V			10/98→05/02		

87-138400-00 STD
87-138406-00 0.40mm

- A** 28.05
 - B-** 5.70
 - C** 1.50
 - D** 48.00
- 18x53



08-138400-00 STD
08-138406-00 0.40mm
08-138408-00 0.60mm

- 1.19 NT P
- 1.20 P
- 2.50 P

70.80

21

178 E8.011 (Fire)	4cyl.	1242cc	48-50kW (65-68PS)	Petrol	TD25005
178 E9.011 (Fire)	4cyl.	1242cc	50-60kW (68-82PS)	Petrol	TD24630
PALIO 1.3			03/04→	UNO 1.3	11/05→04/10
SIENA 1.3			03/04→12/09	UNO CARGO 1.2	11/09→08/13
UNO 1.2			01/04→04/10		

14-021080-00 D **B 73.80 C 128.00 D 75.00 E 5.00**

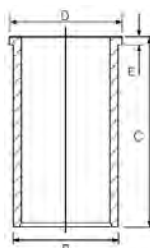



70.80 **22**

188 A5.000 (Euro 3 Fire)	4cyl.	1242cc	57-60kW (78-82PS)	Petrol	TD12791
BRAVA 1.2 16V 80			10/00→10/01	PUNTO 1.2 16V 80	09/99→04/06
BRAVO I 1.2 16V 80			10/00→10/01	SIENA 1.2	06/01→10/07
IDEA 1.2 16V			01/04→	SIENA 1.3	09/01→12/09
PALIO 1.2			09/01→10/04	STILO 1.2 16V	02/02→11/06
PALIO 1.3			03/00→02/03		

87-138400-30 STD
87-138406-30 0.40mm

A 28.00
B- 5.10
D 48.00
18x49

08-138400-00 STD
08-138406-00 0.40mm
08-138408-00 0.60mm

1.19 NT P
1.20 P
2.50 P

14-021080-00 D **B 73.80 C 128.00 D 75.00 E 5.00**

72.00 **23**

178 F3.011	4cyl.	1368cc	57-63kW (78-86PS)	Petrol	TD24633
350 A1.000 (Euro 4/5)	4cyl.	1368cc	51-63kW (69-86PS)	Petrol	TD20248
DOBLO 1.4			10/05→	PANDA 1.4	10/09→
FIORINO 1.4			06/08→	PUNTO 1.4	03/09→
FIORINO 1.4 CNG			06/08→	PUNTO 1.4 LPG	03/12→
GRANDE PUNTO 1.4			06/05→	PUNTO EVO 1.4	03/09→02/12
GRANDE PUNTO 1.4 LPG			12/08→	PUNTO EVO 1.4 LPG	06/09→02/12
IDEA 1.4			10/05→	QUBO 1.4	10/09→
IDEA 1.4 LPG			03/09→	SIENA 1.4	06/04→12/09
LINEA 1.4			06/07→	SIENA 1.4 8V	04/06→12/10
PALIO 1.4			10/02→	STRADA 1.4	01/06→

87-436800-00 STD
87-436806-00 0.40mm

A 26.00
B- 4.75
C 2.05
D 49.00
18x49

08-436800-00 STD
08-436806-00 0.40mm

1.00 NT
1.20 P
2.00 CR P

LKZ-Ring

Steel Stahl Acier Acero Acciaio

72.00 **24**

192 B2.000	4cyl.	1368cc	66kW (90PS)	Petrol	TD18571
843 A1.000 (Euro 4 Fire)	4cyl.	1368cc	65-71kW (88-97PS)	Petrol	TD17978
500L 1.4			09/12→	IDEA 1.4 16V	01/04→
BRAVO II 1.4			04/07→12/14	PUNTO 1.4	09/03→03/12
BRAVO II 1.4 LPG			12/08→12/14	STILO 1.4	01/04→08/08
DOBLO 1.4			02/10→	STILO 1.4 16V	10/03→08/08
IDEA 1.4			12/03→	TIPO 1.4	10/15→10/20





87-433200-00 STD ①
87-433206-00 0.40mm ①

08-433200-00 STD
08-433206-00 0.40mm

A 26.00
B- 7.80
BØ 57.60
C 1.40
C 2.20
D 46.00
 18x49



1.00  NT②
 1.20  P
 2.00  P

① 66.00kW→
 ② Steel

② Stahl

② Acier

② Acero

② Acciaio

73.50

25

126 A.000 2cyl. **594cc** **17kW (23PS)** **Petrol** **TD880**

126 600 09/72→06/77

87-528400-00 STD
87-528406-00 0.40mm
87-528408-00 0.60mm

08-528400-00 STD
08-528406-00 0.40mm
08-528408-00 0.60mm

A 40.00
D 79.50
 20x61

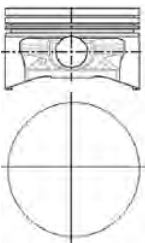

1.50  CR P
 2.00  P
 3.94  P

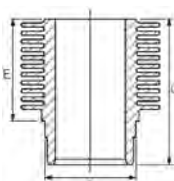

① **B** 81.50 **C** 130.40 **E** 79.90

88-528400-00
 87-528400-00

① Liner available in Kit Set only

① Zylinderlaufbuchse nur in Assemblies verfügbar

① Chemise disponible en kit seulement

① Camisas disponible en conjuntos solamente.

① Cilindro disponibile solo in kit motore

75.00

26

9HM (DV6UC) 4cyl. **1560cc** **66kW (90PS)** **Diesel Turbo Intercooled** **TD32529**

SCUDO 1.6 D Multijet 02/11→03/16

87-433600-00 STD
87-433607-00 0.50mm

08-433600-00 STD
08-433607-00 0.50mm

A 41.75
B- 13.85
BØ 45.00
D 65.20
 26x61



2.50  CK P
 1.95  P
 2.00  CR P

AK KK RT TP



75.00

27

9HU 4cyl. **1560cc** **66kW (90PS)** **Diesel Turbo Intercooled** **TD24776**

SCUDO 1.6 D Multijet 01/07→03/16





87-424000-00 STD
87-424008-00 0.60mm

A 41.70
B- 13.25
BØ 41.80
C 1.20
D 65.30
E 26x61



AK KK RT TP

08-424000-00 STD
08-424007-00 0.50mm
08-424008-00 0.60mm

3.00 CK P
1.95 P
2.50 CR P



14-020900-00 D B 78.00 C 142.00 D 79.50 F 5.00

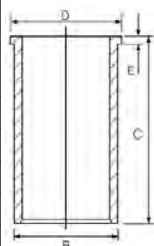

76.00

28

127 A5.000	4cyl.	1301cc	33-38kW (45-52PS)	Diesel	TD4346
146 B1.000	4cyl.	1301cc	33kW (45PS)	Diesel	TD948
156 A5.000	4cyl.	1301cc	27kW (37PS)	Diesel	TD999
127 1.3 D		06/81→05/96	PANDA 1300 D		04/86→12/92
127 1.3 Diesel		04/81→12/86	PANDA D		05/86→04/91
147 1.3 D		10/80→10/95	PENNY 1.3 D		04/86→12/88
FIORINO 1.3 D		01/82→01/88	UNO 1.3 Super Diesel		06/83→03/92
FIORINO Pick up 1.3 D		05/84→12/88			

14-012470-00 D B 79.00 C 139.00

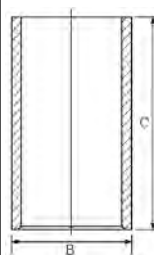

77.00

29

126 A1.000	2cyl.	652cc	17kW (23PS)	Petrol	TD4343
126 A1.048	2cyl.	652cc	17-20kW (23-27PS)	Petrol	TD881
126 650		07/77→09/00			

87-785500-00 STD
87-785506-00 0.40mm
87-785508-00 0.60mm

A 40.00
D 79.50
E 20x61



08-785500-00 STD
08-785506-00 0.40mm
08-785508-00 0.60mm

1.50 CR P
2.00 P
3.94 CR 1

14-012470-00 2 B 83.00 C 130.40 E 79.90

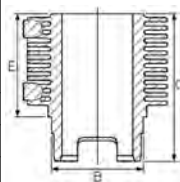

88-785500-00
87-785500-00

1 Steel
2 Liner available in Kit Set only

1 Stahl
2 Zylinderlaufbuchse nur in Assemblies verfügbar

1 Acier
2 Chemise disponible en kit seulement

1 Acero
2 Camisas disponible en conjuntos solamente.

1 Acciaio
2 Cilindro disponibile solo in kit motore

79.50

30

198 A3.000	4cyl.	1598cc	77kW (105PS)	Diesel	Turbo Intercooled	TD24568
199 B5.000	4cyl.	1598cc	77kW (105PS)	Diesel	Turbo Intercooled	TD27727
263 A3.000	4cyl.	1598cc	74kW (101PS)	Diesel	Turbo	TD24768
263 A8.000	4cyl.	1598cc	77kW (105PS)	Diesel	Turbo	TD33008





350 A3.000	4cyl.	1598cc	85kW (116PS)	Diesel	Turbo Intercooled	TD24973
552 60 384	4cyl.	1598cc	84-88kW (114-120PS)	Diesel	Turbo Intercooled	TD31789
844 A3.000	4cyl.	1598cc	77kW (105PS)	Diesel	Turbo Intercooled	TD31284
940 C1.000	4cyl.	1598cc	88kW (120PS)	Diesel	Turbo Intercooled	TD31014
955 A4.000	4cyl.	1598cc	85kW (115PS)	Diesel	Turbo Intercooled	TD25735
500X 1.6 D Multijet			09/14→	DOBLO 1.6 D Multijet		01/10→
500L 1.6 D Multijet			09/12→	LINEA 1.6 D Multijet		06/09→
BRAVO 1.6 JTD Multijet			03/08→12/14	TIPO 1.6 D		10/15→10/20
BRAVO II 1.6 D Multijet			09/07→12/14			

87-429300-10 STD ① ②
 87-429306-10 0.40mm ① ②

08-429300-10 STD ③
 08-429306-10 0.40mm ③

A 43.95
 B- 13.80
 BØ 41.70
 C 1.01
 C 1.03
 D 68.95
 26x63



1.50 GDC P
 1.50 P
 2.00 CR P



(792A-765)

AK RT TP

- ① Pistons to be replaced in Engine Sets only
- ② Bowl capacity 19.65cm³
- ③ Euro 6
- ① Kolben nur in Motorsätzen zu ersetzen
- ② Volumen der Kolbenmulde 19.65cm³
- ③ Piston à remplacer dans jeu moteur
- ② Volume de la cavité du piston 19.65cm³
- ① Pistones de repuesto para juegos de motores solamente
- ② Vol. cavidad pistón 19.65cm³
- ① Il pistone può essere rimpiazzato solamente completo
- ② Volume camera pistone 19.65cm³

80.00

31

124 B.000	4cyl.	1438cc	51kW (69PS)	Petrol	TD18853
125 A.000	4cyl.	1608cc	66kW (90PS)	Petrol	TD878
125 B.000	4cyl.	1608cc	74-82kW (100-112PS)	Petrol	TD879
126 A2.000	2cyl.	704cc	19kW (26PS)	Petrol	TD4342
126 A2.048	2cyl.	704cc	19kW (26PS)	Petrol	TD4344
128 A.000	4cyl.	1116cc	33-48kW (45-65PS)	Petrol	TD888
128 A.048	4cyl.	1116cc	33kW (45PS)	Petrol	TD5378
128 A 064	4cyl.	1116cc	40-44kW (54-60PS)	Petrol	TD23118
128 AC5.000	4cyl.	1116cc	48kW (65PS)	Petrol	TD891
132 BB OA O	4cyl.	1592cc	71-72kW (97-98PS)	Petrol	TD6825
138 AE OA.0	4cyl.	1116cc	44kW (60PS)	Petrol	TD23461
138 B.000	4cyl.	1116cc	40-44kW (55-60PS)	Petrol	TD923
170 A.000	2cyl.	704cc	23kW (31PS)	Petrol	TD1028
170 A.046	2cyl.	704cc	22kW (30PS)	Petrol	TD15809
124 1.4			09/67→05/71	132 1.6	04/72→01/76
124 1600			01/69→12/74	CINQUECENTO 0.7	12/91→01/96
125 1.6			07/67→03/74	CINQUECENTO 0.7 i	07/94→01/98
126 700			09/87→06/96	RITMO 1.1	08/80→08/88
128 1.1			03/69→12/84	UNO 55 1.1	01/83→08/89

14-028710-00 D

B 86.53 C 125.10 D 95.00 E 7.80

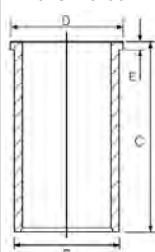



80.00 **32**

R9M 408	4cyl.	1598cc	66-85kW (90-116PS)	Diesel	Turbo Intercooled	TD33447
R9M 413	4cyl.	1598cc	70-89kW (95-121PS)	Diesel	Turbo Intercooled	TD33830
R9M 450	4cyl.	1598cc	88-103kW (120-140PS)	Diesel	Turbo Intercooled	TD33829
R9M 452	4cyl.	1598cc	92-107kW (125-145PS)	Diesel	Turbo Intercooled	TD33831

TALENTO 1.6 D 06/16→

87-424900-00 STD
87-424907-00 0.50mm

- A 46.00
- B- 12.35
- BØ 46.50
- C 0.30
- D 70.50
- 30x60



AK KK RT TP

08-424900-00 STD
08-424907-00 0.50mm

- 2.00 CK P
- 1.75 P
- 2.00 CR P

80.50 **33**

182 B6.000 (Euro 3)	4cyl.	1596cc	68-100kW (92-136PS)	Petrol	TD16166
BRAVA 1.6 16V			01/99→12/02	MULTIPLA VAN	10/01→06/10
BRAVO I 1.6			09/00→10/01	MULTIPLA VAN 1.6	09/00→06/10
DOBLO 1.6			09/02→	PALIO 1.6	06/96→
DOBLO 1.6 16V			10/01→	PALIO 1.6 16V	02/01→01/12
MAREA 1.6			09/00→12/07	SIENA 1.6	11/00→12/12
MULTIPLA 1.6			09/00→06/10	STILO 1.6	04/05→08/08
MULTIPLA 1.6 16V			10/01→06/10	STILO 1.6 16V	10/01→08/08
MULTIPLA 1.6 16V GPL			10/01→06/10		

87-124800-00 STD
87-124806-00 0.40mm

- A 28.65
- B- 1.20
- BØ 62.00
- C 2.49
- C 1.98
- D 50.65
- 21x56



08-124800-00 STD
08-124806-00 0.40mm
08-124808-00 0.60mm

- 1.20 NT P
- 1.20 P
- 2.00 P

82.00 **34**

182 A2.000 (Euro 2)	4cyl.	1747cc	83kW (113PS)	Petrol	TD4398
183 A1.000 (Euro 2)	4cyl.	1747cc	92-97kW (125-132PS)	Petrol	TD4405
BARCETTA 1.8 16V			04/95→05/05	COUPE 1.8 16V	03/96→08/00
BRAVA 1.8 GT 16V			10/95→08/01	MAREA 1.8 115 16V	09/96→05/02
BRAVO I 1.8 GT			10/95→10/01	PUNTO 1.8 130 HGT	09/99→03/12

87-118006-00 0.40mm

- A 36.15
- B- 0.50
- D 60.15
- 20x52



08-118000-00 STD
08-118006-00 0.40mm
08-118008-00 0.60mm

- 1.19 NT
- 1.20 P
- 2.00 P



82.00						35
182 A7.000	4cyl.	1910cc	74kW (100PS)	Diesel	Turbo Intercooled	TD4403
182 A8.000	4cyl.	1910cc	55kW (75PS)	Diesel	Turbo Intercooled	TD4404
182 B4.000 (Euro 2)	4cyl.	1910cc	77-79kW (105-107PS)	Diesel	Turbo Intercooled	TD11168
185 A2.000	5cyl.	2387cc	91kW (125PS)	Diesel	Turbo Intercooled	TD4406
185 A6.000 (Euro 2)	5cyl.	2387cc	96kW (130PS)	Diesel	Turbo Intercooled	TD18145
186 A6.000 (Euro 3)	4cyl.	1910cc	81kW (110PS)	Diesel	Turbo Intercooled	TD15831
188 A2.000 (Euro 3)	4cyl.	1910cc	59kW (80PS)	Diesel	Turbo Intercooled	TD12788
188 A7.000 (Euro 3)	4cyl.	1910cc	63kW (86PS)	Diesel	Turbo Intercooled	TD16409
192 A3.000 (Euro 3)	4cyl.	1910cc	59kW (80PS)	Diesel	Turbo Intercooled	TD16397
839 A5.000 (Euro 2)	5cyl.	2387cc	96-99kW (131-135PS)	Diesel	Turbo Intercooled	TD14408
BRAVA 1.9 JTD 105			12/98→10/01	MAREA 2.4 JTD 130		04/99→05/02
BRAVA 1.9 TD 75 S			03/96→10/01	MAREA 2.4 TD 125		09/96→04/99
BRAVA 1.9 TD 100 S			03/96→10/01	MULTIPLA 1.9 JTD 105		04/99→06/10
BRAVO I 1.9 JTD 105			12/98→10/01	MULTIPLA 1.9 JTD 110		03/01→07/02
BRAVO I 1.9 TD 75 S			03/96→10/01	MULTIPLA VAN 1.9 JTD		04/99→03/02
BRAVO I 1.9 TD 100 S			03/96→10/01	PALIO 1.9 JTD		09/01→
MAREA 1.9 JTD			01/01→12/07	PUNTO 1.9 JTD		02/00→03/12
MAREA 1.9 JTD 105			12/98→12/02	PUNTO 1.9 JTD 80		09/99→03/12
MAREA 1.9 JTD 110			09/00→08/02	STILO 1.9 JTD		10/01→08/08
MAREA 1.9 TD 75			09/96→05/02	STRADA 1.9 JTD		04/03→
MAREA 1.9 TD 100			05/96→06/03			

14-021051-00 D B 85.57 C 155.00 D 88.53 E 4.00
 14-028960-00 D B 85.00 C 155.00 D 88.00 E 4.50

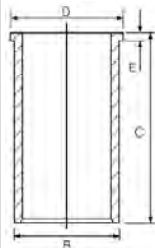

82.00						36
182 B9.000 (Euro 3)	4cyl.	1910cc	74-79kW (100-107PS)	Diesel	Turbo Intercooled	TD16399
186 A8.000	4cyl.	1910cc	85kW (115PS)	Diesel	Turbo Intercooled	TD18309
186 A9.000	4cyl.	1910cc	88kW (120PS)	Diesel	Turbo Intercooled	TD19306
188 B2.000	4cyl.	1910cc	74kW (101PS)	Diesel	Turbo Intercooled	TD18291
192 A1.000	4cyl.	1910cc	85kW (115PS)	Diesel	Turbo Intercooled	TD16398
192 A8.000	4cyl.	1910cc	88kW (120PS)	Diesel	Turbo Intercooled	TD20238
199 A5.000	4cyl.	1910cc	96kW (131PS)	Diesel	Turbo Intercooled	TD20762
223 A7.000	4cyl.	1910cc	77kW (105PS)	Diesel	Turbo Intercooled	TD18318
937 A7.000	4cyl.	1910cc	85kW (115PS)	Diesel	Turbo Intercooled	TD19307
939 A1.000	4cyl.	1910cc	88kW (120PS)	Diesel	Turbo Intercooled	TD18448
D19AA	4cyl.	1910cc	88kW (120PS)	Diesel	Turbo Intercooled	TD20930
BRAVA 1.9 JTD			09/00→10/01	IDEA MJTD		10/04→12/10
BRAVO I 1.9 JTD			09/00→10/01	MAREA 1.9 JTD		01/01→12/07
BRAVO II 1.9 D Multijet			11/06→12/14	MAREA 1.9 TD 100		09/96→06/03
CROMA 1.9 D Multijet			06/05→12/11	MULTIPLA 1.9 JTD		04/02→06/10
CROMA 1.9 MJTD			04/06→12/11	MULTIPLA 1.9 JTD 115		07/02→06/10
DOBLO 1.9 D Multijet			10/05→	MULTIPLA VAN 1.9 JTD		04/02→06/10
DOBLO 1.9 JTD			10/01→	PUNTO 1.9 JTD		06/03→03/12
DOBLO 1.9 JTD Multijet			12/06→	SEDICI 1.9 D Multijet		06/06→10/11
GRANDE PUNTO 1.9 D Multijet			10/05→	STILO 1.9 D Multijet		09/05→08/08
IDEA 1.9 JTD			01/04→	STILO 1.9 JTD		10/01→08/08





87-124000-30 STD
87-124008-30 0.60mm

A 46.50
B- 17.45
BØ 37.55
C 0.65
D 72.50
 26x61



NB RT

08-124000-00 STD
08-124008-00 0.60mm

2.00  CK P
2.00  P
2.00  CR P

14-021051-00 D B 85.57 C 155.00 D 88.53 E 4.00
14-028960-00 D B 85.00 C 155.00 D 88.00 E 4.50

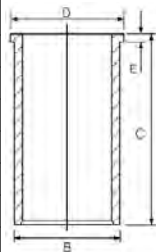

82.00

37

188 A3.000	4cyl.	1910cc	44kW (60PS)	Diesel	TD12789
223 A6.000 (Euro 3)	4cyl.	1910cc	46-48kW (63-65PS)	Diesel	TD15829
DOBLO 1.9 D		03/01→		PUNTO 1.9 DS 60	09/99→03/12
PALIO 1.9 D		03/01→		SIENA 1.9 D	01/04→12/08
PUNTO 1.9 D 60		02/00→10/09		STRADA 1.9 D	12/00→

87-124000-00 STD
87-124008-00 0.60mm

A 44.45
B- 2.60
D 70.40
 26x65



RT

08-124000-00 STD
08-124008-00 0.60mm

2.00  CK P
2.00  P
2.00  CR P

14-021051-00 D B 85.57 C 155.00 D 88.53 E 4.00
14-028960-00 D B 85.00 C 155.00 D 88.00 E 4.50

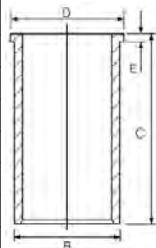

82.00

38

192 A5.000	4cyl.	1910cc	103kW (140PS)	Diesel	Turbo Intercooled	TD17980
192 B1.000	4cyl.	1910cc	100kW (136PS)	Diesel	Turbo Intercooled	TD18944
937 A4.000	4cyl.	1910cc	93kW (126PS)	Diesel	Turbo Intercooled	TD18943
937 A5.000	4cyl.	1910cc	110kW (150PS)	Diesel	Turbo Intercooled	TD18929
939 A2.000	4cyl.	1910cc	110kW (150PS)	Diesel	Turbo Intercooled	TD18449
939 A3.000	5cyl.	2387cc	147kW (200PS)	Diesel	Turbo Intercooled	TD18450
BRAVO II 1.9 D Multijet		04/07→12/14		STILO 1.9 D Multijet		09/05→08/08
CROMA 1.9 D Multijet		06/05→12/11		STILO 1.9 JTD		09/03→08/08
CROMA 2.4 D Multijet		06/05→				

87-146100-00 STD
87-146108-00 0.60mm

A 46.50
B- 15.40
BØ 41.50
C 1.03
D 72.50
 26x61
(08256-102)

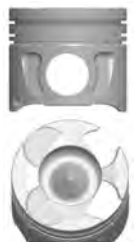

AK KK NB RT TP

08-146100-00 STD
08-146106-00 0.40mm
08-146108-00 0.60mm

2.00  CK P
2.00  P
2.00  CK P

14-021051-00 D B 85.57 C 155.00 D 88.53 E 4.00
14-028960-00 D B 85.00 C 155.00 D 88.00 E 4.50

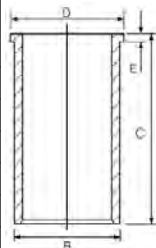

82.20

39

WJY (DW8)	4cyl.	1868cc	51kW (69PS)	Diesel	TD21266
WJY (DW8B)	4cyl.	1868cc	51kW (69PS)	Diesel	TD22240









WJZ (DW8)	4cyl.	1868cc	51-52kW (69-71PS)	Diesel	TD16300
SCUDO 1.9 D		04/98→12/06			

87-104000-00 STD
87-104008-00 0.60mm

A 46.80
B- 1.30
D 78.00
 25x65



08-104000-00 STD
08-104008-00 0.60mm

2.00  CK P
 2.00  P
 3.00  CR P

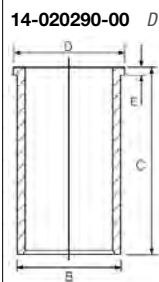

B 85.00 **C** 154.00 **D** 87.00 **E** 5.00

88-104000-00
 87-104000-00 +
 14-020290-00

82.60 **40**

138 C.000	4cyl.	1698cc	44kW (60PS)	Diesel	TD925
146 B2.000	4cyl.	1698cc	42-44kW (57-60PS)	Diesel	TD949
149 B3.000	4cyl.	1698cc	44kW (60PS)	Diesel	TD967
149 B4.000	4cyl.	1698cc	42-45kW (57-61PS)	Diesel	TD968
149 B4.046	4cyl.	1698cc	42-44kW (57-60PS)	Diesel	TD969
176 B3.000	4cyl.	1698cc	42kW (57PS)	Diesel	TD9477
DUNA 1.7 DS			01/87→12/91	PENNY 1.7 D	01/86→12/90
ELBA 1.7 D			04/89→10/97	PUNTO 1.7 D	04/94→02/00
FIORINO 1.7			01/88→10/92	REGATA 60 Diesel 1.7	01/84→12/89
FIORINO 1.7 D			01/88→10/99	RITMO 1.7 Diesel	05/85→12/87
FIORINO 60 1.7 D			05/88→05/00	TIPO 1.7 D	01/88→10/95
FIORINO Pick up 1.7 D			05/88→10/99	UNO 1.7 D	02/88→08/00
PALIO 1.7 D			04/96→09/02	UNO 60 Diesel 1.7	07/86→12/93

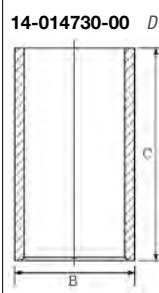

B 86.09 **C** 154.00

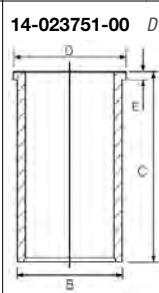

B 87.00 **C** 154.00 **D** 89.00 **E** 4.55

82.60 **41**

146 D7.000	4cyl.	1698cc	46kW (63PS)	Diesel	Turbo	TD9472
176 A5.000	4cyl.	1698cc	52-59kW (71-80PS)	Diesel	Turbo	TD1035
176 B7.000	4cyl.	1698cc	46-47kW (63-64PS)	Diesel	Turbo	TD5493
FIORINO 1.7 TD			11/96→05/00	PALIO 1.7 TD		02/97→
FIORINO 65 1.7 TD			01/97→05/01	PUNTO 1.7 TD		01/94→02/00





FIORINO Pick up 1.7 TD 01/97→05/01

87-783800-30 STD
87-783808-30 0.60mm

08-783800-00 STD
08-783808-00 0.60mm

A 42.40
B+ 2.50
D 76.00
 26x69

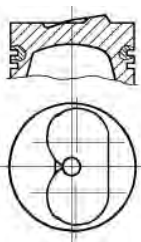

3.00  MOL P
 2.00  P
 3.00  CR P

HA RT

82.60 **42**

149 A1.000	4cyl.	1929cc	48kW (65PS)	Diesel	TD4378
149 B1.000	4cyl.	1929cc	51-52kW (70-71PS)	Diesel	TD963
149 B5.046	4cyl.	1929cc	44kW (60PS)	Diesel	TD9602
154 B.000	4cyl.	1929cc	68kW (92PS)	Diesel Turbo Intercooled	TD21460
154 C6.000	4cyl.	1929cc	66-68kW (90-92PS)	Diesel Turbo Intercooled	TD9621
154 D1.000	4cyl.	1929cc	69kW (94PS)	Diesel Turbo Intercooled	TD9622
160 A7.000	4cyl.	1929cc	48kW (65PS)	Diesel	TD1023
230 A2.000	4cyl.	1929cc	51kW (70PS)	Diesel	TD862
831 D1.000	4cyl.	1929cc	59kW (80PS)	Diesel Turbo	TD4410

BRAVA 1.9 D	10/95→10/01	RITMO 1.9 TD	12/85→12/87
BRAVO I 1.9 D	10/95→10/01	TALENTO 1.9 D	03/89→03/94
CROMA 1900 Turbo D i.d.	08/87→12/96	TEMPRA 1.9 D	07/91→08/96
DUCATO 1.9 D	02/87→04/02	TIPO 1.9 D	07/91→08/95
REGATA 65 Diesel 1.9	04/84→07/89	UNO 1.9 D	09/89→03/94
REGATA 80 Turbo Diesel 1.9	05/86→07/89		

14-014730-00 D **B 86.09 C 154.00**

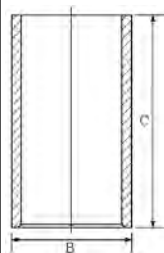

14-021311-00 D **B 86.06 C 154.00 D 89.00 E 4.50**
14-023560-00 D **B 86.00 C 154.00 D 89.00 E 4.50**
14-023751-00 D **B 87.00 C 154.00 D 89.00 E 4.55**

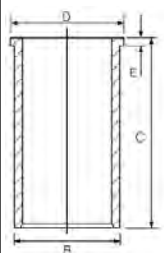





82.60 **43**

160 A6.000	4cyl.	1929cc	66-68kW (90-92PS)	Diesel Turbo Intercooled	TD4394
160 A6.046	4cyl.	1929cc	66-69kW (90-94PS)	Diesel Turbo Intercooled	TD1022



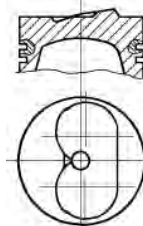

160 B6.046	4cyl.	1929cc	59kW (82PS)	Diesel	Turbo Intercooled	TD1025
160 D1.000	4cyl.	1929cc	65-66kW (88-90PS)	Diesel	Turbo Intercooled	TD1026
230 A3.000	4cyl.	1929cc	60kW (82PS)	Diesel	Turbo	TD5481
230 A4.000 (Euro 2)	4cyl.	1929cc	59kW (80PS)	Diesel	Turbo	TD4407
280 A1.000	4cyl.	1929cc	60kW (82PS)	Diesel	Turbo	TD1043
DUCATO 1.9 TD		03/89→04/02		TEMPRA 1.9 TD		04/90→08/96
DUCATO 1.9 TD CAT		08/94→04/02		TIPO 1.9 TD		04/90→04/95

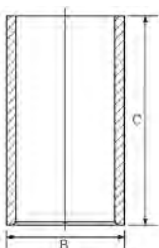
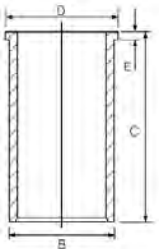
87-783800-30 STD 87-783808-30 0.60mm A 42.40 B+ 2.50 D 76.00  26x69 HA RT		08-783800-00 STD 08-783808-00 0.60mm	3.00  MOL P 2.00  P 3.00  CR P	14-014730-00 D 	B 86.09 C 154.00
		14-021311-00 D 14-023560-00 D 14-023751-00 D		B 86.06 C 154.00 D 89.00 E 4.50 B 86.00 C 154.00 D 89.00 E 4.50 B 87.00 C 154.00 D 89.00 E 4.55	

83.00						44
LFW (XU7 JP) (Euro 2)	4cyl.	1761cc	73kW (99PS)	Petrol	TD10167	
ULYSSE 1.8						05/97→08/02

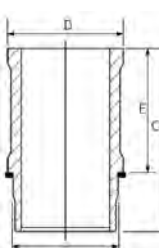
		15-634910-00 WH ① 14-634910-00 WH ②	B 88.00 C 141.00 D 97.00 E 95.13 B 88.00 C 141.00 D 97.00 E 95.13	
--	--	--	--	---

- ① Includes seals
- ② Use also 1 NB O-Ring HR566
- ① Schließt Dichtungen ein
- ② Mitverwenden: 1 NB O-Ring HR566
- ① Inclut des joints
- ② A utiliser aussi: 1 joint toriques HR566
- ① Incluye los sellos
- ② Utilizar también: 1 NB junta toricas HR566
- ① Comprende le guarnizioni
- ② Usare anche: 1 NB O-Ring HR566

83.00						45
198 A5.000	4cyl.	1956cc	121kW (165PS)	Diesel	Turbo Intercooled	TD24569
250 A1.000 (Euro 5)	4cyl.	1956cc	85kW (116PS)	Diesel	Turbo Intercooled	TD25173
263 A1.000 (Euro 5)	4cyl.	1956cc	99kW (135PS)	Diesel	Turbo Intercooled	TD24764
844 A2.000	4cyl.	1956cc	120kW (163PS)	Diesel	Turbo Intercooled	TD24593
939 B5.000	4cyl.	1956cc	100-125kW (140-170PS)	Diesel	Turbo Intercooled	TD26620
940 A5.000 (Euro 5)	4cyl.	1956cc	103-125kW (140-170PS)	Diesel	Turbo Intercooled	TD26672





BRAVO II 2.0 D Multijet	09/08→12/14	DUCATO 115 Multijet 2,0 D	06/11→
DOBLO 2.0 D Multijet	01/10→	FREEMONT 2.0 JTD	08/11→

87-436500-00 STD
87-436506-00 0.40mm

08-436500-00 STD
08-436506-00 0.40mm

A 46.63
B- 15.80
BØ 43.50
D 72.63
30x66



1.50 GDC P
1.50 P
2.00 CR P



(08344A406)
AK KK RT TP

83.00 **46**

D8B	4cyl.	1905cc	68kW (92PS)	Diesel	Turbo Intercooled	TD6828
DHX (XUD9TE)	4cyl.	1905cc	66-69kW (90-94PS)	Diesel	Turbo Intercooled	TD21264
DHX (XUD9TF/L)	4cyl.	1905cc	66-68kW (90-92PS)	Diesel	Turbo Intercooled	TD4352

DUCATO 1.9 TD	04/98→04/02	SCUDO 1.9 TD Eco	02/96→12/06
SCUDO 1.9 TD	02/96→12/06	ULYSSE 1.9 TD	02/95→08/02

87-105500-00 STD
87-105507-00 0.50mm

08-105500-00 STD
08-105507-00 0.50mm

A 46.75
B- 3.50
D 75.00
28x68



3.00 CK
2.00 NT
3.00 CR P



AK HA RT TP

14-020530-00 D B 85.60 C 153.50 D 88.50 E 3.90

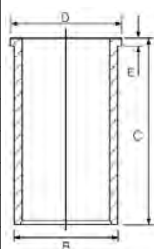

83.00 **47**

D9B (XUD9A) (XUD9)	4cyl.	1905cc	47-52kW (64-71PS)	Diesel		TD21265
D9B (XUD9A/B/L/Y) (XUD9)	4cyl.	1905cc	50-51kW (68-69PS)	Diesel		TD6827
DJY (XUD9)	4cyl.	1905cc	50-52kW (68-71PS)	Diesel		TD21267
DJY (XUD9A)	4cyl.	1905cc	50kW (68PS)	Diesel		TD12748

DUCATO 1.9 D	04/98→04/02	SCUDO 1.9 D	02/96→12/06
--------------	-------------	-------------	-------------

87-152000-10 STD
87-152007-10 0.50mm
87-152010-10 0.80mm

08-152000-00 STD
08-152003-00 0.125mm
08-152007-00 0.50mm
08-152010-00 0.80mm

A 46.80
B- 2.20
D 84.30
25x72



2.00 CR P
2.00 P
3.00 CR P



14-020530-00 D B 85.60 C 153.50 D 88.50 E 3.90

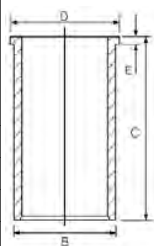

83.50 **48**

312 A4.000 (TwinAir)	2cyl.	964cc	44-48kW (60-65PS)	Petrol		TD26432
312 A6.000 (TwinAir)	2cyl.	964cc	44kW (60PS)	Petrol		TD31245

500 0.9	09/12→	PANDA 0.9	02/12→
500 C 0.9	09/12→	PANDA VAN 0.9	02/12→





87-441900-00 STD 1 2

A 25.43
B- 1.13
BØ 60.88
D 42.93
21x46

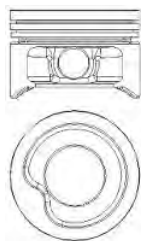

(08395-101)

TP

08-441900-00 STD

1.00 NT 3
1.20 P
1.50 P



1 Bowl capacity 4.140cm³

2 Elastoval ®

3 Steel

1 Volumen der Kolbenmulde 4.140cm³

3 Stahl

1 Volume de la cavité du piston 4.140cm³

3 Acier

1 Vol. cavidad pistón 4.140cm³

3 Acero

1 Volume camera pistone 4.140cm³

3 Acciaio

84.00 **49**

132 AC1.000	4cyl.	1756cc	87-94kW (118-128PS)	Petrol	TD23121
132 C3.031	4cyl.	1995cc	63-77kW (86-105PS)	Petrol	TD908
132 DB.2A-828BC	4cyl.	1995cc		Petrol	MP555
154 A1.000	4cyl.	1995cc	66-74kW (90-101PS)	Petrol	TD1077
154 A2.000	4cyl.	1995cc	114kW (155PS)	Petrol Turbo Intercooled	TD1083
154 C3.046	4cyl.	1995cc	85kW (116PS)	Petrol	TD984
154 C4.046	4cyl.	1995cc	110kW (150PS)	Petrol Turbo Intercooled	TD986
154 E1.000	4cyl.	1995cc	93-101kW (126-137PS)	Petrol	TD989
159 A4.000	4cyl.	1756cc	74-81kW (101-110PS)	Petrol	TD1008
159 A4.046	4cyl.	1756cc	77kW (105PS)	Petrol	TD1009
159 A6.046	4cyl.	1995cc	76-85kW (103-116PS)	Petrol	TD1012
834 B.000	4cyl.	1995cc	88kW (120PS)	Petrol	TD1084
834 B.048	4cyl.	1995cc	83kW (113PS)	Petrol	TD1085
834 B.146	4cyl.	1995cc	85kW (116PS)	Petrol	TD11707
834 C.146	4cyl.	1995cc	110-112kW (150-152PS)	Petrol Turbo Intercooled	TD1064
835 C2.000	4cyl.	1756cc	76kW (103PS)	Petrol	TD1068
835 C4.000	4cyl.	1756cc	66kW (90PS)	Petrol	TD1069
836 A3.000	4cyl.	1995cc	102kW (139PS)	Petrol	TD1071
836 A5.000	4cyl.	1756cc	71-74kW (97-101PS)	Petrol	TD892
836 A6.000	4cyl.	1756cc	66kW (90PS)	Petrol	TD18890
M401 LG.20.0	4cyl.	1995cc	66kW (89PS)	Petrol	MP13997-1
M601 HA.20.0	4cyl.	1995cc	66kW (89PS)	Petrol	MP13997
M619 AA 2.0	4cyl.	1995cc	100kW (136PS)	Petrol Turbo	MP9129
124 1800			01/72→12/77	CROMA 2000 i.e.	03/86→08/96
124 1800 Rally Abarth			09/72→07/75	CROMA 2000 i.e. Turbo	12/85→08/96
124 2000			04/72→11/85	TEMPRA 1.8 i.e.	03/90→08/96
131 2.0			01/77→12/85	TEMPRA 2.0	04/90→12/98
132 2.0			01/77→12/85	TEMPRA 2.0 i.e.	10/90→09/96
ARGENTA 2.0			01/77→12/85	TIPO 1.8 i.e	03/93→04/95
COUPE 2.0 16V			11/93→08/96	TIPO 1.8 i.e.	10/90→10/95
CROMA 2.0			01/90→	TIPO 2.0	10/90→10/92
CROMA 2000 16V			08/92→08/96	TIPO 2.0 i.e.	03/90→04/95
CROMA 2000 CHT			12/85→09/92	TIPO 2.0 i.e. 16V	03/93→04/95





14-011041-00 D B 88.06 C 152.00

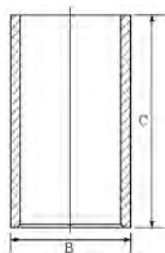

84.00

50

175 A1.000	4cyl.	1995cc	140kW (190PS)	Petrol	Turbo Intercooled	TD4395
COUPE 2.0 16V Turbo		11/93→08/96				

87-142400-00 STD
87-142406-00 0.40mm

08-142400-00 STD
08-142406-00 0.40mm

14-011041-00 D B 88.06 C 152.00

A 39.00
B- 6.00
BØ 72.00
C 2.00
D 69.00
E 22x69

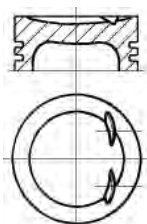

1.50 CK
1.50 P
3.00 P

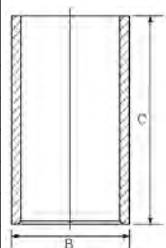

AK

85.00

51

4HP	4cyl.	2179cc	120kW (163PS)	Diesel	Turbo Intercooled	TD24945
4HR	4cyl.	2179cc	120kW (163PS)	Diesel	Turbo Intercooled	TD24946
4HS (Euro 4)	4cyl.	2179cc	125kW (170PS)	Diesel	Turbo Intercooled	TD24775
4HT (DW12BTED4) (Euro 4)	4cyl.	2179cc	125kW (170PS)	Diesel	Turbo Intercooled	TD25656
ULYSSE 2.2 D Multijet		03/08→06/11		ULYSSE 2.2 JTD		03/08→06/11

87-436700-10 STD
87-436708-10 0.60mm

08-436700-00 STD
08-436708-00 0.60mm

A 48.70
B- 13.47
BØ 52.40
C 0.38
D 74.71
E 30x68
(0850HA127)



2.50 GDC P
2.00 P
2.00 CK



AK KK RT TP

For pistons with a 24.3mm con rod gap measured at pin centre line

Für Kolben mit einem Pleuelaugenabstand von 24,3 MM, gemessen an der Kolbenbolzen-Mitte

Pour pistons avec un écart de bielle de 24,3 mm mesuré au centre de l'axe bielle-piston

Para pistones con una distancia de paso de biela en el centro del bulón de 24,3mm

Per pistoni con passaggio biella di 24,3 mm misurato sull'asse foro spinotto

85.00

52

4HW (DW12ATED4)	4cyl.	2179cc	94kW (128PS)	Diesel	Turbo Intercooled	TD16790
4HX (DW12TED4)	4cyl.	2179cc	94-100kW (128-136PS)	Diesel	Turbo Intercooled	TD22230
ULYSSE 2.2 JTD		08/02→08/06				





87-114700-30 STD

- A 48.70
- B- 18.00
- BØ 40.80
- C 0.40
- C 0.40
- D 77.70
- 30x68

AK KK RT



08-114700-00 STD
08-114708-00 0.60mm

- 3.50 CK P
- 2.00 P
- 3.00 CR P

85.00

53

DW10 (RHX)	4cyl.	1997cc	69kW (94PS)	Diesel	Turbo Intercooled	TD16299
DW10 (RHZ)	4cyl.	1997cc	80kW (109PS)	Diesel	Turbo Intercooled	TD16324
RHV	4cyl.	1997cc	62kW (84PS)	Diesel	Turbo	TD39532
DUCATO 2.0 JTD			07/01→07/06	ULYSSE 2.0 JTD		10/99→08/02
SCUDO 2.0 JTD			10/99→12/06			

87-114700-00 STD

87-114708-00 0.60mm

- A 46.75
- B- 18.30
- BØ 38.00
- C 1.00
- D 80.75
- 28x70

AK RT TP



08-114700-00 STD

08-114708-00 0.60mm

- 3.50 CK P
- 2.00 P
- 3.00 CR P

85.00

54

DW10ATED4 (RHM)	4cyl.	1997cc	79-80kW (107-109PS)	Diesel	Turbo Intercooled	TD18906
DW10ATED4 (RHS)	4cyl.	1997cc	80kW (109PS)	Diesel	Turbo Intercooled	TD16789
SCUDO 2.0 JTD 16V			05/99→12/06	ULYSSE 2.0 JTD 16V		05/99→08/02
ULYSSE 2.0 JTD			08/02→08/06			

87-114700-10 STD

87-114708-10 0.60mm

- A 46.73
- B- 18.80
- BØ 39.80
- C 1.67
- D 72.70
- 28x68

(08517-103)

AK KK RT TP



08-114700-00 STD

08-114708-00 0.60mm

- 3.50 CK P
- 2.00 P
- 3.00 CR P

85.00

55

DW10BTED4	4cyl.	1997cc	100kW (136PS)	Diesel	Turbo Intercooled	TD25755
RHK	4cyl.	1997cc	88kW (120PS)	Diesel	Turbo Intercooled	TD20267
RHK (DW10UTED4) (Euro 4)	4cyl.	1997cc	79-88kW (107-120PS)	Diesel	Turbo Intercooled	TD32639
RHR	4cyl.	1997cc	100kW (136PS)	Diesel	Turbo Intercooled	TD20268
SCUDO 2.0 D Multijet			01/07→03/16	ULYSSE 2.0 D Multijet		05/06→06/11
SCUDO 2.0 JTD 16V			05/99→12/06			





87-114700-40 STD
87-114708-40 0.60mm

A 46.70
B- 15.40
BØ 44.80
C 0.57
D 72.71
 28x70

(08570-109)

AK KK RT TP



08-114700-00 STD
08-114708-00 0.60mm



3.50  CK P
2.00  P
3.00  CR P

85.00

56

RH02	4cyl.	1997cc	94-120kW (128-163PS)	Diesel	Turbo Intercooled	TD26194
RHH (Euro 5)	4cyl.	1997cc	120kW (163PS)	Diesel	Turbo Intercooled	TD24777

SCUDO 2.0 D Multijet 07/10→03/16

87-443100-00 STD 
87-443108-00 0.60mm 

A 46.70
B- 13.71
BØ 50.40
C 0.45
D 74.71
 30x68

(0850H-228)

AK KK RT TP



08-443100-00 STD
08-443108-00 0.60mm

2.00  GDC P
2.00  P
2.00  CR P



 Bowl capacity 26.32cm³

 Volumen der Kolbenmulde 26.32cm³

 Volume de la cavité du piston 26.32cm³

 Vol. cavidad pistón 26.32cm³

 Volume camera pistone 26.32cm³

86.00

57

4HU (P22 DTE PUMA)	4cyl.	2198cc	88kW (120PS)	Diesel	Turbo Intercooled	TD25655
---------------------------	-------	---------------	---------------------	---------------	--------------------------	----------------

DUCATO 2.2 TD 120

87-427700-10 STD
87-427707-10 0.50mm

A 43.42
B- 15.85
BØ 46.90
D 69.82
 30x67

(8648B105)

KK RT TP



08-427700-00 STD
08-427705-00 0.25mm
08-427707-00 0.50mm

2.00  CK P
2.00  P
2.00  NT 

14-021120-00 D

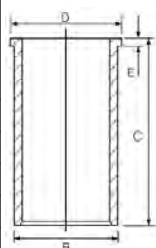

B 89.00 C 156.00 D 90.90 E 5.00

 Steel

 Stahl

 Acier

 Acero

 Acciaio

86.00

58

4HV (Euro 4)	4cyl.	2198cc	74kW (101PS)	Diesel	Turbo	TD39530
---------------------	-------	---------------	---------------------	---------------	--------------	----------------

DUCATO 100 Multijet 2,2 D

07/06→





87-427700-30 STD
87-427707-30 0.50mm

A 43.42
B- 15.85
BØ 46.90
D 69.82
F 30x67

(08650A105)

RT TP



08-427700-00 STD
08-427705-00 0.25mm
08-427707-00 0.50mm

2.00 CK P
2.00 P
2.00 NT



14-021120-00 D

B 89.00 C 156.00 D 90.90 E 5.00

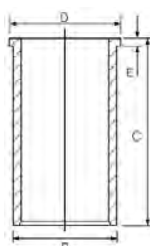

Steel

Stahl

Acier

Acero

Acciaio

88.00

59

170 B	4cyl.	1971cc	55kW (75PS)	Petrol	TD4417
170 D	4cyl.	1971cc	62kW (84PS)	Petrol	TD5102
DUCATO 2.0		07/85→05/94		TALENTO 2.0	
				03/89→03/94	

14-636500-00 WH

B 93.00 C 135.70 D 101.90 E 89.98

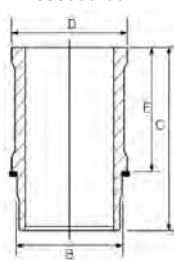

88.00

60

XN 1T	4cyl.	1971cc	55-60kW (75-82PS)	Petrol	TD4418
DUCATO 2.0		01/82→08/90			

A 38.25
B+ 0.65
D 71.85
F 23x74



08-316900-00 STD
08-316907-00 0.50mm

1.50 CR P
2.00 P
4.00 CR



14-636500-00 WH

B 93.00 C 135.70 D 101.90 E 89.98

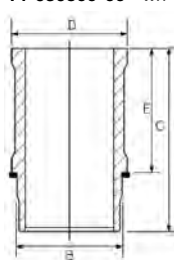

89-316900-00
14-636500-00

Piston available in Kit Set only

Steel

Includes seals

Kolben nur im Assembly erhältlich

Stahl

Schließt Dichtungen ein

Piston disponible en kit seulement

Acier

Inclut des joints

Pistón disponible en conjuntos solamente.

Acero

Incluye los sellos

I pistoni sono disponibili solo in kit motore

Acciaio

Comprende le guarnizioni

88.00

61

F1AE0481C (Euro 3)	4cyl.	2287cc	81kW (110PS)	Diesel	Turbo Intercooled	TD16407
DUCATO 2.3 JTD		12/01→07/06				

87-138000-00 STD
87-138006-00 0.40mm

A 57.00
B- 18.18
BØ 38.00
D 84.00
F 31x67

AK RT TP



08-138000-00 STD
08-138006-00 0.40mm
08-138008-00 0.60mm

2.50 CK P
2.00 P
2.50 CR P





88.00 **62**

F1AE0481D (Euro 4)	4cyl.	2287cc	88kW (120PS)	Diesel	Turbo Intercooled	TD20264
---------------------------	-------	---------------	---------------------	---------------	--------------------------	----------------

DUCATO 120 Multijet 2,3 D 07/06→

<p>87-138000-10 <i>STD</i></p> <p>87-138006-10 <i>0.40mm</i></p> <p>87-138008-10 <i>0.60mm</i></p>	<p>08-138000-00 <i>STD</i></p> <p>08-138006-00 <i>0.40mm</i></p> <p>08-138008-00 <i>0.60mm</i></p>	<p>A 57.00</p> <p>B- 13.75</p> <p>BØ 50.10</p> <p>D 84.00</p> <p> 31x67</p> <p>AK KK RT TP</p>	<p>2.50 CK P</p> <p>2.00 P</p> <p>2.50 CR P</p>
--	--	--	--

88.00 **63**

F1AE3481D	4cyl.	2287cc	96kW (131PS)	Diesel	Turbo Intercooled	TD25174
------------------	-------	---------------	---------------------	---------------	--------------------------	----------------

F1AE3481E	4cyl.	2287cc	109-110kW (148-150PS)	Diesel	Turbo Intercooled	TD25175
------------------	-------	---------------	------------------------------	---------------	--------------------------	----------------

F1AE3481G	4cyl.	2287cc	82-83kW (111-113PS)	Diesel	Turbo Intercooled	TD26313
------------------	-------	---------------	----------------------------	---------------	--------------------------	----------------

DUCATO 110 Multijet 2,3 D 08/06→ DUCATO 150 Multijet 2,3 D 06/11→

DUCATO 130 Multijet 2,3 D 07/06→

<p>87-450600-00 <i>STD</i> </p> <p>A 57.00</p> <p>B- 14.30</p> <p>BØ 49.00</p> <p>D 84.00</p> <p> 31x67</p> <p>AK KK RT TP</p>	<p>08-450600-00 <i>STD</i> </p> <p>2.50 GDC P</p> <p>2.00 P</p> <p>2.50 CR P</p> <p> </p>
--	--

92.00 **64**

THY (DK5ATE)	4cyl.	2446cc	96kW (131PS)	Diesel	Turbo Intercooled	TD22239
---------------------	-------	---------------	---------------------	---------------	--------------------------	----------------

DUCATO II 2.5 TD 07/94→03/98

<p>87-326300-00 <i>STD</i></p> <p>87-326307-00 <i>0.50mm</i> </p> <p>A 49.84</p> <p>B- 2.30</p> <p>D 82.00</p> <p> 34x68</p> <p>AK HA KK RT TP</p>	<p>08-326300-00 <i>STD</i></p> <p>08-326307-00 <i>0.50mm</i> </p> <p>3.00 PS P</p> <p>1.75 CR P</p> <p>3.50 CR P</p>
--	---

A = 49.470, B = 81.600

93.00 **65**

8140.07	4cyl.	2500cc	55kW (75PS)	Diesel		MP19101
----------------	-------	---------------	--------------------	---------------	--	----------------

8140.67	4cyl.	2500cc	55-62kW (75-84PS)	Diesel		TD1052
----------------	-------	---------------	--------------------------	---------------	--	---------------

8140.67.2700	4cyl.	2500cc	62kW (85PS)	Diesel		TD6810
---------------------	-------	---------------	--------------------	---------------	--	---------------

8140.67.X230 (Sofim)	4cyl.	2500cc	63kW (86PS)	Diesel		MP19237
-----------------------------	-------	---------------	--------------------	---------------	--	----------------

8140.97Y (Sofim)	4cyl.	2500cc	85kW (116PS)	Diesel	Turbo Intercooled	MP19100
-------------------------	-------	---------------	---------------------	---------------	--------------------------	----------------

8144.97 (Sofim)	4cyl.	2500cc	85kW (115PS)	Diesel	Turbo Intercooled	TD1061
------------------------	-------	---------------	---------------------	---------------	--------------------------	---------------

8144.97.2400	4cyl.	2500cc	83-87kW (113-118PS)	Diesel	Turbo Intercooled	TD22316
---------------------	-------	---------------	----------------------------	---------------	--------------------------	----------------





8144.97 S (Sofim)	4cyl.	2500cc	77kW (105PS)	Diesel	Turbo Intercooled	TD1059
8144.97 Y (Sofim)	4cyl.	2500cc	85kW (115PS)	Diesel	Turbo Intercooled	TD1060
CROMA 2.5TD			01/92→	DUCATO 2.5 D		03/94→04/02
CROMA 2500 TD			05/89→08/96	DUCATO 2.5D		01/89→
CROMA 2500 TDE			12/91→08/96			

14-021371-00 D B 96.01 C 171.00 D 98.92 E 5.00
14-021372-00 D B 96.05 C 171.00 D 98.92 E 5.00

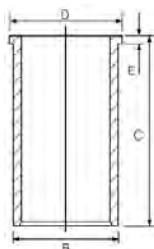

93.00						66
8140.21.201-203 (Sofim)	4cyl.	2445cc	68kW (92PS)	Diesel	Turbo	MP9240
8140.212/214/29 (Sofim)	4cyl.	2445cc	77kW (105PS)	Diesel	Turbo	MP9241
8144.21 (Sofim)	4cyl.	2445cc	68kW (92PS)	Diesel	Turbo	TD4419
8144.21.220	4cyl.	2445cc	68kW (92PS)	Diesel	Turbo	TD6803
DUCATO 2.5 TD			01/86→02/91	DUCATO 2.5TD		

87-245200-30 STD

A 59.65
 B- 14.80
 BØ 51.90
 D 97.65
 32x75

RT



08-245200-00 STD
08-245208-00 0.60mm

3.00  CR P
 2.00  P
 3.00  CR P

14-021371-00 D B 96.01 C 171.00 D 98.92 E 5.00
14-021372-00 D B 96.05 C 171.00 D 98.92 E 5.00

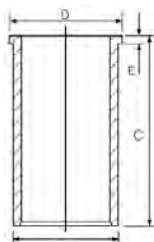

93.00						67
8140.27 (Sofim)	4cyl.	2500cc	68-70kW (92-95PS)	Diesel	Turbo	TD1047
8140.27.2100	4cyl.	2500cc	70kW (95PS)	Diesel	Turbo	TD6800
8140.27R/S.2700 (Sofim)	4cyl.	2500cc		Diesel	Turbo	MP9102-1
DUCATO 2.5 D			09/86→05/90	DUCATO 2.5 TD		09/86→05/94
DUCATO 2.5D			01/89→			

87-245200-40 STD

A 58.75
 B- 17.90
 BØ 38.00
 D 96.75
 32x75

RT



08-245200-00 STD
08-245208-00 0.60mm

3.00  CR P
 2.00  P
 3.00  CR P

14-021371-00 D B 96.01 C 171.00 D 98.92 E 5.00
14-021372-00 D B 96.05 C 171.00 D 98.92 E 5.00

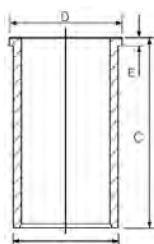

93.00						68
8140.27S.3700 (Euro 1)	4cyl.	2500cc	77kW (105PS)	Diesel	Turbo Intercooled	TD20152





8140.47	4cyl.	2500cc	80-85kW (109-116PS)	Diesel	Turbo Intercooled	TD1048
8140.47.3700	4cyl.	2500cc	85kW (116PS)	Diesel	Turbo Intercooled	TD6809
8140.47R (Sofim)	4cyl.	2500cc	80kW (110PS)	Diesel	Turbo Intercooled	TD1049
8140.47R.2210	4cyl.	2500cc	80kW (110PS)	Diesel	Turbo Intercooled	TD6811
DUCATO 2.5 TD			06/94→09/01	DUCATO 2.5 TDI		03/94→04/02

87-520200-00 STD

A 58.75
B- 18.40
BØ 38.00
D 96.75
E 32x78



AK KK NB RT

08-520200-00 STD

3.00 CR
2.00 P
3.00 CR P



14-021371-00 D B 96.01 C 171.00 D 98.92 E 5.00
14-021372-00 D B 96.05 C 171.00 D 98.92 E 5.00

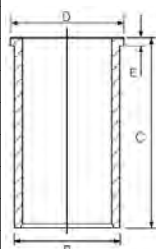

93.00

69

8140.61	4cyl.	2445cc	53-55kW (72-75PS)	Diesel		TD1050
8140.61.204	4cyl.	2445cc	53kW (72PS)	Diesel		TD1051
8142.61	4cyl.	2445cc	53kW (72PS)	Diesel		TD1053
8144.61	4cyl.	2445cc	53-55kW (72-75PS)	Diesel		TD4408
8144.61.200 (SOFIM)	4cyl.	2445cc	53kW (72PS)	Diesel		TD6796
8144.61.500.81	4cyl.	2445cc	66kW (90PS)	Diesel		TD1054
8144.67	4cyl.	2500cc	55kW (75PS)	Diesel		TD1056
8144.67.220	4cyl.	2500cc	55kW (75PS)	Diesel		TD6797
8144.81.2000	4cyl.	2500cc	66-74kW (90-101PS)	Diesel	Turbo	TD1057
8144.91.2000	4cyl.	2445cc	74kW (101PS)	Diesel	Turbo Intercooled	TD1058
8144.97.2200	4cyl.	2500cc	86-87kW (117-118PS)	Diesel	Turbo Intercooled	TD1062
8144.97.2500	4cyl.	2500cc	85kW (118PS)	Diesel	Turbo Intercooled	TD1063

131 2.5 D		06/78→02/84	CAMPAGNOLA 2.4 D	06/74→10/89
131 2.5 Super Diesel		03/79→12/84	CROMA 2500 D	12/85→12/89
132 2.5 D		07/78→07/82	CROMA 2500 TD	12/85→08/89
ARGENTA 2500 Diesel		06/81→11/85	DUCATO 2.4 D	01/82→08/90
ARGENTA 2500 Turbodiesel		07/83→08/85	DUCATO 2.5 D	01/82→05/94

14-022560-00 D B 96.00 C 167.30 D 98.90 E 5.00
14-028930-00 D B 97.50 C 167.00 D 100.90 E 5.00
14-028931-00 D B 97.58 C 167.00 D 100.90 E 5.00
14-028932-00 D B 97.70 C 167.00 D 100.90 E 5.00

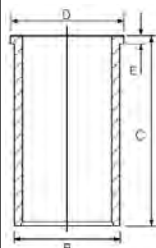

93.00

70

B 25.637	4cyl.	2500cc	51kW (69PS)	Diesel		TD21463
CRD93L (U25-661)	4cyl.	2500cc	54-55kW (73-75PS)	Diesel		TD22981
242 2.5 D			08/80→07/82	DUCATO 2.5 D		01/82→08/90





87-152700-00 STD
87-152707-00 0.50mm

A 52.75
B- 7.30
D 87.75
 30x78



08-152700-00 STD
08-152707-00 0.50mm

2.50  MOL P
 2.00  P
 4.00  CR P

14-013481-00 D

B 96.10 **C** 163.00

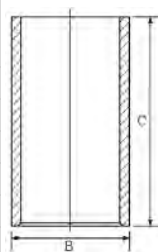

94.40

71

8140.43 (Euro 2 Sofim)	4cyl.	2800cc	90kW (122PS)	Diesel	Turbo	TD11769
DUCATO 2.8 iDTD			05/98→09/01	DUCATO 2.8 TD		05/98→07/06
DUCATO 2.8 JTD			11/03→07/06	DUCATO 2.8 TDI		10/97→04/02

87-122200-10 STD
87-122208-10 0.60mm

A 58.75
B- 19.40
BØ 39.25
D 87.60
 32x72

AK KK RT TP



08-122200-00 STD
08-122208-00 0.60mm

2.50  CK P
 2.00  P
 2.50  CR P

14-021321-00 D

B 97.54 **C** 167.00 **D** 100.90 **E** 5.00

14-028930-00 D

B 97.50 **C** 167.00 **D** 100.90 **E** 5.00

14-028931-00 D

B 97.58 **C** 167.00 **D** 100.90 **E** 5.00

14-028932-00 D

B 97.70 **C** 167.00 **D** 100.90 **E** 5.00

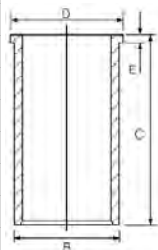

87-854700-00 STD
87-854708-00 0.60mm

A 58.75
B- 19.40
BØ 39.40
D 96.65
 32x78

AK KK RT



08-854700-00 STD
08-854708-00 0.60mm

3.00  CR
 2.00  P
 3.00  CR

94.40

72

8140.43N (Euro 3 Sofim)	4cyl.	2800cc	107kW (146PS)	Diesel	Turbo Intercooled	TD20450
8140.43S (Euro 3 Sofim)	4cyl.	2800cc	93-103kW (127-140PS)	Diesel	Turbo Intercooled	TD16196
DUCATO 2.8 JTD			11/00→			

87-122200-00 STD
87-122208-00 0.60mm

A 58.70
B- 21.30
BØ 39.40
D 87.60
 32x72

AK KK RT TP



08-122200-00 STD
08-122208-00 0.60mm

2.50  CK P
 2.00  P
 2.50  CR P

14-021321-00 D

B 97.54 **C** 167.00 **D** 100.90 **E** 5.00

14-028930-00 D

B 97.50 **C** 167.00 **D** 100.90 **E** 5.00

14-028931-00 D

B 97.58 **C** 167.00 **D** 100.90 **E** 5.00

14-028932-00 D

B 97.70 **C** 167.00 **D** 100.90 **E** 5.00

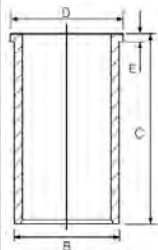



94.40 **73**

8140.63 (Euro 2 Sofim) 4cyl. 2800cc 64kW (87PS) Diesel TD12749

DUCATO 2.8 D 02/98→04/02 DUCATO 2.8 TD 05/98→11/01

87-108200-00 STD
87-108208-00 0.60mm

A 55.00
B- 2.80
D 90.00
 32x68



AK HA RT TP

08-108200-00 STD
08-108208-00 0.60mm

3.00  CR P
2.00  P
2.50  CR P

14-021321-00 D B 97.54 C 167.00 D 100.90 E 5.00
14-028930-00 D B 97.50 C 167.00 D 100.90 E 5.00
14-028931-00 D B 97.58 C 167.00 D 100.90 E 5.00
14-028932-00 D B 97.70 C 167.00 D 100.90 E 5.00

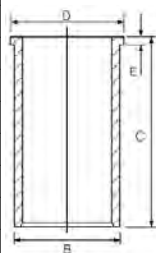

95.80 **74**

F1CE0481D (Euro 4) 4cyl. 2999cc 115-116kW (156-158PS) Diesel Turbo Intercooled TD20265

DUCATO 160 Multijet 3,0 D 07/06→

87-421600-00 STD

A 63.00
B- 16.00
BØ 50.50
D 93.50
 36x80



AK KK RT TP

08-421600-00 STD
08-421606-00 0.40mm

2.50  CK P
2.00  P
2.50  CR P

95.80 **75**

F1CE3481E (Euro 5) 4cyl. 2999cc 130kW (177PS) Diesel Turbo Intercooled TD25176

F1CE3481M (Euro 5) 4cyl. 2999cc 115kW (156PS) Diesel Turbo Intercooled TD24897

F1CE3481N (Euro 5) 4cyl. 2999cc 103-107kW (140-145PS) Diesel Turbo Intercooled TD24896

DUCATO 150 Multijet 3,0 D 04/10→ DUCATO 180 Multijet 3,0 D 06/11→
DUCATO 160 Multijet 3,0 D 07/06→



87-421600-10 STD

A 63.00
B- 16.00
BØ 53.20
D 93.40
 36x80



AK KK RT TP

08-421600-10 STD

2.50  GDC P
2.00  P
2.50  CK P



CCM

x



9

1Z	Diesel	1896	4	79.50	18
4AA (2401E York Parent Block)	Diesel	2358	4	93.67	54
4AB	Diesel	2496	4	93.67	55
4BA	Diesel	2496	4	93.67	55
4BC	Diesel	2496	4	93.67	56
4CA	Diesel	2496	4	93.67	55
4CC	Diesel	2496	4	93.67	55
4DA	Diesel	2496	4	93.67	55
4EA	Diesel	2496	4	93.67	54
4EB	Diesel	2496	4	93.67	54
4EC	Diesel	2496	4	93.67	54
4ED	Diesel	2496	4	93.67	57
4FA	Diesel	2496	4	93.67	56
4FB	Diesel	2496	4	93.67	56
4FC	Diesel	2496	4	93.67	56
4FD	Diesel	2496	4	93.67	56
4GA	Diesel	2496	4	93.67	56
4GB	Diesel	2496	4	93.67	56
4GC	Diesel	2496	4	93.67	56
4GD	Diesel	2496	4	93.67	56
4GE	Diesel	2496	4	93.67	56
4GF	Diesel	2496	4	93.67	56
4HA	Diesel	2496	4	93.67	54
4HB	Diesel	2496	4	93.67	56
4HC	Diesel	2496	4	93.67	56
4HD	Diesel	2496	4	93.67	54
4.108	Diesel	1760	4	79.37	17
6Y SERIES (256 cu.in.)	Diesel	4196	4	111.77	71
6Y SERIES (256 cu.in.)	Diesel	4195	4	106.69	65
6Y SERIES 32D (158 cu.in.)	Diesel	2589	3	106.69	64
6Y SERIES 40D (175 cu.in.)	Diesel	2867	3	106.69	65
7A SERIES (201 cu.in.)	Diesel	3294	3	111.77	69
7A SERIES (256 cu.in.)	Diesel	4196	4	111.77	71
7A SERIES (256 cu.in.)	Diesel	4195	4	106.69	65
7A SERIES 32D (158 cu.in.)	Diesel	2589	3	106.69	64
7A SERIES 32D (180 cu.in.)	Diesel	2950	3	106.69	64
7A SERIES 40D (175 cu.in.)	Diesel	2867	3	106.69	65
56G	Diesel	3819	4	106.69	64
90/5 AA-DOVER	Diesel	4162	4	107.21	67
110/6 AA-DOVER	Diesel	5944	6	104.77	63
130/7 AA-DOVER	Diesel	6223	6	107.21	67
150/6 CA-DOVER	Diesel	5944	6	104.77	63
268 CU.IN.	Diesel	4391	4	111.77	70
401 CU.IN. (TW20,TW30)	Diesel	6571	6	111.77	70
590E	Diesel	5416	6	100.00	62
592E	Diesel	3610	4	100.00	62
711M	Petrol	1599	4	80.98	23
711M UPRATED	Petrol	1599	4	80.98	24
2402E YORK (Parent Block)	Diesel	3537	6	93.67	54
2501E	Diesel	2589	3	106.69	64
2502E	Diesel	2589	3	106.69	64
2503E	Diesel	2589	3	106.69	64
2504E (175 cu.in.)	Diesel	2867	3	106.69	64
2505E (192 CU.IN.)	Diesel	3146	3	111.77	68
2506E (201CU.IN.)	Diesel	3294	3	111.77	68
2508E (175 cu.in.)	Diesel	2867	3	106.69	64
2508E D233	Diesel	3819	4	106.69	64
2701E (240 cu.in.)	Diesel	3933	4	104.77	63
2704E	Diesel	5944	6	104.77	63
2704ET (360 cu.in.)	Diesel	5944	6	104.77	63

ENGINE INDEX

Motorverzeichnis • Index de moteur • Índice de Motor
 Indeks silnika • Модель Двигателя • دليل المحرك

CCM
x

9

2706E (240 cu.in.)	Diesel	3933	4	104.77	63
2709E	Diesel	5944	6	104.77	63
2711E (255 cu.in.)	Diesel	4178	4	107.21	66
2712E (254 cu.in. Parent Block)	Diesel	4162	4	107.21	66
2713E (365 cu.in. Parent Block)	Diesel	5981	6	104.77	63
2714E (380 cu.in.)	Diesel	6227	6	107.21	66
2715E (380 cu.in Parent Block D-Series)	Diesel	6227	6	107.21	66
2737E (Low compression)	Petrol	1599	4	80.98	23
A9A	Petrol	1299	4	74.00	5
A9B	Petrol	1299	4	74.00	5
ABFA (Duratorq)	Diesel	1998	4	86.00	34
AEDA (Duratorq)	Diesel	1499	4	73.50	3
AFN	Diesel	1896	4	79.50	18
AHU	Diesel	1896	4	79.50	18
AJM	Diesel	1896	4	79.50	19
ANU	Diesel	1896	4	79.50	20
AOBA (Euro 4 Duratec)	Petrol	1999	4	87.50	40
AODA	Petrol	1999	4	87.50	40
AODB	Petrol	1999	4	87.50	40
AODE	Petrol	1999	4	87.50	40
AOWA	Petrol	1999	4	87.50	40
AOWB	Petrol	1999	4	87.50	40
ASDA	Petrol	1388	4	76.00	10
ASDB	Petrol	1388	4	76.00	10
ASZ	Diesel	1896	4	79.50	21
AUY	Diesel	1896	4	79.50	19
AVG	Diesel	1896	4	79.50	18
BAA	Petrol	1299	4	74.00	6
BHPA (Endura DI)	Diesel	1753	4	82.50	26
BKFA (Euro 6 EcoBlue)	Diesel	1996	4	84.01	30
BKFB (Euro 6 EcoBlue)	Diesel	1996	4	84.01	30
BKFC (Euro 6 EcoBlue)	Diesel	1996	4	84.01	30
BKFD (Euro 6 EcoBlue)	Diesel	1996	4	84.01	30
BKRA (EcoBlue)	Diesel	1996	4	84.01	30
BKRB (EcoBlue)	Diesel	1996	4	84.01	30
BNMA (EcoBoost)	Petrol	1499	4	79.00	11
BSD 332 (192 CU.IN.)	Diesel	3146	3	111.77	68
BSD333 (201 cu.in.)	Diesel	3294	3	111.77	69
BSD333 >87 (201 cu.in.)	Diesel	3294	3	111.77	68
BSD333H (201 cu.in.)	Diesel	3294	3	111.77	69
BSD442 (256 cu.in.)	Diesel	4195	4	111.77	71
BSD444 (268 cu.in.)	Diesel	4391	4	111.77	69
BSD444T (268 cu.in.)	Diesel	4391	4	111.77	70
CGBA (Duratec)	Petrol	1798	4	83.00	29
CGBB (Duratec)	Petrol	1798	4	83.00	29
CHBA (Duratec)	Petrol	1798	4	83.00	29
CHBB (Duratec)	Petrol	1798	4	83.00	29
CJBA (Duratec)	Petrol	1999	4	87.50	40
CJBB (Duratec)	Petrol	1999	4	87.50	40
CSDA (Duratec)	Petrol	1798	4	83.00	29
CSDB (Duratec)	Petrol	1798	4	83.00	29
CV24 (Duratorq)	Diesel	2198	4	86.00	35
CVF5 (Duratorq)	Diesel	2198	4	86.00	35
CVFF (Duratorq)	Diesel	2198	4	86.00	35
CVR5 (Duratorq)	Diesel	2198	4	86.00	35
CVRA (Duratorq)	Diesel	2198	4	86.00	35
CVRB (Duratorq)	Diesel	2198	4	86.00	35
CVRC (Duratorq)	Diesel	2198	4	86.00	35
CYF5 (Duratorq)	Diesel	2198	4	86.00	36
CYFA (Duratorq)	Diesel	2198	4	86.00	35

CCM

x



9

CYFB (Duratorq)	Diesel	2198	4	86.00	35
CYFC (Duratorq)	Diesel	2198	4	86.00	35
CYFD (Duratorq)	Diesel	2198	4	86.00	35
CYRA (Duratorq)	Diesel	2198	4	86.00	36
CYRB (Duratorq)	Diesel	2198	4	86.00	36
CYRC (Duratorq)	Diesel	2198	4	86.00	36
D2FA (Duratorq)	Diesel	2402	4	89.90	43
D2FB (Duratorq)	Diesel	2402	4	89.90	43
D2FE (Duratorq)	Diesel	2402	4	89.90	43
D3FA	Diesel	1998	4	86.00	34
D4FA (Duratorq)	Diesel	2402	4	89.90	44
D5BA (Duratorq)	Diesel	1998	4	86.00	34
D6BA (Duratorq)	Diesel	1998	4	86.00	37
DOFA (DT24) (Duratorq)	Diesel	2402	4	89.90	45
DRFA (Duratorq)	Diesel	2198	4	86.00	35
DRFB (Duratorq)	Diesel	2198	4	86.00	35
DRFC (Duratorq)	Diesel	2198	4	86.00	35
E5FA	Petrol	2295	4	89.60	42
E5FC	Petrol	2295	4	89.60	42
EDBA (Zetec)	Petrol	1988	4	84.80	31
EDBB (Zetec)	Petrol	1988	4	84.80	31
EDBC (Zetec)	Petrol	1988	4	84.80	31
EDBD (Zetec)	Petrol	1988	4	84.80	31
EDDB (Zetec)	Petrol	1988	4	84.80	31
EDDC (Zetec)	Petrol	1988	4	84.80	31
EDDF (Zetec)	Petrol	1988	4	84.80	31
F3FA (Duratorq)	Diesel	1998	4	86.00	34
F4FA (Duratorq)	Diesel	2402	4	89.90	43
F6JA (DV4TD)	Diesel	1399	4	73.70	4
F6JB (DV4TD)	Diesel	1399	4	73.70	4
F9DA	Diesel	1753	4	82.50	27
F9DB	Diesel	1753	4	82.50	27
FFBA	Diesel	1753	4	82.50	28
FFDA	Diesel	1753	4	82.50	27
FIFA (Duratorq)	Diesel	1998	4	86.00	37
FMBA	Diesel	1998	4	86.00	37
FXDA (Zetec)	Petrol	1388	4	76.00	10
FXDB (Zetec)	Petrol	1388	4	76.00	10
FXDC (Zetec)	Petrol	1388	4	76.00	10
FXDD (Zetec)	Petrol	1388	4	76.00	10
FXFA (Duratorq)	Diesel	2402	4	89.90	44
FXJA	Petrol	1388	4	76.00	10
FXJB	Petrol	1388	4	76.00	10
FYDA (Zetec)	Petrol	1596	4	79.00	12
FYDB (Zetec)	Petrol	1596	4	79.00	12
FYDC (Zetec)	Petrol	1596	4	79.00	12
FYDD (Zetec)	Petrol	1596	4	79.00	12
FYDH (Zetec)	Petrol	1596	4	79.00	12
FYJA	Petrol	1596	4	79.00	13
FYJA (Duratec)	Petrol	1596	4	79.00	12
FYJB (Duratec)	Petrol	1596	4	79.00	12
G6DA (Duratorq)	Diesel	1997	4	85.00	32
G6DB (Duratorq)	Diesel	1997	4	85.00	32
G6DD (Duratorq)	Diesel	1997	4	85.00	32
G8DA	Diesel	1560	4	75.00	8
G8DB	Diesel	1560	4	75.00	8
G8DD	Diesel	1560	4	75.00	8
G8DE	Diesel	1560	4	75.00	8
G8DF	Diesel	1560	4	75.00	8
GBVAJPF (Duratorq)	Diesel	2198	4	86.00	35

ENGINE INDEX

Motorverzeichnis • Index de moteur • Índice de Motor
 Indeks silnika • Модель Двигателя • دليل المحرك



CCM

x



9

GBVAJQJ (Duratorq)	Diesel	2198	4	86.00	35
GBVAJQW (Duratorq)	Diesel	2198	4	86.00	35
GLC	Petrol	1117	4	74.00	7
GPDA (Euro 4)	Diesel	1560	4	75.00	8
GPDC (Euro 4)	Diesel	1560	4	75.00	8
GSE	Petrol	1117	4	74.00	7
GSF	Petrol	1117	4	74.00	7
GSG	Petrol	1117	4	74.00	7
GUD	Petrol	1119	4	68.70	1
GUE	Petrol	1119	4	68.70	1
H9FA (Duratorq)	Diesel	2402	4	89.90	46
H9FA (Euro 4 Duratorq)	Diesel	2402	4	89.90	47
H9FB (Euro 4 Duratorq)	Diesel	2402	4	89.90	46
HCPA (Duratorq)	Diesel	1753	4	82.50	26
HCPB (Duratorq)	Diesel	1753	4	82.50	26
HHDA (Euro 4)	Diesel	1560	4	75.00	8
HHDB (Euro 4)	Diesel	1560	4	75.00	8
HHJA	Diesel	1560	4	75.00	8
HHJB	Diesel	1560	4	75.00	8
HHJC (Duratorq)	Diesel	1560	4	75.00	8
HHJD (Duratorq)	Diesel	1560	4	75.00	8
HHJE (Duratorq)	Diesel	1560	4	75.00	8
HHJF (Duratorq)	Diesel	1560	4	75.00	8
HJBA	Diesel	1998	4	86.00	37
HJBB	Diesel	1998	4	86.00	37
HJBC	Diesel	1998	4	86.00	37
HWDA (Duratec)	Petrol	1596	4	79.00	14
HWDB (Duratec)	Petrol	1596	4	79.00	14
HXDA (Duratec)	Petrol	1596	4	79.00	14
HXDB (Duratec)	Petrol	1596	4	79.00	14
J2	Petrol	1298	4	80.98	25
J4C (Endura)	Petrol	1299	4	74.00	6
J4D (Endura)	Petrol	1299	4	74.00	6
J4J (Endura)	Petrol	1299	4	74.00	6
J4K (Endura)	Petrol	1299	4	74.00	6
J4L (Endura)	Petrol	1299	4	74.00	6
J4M (Endura)	Petrol	1299	4	74.00	6
J4N (Endura)	Petrol	1299	4	74.00	6
J4P (Endura)	Petrol	1299	4	74.00	6
J4Q (Endura)	Petrol	1299	4	74.00	6
J4R (Endura)	Petrol	1299	4	74.00	6
J4S (Endura)	Petrol	1299	4	74.00	6
J4T (Endura)	Petrol	1299	4	74.00	6
JBA	Petrol	1297	4	74.00	6
JBB	Petrol	1297	4	74.00	6
JBC	Petrol	1299	4	74.00	6
JBD	Petrol	1297	4	74.00	6
JJA (Endura)	Petrol	1299	4	74.00	6
JJB (Endura)	Petrol	1299	4	74.00	6
JJC (Endura)	Petrol	1299	4	74.00	6
JJD (Endura)	Petrol	1299	4	74.00	6
JJE (Endura)	Petrol	1299	4	74.00	6
JJF (Endura)	Petrol	1299	4	74.00	6
JJG (Endura)	Petrol	1299	4	74.00	6
JJH (Endura)	Petrol	1299	4	74.00	6
JJJ (Endura)	Petrol	1299	4	74.00	6
JJK (Endura)	Petrol	1299	4	74.00	6
JJL (Endura)	Petrol	1299	4	74.00	6
JJM (Endura)	Petrol	1299	4	74.00	6
JLB	Petrol	1297	4	74.00	6

CCM
x

9

JQDA (EcoBoost)	Petrol	1596	4	79.00	15
JQDB (EcoBoost)	Petrol	1596	4	79.00	15
JQMA (EcoBoost)	Petrol	1596	4	79.00	15
JQMB (EcoBoost)	Petrol	1596	4	79.00	15
JTDA (EcoBoost)	Petrol	1596	4	79.00	15
JTDB (EcoBoost)	Petrol	1596	4	79.00	15
JTMA (EcoBoost)	Petrol	1596	4	79.00	15
JTWA	Petrol	1596	4	79.00	15
JTWB	Petrol	1596	4	79.00	15
JXFA (Duratorq)	Diesel	2402	4	89.90	46
JXFC (Duratorq)	Diesel	2402	4	89.90	46
KHBA (Duratorq)	Diesel	1753	4	82.50	28
KKDA (Euro 4)	Diesel	1753	4	82.50	28
KKDB (Euro 4)	Diesel	1753	4	82.50	28
KL16L (751M)	Petrol	1599	4	80.98	23
KNBA (Duratorq)	Diesel	2179	4	85.00	33
KNBB (Duratorq)	Diesel	2179	4	85.00	33
KNWA (Duratorq)	Diesel	2179	4	85.00	33
KNWB (Duratorq)	Diesel	2179	4	85.00	33
L1V (Zetec)	Petrol	1596	4	79.00	13
L1T (Zetec)	Petrol	1596	4	79.00	13
L1W (Zetec-SE)	Petrol	1596	4	79.00	13
L3E	Petrol	1598	4	80.98	23
LC	Petrol	1598	4	80.98	23
M1CA (EcoBoost)	Petrol	998	3	71.90	2
M1CB (EcoBoost)	Petrol	998	3	71.90	2
M1DA (Euro 5 EcoBoost)	Petrol	998	3	71.90	2
M1JA (EcoBoost)	Petrol	998	3	71.90	2
M1JC (Euro 5 EcoBoost)	Petrol	998	3	71.90	2
M1JE (EcoBoost)	Petrol	998	3	71.90	2
M1JH (EcoBoost)	Petrol	998	3	71.90	2
M2DA (Euro 5 EcoBoost)	Petrol	998	3	71.90	2
M2GA (Euro 5 EcoBoost)	Petrol	998	3	71.90	2
M2GB (Euro 6 EcoBoost)	Petrol	998	3	71.90	2
M8DA (EcoBoost)	Petrol	1498	4	79.00	11
M8DB (EcoBoost)	Petrol	1498	4	79.00	11
M8DD (EcoBoost)	Petrol	1498	4	79.00	11
M8DE (EcoBoost)	Petrol	1498	4	79.00	11
M8MA (EcoBoost)	Petrol	1499	4	79.00	11
M8MB (EcoBoost)	Petrol	1499	4	79.00	11
M9DA (EcoBoost)	Petrol	1498	4	79.00	11
M9DB (EcoBoost)	Petrol	1498	4	79.00	11
M9DG (EcoBoost)	Petrol	1498	4	79.00	11
M9DH (EcoBoost)	Petrol	1498	4	79.00	11
M9MA (EcoBoost)	Petrol	1499	4	79.00	11
M9MC (EcoBoost)	Petrol	1499	4	79.00	11
N4A	Petrol	1994	4	90.80	51
N4I	Petrol	1994	4	90.80	51
N4JB (Duratec)	Petrol	1999	4	87.50	40
N7BA	Diesel	1998	4	86.00	37
NAE (TL20L)	Petrol	1994	4	90.80	52
NAT (TL20L)	Petrol	1994	4	90.80	52
NAV (TL20L)	Petrol	1994	4	90.80	52
NE1	Petrol	1994	4	90.80	51
NE4	Petrol	1994	4	90.80	51
NE5	Petrol	1994	4	90.80	51
NEJ	Petrol	1994	4	90.80	51
NEL	Petrol	1994	4	90.80	51
NES	Petrol	1994	4	90.80	51
NET	Petrol	1994	4	90.80	51

ENGINE INDEX

Motorverzeichnis • Index de moteur • Índice de Motor
 Indeks silnika • Модель Двигателя • دليل المحرك



CCM

x



9

NGA (Zetec)	Petrol	1988	4	84.80	31
NGB (Zetec)	Petrol	1988	4	84.80	31
NR2	Petrol	1994	4	90.80	51
NRA	Petrol	1994	4	90.80	51
NRB	Petrol	1994	4	90.80	51
NRI	Petrol	1994	4	90.80	51
P7PA (Duratorq)	Diesel	1753	4	82.50	26
P7PB (Duratorq)	Diesel	1753	4	82.50	26
P8FA (Duratorq)	Diesel	2198	4	86.00	38
P8FB (Duratorq)	Diesel	2198	4	86.00	38
P9PA (Duratorq)	Diesel	1753	4	82.50	26
P9PB (Duratorq)	Diesel	1753	4	82.50	26
P9PC (Duratorq)	Diesel	1753	4	82.50	26
P9PD (Duratorq)	Diesel	1753	4	82.50	26
PGFA (Duratorq)	Diesel	2198	4	86.00	36
PGFB (Duratorq)	Diesel	2198	4	86.00	36
PHFA (Duratorq)	Diesel	2402	4	89.90	48
PHFC (Duratorq)	Diesel	2402	4	89.90	48
PNBA (Duratec)	Petrol	1596	4	79.00	14
Q7DA (Duratec)	Petrol	1798	4	83.00	29
QJBA (Duratorq)	Diesel	2198	4	86.00	39
QJBB (Duratorq)	Diesel	2198	4	86.00	39
QJBC (Duratorq)	Diesel	2198	4	86.00	39
QJBD (Duratorq)	Diesel	2198	4	86.00	39
QQDA (Duratec)	Petrol	1798	4	83.00	29
QQDB (Duratec)	Petrol	1798	4	83.00	29
QVFA (Duratorq)	Diesel	2198	4	86.00	39
QWFA (Duratorq)	Diesel	2198	4	86.00	39
QYBA (Duratorq)	Diesel	1753	4	82.50	28
QYWA (Duratorq)	Diesel	1753	4	82.50	28
R2PA (Duratorq)	Diesel	1753	4	82.50	26
R3PA (Duratorq)	Diesel	1753	4	82.50	26
RDA (Zetec)	Petrol	1796	4	80.60	22
RDB (Zetec)	Petrol	1796	4	80.60	22
RKA (Zetec)	Petrol	1796	4	80.60	22
RKB (Zetec)	Petrol	1796	4	80.60	22
RKC (Zetec)	Petrol	1796	4	80.60	22
RKF (Zetec)	Petrol	1796	4	80.60	22
RKH (Zetec)	Petrol	1796	4	80.60	22
RKJ (Zetec)	Petrol	1796	4	80.60	22
RKK (Zetec)	Petrol	1796	4	80.60	22
RQB (Zetec)	Petrol	1796	4	80.60	22
RQC (Zetec)	Petrol	1796	4	80.60	22
RWPA (Duratorq)	Diesel	1753	4	82.50	28
RWPC (Duratorq)	Diesel	1753	4	82.50	28
RWPD (Duratorq)	Diesel	1753	4	82.50	28
RWPE (Duratorq)	Diesel	1753	4	82.50	26
RWPF (Duratorq)	Diesel	1753	4	82.50	26
SAFA (Duratorq)	Diesel	3198	5	89.90	49
SAFB (Duratorq)	Diesel	3198	5	89.90	49
SCB	Diesel	2500	4	92.00	53
SCC	Diesel	2500	4	92.00	53
SDBA (Duratorq)	Diesel	1998	4	86.00	34
SFA (XD3T)	Diesel	2498	4	94.00	58
SFB (XD3T)	Diesel	2498	4	94.00	58
SFCA (EcoBoost)	Petrol	998	3	71.90	2
SFCB (EcoBoost)	Petrol	998	3	71.90	2
SFCC (EcoBoost)	Petrol	998	3	71.90	2
SFCD (EcoBoost)	Petrol	998	3	71.90	2
SFDA (Euro 5 EcoBoost)	Petrol	998	3	71.90	2

CCM
x

9

SFJA (EcoBoost)	Petrol	998	3	71.90	2
SFJB (EcoBoost)	Petrol	998	3	71.90	2
SFJC (EcoBoost)	Petrol	998	3	71.90	2
SFJD (EcoBoost)	Petrol	998	3	71.90	2
SHDA (Duratec Ti-VCT)	Petrol	1596	4	79.00	14
SHDB (Duratec Ti-VCT)	Petrol	1596	4	79.00	14
SHDC (Duratec Ti-VCT)	Petrol	1596	4	79.00	14
SIDA (Duratec)	Petrol	1596	4	79.00	14
SRFA (Duratorq)	Diesel	2198	4	86.00	36
SRFB (Duratorq)	Diesel	2198	4	86.00	36
SRFC (Duratorq)	Diesel	2198	4	86.00	36
SRFD (Duratorq)	Diesel	2198	4	86.00	36
SRFE (Duratorq)	Diesel	2198	4	86.00	36
STP (XD3/XD3P)	Diesel	2499	4	94.00	59
STR (XD3/XD3P)	Diesel	2498	4	94.00	59
SYDA (Duratec)	Petrol	1999	4	87.50	40
T1DA (Duratorq)	Diesel	1560	4	75.00	9
T1DB (Duratorq)	Diesel	1560	4	75.00	9
T3DA (Duratorq)	Diesel	1560	4	75.00	9
T3DB (Duratorq)	Diesel	1560	4	75.00	9
T3JA (Duratorq)	Diesel	1560	4	75.00	9
T3JB	Diesel	1560	4	75.00	9
TD27	Diesel	2663	4	96.00	61
TD27E	Diesel	2664	4	96.00	61
TD27 T	Diesel	2664	4	96.00	61
TKA	Petrol	957	4	74.00	7
TKB	Petrol	957	4	74.00	7
TKW	Petrol	957	4	74.00	7
TLA	Petrol	957	4	74.00	7
TLB	Petrol	999	4	68.70	1
TZJA (Duratorq)	Diesel	1560	4	75.00	9
TZJB (Duratorq)	Diesel	1560	4	75.00	9
UBJA (Duratorq)	Diesel	1560	4	75.00	8
UEJB (Euro 5 Duratec)	Petrol	1498	4	79.00	16
UGCA (Duratorq)	Diesel	1499	4	73.50	3
UGCB (Duratorq)	Diesel	1499	4	73.50	3
UGJC	Diesel	1499	4	73.50	3
UGJE (Duratorq)	Diesel	1499	4	73.50	3
UHFA (Duratorq)	Diesel	2198	4	86.00	36
UHFB (Duratorq)	Diesel	2198	4	86.00	36
UHFC (Duratorq)	Diesel	2198	4	86.00	36
UKDA (Duratorq)	Diesel	1997	4	85.00	32
UNCA (EcoBoost)	Petrol	1499	4	79.00	11
UNCB (EcoBoost)	Petrol	1499	4	79.00	11
UNCC (EcoBoost)	Petrol	1499	4	79.00	11
UNCD (EcoBoost)	Petrol	1499	4	79.00	11
UNCE (EcoBoost)	Petrol	1499	4	79.00	11
UNCF (EcoBoost)	Petrol	1499	4	79.00	11
UNCG (EcoBoost)	Petrol	1499	4	79.00	11
UNCH (EcoBoost)	Petrol	1499	4	79.00	11
UNCI (EcoBoost)	Petrol	1499	4	79.00	11
UNCJ (EcoBoost)	Petrol	1499	4	79.00	11
UNCK (EcoBoost)	Petrol	1498	4	79.00	11
UNCM (EcoBoost)	Petrol	1498	4	79.00	11
UNCN (Euro 6 EcoBoost)	Petrol	1499	4	79.00	11
USR6 (Duratorq)	Diesel	2198	4	86.00	36
USRA (Duratorq)	Diesel	2198	4	86.00	36
USRB (Duratorq)	Diesel	2198	4	86.00	36
UYR6 (Duratorq)	Diesel	2198	4	86.00	35
WTA (XD90)	Diesel	2112	V4	90.00	50

ENGINE INDEX

Motorverzeichnis • Index de moteur • Índice de Motor
 Indeks silnika • Модель Двигателя • دليل المحرك

CCM
x

9

XD2S	Diesel	2304	4	94.00	58
XD3P	Diesel	2497	4	94.00	58
XD3T	Diesel	2497	4	94.00	58
XD/P88	Diesel	1948	4	88.00	41
XMJA (EcoBoost)	Petrol	998	3	71.90	2
XMJB (EcoBoost)	Petrol	998	3	71.90	2
XUCA (Duratorq)	Diesel	1499	4	73.50	3
XUCC (Duratorq)	Diesel	1499	4	73.50	3
XUCD (Duratorq)	Diesel	1499	4	73.50	3
XUJA (Euro 6 Duratorq)	Diesel	1499	4	73.50	3
XUJB (Euro 6 Duratorq)	Diesel	1499	4	73.50	3
XUJC (Euro 6 Duratorq)	Diesel	1499	4	73.50	3
XVCA (Duratorq)	Diesel	1499	4	73.50	3
XVCB (Duratorq)	Diesel	1499	4	73.50	3
XVCC (Duratorq)	Diesel	1499	4	73.50	3
XVJA (Duratorq)	Diesel	1499	4	73.50	3
XVJB (Duratorq)	Diesel	1499	4	73.50	3
XVJC (Duratorq)	Diesel	1499	4	73.50	3
XVJD (Duratorq)	Diesel	1499	4	73.50	3
XWCA (Euro 6 Duratorq)	Diesel	1499	4	73.50	3
XWCB (Euro 6 Duratorq)	Diesel	1499	4	73.50	3
XWJA (Euro 5 Duratorq)	Diesel	1499	4	73.50	3
XXGA (Euro 6 Duratorq)	Diesel	1499	4	73.50	3
Y5A	Petrol	2295	4	89.60	42
Y5B	Petrol	2295	4	89.60	42
YMFA (Euro 6 EcoBlue)	Diesel	1996	4	84.01	30
YMFB (Euro 6 EcoBlue)	Diesel	1996	4	84.01	30
YMHA (EcoBlue)	Diesel	1996	4	84.01	30
YMRA (EcoBlue)	Diesel	1996	4	84.01	30
YTR (XD2/XD2P/XD94)	Diesel	2304	4	94.00	60
YTT (XD2/XD2P/XD94)	Diesel	2304	4	94.00	60
YYJA (EcoBoost)	Petrol	998	3	71.90	2
YYJB (EcoBoost)	Petrol	998	3	71.90	2
YYJC (EcoBoost)	Petrol	998	3	71.90	2
YYJD (EcoBoost)	Petrol	998	3	71.90	2
ZH10JRB	Petrol	999	4	68.70	1



68.70

1

GUD	4cyl.	1119cc	40kW (55PS)	Petrol	TD1209
GUE	4cyl.	1119cc	40kW (55PS)	Petrol	TD1210
TLB	4cyl.	999cc	33kW (45PS)	Petrol	TD1454
ZH10JRB	4cyl.	999cc	38kW (52PS)	Petrol	TD24108
FIESTA 1.1			04/89→12/92	FIESTA III 1.1	03/89→12/95
FIESTA Body/MPV 1.0			04/89→12/91	FIESTA IV 1.0 i	04/96→09/99
FIESTA III 1.0			03/89→12/95	KA 1.0 i	07/97→09/99

87-784107-00 0.50mm

08-784100-00 STD

08-784107-00 0.50mm

A 29.40
D 53.90
18x59

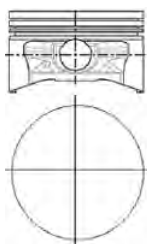

1.50 MO P
1.75 P
3.00 CR

Steel

Stahl

Acier

Acero

Acciaio

71.90

2

M1CA (EcoBoost)	3cyl.	998cc	92kW (125PS)	Petrol	Turbo Intercooled	TD30757
M1CB (EcoBoost)	3cyl.	998cc	92kW (125PS)	Petrol	Turbo Intercooled	TD30758
M1DA (Euro 5 EcoBoost)	3cyl.	998cc	92kW (125PS)	Petrol	Turbo Intercooled	TD26478
M1JA (EcoBoost)	3cyl.	998cc	88kW (120PS)	Petrol	Turbo Intercooled	TD28068
M1JC (Euro 5 EcoBoost)	3cyl.	998cc	92kW (125PS)	Petrol	Turbo Intercooled	TD29434
M1JE (EcoBoost)	3cyl.	998cc	92kW (125PS)	Petrol	Turbo Intercooled	TD27831
M1JH (EcoBoost)	3cyl.	998cc	92kW (125PS)	Petrol	Turbo Intercooled	TD32762
M2DA (Euro 5 EcoBoost)	3cyl.	998cc	74kW (100PS)	Petrol	Turbo Intercooled	TD26479
M2GA (Euro 5 EcoBoost)	3cyl.	998cc	74kW (100PS)	Petrol	Turbo Intercooled	TD28261
M2GB (Euro 6 EcoBoost)	3cyl.	998cc	74kW (100PS)	Petrol	Turbo Intercooled	TD31109
SFCA (EcoBoost)	3cyl.	998cc	74kW (100PS)	Petrol	Turbo Intercooled	TD29694
SFCB (EcoBoost)	3cyl.	998cc	74kW (100PS)	Petrol	Turbo Intercooled	TD29695
SFCC (EcoBoost)	3cyl.	998cc	74kW (100PS)	Petrol	Turbo Intercooled	TD31101
SFCD (EcoBoost)	3cyl.	998cc	74kW (100PS)	Petrol	Turbo Intercooled	TD31102
SFDA (Euro 5 EcoBoost)	3cyl.	998cc	74kW (100PS)	Petrol	Turbo Intercooled	TD30309
SFJA (EcoBoost)	3cyl.	998cc	74kW (101PS)	Petrol	Turbo Intercooled	TD27833
SFJB (EcoBoost)	3cyl.	998cc	74kW (101PS)	Petrol	Turbo Intercooled	TD27834
SFJC (EcoBoost)	3cyl.	998cc	74kW (100PS)	Petrol	Turbo Intercooled	TD31015
SFJD (EcoBoost)	3cyl.	998cc	74kW (100PS)	Petrol	Turbo Intercooled	TD31016
XMJA (EcoBoost)	3cyl.	998cc	48kW (65PS)	Petrol	Turbo Intercooled	TD27835
XMJB (EcoBoost)	3cyl.	998cc	48kW (65PS)	Petrol	Turbo Intercooled	TD27836
YYJA (EcoBoost)	3cyl.	998cc	103kW (140PS)	Petrol	Turbo Intercooled	TD31077
YYJB (EcoBoost)	3cyl.	998cc	103kW (140PS)	Petrol	Turbo Intercooled	TD31078
YYJC (EcoBoost)	3cyl.	998cc	103kW (140PS)	Petrol	Turbo Intercooled	TD32680
YYJD (EcoBoost)	3cyl.	998cc	103kW (140PS)	Petrol	Turbo Intercooled	TD32681
B-MAX 1.0			08/12→	MONDEO V 1.0		02/15→
C-MAX II 1.0			10/12→06/19	TOURNEO CONNECT / GRAND TOURNEO CONNECT V408 MPV 1.0		11/13→
ECOSPORT 1.0			10/13→	TOURNEO COURIER B460 MPV 1.0		02/14→
FIESTA 1.0			09/13→	TRANSIT CONNECT V408 Body/MPV 1.0		02/13→
FIESTA VI 1.0			09/12→	TRANSIT COURIER B460 Body/MPV 1.0		02/14→
FOCUS III 1.0			02/12→	TRANSIT COURIER B460 MPV 1.0		02/14→
GRAND C-MAX 1.0			10/12→06/19			





87-424300-00 STD
87-424307-00 0.50mm

08-424300-00 STD
08-424307-00 0.50mm

A 32.80
BØ 43.00
D 50.80
E 20x47



1.00 PVD P
1.20 P
2.00 NT

AK TP

Steel Stahl Acier Acero Acciaio

73.50 **3**

AEDA (Duratorq)	4cyl.	1499cc	77kW (105PS)	Diesel	Turbo Intercooled	TD31018
UGCA (Duratorq)	4cyl.	1499cc	55kW (75PS)	Diesel	Turbo Intercooled	TD30776
UGCB (Duratorq)	4cyl.	1499cc	55kW (75PS)	Diesel	Turbo Intercooled	TD30777
UGJC	4cyl.	1499cc	55kW (75PS)	Diesel	Turbo Intercooled	TD27839
UGJE (Duratorq)	4cyl.	1499cc	66-67kW (90-91PS)	Diesel	Turbo Intercooled	TD29437
XUCA (Duratorq)	4cyl.	1499cc	88kW (120PS)	Diesel	Turbo Intercooled	TD31063
XUCC (Duratorq)	4cyl.	1499cc	55kW (75PS)	Diesel	Turbo Intercooled	TD31103
XUCD (Duratorq)	4cyl.	1499cc	55kW (75PS)	Diesel	Turbo Intercooled	TD31104
XUJA (Euro 6 Duratorq)	4cyl.	1499cc	55kW (75PS)	Diesel	Turbo Intercooled	TD33196
XUJB (Euro 6 Duratorq)	4cyl.	1499cc	55kW (75PS)	Diesel	Turbo Intercooled	TD33197
XUJC (Euro 6 Duratorq)	4cyl.	1499cc	63kW (86PS)	Diesel	Turbo Intercooled	TD35275
XVCA (Duratorq)	4cyl.	1499cc	70kW (95PS)	Diesel	Turbo Intercooled	TD31105
XVCB (Duratorq)	4cyl.	1499cc	70kW (95PS)	Diesel	Turbo Intercooled	TD31106
XVCC (Duratorq)	4cyl.	1499cc	70kW (95PS)	Diesel	Turbo Intercooled	TD31107
XVJA (Duratorq)	4cyl.	1499cc	70kW (95PS)	Diesel	Turbo Intercooled	TD31073
XVJB (Duratorq)	4cyl.	1499cc	70kW (95PS)	Diesel	Turbo Intercooled	TD31079
XVJC (Duratorq)	4cyl.	1499cc	70kW (95PS)	Diesel	Turbo Intercooled	TD31074
XVJD (Duratorq)	4cyl.	1499cc	70kW (95PS)	Diesel	Turbo Intercooled	TD31333
XWCA (Euro 6 Duratorq)	4cyl.	1499cc	55kW (75PS)	Diesel	Turbo Intercooled	TD35923
XWCB (Euro 6 Duratorq)	4cyl.	1499cc	55kW (75PS)	Diesel	Turbo Intercooled	TD35924
XWJA (Euro 5 Duratorq)	4cyl.	1499cc	88kW (120PS)	Diesel	Turbo Intercooled	TD35280
XXGA (Euro 6 Duratorq)	4cyl.	1499cc	70-74kW (95-101PS)	Diesel	Turbo Intercooled	TD33184

B-MAX 1.5 TDCi	10/12→	MONDEO V 1.5 TDCi	03/15→
C-MAX II 1.5 TDCi	03/15→06/19	TOURNEO CONNECT / GRAND TOURNEO CONNECT V408 MPV 1.5 TDCi	05/15→
ECOSPORT 1.5 EcoBlue TDCi	05/15→	TOURNEO COURIER B460 MPV 1.5 TDCi	02/14→
ECOSPORT 1.5 TDCi	10/12→	TRANSIT CONNECT V408 Body/MPV 1.5 TDCi	05/15→
FIESTA VI 1.5 TDCi	09/12→	TRANSIT CONNECT MPV 1.5 TDCi	05/15→
FIESTA VII 1.5 TDCi	05/17→	TRANSIT COURIER B460 Body/MPV 1.5 TDCi	02/14→
FOCUS III 1.5 TDCi	09/14→	TRANSIT COURIER B460 MPV 1.5 TDCi	02/14→

87-452400-00 STD
87-452407-00 0.50mm

08-452400-00 STD
08-452407-00 0.50mm

A 41.70
B- 13.40
BØ 45.00
D 65.20
E 26x59



2.00 CK
1.95 P
2.00 CR

AK KK RT TP



73.70 **4**

F6JA (DV4TD)	4cyl.	1399cc	50-51kW (68-69PS)	Diesel	Turbo Intercooled	TD17307
F6JB (DV4TD)	4cyl.	1399cc	50kW (68PS)	Diesel	Turbo Intercooled	TD17346
FIESTA V 1.4 TDCi			11/01→12/10	FUSION 1.4 TDCi		08/02→12/12
FIESTA VI 1.4 TDCi			08/08→			

87-135300-00 *STD*
87-135307-00 *0.50mm*

- A 42.94
- B- 14.70
- BØ 37.16
- C 1.55
- D 65.44
-  25x60

AK RT TP



08-135300-00 *STD*
08-135305-00 *0.25mm*
08-135307-00 *0.50mm*

- 2.50  CK P
- 1.95  P
- 2.50  CR P

14-020760-00 *D*
14-020761-00 *D*

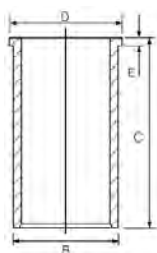

B 76.95 C 136.00 D 78.45 E 5.25
B 76.95 C 136.00 D 78.45 E 5.25

74.00 **5**

A9A	4cyl.	1299cc	51kW (70PS)	Petrol	TD18764
A9B	4cyl.	1299cc	51kW (70PS)	Petrol	TD18765
KA 1.3			09/02→03/04	KA 1.3 i ROCAM	08/02→11/08

87-449000-00 *STD*
87-449007-00 *0.50mm*

- A 24.90
- B- 2.80
- BØ 35.00
- D 48.90
-  18x54



08-449000-00 *STD*
08-449007-00 *0.50mm*

- 1.20  CR P
- 1.50  P
- 2.00  CR P

74.00 **6**

BAA	4cyl.	1299cc	44kW (60PS)	Petrol	TD17169
J4C (Endura)	4cyl.	1299cc	44kW (60PS)	Petrol	TD11087
J4D (Endura)	4cyl.	1299cc	44kW (60PS)	Petrol	TD12084
J4J (Endura)	4cyl.	1299cc	44kW (60PS)	Petrol	TD12073
J4K (Endura)	4cyl.	1299cc	44kW (60PS)	Petrol	TD12085
J4L (Endura)	4cyl.	1299cc	44kW (60PS)	Petrol	TD15930
J4M (Endura)	4cyl.	1299cc	44kW (60PS)	Petrol	TD15952
J4N (Endura)	4cyl.	1299cc	44kW (60PS)	Petrol	TD15953
J4P (Endura)	4cyl.	1299cc	44kW (60PS)	Petrol	TD15954
J4Q (Endura)	4cyl.	1299cc	44kW (60PS)	Petrol	TD15931
J4R (Endura)	4cyl.	1299cc	44kW (60PS)	Petrol	TD15932
J4S (Endura)	4cyl.	1299cc	44kW (60PS)	Petrol	TD15955
J4T (Endura)	4cyl.	1299cc	44kW (60PS)	Petrol	TD15933
JBA	4cyl.	1297cc	44-46kW (60-63PS)	Petrol	TD1227
JBB	4cyl.	1297cc	44kW (60PS)	Petrol	TD4459
JBC	4cyl.	1299cc	44kW (60PS)	Petrol	TD1229
JBD	4cyl.	1297cc	46kW (63PS)	Petrol	TD1230
JJA (Endura)	4cyl.	1299cc	37kW (50PS)	Petrol	TD12071
JJB (Endura)	4cyl.	1299cc	37kW (50PS)	Petrol	TD12083
JJC (Endura)	4cyl.	1299cc	37kW (50PS)	Petrol	TD12072
JJD (Endura)	4cyl.	1299cc	36kW (49PS)	Petrol	TD12082





JJE (Endura)	4cyl.	1299cc	37kW (50PS)	Petrol	TD15926
JJF (Endura)	4cyl.	1299cc	36kW (49PS)	Petrol	TD15948
JJG (Endura)	4cyl.	1299cc	36kW (49PS)	Petrol	TD15949
JJH (Endura)	4cyl.	1299cc	36kW (49PS)	Petrol	TD15950
JJJ (Endura)	4cyl.	1299cc	37kW (50PS)	Petrol	TD15927
JJK (Endura)	4cyl.	1299cc	37kW (50PS)	Petrol	TD15928
JJL (Endura)	4cyl.	1299cc	36kW (49PS)	Petrol	TD15951
JJM (Endura)	4cyl.	1299cc	37kW (50PS)	Petrol	TD15929
JLB	4cyl.	1297cc	44kW (60PS)	Petrol	TD1237

ESCORT IV 1.3	01/86→10/90	FIESTA III 1.3	03/89→12/95
ESCORT IV Express 1.3	02/86→07/90	FIESTA IV 1.3 i	08/95→01/02
ESCORT V Express 1.3	07/90→12/94	KA 1.3 i	09/96→11/08
FIESTA Body/MPV 1.3	02/96→08/03	ORION II 1.3	12/85→07/90

87-785000-00 STD
87-785007-00 0.50mm
87-785011-00 1.00mm

08-785000-00 STD
08-785007-00 0.50mm
08-785011-00 1.00mm

A 29.40
D 53.90
 18x64



1.50 CR P
 1.75 P
 3.00 CR T

Steel Stahl Acier Acero Acciaio

74.00 **7**

GLC	4cyl.	1117cc	37kW (50PS)	Petrol	TD1198
GSE	4cyl.	1117cc	37-40kW (50-55PS)	Petrol	TD1203
GSF	4cyl.	1117cc	37kW (50PS)	Petrol	TD1204
GSG	4cyl.	1117cc	37kW (50PS)	Petrol	TD1205
TKA	4cyl.	957cc	29kW (40PS)	Petrol	TD4495
TKB	4cyl.	957cc	33kW (45PS)	Petrol	TD1452
TKW	4cyl.	957cc	29kW (40PS)	Petrol	TD4496
TLA	4cyl.	957cc	33kW (45PS)	Petrol	TD1453

ESCORT III 1.1	08/83→12/85	FIESTA I 0.9	05/76→08/83
ESCORT IV 1.1	10/85→09/90	FIESTA II 1.0	09/83→02/89
ESCORT IV Express 1.1	05/86→07/90	FIESTA II 1.1	09/83→02/89
FIESTA 1.0	10/77→11/89		

14-010830-00 D **B 77.16 C 119.61**

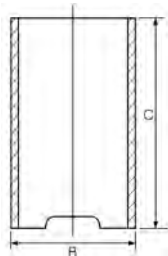

75.00 **8**

G8DA	4cyl.	1560cc	80kW (109PS)	Diesel	Turbo Intercooled	TD18508
G8DB	4cyl.	1560cc	80kW (109PS)	Diesel	Turbo Intercooled	TD18509
G8DD	4cyl.	1560cc	80kW (109PS)	Diesel	Turbo Intercooled	TD24351





G8DE	4cyl.	1560cc	80kW (109PS)	Diesel	Turbo Intercooled	TD25790
G8DF	4cyl.	1560cc	80kW (109PS)	Diesel	Turbo Intercooled	TD25791
GPDA (Euro 4)	4cyl.	1560cc	66kW (90PS)	Diesel	Turbo Intercooled	TD24348
GPDC (Euro 4)	4cyl.	1560cc	66kW (90PS)	Diesel	Turbo Intercooled	TD24660
HHDA (Euro 4)	4cyl.	1560cc	66kW (90PS)	Diesel	Turbo Intercooled	TD18478
HHDB (Euro 4)	4cyl.	1560cc	66kW (90PS)	Diesel	Turbo Intercooled	TD18479
HHJA	4cyl.	1560cc	66kW (90PS)	Diesel	Turbo Intercooled	TD17988
HHJB	4cyl.	1560cc	66kW (90PS)	Diesel	Turbo Intercooled	TD17989
HHJC (Duratorq)	4cyl.	1560cc	66kW (90PS)	Diesel	Turbo Intercooled	TD24416
HHJD (Duratorq)	4cyl.	1560cc	66kW (90PS)	Diesel	Turbo Intercooled	TD23543
HHJE (Duratorq)	4cyl.	1560cc	66kW (90PS)	Diesel	Turbo Intercooled	TD24417
HHJF (Duratorq)	4cyl.	1560cc	55kW (75PS)	Diesel	Turbo Intercooled	TD24418
UBJA (Duratorq)	4cyl.	1560cc	55kW (75PS)	Diesel	Turbo Intercooled	TD24419
C-MAX 1.6 TDCi			02/07→09/10	FOCUS C-MAX 1.6 TDCi		10/03→03/07
FIESTA 1.6 TDCi			10/10→	FOCUS II 1.6 TDCi		07/04→09/12
FIESTA V 1.6 TDCi			11/04→09/09	FUSION 1.6 TDCi		11/04→12/12
FIESTA VI 1.6 TDCi			06/08→			

87-424000-00 STD
87-424008-00 0.60mm

- A 41.70
- B- 13.25
- Bø 41.80
- C 1.20
- D 65.30
- 26x61



AK KK RT TP

08-424000-00 STD
08-424007-00 0.50mm
08-424008-00 0.60mm

- 3.00 CK P
- 1.95 P
- 2.50 CR P

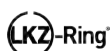

14-020900-00 D

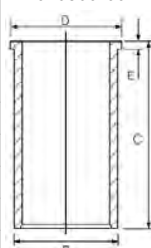

B 78.00 C 142.00 D 79.50 F 5.00

75.00

9

T1DA (Duratorq)	4cyl.	1560cc	85kW (115PS)	Diesel	Turbo Intercooled	TD25883
T1DB (Duratorq)	4cyl.	1560cc	85kW (115PS)	Diesel	Turbo Intercooled	TD25884
T3DA (Duratorq)	4cyl.	1560cc	70kW (95PS)	Diesel	Turbo Intercooled	TD25881
T3DB (Duratorq)	4cyl.	1560cc	70kW (95PS)	Diesel	Turbo Intercooled	TD25882
T3JA (Duratorq)	4cyl.	1560cc	70kW (95PS)	Diesel	Turbo Intercooled	TD26473
T3JB	4cyl.	1560cc	70kW (95PS)	Diesel	Turbo Intercooled	TD28069
TZJA (Duratorq)	4cyl.	1560cc	70kW (95PS)	Diesel	Turbo Intercooled	TD24420
TZJB (Duratorq)	4cyl.	1560cc	70kW (95PS)	Diesel	Turbo Intercooled	TD24421
B-MAX 1.6 TDCi			10/12→	FIESTA VI 1.6 TDCi		02/10→
C-MAX II 1.6 TDCi			12/10→06/19	FOCUS III 1.6 TDCi		07/10→
FIESTA 1.6 TDCi			02/10→12/10	GRAND C-MAX 1.6 TDCi		12/10→06/19

87-433600-00 STD
87-433607-00 0.50mm

- A 41.75
- B- 13.85
- Bø 45.00
- D 65.20
- 26x61



AK KK RT TP

08-433600-00 STD
08-433607-00 0.50mm

- 2.50 CK P
- 1.95 P
- 2.00 CR P

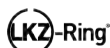

14-020900-00 D

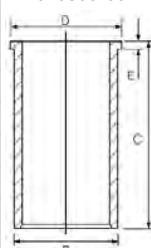

B 78.00 C 142.00 D 79.50 F 5.00

76.00

10

ASDA	4cyl.	1388cc	59kW (80PS)	Petrol		TD18501
-------------	-------	---------------	--------------------	---------------	--	----------------





ASDB	4cyl.	1388cc	59kW (80PS)	Petrol	TD18502
FXDA (Zetec)	4cyl.	1388cc	55kW (75PS)	Petrol	TD12075
FXDB (Zetec)	4cyl.	1388cc	55kW (75PS)	Petrol	TD15892
FXDC (Zetec)	4cyl.	1388cc	55kW (75PS)	Petrol	TD12076
FXDD (Zetec)	4cyl.	1388cc	55kW (75PS)	Petrol	TD15893
FXJA	4cyl.	1388cc	59-62kW (80-84PS)	Petrol	TD17304
FXJB	4cyl.	1388cc	59-62kW (80-84PS)	Petrol	TD17305
FIESTA V 1.4			05/02→09/05	FOCUS I 1.4 16V	10/98→11/04
FIESTA V 1.4 16V			11/01→06/08	FOCUS II 1.4	07/04→09/12
FOCUS I 1.4			04/99→03/05	FUSION 1.4	08/02→12/12

87-426100-00 STD
87-426107-00 0.50mm

08-426100-00 STD
08-426107-00 0.50mm

A 28.25
B+ 1.25
D 55.50
 19x50



1.20 NT
 1.50 P
 2.50 NT

Elastoval®
 Steel

Stahl

Acier

Acero

Acciaio

79.00

11

BNMA (EcoBoost)	4cyl.	1499cc	88kW (120PS)	Petrol	Turbo Intercooled	TD33187
M8DA (EcoBoost)	4cyl.	1498cc	110kW (150PS)	Petrol	Turbo Intercooled	TD29721
M8DB (EcoBoost)	4cyl.	1498cc	110kW (150PS)	Petrol	Turbo Intercooled	TD29722
M8DD (EcoBoost)	4cyl.	1498cc	110kW (150PS)	Petrol	Turbo Intercooled	TD39491
M8DE (EcoBoost)	4cyl.	1498cc	110kW (150PS)	Petrol	Turbo Intercooled	TD39492
M8MA (EcoBoost)	4cyl.	1499cc	110kW (150PS)	Petrol	Turbo Intercooled	TD31331
M8MB (EcoBoost)	4cyl.	1499cc	110kW (150PS)	Petrol	Turbo Intercooled	TD33185
M9DA (EcoBoost)	4cyl.	1498cc	132-134kW (179-182PS)	Petrol	Turbo Intercooled	TD29723
M9DB (EcoBoost)	4cyl.	1498cc	132-134kW (179-182PS)	Petrol	Turbo Intercooled	TD29724
M9DG (EcoBoost)	4cyl.	1498cc	134kW (182PS)	Petrol	Turbo Intercooled	TD33170
M9DH (EcoBoost)	4cyl.	1498cc	134kW (182PS)	Petrol	Turbo Intercooled	TD33171
M9MA (EcoBoost)	4cyl.	1499cc	132-134kW (182PS)	Petrol	Turbo Intercooled	TD31332
M9MC (EcoBoost)	4cyl.	1499cc	134kW (182PS)	Petrol	Turbo Intercooled	TD33186
UNCA (EcoBoost)	4cyl.	1499cc	118kW (160PS)	Petrol	Turbo Intercooled	TD30530
UNCB (EcoBoost)	4cyl.	1499cc	118kW (160PS)	Petrol	Turbo Intercooled	TD30531
UNCC (EcoBoost)	4cyl.	1499cc	110kW (149PS)	Petrol	Turbo Intercooled	TD30534
UNCD (EcoBoost)	4cyl.	1499cc	110kW (150PS)	Petrol	Turbo Intercooled	TD30535
UNCE (EcoBoost)	4cyl.	1499cc	118kW (160PS)	Petrol	Turbo Intercooled	TD30532
UNCF (EcoBoost)	4cyl.	1499cc	118kW (160PS)	Petrol	Turbo Intercooled	TD30533
UNCG (EcoBoost)	4cyl.	1499cc	132kW (180PS)	Petrol	Turbo Intercooled	TD33198
UNCH (EcoBoost)	4cyl.	1499cc	132kW (180PS)	Petrol	Turbo Intercooled	TD33199
UNCI (EcoBoost)	4cyl.	1499cc	118kW (160PS)	Petrol	Turbo Intercooled	TD31082
UNCJ (EcoBoost)	4cyl.	1499cc	118kW (160PS)	Petrol	Turbo Intercooled	TD31083
UNCK (EcoBoost)	4cyl.	1498cc	118kW (160PS)	Petrol	Turbo Intercooled	TD31084
UNCM (EcoBoost)	4cyl.	1498cc	118kW (160PS)	Petrol	Turbo Intercooled	TD33200
UNCN (Euro 6 EcoBoost)	4cyl.	1499cc	121kW (165PS)	Petrol	Turbo Intercooled	TD35994
C-MAX II 1.5			03/15→06/19	KUGA II 1.5		09/14→
FOCUS III 1.5			09/14→	KUGA II VAN 1.5		09/14→





GALAXY III 1.5	01/15→06/18	MONDEO V 1.5	09/14→
GRAND C-MAX 1.5	03/15→06/19	S-MAX 1.5	01/15→06/18

87-452800-10 STD
87-452807-10 0.50mm

- A 34.85
- B- 9.30
- BØ 53.50
- C 3.53
- C 3.47
- D 53.90
- TP 21x49



08-452800-10 STD ①
08-452807-10 0.50mm ①

- 1.20 PVD P ②
- 1.20 P
- 2.00 NT ②



① Later engine, check ring thickness

① Späterer Motor, Ringdicke prüfen

① Moteur ultérieur, vérifier l'épaisseur du segment

① Motor posterior, comprobar espesor segmentos

① Motore successivo, controllare spessore segmento

② Steel

② Stahl

② Acier

② Acero

② Acciaio

79.00

12

FYDA (Zetec)	4cyl.	1596cc	74-75kW (100-102PS)	Petrol	TD12077
FYDB (Zetec)	4cyl.	1596cc	74kW (100PS)	Petrol	TD15894
FYDC (Zetec)	4cyl.	1596cc	74kW (100PS)	Petrol	TD12078
FYDD (Zetec)	4cyl.	1596cc	74kW (100PS)	Petrol	TD15895
FYDH (Zetec)	4cyl.	1596cc	74-75kW (100-102PS)	Petrol	TD18776
FYJA (Duratec)	4cyl.	1596cc	74kW (100PS)	Petrol	TD17306
FYJB (Duratec)	4cyl.	1596cc	74kW (100PS)	Petrol	TD18778

COURIER 1.6	08/01→12/11	FOCUS I 1.6 16V	10/98→11/04
FIESTA V 1.6 16V	11/01→06/08	FUSION 1.6	08/02→11/09
FOCUS I 1.6	04/99→06/07		

87-141300-00 STD ①
87-141307-00 0.50mm ①
→01/03

- A 25.05
- D 48.10
- TP 18x50



08-141300-00 STD
08-141307-00 0.50mm

- 1.20 NT ②
- 1.50 P
- 2.00 CR ②



87-141300-10 STD
87-141307-10 0.50mm
01/03→

- A 25.50
- B- 0.65
- BØ 57.30
- D 48.05
- TP 18x51



08-141300-10 STD
08-141307-10 0.50mm

- 1.20 PVD P ②
- 1.50 P
- 2.00 NT ②



① Elastoval ©

② Steel

② Stahl

② Acier

② Acero

② Acciaio

79.00

13

FYJA	4cyl.	1596cc	74kW (100PS)	Petrol	TD23730
-------------	-------	---------------	---------------------	---------------	----------------





L1V (Zetec)	4cyl.	1596cc	70-76kW (95-103PS)	Petrol	TD15936
L1T (Zetec)	4cyl.	1596cc	76kW (103PS)	Petrol	TD15935
L1W (Zetec-SE)	4cyl.	1596cc	76kW (103PS)	Petrol	TD18770
FIESTA 1.6 i			04/04→12/08	FIESTA IV 1.6 16V	02/00→01/02
FIESTA IV 1.6			06/00→06/02	PUMA 1.6 16V	08/00→06/02

87-141300-00 STD 1
87-141307-00 0.50mm 1

08-141300-00 STD
08-141307-00 0.50mm

A 25.05
D 48.10
 18x50



1.20 NT 2
 1.50 P
 2.00 CR 2

1 Elastoval®
2 Steel

2 Stahl

2 Acier

2 Acero

2 Acciaio

79.00					14
HWDA (Duratec)	4cyl.	1596cc	74kW (100PS)	Petrol	TD18503
HWDB (Duratec)	4cyl.	1596cc	74kW (100PS)	Petrol	TD18504
HXDA (Duratec)	4cyl.	1596cc	85kW (115PS)	Petrol	TD18505
HXDB (Duratec)	4cyl.	1596cc	85kW (115PS)	Petrol	TD23365
PNBA (Duratec)	4cyl.	1596cc	92kW (125PS)	Petrol	TD23302
SHDA (Duratec Ti-VCT)	4cyl.	1596cc	74kW (101PS)	Petrol	TD21247
SHDB (Duratec Ti-VCT)	4cyl.	1596cc	74kW (101PS)	Petrol	TD24345
SHDC (Duratec Ti-VCT)	4cyl.	1596cc	74kW (101PS)	Petrol	TD24346
SIDA (Duratec)	4cyl.	1596cc	85kW (115PS)	Petrol	TD23366
C-MAX 1.6			02/07→09/10	FOCUS II 1.6 LPG	10/09→09/12
FOCUS C-MAX 1.6			10/03→03/07	FOCUS II 1.6 Ti	07/04→09/12
FOCUS C-MAX 1.6 Ti			08/04→03/07	FOCUS II 1.6 Ti-VCT	09/05→07/11
FOCUS II 1.6			07/04→09/12	MONDEO IV 1.6 Ti	03/07→01/15

87-141300-20 STD
87-141307-20 0.50mm
 01/07→

08-141300-10 STD
08-141307-10 0.50mm

A 25.40
B- 0.70
BØ 50.90
C 3.80
C 2.76
D 53.40
 18x51



1.20 PVD P 1
 1.50 P
 2.00 NT 1

1 Steel

1 Stahl

1 Acier

1 Acero

1 Acciaio

79.00					15	
JQDA (EcoBoost)	4cyl.	1596cc	110kW (150PS)	Petrol	Turbo Intercooled	TD25877
JQDB (EcoBoost)	4cyl.	1596cc	110kW (150PS)	Petrol	Turbo Intercooled	TD25878
JQMA (EcoBoost)	4cyl.	1596cc	110kW (150PS)	Petrol	Turbo Intercooled	TD29490
JQMB (EcoBoost)	4cyl.	1596cc	110kW (150PS)	Petrol	Turbo Intercooled	TD29491
JTDA (EcoBoost)	4cyl.	1596cc	134kW (182PS)	Petrol	Turbo Intercooled	TD25879
JTDB (EcoBoost)	4cyl.	1596cc	134kW (182PS)	Petrol	Turbo Intercooled	TD25880
JTMA (EcoBoost)	4cyl.	1596cc	130-134kW (179-182PS)	Petrol	Turbo Intercooled	TD29492
JTWA	4cyl.	1596cc	118kW (160PS)	Petrol	Turbo Intercooled	TD28065





JTWS	4cyl.	1596cc	118kW (160PS)	Petrol	Turbo Intercooled	TD28066
C-MAX II 1.6			12/10→06/19	GRAND C-MAX 1.6		12/10→06/19
FOCUS III 1.6			07/10→	KUGA II 1.6		10/12→
GALAXY II 1.6			11/10→06/15	S-MAX 1.6		02/11→12/14
GALAXY MK II VAN			02/11→06/15	S-MAX VAN 1.6		02/11→12/14

87-452800-30 STD
87-452807-30 0.50mm

08-452800-10 STD ①
08-452807-10 0.50mm ①

A 35.00
B- 11.50
BØ 53.70
C 3.43
C 2.67
D 54.00
21x49



1.20 PVD P ②
1.20 P
2.00 NT ②



TP

① Later engine, check ring thickness ① Späterer Motor, Ringdicke prüfen ① Moteur ultérieur, vérifier l'épaisseur du segment ① Motor posterior, comprobar espesor segmentos ① Motore successivo, controllare spessore segmento

② Steel ② Stahl ② Acier ② Acero ② Acciaio

79.00

16

UEJB (Euro 5 Duratec)	4cyl.	1498cc	77-82kW (105-111PS)	Petrol	TD29435
ECOSPORT 1.5 Ti			10/13→	KA+ III 1.5	09/15→

87-424400-00 STD
87-424407-00 0.50mm

08-424400-00 STD
08-424407-00 0.50mm

A 27.55
B+ 1.25
C 4.66
C 3.12
D 47.80
19x55



1.20 PVD P ①
1.50 P
2.00 NT ①



AK HA TP

① Steel ① Stahl ① Acier ① Acero ① Acciaio

79.37

17

4.108	4cyl.	1760cc		Diesel	MP1346-1
TRANSIT 1.8D			01/65→12/78		

14-010900-00 D B 82.63 C 165.10

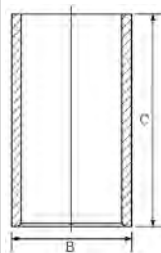

79.50

18

1Z	4cyl.	1896cc	66kW (90PS)	Diesel	Turbo Intercooled	TD11370
AFN	4cyl.	1896cc	81kW (110PS)	Diesel	Turbo Intercooled	TD11368
AHU	4cyl.	1896cc	66kW (90PS)	Diesel	Turbo Intercooled	TD11369
AVG	4cyl.	1896cc	81kW (110PS)	Diesel	Turbo Intercooled	TD17557
GALAXY I 1.9 TDi			03/95→05/06	GALAXY MK I VAN 1.9 TDi		09/96→03/06





87-114900-60 STD ① ②
87-114907-60 0.50mm ① ② ③

A 45.80
B- 17.65
BØ 38.00
C 1.10
D 68.80
 26x66

(07987)

AK KK NB RT



08-114900-00 STD
08-114907-00 0.50mm
08-114911-00 1.00mm

1.75  CK P
 2.00  P
 3.00  CR P

14-027950-00 D **B** 82.50 **C** 152.00 **D** 85.50 **E** 4.70

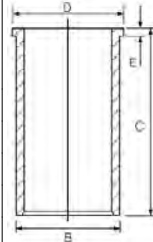

87-114900-70 STD ② ④
87-114907-70 0.50mm ② ③ ④

A 45.80
B- 17.65
BØ 38.00
C 1.10
D 68.80
 26x66

(07987A)

AK KK NB RT



08-114900-00 STD
08-114907-00 0.50mm
08-114911-00 1.00mm

1.75  CK P
 2.00  P
 3.00  CR P

87-114900-90 STD ①
87-114907-90 0.50mm ① ⑤
87-114900-95 STD ④
87-114907-95 0.50mm ④ ⑤

A 45.80
B- 17.65
BØ 38.00
C 1.10
D 71.80
 26x66

AK NB RT



08-114900-00 STD
08-114907-00 0.50mm
08-114911-00 1.00mm

1.75  CK P
 2.00  P
 3.00  CR P

- ① To cylinder 1 & 2
- ② Bowl capacity 23.54cm³
- ③ A = 45.550, D = 68.550
- ④ To cylinder 3 & 4
- ⑤ A = 45.550, D = 71.550

- ① an Zylinder 1 & 2
- ② Volumen der Kolbenmulde 23.54cm³
- ④ an Zylinder 3 & 4

- ① sur cylindre 1 & 2
- ② Volume de la cavité du piston 23.54cm³
- ④ sur cylindre 3 & 4

- ① en el cilindro 1 & 2
- ② Vol. cavidad pistón 23.54cm³
- ④ en el cilindro 3 & 4

- ① a cilindro 1 & 2
- ② Volume camera pistone 23.54cm³
- ④ a cilindro 3 & 4

79.50

19

AJM	4cyl.	1896cc	85kW (116PS)	Diesel	Turbo Intercooled	TD14108
AUY	4cyl.	1896cc	85kW (115PS)	Diesel	Turbo Intercooled	TD14918

GALAXY I 1.9 TDi 04/00→05/06 GALAXY MK I VAN 1.9 TDi 05/00→03/06

87-114900-05 STD ① ②
87-114907-05 0.50mm ① ② ③
 →09/02

A 45.80
B- 17.80
BØ 38.00
C 1.30
D 68.80
 26x66

(07969L-101)

AK KK NB RT TP



08-114900-00 STD
08-114907-00 0.50mm
08-114911-00 1.00mm

1.75  CK P
 2.00  P
 3.00  CR P

14-027950-00 D **B** 82.50 **C** 152.00 **D** 85.50 **E** 4.70

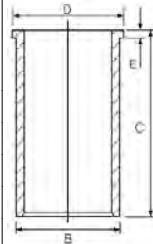



87-114900-15 STD ① ④
87-114907-15 0.50mm ① ③ ④
 →09/02

A 45.80
B- 17.80
BØ 38.00
C 1.30
D 68.80
 26x66



(07969L-102)

AK KK NB RT TP

08-114900-00 STD
08-114907-00 0.50mm
08-114911-00 1.00mm

1.75 CK P
 2.00 P
 3.00 CR P

87-114900-55 STD ② ⑤ ⑥
87-114907-55 0.50mm ② ③ ⑤
 09/02→

A 45.80
B- 17.60
BØ 38.00
C 1.10
D 68.80
 26x66



(07901D101)

AK KK NB RT TP

08-114900-00 STD
08-114907-00 0.50mm
08-114911-00 1.00mm

1.75 CK P
 2.00 P
 3.00 CR P

87-114900-56 STD ④ ⑤ ⑥
87-114907-56 0.50mm ③ ④ ⑤
 09/02→

A 45.80
B- 17.60
BØ 38.00
C 1.10
D 68.60
 26x66



(07901D102)

AK KK NB RT TP

08-114900-00 STD
08-114907-00 0.50mm
08-114911-00 1.00mm

1.75 CK P
 2.00 P
 3.00 CR P

① For side angled injection nozzle

① Nur für schräg angeordnete Einspritzdüsen

① Pour buse d'injection latérale angulaire

① Para la boquilla de inyección lateral angular

① Per il lato angolato dell'ugello olio

② To cylinder 1 & 2
 ③ A = 45.550, D = 68.550

② an Zylinder 1 & 2

② sur cylindre 1 & 2

② en el cilindro 1 & 2

② a cilindro 1 & 2

④ To cylinder 3 & 4

④ an Zylinder 3 & 4

④ sur cylindre 3 & 4

④ en el cilindro 3 & 4

④ a cilindro 3 & 4

⑤ For newer design straight injection nozzle

⑤ Für neuere Ausführungen, direkt einspritzende Düsen

⑤ Pour buse d'injection droite à conception plus récente

⑤ Para el más reciente diseño de boquilla de inyección directa

⑤ Per la più recente progettazione dell'ugello olio non ango lato

⑥ Bowl capacity 23.60cm³

⑥ Volumen der Kolbenmulde 23.60cm³

⑥ Volume de la cavité du piston 23.60cm³

⑥ Vol. cavidad pistón 23.60cm³

⑥ Volume camera pistone 23.60cm³

79.50

20

ANU	4cyl.	1896cc	66kW (90PS)	Diesel	Turbo Intercooled	TD14917
GALAXY I 1.9 TDI			03/95→05/06		GALAXY MK I VAN 1.9 Tdi	09/96→03/06





87-114900-65 STD ① ②
87-114907-65 0.50mm ① ③

A 45.80
B- 17.20
BØ 38.00
C 1.10
D 68.80
 26x66



(07901D-301)
AK KK NB RT TP

08-114900-00 STD
08-114907-00 0.50mm
08-114911-00 1.00mm

1.75  CK P
 2.00  P
 3.00  CR P

14-027950-00 D **B 82.50 C 152.00 D 85.50 E 4.70**

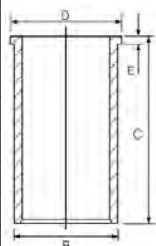

87-114900-66 STD ② ④
87-114907-66 0.50mm ③ ④

A 45.80
B- 17.20
BØ 38.00
C 1.10
D 68.80
 26x66



(07901D-302)
AK KK NB RT TP

08-114900-00 STD
08-114907-00 0.50mm
08-114911-00 1.00mm

1.75  CK P
 2.00  P
 3.00  CR P

① To cylinder 1 & 2
 ② Bowl capacity 22.85cm³
 ③ A = 45.550, D = 68.550
 ④ To cylinder 3 & 4

① an Zylinder 1 & 2
 ② Volumen der Kolbenmulde 22.85cm³
 ④ an Zylinder 3 & 4

① sur cylindre 1 & 2
 ② Volume de la cavité du piston 22.85cm³
 ④ sur cylindre 3 & 4

① en el cilindro 1 & 2
 ② Vol. cavidad pistón 22.85cm³
 ④ en el cilindro 3 & 4

① a cilindro 1 & 2
 ② Volume camera pistone 22.85cm³
 ④ a cilindro 3 & 4

79.50

21

ASZ 4cyl. **1896cc** **96kW** (130PS) **Diesel Turbo Intercooled** **TD17167**
 GALAXY I 1.9 TDI 02/03→05/06

87-114900-45 STD ① ②
87-114907-45 0.50mm ① ③

A 45.80
B- 17.50
BØ 38.00
C 1.10
D 68.80
 26x66



(07901C105)
AK KK NB RT TP

08-114900-00 STD
08-114907-00 0.50mm
08-114911-00 1.00mm

1.75  CK P
 2.00  P
 3.00  CR P

14-027950-00 D **B 82.50 C 152.00 D 85.50 E 4.70**

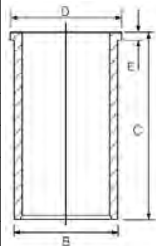

87-114900-46 STD ② ④
87-114907-46 0.50mm ③ ④

A 45.80
B- 17.50
BØ 38.00
C 1.10
D 68.80
 26x66



(07901C106)
AK KK NB RT TP

08-114900-00 STD
08-114907-00 0.50mm
08-114911-00 1.00mm

1.75  CK P
 2.00  P
 3.00  CR P

① To cylinder 1 & 2
 ② Bowl capacity 24.05cm³
 ③ A = 45.550, D = 68.550
 ④ To cylinder 3 & 4

① an Zylinder 1 & 2
 ② Volumen der Kolbenmulde 24.05cm³
 ④ an Zylinder 3 & 4

① sur cylindre 1 & 2
 ② Volume de la cavité du piston 24.05cm³
 ④ sur cylindre 3 & 4

① en el cilindro 1 & 2
 ② Vol. cavidad pistón 24.05cm³
 ④ en el cilindro 3 & 4

① a cilindro 1 & 2
 ② Volume camera pistone 24.05cm³
 ④ a cilindro 3 & 4



80.60 **22**

RDA (Zetec)	4cyl.	1796cc	77kW (105PS)	Petrol	TD1419
RDB (Zetec)	4cyl.	1796cc	77kW (105PS)	Petrol	TD1420
RKA (Zetec)	4cyl.	1796cc	85kW (115PS)	Petrol	TD4487
RKB (Zetec)	4cyl.	1796cc	82-85kW (111-116PS)	Petrol	TD12091
RKC (Zetec)	4cyl.	1796cc	85kW (115PS)	Petrol	TD5107
RKF (Zetec)	4cyl.	1796cc	85kW (115PS)	Petrol	TD12088
RKH (Zetec)	4cyl.	1796cc	85kW (115PS)	Petrol	TD15991
RKJ (Zetec)	4cyl.	1796cc	85kW (115PS)	Petrol	TD12089
RKK (Zetec)	4cyl.	1796cc	85kW (115PS)	Petrol	TD16011
RQB (Zetec)	4cyl.	1796cc	96kW (130PS)	Petrol	TD1431
RQC (Zetec)	4cyl.	1796cc	96kW (130PS)	Petrol	TD1432

COURIER 1.8	03/98→02/02	FIESTA III 1.8 16V	02/92→12/95
ESCORT V 1.8 16V	02/92→01/95	FIESTA III 1.8 XR2i 16V	02/92→12/95
ESCORT V 1.8 16V XR3i	02/92→01/95	MONDEO I 1.8	02/93→08/96
ESCORT V 1.8 i 16V	02/93→01/95	MONDEO I 1.8 i 16V	02/93→08/96
ESCORT V 1.8 XR3i 16V	08/93→01/95	MONDEO II 1.8 i	08/96→09/00
ESCORT VI 1.8 16V	01/95→02/99	ORION III 1.8 i 16V	01/92→12/93
ESCORT VI 1.8 16V XR3i	02/95→08/00	RANGER 1.8	06/99→02/02



87-136600-00 STD
87-136607-00 0.50mm
 06/99→

A 28.09
B- 1.27
BØ 65.00
C 0.88
D 52.09
 19x50

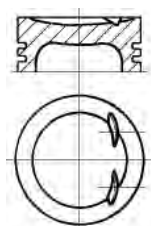
TP



08-136600-00 STD
08-136607-00 0.50mm



1.20  NT
 1.50  P
 2.50  CR

87-786500-00 STD
87-786507-00 0.50mm

A 33.20
D 57.20
 21x64



08-786500-00 STD
08-786507-00 0.50mm

1.50  MOL P
 1.60  P
 2.50  P

Steel Stahl Acier Acero Acciaio

80.98 **23**

711M	4cyl.	1599cc		Petrol	MP2361
2737E (Low compression)	4cyl.	1599cc		Petrol	MP2405
KL16L (751M)	4cyl.	1599cc		Petrol	MP2382
L3E	4cyl.	1598cc	62-71kW (84-97PS)	Petrol	TD1251
LC	4cyl.	1598cc	53-62kW (72-84PS)	Petrol	TD1261

CAPRI 1600	01/68→12/72	CORTINA 1600 MkIII	01/70→12/73
CAPRI 1600 GT	01/67→12/70	ESCORT II 1.6 RS	12/74→08/80
CORTINA 1600	01/71→12/75	FIESTA I 1.6 XR2	08/81→08/83
CORTINA 1600 GT	01/67→12/70	TRANSIT 1.6	01/75→12/77
CORTINA 1600 MkII	01/67→12/70		





14-010880-00 *D* **B 84.21 C 150.37**

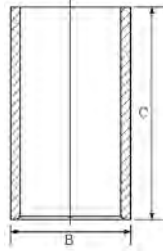

80.98

24

711M UPATED	4cyl.	1599cc	Petrol	MP2350
CAPRI 1600		01/68→12/72	CORTINA 1600	01/71→12/75

- 87-780600-10 *STD*
- 87-780607-10 *.020*
- 87-780609-10 *.030*
- 87-780611-10 *.040*
- 87-780614-10 *.060*
- 87-780617-10 *.090*

- 08-780600-10 *STD*
- 08-780607-10 *.020*
- 08-780609-10 *.030*
- 08-780611-10 *.040*
- 08-780614-10 *.060*
- 08-780617-10 *.090*

14-010880-00 *D* **B 84.21 C 150.37**

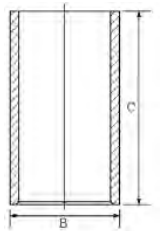

- A 44.12
- B- 12.86
- C 3.10
- C 2.80
- D 83.82
- E 21x71



- 1.60 CR P
- 2.00 P
- 3.94 P

80.98

25

J2	4cyl.	1298cc	38-47kW (52-64PS)	Petrol	TD1217
ESCORT I 1300		06/68→02/76	ESCORT II 1.3		12/74→08/80

- 87-780607-00 *.020*
- 87-780609-00 *.030*
- 87-780614-00 *.060*
- 87-780617-00 *.090*

- 08-780600-10 *STD*
- 08-780607-10 *.020*
- 08-780609-10 *.030*
- 08-780611-10 *.040*
- 08-780614-10 *.060*
- 08-780617-10 *.090*

14-010880-00 *D* **B 84.21 C 150.37**

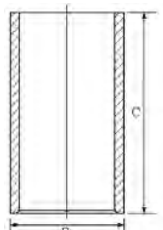

- A 44.22
- B- 13.72
- C 2.77
- C 2.77
- D 83.82
- E 21x71

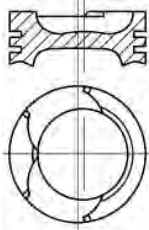

- 1.60 CR P
- 2.00 P
- 3.94 P

82.50

26

BHPA (Endura DI)	4cyl.	1753cc	55-57kW (75-78PS)	Diesel	Turbo Intercooled	TD20062
HCPA (Duratorq)	4cyl.	1753cc	66kW (90PS)	Diesel	Turbo Intercooled	TD18779
HCPB (Duratorq)	4cyl.	1753cc	66kW (90PS)	Diesel	Turbo Intercooled	TD18780
P7PA (Duratorq)	4cyl.	1753cc	55kW (75PS)	Diesel	Turbo Intercooled	TD24465
P7PB (Duratorq)	4cyl.	1753cc	55kW (75PS)	Diesel	Turbo Intercooled	TD24466
P9PA (Duratorq)	4cyl.	1753cc	66kW (90PS)	Diesel	Turbo Intercooled	TD25795
P9PB (Duratorq)	4cyl.	1753cc	66kW (90PS)	Diesel	Turbo Intercooled	TD25796
P9PC (Duratorq)	4cyl.	1753cc	66kW (90PS)	Diesel	Turbo Intercooled	TD25797







P9PD (Duratorq)	4cyl.	1753cc	66kW (90PS)	Diesel	Turbo Intercooled	TD25798
R2PA (Duratorq)	4cyl.	1753cc	55kW (75PS)	Diesel	Turbo Intercooled	TD24467
R3PA (Duratorq)	4cyl.	1753cc	66kW (90PS)	Diesel	Turbo Intercooled	TD25799
RWPE (Duratorq)	4cyl.	1753cc	66kW (90PS)	Diesel	Turbo Intercooled	TD25800
RWPF (Duratorq)	4cyl.	1753cc	66kW (90PS)	Diesel	Turbo Intercooled	TD25801

TOURNEO CONNECT 1.8 TDCi	06/02→12/13	TRANSIT CONNECT 1.8 Di	06/02→12/13
TOURNEO CONNECT 1.8 TDCi /TDDi /DI	06/02→12/13	TRANSIT CONNECT 1.8 TDCi	06/02→12/13



87-107000-10 STD
87-107007-10 0.50mm
87-107011-10 1.00mm
 →12/06

A 45.50
B- 14.10
BØ 41.50
D 70.70
 28x66

KK RT TP



08-107000-00 STD
08-107007-00 0.50mm
08-107011-00 1.00mm

2.50  CK P
 2.00  P
 3.00  CR P



87-437000-10 STD
87-437007-10 0.50mm
 01/07→

A 45.70
B- 12.50
BØ 45.30
D 71.20
 28x66

RT TP



08-437000-00 STD
08-437007-00 0.50mm

1.75  NT
 2.00  P
 2.00  NT

Steel

Stahl

Acier

Acero

Acciaio

82.50

27

F9DA	4cyl.	1753cc	85kW (115PS)	Diesel	Turbo Intercooled	TD17524
F9DB	4cyl.	1753cc	85kW (115PS)	Diesel	Turbo Intercooled	TD17526
FFDA	4cyl.	1753cc	74kW (100PS)	Diesel	Turbo Intercooled	TD17521

FOCUS I 1.8 TDCi	03/01→03/05
------------------	-------------



87-107000-10 STD
87-107007-10 0.50mm
87-107011-10 1.00mm

A 45.50
B- 14.10
BØ 41.50
D 70.70
 28x66

KK RT TP



08-107000-00 STD
08-107007-00 0.50mm
08-107011-00 1.00mm

2.50  CK P
 2.00  P
 3.00  CR P

82.50

28

FFBA	4cyl.	1753cc	74kW (100PS)	Diesel	Turbo Intercooled	TD23304
KHBA (Duratorq)	4cyl.	1753cc	92kW (125PS)	Diesel	Turbo Intercooled	TD23372
KKDA (Euro 4)	4cyl.	1753cc	85kW (115PS)	Diesel	Turbo Intercooled	TD18480





KKDB (Euro 4)	4cyl.	1753cc	85kW (115PS)	Diesel	Turbo Intercooled	TD23303
QYBA (Duratorq)	4cyl.	1753cc	92kW (125PS)	Diesel	Turbo Intercooled	TD23371
QYWA (Duratorq)	4cyl.	1753cc	92kW (125PS)	Diesel	Turbo Intercooled	TD19112
RWPA (Duratorq)	4cyl.	1753cc	81kW (110PS)	Diesel	Turbo Intercooled	TD20063
RWPC (Duratorq)	4cyl.	1753cc	81kW (110PS)	Diesel	Turbo Intercooled	TD25793
RWPD (Duratorq)	4cyl.	1753cc	81kW (110PS)	Diesel	Turbo Intercooled	TD25794

C-MAX 1.8 TDCi	02/07→09/10	MONDEO IV 1.8 TDCi	03/07→01/15
FOCUS C-MAX 1.8 TDCi	01/05→03/07	S-MAX 1.8 TDCi	05/06→12/14
FOCUS II 1.8 TDCi	07/04→09/12	TOURNEO CONNECT 1.8 TDCi	08/06→12/13
GALAXY II 1.8 TDCi	05/06→06/15	TRANSIT CONNECT 1.8 TDCi	08/06→12/13

87-437000-00 STD
87-437007-00 0.50mm
 01/07→

A 45.65
B- 12.47
BØ 45.29
D 71.15
 28x66



08-437000-00 STD
08-437007-00 0.50mm

1.75  NT
 2.00  P
 2.00  NT

Steel Stahl Acier Acero Acciaio

83.00 **29**

CGBA (Duratec)	4cyl.	1798cc	81kW (110PS)	Petrol	TD15907
CGBB (Duratec)	4cyl.	1798cc	81kW (110PS)	Petrol	TD15908
CHBA (Duratec)	4cyl.	1798cc	92kW (125PS)	Petrol	TD15909
CHBB (Duratec)	4cyl.	1798cc	92kW (125PS)	Petrol	TD15910
CSDA (Duratec)	4cyl.	1798cc	88kW (120PS)	Petrol	TD18975
CSDB (Duratec)	4cyl.	1798cc	88kW (120PS)	Petrol	TD18976
Q7DA (Duratec)	4cyl.	1798cc	92kW (125PS)	Petrol	TD18974
QQDA (Duratec)	4cyl.	1798cc	92kW (125PS)	Petrol	TD18788
QQDB (Duratec)	4cyl.	1798cc	92kW (125PS)	Petrol	TD18787

C-MAX 1.8	02/07→09/10	FOCUS II 1.8	01/06→09/12
FOCUS C-MAX 1.8	10/03→03/07	MONDEO III 1.8 16V	10/00→03/07

87-429400-00 STD
87-429407-00 0.50mm

A 28.50
D 51.00
 21x51



08-429400-00 STD
08-429407-00 0.50mm

1.20  NT
 1.20  P
 2.50  NT

Steel Stahl Acier Acero Acciaio

84.01 **30**

BKFA (Euro 6 EcoBlue)	4cyl.	1996cc	96kW (130PS)	Diesel	Turbo Intercooled	TD38410
BKFB (Euro 6 EcoBlue)	4cyl.	1996cc	96kW (130PS)	Diesel	Turbo Intercooled	TD38411
BKFC (Euro 6 EcoBlue)	4cyl.	1996cc	96kW (130PS)	Diesel	Turbo Intercooled	TD38412
BKFD (Euro 6 EcoBlue)	4cyl.	1996cc	96kW (130PS)	Diesel	Turbo Intercooled	TD38413
BKRA (EcoBlue)	4cyl.	1996cc	96kW (130PS)	Diesel	Turbo Intercooled	TD38416





BKRB (EcoBlue)	4cyl.	1996cc	96kW (130PS)	Diesel	Turbo Intercooled	TD38414
YMFA (Euro 6 EcoBlue)	4cyl.	1996cc	96kW (130PS)	Diesel	Turbo Intercooled	TD38408
YMFB (Euro 6 EcoBlue)	4cyl.	1996cc	96kW (130PS)	Diesel	Turbo Intercooled	TD38409
YMHA (EcoBlue)	4cyl.	1996cc	96kW (130PS)	Diesel	Turbo Intercooled	TD38415
YMRA (EcoBlue)	4cyl.	1996cc	96kW (130PS)	Diesel	Turbo Intercooled	TD38417
TOURNEO CUSTOM V362 2.0 EcoBlue			12/15→		TRANSIT V363 2.0 EcoBlue	03/16→
TOURNEO CUSTOM V362 2.0 EcoBlue mHEV			05/19→		TRANSIT V363 2.0 EcoBlue mHEV	05/19→
TRANSIT CUSTOM V362 2.0 EcoBlue			12/15→		TRANSIT V363 2.0 EcoBlue mHEV RWD	05/19→
TRANSIT CUSTOM V362 2.0 EcoBlue mHEV			05/19→		TRANSIT V363 2.0 EcoBlue RWD	03/16→

87-452900-00 STD
87-452907-00 0.50mm
12/15→

A 48.40
B- 14.40
BØ 48.23
C 0.06
D 73.20
30x64



AK KK NB RT TP

08-452900-00 STD
08-452907-00 STD

2.00 GDC P
2.00 CR
2.00 GDC P



84.80 **31**

EDBA (Zetec)	4cyl.	1988cc	96kW (131PS)	Petrol	TD12068
EDBB (Zetec)	4cyl.	1988cc	96kW (131PS)	Petrol	TD15916
EDBC (Zetec)	4cyl.	1988cc	96kW (131PS)	Petrol	TD15917
EDBD (Zetec)	4cyl.	1988cc	96kW (131PS)	Petrol	TD15918
EDDB (Zetec)	4cyl.	1988cc	96kW (131PS)	Petrol	TD15900
EDDC (Zetec)	4cyl.	1988cc	96kW (131PS)	Petrol	TD12080
EDDF (Zetec)	4cyl.	1988cc	96kW (131PS)	Petrol	TD15902
NGA (Zetec)	4cyl.	1988cc	96-100kW (131-136PS)	Petrol	TD4475
NGB (Zetec)	4cyl.	1988cc	96kW (131PS)	Petrol	TD12090
COUGAR 2.0 16V			08/98→12/01	MONDEO I 2.0 i 16V	01/93→08/96
FOCUS I 2.0 16V			10/98→11/04	MONDEO II 2.0 i	08/96→09/00

87-786400-00 STD ①
87-786407-00 0.50mm ①

A 32.92
D 56.90
21x64



08-786400-00 STD
08-786407-00 0.50mm

1.50 CR P
1.75 P
3.00 CR ②

① Pistons to be replaced in Engine Sets only ① Kolben nur in Motorsätzen zu ersetzen ① Piston à remplacer dans jeu moteur ① Pistones de repuesto para juegos de motores solamente ① Il pistone può essere rimpiazzato solamente completo

② Steel ② Stahl ② Acier ② Acero ② Acciaio

85.00 **32**

G6DA (Duratorq)	4cyl.	1997cc	100kW (136PS)	Diesel	Turbo Intercooled	TD18510
G6DB (Duratorq)	4cyl.	1997cc	100kW (136PS)	Diesel	Turbo Intercooled	TD18511
G6DD (Duratorq)	4cyl.	1997cc	100kW (136PS)	Diesel	Turbo Intercooled	TD18790
UKDA (Duratorq)	4cyl.	1997cc	100kW (136PS)	Diesel	Turbo Intercooled	TD24428
C-MAX 2.0 TDCi			02/07→09/10	FOCUS II 2.0 TDCi	07/04→09/12	
FOCUS C-MAX 2.0 TDCi			10/03→03/07	KUGA I 2.0 TDCi	03/08→11/12	





87-114700-40 STD
87-114708-40 0.60mm

A 46.70
B- 15.40
BØ 44.80
C 0.57
D 72.71
 28x70



(08570-109)
AK KK RT TP

08-114700-00 STD
08-114708-00 0.60mm

3.50 CK P
2.00 P
3.00 CR P

85.00

33

KNBA (Duratorq)	4cyl.	2179cc	147kW (200PS)	Diesel	Turbo Intercooled	TD26808
KNBB (Duratorq)	4cyl.	2179cc	146kW (199PS)	Diesel	Turbo Intercooled	TD26809
KNWA (Duratorq)	4cyl.	2179cc	147kW (200PS)	Diesel	Turbo Intercooled	TD26488
KNWB (Duratorq)	4cyl.	2179cc	146kW (199PS)	Diesel	Turbo Intercooled	TD26489
GALAXY II 2.2 TDCi		11/10→06/15		MONDEO IV 2.2 TDCi		07/10→01/15
GALAXY MK II VAN TDCi		03/13→06/15		S-MAX 2.2 TDCi		07/10→12/14

87-436700-00 STD ¹
87-436708-00 0.60mm ¹

A 48.60
B- 15.12
BØ 50.40
C 0.38
D 74.61
 30x68
(0850HA324)



AK KK RT TP

08-436700-00 STD
08-436708-00 0.60mm

2.50 GDC P
2.00 P
2.00 CK



¹ For pistons with a 24.3mm rod gap measured at pin centre line
¹ Für Kolben mit einem Pleuelaugenabstand von 24,3 MM, gemessen an der Kolbenbolzen-Mitte
¹ Pour pistons avec un écart de bielle de 24,3 mm mesuré au centre de l'axe bielle-piston
¹ Para pistones con una distancia de paso de biela en el centro del bulón de 24,3mm
¹ Per pistoni con passaggio biella di 24,3 mm misurato sull'asse foro spinotto

86.00

34

ABFA (Duratorq)	4cyl.	1998cc	74kW (101PS)	Diesel	Turbo Intercooled	TD15888
D3FA	4cyl.	1998cc	55kW (75PS)	Diesel	Turbo Intercooled	TD15551
D5BA (Duratorq)	4cyl.	1998cc	66kW (90PS)	Diesel	Turbo Intercooled	TD15914
F3FA (Duratorq)	4cyl.	1998cc	63kW (86PS)	Diesel	Turbo Intercooled	TD18777
SDBA (Duratorq)	4cyl.	1998cc	66kW (90PS)	Diesel	Turbo Intercooled	TD18763
MONDEO III 2.0 16V DI / TDDi / TDCi		10/00→03/07		TRANSIT TOURNEO 2.0		06/00→03/05
TRANSIT 2.0 DI		08/00→05/06				

87-140800-00 STD ¹
87-140807-00 0.50mm

A 47.58
B- 16.50
BØ 40.20
D 73.98
 30x66



RT TP

08-140800-00 STD ²
08-140807-00 0.50mm ²

2.00 CK P
2.00 P
2.00 NT ³

¹ Bowl capacity 20.14cm³
² Only fit to pistons equivalent to OE 24878 and 24879
³ Steel
¹ Volumen der Kolbenmulde 20.14cm³
² Nur gepasst worden zu den Kolben gleichwertig mit OE 24878 u nd 24879
³ Stahl
¹ Volume de la cavité du piston 20.14cm³
² Seulement adapté aux pistons équivalents à OE 24878 et 24879
³ Acier
¹ Vol. cavidad pistón 20.14cm³
² Cabido solamente a los pistones equivalentes a OE 24878 y 24 879
³ Acero
¹ Volume camera pistone 20.14cm³
² Adattato soltanto ai pistoni equivalenti a OE 24878 e 24879
³ Acciaio



86.00 **35**

CV24 (Duratorq)	4cyl.	2198cc	114kW (155PS)	Diesel	Turbo Intercooled	TD29669
CVF5 (Duratorq)	4cyl.	2198cc	114kW (155PS)	Diesel	Turbo Intercooled	TD29676
CVFF (Duratorq)	4cyl.	2198cc	114kW (155PS)	Diesel	Turbo Intercooled	TD29681
CVR5 (Duratorq)	4cyl.	2198cc	114kW (155PS)	Diesel	Turbo Intercooled	TD29667
CVRA (Duratorq)	4cyl.	2198cc	114kW (155PS)	Diesel	Turbo Intercooled	TD26453
CVRB (Duratorq)	4cyl.	2198cc	114kW (155PS)	Diesel	Turbo Intercooled	TD26454
CVRC (Duratorq)	4cyl.	2198cc	114kW (155PS)	Diesel	Turbo Intercooled	TD26455
CYFA (Duratorq)	4cyl.	2198cc	92kW (125PS)	Diesel	Turbo Intercooled	TD26461
CYFB (Duratorq)	4cyl.	2198cc	92kW (125PS)	Diesel	Turbo Intercooled	TD26462
CYFC (Duratorq)	4cyl.	2198cc	92kW (125PS)	Diesel	Turbo Intercooled	TD26463
CYFD (Duratorq)	4cyl.	2198cc	92kW (125PS)	Diesel	Turbo Intercooled	TD26464
DRFA (Duratorq)	4cyl.	2198cc	74kW (101PS)	Diesel	Turbo Intercooled	TD26456
DRFB (Duratorq)	4cyl.	2198cc	74kW (101PS)	Diesel	Turbo Intercooled	TD26457
DRFC (Duratorq)	4cyl.	2198cc	74kW (101PS)	Diesel	Turbo Intercooled	TD26458
GBVAJPF (Duratorq)	4cyl.	2198cc	88kW (120PS)	Diesel	Turbo Intercooled	TD26487
GBVAJQJ (Duratorq)	4cyl.	2198cc	110-118kW (150-160PS)	Diesel	Turbo Intercooled	TD26483
GBVAJQW (Duratorq)	4cyl.	2198cc	92kW (125PS)	Diesel	Turbo Intercooled	TD26486
UYR6 (Duratorq)	4cyl.	2198cc	114kW (155PS)	Diesel	Turbo Intercooled	TD29668

RANGER 2.2 TDCi	04/11→	TRANSIT CUSTOM V362 2.2 TDCi	04/12→
TOURNEO CUSTOM V362 2.2 TDCi	04/12→12/15	TRANSIT V362 2.2 TDCi	08/13→12/18
TRANSIT 2.2 TDCi	10/11→08/14	TRANSIT V363 2.2 TDCi RWD	08/13→12/18
TRANSIT 2.2 TDCi RWD	10/11→08/14	TRANSIT TOURNEO 2.2	10/11→08/14

87-427700-50 STD ①
87-427707-50 0.50mm ①

A 48.42
B- 16.17
BØ 49.04
D 74.82
F 30x67



(08683-607)
AK KK RT TP

08-427700-00 STD
08-427705-00 0.25mm
08-427707-00 0.50mm

2.00 CK P
2.00 P
2.00 NT ②



14-022110-00 D B 89.00 C 165.00 D 90.05 E 5.00

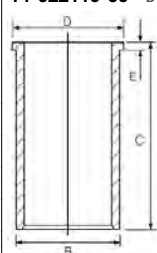

① *** CAUTION - CHECK BOWL DIAMETER *** ① *** ACHTUNG - MULDENDURCHMESSER ÜBERPRÜFEN *** ① ** Attention ¿ veuillez verifier le diamètre du bol** ① ** Precaución - verifica el diámetro del bulón ** ① ** attenzione ¿ controllare diametro camera di combustione **
② Steel ② Stahl ② Acier ② Acero ② Acciaio

86.00 **36**

CYF5 (Duratorq)	4cyl.	2198cc	92-99kW (125-135PS)	Diesel	Turbo Intercooled	TD29666
CYRA (Duratorq)	4cyl.	2198cc	92kW (125PS)	Diesel	Turbo Intercooled	TD26716
CYRB (Duratorq)	4cyl.	2198cc	92kW (125PS)	Diesel	Turbo Intercooled	TD26465
CYRC (Duratorq)	4cyl.	2198cc	92kW (125PS)	Diesel	Turbo Intercooled	TD26466
PGFA (Duratorq)	4cyl.	2198cc	103kW (140PS)	Diesel	Turbo Intercooled	TD21067
PGFB (Duratorq)	4cyl.	2198cc	103kW (140PS)	Diesel	Turbo Intercooled	TD24463
SRFA (Duratorq)	4cyl.	2198cc	85kW (115PS)	Diesel	Turbo Intercooled	TD24458
SRFB (Duratorq)	4cyl.	2198cc	85kW (115PS)	Diesel	Turbo Intercooled	TD24459
SRFC (Duratorq)	4cyl.	2198cc	85kW (115PS)	Diesel	Turbo Intercooled	TD24460
SRFD (Duratorq)	4cyl.	2198cc	85kW (115PS)	Diesel	Turbo Intercooled	TD24461
SRFE (Duratorq)	4cyl.	2198cc	85kW (115PS)	Diesel	Turbo Intercooled	TD24462
UHFA (Duratorq)	4cyl.	2198cc	103kW (140PS)	Diesel	Turbo Intercooled	TD26467
UHFB (Duratorq)	4cyl.	2198cc	103kW (140PS)	Diesel	Turbo Intercooled	TD26468
UHFC (Duratorq)	4cyl.	2198cc	103kW (140PS)	Diesel	Turbo Intercooled	TD26469
USR6 (Duratorq)	4cyl.	2198cc	92kW (125PS)	Diesel	Turbo Intercooled	TD29670
USRA (Duratorq)	4cyl.	2198cc	100kW (136PS)	Diesel	Turbo Intercooled	TD26470
USRB (Duratorq)	4cyl.	2198cc	100kW (136PS)	Diesel	Turbo Intercooled	TD26471







TRANSIT 2.2 TDCi	10/07→08/14	TRANSIT V363 2.2 TDCi RWD	08/13→12/18
TRANSIT 2.2 TDCi RWD	09/11→12/14	TRANSIT TOURNEO 2.2 TDCi	10/07→08/14
TRANSIT V363 2.2 TDCi	08/13→12/18		

87-427700-40 STD ①
87-427707-40 0.50mm ①

A 48.42
 B- 15.85
 BØ 46.90
 D 74.82
 30x66
 (08683-101)
AK KK RT TP



08-427700-00 STD
08-427705-00 0.25mm
08-427707-00 0.50mm

2.00  CK P
 2.00  P
 2.00  NT ②

14-021120-00 D
B 89.00 C 156.00 D 90.90 E 5.00

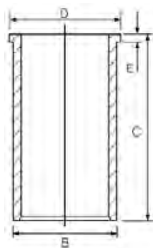

① *** CAUTION - CHECK BOWL DIAMETER *** ① *** ACHTUNG - MULDENDURCHMESSER ÜBERPRÜFEN *** ① ** Attention ȳ veuillez verifier le diamȳtre du bol** ① ** Precauciȳn - verifica el diȳmetro del bulȳn ** ① ** attenzione ȳ controllare diametro camera di combustione **

② Steel ② Stahl ② Acier ② Acero ② Acciaio

86.00						37
D6BA (Duratorq)	4cyl.	1998cc	85kW (115PS)	Diesel	Turbo Intercooled	TD15915
FIFA (Duratorq)	4cyl.	1998cc	92kW (125PS)	Diesel	Turbo Intercooled	TD18839
FMBA	4cyl.	1998cc	96kW (130PS)	Diesel	Turbo Intercooled	TD18761
HJBA	4cyl.	1998cc	85kW (115PS)	Diesel	Turbo Intercooled	TD17547
HJBB	4cyl.	1998cc	85kW (115PS)	Diesel	Turbo Intercooled	TD17548
HJBC	4cyl.	1998cc	85kW (115PS)	Diesel	Turbo Intercooled	TD17549
N7BA	4cyl.	1998cc	96kW (130PS)	Diesel	Turbo Intercooled	TD18762



MONDEO III 2.0 16V TDDi / TDCi	10/00→03/07	TRANSIT 2.0 TDCi	08/02→05/06
MONDEO III 2.0 TDCi	10/01→03/07	TRANSIT TOURNEO 2.0	03/02→03/06

87-140800-10 STD ①
87-140807-10 0.50mm

A 47.70
 B- 15.20
 BØ 43.30
 D 74.10
 30x66
 (8662)
KK RT TP



08-140800-00 STD ②
08-140807-00 0.50mm ②

2.00  CK P
 2.00  P
 2.00  NT ③

14-021120-00 D
B 89.00 C 156.00 D 90.90 E 5.00



① Bowl capacity 21.49cm³ ① Volumen der Kolbenmulde 21.49cm³ ① Volume de la cavitȳ du piston 21.49cm³ ① Vol. cavidad pistȳn 21.49cm³ ① Volume camera pistone 21.49cm³

② Only fit to pistons equivalent to OE 24878 and 24879 ② Nur gepasst worden zu den Kolben gleichwertig mit OE 24878 u nd 24879 ② Seulement adaptȳ aux pistons ȳquivalents ȳ OE 24878 et 24879 ② Cabido solamente a los pistones equivalentes a OE 24878 y 24 879 ② Adattato soltanto ai pistoni equivalenti a OE 24878 e 24879

③ Steel ③ Stahl ③ Acier ③ Acero ③ Acciaio

86.00						38
P8FA (Duratorq)	4cyl.	2198cc	63kW (85PS)	Diesel	Turbo Intercooled	TD20042
P8FB (Duratorq)	4cyl.	2198cc	63kW (85PS)	Diesel	Turbo Intercooled	TD21066



TRANSIT 2.2 TDCi	04/06→08/14		
------------------	-------------	--	--

87-427700-30 STD
87-427707-30 0.50mm

A 43.42
 B- 15.85
 BØ 46.90
 D 69.82
 30x67
 (08650A105)
RT TP



08-427700-00 STD
08-427705-00 0.25mm
08-427707-00 0.50mm

2.00  CK P
 2.00  P
 2.00  NT ①

14-021120-00 D
B 89.00 C 156.00 D 90.90 E 5.00

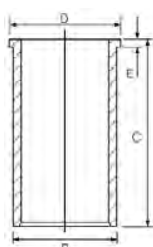

① Steel ① Stahl ① Acier ① Acero ① Acciaio

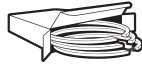



86.00 **39**

QJBA (Duratorq)	4cyl.	2198cc	114kW (155PS)	Diesel	Turbo Intercooled	TD18756
QJBB (Duratorq)	4cyl.	2198cc	114kW (155PS)	Diesel	Turbo Intercooled	TD18757
QJBC (Duratorq)	4cyl.	2198cc	110kW (150PS)	Diesel	Turbo Intercooled	TD18782
QJBD (Duratorq)	4cyl.	2198cc	110kW (150PS)	Diesel	Turbo Intercooled	TD18783
QVFA (Duratorq)	4cyl.	2198cc	81kW (110PS)	Diesel	Turbo Intercooled	TD20043
QWFA (Duratorq)	4cyl.	2198cc	96kW (130PS)	Diesel	Turbo Intercooled	TD20044





MONDEO III 2.2 TDCi	09/04→03/07	TRANSIT TOURNEO 2.2 TDCi	07/06→08/14
TRANSIT 2.2 TDCi	04/06→08/14		

87-427700-10 STD
87-427707-10 0.50mm

A 43.42
B- 15.85
BØ 46.90
D 69.82
 30x67
 (8648B105)
KK RT TP







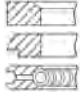

08-427700-00 STD
08-427705-00 0.25mm
08-427707-00 0.50mm

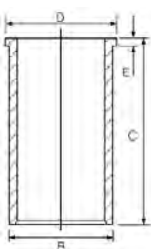
2.00  CK P
 2.00  P
 2.00  NT 



14-021120-00 D **B** 89.00 **C** 156.00 **D** 90.90 **E** 5.00



 Steel  Stahl  Acier  Acero  Acciaio

87.50 **40**

AOBA (Euro 4 Duratec)	4cyl.	1999cc	107kW (145PS)	Petrol	TD23308
AODA	4cyl.	1999cc	107kW (145PS)	Petrol	TD18506
AODB	4cyl.	1999cc	107kW (145PS)	Petrol	TD18507
AODE	4cyl.	1999cc	104-107kW (141-145PS)	Petrol	TD24347
AOWA	4cyl.	1999cc	107kW (145PS)	Petrol	TD20039
AOWB	4cyl.	1999cc	107kW (145PS)	Petrol	TD24430
CJBA (Duratec)	4cyl.	1999cc	106-107kW (144-146PS)	Petrol	TD15911
CJBB (Duratec)	4cyl.	1999cc	107kW (146PS)	Petrol	TD15912
N4JB (Duratec)	4cyl.	1999cc	110kW (150PS)	Petrol	TD18781
SYDA (Duratec)	4cyl.	1999cc	104-109kW (143-146PS)	Petrol	TD23368





C-MAX 2.0	02/07→09/10	GALAXY II 2.0	05/06→06/15
C-MAX 2.0 CNG	04/09→09/10	GALAXY MK II VAN 2.0	05/06→06/15
C-MAX 2.0 LPG	06/08→09/10	MONDEO III 2.0	10/00→03/07
FIESTA V ST150	03/05→06/08	MONDEO III 2.0 16V	10/00→03/07
FOCUS C-MAX 2.0	03/04→03/07	MONDEO IV 2.0	03/07→01/15
FOCUS II 2.0	07/04→09/12	S-MAX 2.0	05/06→12/14
FOCUS II 2.0 CNG	04/09→07/11	S-MAX VAN 2.0	03/10→12/14
FOCUS II 2.0 LPG	06/08→07/11		

87-423400-00 STD
87-423407-00 0.50mm

A 28.50
B- 0.35
BØ 76.50
D 51.00
 21x60



08-423400-00 STD
08-423407-00 0.50mm

1.20  CR P 
 1.20  P
 2.50  CR 



 Steel  Stahl  Acier  Acero  Acciaio

88.00 **41**

XD/P88	4cyl.	1948cc	Diesel	MP1421
---------------	-------	---------------	---------------	---------------

GRANADA 1.9D	01/77→12/82
--------------	-------------





14-600420-00 WH **B 96.00 C 173.00 D 106.30 E 129.00**

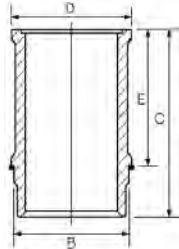

Use also HT022

Mitverwenden: HT022

A utiliser aussi: HT022

Utilizar también: HT022

Usare anche HT022

89.60					42
E5FA	4cyl.	2295cc	107kW (146PS)	Petrol	TD16167
E5FC	4cyl.	2295cc	103-107kW (140-146PS)	Petrol	TD20058
Y5A	4cyl.	2295cc	108kW (147PS)	Petrol	TD12092
Y5B	4cyl.	2295cc	107kW (146PS)	Petrol	TD5497
GALAXY I 2.3 16V		01/97→05/06	TRANSIT 2.3 16V		04/01→05/06
SCORPIO II 2.3 i 16V		06/96→08/98	TRANSIT 2.3 16V RWD		08/00→05/06
TRANSIT 2.3		03/01→03/06			

87-107600-00 STD
87-107607-00 0.50mm

08-107600-00 STD
08-107607-00 0.50mm

A 29.25
D 54.20
21x63



1.60 PS P
1.50 P
2.50 CR

Steel

Stahl

Acier

Acero

Acciaio

89.90					43
D2FA (Duratorq)	4cyl.	2402cc	66kW (90PS)	Diesel Turbo Intercooled	TD15549
D2FB (Duratorq)	4cyl.	2402cc	66kW (90PS)	Diesel Turbo Intercooled	TD20037
D2FE (Duratorq)	4cyl.	2402cc	66kW (90PS)	Diesel Turbo Intercooled	TD15552
F4FA (Duratorq)	4cyl.	2402cc	55kW (75PS)	Diesel Turbo Intercooled	TD15548
TRANSIT 2.4 DI		01/00→05/06	TRANSIT 2.4 TD		08/00→08/03
TRANSIT 2.4 DI RWD		01/00→05/06			

87-113500-00 STD
87-113507-00 0.50mm
87-113511-00 1.00mm

08-113500-00 STD
08-113507-00 0.50mm
08-113511-00 1.00mm

A 53.54
B- 17.60
BØ 41.00
D 80.50
32x65



2.50 CK P
2.00 P
3.00 CR P

RT TP

14-020540-00 D **B 92.50 C 165.00 D 95.50 E 3.00**

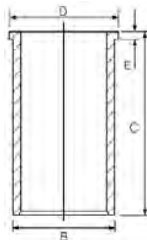

89.90					44
D4FA (Duratorq)	4cyl.	2402cc	88kW (120PS)	Diesel Turbo Intercooled	TD15550
FXFA (Duratorq)	4cyl.	2402cc	85kW (115PS)	Diesel Turbo Intercooled	TD18798





TRANSIT 2.4 DI	01/00→05/06	TRANSIT 2.4 TDE	03/04→05/06
TRANSIT 2.4 DI RWD	01/00→05/06		

87-113500-10 STD
87-113507-10 0.50mm
87-113511-10 1.00mm

A 53.50
B- 17.24
Bø 40.40
D 80.50
 32x71



KK RT TP

08-113500-00 STD
08-113507-00 0.50mm
08-113511-00 1.00mm

2.50 CK P
 2.00 P
 3.00 CR P

14-020540-00 D

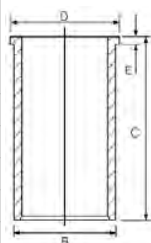

B 92.50 **C** 165.00 **D** 95.50 **E** 3.00

Bowl capacity 25.34cm³

Volumen der Kolbenmulde 25.34cm³

Volume de la cavité du piston 25.34cm³

Vol. cavidad pistón 25.34cm³

Volume camera pistone 25.34cm³

89.90

45

DOFA (DT24) (Duratorq)	4cyl.	2402cc	92kW (125PS)	Diesel	Turbo Intercooled	TD20038
-------------------------------	-------	---------------	---------------------	---------------	--------------------------	----------------

TRANSIT 2.4 TDE	07/01→05/06					
-----------------	-------------	--	--	--	--	--

87-148100-00 STD
87-148105-00 0.25mm
87-148107-00 0.50mm

A 53.50
B- 17.24
Bø 40.40
D 80.50
 32x71



(08900B201)

AK KK RT TP

08-148100-00 STD
08-148105-00 0.25mm
08-148107-00 0.50mm

2.00 CK P
 2.00 P
 2.00 NT

14-020540-00 D

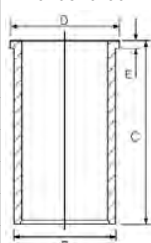

B 92.50 **C** 165.00 **D** 95.50 **E** 3.00

Steel

Stahl

Acier

Acero

Acciaio

89.90

46

H9FA (Duratorq)	4cyl.	2402cc	101kW (137PS)	Diesel	Turbo Intercooled	TD24094
H9FB (Euro 4 Duratorq)	4cyl.	2402cc	103kW (140PS)	Diesel	Turbo Intercooled	TD20033
JXFA (Duratorq)	4cyl.	2402cc	85kW (115PS)	Diesel	Turbo Intercooled	TD20034
JXFC (Duratorq)	4cyl.	2402cc	85kW (115PS)	Diesel	Turbo Intercooled	TD24456

TRANSIT 2.4 D	03/04→12/06	TRANSIT 2.4 TDCi RWD	04/06→08/14
TRANSIT 2.4 TDCi	04/06→08/14		

87-148100-30 STD
87-148105-30 0.25mm
87-148107-30 0.50mm

A 53.50
B- 16.30
Bø 49.00
D 80.50
 32x71



(08900B102)

AK KK RT TP

08-148100-00 STD
08-148105-00 0.25mm
08-148107-00 0.50mm

2.00 CK P
 2.00 P
 2.00 NT

14-020540-00 D

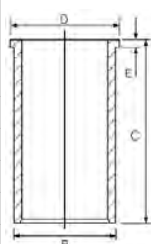

B 92.50 **C** 165.00 **D** 95.50 **E** 3.00

Steel

Stahl

Acier

Acero

Acciaio

89.90

47

H9FA (Euro 4 Duratorq)	4cyl.	2402cc	101kW (137PS)	Diesel	Turbo Intercooled	TD20036
-------------------------------	-------	---------------	----------------------	---------------	--------------------------	----------------

TRANSIT 2.4 TDCi	03/04→05/06					
------------------	-------------	--	--	--	--	--





87-148100-10 STD ¹
87-148105-10 0.25mm
87-148107-10 0.50mm
 03/04→

A 53.50
B- 15.62
BØ 47.10
D 80.50
 32x71

(8900B301)
AK KK RT TP



08-148100-00 STD
08-148105-00 0.25mm
08-148107-00 0.50mm

2.00  CK P
 2.00  P
 2.00  NT ²

14-020540-00 D

B 92.50 **C** 165.00 **D** 95.50 **E** 3.00

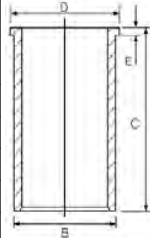

¹ Bowl capacity 27.03cm³
² Steel

¹ Volumen der Kolbenmulde 27.03cm³
² Stahl

¹ Volume de la cavité du piston 27.03cm³
² Acier

¹ Vol. cavidad pistón 27.03cm³
² Acero

¹ Volume camera pistone 27.03cm³
² Acciaio

89.90

48

PHFA (Duratorq)	4cyl.	2402cc	74kW (100PS)	Diesel	Turbo Intercooled	TD20035
PHFC (Duratorq)	4cyl.	2402cc	74kW (100PS)	Diesel	Turbo Intercooled	TD21068

TRANSIT 2.4 TDCi	04/06→08/14	TRANSIT 2.4 TDCi RWD	04/06→08/14
------------------	-------------	----------------------	-------------

87-148100-40 STD
87-148105-40 0.25mm
87-148107-40 0.50mm

A 53.50
B- 16.30
BØ 49.00
D 80.50
 32x66

(08998A101)
AK RT TP



08-148100-00 STD
08-148105-00 0.25mm
08-148107-00 0.50mm

2.00  CK P
 2.00  P
 2.00  NT ¹

14-020540-00 D

B 92.50 **C** 165.00 **D** 95.50 **E** 3.00

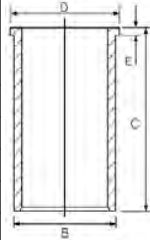

¹ Steel

¹ Stahl

¹ Acier

¹ Acero

¹ Acciaio

89.90

49

SAFA (Duratorq)	5cyl.	3198cc	147kW (200PS)	Diesel	Bi-Turbo Intercooled	TD21069
SAFB (Duratorq)	5cyl.	3198cc	147kW (200PS)	Diesel	Bi-Turbo Intercooled	TD23369

RANGER 3.2 TDCi	04/11→	TRANSIT 3.2 TDCi RWD	09/07→08/14
TRANSIT 3.2 TDCi	02/08→08/14		

87-148100-80 STD
87-148105-80 0.25mm
87-148107-80 0.50mm

A 48.22
B- 16.70
BØ 50.20
D 75.22
 32x74

(0899BA-105)
AK KK RT TP



08-148100-00 STD
08-148105-00 0.25mm
08-148107-00 0.50mm

2.00  CK P
 2.00  P
 2.00  NT ¹

14-020540-00 D

B 92.50 **C** 165.00 **D** 95.50 **E** 3.00

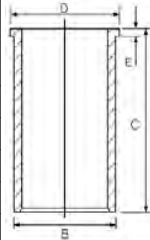



87-148100-85 STD ②
87-148107-85 0.50mm ②

A 48.34
B- 17.93
BØ 51.43
D 75.34
 32x74

(0899E-301)
AK KK RT TP



08-148100-00 STD
08-148105-00 0.25mm
08-148107-00 0.50mm

2.00  CK P
 2.00  P
 2.00  NT①

① Steel
 ② Bowl capacity 36.149cm³

① Stahl
 ② Volumen der Kolbenmulde 36.149cm³

① Acier
 ② Volume de la cavité du piston 36.149cm³

① Acero
 ② Vol. cavidad pistón 36.149cm³

① Acciaio
 ② Volume camera pistone 36.149cm³

90.00

50

WTA (XD90)	V4cyl.	2112cc	46kW (63PS)	Diesel	TD1478
GRANADA II 2.1 D		08/77→08/82			

14-604060-00 WH **B 96.00 C 173.00 D 106.30 E 129.00**

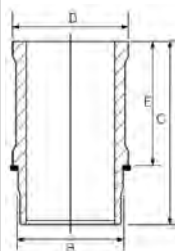

90.80

51

N4A	4cyl.	1994cc	85kW (115PS)	Petrol	TD1318
N4I	4cyl.	1994cc	85kW (115PS)	Petrol	TD1320
NE1	4cyl.	1994cc	74-77kW (101-105PS)	Petrol	TD1347
NE4	4cyl.	1994cc	74kW (100PS)	Petrol	TD1350
NE5	4cyl.	1994cc	74kW (100PS)	Petrol	TD1351
NEJ	4cyl.	1994cc	74kW (100PS)	Petrol	TD1355
NEL	4cyl.	1994cc	77kW (105PS)	Petrol	TD1357
NES	4cyl.	1994cc	77kW (105PS)	Petrol	TD1361
NET	4cyl.	1994cc	74-77kW (101-105PS)	Petrol	TD1362
NR2	4cyl.	1994cc	85kW (115PS)	Petrol	TD1364
NRA	4cyl.	1994cc	85kW (115PS)	Petrol	TD1365
NRB	4cyl.	1994cc	85kW (115PS)	Petrol	TD1367
NRI	4cyl.	1994cc	85kW (115PS)	Petrol	TD1370
SCORPIO I 2.0			04/85→09/93	SIERRA I 2.0 i	03/85→12/86
SCORPIO I 2.0 i			04/85→02/92	SIERRA II 2.0	01/87→02/93
SIERRA 2.0			08/82→12/86	SIERRA II 2.0 i	01/87→02/93
SIERRA I 2.0			08/82→12/86		





87-780300-10 STD ①
87-780307-10 0.50mm
87-780311-10 1.00mm ②
87-780314-10 1.50mm ②

A 41.55
D 69.55
 24x69



08-780300-10 STD
08-780307-10 0.50mm
08-780311-10 1.00mm
08-780314-10 1.50mm

1.60  CK
 2.00  P
 4.00  CR ③

① Earlier pistons to be replaced in Engine sets only

① Frühere Kolben nur in Motorsätzen zu ersetzen

① Premier piston à remplacer dans le jeu moteur

① Pistones más antiguos para ser reemplados en juego de motores solamente

① Con i pistone di vecchia versione è necessario sostituire tutta la serie

② Recommended maximum oversize is 1.00mm (.0394in)

② Empfohlenes Übermaß max 1.00mm (.0394in)

② Cote maxi recommandée de 1.00mm (.0394in)

② La sobremedida máxima recomendada es de 1.00mm (.0394in)

② Maggiorazione massima raccomandata 1.00mm

③ Steel

③ Stahl

③ Acier

③ Acero

③ Acciaio

90.80

52

NAE (TL20L)	4cyl.	1994cc	57kW (78PS)	Petrol	TD1342
NAT (TL20L)	4cyl.	1994cc	57kW (78PS)	Petrol	TD4472
NAV (TL20L)	4cyl.	1994cc	55-57kW (75-78PS)	Petrol	TD1344
P 100 II 2.0			10/87→12/92	TRANSIT 2.0	09/85→09/92

87-780300-30 STD ①

A 40.25
D 68.25
 24x72



08-780300-10 STD
08-780307-10 0.50mm
08-780311-10 1.00mm
08-780314-10 1.50mm

1.60  CK
 2.00  P
 4.00  CR ②

① Earlier pistons to be replaced in Engine sets only

① Frühere Kolben nur in Motorsätzen zu ersetzen

① Premier piston à remplacer dans le jeu moteur

① Pistones más antiguos para ser reemplados en juego de motores solamente

① Con i pistone di vecchia versione è necessario sostituire tutta la serie

② Steel

② Stahl

② Acier

② Acero

② Acciaio

92.00

53

SCB	4cyl.	2500cc	85kW (115PS)	Diesel Turbo Intercooled	TD1443
SCC	4cyl.	2500cc	85kW (115PS)	Diesel Turbo Intercooled	TD4490
SCORPIO I 2.5 TD			08/93→09/94	SCORPIO II 2.5 TD	10/94→08/98

15-676420-00 WH ① **B** 101.50 **C** 166.80 **D** 110.00 **E** 8.90 **F** 1.20
14-676420-00 WH **B** 101.50 **C** 166.80 **D** 110.00 **E** 8.90 **F** 1.20

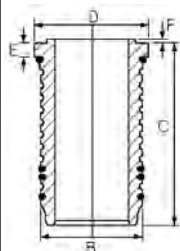

① Includes seals

① Schließt Dichtungen ein

① Inclut des joints

① Incluye los sellos

① Comprende le guarnizioni

93.67

54

4AA (2401E York Parent Block)	4cyl.	2358cc	46kW (62PS)	Diesel	TD17094
4EA	4cyl.	2496cc	74kW (100PS)	Diesel Turbo	TD1119





4EB	4cyl.	2496cc	74kW (101PS)	Diesel	Turbo	TD4424
4EC	4cyl.	2496cc	74kW (101PS)	Diesel	Turbo	TD15214
4HA	4cyl.	2496cc	55-56kW (75-76PS)	Diesel		TD4434
4HD	4cyl.	2496cc	55-56kW (75-76PS)	Diesel		TD16250
2402E YORK (Parent Block)	6cyl.	3537cc		Diesel		MP2463
A-SERIES 3.5D			09/73→09/83	TRANSIT 2.5 TDI		06/94→03/00
TRANSIT 2.3 D FT 100			11/71→09/78	TRANSIT TOURNEO 2.4 D		08/94→06/00
TRANSIT 2.4 D			11/77→10/86	TRANSIT TOURNEO 2.5 TD		04/98→12/00
TRANSIT 2.5 TD			05/91→06/00			

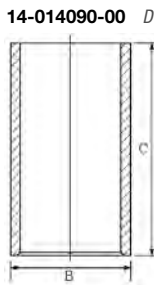

B 96.94 C 171.45

93.67						55
4AB	4cyl.	2496cc	50-52kW (68-71PS)	Diesel		TD1113
4BA	4cyl.	2496cc	52kW (71PS)	Diesel		TD1114
4CA	4cyl.	2496cc	52kW (71PS)	Diesel		TD1116
4CC	4cyl.	2496cc	52kW (70PS)	Diesel		TD1117
4DA	4cyl.	2496cc	59kW (80PS)	Diesel		TD1118
TRANSIT 2.4 D			10/83→10/86	TRANSIT 2.5 DI		09/88→08/94
TRANSIT 2.5 D			10/83→09/92			

87-784800-00 STD
87-784821-00 0.65mm

- A** 59.47
- B-** 18.00
- BØ** 40.00
- D** 94.00
-  29x77



RT

08-784800-00 STD
08-784821-00 0.65mm

- 2.50  MOL P
- 2.00  P
- 4.00  CR P

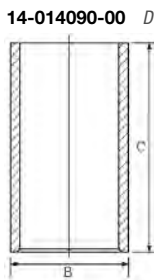

B 96.94 C 171.45

93.67						56
4BC	4cyl.	2496cc	52kW (70PS)	Diesel		TD1115
4FA	4cyl.	2496cc	51-52kW (69-70PS)	Diesel		TD1120
4FB	4cyl.	2496cc	51kW (70PS)	Diesel		TD4426
4FC	4cyl.	2496cc	51kW (70PS)	Diesel		TD4428
4FD	4cyl.	2496cc	51kW (69PS)	Diesel		TD15209
4GA	4cyl.	2496cc	63kW (85PS)	Diesel	Turbo	TD4430
4GB	4cyl.	2496cc	63kW (85PS)	Diesel	Turbo	TD4432
4GC	4cyl.	2496cc	63kW (85PS)	Diesel	Turbo	TD4433
4GD	4cyl.	2496cc	63kW (86PS)	Diesel	Turbo	TD15211
4GE	4cyl.	2496cc	63kW (86PS)	Diesel	Turbo	TD15212
4GF	4cyl.	2496cc	63kW (85PS)	Diesel	Turbo	TD15213
4HB	4cyl.	2496cc	56kW (76PS)	Diesel		TD4436
4HC	4cyl.	2496cc	56kW (76PS)	Diesel		TD15210





TRANSIT 2.5 DI	05/91→03/00	TRANSIT TOURNEO 2.5 DI	11/94→12/00
TRANSIT 2.5 TD	10/92→03/00	TRANSIT TOURNEO 2.5 TD	11/94→12/00



87-784800-00 STD
87-784821-00 0.65mm
 →12/94

A 59.47
B- 18.00
BØ 40.00
D 94.00
 29x77

RT



08-784800-00 STD
08-784821-00 0.65mm

2.50  MOL P
 2.00  P
 4.00  CR P

14-014090-00 D **B** 96.94 **C** 171.45

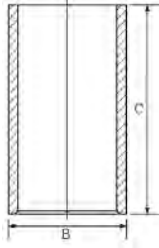



87-123700-30 STD
87-123721-30 0.65mm
 01/95→

A 59.51
B- 18.00
BØ 40.00
D 94.00
 29x76

RT



08-123700-00 STD
08-123721-00 0.65mm

2.50  MOL P
 2.00  P
 4.00  CR P

93.67 **57**

4ED	4cyl.	2496cc	85kW (116PS)	Diesel	Turbo Intercooled	TD12093
TRANSIT 2.5 DI		08/97→03/00				



87-123700-30 STD
87-123721-30 0.65mm

A 59.51
B- 18.00
BØ 40.00
D 94.00
 29x76

RT



08-123700-00 STD
08-123721-00 0.65mm

2.50  MOL P
 2.00  P
 4.00  CR P

14-014090-00 D **B** 96.94 **C** 171.45

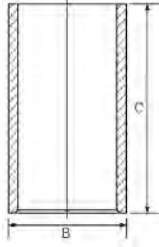

94.00 **58**

SFA (XD3T)	4cyl.	2498cc	68kW (92PS)	Diesel	Turbo	TD4492
SFB (XD3T)	4cyl.	2498cc	68kW (92PS)	Diesel	Turbo	TD4493
XD2S	4cyl.	2304cc	51kW (69PS)	Diesel	Turbo Intercooled	MP1429
XD3P	4cyl.	2497cc	53-58kW (72-79PS)	Diesel		TD22249
XD3T	4cyl.	2497cc	70kW (95PS)	Diesel	Turbo Intercooled	TD22250
GRANADA 2.3 D			01/82→	SCORPIO I 2.5 TD		06/88→07/93
SCORPIO 2.3 D			01/82→	SIERRA 2.3 D		01/82→





14-020660-00 D B 97.00 C 170.60 D 99.50 E 4.00
14-021520-00 D B 98.00 C 170.60 D 100.00 E 6.00

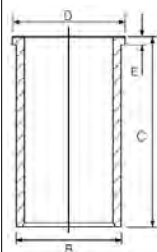

94.00

59

STP (XD3/XD3P)	4cyl.	2499cc	51kW (69PS)	Diesel	TD1448
STR (XD3/XD3P)	4cyl.	2498cc	51kW (69PS)	Diesel	TD1449
GRANADA 2.5 D			08/82→08/85	SCORPIO I 2.5 D	12/85→12/94
GRANADA II 2.5 D			08/82→08/85		

87-318700-10 STD
87-318706-10 0.40mm
 →12/93

A 54.00
B- 1.80
D 96.42
 30x79



08-318700-10 STD
08-318706-10 0.40mm
08-318708-10 0.60mm
08-318711-10 1.00mm

2.00 CR P
 2.00 P
 4.00 CR P



14-020660-00 D B 97.00 C 170.60 D 99.50 E 4.00
14-021520-00 D B 98.00 C 170.60 D 100.00 E 6.00

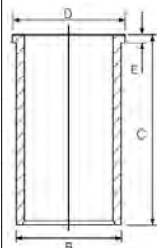

87-318700-30 STD
87-318710-30 0.80mm
 01/94→

A 54.00
B- 1.75
D 91.42
 30x79



08-318700-10 STD
08-318706-10 0.40mm
08-318708-10 0.60mm
08-318711-10 1.00mm

2.00 CR P
 2.00 P
 4.00 CR P



94.00

60

YTR (XD2/XD2P/XD94)	4cyl.	2304cc	49kW (67PS)	Diesel	TD1482
YTT (XD2/XD2P/XD94)	4cyl.	2304cc	49kW (67PS)	Diesel	TD1483
SIERRA 2.3 D			08/82→12/86	SIERRA II 2.3 D	01/87→02/93
SIERRA I 2.3 D			08/82→12/86		





87-318700-00 STD 1
87-318706-00 0.40mm 1
87-318708-00 0.60mm 1
87-318711-00 1.00mm 1

A 57.42
B- 2.00
D 99.90
 30x79



08-318700-10 STD
08-318706-10 0.40mm
08-318708-10 0.60mm
08-318711-10 1.00mm

2.00 CR P
 2.00 P
 4.00 CR P

14-020660-00 D **B** 97.00 **C** 170.60 **D** 99.50 **E** 4.00
14-021520-00 D **B** 98.00 **C** 170.60 **D** 100.00 **E** 6.00

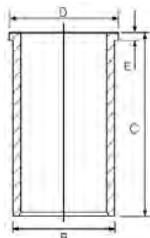

1 Pistons to be replaced in Engine Sets only 1 Kolben nur in Motorsätzen zu ersetzen 1 Piston à remplacer dans jeu moteur 1 Pistones de repuesto para juegos de motores solamente 1 Il pistone può essere rimpiazzato solamente completo

96.00 **61**

TD27	4cyl.	2663cc	74kW (100PS)	Diesel	Turbo	TD4494
TD27E	4cyl.	2664cc	92kW (125PS)	Diesel	Turbo Intercooled	TD9466
TD27 T	4cyl.	2664cc	73-74kW (100-101PS)	Diesel	Turbo Intercooled	TD1450

MAVERICK 2.7 TD 02/93→04/98 MAVERICK VAN 2.7 TD 06/96→04/98

14-020110-00 D **B** 99.08 **C** 160.00 **D** 105.03 **E** 5.09

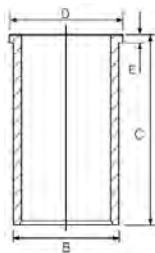

100.00 **62**

590E	6cyl.	5416cc		Diesel		MP2506
592E	4cyl.	3610cc		Diesel		MP2503-1

AGRICULTURAL INDUSTRIAL

87-203500-00 STD

A 71.04
B- 24.74
BØ 49.90
C 1.74
C 1.74
D 118.14
 35x86



08-203500-10 STD

2.38 CR P
 2.38 P
 2.38 P
 4.74 CR P
 4.74 P

14-370870-00 WH **B** 111.76 **C** 222.89 **D** 120.00 **E** 11.16 **F** 0.65

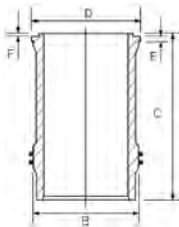

14-455210-00 WH **B** 109.60 **C** 223.00 **D** 117.60 **E** 11.20 **F** 0.80

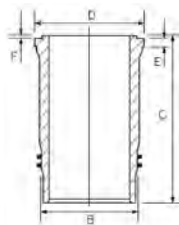



104.77						63
110/6 AA-DOVER	6cyl.	5944cc	81kW (110PS)	Diesel		TD22248
150/6 CA-DOVER	6cyl.	5944cc	110kW (150PS)	Diesel	Turbo	TD6957
2701E (240 cu.in.)	4cyl.	3933cc		Diesel		MP2512
2704E	6cyl.	5944cc		Diesel		MP2514
2704ET (360 cu.in.)	6cyl.	5944cc		Diesel	Turbo	MP2537
2706E (240 cu.in.)	4cyl.	3933cc		Diesel		MP2512-1
2709E	6cyl.	5944cc		Diesel		MP2514-1
2713E (365 cu.in. Parent Block)	6cyl.	5981cc		Diesel		MP2542

Cargo 01/82→01/96 INDUSTRIAL

14-013700-00 D B 108.80 C 219.00

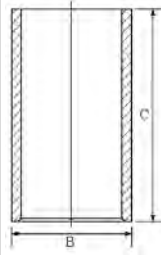

14-045570-00 D B 109.37 C 219.55 D 112.85 E 4.76

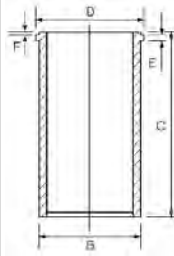

106.69						64
6Y SERIES 32D (158 cu.in)	3cyl.	2589cc		Diesel		MP6738-1
7A SERIES 32D (158 cu.in)	3cyl.	2589cc		Diesel		MP6736
7A SERIES 32D (180 cu.in.)	3cyl.	2950cc		Diesel		MP6735
56G	4cyl.	3819cc		Diesel		MP2974-1
2501E	3cyl.	2589cc		Diesel		MP6738
2502E	3cyl.	2589cc		Diesel		MP6738-2
2503E	3cyl.	2589cc		Diesel		MP6738-3
2504E (175 cu.in.)	3cyl.	2867cc		Diesel		MP6732
2508E (175 cu.in.)	3cyl.	2867cc		Diesel		MP6732-2
2508E D233	4cyl.	3819cc		Diesel		MP2974

AGRICULTURAL INDUSTRIAL

14-010770-00 D B 110.78 C 209.55

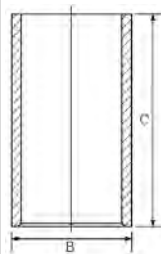

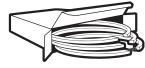

14-020730-00 *D* **B 110.80 C 209.60 D 111.80 E 5.00**

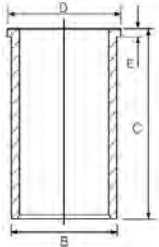

106.69 **65**

6Y SERIES (256 cu.in.)	4cyl.	4195cc	Diesel	MP6757
6Y SERIES 40D (175 cu.in.)	3cyl.	2867cc	Diesel	MP6733
7A SERIES (256 cu.in.)	4cyl.	4195cc	Diesel	MP6756
7A SERIES 40D (175 cu.in.)	3cyl.	2867cc	Diesel	MP6734

AGRICULTURAL

87-208100-10 *STD*

- A** 70.18
- B-** 17.12
- BØ** 63.32
- D** 129.01
- 38x89



RT

08-208100-00 *STD*

- 2.38 CR P
- 2.38 P
- 2.38 P
- 4.74 CR P

14-010770-00 *D* **B 110.78 C 209.55**

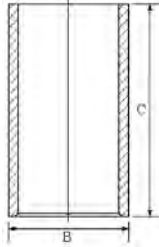

107.21 **66**

2711E (255 cu.in.)	4cyl.	4178cc	Diesel	MP2558
2712E (254 cu.in. Parent Block)	4cyl.	4162cc	Diesel	MP2559
2714E (380 cu.in)	6cyl.	6227cc	Diesel	MP2560
2715E (380 cu.in Parent Block D-Series)	6cyl.	6227cc	Diesel	MP2562

AGRICULTURAL INDUSTRIAL

- 87-214800-10** *STD*
- 87-214807-10** *.020*
- 87-214809-10** *.030*

- A** 71.20
- B-** 27.77
- BØ** 51.56
- C** 1.65
- C** 1.65
- D** 119.89
- 37x90



- 08-214800-10** *STD*
- 08-214807-10** *.020*
- 08-214809-10** *.030*
- 08-214811-10** *.040*

- 2.38 CR P
- 2.38 P
- 2.38 P
- 4.74 CR P

14-014120-00 *D* **B 111.40 C 213.00**
14-014640-00 *D* **B 110.78 C 213.00**

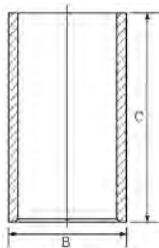



107.21 **67**

90/5 AA-DOVER	4cyl.	4162cc	63-66kW (86-90PS)	Diesel	TD6954
130/7 AA-DOVER	6cyl.	6223cc	94kW (128PS)	Diesel	TD6956

Cargo 05/81 → 01/96

87-782900-00 STD
87-782906-00 .015

08-782900-00 STD
08-782906-00 .015

A 71.25
B- 23.20
BØ 58.50
C 2.30
C 2.30
D 119.89
 37x86



2.38 CR P
 2.38 P
 4.74 CR P

RT

For Cast Iron Bores only Nur für Gußeisenbohrungen Pour intérieur cylindre seulement Para diámetro internos de hierro fundido solamente Solo per cilindri in ghisa solamente

111.77 **68**

2505E (192 CU.IN.)	3cyl.	3146cc	Diesel	MP3456
2506E (201CU.IN.)	3cyl.	3294cc	Diesel	MP3518
BSD 332 (192 CU.IN.)	3cyl.	3146cc	Diesel	MP3456-1
BSD333 >87 (201 cu.in.)	3cyl.	3294cc	Diesel	MP3518-1

AGRICULTURAL

INDUSTRIAL

14-020740-00 D **B** 114.45 **C** 208.50 **D** 120.35 **E** 2.60
14-020741-00 D **B** 116.00 **C** 208.50 **D** 120.35 **E** 2.60
14-020742-00 D **B** 116.99 **C** 208.50 **D** 120.35 **E** 2.60
14-021610-00 D **B** 114.43 **C** 208.53 **D** 120.35 **E** 2.56
14-021611-00 D **B** 116.97 **C** 208.53 **D** 120.35 **E** 2.57

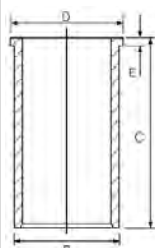

111.77 **69**

7A SERIES (201 cu.in.)	3cyl.	3294cc	Diesel	MP6730
BSD333 (201 cu.in.)	3cyl.	3294cc	Diesel	MP33519
BSD333H (201 cu.in.)	3cyl.	3294cc	Diesel	MP3519
BSD444 (268 cu.in.)	4cyl.	4391cc	Diesel	MP3521

AGRICULTURAL

87-202400-10 STD
87-202407-10 .020
 →07/87

08-202400-10 STD
08-202407-10 .020

A 68.12
B- 19.76
BØ 63.50
D 127.00
 38x89



2.38 CR P
 2.38 P
 2.38 P
 4.74 CR P

14-020740-00 D **B** 114.45 **C** 208.50 **D** 120.35 **E** 2.60
14-020741-00 D **B** 116.00 **C** 208.50 **D** 120.35 **E** 2.60
14-020742-00 D **B** 116.99 **C** 208.50 **D** 120.35 **E** 2.60
14-021610-00 D **B** 114.43 **C** 208.53 **D** 120.35 **E** 2.56
14-021611-00 D **B** 116.97 **C** 208.53 **D** 120.35 **E** 2.57

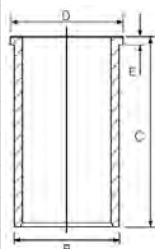

RT



111.77 **70**

268 CU.IN.	4cyl.	4391cc		Diesel	MP6749
401 CU.IN. (TW20,TW30)	6cyl.	6571cc		Diesel Turbo	MP6768
BSD444T (268 cu.in.)	4cyl.	4391cc		Diesel Turbo	MP3522

AGRICULTURAL

87-100100-00 STD

- A** 67.80
- B-** 19.00
- BØ** 63.70
- D** 127.00
-  41x89



RT

08-100100-00 STD

- 3.16  CR P
- 2.38  P
- 2.38  P
- 4.74  CR P

- 14-020740-00** D **B** 114.45 **C** 208.50 **D** 120.35 **E** 2.60
- 14-020741-00** D **B** 116.00 **C** 208.50 **D** 120.35 **E** 2.60
- 14-020742-00** D **B** 116.99 **C** 208.50 **D** 120.35 **E** 2.60
- 14-021610-00** D **B** 114.43 **C** 208.53 **D** 120.35 **E** 2.56
- 14-021611-00** D **B** 116.97 **C** 208.53 **D** 120.35 **E** 2.57

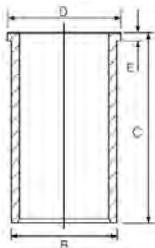

111.77 **71**

6Y SERIES (256 cu.in.)	4cyl.	4196cc	55-58kW (75-79PS)	Diesel	MP6752
7A SERIES (256 cu.in.)	4cyl.	4196cc	55-58kW (75-79PS)	Diesel	MP6752-1
BSD442 (256 cu.in.)	4cyl.	4195cc		Diesel	MP6747

AGRICULTURAL

87-202400-00 STD

- A** 70.66
- B-** 18.62
- BØ** 63.50
- D** 129.50
-  38x89



RT

08-202400-10 STD

08-202407-10 .020

- 2.38  CR P
- 2.38  P
- 2.38  P
- 4.74  CR P

- 14-020740-00** D **B** 114.45 **C** 208.50 **D** 120.35 **E** 2.60
- 14-020741-00** D **B** 116.00 **C** 208.50 **D** 120.35 **E** 2.60
- 14-020742-00** D **B** 116.99 **C** 208.50 **D** 120.35 **E** 2.60
- 14-021610-00** D **B** 114.43 **C** 208.53 **D** 120.35 **E** 2.56
- 14-021611-00** D **B** 116.97 **C** 208.53 **D** 120.35 **E** 2.57

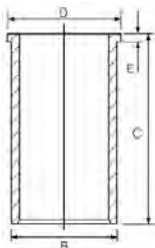

Motorverzeichnis • Index de moteur • Índice de Motor
 Indeks silnika • Модель ДВИгателя • دليل المحرك

ENGINE INDEX



CCM

x



9

100 GF 000	Petrol	903	4	65.00	1
100 GL.000	Petrol	903	4	65.00	1
126 A1.048	Petrol	652	2	77.00	3
ROVER K16 DOHC	Petrol	1396	4	75.00	2
XUD 9A	Diesel	1905	4	83.00	4



65.00 **1**

100 GF 000	4cyl.	903cc	26-29kW (35-39PS)	Petrol	TD22255
100 GL.000	4cyl.	903cc	30-33kW (41-45PS)	Petrol	TD22256
127P 0.9			10/69 → 10/76		

87-209800-00 STD
87-209806-00 0.40mm
87-209808-00 0.60mm

A 30.75
D 61.25
 20x54

08-209800-00 STD
08-209806-00 0.40mm
08-209808-00 0.60mm

1.75 CR P
 2.00 P
 3.94 P

14-011001-00 D **B** 68.04 **C** 115.00

75.00 **2**

ROVER K16 DOHC	4cyl.	1396cc	76kW (103PS)	Petrol	TD1494
POLONEZ 1.4 i 16V			04/94 → 09/98	POLONEZ III 1.4 i 16V	09/92 → 03/02

87-520500-00 STD
 01/95 →

A 23.84
D 46.79
 18x48

08-520500-00 STD

1.00 ①
 1.20
 2.00 NT ①

14-710030-00 WH **B** 84.10 **C** 129.50 **D** 87.50 **E** 50.00

88-520500-00
 87-520500-00 +
 14-710030-00

① Steel ① Stahl ① Acier ① Acero ① Acciaio

77.00 **3**

126 A1.048	2cyl.	652cc	17-22kW (23-30PS)	Petrol	TD24116
126P 0.6			07/77 → 12/91	126P 650	07/81 → 09/00

87-785500-00 STD
87-785506-00 0.40mm
87-785508-00 0.60mm

A 40.00
D 79.50
 20x61

08-785500-00 STD
08-785506-00 0.40mm
08-785508-00 0.60mm

1.50 CR P
 2.00 P
 3.94 CR ①

② **B** 83.00 **C** 130.40 **E** 79.90

88-785500-00
 87-785500-00

① Steel ① Stahl ① Acier ① Acero ① Acciaio
 ② Liner available in Kit Set only ② Zylinderlaufbuchse nur in Assemblies verfügbar ② Chemise disponible en kit seulement ② Camisas disponible en conjuntos solamente. ② Cilindro disponibile solo in kit motore

83.00 **4**

XUD 9A	4cyl.	1905cc	51kW (69PS)	Diesel	TD1493
POLONEZ 1.9 D			04/94 → 09/98	POLONEZ III 1.9 D	09/92 → 03/02
POLONEZ II 1.9 D			08/88 → 08/92		



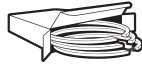

87-152000-10 STD
87-152007-10 0.50mm
87-152010-10 0.80mm

A 46.80
B- 2.20
D 84.30
 25x72



08-152000-00 STD
08-152003-00 0.125mm
08-152007-00 0.50mm
08-152010-00 0.80mm

2.00  CR P
 2.00  P
 3.00  CR P

14-020530-00 D

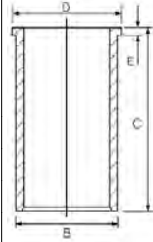

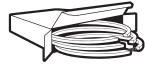

B 85.60 **C** 153.50 **D** 88.50 **E** 3.90





95.00					1
B	4cyl.	2977cc	59kW (80PS)	Diesel	MP1716
INDUSTRIAL					

87-526300-00 STD ⓘ

A 52.20
B- 2.50
D 101.20
 **F** 29x79



08-526300-00 STD

2.50  CR
 2.50  CR
 4.50  CR

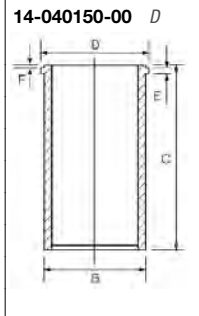

B 102.00 **C** 190.22 **D** 107.75 **E** 2.55 **F** 1.20

ⓘ Pistons to be replaced in Engine Sets only

ⓘ Kolben nur in Motorsätzen zu ersetzen

ⓘ Piston à remplacer dans jeu moteur

ⓘ Pistones de repuesto para juegos de motores solamente

ⓘ Il pistone può essere rimpiazzato solamente completo

Motorverzeichnis • Index de moteur • Índice de Motor
 Indeks silnika • Модель ДВИгателя • دليل المحرك

ENGINE INDEX



CCM

x



9

4EE-2	Diesel	1686	4	79.00	2
20T2N (L SERIES)	Diesel	1994	4	84.45	4
20T2R (L SERIES)	Diesel	1994	4	84.45	4
D16A	Petrol	1590	4	75.00	1
D16Y7	Petrol	1590	4	75.00	1
XUD7T (XUD7)	Diesel	1769	4	80.00	3



75.00 1



D16A	4cyl.	1590cc	79-91kW (107-124PS)	Petrol	TD17638
D16Y7	4cyl.	1590cc	77-79kW (105-107PS)	Petrol	TD11128
CIVIC II 1.6			01/88→12/92	CRX III 1.6 i	09/95→03/96
CIVIC VI 1.6			09/95→12/00	DOMANI 1.6	10/95→09/99
CIVIC VI 1.6 i			03/96→03/00	ORTHIA / PARTNER 1.6	10/95→09/99
CRX II 1.6 i 16V			10/87→12/91		

87-433700-00 STD
87-433707-00 0.50mm
 01/96→12/01

A 30.00
B- 3.47
BØ 63.63
C 3.60
C 2.00
D 50.00
 19x56
TP



08-433700-00 STD 1
08-433707-00 0.50mm 1

1.00  CR 2
 1.20  P
 2.85  CR 2

1 P07/P08 2 Steel 2 Stahl 2 Acier 2 Acero 2 Acciaio

79.00 2



4EE-2	4cyl.	1686cc	74kW (101PS)	Diesel	Turbo Intercooled	TD18735
CIVIC VII 1.7 CTDi			01/02→09/05			

87-307600-40 STD
87-307607-40 0.50mm

A 39.75
B- 14.00
BØ 38.70
C 1.10
D 84.00
 27x64
RT



08-307600-00 STD
08-307607-00 0.50mm

2.00  CR P
 1.50  CR P
 3.00  CR P

80.00 3



XUD7T (XUD7)	4cyl.	1769cc	58-65kW (79-88PS)	Diesel	Turbo Intercooled	TD18393
CITY 1.8 D			02/97→11/99			

87-323607-00 0.50mm

A 46.80
B- 2.20
D 84.50
 28x68
AK RT



08-323600-00 STD
08-323607-00 0.50mm

3.00  MOL P
 2.00  P
 3.00  CR P

14-024740-00 D **B** 83.50 **C** 154.00 **D** 85.70 **E** 4.60
14-024830-00 D **B** 83.00 **C** 154.00 **D** 86.00 **E** 4.50

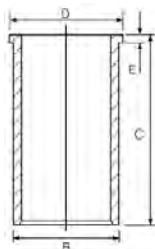

84.45 4

20T2N (L SERIES)	4cyl.	1994cc	74-77kW (101-105PS)	Diesel	Turbo Intercooled	TD5390
20T2R (L SERIES)	4cyl.	1994cc	63kW (86PS)	Diesel	Turbo Intercooled	TD22035
ACCORD V 2.0 TDi			04/96→10/98	CIVIC VI 2.0 i D	04/98→02/01	
ACCORD VI 2.0 TDi			12/99→10/00	CIVIC VI 2.0 i TD	01/97→02/01	





ACCORD VI 2.0 Turbo DI	02/99→12/02	CIVIC VI 2.0 TDiC	11/98→10/00
------------------------	-------------	-------------------	-------------

87-119800-00 STD

87-119807-00 0.50mm

- A 47.97
- B- 17.00
- BØ 38.00
- D 76.97
-  30x70

AK RT TP



08-119800-00 STD 

08-119807-00 0.50mm 

- 3.00  PS
- 2.00  P
- 3.00  CR

 15 degree Wedge Top Ring

 15-Grad Keilobering

 Segment trapézoïdal angle 15 de grés.

 Anillo superior en cuña de 15 grados

 Segmento trapezio con inclinazione fianchi = 15

ENGINE INDEX

Motorverzeichnis • Index de moteur • Índice de Motor
 Indeks silnika • Модель Двигателя • دليل المحرك



CCM

x



9

Engine Model	Fuel Type	CCM	x	Value	Value
4D31	Diesel	3298	4	100.00	19
4D31T	Diesel	3298	4	100.00	19
4D55	Diesel	2346	4	91.10	16
4D55T	Diesel	2346	4	91.10	17
4D56-T	Diesel	2477	4	91.10	18
D3EA	Diesel	1493	3	83.00	10
D4CB (Euro 4)	Diesel	2497	4	91.00	15
D4EA	Diesel	1991	4	83.00	11
D4EA-V (Euro 4)	Diesel	1991	4	83.00	12
D4FA	Diesel	1493	4	75.00	3
D4FB (Euro 4)	Diesel	1582	4	77.20	9
D4FB-5P	Diesel	1582	4	77.20	9
D4FB-L (Euro 4)	Diesel	1582	4	77.20	9
D4HA	Diesel	1995	4	84.00	14
DJY	Diesel	1905	4	83.00	13
G4ED (Euro 4)	Petrol	1599	4	76.50	6
G4EE (Euro 4)	Petrol	1399	4	75.50	4
G4EK	Petrol	1495	4	75.50	5
G4FA (Euro 4)	Petrol	1396	4	77.00	7
G4FJ	Petrol	1591	4	77.00	8
G4LA	Petrol	1248	4	71.00	1
G4LC	Petrol	1368	4	72.00	2



71.00

1

G4LA	4cyl.	1248cc	55-65kW (75-88PS)	Petrol	TD24880
i10 I 1.2			11/08→	i20 II 1.2	11/14→
i10 I 1.2 LPG			01/10→12/13	i20 II 1.2 LPG	01/19→
i10 II 1.2			12/13→	i20 II 1.2 LPGI	11/14→
i20 I 1.2			09/08→12/15	VENUE MPI	07/19→
i20 I 1.2 LPG			01/09→08/14		

87-448500-00 STD
87-448507-00 0.50mm

08-448500-00 STD
08-448507-00 0.50mm

A 24.70
B- 3.00
BØ 58.50
C 2.82
C 2.67
D 43.90
Ø 18x48



1.00 CR
1.20 P
2.00 PVD

Steel

Stahl

Acier

Acero

Acciaio

72.00

2

G4LC	4cyl.	1368cc	70-85kW (95-116PS)	Petrol	TD29872
ACCENT IV 1.4			11/10→	i20 II 1.4 MPI	11/14→
ACCENT V 1.4			07/18→	i20 III 1.4	05/21→
BAYON 1.4			05/21→	i30 1.4	12/14→
i20 1.4			09/15→	SOLARIS 1.4	01/17→
i20 II 1.4			11/14→		

87-423900-00 STD
87-423907-00 0.50mm

08-423900-00 STD
08-423907-00 0.50mm

A 24.70
B- 3.60
C 2.50
D 42.70
Ø 18x48



1.00 CR
1.20 P
2.00 PVD

Steel

Stahl

Acier

Acero

Acciaio

75.00

3

D4FA	4cyl.	1493cc	65-85kW (88-116PS)	Diesel Turbo Intercooled	TD18229
ACCENT III 1.5 CRDi GLS			11/05→11/10	i20 III 1.5 CRDi	11/20→
CRETA 1.5 CRDi			03/20→	MATRIX 1.5 CRDi	12/04→08/10
ELANTRA III D			01/05→09/06	MATRIX 1.5 CRDi VGT	08/05→08/10
GETZ 1.5 CRDi			08/05→06/09	SOLARIS 1.5 CRDi	05/20→
GETZ 1.5 CRDi GLS			07/04→06/09	VENUE CRDi	03/20→

87-849000-00 STD
87-849007-00 0.50mm

08-849000-00 STD
08-849007-00 0.50mm

A 41.95
B- 12.20
BØ 43.40
C 0.50
D 65.70
Ø 28x62



1.75 NT
1.75 CR P
3.00 NT

Steel

Stahl

Acier

Acero

Acciaio

AK KK RT



75.50 **4**

G4EE (Euro 4) 4cyl. **1399cc** **71kW (97PS)** **Petrol** **TD20722**

ACCENT III 1.4 GL 11/05→11/10 GETZ 1.4 i 08/05→12/10

87-849200-00 STD
87-849207-00 0.50mm

A 28.75
B+ 2.20
C 2.95
D 47.90
 18x48



08-849200-50 STD
08-849207-50 0.50mm

1.20 CR
1.20 P
2.00

Steel Stahl Acier Acero Acciaio

75.50 **5**

G4EK 4cyl. **1495cc** **63-95kW (85-129PS)** **Petrol** **TD4569**

ACCENT 1.5	10/94→12/99	ACCENT III 1.5	01/08→12/12
ACCENT 1.5 i 12V	10/94→01/00	ACCENT III 1.5 CNG	01/08→11/10
ACCENT I 1.5	10/94→12/02	GETZ 1.5	06/01→01/04
ACCENT I 1.5 i 12V	10/94→01/00	LANTRA II 1.5 12V	12/96→10/00
ACCENT II 1.5	09/99→12/06	S COUPE 1.5	01/91→12/95
ACCENT II 1.5 LPG	01/00→12/06	S COUPE 1.5 i	04/92→05/96

87-435407-00 0.50mm

A 31.37
B- 0.70
BØ 64.30
C 2.20
D 54.40
 18x48



08-435400-00 STD
08-435407-00 0.50mm

1.50 CR P
1.50 P
3.00 CR

Steel Stahl Acier Acero Acciaio

76.50 **6**

G4ED (Euro 4) 4cyl. **1599cc** **66-89kW (90-121PS)** **Petrol** **TD20721**

ACCENT II 1.6	01/00→12/05	ELANTRA III LPI	01/05→09/06
ACCENT III 1.6 GLS	11/05→11/10	GETZ 1.6	09/02→06/09
COUPE II 1.6 16V	03/02→08/09	MATRIX 1.6	06/01→08/10
ELANTRA III 1.6	06/00→07/06	TIBURON 1.6	10/06→12/08

87-424200-00 STD
87-424207-00 0.50mm

A 28.14
B- 0.40
BØ 60.40
C 3.00
D 50.14
 18x48



08-424200-10 STD
08-424205-10 0.25mm
08-424207-10 0.50mm

1.20 CR FE
1.20 P
2.00 NT P

Steel Stahl Acier Acero Acciaio

77.00 **7**

G4FA (Euro 4) 4cyl. **1396cc** **66-80kW (90-109PS)** **Petrol** **TD24881**

ACCENT IV 1.4	11/10→	i30 1.4 LPG	01/09→
i20 I 1.4	09/08→12/15	ix20 1.4	11/10→07/19





i20 I 1.4 LPG i30 1.4	12/08→12/12 10/07→	ix20 1.4 LPG	11/10→07/19
--------------------------	-----------------------	--------------	-------------

87-424800-00 STD
87-424807-00 0.50mm

A 26.90
B+ 1.40
C 4.50
D 45.30
18x52

TP

08-424800-30 STD
08-424805-30 0.25mm
08-424807-30 0.50mm

1.20 CR FE ①
1.20 P
2.00 CR P ①

① Steel ① Stahl ① Acier ① Acero ① Acciaio

77.00 **8**

G4FJ	4cyl.	1591cc	129-150kW (175-204PS)	Petrol	Turbo Intercooled	TD29281
ELANTRA VI 1.6 SR Turbo			02/16→	SONATA VIII 1.6		03/19→
i30 1.6 T-GDi			01/15→	TUCSON 1.6 T-GDi		06/15→
i30 1.6 T-GDi			11/16→	VELOSTER 1.6 T-GDi		08/12→12/17
KONA 1.6 T-GDi			06/17→	VELOSTER 1.6 T-GDi		01/18→
SONATA VII 1.6			09/14→			

87-426900-00 STD ①
87-426907-00 0.50mm

A 28.00
B- 3.00
C 2.00
C 2.80
D 45.00
20x52

TP

08-426900-00 STD
08-426907-00 0.50mm

1.20 PVD ②
1.50 P
2.00 NT ②

87-426900-10 STD ③
87-426907-10 0.50mm

A 28.00
B- 3.00
C 2.00
C 2.80
D 45.00
20x52

RT TP

08-426900-00 STD
08-426907-00 0.50mm

1.20 PVD ②
1.50 P
2.00 NT ②

① OE 230412BCB0 ② Stahl ② Acier ② Acero ② Acciaio
② Steel
③ OE 230412BAA0

77.20 **9**

D4FB (Euro 4)	4cyl.	1582cc	66-100kW (90-136PS)	Diesel	Turbo Intercooled	TD20726
D4FB-5P	4cyl.	1582cc	94kW (128PS)	Diesel	Turbo Intercooled	TD26998
D4FB-L (Euro 4)	4cyl.	1582cc	81kW (110PS)	Diesel	Turbo Intercooled	TD27228
ACCENT IV 1.6 CRDi			04/11→	i20 I 1.6 CRDi		09/08→12/12
ACCENT IV 1.6 CRDi			11/10→	i30 1.6 CRDi		10/07→
ACCENT V 1.6 CRDi			01/17→	i30 1.6 CRDi		05/15→
CRETA 1.6 CRDi			01/16→01/21	i30 1.6 CRDi VGT		10/07→
ELANTRA IV 1.6 CRDi			11/05→12/11	ix20 1.6 CRDi		06/11→07/19
ELANTRA V 1.6 CRDi			02/11→12/15	KONA 1.6 CRDi e-VGT		07/17→





ELANTRA VI 1.6 CRDi VGT	01/16→	SOLARIS 1.6 CRDi	01/17→
ELANTRA VI 1.6 D	02/16→		

87-434200-00 STD
87-434207-00 0.50mm

08-434200-00 STD
08-434207-00 0.50mm

A 41.95
B- 12.70
B- 2.80
BØ 18.20
C 0.50
D 65.70
 28x62



1.75  PVD NT ①
 1.75  CR P
 3.00  NT①

AK KK RT

① Steel ① Stahl ① Acier ① Acero ① Acciaio

83.00 **10**

D3EA 3cyl. **1493cc** **60kW** (82PS) **Diesel** **Turbo Intercooled** **TD16283**

ACCENT II 1.5 CRDi	01/02→11/05	MATRIX 1.5 CRDi	10/01→08/10
GETZ 1.5 CRDi	03/03→09/05		

87-431900-00 STD
87-431907-00 0.50mm

08-431900-00 STD ①
08-431907-00 0.50mm ①

A 46.30
B- 13.90
BØ 46.95
D 72.30
 28x66



1.90  CK P ②
 2.00  CR P
 3.00  NT②

AK NB RT

① Oil ring radial width 3.75mm ① Dicke Öiring: 3.75mm ① Largeur radiale du segment d'huile 3.75mm ① Ancho segmento de aceite 3,75mm ① Spessore radiale segmento raschiaolio : 3.75 mm
 ② Steel ② Stahl ② Acier ② Acero ② Acciaio

83.00 **11**

D4EA 4cyl. **1991cc** **83-110kW** (113-150PS) **Diesel** **Turbo Intercooled** **TD16321**

ELANTRA III 2.0 CRDi	04/01→07/06	SONATA V 2.0 CRDi	02/06→12/10
HIGHWAY VAN 2.0 CRDi	03/01→03/04	TRAJET 2.0 CRDi	04/01→07/08
i30 2.0 CRDi	10/07→06/12	TRAJET CRDi	04/04→07/08
SANTA FÉ I 2.0 CRDi	04/01→03/06	TUCSON 2.0 CRDi	08/04→03/10
SANTA FÉ I CRDi	04/01→03/06	TUCSON CRDi	01/06→03/10
SANTA FÉ II 2.0	01/05→12/09	TUCSON CRDi VGT	01/09→03/10
SANTA FÉ II 2.0 CRDi	03/06→12/12		

87-431900-00 STD
87-431907-00 0.50mm
 →12/07

08-431900-00 STD ①
08-431907-00 0.50mm ①

A 46.30
B- 13.90
BØ 46.95
D 72.30
 28x66



1.90  CK P ②
 2.00  CR P
 3.00  NT②

AK NB RT

① Steel ① Stahl ① Acier ① Acero ① Acciaio





87-430400-10 STD ③
87-430407-10 0.50mm
 01/08→

A 46.30
B- 16.95
BØ 42.70
D 72.30
 28x66



AK KK NB RT TP

08-430400-00 STD
08-430407-00 0.50mm

2.00 CK ②
 2.00 CR P
 3.00 NT ②

① Oil ring radial width 3.75mm

① Dicke Ölring: 3.75mm

① Largeur radiale du segment d'huile 3.75mm

① Ancho segmento de aceite 3,75mm

① Spessore radiale segmento raschiaolio : 3.75 mm

② Steel

② Stahl

② Acier

② Acero

② Acciaio

③ OE 2341027930

③ OE 2341027930

③ OE 2341027930

③ OE 2341027930

③ OE 2341027930

83.00

12

D4EA-V (Euro 4)	4cyl.	1991cc	92kW (125PS)	Diesel	Turbo Intercooled	TD20719
SANTA FE 2.0 TDI		10/06→12/13				

87-430400-00 STD ①
87-430407-00 0.50mm

A 46.30
B- 13.70
BØ 48.50
D 72.30
 28x66



AK KK NB RT TP

08-430400-00 STD
08-430407-00 0.50mm

2.00 CK ②
 2.00 CR P
 3.00 NT ②

① OE 2341027911

① OE 2341027911

① OE 2341027911

① OE 2341027911

① OE 2341027911

② Steel

② Stahl

② Acier

② Acero

② Acciaio

83.00

13

DJY	4cyl.	1905cc	50-52kW (68-71PS)	Diesel		TD22267
LANTRA II 1.9 D		03/98→10/00				

87-152000-10 STD
87-152007-10 0.50mm
87-152010-10 0.80mm

A 46.80
B- 2.20
D 84.30
 25x72



08-152000-00 STD
08-152003-00 0.125mm
08-152007-00 0.50mm
08-152010-00 0.80mm

2.00 CR P
 2.00 P
 3.00 CR P

14-020530-00 D

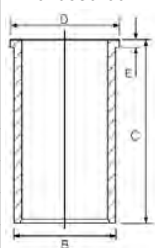

B 85.60 **C** 153.50 **D** 88.50 **E** 3.90

84.00

14

D4HA	4cyl.	1995cc	100-150kW (136-204PS)	Diesel	Turbo Intercooled	TD25694
ix35 2.0 CRDi			01/10→	SANTA FE IV 2.0 CRDi		02/18→
ix35 CRDi			08/09→12/15	TUCSON 2.0 CRDi		06/15→
SANTA FÉ II 2.0 CRDi			03/06→12/12	TUCSON 2.0 CRDi 48V		10/18→
SANTA FÉ III 2.0 CRDi			09/12→			





87-446400-00 STD
87-446407-00 0.50mm

A 48.90
B- 15.70
BØ 45.40
D 75.90
 34x66



AK KK RT TP

08-446400-00 STD
08-446407-00 0.50mm

2.50 CR P
 2.00 P
 3.00 NT

Steel

Stahl

Acier

Acero

Acciaio

91.00

15

D4CB (Euro 4)	4cyl.	2497cc	74-129kW (110-175PS)	Diesel	Turbo Intercooled	TD21021
H-1 2.5 CRDi			07/01→	H100 2.5 TD		01/10→
H-1 2.5 CRDI			02/08→	H350 2.5 CRDI		04/15→
H-1 / STAREX 2.5 CRDi			12/02→12/07	PORTER 2.5 CRDi		02/03→
H-1 / STAREX CRDi			01/02→12/07	PORTER 2.5 D		01/12→
H100 2.5 CRDI			01/04→			

87-431700-00 STD
87-431707-00 0.50mm

A 54.25
B- 15.00
BØ 52.00
C 0.30
D 83.75
 33x75



AK KK RT

08-431700-00 STD
08-431707-00 0.50mm

2.50 CK P
 2.00 CR P
 3.00 NT

Steel

Stahl

Acier

Acero

Acciaio

91.10

16

4D55	4cyl.	2346cc		Diesel		MP3377
GALLOPER Jeep 2.4D			01/80→12/86	PORTER TRUCK 2.4		01/80→12/86
GRACE 2.4			01/80→12/86			

14-015590-00 D **B 94.13 C 164.50**

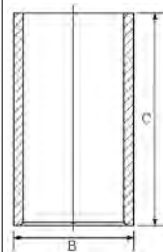

91.10

17

4D55T	4cyl.	2346cc	49kW (67PS)	Diesel	Turbo Intercooled	MP3828
GALLOPER 2.4						





87-287100-30 STD
87-287107-30 0.50mm

- A** 48.70
- B-** 3.10
- C** 2.30
- D** 88.70
-  29x75

RT



08-287100-00 STD 
08-287107-00 0.50mm

- 2.50  MO P
- 2.00  CR P
- 4.00  CR P

14-015590-00 D

B 94.13 **C** 164.50

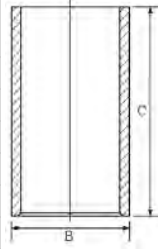

 OE: MD103391

91.10

18

4D56-T 4cyl. **2477cc** **62-74kW** (84-101PS) **Diesel** **Turbo Intercooled** **TD18860**

GALLOPER I 2.5 TD 08/91→07/98 H100 2.5 TD 11/06→

87-287100-30 STD
87-287107-30 0.50mm

- A** 48.70
- B-** 3.10
- C** 2.30
- D** 88.70
-  29x75

RT



08-287100-00 STD 
08-287107-00 0.50mm

- 2.50  MO P
- 2.00  CR P
- 4.00  CR P

14-015590-00 D

B 94.13 **C** 164.50

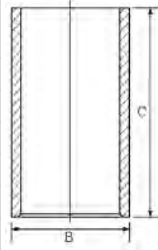

 OE: MD103391

100.00

19

4D31 4cyl. **3298cc** **Diesel** **MP19502**

4D31T 4cyl. **3298cc** **Diesel** **Turbo Intercooled** **MP9515**

CANTER 3.3 01/87→ TRUCK 3.5 ton 01/82→09/85

ROSA BUS 3.3 01/85→12/86

14-010970-00 D

B 104.00 **C** 196.50

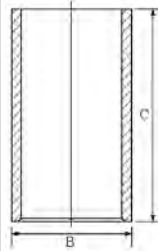

ENGINE INDEX

Motorverzeichnis • Index de moteur • Índice de Motor
 Indeks silnika • Модель Двигателя • دليل المحرك



CCM

x



9

D-179	Diesel	2933	3	98.42	1
D-239	Diesel	3911	4	98.42	1
D-358	Diesel	5867	6	98.42	1
DT-239	Diesel	3911	4	98.42	1
DT-358	Diesel	5667	6	98.42	1



98.42						1
D-179	3cyl.	2933cc	33-38kW (45-52PS)	Diesel		TD18802
D-239	4cyl.	3911cc	45-56kW (61-76PS)	Diesel		TD18804
D-358	6cyl.	5867cc	66-101kW (90-137PS)	Diesel		TD18807
DT-239	4cyl.	3911cc	59-63kW (80-86PS)	Diesel	Turbo	TD18810
DT-358	6cyl.	5667cc	88-100kW (120-136PS)	Diesel	Turbo	TD18808
743			01/80→12/89	B-Series		01/74→12/80
856			01/83→12/91	CM-Series		01/65→12/94
A-Series			01/75→12/89	C-Series		01/77→12/92

14-451170-00 *WH*

B 110.75 C 215.00 D 119.00 E 7.70 F 1.10

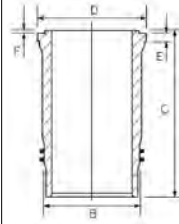

ENGINE INDEX

Motorverzeichnis • Index de moteur • Índice de Motor
 Indeks silnika • Модель Двигателя • دليل المحرك



CCM

x



9

4HF1-II	Diesel	4334	4	112.00	6
4HG1-T (Euro 2)	Diesel	4570	4	115.00	7
4HK1-TC (Euro 3/4)	Diesel	5193	4	115.00	8
4JA1T	Diesel	2500	4	93.00	4
4JB1	Diesel	2771	4	93.00	4
C 20 NE	Petrol	1998	4	86.00	1
C190	Diesel	1951	4	86.00	2
C 223	Diesel	2238	4	88.00	3
C 240	Diesel	2369	4	86.00	2
TD27	Diesel	2663	4	96.00	5



86.00

1

C 20 NE 4cyl. **1998cc** **85kW** (115PS) **Petrol** **TD26802**

KB 2.0 07/02→06/04

87-306800-30 STD

A 30.40
B- 5.00
BØ 57.00
D 50.40
 21x62
TP



08-306800-00 STD

08-306807-00 0.50mm
 08-306811-00 1.00mm

1.50  CR P
 1.50  P
 3.00  CR T

 Steel

 Stahl

 Acier

 Acero

 Acciaio

86.00

2

C 190 4cyl. **1951cc** **40kW** (54PS) **Diesel** **TD1685**

C 240 4cyl. **2369cc** **44-51kW** (60-69PS) **Diesel** **TD26269**

CAMPO 2.0 D

ELF 2.4 D

ELF 2.0 D

GEMINI 2.0 D

14-021180-00 D

B 90.13 **C** 178.50 **D** 94.00 **E** 4.00

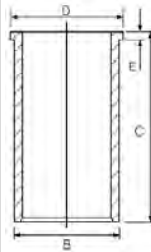

88.00

3

C 223 4cyl. **2238cc** **39-54kW** (53-73PS) **Diesel** **TD1686**

117 2.2 D

06/79→06/81

TFR/TFS 2.2

10/92→08/93

CAMPO 2.2 D

01/83→12/91

TROOPER I 2.2 D

05/84→12/89

KB 2.2 D

01/83→03/88

14-021190-00 D

B 92.13 **C** 163.50 **D** 95.00 **E** 4.00

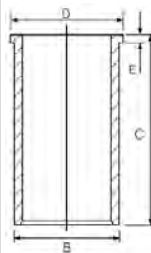

93.00

4

4JA1T 4cyl. **2500cc** **52-86kW** (71-117PS) **Diesel Turbo** **TD8401**

4JB1 4cyl. **2771cc** **42-74kW** (57-101PS) **Diesel** **TD1670**

D-MAX I 2.5

07/05→06/12

N (5th Generation)

10/92→06/06

ELF

10/85→09/03

PANTHER I 2.5 TD

03/91→08/00

ELF 2.8 D

10/85→09/03

PICKUP 2.5

11/15→

FRONTIER 2.8 D

11/97→08/03

PICKUP 2.5 TD

06/92→12/02

KB 2.5 D

07/94→09/03

TFR/TFS 2.5 TD

09/88→12/00

KB 2.5 TDi

12/90→

TFR/TFS 2.8 D

09/91→08/99

MTB

01/94→12/04





87-246200-00 STD

- A 51.84
- B- 14.40
- BØ 48.00
- C 0.49
- D 91.84
- 31x76



AK RT

08-246200-00 STD

- 2.00 P
- 2.00 P
- 4.00 P

96.00

5

TD27 4cyl. **2663cc** **58-73kW** (79-99PS) **Diesel** **TD21156**

ELF 2.7 TD 10/99→09/01

14-020110-00 D

B 99.08 C 160.00 D 105.03 E 5.09

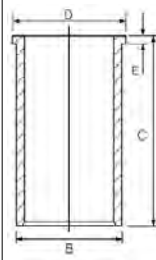

112.00

6

4HF1-II 4cyl. **4334cc** **76kW** (103PS) **Diesel Turbo** **TD27981**

N (5th Generation) 10/92→09/03

87-446200-00 STD

- A 60.75
- B- 22.00
- BØ 49.60
- D 94.50
- 36x79



RT

08-446200-00 STD

- 3.00 CR NT ①
- 2.50 CR P
- 4.00 NT ①

14-020780-00 D ②

B 115.00 C 180.00 D 121.70 E 6.10

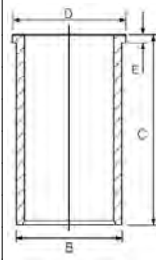

- ① Steel
- ② Phosphated

- ① Stahl
- ② Phosphatiert

- ① Acier
- ② Fosfaté

- ① Acero
- ② Fosfatado

- ① Acciaio
- ② Fosfatato

115.00

7

4HG1-T (Euro 2) 4cyl. **4570cc** **85-103kW** (116-140PS) **Diesel Turbo** **TD22127**

ELF 4.6 DiTD 10/99→09/03 N 01/07→12/14

ELF 4.6 TD 10/92→09/00 N (5th Generation) 10/92→12/03

87-447900-00 STD ①
→12/05

- A 60.75
- B- 22.50
- BØ 51.00
- D 119.50
- 36x79



AK KK RT

08-447900-00 STD

- 3.00 NT ②
- 2.50 CR P
- 4.00 NT ②

- ① Euro 2
- ② Steel

- ② Stahl

- ② Acier

- ② Acero

- ② Acciaio



115.00 **8**

4HK1-TC (Euro 3/4) 4cyl. **5193cc** **110-155kW (150-211PS)** **Diesel** **Turbo Intercooled** **TD31421**

ELF-SERIE 03/10→07/14 FORWARD F 01/06→
 FORWARD 01/06→ N (6th Generation) 10/06→

87-446300-00 STD

- A** 66.15
- B-** 18.80
- BØ** 61.90
- D** 96.65
-  40x87



AK KK RT

- ① Steel
- ② Phosphated

08-446300-00 STD

- 3.00  NT ①
- 2.50  CR P
- 4.00  NT ①

- ① Stahl
- ② Phosphatiert

14-021930-00 DH ②

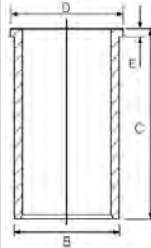

- ① Acier
- ② Phosphaté

B 118.00 C 210.00 D 123.70 E 6.10

- ① Acero
- ② Fosfatado

- ① Acciaio
- ② Fosfatato

ENGINE INDEX

Motorverzeichnis • Index de moteur • Índice de Motor
 Indeks silnika • Модель Двигателя • دليل المحرك



CCM

x



9

203 A/61	Diesel	11548	6	130.00	54
203 H 61	Diesel	11548	6	130.00	54
310 H/61	Diesel	11548	6	130.00	54
803 A.062 (8030.01)	Diesel	2339	3	95.00	14
804A (8040.01)	Diesel	3119	4	95.00	14
806 A (8060.01/.11)	Diesel	4678	6	95.00	14
8025.01	Diesel	1559	2	95.00	14
8025.02	Diesel	1728	2	100.00	17
8030.02	Diesel	2592	3	100.00	17
8035.02	Diesel	2592	3	100.00	17
8035.04	Diesel	2748	3	103.00	24
8035.05	Diesel	2930	3	104.00	28
8035.06	Diesel	2708	3	100.00	18
8040.02	Diesel	3456	4	100.00	19
8040.02	Diesel	3455	4	100.00	19
8040.25B.4200	Diesel	3908	4	104.00	31
8040.25X.4000	Diesel	3908	4	104.00	31
8040.45D.5100 (Euro 2)	Diesel	3908	4	104.00	29
8040.45D.5101 (Euro 2)	Diesel	3908	4	104.00	29
8040.45D.5103 (Euro 2)	Diesel	3908	4	104.00	29
8040.45D.5105 (Euro 2)	Diesel	3908	4	104.00	29
8040.45X.4180	Diesel	3908	4	104.00	34
8041 L	Diesel	3666	4	103.00	25
8045.02	Diesel	3456	4	100.00	17
8045.05	Diesel	3908	4	104.00	28
8045.06	Diesel	3613	4	100.00	18
8055.04	Diesel	4583	5	103.00	24
8060.04	Diesel	5499	6	103.00	24
8060.25V.4000	Diesel	5861	6	104.00	29
8060.25V.4000 (Euro 1)	Diesel	5861	6	104.00	31
8060.25V.4080	Diesel	5861	6	104.00	31
8060.25V.4800	Diesel	5861	6	104.00	31
8060.25R.4200	Diesel	5861	6	104.00	33
8060.25R.4200 (Euro 1)	Diesel	5861	6	104.00	31
8060.25R.4200 LTC	Diesel	5861	6	104.00	33
8060.25R.4210 (Euro 1)	Diesel	5861	6	104.00	29
8060.25R.4220 (Euro 1)	Diesel	5861	6	104.00	29
8060.25R.4225 (Euro 1)	Diesel	5861	6	104.00	29
8060.25R.4230 (Euro 1)	Diesel	5861	6	104.00	29
8060.25R.4240 (Euro 1)	Diesel	5861	6	104.00	29
8060.25R.4250 (Euro 1)	Diesel	5861	6	104.00	29
8060.25R.4280	Diesel	5861	6	104.00	33
8060.25R.4280	Diesel	5861	6	104.00	31
8060.25R.4285 (Euro 1)	Diesel	5861	6	104.00	29
8060.25R.4290 (Euro 1)	Diesel	5861	6	104.00	29
8060.25R.4295 (Euro 1)	Diesel	5861	6	104.00	29
8060.25R.4300	Diesel	5861	6	104.00	31
8060.25R.4360 (Euro 1)	Diesel	5861	6	104.00	29
8060.25R.4362 (Euro 1)	Diesel	5861	6	104.00	29
8060.25R.4750	Diesel	5861	6	104.00	29
8060.25R.4755	Diesel	5861	6	104.00	29
8060.25R.4760	Diesel	5861	6	104.00	29
8060.25R.4764	Diesel	5861	6	104.00	29
8060.25R.4960 (Euro 1)	Diesel	5861	6	104.00	29
8060.25R.4967 (Euro 1)	Diesel	5861	6	104.00	29
8060.25R.4968 (Euro 1)	Diesel	5861	6	104.00	29
8060.25R.4970 (Euro 1)	Diesel	5861	6	104.00	29
8060.25R.4973 (Euro 1)	Diesel	5861	6	104.00	29
8060.25R.4980 (Euro 1)	Diesel	5861	6	104.00	29
8060.45 (Euro 1)	Diesel	5861	6	104.00	33



CCM



9

8060.45B (Euro 2)	Diesel	5861	6	104.00	29
8060.45B.5100 (Euro 2)	Diesel	5861	6	104.00	29
8060.45B.5101 (Euro 2)	Diesel	5861	6	104.00	29
8060.45B.5103 (Euro 2)	Diesel	5861	6	104.00	29
8060.45B.5105 (Euro 2)	Diesel	5861	6	104.00	29
8060.45B.5111 (Euro 2)	Diesel	5861	6	104.00	29
8060.45B.5112 (Euro 2)	Diesel	5861	6	104.00	29
8060.45B.5113 (Euro 2)	Diesel	5861	6	104.00	29
8060.45B.5120 (Euro 2)	Diesel	5861	6	104.00	29
8060.45B.5121 (Euro 2)	Diesel	5861	6	104.00	29
8060.45B.5123 (Euro 2)	Diesel	5861	6	104.00	29
8060.45B.5124 (Euro 2)	Diesel	5861	6	104.00	29
8060.45B.5145 (Euro 2)	Diesel	5861	6	104.00	29
8060.45B.5146 (Euro 2)	Diesel	5861	6	104.00	29
8060.45B.5150 (Euro 2)	Diesel	5861	6	104.00	29
8060.45B.5151 (Euro 2)	Diesel	5861	6	104.00	29
8060.45B.5185 (Euro 2)	Diesel	5861	6	104.00	29
8060.45B.5186 (Euro 2)	Diesel	5861	6	104.00	29
8060.45K.6090 (Euro 1)	Diesel	5861	6	104.00	29
8060.45L.4400	Diesel	5861	6	104.00	29
8060.45M.7200	Diesel	5861	6	104.00	29
8060.45R.5000 (Euro 2)	Diesel	5861	6	104.00	34
8060.45R.5001 (Euro 2)	Diesel	5861	6	104.00	29
8060.45R.5003 (Euro 2)	Diesel	5861	6	104.00	29
8060.45R.5050	Diesel	5861	6	104.00	29
8060.45S.6000	Diesel	5861	6	104.00	29
8060.45S.6000 (Euro 1)	Diesel	5861	6	104.00	29
8060.45S.6203 (Euro 1)	Diesel	5861	6	104.00	29
8060.45S.6800 (Euro 1)	Diesel	5861	6	104.00	29
8060.45S.6800 (Euro 1)	Diesel	5861	6	104.00	35
8060.45S.7200 (Euro 2)	Diesel	5861	6	104.00	29
8060.45S TCA	Diesel	5861	6	104.00	29
8061 L	Diesel	5499	6	103.00	25
8061.05	Diesel	5861	6	104.00	30
8061.25	Diesel	5868	6	104.00	32
8065.E	Diesel	5861	6	104.00	28
8065.04	Diesel	5499	6	103.00	24
8065.04-H	Diesel	5499	6	103.00	24
8140.23 (Euro 2 Sofim)	Diesel	2800	4	94.40	9
8140.27R.2700	Diesel	2500	4	93.00	7
8140.27R.2780	Diesel	2500	4	93.00	4
8140.27R.2782	Diesel	2500	4	93.00	4
8140.27R.2786	Diesel	2500	4	93.00	4
8140.27R.2787	Diesel	2500	4	93.00	4
8140.27 S (SOFIM 2.5TD)	Diesel	2445	4	93.00	6
8140.27S.2700 (Sofim)	Diesel	2500	4	93.00	7
8140.27S.2701	Diesel	2500	4	93.00	4
8140.27S.2710	Diesel	2500	4	93.00	4
8140.27S.2711	Diesel	2500	4	93.00	4
8140.27S.2720	Diesel	2500	4	93.00	4
8140.27S.2721	Diesel	2500	4	93.00	4
8140.27S.2730	Diesel	2500	4	93.00	4
8140.27S.2731	Diesel	2500	4	93.00	4
8140.27S.2750	Diesel	2500	4	93.00	4
8140.27S.2751	Diesel	2500	4	93.00	4
8140.27S.2760	Diesel	2500	4	93.00	4
8140.27S.2761	Diesel	2500	4	93.00	4
8140.27S.2770	Diesel	2500	4	93.00	4
8140.27S.2771	Diesel	2500	4	93.00	4
8140.27S.2801 (Sofim)	Diesel	2500	4	93.00	7

ENGINE INDEX

Motorverzeichnis • Index de moteur • Índice de Motor
 Indeks silnika • Модель Двигателя • دليل المحرك



CCM

x



9

8140.27S.2811	Diesel	2500	4	93.00	4
8140.27S.2885 (Sofim)	Diesel	2500	4	93.00	7
8140.27S.3700	Diesel	2500	4	93.00	6
8140.27S.3701	Diesel	2500	4	93.00	6
8140.27S.3711	Diesel	2500	4	93.00	6
8140.27S.3720	Diesel	2500	4	93.00	6
8140.27S.3721	Diesel	2500	4	93.00	6
8140.27S.3750	Diesel	2500	4	93.00	6
8140.27S.3751	Diesel	2500	4	93.00	6
8140.27S.3760	Diesel	2500	4	93.00	6
8140.27S.3761	Diesel	2500	4	93.00	6
8140.27S.3770	Diesel	2500	4	93.00	6
8140.27S.3771	Diesel	2500	4	93.00	6
8140.27S.3780	Diesel	2500	4	93.00	6
8140.27S.3781	Diesel	2500	4	93.00	6
8140.27S.3811	Diesel	2500	4	93.00	6
8140.43 (Euro 2 Sofim)	Diesel	2800	4	94.40	9
8140.43B (Euro 3 Sofim)	Diesel	2800	4	94.40	10
8140.43B.4300 (Euro 3 Sofim)	Diesel	2800	4	94.40	10
8140.43B.4305 (Euro 3 Sofim)	Diesel	2800	4	94.40	10
8140.43B.4320 (Euro 3 Sofim)	Diesel	2800	4	94.40	10
8140.43B.4325 (Euro 3 Sofim)	Diesel	2800	4	94.40	10
8140.43B.4330 (Euro 3 Sofim)	Diesel	2800	4	94.40	10
8140.43B.4335 (Euro 3 Sofim)	Diesel	2800	4	94.40	10
8140.43C (Euro 2 Sofim)	Diesel	2800	4	94.40	9
8140.43C.4000 (Euro 3 Sofim)	Diesel	2800	4	94.40	11
8140.43C.4005 (Euro 3 Sofim)	Diesel	2800	4	94.40	11
8140.43C.4020 (Euro 3 Sofim)	Diesel	2800	4	94.40	11
8140.43C.4021 (Euro 3 Sofim)	Diesel	2800	4	94.40	11
8140.43C.4025 (Euro 3 Sofim)	Diesel	2800	4	94.40	11
8140.43C.4026 (Euro 3 Sofim)	Diesel	2800	4	94.40	11
8140.43C.4030 (Euro 3 Sofim)	Diesel	2800	4	94.40	11
8140.43C.4031 (Euro 3 Sofim)	Diesel	2800	4	94.40	11
8140.43C.4035 (Euro 3 Sofim)	Diesel	2800	4	94.40	11
8140.43C.4036 (Euro 3 Sofim)	Diesel	2800	4	94.40	11
8140.43K.4020 (Euro 3 Sofim)	Diesel	2800	4	94.40	12
8140.43K.4030 (Euro 3 Sofim)	Diesel	2800	4	94.40	12
8140.43N (Euro 3 Sofim)	Diesel	2800	4	94.40	12
8140.43N.4300 (Euro 3 Sofim)	Diesel	2800	4	94.40	12
8140.43N.4320 (Euro 3 Sofim)	Diesel	2800	4	94.40	12
8140.43N.4330 (Euro 3 Sofim)	Diesel	2800	4	94.40	12
8140.43N.4400 (Euro 3 Sofim)	Diesel	2800	4	94.40	12
8140.43N.4430 (Euro 3 Sofim)	Diesel	2800	4	94.40	12
8140.43S (Euro 3 Sofim)	Diesel	2800	4	94.40	12
8140.43S.4000 (Euro 3 Sofim)	Diesel	2800	4	94.40	12
8140.43S.4020 (Euro 3 Sofim)	Diesel	2800	4	94.40	12
8140.43S.4030 (Euro 3 Sofim)	Diesel	2800	4	94.40	12
8140.43S.4140 (Euro 3 Sofim)	Diesel	2800	4	94.40	12
8140.43S.4300 (Euro 3 Sofim)	Diesel	2800	4	94.40	12
8140.43S.4320 (Euro 3 Sofim)	Diesel	2800	4	94.40	12
8140.43S.4330 (Euro 3 Sofim)	Diesel	2800	4	94.40	12
8140.43S.4400 (Euro 3 Sofim)	Diesel	2800	4	94.40	12
8140.43S.4420 (Euro 3 Sofim)	Diesel	2800	4	94.40	12
8140.43S.4430 (Euro 3 Sofim)	Diesel	2800	4	94.40	12
8140.47B.3790 (Euro 1)	Diesel	2500	4	93.00	6
8140.47B.3795 (Euro 1)	Diesel	2500	4	93.00	6
8140.47R	Diesel	2500	4	93.00	6
8140.47R.2790	Diesel	2500	4	93.00	6
8140.47R.2795	Diesel	2500	4	93.00	6
8140.47S (Euro 1)	Diesel	2500	4	93.00	6



CCM



9

8140.63 (Euro 2 Sofim)	Diesel	2800	4	94.40	13
8140.67 (290B7W)	Diesel	2500	4	93.00	8
8140.67F. (Euro 2)	Diesel	2500	4	93.00	4
8140.67F.3700 (Euro 2)	Diesel	2500	4	93.00	4
8140.67F.3701 (Euro 2)	Diesel	2500	4	93.00	4
8140.67F.3710 (Euro 2)	Diesel	2500	4	93.00	4
8140.67F.3711 (Euro 2)	Diesel	2500	4	93.00	4
8140.67F.3713 (Euro 2)	Diesel	2500	4	93.00	4
8140.67F.3721 (Euro 2)	Diesel	2500	4	93.00	4
8144.67	Diesel	2500	4	93.00	8
8200.02	Diesel	9820	6	122.00	49
8200.03	Diesel	10308	6	125.00	50
8200.12	Diesel	9820	6	122.00	49
8200.13	Diesel	10308	6	125.00	50
8205.02	Diesel	9820	6	122.00	49
8205.03	Diesel	10308	6	125.00	50
8210.02	Diesel	13800	6	137.00	57
8210.22	Diesel	13798	6	137.00	58
8210.22X.069	Diesel	13798	6	137.00	59
8210.22X.235	Diesel	13798	6	137.00	58
8210.22X.523	Diesel	13798	6	137.00	59
8210.22X.575	Diesel	13798	6	137.00	59
8210.42	Diesel	13798	6	137.00	60
8210.42 K	Diesel	13798	6	137.00	61
8210.42K (Euro 2)	Diesel	13798	6	137.00	61
8210.42K (TCA) (Euro 1)	Diesel	13798	6	137.00	59
8210.42L (Euro 2)	Diesel	13798	6	137.00	62
8210.42L (TCA) (Euro 2)	Diesel	13798	6	137.00	62
8210.42L.(TCA) (Euro 1)	Diesel	13798	6	137.00	61
8210.42L.400 (Euro 1)	Diesel	13798	6	137.00	61
8210.42M (TCA) (Euro 2)	Diesel	13798	6	137.00	59
8211.02	Diesel	13798	6	137.00	57
8211.22	Diesel	13798	6	137.00	58
8212.00	Diesel	13800	6	137.00	59
8215.00	Diesel	13800	6	137.00	59
8215.02	Diesel	13798	6	137.00	57
8217.00	Diesel	13798	6	137.00	59
8217.32	Diesel	13798	6	137.00	59
8260.01	Diesel	12800	6	137.00	59
8260.02	Diesel	12880	6	145.00	63
8280.01	Diesel	17174	V8	145.00	63
8281.02	Diesel	17174	V8	145.00	63
8285.02	Diesel	17174	V8	145.00	63
8285.22	Diesel	17174	V8	145.00	64
8340.05	Diesel	5401	4	115.00	41
8360.04	Diesel	6855	6	115.00	40
8360.05	Diesel	8100	6	115.00	41
8360.46	Diesel	7685	6	112.00	39
8360.46B.4591	Diesel	7684	6	112.00	39
8360.46R.416 (TCA)	Diesel	7685	6	112.00	39
8361.04	Diesel	6850	6	115.00	40
8361.05	Diesel	8102	6	115.00	41
8460.21B.613	Diesel	9500	6	120.00	48
8460.21B.615	Diesel	9500	6	120.00	48
8460.41C	Diesel	9500	6	120.00	48
8460.41C (TCA)	Diesel	9500	6	120.00	48
8460.41C.320	Diesel	9500	6	120.00	48
8460.41K (Euro 2)	Diesel	9500	6	120.00	48
8460.41K. TCA (Euro 1)	Diesel	9500	6	120.00	48
8460.41K.406	Diesel	9500	6	120.00	48

ENGINE INDEX

Motorverzeichnis • Index de moteur • Índice de Motor
 Indeks silnika • Модель Двигателя • دليل المحرك



CCM

x



9

8460.41K.410	Diesel	9500	6	120.00	48
8460.41L (TCA)	Diesel	9500	6	120.00	48
8460.41L.5020	Diesel	9500	6	120.00	48
8460.41 M	Diesel	9500	6	120.00	47
8460.41 R	Diesel	9500	6	120.00	48
8460.41 S	Diesel	9500	6	120.00	48
8460.41S.733 (Euro 1)	Diesel	9498	6	120.00	47
8460.41 T	Diesel	9500	6	120.00	47
8035.04.265	Diesel	2749	3	103.00	24
8035.04.270	Diesel	2749	3	103.00	24
8035.05.214	Diesel	2931	3	104.00	29
8035.05.215	Diesel	2931	3	104.00	29
8035.06.200	Diesel	2708	3	100.00	18
8035.06.206	Diesel	2708	3	100.00	18
8035.06.208	Diesel	2708	3	100.00	18
8035.06.216	Diesel	2708	3	100.00	18
8035.06.220	Diesel	2708	3	100.00	18
8035.06.222	Diesel	2708	3	100.00	18
8035.06.223	Diesel	2708	3	100.00	18
8035.06.306	Diesel	2708	3	100.00	18
8035.06.307	Diesel	2708	3	100.00	18
8035.06.308	Diesel	2708	3	100.00	18
8035.06.309	Diesel	2708	3	100.00	18
8035.06.317	Diesel	2708	3	100.00	18
8035.06.320	Diesel	2708	3	100.00	18
8035.06.321	Diesel	2708	3	100.00	18
8035.06.322	Diesel	2708	3	100.00	18
8035.06.323	Diesel	2708	3	100.00	18
8040.02.041	Diesel	3456	4	100.00	19
8040.02.267	Diesel	3456	4	100.00	19
8040.02.300	Diesel	3456	4	100.00	19
8040.02.360	Diesel	3456	4	100.00	19
8040.02.367	Diesel	3456	4	100.00	19
8040.04.200	Diesel	3666	4	103.00	24
8040.05.200	Diesel	3908	4	104.00	30
8040.05.203	Diesel	3908	4	104.00	30
8040.05.230	Diesel	3908	4	104.00	30
8040.05.233	Diesel	3908	4	104.00	30
8040.05.235	Diesel	3908	4	104.00	30
8040.05.4990	Diesel	3908	4	104.00	31
8040.05.4990	Diesel	3908	4	104.00	29
8040.25.000	Diesel	3908	4	104.00	32
8040.25.200	Diesel	3908	4	104.00	32
8040.25.220	Diesel	3908	4	104.00	32
8040.25.230	Diesel	3908	4	104.00	32
8040.25.4990	Diesel	3908	4	104.00	29
8040.45.4000	Diesel	3908	4	104.00	33
8040.45.4180	Diesel	3908	4	104.00	29
8040.45.4380	Diesel	3908	4	104.00	29
8040.45.5200 (Euro 2)	Diesel	3908	4	104.00	29
8040.45.5201 (Euro 2)	Diesel	3908	4	104.00	29
8040.45.5203 (Euro 2)	Diesel	3908	4	104.00	29
8040.45.5280 (Euro 2)	Diesel	3908	4	104.00	29
8040.45.5281 (Euro 2)	Diesel	3908	4	104.00	29
8045.04.270	Diesel	3666	4	103.00	24
8045.05.000	Diesel	3908	4	104.00	29
8045.05.213	Diesel	3908	4	104.00	29
8045.05.215	Diesel	3908	4	104.00	29
8045.06.200	Diesel	3613	4	100.00	18
8045.06.208	Diesel	3613	4	100.00	18



CCM



9

8045.06.213	Diesel	3613	4	100.00	18
8045.06.214	Diesel	3613	4	100.00	18
8045.06.215	Diesel	3613	4	100.00	18
8045.06.225	Diesel	3613	4	100.00	18
8045.06.319	Diesel	3613	4	100.00	18
8045.06.326	Diesel	3613	4	100.00	18
8045.25.310	Diesel	3908	4	104.00	29
8045.25.370	Diesel	3908	4	104.00	29
8045.25.375	Diesel	3908	4	104.00	29
8045.25.376	Diesel	3908	4	104.00	29
8045.25.381	Diesel	3908	4	104.00	29
8055.04.200	Diesel	4583	5	103.00	24
8055.05.000	Diesel	4885	5	104.00	30
8060.02.000	Diesel	5184	6	100.00	17
8060.02.001	Diesel	5184	6	100.00	17
8060.02.003	Diesel	5184	6	100.00	17
8060.02.070	Diesel	5184	6	100.00	17
8060.04.000	Diesel	5499	6	103.00	24
8060.04.055	Diesel	5499	6	103.00	24
8060.04.060	Diesel	5500	6	103.00	24
8060.04.070	Diesel	5499	6	103.00	24
8060.04.620	Diesel	5499	6	103.00	24
8060.04.621	Diesel	5499	6	103.00	24
8060.04.630	Diesel	5500	6	103.00	24
8060.04.639	Diesel	5500	6	103.00	24
8060.04.658	Diesel	5499	6	103.00	24
8060.04.660	Diesel	5500	6	103.00	24
8060.04.669	Diesel	5500	6	103.00	24
8060.04.670	Diesel	5500	6	103.00	24
8060.04.672	Diesel	5500	6	103.00	24
8060.04.675	Diesel	5500	6	103.00	24
8060.04.689	Diesel	5500	6	103.00	24
8060.05.000	Diesel	5861	6	104.00	30
8060.05.200	Diesel	5861	6	104.00	30
8060.05.246	Diesel	5861	6	104.00	30
8060.05.270	Diesel	5861	6	104.00	30
8060.05.280	Diesel	5861	6	104.00	30
8060.05.285	Diesel	5861	6	104.00	30
8060.05.289	Diesel	5861	6	104.00	30
8060.24.601	Diesel	5500	6	103.00	26
8060.24.670	Diesel	5499	6	103.00	26
8060.24.671	Diesel	5499	6	103.00	26
8060.24.678	Diesel	5500	6	103.00	26
8060.25.600	Diesel	5861	6	104.00	32
8060.25.621	Diesel	5861	6	104.00	32
8060.25.630	Diesel	5861	6	104.00	32
8060.25.631	Diesel	5861	6	104.00	32
8060.25.641	Diesel	5861	6	104.00	32
8060.25.662	Diesel	5861	6	104.00	32
8060.25.663	Diesel	5861	6	104.00	32
8060.25.669	Diesel	5861	6	104.00	32
8060.25.670	Diesel	5861	6	104.00	32
8060.25.673	Diesel	5861	6	104.00	32
8060.25.678	Diesel	5861	6	104.00	32
8060.25.679	Diesel	5861	6	104.00	32
8060.45.4100 (Euro 1)	Diesel	5861	6	104.00	33
8060.45.4100 TCA (Euro 1)	Diesel	5861	6	104.00	33
8060.45.4300	Diesel	5861	6	104.00	29
8060.45.4400	Diesel	5861	6	104.00	29
8060.45.4700	Diesel	5861	6	104.00	33

ENGINE INDEX

Motorverzeichnis • Index de moteur • Índice de Motor
 Indeks silnika • Модель Двигателя • دليل المحرك



CCM

x



9

8060.45.4702 (Euro 1)	Diesel	5861	6	104.00	29
8060.45.4704 (Euro 1)	Diesel	5861	6	104.00	29
8060.45.4706 (Euro 1)	Diesel	5861	6	104.00	29
8060.45.4708	Diesel	5861	6	104.00	29
8060.45.5200 (Euro 2)	Diesel	5861	6	104.00	29
8060.45.5201 (Euro 2)	Diesel	5861	6	104.00	29
8060.45.5203 (Euro 2)	Diesel	5861	6	104.00	29
8060.45.5205 (Euro 2)	Diesel	5861	6	104.00	29
8060.45.5220 (Euro 2)	Diesel	5861	6	104.00	29
8060.45.5221 (Euro 2)	Diesel	5861	6	104.00	29
8060.45.5223 (Euro 2)	Diesel	5861	6	104.00	29
8060.45.5232 (Euro 2)	Diesel	5861	6	104.00	29
8060.45.5233 (Euro 2)	Diesel	5861	6	104.00	29
8060.45.5234 (Euro 2)	Diesel	5861	6	104.00	29
8060.45.5235 (Euro 2)	Diesel	5861	6	104.00	29
8060.45.5250 (Euro 2)	Diesel	5861	6	104.00	29
8060.45.5251	Diesel	5861	6	104.00	29
8060.45.5255	Diesel	5861	6	104.00	29
8060.45.600	Diesel	5861	6	104.00	33
8062.24.070	Diesel	5499	6	103.00	26
8065.02.007	Diesel	5184	6	100.00	17
8065.02.200	Diesel	5184	6	100.00	17
8065.02.207	Diesel	5184	6	100.00	17
8065.02.217	Diesel	5184	6	100.00	17
8065.04.200	Diesel	5499	6	103.00	24
8065.05.000	Diesel	5863	6	104.00	29
8065.05.330	Diesel	5863	6	104.00	29
8065.06.000	Diesel	5418	6	100.00	18
8065.24.000	Diesel	5499	6	103.00	27
8065.24.300	Diesel	5499	6	103.00	27
8065.25.080	Diesel	5863	6	104.00	36
8065.25.320	Diesel	5863	6	104.00	29
8140.07.2585 (Euro 1)	Diesel	2500	4	93.00	4
8140.07.2700	Diesel	2500	4	93.00	4
8140.07.2701	Diesel	2500	4	93.00	4
8140.07.2710	Diesel	2500	4	93.00	4
8140.07.2711	Diesel	2500	4	93.00	4
8140.07.2712	Diesel	2500	4	93.00	4
8140.07.3700 (Euro 1)	Diesel	2500	4	93.00	4
8140.07.3710 (Euro 1)	Diesel	2500	4	93.00	4
8140.07.3711 (Euro 1)	Diesel	2500	4	93.00	4
8140.07.3712 (Euro 1)	Diesel	2500	4	93.00	4
8140.07.3713 (Euro 1)	Diesel	2500	4	93.00	4
8140.21.200 (SOFIM 2.4TD)	Diesel	2445	4	93.00	5
8140.21.201 (SOFIM 2.4TD)	Diesel	2445	4	93.00	4
8140.21.202 (SOFIM 2.4TD)	Diesel	2445	4	93.00	4
8140.21.203 (SOFIM 2.4TD)	Diesel	2445	4	93.00	4
8140.21.212 (SOFIM 2.4TD)	Diesel	2445	4	93.00	4
8140.21.214 (Sofim)	Diesel	2445	4	93.00	5
8140.21.290 (SOFIM 2.4TD)	Diesel	2445	4	93.00	4
8140.23.2585 (Euro 2 Sofim)	Diesel	2800	4	94.40	9
8140.23.3700 (Euro 2 Sofim)	Diesel	2800	4	94.40	9
8140.23.3701 (Euro 2 Sofim)	Diesel	2800	4	94.40	9
8140.23.3710 (Euro 2 Sofim)	Diesel	2800	4	94.40	9
8140.23.3711 (Euro 2 Sofim)	Diesel	2800	4	94.40	9
8140.23.3713 (Euro 2 Sofim)	Diesel	2800	4	94.40	9
8140.23.3720 (Euro 2 Sofim)	Diesel	2800	4	94.40	9
8140.23.3721 (Euro 2 Sofim)	Diesel	2800	4	94.40	9
8140.23.3730 (Euro 2 Sofim)	Diesel	2800	4	94.40	9
8140.23.3731 (Euro 2 Sofim)	Diesel	2800	4	94.40	9



CCM

x



9

8140.23.3750 (Euro 2 Sofim)	Diesel	2800	4	94.40	9
8140.23.3751 (Euro 2 Sofim)	Diesel	2800	4	94.40	9
8140.23.3760 (Euro 2 Sofim)	Diesel	2800	4	94.40	9
8140.23.3801 (Euro 2 Sofim)	Diesel	2800	4	94.40	9
8140.23.3811 (Euro 2 Sofim)	Diesel	2800	4	94.40	9
8140.23.3821 (Euro 2 Sofim)	Diesel	2800	4	94.40	9
8140.27.210	Diesel	2445	4	93.00	4
8140.27.213	Diesel	2445	4	93.00	4
8140.27.215	Diesel	2500	4	93.00	4
8140.27.218	Diesel	2500	4	93.00	4
8140.27.2582	Diesel	2500	4	93.00	7
8140.27.2700 (SOFIM 2.5TD)	Diesel	2500	4	93.00	7
8140.27.2720	Diesel	2500	4	93.00	7
8140.27.2811	Diesel	2500	4	93.00	7
8140.43.2585 (Euro 2 Sofim)	Diesel	2800	4	94.40	9
8140.43.3700 (Euro 2 Sofim)	Diesel	2800	4	94.40	9
8140.43.3711 (Euro 2 Sofim)	Diesel	2800	4	94.40	9
8140.43.3713 (Euro 2 Sofim)	Diesel	2800	4	94.40	9
8140.43.3718 (Euro 2 Sofim)	Diesel	2800	4	94.40	9
8140.43.3721 (Euro 2 Sofim)	Diesel	2800	4	94.40	9
8140.43.3723 (Euro 2 Sofim)	Diesel	2800	4	94.40	9
8140.43.3728 (Euro 2 Sofim)	Diesel	2800	4	94.40	9
8140.43.3731 (Euro 2 Sofim)	Diesel	2800	4	94.40	9
8140.43.3900 (Euro 2 Sofim)	Diesel	2800	4	94.40	9
8140.43.3911 (Euro 2 Sofim)	Diesel	2800	4	94.40	9
8140.43.3921 (Euro 2 Sofim)	Diesel	2800	4	94.40	9
8140.43.3931 (Euro 2 Sofim)	Diesel	2800	4	94.40	9
8140.47.2700 (Euro 1)	Diesel	2500	4	93.00	6
8140.47.2711 (Euro 1)	Diesel	2500	4	93.00	6
8140.47.2721 (Euro 1)	Diesel	2500	4	93.00	6
8140.47.2785 (Euro 1)	Diesel	2500	4	93.00	6
8140.47.3700 (Euro 1)	Diesel	2500	4	93.00	6
8140.47.3711 (Euro 1)	Diesel	2500	4	93.00	6
8140.47.3721 (Euro 1)	Diesel	2500	4	93.00	6
8140.47.3731 (Euro 1)	Diesel	2500	4	93.00	6
8140.61.200 (SOFIM 2.4D)	Diesel	2445	4	93.00	8
8140.61.300	Diesel	2445	4	93.00	8
8140.63.4000 (Euro 3 Sofim)	Diesel	2800	4	94.40	13
8140.67.2585 (Euro 2)	Diesel	2500	4	93.00	4
8140.97.2781	Diesel	2500	4	93.00	8
8140.97.2783	Diesel	2499	4	93.00	8
8144.61.200	Diesel	2445	4	93.00	8
8200.02.220	Diesel	9820	6	122.00	49
8200.12.000	Diesel	9820	6	122.00	49
8210.02.000	Diesel	13798	6	137.00	57
8210.02.020	Diesel	13798	6	137.00	57
8210.02.022	Diesel	13798	6	137.00	57
8210.02.032	Diesel	13798	6	137.00	57
8210.02.053	Diesel	13798	6	137.00	57
8210.02.067	Diesel	13798	6	137.00	57
8210.02.069	Diesel	13798	6	137.00	57
8210.02.081	Diesel	13798	6	137.00	57
8210.02.266	Diesel	13798	6	137.00	57
8210.02.267	Diesel	13798	6	137.00	57
8210.02.371	Diesel	13798	6	137.00	57
8210.02.373	Diesel	13798	6	137.00	57
8210.02.377	Diesel	13798	6	137.00	57
8210.02.385	Diesel	13798	6	137.00	57
8210.02.393	Diesel	13798	6	137.00	57
8210.02.405	Diesel	13798	6	137.00	57

ENGINE INDEX

Motorverzeichnis • Index de moteur • Índice de Motor
 Indeks silnika • Модель Двигателя • دليل المحرك



CCM

x



9

8210.02.426	Diesel	13798	6	137.00	57
8210.02.440	Diesel	13798	6	137.00	57
8210.02.441	Diesel	13798	6	137.00	57
8210.02.731	Diesel	13798	6	137.00	57
8210.22.000	Diesel	13798	6	137.00	58
8210.22.069	Diesel	13798	6	137.00	58
8210.22.101	Diesel	13798	6	137.00	58
8210.22.105	Diesel	13798	6	137.00	59
8210.22.171	Diesel	13798	6	137.00	59
8210.22.175	Diesel	13798	6	137.00	58
8210.22.183	Diesel	13798	6	137.00	58
8210.22.210	Diesel	13798	6	137.00	59
8210.22.235	Diesel	13798	6	137.00	58
8210.22.236	Diesel	13798	6	137.00	59
8210.22.269	Diesel	13798	6	137.00	58
8210.22.317	Diesel	13798	6	137.00	58
8210.22.327	Diesel	13798	6	137.00	59
8210.22.373	Diesel	13798	6	137.00	58
8210.22.385	Diesel	13798	6	137.00	58
8210.22.406	Diesel	13798	6	137.00	58
8210.22.511	Diesel	13798	6	137.00	59
8210.22.521	Diesel	13798	6	137.00	59
8210.22.523	Diesel	13798	6	137.00	58
8210.22.525	Diesel	13798	6	137.00	59
8210.22.535	Diesel	13798	6	137.00	59
8210.22.537	Diesel	13798	6	137.00	59
8210.22.569	Diesel	13798	6	137.00	59
8210.22.800	Diesel	13798	6	137.00	59
8210.22.869	Diesel	13798	6	137.00	59
8210.42.009	Diesel	13798	6	137.00	60
8210.42.101	Diesel	13798	6	137.00	60
8210.42.115	Diesel	13798	6	137.00	60
8210.42.151	Diesel	13798	6	137.00	60
8210.42.152	Diesel	13798	6	137.00	60
8210.42.154	Diesel	13798	6	137.00	60
8210.42.155	Diesel	13798	6	137.00	60
8210.42.161	Diesel	13798	6	137.00	60
8210.42.162	Diesel	13798	6	137.00	60
8210.42.165	Diesel	13798	6	137.00	60
8210.42.171	Diesel	13798	6	137.00	60
8210.42.172	Diesel	13798	6	137.00	59
8210.42.175	Diesel	13798	6	137.00	60
8210.42.181	Diesel	13798	6	137.00	60
8210.42.182	Diesel	13798	6	137.00	60
8210.42.185	Diesel	13798	6	137.00	60
8210.42.186	Diesel	13798	6	137.00	60
8210.42.191	Diesel	13798	6	137.00	60
8210.42.195	Diesel	13798	6	137.00	60
8210.42.500 (Euro 2)	Diesel	13798	6	137.00	59
8211.02.032	Diesel	13798	6	137.00	57
8215.22.520	Diesel	13798	6	137.00	59
8260.02.405	Diesel	12880	6	145.00	63
8261.02.002	Diesel	12880	6	145.00	63
8261.1.002	Diesel	12880	6	145.00	63
8280.01.000	Diesel	17174	V8	145.00	63
8280.02.000	Diesel	17174	V8	145.00	63
8280.02.024	Diesel	17174	V8	145.00	63
8280.02.082	Diesel	17174	V8	145.00	63
8280.02.109	Diesel	17174	V8	145.00	63
8280.02.125-135	Diesel	17174	V8	145.00	63



CCM

x



9

8280.02.265	Diesel	17174	V8	145.00	63
8280.02.269	Diesel	17174	V8	145.00	63
8280.02.273	Diesel	17174	V8	145.00	63
8280.02.274	Diesel	17174	V8	145.00	63
8280.02.275	Diesel	17174	V8	145.00	63
8280.02.279	Diesel	17174	V8	145.00	63
8280.02.289	Diesel	17174	V8	145.00	63
8280.02.405	Diesel	17174	V8	145.00	63
8280.02.410	Diesel	17174	V8	145.00	63
8280.02.412	Diesel	17174	V8	145.00	63
8280.22.000	Diesel	17174	V8	145.00	64
8280.22.007	Diesel	17174	V8	145.00	64
8280.22.009	Diesel	17200	V8	145.00	64
8280.22.033	Diesel	17174	V8	145.00	64
8280.22.054	Diesel	17174	V8	145.00	64
8280.22.201	Diesel	17174	V8	145.00	64
8280.22.205	Diesel	17174	V8	145.00	64
8280.42.001	Diesel	17174	V8	145.00	64
8281.22.201	Diesel	17174	V8	145.00	64
8340.04.040	Diesel	4570	4	115.00	40
8340.04.200	Diesel	4570	4	115.00	40
8340.04.250	Diesel	4570	4	115.00	40
8340.04.300	Diesel	4570	4	115.00	40
8340.04.350	Diesel	4570	4	115.00	40
8340.04.362	Diesel	4570	4	115.00	40
8340.05.200	Diesel	5401	4	115.00	41
8360.05.200	Diesel	8102	6	115.00	41
8360.05.254	Diesel	8102	6	115.00	41
8360.05.673	Diesel	8102	6	115.00	41
8360.05.B	Diesel	8102	6	115.00	41
8361.25.510	Diesel	8101	6	115.00	42
8361.45.530	Diesel	8101	6	115.00	42
8361.45.530-836 L	Diesel	8101	6	115.00	42
8365.05.500	Diesel	8101	6	115.00	41
8365.05.520	Diesel	8101	6	115.00	41
8365.05.530	Diesel	8101	6	115.00	41
8365.05.531	Diesel	8101	6	115.00	41
8365.05.555	Diesel	8101	6	115.00	41
8365.05.560	Diesel	8101	6	115.00	41
8365.05.570	Diesel	8101	6	115.00	41
8365.05.580	Diesel	8101	6	115.00	41
8365.05.590	Diesel	8101	6	115.00	41
8365.25.500	Diesel	8102	6	115.00	43
8365.25.501	Diesel	8102	6	115.00	43
8365.25.502	Diesel	8102	6	115.00	43
8365.25.503	Diesel	8102	6	115.00	43
8365.25.533	Diesel	8102	6	115.00	43
8460.21.002	Diesel	9500	6	120.00	47
8460.21.002	Diesel	9498	6	120.00	47
8460.21.010	Diesel	9500	6	120.00	47
8460.21.042	Diesel	9500	6	120.00	47
8460.21.102	Diesel	9500	6	120.00	47
8460.21.106	Diesel	9500	6	120.00	47
8460.21.202	Diesel	9498	6	120.00	47
8460.21.206	Diesel	9498	6	120.00	47
8460.21.601	Diesel	9498	6	120.00	47
8460.21.611	Diesel	9498	6	120.00	47
8460.21.708	Diesel	9500	6	120.00	47
8460.21.710	Diesel	9500	6	120.00	47
8460.41.102	Diesel	9500	6	120.00	47

ENGINE INDEX

Motorverzeichnis • Index de moteur • Índice de Motor
 Indeks silnika • Модель Двигателя • دليل المحرك

CCM
x

9

8460.41.124	Diesel	9500	6	120.00	47
8460.41.160	Diesel	9500	6	120.00	47
BF4L 913 T	Diesel	4086	4	102.00	20
BF6L 913	Diesel	6128	6	102.00	23
BF6L 913 T	Diesel	6128	6	102.00	20
C 03	Diesel	4940	4	110.00	38
C20	Diesel	4562	4	110.00	38
C21	Diesel	4562	4	110.00	38
C41	Diesel	4562	4	110.00	38
C70	Diesel	4941	4	110.00	37
C100	Diesel	4941	4	110.00	37
CN3	Diesel	3706	3	110.00	37
CO3	Diesel	4562	4	110.00	38
CO40	Diesel	4562	4	110.00	38
CP 3	Diesel	7412	6	110.00	37
CP 3/32.1.200	Diesel	7412	6	110.00	37
F1AE0481A (Euro 3)	Diesel	2287	4	88.00	1
F1AE0481B (Euro 3)	Diesel	2287	4	88.00	1
F1AE0481 C (Euro 3)	Diesel	2287	4	88.00	1
F1AE0481F (Euro 4)	Diesel	2287	4	88.00	2
F1AE0481G (Euro 4)	Diesel	2287	4	88.00	2
F1AE0481H (Euro 4)	Diesel	2287	4	88.00	2
F1AE0481V (Euro 4)	Diesel	2287	4	88.00	2
F1AE0481M	Diesel	2287	4	88.00	2
F1AE0481R (Euro 4)	Diesel	2287	4	88.00	2
F1AE0481U (Euro 4)	Diesel	2287	4	88.00	2
F1AE3481A	Diesel	2287	4	88.00	3
F1AE3481B	Diesel	2287	4	88.00	3
F1AE3481C	Diesel	2287	4	88.00	3
F1CE0481A	Diesel	2998	4	95.80	15
F1CE0481B (Euro 3)	Diesel	2998	4	95.80	15
F1CE0481F (Euro 4/5)	Diesel	2998	4	95.80	15
F1CE0481H (Euro 4/5)	Diesel	2998	4	95.80	15
F1CE0481L (Euro 4)	Diesel	2998	4	95.80	15
F1CE3481B	Diesel	2998	4	95.80	16
F1CE3481C	Diesel	2998	4	95.80	16
F1CE3481D (Euro 5)	Diesel	2998	4	95.80	16
F1CE3481J (Euro 5)	Diesel	2998	4	95.80	16
F1CE3481K (Euro 5)	Diesel	2998	4	95.80	16
F1CE3481L	Diesel	2998	4	95.80	16
F2BE0681A (Euro 2 Cursor 8)	Diesel	7790	6	115.00	44
F2BE0681A/B/C/D/F (Euro 3)	Diesel	7790	6	115.00	45
F2BE0681B (Euro 2 Cursor 8)	Diesel	7790	6	115.00	44
F2BE0681C (Euro 2 Cursor 8)	Diesel	7790	6	115.00	44
F2BE0681D (Euro 2 Cursor 8)	Diesel	7790	6	115.00	44
F2BE0681DA (Euro 2 Cursor 8)	Diesel	7790	6	115.00	44
F2BE0681DB (Euro 2 Cursor 8)	Diesel	7790	6	115.00	44
F2BE0681E (Euro 2 Cursor 8)	Diesel	7790	6	115.00	44
F2BE0681F (Euro 2 Cursor 8)	Diesel	7790	6	115.00	44
F2BE1682G (Euro 3)	Diesel	7790	6	115.00	45
F2CE0681A (Cursor 9)	Diesel	8708	6	117.00	46
F2CE0682A (Cursor 9)	Diesel	8708	6	117.00	46
F2CE0683A (Cursor 9)	Diesel	8708	6	117.00	46
F2CE0684A (Cursor 9)	Diesel	8708	6	117.00	46
F3A3681A (Euro 4/5 Cursor 10)	Diesel	10300	6	125.00	51
F3A3681B (Euro 4/5 Cursor 10)	Diesel	10300	6	125.00	51
F3A3681Y (Euro 4/5 Cursor 10)	Diesel	10300	6	125.00	51
F3AE0681B (Euro 3 Cursor 10)	Diesel	10300	6	125.00	52
F3AE0681D (Euro 2 Cursor 10)	Diesel	10300	6	125.00	52
F3AE0681E (Euro 2 Cursor 10)	Diesel	10300	6	125.00	52



CCM

x



9

F3AE0681H (Euro 3)	Diesel	10300	6	125.00	52
F3AE3681D (Euro 4/5 Cursor 10)	Diesel	10300	6	125.00	51
F3BE0681A (Euro 3 Cursor 13)	Diesel	12880	6	135.00	55
F3BE0681B (Euro 3 Cursor 13)	Diesel	12880	6	135.00	55
F3BE0681C (Euro 3 Cursor 13)	Diesel	12880	6	135.00	55
F3BE0681D (Euro 3 Cursor 13)	Diesel	12882	6	135.00	55
F3BE0681E (Euro 3 Cursor 13)	Diesel	12880	6	135.00	55
F3BE0681F (Euro 3 Cursor 13)	Diesel	12882	6	135.00	55
F3BE0681G (Euro 3 Cursor 13)	Diesel	12880	6	135.00	55
F3BE3681A (Euro 4/5 Cursor 13)	Diesel	12882	6	135.00	56
F3BE3681B (Euro 4/5 Cursor 13)	Diesel	12880	6	135.00	56
F3BE3681C (Euro 4/5 Cursor 13)	Diesel	12880	6	135.00	56
F3BE3681D (Euro 4/5 Cursor 13)	Diesel	12882	6	135.00	56
F3BE3681E (Euro 4/5 Cursor 13)	Diesel	12882	6	135.00	56
F3BE3681F (Euro 4/5 Cursor 13)	Diesel	12882	6	135.00	56
F3BE3681G (Euro 4/5 Cursor 13)	Diesel	12882	6	135.00	56
F4AE0481A (Euro 3)	Diesel	3920	4	102.00	21
F4AE0481C (Euro 3)	Diesel	3920	4	102.00	21
F4AE0481D (Euro 3)	Diesel	3920	4	102.00	21
F4AE0681A (Euro 3)	Diesel	5880	6	102.00	21
F4AE0681B (Euro 3)	Diesel	5880	6	102.00	21
F4AE0681C (Euro 3)	Diesel	5880	6	102.00	21
F4AE0681D (Euro 3)	Diesel	5880	6	102.00	21
F4AE0681E (Euro 3)	Diesel	5880	6	102.00	21
F4AE3481A (Euro 4/5)	Diesel	3920	4	102.00	22
F4AE3481B (Euro 4/5)	Diesel	3920	4	102.00	22
F4AE3481C (Euro 4/5)	Diesel	3920	4	102.00	22
F4AE3481D (Euro 4/5)	Diesel	3920	4	102.00	22
F4AE3681A (Euro 4/5)	Diesel	5880	6	102.00	22
F4AE3681B (Euro 4/5)	Diesel	5880	6	102.00	22
F4AE3681C (Euro 4/5)	Diesel	5880	6	102.00	22
F4AE3681D (Euro 4/5)	Diesel	5880	6	102.00	22
F4AE3681E (Euro 4/5)	Diesel	5880	6	102.00	22
F4L 913	Diesel	4086	4	102.00	23
F6L 413 F	Diesel	9570	V6	125.00	53
F8L 413 F	Diesel	12763	V8	125.00	53
F10L 413 F	Diesel	15953	V10	125.00	53



88.00 **1**

F1AE0481A (Euro 3)	4cyl.	2287cc	70kW (95PS)	Diesel	Turbo Intercooled	TD17144
F1AE0481B (Euro 3)	4cyl.	2287cc	85kW (116PS)	Diesel	Turbo Intercooled	TD17145
F1AE0481 C (Euro 3)	4cyl.	2287cc	81kW (110PS)	Diesel	Turbo Intercooled	MP9055
DAILY III 29 L 10			09/02→04/06	DAILY III 35 C 12 V, 35 S 12 V		09/02→07/07
DAILY III 29 L 10 V			09/02→07/07	DAILY III 35 S 10		09/02→07/07
DAILY III 29 L 12			09/02→04/06	DAILY III 35 S 12, 35 C 12, 40 C 12		01/03→05/06
DAILY III 29 L 12 V			09/02→07/07	DAILY III 40 C 10		09/02→04/06
DAILY III 35 C 10 V, 35 S 10 V			09/02→04/06	VAN		
DAILY III 35 C 12, 35 S 12			09/02→04/06			



87-138000-00 STD
87-138006-00 0.40mm

A 57.00
B- 18.18
BØ 38.00
D 84.00
 31x67



AK RT TP

08-138000-00 STD
08-138006-00 0.40mm
08-138008-00 0.60mm

2.50  CK P
 2.00  P
 2.50  CR P

88.00 **2**

F1AE0481F (Euro 4)	4cyl.	2287cc	70kW (95PS)	Diesel	Turbo Intercooled	TD28231
F1AE0481G (Euro 4)	4cyl.	2287cc	85kW (116PS)	Diesel	Turbo Intercooled	TD28232
F1AE0481H (Euro 4)	4cyl.	2287cc	100kW (136PS)	Diesel	Turbo Intercooled	TD28233
F1AE0481V (Euro 4)	4cyl.	2287cc	93kW (126PS)	Diesel	Turbo Intercooled	TD26637
F1AE0481M	4cyl.	2287cc	100kW (136PS)	Diesel	Turbo Intercooled	TD19156
F1AE0481R (Euro 4)	4cyl.	2287cc	85kW (116PS)	Diesel	Turbo Intercooled	TD28234
F1AE0481U (Euro 4)	4cyl.	2287cc	78kW (106PS)	Diesel	Turbo Intercooled	TD26638
DAILY III 29 L 14			01/05→04/06	DAILY IV 35C13, 35C13 /P, 35S13 D, 35S13, 35S13 /P		07/07→08/11
DAILY III 35 C 14, 35 S 14			01/05→04/06	DAILY IV 35C13 V, 35C13 V/P, 35S13 V, 35S13 V/P		07/07→08/11
DAILY IV 29L10			05/06→08/11	DAILY IV 35C14, 35S14, 35S14 /P		05/06→08/11
DAILY IV 29L10 V			05/06→08/11	DAILY IV 35S14, 35S14 /P		05/06→08/11
DAILY IV 29L12			05/06→08/11	DAILY IV 35S14 C, 35S14 C/P, 35S14 V, 35S14 V/P, 35C14 V,...		05/06→08/11
DAILY IV 29L12 V, 29L12 V/P			05/06→08/11	DAILY IV 40C10		05/06→08/11
DAILY IV 29L14			05/06→08/11	DAILY IV 40C10 V		05/06→08/11
DAILY IV 29L14 C, 29L14 C/P, 29L14 V, 29L14 V/P			05/06→08/11	DAILY IV 40C11, 40C11 D		07/07→08/11
DAILY IV 35C10, 35S10			05/06→08/11	DAILY IV 40C11 V		07/07→08/11
DAILY IV 35C11, 35S11, 35S11 D, 35S11 /P			07/07→08/11	DAILY IV 40C12		05/06→08/11
DAILY IV 35C11 V, 35S11 V			07/07→08/11	DAILY IV 40C12 V, 40C14 V/P		05/06→08/11
DAILY IV 35C12, 35S12			05/06→08/11	DAILY IV 40C13, 40C13 /P		07/07→08/11
DAILY IV 35C12 V, 35C12 V/P, 35S12 V, 35S12 V/P			05/06→08/11	DAILY IV 40C13 V, 40C13 V/P		07/07→08/11



87-138000-10 STD
87-138006-10 0.40mm
87-138008-10 0.60mm

A 57.00
B- 13.75
BØ 50.10
D 84.00
 31x67



AK KK RT TP

08-138000-00 STD
08-138006-00 0.40mm
08-138008-00 0.60mm

2.50  CK P
 2.00  P
 2.50  CR P

88.00 **3**

F1AE3481A	4cyl.	2287cc	78kW (106PS)	Diesel	Turbo Intercooled	TD26934
F1AE3481B	4cyl.	2287cc	93kW (126PS)	Diesel	Turbo Intercooled	TD26935





F1AE3481C	4cyl.	2287cc	107kW (146PS)	Diesel	Turbo Intercooled	TD26943
DAILY V 26L11, 29L11, 29S11, 35C11D, 35S11, 40C11			09/11→02/14	DAILY V 29S11, 29L11, 35C11, 35S11, 40C11		09/11→02/14
DAILY V 29L15, 35S15, 35C15, 40C15, 50C15			09/11→02/14	DAILY V 29S13, 29L13, 29L13D, 35S13, 35C13D, 40C13		09/11→02/14
DAILY V 29L15 V, 35S15 V, 35C15L V, 40C15L V, 50C15L V			09/11→02/14	DAILY V 29S13, 29L13, 35C13, 35S13, 40C13, 40S13		09/11→02/14

87-450600-00 STD

A 57.00
B- 14.30
BØ 49.00
D 84.00
 31x67

AK KK RT TP

08-450600-00 STD

2.50 GDC P
 2.00 P
 2.50 CR P

GDC **LKZ-Ring**

Euro 5

93.00						4
8140.07.2585 (Euro 1)	4cyl.	2500cc	55kW (75PS)	Diesel		TD20437
8140.07.2700	4cyl.	2500cc	55kW (75PS)	Diesel		TD1700
8140.07.2701	4cyl.	2500cc	55kW (75PS)	Diesel		TD1701
8140.07.2710	4cyl.	2500cc	55kW (75PS)	Diesel		TD27358
8140.07.2711	4cyl.	2500cc	55kW (75PS)	Diesel		TD27359
8140.07.2712	4cyl.	2500cc	55kW (75PS)	Diesel		TD1702
8140.07.3700 (Euro 1)	4cyl.	2500cc	53kW (72PS)	Diesel		TD27364
8140.07.3710 (Euro 1)	4cyl.	2500cc	53kW (72PS)	Diesel		TD20418
8140.07.3711 (Euro 1)	4cyl.	2500cc	53kW (72PS)	Diesel		TD27365
8140.07.3712 (Euro 1)	4cyl.	2500cc	53kW (72PS)	Diesel		TD27366
8140.07.3713 (Euro 1)	4cyl.	2500cc	53kW (72PS)	Diesel		TD27367
8140.21.201 (SOFIM 2.4TD)	4cyl.	2445cc	68kW (92PS)	Diesel	Turbo Intercooled	TD27368
8140.21.202 (SOFIM 2.4TD)	4cyl.	2445cc	68kW (92PS)	Diesel	Turbo Intercooled	TD27369
8140.21.203 (SOFIM 2.4TD)	4cyl.	2445cc	68kW (92PS)	Diesel	Turbo Intercooled	TD27370
8140.21.212 (SOFIM 2.4TD)	4cyl.	2445cc	68kW (92PS)	Diesel	Turbo Intercooled	TD27371
8140.21.290 (SOFIM 2.4TD)	4cyl.	2445cc	68kW (92PS)	Diesel	Turbo Intercooled	TD27372
8140.27.210	4cyl.	2445cc	77kW (105PS)	Diesel	Turbo	MP9131
8140.27.213	4cyl.	2445cc	77kW (105PS)	Diesel	Turbo	MP9131-1
8140.27.215	4cyl.	2500cc	76kW (103PS)	Diesel	Turbo Intercooled	TD27387
8140.27.218	4cyl.	2500cc	76kW (103PS)	Diesel	Turbo Intercooled	TD26268
8140.27R.2780	4cyl.	2500cc	67-70kW (91-95PS)	Diesel	Turbo Intercooled	TD27393
8140.27R.2782	4cyl.	2500cc	70kW (96PS)	Diesel	Turbo	TD1710
8140.27R.2786	4cyl.	2500cc	67-70kW (91-95PS)	Diesel	Turbo Intercooled	TD27394
8140.27R.2787	4cyl.	2500cc	67-70kW (91-95PS)	Diesel	Turbo Intercooled	TD27395
8140.27S.2701	4cyl.	2500cc	76kW (103PS)	Diesel	Turbo Intercooled	TD27396
8140.27S.2710	4cyl.	2500cc	76kW (103PS)	Diesel	Turbo Intercooled	TD27397
8140.27S.2711	4cyl.	2500cc	76kW (103PS)	Diesel	Turbo Intercooled	TD27398
8140.27S.2720	4cyl.	2500cc	76kW (103PS)	Diesel	Turbo Intercooled	TD27399
8140.27S.2721	4cyl.	2500cc	76kW (103PS)	Diesel	Turbo Intercooled	TD27400
8140.27S.2730	4cyl.	2500cc	76kW (103PS)	Diesel	Turbo Intercooled	TD27401
8140.27S.2731	4cyl.	2500cc	76kW (103PS)	Diesel	Turbo Intercooled	TD27402
8140.27S.2750	4cyl.	2500cc	76kW (103PS)	Diesel	Turbo Intercooled	TD27403
8140.27S.2751	4cyl.	2500cc	76kW (103PS)	Diesel	Turbo Intercooled	TD27404
8140.27S.2760	4cyl.	2500cc	76kW (103PS)	Diesel	Turbo Intercooled	TD27405
8140.27S.2761	4cyl.	2500cc	76kW (103PS)	Diesel	Turbo Intercooled	TD27406
8140.27S.2770	4cyl.	2500cc	76kW (103PS)	Diesel	Turbo Intercooled	TD27407





8140.27S.2771	4cyl.	2500cc	76kW (103PS)	Diesel	Turbo Intercooled	TD27408
8140.27S.2811	4cyl.	2500cc	76kW (103PS)	Diesel	Turbo Intercooled	TD27409
8140.67.2585 (Euro 2)	4cyl.	2500cc	55-63kW (75-86PS)	Diesel	Turbo Intercooled	TD20427
8140.67F. (Euro 2)	4cyl.	2500cc	60kW (82PS)	Diesel		TD7226
8140.67F.3700 (Euro 2)	4cyl.	2500cc	60-63kW (82-86PS)	Diesel		TD20428
8140.67F.3701 (Euro 2)	4cyl.	2500cc	60kW (82PS)	Diesel		TD26292
8140.67F.3710 (Euro 2)	4cyl.	2500cc	60kW (82PS)	Diesel		TD26293
8140.67F.3711 (Euro 2)	4cyl.	2500cc	60kW (82PS)	Diesel		TD26294
8140.67F.3713 (Euro 2)	4cyl.	2500cc	60kW (82PS)	Diesel		TD26295
8140.67F.3721 (Euro 2)	4cyl.	2500cc	60kW (82PS)	Diesel		TD26296

DAILY II 30-8	01/89→08/98	INDUSTRIAL, TRUCK & BUS
DAILY II 35-8	01/89→08/98	

14-021371-00 D B 96.01 C 171.00 D 98.92 E 5.00
 14-021372-00 D B 96.05 C 171.00 D 98.92 E 5.00

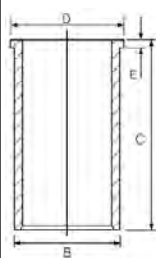

93.00 **5**

8140.21.200 (SOFIM 2.4TD)	4cyl.	2445cc	68kW (92PS)	Diesel	Turbo	TD1703
8140.21.214 (Sofim)	4cyl.	2445cc	70kW (95PS)	Diesel	Turbo	TD1704

DAILY I 35-10	01/85→12/89	DAILY I 49-10	01/85→12/89
DAILY I 45-10	01/85→12/89	DAILY I 49-10 V	01/85→12/89
DAILY I 45-10 V	01/85→12/89		

87-245200-30 STD

- A 59.65
- B- 14.80
- BØ 51.90
- D 97.65
- 32x75



RT

08-245200-00 STD

08-245208-00 0.60mm

- 3.00 CR P
- 2.00 P
- 3.00 CR P



14-021371-00 D B 96.01 C 171.00 D 98.92 E 5.00
 14-021372-00 D B 96.05 C 171.00 D 98.92 E 5.00

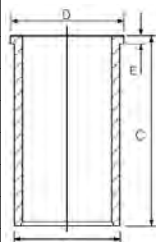

93.00 **6**

8140.27 S (SOFIM 2.5TD)	4cyl.	2445cc	68-76kW (92-103PS)	Diesel	Turbo	TD1705
8140.27S.3700	4cyl.	2500cc	77kW (104PS)	Diesel	Turbo Intercooled	TD27410
8140.27S.3701	4cyl.	2500cc	77kW (104PS)	Diesel	Turbo Intercooled	TD27411
8140.27S.3711	4cyl.	2500cc	77kW (104PS)	Diesel	Turbo Intercooled	TD27412
8140.27S.3720	4cyl.	2500cc	77kW (104PS)	Diesel	Turbo Intercooled	TD27413
8140.27S.3721	4cyl.	2500cc	77kW (104PS)	Diesel	Turbo Intercooled	TD27414
8140.27S.3750	4cyl.	2500cc	77kW (104PS)	Diesel	Turbo Intercooled	TD27415
8140.27S.3751	4cyl.	2500cc	77kW (104PS)	Diesel	Turbo Intercooled	TD27416
8140.27S.3760	4cyl.	2500cc	77kW (104PS)	Diesel	Turbo Intercooled	TD27419
8140.27S.3761	4cyl.	2500cc	77kW (104PS)	Diesel	Turbo Intercooled	TD27420
8140.27S.3770	4cyl.	2500cc	77kW (104PS)	Diesel	Turbo Intercooled	TD27422





8140.27S.3771	4cyl.	2500cc	77kW (104PS)	Diesel	Turbo Intercooled	TD27423
8140.27S.3780	4cyl.	2500cc	77kW (104PS)	Diesel	Turbo Intercooled	TD27424
8140.27S.3781	4cyl.	2500cc	77kW (104PS)	Diesel	Turbo Intercooled	TD27425
8140.27S.3811	4cyl.	2500cc	77kW (104PS)	Diesel	Turbo Intercooled	TD27426
8140.47.2700 (Euro 1)	4cyl.	2500cc	85kW (116PS)	Diesel	Turbo Intercooled	TD1711
8140.47.2711 (Euro 1)	4cyl.	2500cc	85kW (116PS)	Diesel	Turbo Intercooled	TD1712
8140.47.2721 (Euro 1)	4cyl.	2500cc	85kW (116PS)	Diesel	Turbo Intercooled	TD1713
8140.47.2785 (Euro 1)	4cyl.	2500cc	85kW (116PS)	Diesel	Turbo Intercooled	TD1715
8140.47.3700 (Euro 1)	4cyl.	2500cc	85kW (116PS)	Diesel	Turbo Intercooled	TD20477
8140.47.3711 (Euro 1)	4cyl.	2500cc	85kW (116PS)	Diesel	Turbo Intercooled	TD26005
8140.47.3721 (Euro 1)	4cyl.	2500cc	85kW (116PS)	Diesel	Turbo Intercooled	TD26006
8140.47.3731 (Euro 1)	4cyl.	2500cc	85kW (116PS)	Diesel	Turbo Intercooled	TD26007
8140.47B.3790 (Euro 1)	4cyl.	2500cc	78-83kW (106-113PS)	Diesel	Turbo Intercooled	TD26008
8140.47B.3795 (Euro 1)	4cyl.	2500cc	78-83kW (106-113PS)	Diesel	Turbo Intercooled	TD26009
8140.47R	4cyl.	2500cc	80kW (109PS)	Diesel	Turbo Intercooled	TD7234
8140.47R.2790	4cyl.	2500cc	76-80kW (103-109PS)	Diesel	Turbo Intercooled	TD1716
8140.47R.2795	4cyl.	2500cc	80kW (109PS)	Diesel	Turbo Intercooled	TD26010
8140.47S (Euro 1)	4cyl.	2500cc	85kW (116PS)	Diesel	Turbo Intercooled	TD20453
DAILY I 40-10			01/85→12/89	DAILY II 49-12 V		06/90→04/96
DAILY I 40-10 V			01/85→12/89	DAILY II 59-12		05/91→04/96
DAILY II 35-10			01/89→08/98	DAILY II 59-12 V		05/91→04/96
DAILY II 35-12			01/90→04/96	DAILY II A 45-12		06/90→04/96
DAILY II 49-12			06/90→04/96			

87-520200-00 STD

- A 58.75
- B- 18.40
- BØ 38.00
- D 96.75
-  32x78

AK KK NB RT



08-520200-00 STD

- 3.00  CR
- 2.00  P
- 3.00  CR P

14-021371-00 D

14-021372-00 D

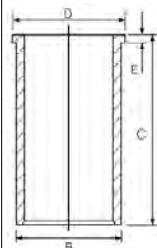

B 96.01 C 171.00 D 98.92 E 5.00

B 96.05 C 171.00 D 98.92 E 5.00

 93.00

7

8140.27.2582	4cyl.	2500cc	74-79kW (101-107PS)	Diesel	Turbo	TD7260
8140.27.2700 (SOFIM 2.5TD)	4cyl.	2500cc	76kW (103PS)	Diesel	Turbo	TD1706
8140.27.2720	4cyl.	2500cc	76kW (103PS)	Diesel	Turbo	TD1707
8140.27.2811	4cyl.	2500cc	76kW (103PS)	Diesel	Turbo	TD1708
8140.27R.2700	4cyl.	2500cc	67-70kW (92-95PS)	Diesel	Turbo Intercooled	TD20420
8140.27S.2700 (Sofim)	4cyl.	2500cc	76kW (103PS)	Diesel	Turbo Intercooled	TD20421
8140.27S.2801 (Sofim)	4cyl.	2500cc	76kW (103PS)	Diesel	Turbo Intercooled	TD20419
8140.27S.2885 (Sofim)	4cyl.	2500cc	76kW (103PS)	Diesel	Turbo Intercooled	TD20422

DAILY II A 45-10 01/91→04/96





87-245200-40 STD

- A 58.75
- B- 17.90
- BØ 38.00
- D 96.75
-  32x75



RT

08-245200-00 STD

08-245208-00 0.60mm

- 3.00  CR P
- 2.00  P
- 3.00  CR P

14-021371-00 D

14-021372-00 D

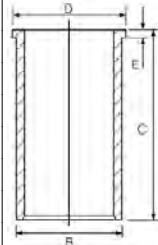

B 96.01 C 171.00 D 98.92 E 5.00

B 96.05 C 171.00 D 98.92 E 5.00

93.00

8

8140.61.200 (SOFIM 2.4D)	4cyl.	2445cc	53kW (72PS)	Diesel		TD7225
8140.61.300	4cyl.	2445cc	53kW (72PS)	Diesel		TD20426
8140.67 (290B7W)	4cyl.	2500cc		Diesel		MP9170-1
8140.97.2781	4cyl.	2500cc	68kW (92PS)	Diesel	Turbo Intercooled	TD1717
8140.97.2783	4cyl.	2499cc		Diesel	Turbo	MP29100
8144.61.200	4cyl.	2445cc	53kW (72PS)	Diesel		TD20429
8144.67	4cyl.	2500cc		Diesel		MP9170
DAILY I 30-8			01/78→12/89	DAILY I 40-8 V		01/83→06/89
DAILY I 35-8			01/78→12/89	INDUSTRIAL, TRUCK & BUS		
DAILY I 40-8			01/83→06/89	VAN		

14-022560-00 D

14-028930-00 D

14-028931-00 D

14-028932-00 D

B 96.00 C 167.30 D 98.90 E 5.00

B 97.50 C 167.00 D 100.90 E 5.00

B 97.58 C 167.00 D 100.90 E 5.00

B 97.70 C 167.00 D 100.90 E 5.00

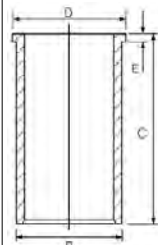

94.40

9

8140.23 (Euro 2 Sofim)	4cyl.	2800cc	76kW (103PS)	Diesel	Turbo Intercooled	TD7229
8140.23.2585 (Euro 2 Sofim)	4cyl.	2800cc	76-78kW (103-106PS)	Diesel	Turbo Intercooled	TD16183
8140.23.3700 (Euro 2 Sofim)	4cyl.	2800cc	76kW (103PS)	Diesel	Turbo Intercooled	TD10387
8140.23.3701 (Euro 2 Sofim)	4cyl.	2800cc	76kW (103PS)	Diesel	Turbo Intercooled	TD27373
8140.23.3710 (Euro 2 Sofim)	4cyl.	2800cc	76kW (103PS)	Diesel	Turbo Intercooled	TD27374
8140.23.3711 (Euro 2 Sofim)	4cyl.	2800cc	76kW (103PS)	Diesel	Turbo Intercooled	TD27375
8140.23.3713 (Euro 2 Sofim)	4cyl.	2800cc	76kW (103PS)	Diesel	Turbo Intercooled	TD27376
8140.23.3720 (Euro 2 Sofim)	4cyl.	2800cc	76kW (103PS)	Diesel	Turbo Intercooled	TD27377
8140.23.3721 (Euro 2 Sofim)	4cyl.	2800cc	76kW (103PS)	Diesel	Turbo Intercooled	TD27378
8140.23.3730 (Euro 2 Sofim)	4cyl.	2800cc	76kW (103PS)	Diesel	Turbo Intercooled	TD27379
8140.23.3731 (Euro 2 Sofim)	4cyl.	2800cc	76kW (103PS)	Diesel	Turbo Intercooled	TD27380
8140.23.3750 (Euro 2 Sofim)	4cyl.	2800cc	76kW (103PS)	Diesel	Turbo Intercooled	TD27381
8140.23.3751 (Euro 2 Sofim)	4cyl.	2800cc	76kW (103PS)	Diesel	Turbo Intercooled	TD27382
8140.23.3760 (Euro 2 Sofim)	4cyl.	2800cc	76kW (103PS)	Diesel	Turbo Intercooled	TD27383
8140.23.3801 (Euro 2 Sofim)	4cyl.	2800cc	76kW (103PS)	Diesel	Turbo Intercooled	TD27384
8140.23.3811 (Euro 2 Sofim)	4cyl.	2800cc	76kW (103PS)	Diesel	Turbo Intercooled	TD27385





8140.23.3821 (Euro 2 Sofim)	4cyl.	2800cc	76kW (103PS)	Diesel	Turbo Intercooled	TD27386
8140.43 (Euro 2 Sofim)	4cyl.	2800cc	90kW (122PS)	Diesel	Turbo Intercooled	TD7235
8140.43.2585 (Euro 2 Sofim)	4cyl.	2800cc	84-90kW (114-122PS)	Diesel	Turbo Intercooled	TD20423
8140.43.3700 (Euro 2 Sofim)	4cyl.	2800cc	90kW (122PS)	Diesel	Turbo Intercooled	TD20424
8140.43.3711 (Euro 2 Sofim)	4cyl.	2800cc	90kW (122PS)	Diesel	Turbo Intercooled	TD27427
8140.43.3713 (Euro 2 Sofim)	4cyl.	2800cc	90kW (122PS)	Diesel	Turbo Intercooled	TD27428
8140.43.3718 (Euro 2 Sofim)	4cyl.	2800cc	90kW (122PS)	Diesel	Turbo Intercooled	TD27429
8140.43.3721 (Euro 2 Sofim)	4cyl.	2800cc	90kW (122PS)	Diesel	Turbo Intercooled	TD27430
8140.43.3723 (Euro 2 Sofim)	4cyl.	2800cc	90kW (122PS)	Diesel	Turbo Intercooled	TD27431
8140.43.3728 (Euro 2 Sofim)	4cyl.	2800cc	90kW (122PS)	Diesel	Turbo Intercooled	TD27432
8140.43.3731 (Euro 2 Sofim)	4cyl.	2800cc	90kW (122PS)	Diesel	Turbo Intercooled	TD27433
8140.43.3900 (Euro 2 Sofim)	4cyl.	2800cc	90kW (122PS)	Diesel	Turbo Intercooled	TD20425
8140.43.3911 (Euro 2 Sofim)	4cyl.	2800cc	90kW (122PS)	Diesel	Turbo Intercooled	TD27434
8140.43.3921 (Euro 2 Sofim)	4cyl.	2800cc	90kW (122PS)	Diesel	Turbo Intercooled	TD27435
8140.43.3931 (Euro 2 Sofim)	4cyl.	2800cc	90kW (122PS)	Diesel	Turbo Intercooled	TD27436
8140.43C (Euro 2 Sofim)	4cyl.	2800cc	74-78kW (101-106PS)	Diesel	Turbo Intercooled	TD14449

DAILY II 2.8 D	06/00→05/07	DAILY II A 40-12	05/96→05/99
DAILY II 2.8 D HM 4180	06/00→07/07	DAILY II A 45-10	05/96→05/99
DAILY II 30-10	01/97→05/99	DAILY II A 45-12	05/96→05/99
DAILY II 30-10 C	01/97→05/99	DAILY III 29 L 11	05/99→04/06
DAILY II 35-10	01/96→05/99	DAILY III 29 L 11 V	05/99→07/07
DAILY II 35-12	02/95→05/99	DAILY III 35 S 11,35 C 11	05/99→04/06
DAILY II 35-12 K	09/96→08/98	DAILY III 35 S 11 V,35 C 11 V	05/99→07/07
DAILY II 40-10	01/97→05/99	DAILY III 40 C 11	04/01→11/03
DAILY II 40-10 W	01/97→05/99	DAILY III 40 C 11, 50 C 11	05/99→05/06
DAILY II 49-10	01/96→12/99	DAILY III 50 C 11	05/99→07/07
DAILY II 49-12	05/96→05/99	M26	01/96→12/02
DAILY II 49-12 V	05/96→05/99	POWER DAILY 36.10	12/07→
DAILY II 59-12	05/96→05/99	POWER DAILY 42.12, 50.12	12/07→
DAILY II 59-12 V	05/96→05/99	POWER DAILY A36.10	12/07→
DAILY II A 40-10	09/96→05/99	POWER DAILY A40.12, A42.12, A50.12	12/07→

87-854700-00 STD
87-854708-00 0.60mm
 →Eng.2572279

A 58.75
B- 19.40
BØ 39.40
D 96.65
 32x78

AK KK RT

08-854700-00 STD
08-854708-00 0.60mm

3.00 CR
 2.00 P
 3.00 CR

14-021321-00 D **B** 97.54 **C** 167.00 **D** 100.90 **E** 5.00
14-028930-00 D **B** 97.50 **C** 167.00 **D** 100.90 **E** 5.00
14-028931-00 D **B** 97.58 **C** 167.00 **D** 100.90 **E** 5.00
14-028932-00 D **B** 97.70 **C** 167.00 **D** 100.90 **E** 5.00

87-122200-10 STD
87-122208-10 0.60mm
 Eng.2572280→

A 58.75
B- 19.40
BØ 39.25
D 87.60
 32x72

AK KK RT TP

08-122200-00 STD
08-122208-00 0.60mm

2.50 CK P
 2.00 P
 2.50 CR P



94.40							10
8140.43B (Euro 3 Sofim)	4cyl.	2800cc	78kW (106PS)	Diesel	Turbo Intercooled		TD16514
8140.43B.4300 (Euro 3 Sofim)	4cyl.	2800cc	78kW (106PS)	Diesel	Turbo Intercooled		TD25968
8140.43B.4305 (Euro 3 Sofim)	4cyl.	2800cc	78kW (106PS)	Diesel	Turbo Intercooled		TD25966
8140.43B.4320 (Euro 3 Sofim)	4cyl.	2800cc	78kW (106PS)	Diesel	Turbo Intercooled		TD25967
8140.43B.4325 (Euro 3 Sofim)	4cyl.	2800cc	78kW (106PS)	Diesel	Turbo Intercooled		TD25969
8140.43B.4330 (Euro 3 Sofim)	4cyl.	2800cc	78kW (106PS)	Diesel	Turbo Intercooled		TD25970
8140.43B.4335 (Euro 3 Sofim)	4cyl.	2800cc	78kW (106PS)	Diesel	Turbo Intercooled		TD25971
DAILY III 29 L 11			05/99→04/06	DAILY III 40 C 11			04/01→11/03
DAILY III 29 L 11 V			05/99→07/07	DAILY III 50 C 11			05/99→07/07
DAILY III 35 S 11,35 C 11			05/99→04/06	Fumo			09/01→
DAILY III 35 S 11 V,35 C 11 V			05/99→07/07				

- 14-021321-00 D B 97.54 C 167.00 D 100.90 E 5.00
- 14-028930-00 D B 97.50 C 167.00 D 100.90 E 5.00
- 14-028931-00 D B 97.58 C 167.00 D 100.90 E 5.00
- 14-028932-00 D B 97.70 C 167.00 D 100.90 E 5.00

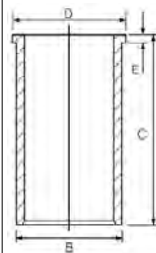

94.40							11
8140.43C.4000 (Euro 3 Sofim)	4cyl.	2800cc	78kW (106PS)	Diesel	Turbo Intercooled		TD25972
8140.43C.4005 (Euro 3 Sofim)	4cyl.	2800cc	78kW (106PS)	Diesel	Turbo Intercooled		TD25973
8140.43C.4020 (Euro 3 Sofim)	4cyl.	2800cc	78kW (106PS)	Diesel	Turbo Intercooled		TD25974
8140.43C.4021 (Euro 3 Sofim)	4cyl.	2800cc	78kW (106PS)	Diesel	Turbo Intercooled		TD25975
8140.43C.4025 (Euro 3 Sofim)	4cyl.	2800cc	78kW (106PS)	Diesel	Turbo Intercooled		TD25976
8140.43C.4026 (Euro 3 Sofim)	4cyl.	2800cc	78kW (106PS)	Diesel	Turbo Intercooled		TD25977
8140.43C.4030 (Euro 3 Sofim)	4cyl.	2800cc	78kW (106PS)	Diesel	Turbo Intercooled		TD25978
8140.43C.4031 (Euro 3 Sofim)	4cyl.	2800cc	78kW (106PS)	Diesel	Turbo Intercooled		TD25979
8140.43C.4035 (Euro 3 Sofim)	4cyl.	2800cc	78kW (106PS)	Diesel	Turbo Intercooled		TD25980
8140.43C.4036 (Euro 3 Sofim)	4cyl.	2800cc	78kW (106PS)	Diesel	Turbo Intercooled		TD25981

87-122200-10 STD
87-122208-10 0.60mm

- A 58.75
- B- 19.40
- BØ 39.25
- D 87.60
- 32x72



AK KK RT TP

08-122200-00 STD
08-122208-00 0.60mm

- 2.50 CK P
- 2.00 P
- 2.50 CR P

- 14-021321-00 D B 97.54 C 167.00 D 100.90 E 5.00
- 14-028930-00 D B 97.50 C 167.00 D 100.90 E 5.00
- 14-028931-00 D B 97.58 C 167.00 D 100.90 E 5.00
- 14-028932-00 D B 97.70 C 167.00 D 100.90 E 5.00

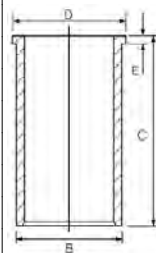

94.40							12
8140.43K.4020 (Euro 3 Sofim)	4cyl.	2800cc	107kW (145PS)	Diesel	Turbo Intercooled		TD25982
8140.43K.4030 (Euro 3 Sofim)	4cyl.	2800cc	107kW (145PS)	Diesel	Turbo Intercooled		TD25983
8140.43N (Euro 3 Sofim)	4cyl.	2800cc	107kW (146PS)	Diesel	Turbo Intercooled		TD16873
8140.43N.4300 (Euro 3 Sofim)	4cyl.	2800cc	107kW (146PS)	Diesel	Turbo Intercooled		TD25984





8140.43N.4320 (Euro 3 Sofim)	4cyl.	2800cc	107kW (146PS)	Diesel	Turbo Intercooled	TD25985
8140.43N.4330 (Euro 3 Sofim)	4cyl.	2800cc	107kW (146PS)	Diesel	Turbo Intercooled	TD25986
8140.43N.4400 (Euro 3 Sofim)	4cyl.	2800cc	107kW (146PS)	Diesel	Turbo Intercooled	TD25987
8140.43N.4430 (Euro 3 Sofim)	4cyl.	2800cc	107kW (146PS)	Diesel	Turbo Intercooled	TD25988
8140.43S (Euro 3 Sofim)	4cyl.	2800cc	92kW (125PS)	Diesel	Turbo Intercooled	TD16874
8140.43S.4000 (Euro 3 Sofim)	4cyl.	2800cc	92-94kW (125-128PS)	Diesel	Turbo Intercooled	TD25995
8140.43S.4020 (Euro 3 Sofim)	4cyl.	2800cc	92-94kW (125-128PS)	Diesel	Turbo Intercooled	TD25996
8140.43S.4030 (Euro 3 Sofim)	4cyl.	2800cc	92-94kW (125-128PS)	Diesel	Turbo Intercooled	TD25997
8140.43S.4140 (Euro 3 Sofim)	4cyl.	2800cc	92-94kW (125-128PS)	Diesel	Turbo Intercooled	TD25998
8140.43S.4300 (Euro 3 Sofim)	4cyl.	2800cc	92-94kW (125-128PS)	Diesel	Turbo Intercooled	TD25999
8140.43S.4320 (Euro 3 Sofim)	4cyl.	2800cc	92-94kW (125-128PS)	Diesel	Turbo Intercooled	TD26000
8140.43S.4330 (Euro 3 Sofim)	4cyl.	2800cc	92-94kW (125-128PS)	Diesel	Turbo Intercooled	TD26001
8140.43S.4400 (Euro 3 Sofim)	4cyl.	2800cc	92-94kW (125-128PS)	Diesel	Turbo Intercooled	TD26002
8140.43S.4420 (Euro 3 Sofim)	4cyl.	2800cc	92-94kW (125-128PS)	Diesel	Turbo Intercooled	TD26003
8140.43S.4430 (Euro 3 Sofim)	4cyl.	2800cc	92-94kW (125-128PS)	Diesel	Turbo Intercooled	TD26004

ALERO	08/00→12/08	DAILY III 40 C 15	11/01→04/06
DAILY III 29 L 13	05/01→07/07	DAILY III 40 C 15, 50 C 15	05/99→05/06
DAILY III 35 C 15	11/01→04/06	DAILY III 50 C 13	05/99→07/07
DAILY III 35 S 13,35 C 13	05/99→04/06	DAILY III 50 C 15	01/01→04/06
DAILY III 35 S 13, 40 C 13, 50 C 13	05/99→05/06	DAILY III 65 C 15	11/01→04/06
DAILY III 35 S 13 V,35 C 13 V	05/99→07/07	POWER DAILY 36.13, 39.13, 42.13, 50.13	12/07→
DAILY III 35 S 15 V, 35 C 15 V	11/02→07/07	POWER DAILY 42.13, 50.13	12/07→
DAILY III 40 C 13	05/99→04/06	POWER DAILY A36.13, A39.13, A42.13, A50.13	12/07→

87-122200-00 STD
87-122208-00 0.60mm

A 58.70
B- 21.30
BØ 39.40
D 87.60
 32x72

AK KK RT TP



08-122200-00 STD
08-122208-00 0.60mm

2.50  CK P
 2.00  P
 2.50  CR P

14-021321-00 D **B** 97.54 **C** 167.00 **D** 100.90 **E** 5.00
14-028930-00 D **B** 97.50 **C** 167.00 **D** 100.90 **E** 5.00
14-028931-00 D **B** 97.58 **C** 167.00 **D** 100.90 **E** 5.00
14-028932-00 D **B** 97.70 **C** 167.00 **D** 100.90 **E** 5.00

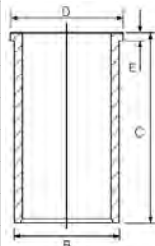

94.40

13

8140.63 (Euro 2 Sofim)	4cyl.	2800cc	62-64kW (84-87PS)	Diesel	TD10389
8140.63.4000 (Euro 3 Sofim)	4cyl.	2800cc	62-64kW (84-87PS)	Diesel	TD20478
DAILY II 30-8	09/98→05/99	DAILY III 29 L 9 V	05/99→07/07		
DAILY II 30-8 V	09/98→05/99	DAILY III 35 S 9,35 C 9	05/99→04/06		
DAILY II 35-8	09/98→05/99	DAILY III 35 S 9 V,35 C 9 V	05/99→07/07		
DAILY III 29 L 9	05/99→04/06				

87-108200-00 STD
87-108208-00 0.60mm

A 55.00
B- 2.80
D 90.00
 32x68

AK HA RT TP



08-108200-00 STD
08-108208-00 0.60mm

3.00  CR P
 2.00  P
 2.50  CR P

14-021321-00 D **B** 97.54 **C** 167.00 **D** 100.90 **E** 5.00
14-028930-00 D **B** 97.50 **C** 167.00 **D** 100.90 **E** 5.00
14-028931-00 D **B** 97.58 **C** 167.00 **D** 100.90 **E** 5.00
14-028932-00 D **B** 97.70 **C** 167.00 **D** 100.90 **E** 5.00

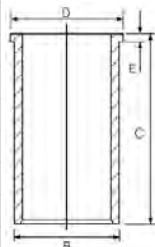







95.00 **14**

803 A.062 (8030.01)	3cyl.	2339cc		Diesel	MP570
804A (8040.01)	4cyl.	3119cc		Diesel	MP4009
806 A (8060.01/.11)	6cyl.	4678cc		Diesel	MP572
8025.01	2cyl.	1559cc		Diesel	MP569



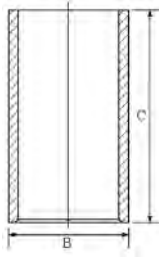

INDUSTRIAL, TRUCK & BUS

<p>87-207200-00 <i>STD</i></p> <p>87-207208-00 <i>0.60mm</i></p> <p>A 59.60 B- 23.50 BØ 42.20 D 101.15  32x84</p> 	<p>08-207200-00 <i>STD</i></p> <p>08-207208-00 <i>0.60mm</i></p> <p>2.50  CR P 2.50  P 5.50  CR P</p>	<p>14-010620-00 <i>D</i> B 99.00 C 187.00</p> <p>14-011061-00 <i>D</i> B 99.10 C 187.00</p> 
---	--	---

95.80 **15**

F1CE0481A	4cyl.	2998cc	100-114kW (136-155PS)	Diesel	Turbo Intercooled	TD19195
F1CE0481B (Euro 3)	4cyl.	2998cc	122kW (166PS)	Diesel	Turbo Intercooled	TD22675
F1CE0481F (Euro 4/5)	4cyl.	2998cc	107kW (146PS)	Diesel	Turbo Intercooled	TD39397
F1CE0481H (Euro 4/5)	4cyl.	2998cc	130kW (177PS)	Diesel	Turbo Intercooled	TD39400
F1CE0481L (Euro 4)	4cyl.	2998cc	107kW (146PS)	Diesel	Turbo Intercooled	TD27239

DAILY III 35 C 14	09/04→04/06	DAILY IV 40C18 V, 40C18 V/P	05/06→08/11
DAILY III 35 C 17, 35 S 17	01/05→04/06	DAILY IV 45C15	05/06→08/11
DAILY III 35 S 14, 50 C 14	01/04→05/06	DAILY IV 45C15 V	05/06→08/11
DAILY III 40 C 14	09/04→04/06	DAILY IV 45C18	05/06→08/11
DAILY III 40 C 17, 40 S 17	07/99→12/06	DAILY IV 45C18, 45C18 /P, 45C18 D, 45C18 D/P	05/06→08/11
DAILY III 40 C 17, 50 C 17	01/04→05/06	DAILY IV 50C15	05/06→08/11
DAILY III 45 C 14	07/99→04/06	DAILY IV 50C15 V, 50C15 V/P	05/06→08/11
DAILY III 50 C 14	09/04→04/06	DAILY IV 50C18	05/06→08/11
DAILY III 50 C 17	09/04→04/06	DAILY IV 50C18 V, 50C18 V/P	05/06→08/11
DAILY III 65 C 14	09/04→04/06	DAILY IV 55S18W	06/06→08/11
DAILY III 65 C 17	09/04→04/06	DAILY IV 60C15, 60C15 /P, 60C15 D, 60C15 D/P	05/06→08/11
DAILY IV 35C15	05/06→08/11	DAILY IV 60C15 V	05/06→08/11
DAILY IV 35C15 V, 35C15 V/P	05/06→08/11	DAILY IV 60C18	05/06→08/11
DAILY IV 35C18, 35S18	05/06→08/11	DAILY IV 65C15	05/06→08/11
DAILY IV 35C18 V, 35C18 V/P, 35S18 V, 35S18 V/P	05/06→08/11	DAILY IV 65C15, 65C15 /P, 65C15 D, 65C15 D/P	05/06→08/11
DAILY IV 35S14	08/07→03/12	DAILY IV 65C18	05/06→08/11
DAILY IV 35S15	06/06→08/11	DAILY IV 70C15	07/08→08/11
DAILY IV 35S18W	06/06→08/11	Fumo	09/06→
DAILY IV 40C15	05/06→08/11	MASSIF 3.0 HPI	10/08→02/11
DAILY IV 40C15 V, 40C15 V/P	05/06→08/11	MASSIF 3.0 HPT	10/08→02/11
DAILY IV 40C18	05/06→08/11		

<p>87-421600-00 <i>STD</i></p> <p>A 63.00 B- 16.00 BØ 50.50 D 93.50  36x80</p> <p>AK KK RT TP</p> 	<p>08-421600-00 <i>STD</i></p> <p>08-421606-00 <i>0.40mm</i></p> <p>2.50  CK P 2.00  P 2.50  CR P</p>
---	--

95.80 **16**

F1CE3481B	4cyl.	2998cc	107kW (145PS)	Diesel	Turbo Intercooled	TD36090
F1CE3481C	4cyl.	2998cc	125kW (170PS)	Diesel	Turbo Intercooled	TD26636





F1CE3481D (Euro 5)	4cyl.	2998cc	150kW (205PS)	Diesel	Turbo Intercooled	TD26942
F1CE3481J (Euro 5)	4cyl.	2998cc	107kW (146PS)	Diesel	Turbo Intercooled	TD26940
F1CE3481K (Euro 5)	4cyl.	2998cc	125kW (170PS)	Diesel	Turbo Intercooled	TD26941
F1CE3481L	4cyl.	2998cc	103-110kW (140-150PS)	Diesel	Turbo Intercooled	TD26939
CITYCLASS			01/15→		DAILY IV 65C14, 65C14 /P	09/09→08/11
DAILY IV 35C14, 35C14 /P, 35S14, 35S14 /P, 35S14 D, 35S14 D/P			09/09→08/11		DAILY IV 65C14 V, 65C14 V/P	09/09→08/11
DAILY IV 35C14 V, 35C14 V/P, 35S14 V, 35S14 V/P			09/09→08/11		DAILY IV 65C17, 65C17 /P	07/07→08/11
DAILY IV 35C17, 35C17 /P, 35S17, 35S17 /P, 35S17 D			07/07→08/11		DAILY IV 65C17 V, 65C17 V/P	07/07→08/11
DAILY IV 35C17 V, 35C17 V/P, 35S17 V, 35S17 V/P			07/07→08/11		DAILY IV 70C14, 70C14 /P	09/09→08/11
DAILY IV 35S17 W, 35S17 WD			07/07→08/11		DAILY IV 70C14 V, 70C14 V/P	09/09→08/11
DAILY IV 40C14, 40C14 /P			09/09→08/11		DAILY IV 70C17, 70C17 /P	07/07→08/11
DAILY IV 40C14 V, 40C14 V/P			09/09→08/11		DAILY IV 70C17V, 70C17 V/P	07/07→08/11
DAILY IV 40C17, 40C17 /P			07/07→08/11		DAILY V 35C15, 35S15, 40C15, 45C15, 50C15, 60C15, 65C15, 70C15	09/11→02/14
DAILY IV 40C17 V, 40C17 V/P			07/07→08/11		DAILY V 35C15 V, 40C15 V, 45C15 V, 50C15 V, 60C15 V, 65C15 V	09/11→02/14
DAILY IV 45C14, 45C14 /P			09/09→08/11		DAILY V 35C17, 35S17, 40C17, 45C17, 50C17, 60C17, 65C17, 70C17	09/11→02/14
DAILY IV 45C17, 45C17 /P			07/07→08/11		DAILY V 35C21, 35S21, 40C21, 45C21, 50C21, 60C21, 65C21, 70C21	09/11→02/14
DAILY IV 45C17 V, 45C17 V/P			07/07→08/11		DAILY V 35C21 V, 35S21 V, 40C21 V, 45C21 V, 50C21 V	09/11→02/14
DAILY IV 50C14, 50C14 /P			09/09→08/11		DAILY V 35S14	04/12→02/14
DAILY IV 50C14 V, 50C14 V/P			09/09→08/11		DAILY V 35S17, 40C17, 45C17, 50C17	09/11→02/14
DAILY IV 50C17, 50C17 /P			07/07→08/11		DAILY V 50C15	09/11→02/14
DAILY IV 50C17 V, 50C17 V/P			07/07→08/11		DAILY V 55S17W	09/11→02/14
DAILY IV 55S17 W, 55S17 WD			07/07→08/11		DAILY VI 35S14, 35S15, 35C15, 40S14, 40C15, 50C15, 60C5, 65C15,...	03/14→
DAILY IV 60C14, 60C14 /P			09/09→08/11		DAILY VI 35S15, 35C15, 40C15, 45C15, 50C15, 65C15, 70C15	03/14→04/16
DAILY IV 60C17, 60C17 /P			07/07→08/11		DAILY VI 35S15, 55S15, 70S15, 70C15	03/14→
DAILY IV 60C17 V, 60C17 V/P			07/07→08/11		DAILY VI 40C15, 50C15, 60C15	03/14→



87-421600-10 STD

- A** 63.00
- B-** 16.00
- BØ** 53.20
- D** 93.40
-  36x80



AK KK RT TP

08-421600-10 STD

- 2.50  GDC P
- 2.00  P
- 2.50  CK P



100.00

17

8025.02	2cyl.	1728cc		Diesel	MP573
8030.02	3cyl.	2592cc	46kW (62PS)	Diesel	MP574
8035.02	3cyl.	2592cc	33-40kW (45-54PS)	Diesel	TD25194
8045.02	4cyl.	3456cc	44-50kW (60-68PS)	Diesel	TD25195
8060.02.000	6cyl.	5184cc	90kW (122PS)	Diesel	TD6852
8060.02.001	6cyl.	5184cc	90kW (122PS)	Diesel	TD10468
8060.02.003	6cyl.	5184cc	90kW (122PS)	Diesel	TD10469
8060.02.070	6cyl.	5184cc	90kW (122PS)	Diesel	TD6843
8065.02.007	6cyl.	5184cc	74kW (101PS)	Diesel	TD25315
8065.02.200	6cyl.	5184cc	70-74kW (95-101PS)	Diesel	TD25316
8065.02.207	6cyl.	5184cc	74kW (101PS)	Diesel	TD25317
8065.02.217	6cyl.	5184cc	74kW (101PS)	Diesel	TD25318
400			01/68→12/86	Series 75	01/75→12/79
500 Serie			01/71→12/80	Series 80	01/72→12/76
600 Serie			01/71→12/86	Series 90	01/72→12/79
900			01/79→12/84	Series 100	01/73→12/76
1000			01/72→12/76	Series 110	01/73→12/83





INDUSTRIAL, TRUCK & BUS Series 600 01/70→12/72

<p>87-206800-00 STD </p> <p>87-206808-00 0.60mm </p> <p>A 59.60 B- 23.70 BØ 47.00 D 101.15 32x84</p>	<p>08-206800-00 STD 08-206808-00 0.60mm</p> <p>2.50 CR P 2.50 P 5.50 CR P</p>	<p>14-010170-00 D B 103.00 C 187.00 14-011021-00 D B 103.06 C 187.00 14-011022-00 D B 103.10 C 187.00 14-013401-00 D B 103.04 C 187.00</p>	
		<p>14-021540-00 D B 103.00 C 187.00 D 104.00 E 5.00</p>	
<p>87-206800-10 STD</p> <p>A 59.60 B- 23.70 BØ 45.40 D 101.15 32x84</p>	<p>08-206800-00 STD 08-206808-00 0.60mm</p> <p>2.50 CR P 2.50 P 5.50 CR P</p>		

Piston with central combustion chamber. Kolben mit zentraler Verbrennungskammer. Piston à chambre de combustion centrale. Pistón con cámara de combustión central. Pistone con camera di combustione centrale.

	100.00	18
8035.06	3cyl. 2708cc 33-40kW (45-54PS) Diesel	MP4008
8035.06.200	3cyl. 2708cc 33-41kW (45-56PS) Diesel	TD25535
8035.06.206	3cyl. 2708cc 38-40kW (52-54PS) Diesel	TD25536
8035.06.208	3cyl. 2708cc 38-40kW (52-54PS) Diesel	TD25537
8035.06.216	3cyl. 2708cc 38-40kW (52-55PS) Diesel	TD25538
8035.06.220	3cyl. 2708cc 33kW (45PS) Diesel	TD25539
8035.06.222	3cyl. 2708cc 33-40kW (45-54PS) Diesel	TD25540
8035.06.223	3cyl. 2708cc 38kW (52PS) Diesel	TD25541
8035.06.306	3cyl. 2708cc 38kW (52PS) Diesel	TD25542
8035.06.307	3cyl. 2708cc 38-40kW (52-54PS) Diesel	TD25543
8035.06.308	3cyl. 2708cc 38-40kW (52-54PS) Diesel	TD25544
8035.06.309	3cyl. 2708cc 38kW (52PS) Diesel	TD25545
8035.06.317	3cyl. 2708cc 38-40kW (52-55PS) Diesel	TD25546
8035.06.320	3cyl. 2708cc 34kW (46PS) Diesel	TD25547
8035.06.321	3cyl. 2708cc 33-34kW (45-46PS) Diesel	TD25548
8035.06.322	3cyl. 2708cc 38kW (52PS) Diesel	TD25549
8035.06.323	3cyl. 2708cc 33-40kW (45-54PS) Diesel	TD25550





8045.06	4cyl.	3613cc	44-73kW (60-99PS)	Diesel	TD28623
8045.06.200	4cyl.	3613cc	51kW (69PS)	Diesel	TD25521
8045.06.208	4cyl.	3613cc	51kW (69PS)	Diesel	TD25522
8045.06.213	4cyl.	3613cc	48-51kW (65-69PS)	Diesel	TD25523
8045.06.214	4cyl.	3613cc	73kW (99PS)	Diesel	TD25524
8045.06.215	4cyl.	3613cc	73kW (99PS)	Diesel	TD25525
8045.06.225	4cyl.	3613cc	48kW (65PS)	Diesel	TD25526
8045.06.319	4cyl.	3613cc	48kW (65PS)	Diesel	TD25527
8045.06.326	4cyl.	3613cc	48kW (65PS)	Diesel	TD25528
8065.06.000	6cyl.	5418cc	74kW (100PS)	Diesel	TD25390

66	01/85→12/99	INDUSTRIAL, TRUCK & BUS	
88	01/89→12/93	L	01/96→12/98
90	01/84→12/92	TL	01/98→12/04
94	01/93→12/96	TN	01/99→12/02

87-781900-10 STD
87-781908-10 0.60mm

A 65.15
B- 22.70
D 108.50
 38x85

08-781900-00 STD
08-781908-00 0.60mm

2.50 MOL P
 2.50 P
 4.00 CR P

14-010780-00 D **B** 103.02 **C** 196.00
14-010781-00 D **B** 103.06 **C** 196.00
14-010782-00 D **B** 103.10 **C** 196.00

100.00 **19**

8040.02	4cyl.	3456cc	60kW (82PS)	Diesel	TD6840
8040.02	4cyl.	3455cc		Diesel	MP575
8040.02.041	4cyl.	3456cc	56kW (76PS)	Diesel	TD6925
8040.02.267	4cyl.	3456cc	56kW (76PS)	Diesel	TD5606
8040.02.300	4cyl.	3456cc	56kW (76PS)	Diesel	TD5605
8040.02.360	4cyl.	3456cc	56kW (76PS)	Diesel	TD5944
8040.02.367	4cyl.	3456cc	56kW (76PS)	Diesel	TD5945

INDUSTRIAL, TRUCK & BUS	Series 55	01/72→12/76
Series 50	Series 65	01/75→12/79

87-206800-00 STD
87-206808-00 0.60mm

A 59.60
B- 23.70
BØ 47.00
D 101.15
 32x84

08-206800-00 STD
08-206808-00 0.60mm

2.50 CR P
 2.50 P
 5.50 CR P

14-010170-00 D **B** 103.00 **C** 187.00
14-011021-00 D **B** 103.06 **C** 187.00
14-011022-00 D **B** 103.10 **C** 187.00
14-013401-00 D **B** 103.04 **C** 187.00





14-021540-00 *D*

B 103.00 C 187.00 D 104.00 E 5.00

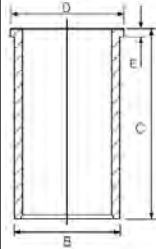

87-206800-10 *STD*

A 59.60
B- 23.70
BØ 45.40
D 101.15
 32x84



08-206800-00 *STD*

08-206808-00 *0.60mm*

2.50 CR P
2.50 P
5.50 CR P

87-781900-30 *STD*

87-781908-30 *0.60mm*

A 59.60
B- 23.70
BØ 47.10
D 101.15
 34x84



08-781900-10 *STD*

08-781908-10 *0.60mm*

2.50 CK P
2.50 P
4.00 CR P

Piston with central combustion chamber. Kolben mit zentraler Verbrennungskammer. Piston à chambre de combustion centrale. Pistón con cámara de combustión central. Pistone con camera di combustione centrale.

102.00						20
BF4L 913 T	4cyl.	4086cc	64-78kW (87-106PS)	Diesel	Turbo	TD10402
BF6L 913 T	6cyl.	6128cc	96-112kW (131-152PS)	Diesel	Turbo	TD10425
MK	01/83→12/91		P/PA-Haubenfahrzeuge		01/83→09/90	

87-174600-30 *STD*

87-174607-30 *0.50mm*

A 69.10
B- 17.60
BØ 58.00
B+ 6.00
D 123.60
 35x80



AK KK RT

08-174600-10 *STD*

08-174607-10 *0.50mm*

3.00 M0 P
2.50 P
2.50 P
5.00 CR P

14-900060-00 *DH*

B 109.90 C 222.30 D 120.00 E 136.80

14-900100-00 *DH*

B 109.90 C 222.30 D 120.00 E 137.30

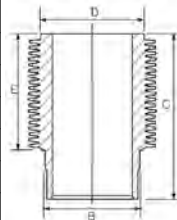

Hone-Lapped Hongeläppt Rodée à la pierre Lapeado buñido Parzialmente rodati

102.00						21
F4AE0481A (Euro 3)	4cyl.	3920cc	125kW (170PS)	Diesel	Turbo Intercooled	TD16294
F4AE0481C (Euro 3)	4cyl.	3920cc	110kW (149PS)	Diesel	Turbo Intercooled	TD16293
F4AE0481D (Euro 3)	4cyl.	3920cc	95kW (130PS)	Diesel	Turbo Intercooled	TD16292
F4AE0681A (Euro 3)	6cyl.	5880cc	202-220kW (275-299PS)	Diesel	Turbo Intercooled	TD16520





F4AE0681B (Euro 3)	6cyl.	5880cc	176kW (240PS)	Diesel	Turbo Intercooled	TD16519
F4AE0681C (Euro 3)	6cyl.	5880cc	154kW (210PS)	Diesel	Turbo Intercooled	TD24238
F4AE0681D (Euro 3)	6cyl.	5880cc	132-155kW (180-211PS)	Diesel	Turbo Intercooled	TD16296
F4AE0681E (Euro 3)	6cyl.	5880cc	132-134kW (180-181PS)	Diesel	Turbo Intercooled	TD16295
AFRIWAY			03/16→	EUROPOLIS		09/09→
C-Series			09/03→	NOVUS		01/05→12/11
EUROCARGO I-III			09/00→09/15	PRIMA		01/10→12/11
EUROFIRE			09/00→	URBIN		01/07→

87-145000-00 STD
87-145007-00 0.50mm

A 71.38
B- 18.55
BØ 56.50
D 105.38
 40x83



AK KK RT TP

08-145000-00 STD
08-145007-00 0.50mm
08-145008-00 0.60mm

3.00  CK P
 2.39  P
 4.00  CR P

102.00

22

F4AE3481A (Euro 4/5)	4cyl.	3920cc	130-134kW (177-182PS)	Diesel	Turbo Intercooled	TD21097
F4AE3481B (Euro 4/5)	4cyl.	3920cc	130kW (177PS)	Diesel	Turbo Intercooled	TD21096
F4AE3481C (Euro 4/5)	4cyl.	3920cc	103kW (140PS)	Diesel	Turbo Intercooled	TD21092
F4AE3481D (Euro 4/5)	4cyl.	3920cc	118kW (160PS)	Diesel	Turbo Intercooled	TD21095
F4AE3681A (Euro 4/5)	6cyl.	5880cc	220kW (299PS)	Diesel	Turbo Intercooled	TD22585
F4AE3681B (Euro 4/5)	6cyl.	5880cc	160kW (218PS)	Diesel	Turbo Intercooled	TD21098
F4AE3681C (Euro 4/5)	6cyl.	5880cc	135kW (183PS)	Diesel	Turbo Intercooled	TD22602
F4AE3681D (Euro 4/5)	6cyl.	5880cc	185kW (251PS)	Diesel	Turbo Intercooled	TD21099
F4AE3681E (Euro 4/5)	6cyl.	5880cc	205-206kW (279-280PS)	Diesel	Turbo Intercooled	TD21100
EUROCARGO I-III			09/00→09/15	PRIMA		01/10→12/16
EUROFIRE			05/06→	PROWAY		01/09→
EUROMIDI			05/07→	TECTOR I		01/12→
MIDIRIDER			05/07→	VERTIS		10/10→
NOVUS			01/10→12/16			

87-427900-00 STD

A 71.40
B- 17.15
BØ 56.80
D 105.30
 40x83



AK KK RT TP

08-427900-00 STD

3.00  CK P
 2.39  P
 4.00  CR P

102.00

23

BF6L 913	6cyl.	6128cc	118-124kW (160-169PS)	Diesel	Turbo	TD10451
F4L 913	4cyl.	4086cc	64kW (87PS)	Diesel		TD10414
MK			01/83→12/91	P/PA-Haubenfahrzeuge		07/89→12/93





14-900060-00 DH B 109.90 C 222.30 D 120.00 E 136.80
 14-900100-00 DH B 109.90 C 222.30 D 120.00 E 137.30
 14-900110-00 DH B 109.90 C 220.40 D 124.50 E 134.90

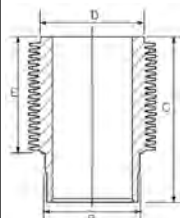

Hone-Lapped

Hongeläppt

Rodée à la pierre





Lapeado buñido

Parzialmente rodati





103.00					24
8035.04	3cyl.	2748cc		Diesel	MP4007
8035.04.265	3cyl.	2749cc	35-37kW (48-50PS)	Diesel	TD25325
8035.04.270	3cyl.	2749cc	43kW (58PS)	Diesel	TD25326
8040.04.200	4cyl.	3666cc	63kW (86PS)	Diesel	TD10397
8045.04.270	4cyl.	3666cc	57kW (78PS)	Diesel	TD25335
8055.04	5cyl.	4583cc		Diesel	MP3484
8055.04.200	5cyl.	4583cc	63-66kW (86-90PS)	Diesel	TD25345
8060.04	6cyl.	5499cc	96kW (131PS)	Diesel	TD10457
8060.04.000	6cyl.	5499cc	99kW (135PS)	Diesel	TD6853
8060.04.055	6cyl.	5499cc	96kW (131PS)	Diesel	TD10420
8060.04.060	6cyl.	5500cc	96kW (131PS)	Diesel	TD10417
8060.04.070	6cyl.	5499cc	99kW (135PS)	Diesel	TD10413
8060.04.620	6cyl.	5499cc	99kW (135PS)	Diesel	TD10408
8060.04.621	6cyl.	5499cc	99kW (135PS)	Diesel	TD10409
8060.04.630	6cyl.	5500cc	99kW (135PS)	Diesel	TD10470
8060.04.639	6cyl.	5500cc	99kW (135PS)	Diesel	TD10463
8060.04.658	6cyl.	5499cc	99kW (135PS)	Diesel	TD10390
8060.04.660	6cyl.	5500cc	96-99kW (131-135PS)	Diesel	TD10421
8060.04.669	6cyl.	5500cc	99-102kW (135-139PS)	Diesel	TD10460
8060.04.670	6cyl.	5500cc	99kW (135PS)	Diesel	TD10449
8060.04.672	6cyl.	5500cc	73kW (99PS)	Diesel	TD10450
8060.04.675	6cyl.	5500cc	99kW (135PS)	Diesel	TD10464
8060.04.689	6cyl.	5500cc	99-102kW (135-139PS)	Diesel	TD10462
8065.04	6cyl.	5499cc		Diesel	MP14933
8065.04.200	6cyl.	5499cc	81-85kW (110-116PS)	Diesel	TD25322
8065.04-H	6cyl.	5499cc		Diesel	MP13486
500 Serie		01/78→12/86		INDUSTRIAL	
700		01/78→12/84		INDUSTRIAL, TRUCK & BUS	
800		01/80→12/84		ZETA	11/79→03/91
1000		01/76→12/84			

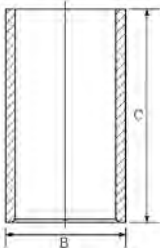
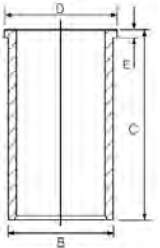



<p>87-782000-00 STD 87-782008-00 0.60mm</p> <p>A 59.60 B- 22.70 Bø 50.00 D 101.15  34x90</p> 	<p>08-782000-00 STD 08-782008-00 0.60mm</p> <p>2.50  MOL P 2.50  P 4.00  CR P</p>	<p>14-010180-00 D B 107.00 C 187.00 14-010181-00 D B 107.06 C 187.00 14-010182-00 D B 107.10 C 187.00</p> 	
		<p>14-023551-00 D B 107.06 C 187.00 D 110.00 E 5.00</p> 	

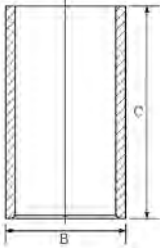

103.00					25
8041 L	4cyl.	3666cc		Diesel	MP13483
8061 L	6cyl.	5499cc		Diesel	MP23487
INDUSTRIAL, TRUCK & BUS					

<p>87-783900-00 STD</p> <p>A 59.61 B- 22.50 Bø 53.30 D 101.15  34x90</p> <p>RT</p> 	<p>08-783900-00 STD</p> <p>3.00  MOL P 2.50  P 4.00  CR</p>	<p>14-010180-00 D B 107.00 C 187.00 14-010181-00 D B 107.06 C 187.00 14-010182-00 D B 107.10 C 187.00</p> 	
---	---	--	--

103.00					26
8060.24.601	6cyl.	5500cc	124kW (169PS)	Diesel Turbo	TD10472
8060.24.670	6cyl.	5499cc	118kW (160PS)	Diesel Turbo	TD10447
8060.24.671	6cyl.	5499cc	118kW (160PS)	Diesel Turbo	TD10448
8060.24.678	6cyl.	5500cc	123kW (167PS)	Diesel Turbo	TD10465
8062.24.070	6cyl.	5499cc	118kW (160PS)	Diesel	TD10458

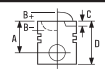

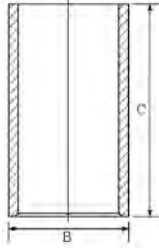
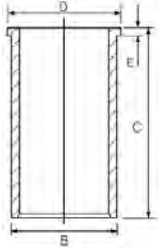

<p>87-783900-10 STD</p> <p>A 59.60 B- 22.80 BØ 49.80 D 101.15 34x90</p> <p>AK RT</p> 	<p>08-783900-00 STD</p> <p>3.00 MOL P 2.50 P 4.00 CR</p> 	<p>14-010180-00 D B 107.00 C 187.00 14-010181-00 D B 107.06 C 187.00 14-010182-00 D B 107.10 C 187.00</p> 	
		<p>14-023551-00 D B 107.06 C 187.00 D 110.00 E 5.00</p> 	

103.00 **27**

8065.24.000	6cyl.	5499cc	99kW (135PS)	Diesel	TD25348
8065.24.300	6cyl.	5499cc	90-91kW (121-124PS)	Diesel	TD25352

1000 01/79→12/84

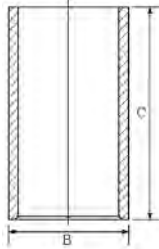
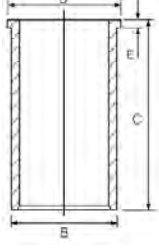
		<p>14-010180-00 D B 107.00 C 187.00 14-010181-00 D B 107.06 C 187.00 14-010182-00 D B 107.10 C 187.00</p> 	
		<p>14-023551-00 D B 107.06 C 187.00 D 110.00 E 5.00</p> 	

104.00 **28**

8035.05	3cyl.	2930cc		Diesel	MP4032-3
8045.05	4cyl.	3908cc	54-60kW (73-82PS)	Diesel	TD28624
8065.E	6cyl.	5861cc	82kW (112PS)	Diesel	TD28430

INDUSTRIAL, TRUCK & BUS TNF-A 01/04→





Series 90

01/93 →

87-247800-00 STD

A 65.15
B- 22.50
BØ 52.20
D 108.50
 38x85



TP

08-247800-00 STD

08-247808-00 0.60mm

2.50  MOL P
 2.50  P
 4.00  CR P

14-010940-00 D

B 107.00 **C** 198.00

14-010941-10 D

B 107.10 **C** 198.00

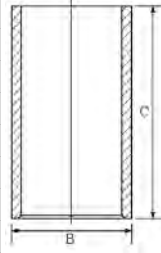

14-021361-00 D

B 107.02 **C** 198.00 **D** 110.87 **E** 5.00

14-021362-00 D

B 107.14 **C** 198.00 **D** 110.87 **E** 5.00

14-021363-00 D

B 107.44 **C** 198.00 **D** 110.87 **E** 5.00

14-021491-00 D

B 107.01 **C** 198.00 **D** 109.87 **E** 5.00

14-021492-00 D

B 107.05 **C** 198.00 **D** 109.87 **E** 5.00

14-021493-00 D

B 107.17 **C** 198.00 **D** 109.87 **E** 5.00

14-021494-00 D

B 107.47 **C** 198.00 **D** 109.87 **E** 5.00

14-024781-00 D

B 107.02 **C** 198.00 **D** 109.95 **E** 5.00

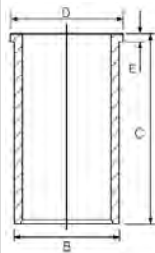

 **104.00**

29

8035.05.214	3cyl.	2931cc	37-44kW (50-60PS)	Diesel		TD22233
8035.05.215	3cyl.	2931cc	37-44kW (50-60PS)	Diesel		TD22234
8040.05.4990	4cyl.	3908cc	80kW (109PS)	Diesel	Turbo Intercooled	TD22235
8040.25.4990	4cyl.	3908cc	85kW (116PS)	Diesel	Turbo Intercooled	MP24132
8040.45.4180	4cyl.	3908cc	100kW (136PS)	Diesel	Turbo Intercooled	TD10406
8040.45.4380	4cyl.	3908cc	100kW (136PS)	Diesel	Turbo Intercooled	TD20438
8040.45.5200 (Euro 2)	4cyl.	3908cc	100kW (136PS)	Diesel	Turbo Intercooled	TD20439
8040.45.5201 (Euro 2)	4cyl.	3908cc	100kW (136PS)	Diesel	Turbo Intercooled	TD27290
8040.45.5203 (Euro 2)	4cyl.	3908cc	100kW (136PS)	Diesel	Turbo Intercooled	TD27291
8040.45.5280 (Euro 2)	4cyl.	3908cc	100kW (136PS)	Diesel	Turbo Intercooled	TD27293
8040.45.5281 (Euro 2)	4cyl.	3908cc	100kW (136PS)	Diesel	Turbo Intercooled	TD27294
8040.45D.5100 (Euro 2)	4cyl.	3908cc	85-100kW (116-136PS)	Diesel	Turbo Intercooled	TD20440
8040.45D.5101 (Euro 2)	4cyl.	3908cc	85kW (116PS)	Diesel	Turbo Intercooled	TD27295
8040.45D.5103 (Euro 2)	4cyl.	3908cc	85kW (116PS)	Diesel	Turbo Intercooled	TD27296
8040.45D.5105 (Euro 2)	4cyl.	3908cc	85kW (116PS)	Diesel	Turbo Intercooled	TD27297
8045.05.000	4cyl.	3908cc	59kW (80PS)	Diesel		TD25496
8045.05.213	4cyl.	3908cc	55kW (75PS)	Diesel		TD25500
8045.05.215	4cyl.	3908cc	55kW (75PS)	Diesel		TD25501
8045.25.310	4cyl.	3908cc	63kW (85PS)	Diesel	Turbo Intercooled	TD25364
8045.25.370	4cyl.	3908cc	75-103kW (102-140PS)	Diesel	Turbo Intercooled	TD25365
8045.25.375	4cyl.	3908cc	63-103kW (85-140PS)	Diesel	Turbo Intercooled	TD25366
8045.25.376	4cyl.	3908cc	75-103kW (102-140PS)	Diesel	Turbo Intercooled	TD25367





8045.25.381	4cyl.	3908cc	80-103kW (109-140PS)	Diesel	Turbo Intercooled	TD25369
8060.25V.4000	6cyl.	5861cc	130kW (177PS)	Diesel	Turbo Intercooled	TD7283
8060.25R.4210 (Euro 1)	6cyl.	5861cc	105kW (143PS)	Diesel	Turbo	TD27309
8060.25R.4220 (Euro 1)	6cyl.	5861cc	105kW (143PS)	Diesel	Turbo	TD27310
8060.25R.4225 (Euro 1)	6cyl.	5861cc	105kW (143PS)	Diesel	Turbo	TD27311
8060.25R.4230 (Euro 1)	6cyl.	5861cc	105kW (143PS)	Diesel	Turbo	TD27312
8060.25R.4240 (Euro 1)	6cyl.	5861cc	105kW (143PS)	Diesel	Turbo	TD27313
8060.25R.4250 (Euro 1)	6cyl.	5861cc	105kW (143PS)	Diesel	Turbo	TD27314
8060.25R.4285 (Euro 1)	6cyl.	5861cc	105kW (143PS)	Diesel	Turbo	TD27315
8060.25R.4290 (Euro 1)	6cyl.	5861cc	105kW (143PS)	Diesel	Turbo	TD27316
8060.25R.4295 (Euro 1)	6cyl.	5861cc	105kW (143PS)	Diesel	Turbo	TD27317
8060.25R.4360 (Euro 1)	6cyl.	5861cc	105kW (143PS)	Diesel	Turbo	TD27318
8060.25R.4362 (Euro 1)	6cyl.	5861cc	105kW (143PS)	Diesel	Turbo	TD27319
8060.25R.4750	6cyl.	5861cc	105kW (143PS)	Diesel	Turbo Intercooled	TD10907
8060.25R.4755	6cyl.	5861cc	105kW (143PS)	Diesel	Turbo	TD10908
8060.25R.4760	6cyl.	5861cc	105kW (143PS)	Diesel	Turbo Intercooled	TD10909
8060.25R.4764	6cyl.	5861cc	105kW (143PS)	Diesel	Turbo Intercooled	TD10910
8060.25R.4960 (Euro 1)	6cyl.	5861cc	105kW (143PS)	Diesel	Turbo	TD27321
8060.25R.4967 (Euro 1)	6cyl.	5861cc	105kW (143PS)	Diesel	Turbo	TD27322
8060.25R.4968 (Euro 1)	6cyl.	5861cc	105kW (143PS)	Diesel	Turbo	TD27323
8060.25R.4970 (Euro 1)	6cyl.	5861cc	105kW (143PS)	Diesel	Turbo	TD27324
8060.25R.4973 (Euro 1)	6cyl.	5861cc	105kW (143PS)	Diesel	Turbo	TD27325
8060.25R.4980 (Euro 1)	6cyl.	5861cc	105kW (143PS)	Diesel	Turbo	TD27326
8060.45.4300	6cyl.	5861cc	152kW (207PS)	Diesel	Turbo	MP19257
8060.45.4400	6cyl.	5861cc	152kW (207PS)	Diesel	Turbo	MP19257-1
8060.45.4702 (Euro 1)	6cyl.	5861cc	152kW (207PS)	Diesel	Turbo	TD10914
8060.45.4704 (Euro 1)	6cyl.	5861cc	152kW (207PS)	Diesel	Turbo	TD10915
8060.45.4706 (Euro 1)	6cyl.	5861cc	152kW (207PS)	Diesel	Turbo	TD10916
8060.45.4708	6cyl.	5861cc	152kW (207PS)	Diesel	Turbo	TD10917
8060.45.5200 (Euro 2)	6cyl.	5861cc	152-169kW (207-230PS)	Diesel	Turbo Intercooled	TD27106
8060.45.5201 (Euro 2)	6cyl.	5861cc	152kW (207PS)	Diesel	Turbo Intercooled	TD27107
8060.45.5203 (Euro 2)	6cyl.	5861cc	152kW (207PS)	Diesel	Turbo Intercooled	TD27108
8060.45.5205 (Euro 2)	6cyl.	5861cc	152kW (207PS)	Diesel	Turbo Intercooled	TD27109
8060.45.5220 (Euro 2)	6cyl.	5861cc	152kW (207PS)	Diesel	Turbo Intercooled	TD27112
8060.45.5221 (Euro 2)	6cyl.	5861cc	152kW (207PS)	Diesel	Turbo Intercooled	TD27113
8060.45.5223 (Euro 2)	6cyl.	5861cc	152kW (207PS)	Diesel	Turbo Intercooled	TD27114
8060.45.5232 (Euro 2)	6cyl.	5861cc	152kW (207PS)	Diesel	Turbo Intercooled	TD27115
8060.45.5233 (Euro 2)	6cyl.	5861cc	152kW (207PS)	Diesel	Turbo Intercooled	TD27116
8060.45.5234 (Euro 2)	6cyl.	5861cc	152kW (207PS)	Diesel	Turbo Intercooled	TD27117
8060.45.5235 (Euro 2)	6cyl.	5861cc	152kW (207PS)	Diesel	Turbo Intercooled	TD27118
8060.45.5250 (Euro 2)	6cyl.	5861cc	152kW (207PS)	Diesel	Turbo Intercooled	TD10918
8060.45.5251	6cyl.	5861cc	152kW (207PS)	Diesel	Turbo	TD10919
8060.45.5255	6cyl.	5861cc	152kW (207PS)	Diesel	Turbo	TD10920
8060.45B (Euro 2)	6cyl.	5861cc	130kW (177PS)	Diesel	Turbo Intercooled	TD27442
8060.45B.5100 (Euro 2)	6cyl.	5861cc	130-152kW (177-207PS)	Diesel	Turbo Intercooled	TD20415
8060.45B.5101 (Euro 2)	6cyl.	5861cc	130kW (177PS)	Diesel	Turbo Intercooled	TD27121
8060.45B.5103 (Euro 2)	6cyl.	5861cc	130kW (177PS)	Diesel	Turbo Intercooled	TD27122
8060.45B.5105 (Euro 2)	6cyl.	5861cc	130kW (177PS)	Diesel	Turbo Intercooled	TD27123
8060.45B.5111 (Euro 2)	6cyl.	5861cc	130kW (177PS)	Diesel	Turbo Intercooled	TD27125
8060.45B.5112 (Euro 2)	6cyl.	5861cc	130kW (177PS)	Diesel	Turbo Intercooled	TD27126





8060.45B.5113 (Euro 2)	6cyl.	5861cc	130kW (177PS)	Diesel	Turbo Intercooled	TD27127
8060.45B.5120 (Euro 2)	6cyl.	5861cc	130kW (177PS)	Diesel	Turbo Intercooled	TD27128
8060.45B.5121 (Euro 2)	6cyl.	5861cc	130kW (177PS)	Diesel	Turbo Intercooled	TD27129
8060.45B.5123 (Euro 2)	6cyl.	5861cc	130kW (177PS)	Diesel	Turbo Intercooled	TD27130
8060.45B.5124 (Euro 2)	6cyl.	5861cc	130kW (177PS)	Diesel	Turbo Intercooled	TD27131
8060.45B.5145 (Euro 2)	6cyl.	5861cc	130kW (177PS)	Diesel	Turbo Intercooled	TD27132
8060.45B.5146 (Euro 2)	6cyl.	5861cc	130kW (177PS)	Diesel	Turbo Intercooled	TD27133
8060.45B.5150 (Euro 2)	6cyl.	5861cc	130kW (177PS)	Diesel	Turbo Intercooled	TD27134
8060.45B.5151 (Euro 2)	6cyl.	5861cc	130kW (177PS)	Diesel	Turbo Intercooled	TD27136
8060.45B.5185 (Euro 2)	6cyl.	5861cc	130kW (177PS)	Diesel	Turbo Intercooled	TD27139
8060.45B.5186 (Euro 2)	6cyl.	5861cc	130kW (177PS)	Diesel	Turbo Intercooled	TD27140
8060.45K.6090 (Euro 1)	6cyl.	5861cc	167kW (227PS)	Diesel	Turbo Intercooled	TD20471
8060.45L.4400	6cyl.	5861cc		Diesel	Turbo	MP19257-2
8060.45M.7200	6cyl.	5861cc		Diesel	Turbo	MP59257
8060.45R.5001 (Euro 2)	6cyl.	5861cc	105kW (143PS)	Diesel	Turbo	TD16718
8060.45R.5003 (Euro 2)	6cyl.	5861cc	105kW (143PS)	Diesel	Turbo	TD16719
8060.45R.5050	6cyl.	5861cc	105kW (143PS)	Diesel	Turbo	TD10911
8060.45S.6000	6cyl.	5861cc	167kW (227PS)	Diesel	Turbo Intercooled	TD7307
8060.45S.6000 (Euro 1)	6cyl.	5861cc	167kW (227PS)	Diesel	Turbo	TD10480
8060.45S.6203 (Euro 1)	6cyl.	5861cc	167kW (227PS)	Diesel	Turbo	TD27165
8060.45S.6800 (Euro 1)	6cyl.	5861cc	167kW (227PS)	Diesel	Turbo	TD10478
8060.45S.7200 (Euro 2)	6cyl.	5861cc	167kW (227PS)	Diesel	Turbo Intercooled	TD20472
8060.45S TCA	6cyl.	5861cc	167kW (227PS)	Diesel	Turbo Intercooled	TD10482
8065.05.000	6cyl.	5863cc	85kW (116PS)	Diesel		TD25488
8065.05.330	6cyl.	5863cc	73kW (99PS)	Diesel		TD25495
8065.25.320	6cyl.	5863cc	105-110kW (143-150PS)	Diesel		TD25477

66	01/92→12/96	EUROFIRE	01/93→
88	01/89→12/93	F	01/90→12/96
90	01/84→12/92	INDUSTRIAL, TRUCK & BUS	
94	01/93→12/96	L	01/96→12/98
EUROCARGO I-III	01/91→09/15	TL	01/98→12/04

14-010940-00 D B 107.00 C 198.00
 14-010941-10 D B 107.10 C 198.00

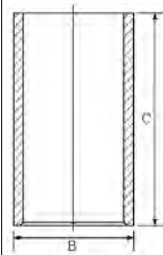



14-021361-00	<i>D</i>	B 107.02 C 198.00 D 110.87 E 5.00
14-021362-00	<i>D</i>	B 107.14 C 198.00 D 110.87 E 5.00
14-021363-00	<i>D</i>	B 107.44 C 198.00 D 110.87 E 5.00
14-021491-00	<i>D</i>	B 107.01 C 198.00 D 109.87 E 5.00
14-021492-00	<i>D</i>	B 107.05 C 198.00 D 109.87 E 5.00
14-021493-00	<i>D</i>	B 107.17 C 198.00 D 109.87 E 5.00
14-021494-00	<i>D</i>	B 107.47 C 198.00 D 109.87 E 5.00
14-024781-00	<i>D</i>	B 107.02 C 198.00 D 109.95 E 5.00

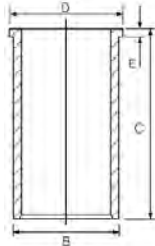

104.00

30

8040.05.200	4cyl.	3908cc	65kW (88PS)	Diesel	TD10399
8040.05.203	4cyl.	3908cc	65kW (88PS)	Diesel	TD16721
8040.05.230	4cyl.	3908cc	65kW (88PS)	Diesel	TD10398
8040.05.233	4cyl.	3908cc	65kW (88PS)	Diesel	TD16723
8040.05.235	4cyl.	3908cc	65kW (88PS)	Diesel	TD16724
8055.05.000	5cyl.	4885cc	66kW (90PS)	Diesel	TD25384
8060.05.000	6cyl.	5861cc	101kW (137PS)	Diesel	TD10424
8060.05.200	6cyl.	5861cc	99-102kW (135-139PS)	Diesel	TD10471
8060.05.246	6cyl.	5861cc	101kW (137PS)	Diesel	TD10391
8060.05.270	6cyl.	5861cc	101kW (137PS)	Diesel	TD10412
8060.05.280	6cyl.	5861cc	101kW (137PS)	Diesel	TD10423
8060.05.285	6cyl.	5861cc	101kW (137PS)	Diesel	TD10411
8060.05.289	6cyl.	5861cc	101kW (137PS)	Diesel	TD10461
8061.05	6cyl.	5861cc	82kW (112PS)	Diesel	TD28429
90		01/84→01/91	ZETA		11/85→12/92
Series 90		01/93→			

87-247800-10 *STD*

A	65.15
B-	22.50
BØ	52.00
D	108.50
	38x85

RT TP



08-247800-00 *STD*

08-247808-00 *0.60mm*

2.50		MOL P
2.50		P
4.00		CR P

14-010940-00 *D*

14-010941-10 *D*

B 107.00 **C** 198.00

B 107.10 **C** 198.00

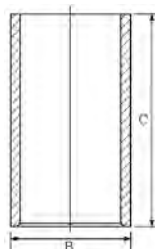



14-021361-00	D	B 107.02 C 198.00 D 110.87 E 5.00
14-021362-00	D	B 107.14 C 198.00 D 110.87 E 5.00
14-021363-00	D	B 107.44 C 198.00 D 110.87 E 5.00
14-021491-00	D	B 107.01 C 198.00 D 109.87 E 5.00
14-021492-00	D	B 107.05 C 198.00 D 109.87 E 5.00
14-021493-00	D	B 107.17 C 198.00 D 109.87 E 5.00
14-021494-00	D	B 107.47 C 198.00 D 109.87 E 5.00
14-024781-00	D	B 107.02 C 198.00 D 109.95 E 5.00

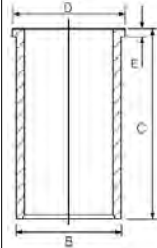

104.00

31

8040.05.4990	4cyl.	3908cc	80kW (109PS)	Diesel	Turbo	TD16725
8040.25B.4200	4cyl.	3908cc	75kW (102PS)	Diesel	Turbo	TD10403
8040.25X.4000	4cyl.	3908cc	85kW (116PS)	Diesel	Turbo	TD10404
8060.25V.4000 (Euro 1)	6cyl.	5861cc	130kW (177PS)	Diesel	Turbo Intercooled	TD10454
8060.25V.4080	6cyl.	5861cc	130kW (177PS)	Diesel	Turbo Intercooled	TD10476
8060.25V.4800	6cyl.	5861cc	130kW (177PS)	Diesel	Turbo Intercooled	TD10481
8060.25R.4200 (Euro 1)	6cyl.	5861cc	105kW (143PS)	Diesel	Turbo	TD10479
8060.25R.4280	6cyl.	5861cc	105kW (143PS)	Diesel	Turbo	TD10475
8060.25R.4300	6cyl.	5861cc	105kW (143PS)	Diesel	Turbo Intercooled	TD20414

EUROCARGO I-III 01/91→09/15

87-103900-40 STD

- A 65.25
- B- 21.00
- BØ 46.00
- D 104.20
- F 38x85



AK HA RT TP

08-103900-00 STD

08-103908-00 0.60mm

- 3.50 MO P
- 2.50 P
- 4.00 CR P



14-010940-00 D

14-010941-10 D

B 107.00 C 198.00

B 107.10 C 198.00

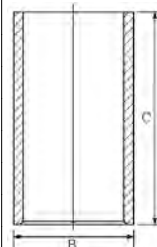

14-021361-00	D	B 107.02 C 198.00 D 110.87 E 5.00
14-021362-00	D	B 107.14 C 198.00 D 110.87 E 5.00
14-021363-00	D	B 107.44 C 198.00 D 110.87 E 5.00
14-021491-00	D	B 107.01 C 198.00 D 109.87 E 5.00
14-021492-00	D	B 107.05 C 198.00 D 109.87 E 5.00
14-021493-00	D	B 107.17 C 198.00 D 109.87 E 5.00
14-021494-00	D	B 107.47 C 198.00 D 109.87 E 5.00
14-024781-00	D	B 107.02 C 198.00 D 109.95 E 5.00

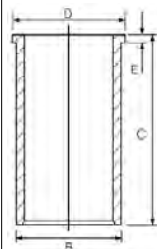



104.00						32
8040.25.000	4cyl.	3908cc	74-85kW (101-116PS)	Diesel	Turbo Intercooled	TD21461
8040.25.200	4cyl.	3908cc	85kW (116PS)	Diesel	Turbo	TD10407
8040.25.220	4cyl.	3908cc	85kW (116PS)	Diesel	Turbo	TD10416
8040.25.230	4cyl.	3908cc	74kW (101PS)	Diesel	Turbo	TD7271
8060.25.600	6cyl.	5861cc	130kW (177PS)	Diesel	Turbo	TD10473
8060.25.621	6cyl.	5861cc	110kW (150PS)	Diesel	Turbo	TD7243
8060.25.630	6cyl.	5861cc	100kW (135PS)	Diesel	Turbo	TD5604
8060.25.631	6cyl.	5861cc	100kW (135PS)	Diesel	Turbo	TD5943
8060.25.641	6cyl.	5861cc	103kW (140PS)	Diesel	Turbo	TD7242
8060.25.662	6cyl.	5861cc	96kW (130PS)	Diesel	Turbo	TD5599
8060.25.663	6cyl.	5861cc	88-96kW (118-131PS)	Diesel	Turbo	TD5936
8060.25.669	6cyl.	5861cc	125kW (170PS)	Diesel	Turbo	TD10459
8060.25.670	6cyl.	5861cc	125kW (170PS)	Diesel	Turbo	TD10453
8060.25.673	6cyl.	5861cc	96kW (130PS)	Diesel	Turbo	TD5938
8060.25.678	6cyl.	5861cc	130kW (177PS)	Diesel	Turbo	TD10466
8060.25.679	6cyl.	5861cc	130kW (177PS)	Diesel	Turbo	TD10467
8061.25	6cyl.	5868cc	114kW (155PS)	Diesel	Turbo	MP24133

INDUSTRIAL, TRUCK & BUS ZETA 01/87→03/91
M 01/86→12/92

<p>87-244500-10 STD</p> <p>A 65.15 B- 22.50 BØ 54.50 D 104.15 38x85</p> <p>AK RT TP</p>	<p>08-244500-00 STD</p> <p>3.00 CR P 2.50 P 4.00 CR P</p>	<p>14-010940-00 D B 107.00 C 198.00 14-010941-10 D B 107.10 C 198.00</p>	
--	---	---	--

		<p>14-021361-00 D B 107.02 C 198.00 D 110.87 E 5.00 14-021362-00 D B 107.14 C 198.00 D 110.87 E 5.00 14-021363-00 D B 107.44 C 198.00 D 110.87 E 5.00 14-021491-00 D B 107.01 C 198.00 D 109.87 E 5.00 14-021492-00 D B 107.05 C 198.00 D 109.87 E 5.00 14-021493-00 D B 107.17 C 198.00 D 109.87 E 5.00 14-021494-00 D B 107.47 C 198.00 D 109.87 E 5.00 14-024781-00 D B 107.02 C 198.00 D 109.95 E 5.00</p>	
--	--	---	--

104.00						33
8040.45.4000	4cyl.	3908cc	100kW (136PS)	Diesel	Turbo Intercooled	TD10405
8060.25R.4200	6cyl.	5861cc	105kW (143PS)	Diesel	Turbo Intercooled	TD7276
8060.25R.4200 LTC	6cyl.	5861cc	105kW (143PS)	Diesel	Turbo Intercooled	TD10415
8060.25R.4280	6cyl.	5861cc	105kW (143PS)	Diesel	Turbo Intercooled	TD7302
8060.45 (Euro 1)	6cyl.	5861cc	152kW (207PS)	Diesel	Turbo Intercooled	TD27439





8060.45.600	6cyl.	5861cc	152kW (207PS)	Diesel	Turbo Intercooled	TD7295
8060.45.4100 (Euro 1)	6cyl.	5861cc	152kW (207PS)	Diesel	Turbo Intercooled	TD10497
8060.45.4100 TCA (Euro 1)	6cyl.	5861cc	152kW (207PS)	Diesel	Turbo	TD10455
8060.45.4700	6cyl.	5861cc	152kW (207PS)	Diesel	Turbo	TD10913

EUROCARGO I-III 01/91→09/15

87-103900-00 <i>STD</i> A 65.33 B- 22.10 BØ 54.40 D 104.33 AK RT TP 	08-103900-00 <i>STD</i> 08-103908-00 <i>0.60mm</i> 3.50 MO P 2.50 P 4.00 CR P	14-010940-00 <i>D</i> 14-010941-10 <i>D</i> 	B 107.00 C 198.00 B 107.10 C 198.00
	14-021361-00 <i>D</i> 14-021362-00 <i>D</i> 14-021363-00 <i>D</i> 14-021491-00 <i>D</i> 14-021492-00 <i>D</i> 14-021493-00 <i>D</i> 14-021494-00 <i>D</i> 14-024781-00 <i>D</i>	B 107.02 C 198.00 D 110.87 E 5.00 B 107.14 C 198.00 D 110.87 E 5.00 B 107.44 C 198.00 D 110.87 E 5.00 B 107.01 C 198.00 D 109.87 E 5.00 B 107.05 C 198.00 D 109.87 E 5.00 B 107.17 C 198.00 D 109.87 E 5.00 B 107.47 C 198.00 D 109.87 E 5.00 B 107.02 C 198.00 D 109.95 E 5.00	

104.00 **34**

8040.45X.4180	4cyl.	3908cc	100kW (136PS)	Diesel	Turbo Intercooled	TD20441
8060.45R.5000 (Euro 2)	6cyl.	5861cc	105kW (143PS)	Diesel	Turbo	TD16717

EUROCARGO I-III 01/91→09/15

87-103900-30 <i>STD</i> A 65.33 B- 21.40 BØ 48.10 D 104.33 AK RT TP 	08-103900-00 <i>STD</i> 08-103908-00 <i>0.60mm</i> 3.50 MO P 2.50 P 4.00 CR P	14-010940-00 <i>D</i> 14-010941-10 <i>D</i> 	B 107.00 C 198.00 B 107.10 C 198.00



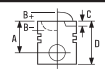

- 14-021361-00 *D* **B** 107.02 **C** 198.00 **D** 110.87 **E** 5.00
- 14-021362-00 *D* **B** 107.14 **C** 198.00 **D** 110.87 **E** 5.00
- 14-021363-00 *D* **B** 107.44 **C** 198.00 **D** 110.87 **E** 5.00
- 14-021491-00 *D* **B** 107.01 **C** 198.00 **D** 109.87 **E** 5.00
- 14-021492-00 *D* **B** 107.05 **C** 198.00 **D** 109.87 **E** 5.00
- 14-021493-00 *D* **B** 107.17 **C** 198.00 **D** 109.87 **E** 5.00
- 14-021494-00 *D* **B** 107.47 **C** 198.00 **D** 109.87 **E** 5.00
- 14-024781-00 *D* **B** 107.02 **C** 198.00 **D** 109.95 **E** 5.00

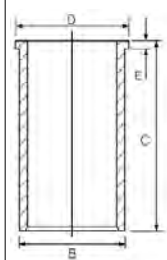

104.00							35
8060.45S.6800 (Euro 1)	6cyl.	5861cc	167kW (227PS)	Diesel	Turbo Intercooled		TD7305

- 14-010940-00 *D* **B** 107.00 **C** 198.00

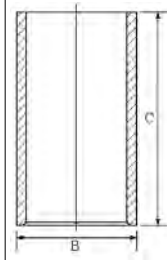

104.00							36
8065.25.080	6cyl.	5863cc	103-105kW (140-143PS)	Diesel			TD25475
90			01/84→12/93	F			01/90→12/96

87-244500-40 *STD*

- A** 65.15
- B-** 22.50
- BØ** 54.45
- D** 108.50
- 38x89



AK RT

08-244500-00 *STD*

- 3.00 CR P
- 2.50 P
- 4.00 CR P

- 14-010940-00 *D* **B** 107.00 **C** 198.00
- 14-010941-10 *D* **B** 107.10 **C** 198.00

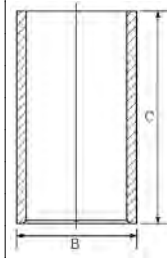



14-021361-00	D	B 107.02 C 198.00 D 110.87 E 5.00
14-021362-00	D	B 107.14 C 198.00 D 110.87 E 5.00
14-021363-00	D	B 107.44 C 198.00 D 110.87 E 5.00
14-021491-00	D	B 107.01 C 198.00 D 109.87 E 5.00
14-021492-00	D	B 107.05 C 198.00 D 109.87 E 5.00
14-021493-00	D	B 107.17 C 198.00 D 109.87 E 5.00
14-021494-00	D	B 107.47 C 198.00 D 109.87 E 5.00
14-024781-00	D	B 107.02 C 198.00 D 109.95 E 5.00

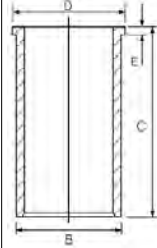

110.00				37
C70	4cyl.	4941cc	Diesel	MP4029-2
C100	4cyl.	4941cc	Diesel	MP4029-1
CN3	3cyl.	3706cc	Diesel	MP4028
CP 3	6cyl.	7412cc	107kW (145PS)	Diesel
CP 3/32.1.200	6cyl.	7412cc	107-110kW (145-150PS)	Diesel
INDUSTRIAL, TRUCK & BUS			Series 130	12/74 → 12/78

87-207500-10 STD

A	70.20
B-	28.00
BØ	55.00
D	140.20
	40x94



08-207500-00 STD

2.50		CR P
2.50		P
2.50		P
5.00		CR P

14-611250-00 WH
14-615230-00 WH

B 118.00	C 237.00	D 129.50	E 170.00	F 1.00
B 118.00	C 236.00	D 129.50	E 170.00	F 1.00

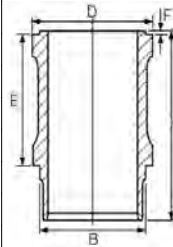

88-207500-10
87-207500-10 +
14-611250-00

87-207500-30 STD

A	70.20
B-	28.00
BØ	55.00
D	140.20
	40x94



08-207500-00 STD

2.50		CR P
2.50		P
2.50		P
5.00		CR P

14-611250-00 WH

B 118.00	C 237.00	D 129.50	E 170.00	F 1.00
-----------------	-----------------	-----------------	-----------------	---------------

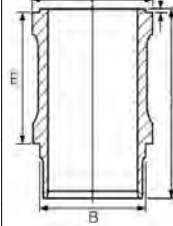



88-207500-30
87-207500-30 +
14-611250-00

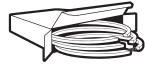

110.00				38
C 03	4cyl.	4940cc	55-67kW (75-91PS)	Diesel
C20	4cyl.	4562cc		Diesel
C21	4cyl.	4562cc		Diesel
C41	4cyl.	4562cc		Diesel
CO3	4cyl.	4562cc		Diesel
CO40	4cyl.	4562cc		Diesel
INDUSTRIAL, TRUCK & BUS			Series 70	01/76 → 08/78



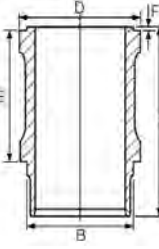

<p>87-207500-00 STD</p> <p>A 75.20 B- 27.50 BØ 51.00 D 150.20 40x94</p> 	<p>08-207500-00 STD</p> <p>2.50 CR P 2.50 P 2.50 P 5.00 CR P</p> 	<p>14-611250-00 WH 14-615230-00 WH</p> 	<p>B 118.00 C 237.00 D 129.50 E 170.00 F 1.00 B 118.00 C 236.00 D 129.50 E 170.00 F 1.00</p>	<p>88-207500-00 87-207500-00 + 14-611250-00</p>
--	---	--	--	--

112.00						39
8360.46	6cyl.	7685cc	196kW (267PS)	Diesel	Turbo	TD27452
8360.46B.4591	6cyl.	7684cc	162-196kW (220-267PS)	Diesel	Turbo Intercooled	TD24862
8360.46R.416 (TCA)	6cyl.	7685cc	176kW (239PS)	Diesel	Turbo Intercooled	TD10511
EUROFIRE		09/06 →		EUROTECH MT		01/92 → 08/98

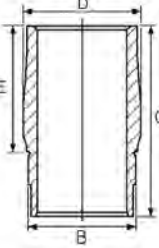
<p>87-142900-00 STD</p> <p>A 76.50 B- 25.00 BØ 52.00 D 126.50 42x93</p> <p>AK KK RT TP</p> 	<p>08-142900-00 STD</p> <p>3.50 CK P 2.50 CR P 4.00 CR P</p> 	<p>14-740060-00 WH</p> 	<p>B 120.50 C 232.00 D 128.90 E 87.00</p>	<p>88-142900-00 87-142900-00 + 14-740060-00</p>
---	---	--	--	--

Euro 1

115.00						40
8340.04.040	4cyl.	4570cc	73kW (99PS)	Diesel		TD10400
8340.04.200	4cyl.	4570cc	74kW (101PS)	Diesel		TD10392
8340.04.250	4cyl.	4570cc	74kW (101PS)	Diesel		TD10393
8340.04.300	4cyl.	4570cc	74kW (101PS)	Diesel		TD10394
8340.04.350	4cyl.	4570cc	74kW (101PS)	Diesel		TD10395
8340.04.362	4cyl.	4570cc	74kW (101PS)	Diesel		TD10396
8360.04	6cyl.	6855cc	106kW (145PS)	Diesel		MP3523
8361.04	6cyl.	6850cc	106kW (145PS)	Diesel		MP4951
INDUSTRIAL		ZETA				01/79 → 06/88
INDUSTRIAL, TRUCK & BUS						

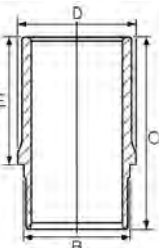
		<p>14-610020-00 WH</p> 	<p>B 122.00 C 215.00 D 129.70 E 147.00</p>	
--	--	---	---	--

- ☐ Liner with "anti-cavitation" galvanized exterior
- ☐ Laufbuchse mit "hohlraumfreiem" verzinktem Äußerem
- ☐ Chemise à extérieur galvanisé "anti-cavitation"
- ☐ Camisa con exterior galvanizado "anticavitación"
- ☐ Canna con esterno zincato "anticavitazione"

115.00						41
8340.05	4cyl.	5401cc	63kW (86PS)	Diesel		TD6849
8340.05.200	4cyl.	5401cc	84kW (114PS)	Diesel		TD10410





8360.05	6cyl.	8100cc	95-124kW (129-169PS)	Diesel	TD6854
8360.05.200	6cyl.	8102cc	124kW (169PS)	Diesel	TD10484
8360.05.254	6cyl.	8102cc	124kW (169PS)	Diesel	TD10488
8360.05.673	6cyl.	8102cc	118-121kW (160-165PS)	Diesel	TD10494
8360.05.B	6cyl.	8102cc	95-110kW (129-150PS)	Diesel	TD6856
8361.05	6cyl.	8102cc	118kW (160PS)	Diesel	MP4952-1
8365.05.500	6cyl.	8101cc	114kW (155PS)	Diesel	TD25353
8365.05.520	6cyl.	8101cc	104kW (141PS)	Diesel	TD25354
8365.05.530	6cyl.	8101cc	99kW (135PS)	Diesel	TD25355
8365.05.531	6cyl.	8101cc	104kW (141PS)	Diesel	TD25356
8365.05.555	6cyl.	8101cc	96kW (130PS)	Diesel	TD25357
8365.05.560	6cyl.	8101cc	94kW (128PS)	Diesel	TD25358
8365.05.570	6cyl.	8101cc	94kW (128PS)	Diesel	TD25359
8365.05.580	6cyl.	8101cc	94kW (128PS)	Diesel	TD25360
8365.05.590	6cyl.	8101cc	94kW (128PS)	Diesel	TD25361

1000	01/79→12/84	Series 120	01/79→12/86
INDUSTRIAL, TRUCK & BUS		Series 140	01/78→01/86
Series 80	01/78→12/84	ZETA	01/83→01/85



87-523000-00 STD

- A** 76.50
- B-** 29.40
- BØ** 54.00
- D** 140.50
-  42x97



RT

08-523000-00 STD

- 2.50  CR P
- 2.50  P
- 4.00  CR P

14-684840-00 WH

14-633860-00 WH

B 122.00 **C** 235.00 **D** 129.70 **E** 167.00
B 122.00 **C** 235.00 **D** 129.90 **E** 167.00

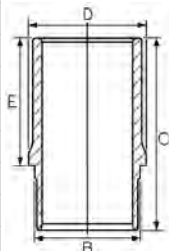

88-523000-00

87-523000-00 +
14-684840-00

115.00

42

8361.25.510	6cyl.	8101cc		Diesel	MP19113
8361.45.530	6cyl.	8101cc		Diesel Turbo Intercooled	MP9113-1
8361.45.530-836 L	6cyl.	8101cc		Diesel Turbo Intercooled	MP9113

AGRICULTURAL INDUSTRIAL STATIONARY ENGINES

87-245500-10 STD

- A** 76.50
- B-** 27.70
- BØ** 59.00
- D** 140.50
-  42x97



RT

08-245500-00 STD

- 3.00  CR P
- 2.50  P
- 4.00  CR P

14-684840-00 WH

14-633860-00 WH

B 122.00 **C** 235.00 **D** 129.70 **E** 167.00
B 122.00 **C** 235.00 **D** 129.90 **E** 167.00

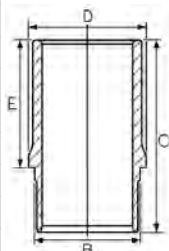

88-245500-10

87-245500-10 +
14-684840-00

115.00



43



8365.25.500	6cyl.	8102cc	132kW (180PS)	Diesel Turbo	TD18678
8365.25.501	6cyl.	8102cc	118kW (160PS)	Diesel Turbo	TD18679
8365.25.502	6cyl.	8102cc	118-133kW (160-181PS)	Diesel Turbo	TD18680
8365.25.503	6cyl.	8102cc	118kW (160PS)	Diesel Turbo	TD18681
8365.25.533	6cyl.	8102cc	133kW (181PS)	Diesel Turbo	TD18682



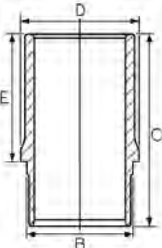

Series 90 01/93 →



<p>87-245500-00 STD</p> <p>A 76.50 B- 29.00 BØ 59.30 D 140.50 42x97</p> <p>RT</p> 	<p>08-245500-00 STD</p> <p>3.00 CR P 2.50 P 4.00 CR P</p> 	<p>14-684840-00 WH 14-633860-00 WH</p> <p>B 122.00 C 235.00 D 129.70 E 167.00 B 122.00 C 235.00 D 129.90 E 167.00</p> 	<p>88-245500-00 87-245500-00 + 14-684840-00</p>
--	--	---	--

<p>87-245500-30 STD</p> <p>A 76.50 B- 27.70 BØ 59.00 D 126.50 42x97</p> <p>RT</p> 	<p>08-245500-00 STD</p> <p>3.00 CR P 2.50 P 4.00 CR P</p> 		
--	--	--	--

115.00 **44**

F2BE0681A (Euro 2 Cursor 8)	6cyl.	7790cc	259kW (352PS)	Diesel	Turbo Intercooled	TD10828
F2BE0681B (Euro 2 Cursor 8)	6cyl.	7790cc	228kW (310PS)	Diesel	Turbo Intercooled	TD10829
F2BE0681C (Euro 2 Cursor 8)	6cyl.	7790cc	200kW (272PS)	Diesel	Turbo Intercooled	TD10832
F2BE0681D (Euro 2 Cursor 8)	6cyl.	7790cc	180kW (245PS)	Diesel	Turbo Intercooled	TD10833
F2BE0681DA (Euro 2 Cursor 8)	6cyl.	7790cc	180kW (245PS)	Diesel	Turbo Intercooled	TD28228
F2BE0681DB (Euro 2 Cursor 8)	6cyl.	7790cc	180kW (245PS)	Diesel	Turbo Intercooled	TD28229
F2BE0681E (Euro 2 Cursor 8)	6cyl.	7790cc	218kW (296PS)	Diesel	Turbo Intercooled	TD10830
F2BE0681F (Euro 2 Cursor 8)	6cyl.	7790cc	200kW (272PS)	Diesel	Turbo Intercooled	TD10831

CITYCLASS	01/97 →	STRALIS I	06/03 →
EUROTECH MH	09/98 →	TRAKKER I	10/04 →
EUROTRAKKER	09/99 → 11/04		

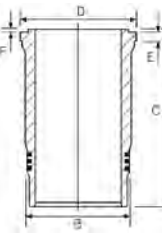
<p>87-121800-10 STD</p> <p>A 72.10 B- 21.50 BØ 60.00 D 117.10 46x96</p> <p>KK RT TP</p> 	<p>08-121800-00 STD</p> <p>3.00 CR P 2.50 CR P 4.00 CR P</p> 	<p>15-260070-00 WH <input type="checkbox"/> 14-260070-00 WH</p> <p>B 128.50 C 211.10 D 136.50 E 8.90 F 1.20 B 128.50 C 211.10 D 136.50 E 8.90 F 1.20</p> 	
--	---	--	--

Includes seals Schließt Dichtungen ein Inclut des joints Incluye los sellos Comprende le guarnizioni

115.00 **45**

F2BE1682G (Euro 3)	6cyl.	7790cc	228-259kW (310-352PS)	Diesel	Turbo Intercooled	TD20019
F2BE0681A/B/C/D/F (Euro 3)	6cyl.	7790cc	180-259kW (245-352PS)		Turbo Intercooled	MP15537

AXER	03/05 → 01/07	EURO CARGO I-III	06/07 → 09/15
C-Series	09/01 →		





87-121800-00 STD

- A 72.10
- B- 19.30
- BØ 59.30
- D 117.10
- 46x96

(11570-101)

AK HA KK RT TP



08-121800-00 STD

- 3.00 CR P
- 2.50 CR P
- 4.00 CR P

Schließt Dichtungen ein

15-260070-00 WH
14-260070-00 WH

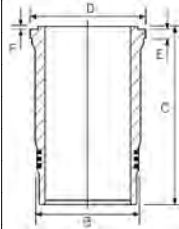

Inclut des joints

B 128.50 C 211.10 D 136.50 E 8.90 F 1.20
B 128.50 C 211.10 D 136.50 E 8.90 F 1.20

Incluye los sellos

Comprende le guarnizioni

89-121800-00
87-121800-00 +
15-260070-00

88-121800-00
87-121800-00 +
14-260070-00

117.00

46

F2CE0681A (Cursor 9)	6cyl.	8708cc	294kW (400PS)	Diesel	Turbo Intercooled	TD25715
F2CE0682A (Cursor 9)	6cyl.	8708cc	294kW (400PS)	Diesel	Turbo Intercooled	TD25716
F2CE0683A (Cursor 9)	6cyl.	8708cc	294kW (400PS)	Diesel	Turbo Intercooled	TD25717
F2CE0684A (Cursor 9)	6cyl.	8708cc	294kW (400PS)	Diesel	Turbo Intercooled	TD25718

87-428800-00 STD

- A 80.00
- B- 20.70
- BØ 65.60
- D 125.50
- 52x93

(11701A423)

AK KK RT TP



08-428800-00 STD

- 3.00 GDC P
- 2.50 NT
- 4.00 CR P



120.00

47

8460.21.002	6cyl.	9500cc	177kW (241PS)	Diesel	Turbo	TD10502
8460.21.002	6cyl.	9498cc	154-192kW (209-261PS)	Diesel	Turbo Intercooled	TD24863
8460.21.010	6cyl.	9500cc	177kW (241PS)	Diesel	Turbo	TD10503
8460.21.042	6cyl.	9500cc	177kW (240PS)	Diesel	Turbo	MP4130
8460.21.102	6cyl.	9500cc	191-192kW (260-261PS)	Diesel	Turbo	TD10521
8460.21.106	6cyl.	9500cc	177kW (240PS)	Diesel	Turbo	MP4130-1
8460.21.202	6cyl.	9498cc	177kW (241PS)	Diesel	Turbo	TD10518
8460.21.206	6cyl.	9498cc	177kW (241PS)	Diesel	Turbo	TD10519
8460.21.601	6cyl.	9498cc	191kW (260PS)	Diesel	Turbo	TD20435
8460.21.611	6cyl.	9498cc	154kW (209PS)	Diesel	Turbo	TD20436
8460.21.708	6cyl.	9500cc	177kW (240PS)	Diesel	Turbo	MP4130-2
8460.21.710	6cyl.	9500cc	177kW (240PS)	Diesel	Turbo	MP4130-3
8460.41.102	6cyl.	9500cc	234kW (318PS)	Diesel	Turbo Intercooled	TD10548
8460.41.124	6cyl.	9500cc	234kW (318PS)	Diesel	Turbo Intercooled	TD10599
8460.41.160	6cyl.	9500cc	236kW (321PS)	Diesel	Turbo Intercooled	TD10547
8460.41 M	6cyl.	9500cc	278kW (378PS)	Diesel	Turbo Intercooled	TD7250
8460.41S.733 (Euro 1)	6cyl.	9498cc	254kW (345PS)	Diesel	Turbo Intercooled	TD24865
8460.41 T	6cyl.	9500cc	185kW (251PS)	Diesel		TD24262

EUROTRAKKER	05/99→11/04	TURBOCITY	01/89→12/92
INDUSTRIAL, TRUCK & BUS		TURBOTECH	01/90→12/92
M	09/86→11/92		





14-450880-00 WH B 134.00 C 250.00 D 144.80 E 10.02 F 1.00

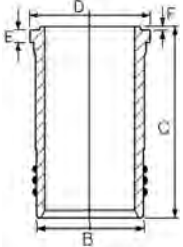

Nitrided Nitriert Nitruré Nitrurado Nitrurato

120.00 **48**

8460.21B.613	6cyl.	9500cc	162kW (220PS)	Diesel	MP19114
8460.21B.615	6cyl.	9500cc	162kW (220PS)	Diesel	MP19114-1
8460.41C	6cyl.	9500cc	221kW (301PS)	Diesel Turbo	TD10807
8460.41C (TCA)	6cyl.	9500cc	221kW (301PS)	Diesel Turbo Intercooled	TD10595
8460.41C.320	6cyl.	9500cc	221kW (301PS)	Diesel Turbo	TD10512
8460.41K (Euro 2)	6cyl.	9500cc	254kW (345PS)	Diesel Turbo	TD10808
8460.41K.406	6cyl.	9500cc	254kW (345PS)	Diesel Turbo	TD10513
8460.41K.410	6cyl.	9500cc	254kW (345PS)	Diesel Turbo	TD10709
8460.41K. TCA (Euro 1)	6cyl.	9500cc	254kW (345PS)	Diesel Turbo Intercooled	TD7342
8460.41L (TCA)	6cyl.	9500cc	276kW (375PS)	Diesel Turbo	TD10573
8460.41L.5020	6cyl.	9500cc	276kW (375PS)	Diesel Turbo	TD10514
8460.41 R	6cyl.	9500cc	214-276kW (290-375PS)	Diesel Turbo Intercooled	TD7248
8460.41 S	6cyl.	9500cc	254kW (345PS)	Diesel	TD7249
EUROSTAR		01/93→02/02	HD 7		01/96→
EUROTECH MP		01/92→	INDUSTRIAL, TRUCK & BUS		
EUROTECH MT		01/92→08/98	TURBOTECH		01/90→12/92
EUROTRAKKER		01/93→11/04			

87-785300-10 STD

- A 84.70
- B- 27.00
- BØ 59.50
- D 134.70
- 48x96



AK HA KK NB RT

08-785300-00 STD

- 3.50 CR P
- 3.00 CR P
- 5.00 CR P

14-450880-00 WH B 134.00 C 250.00 D 144.80 E 10.02 F 1.00

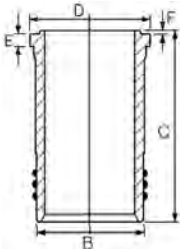

88-785300-10
87-785300-10 +
14-450880-00

Nitrided Nitriert Nitruré Nitrurado Nitrurato

122.00 **49**

8200.02	6cyl.	9820cc		Diesel	MP9108
8200.02.220	6cyl.	9820cc	147kW (200PS)	Diesel	TD6935
8200.12	6cyl.	9820cc		Diesel	MP9109
8200.12.000	6cyl.	9820cc	140kW (190PS)	Diesel	TD6906
8205.02	6cyl.	9820cc		Diesel	MP3500
INDUSTRIAL				Series 400	
INDUSTRIAL, TRUCK & BUS				Series 600	01/70→12/80
Series 300			01/58→12/71		





87-207700-00 STD

A 80.20
B- 28.00
BØ 66.50
D 150.00
 42x104
RT

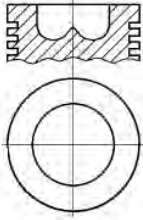

 Nitrided

08-207700-00 STD

3.50
 3.00
 3.00
 5.50

 CR P
 P
 P
 CR P

 Nitridé

14-020200-00 D 

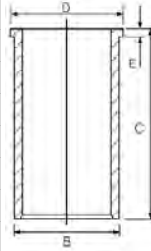

 Niturado

B 128.00 **C** 252.00 **D** 132.00 **E** 6.00

 Niturato

 **125.00**

50

8200.03	6cyl.	10308cc	Diesel	MP595-1
8200.13	6cyl.	10308cc	Diesel	MP9110
8205.03	6cyl.	10308cc	Diesel	MP595

INDUSTRIAL

INDUSTRIAL, TRUCK & BUS

14-021580-00 DH 

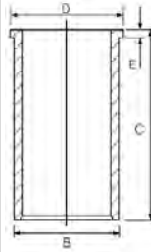

 Niturado

B 130.02 **C** 252.00 **D** 136.00 **E** 6.00

 Niturato

 **125.00**

51

F3A3681A (Euro 4/5 Cursor 10)	6cyl.	10300cc	330-331kW (449-450PS)	Diesel	Turbo Intercooled	TD20468
F3A3681B (Euro 4/5 Cursor 10)	6cyl.	10300cc	310kW (422PS)	Diesel	Turbo Intercooled	TD20467
F3A3681Y (Euro 4/5 Cursor 10)	6cyl.	10300cc	330-338kW (449-460PS)	Diesel	Turbo Intercooled	TD20469
F3AE3681D (Euro 4/5 Cursor 10)	6cyl.	10300cc	310kW (422PS)	Diesel	Turbo Intercooled	TD24603



Cargo	09/12→	STRALIS I	01/06→
EURORIDER	05/07→	STRALIS II	09/12→

87-434100-00 STD 

A 85.50
B- 21.20
BØ 67.20
D 133.50
 50x101

AK KK NB RT TP





 Volumen der Kolbenmulde 76.90cm³
 Schließt Dichtungen ein

08-434100-00 STD



2.50
 3.00
 4.00

 CK P
 NT P
 CR P

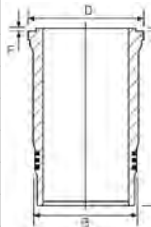

 Volume de la cavité du piston 76.90cm³
 Inclut des joints

15-260040-00 WH 



 Vol. cavidad pistón 76.90cm³
 Incluye los sellos

B 141.00 **C** 239.00 **D** 150.60 **E** 9.96 **F** 1.20

 Volume camera pistone 76.90cm³
 Comprende le garnizioni

89-434100-00
 87-434100-00 +
 15-260040-00

 **125.00**

52

F3AE0681B (Euro 3 Cursor 10)	6cyl.	10300cc	294kW (400PS)	Diesel	Turbo Intercooled	TD16551
F3AE0681D (Euro 2 Cursor 10)	6cyl.	10300cc	316kW (430PS)	Diesel	Turbo Intercooled	TD14970
F3AE0681E (Euro 2 Cursor 10)	6cyl.	10300cc	287kW (390PS)	Diesel	Turbo Intercooled	TD14968
F3AE0681H (Euro 3)	6cyl.	10300cc	294kW (400PS)	Diesel	Turbo Intercooled	TD24541

DOMINO	10/03→12/08	EUROTECH MP	11/99→
EURORIDER	01/01→12/13	POWERSTAR	01/06→12/08
EUROSTAR	01/93→10/02	STRALIS I	02/02→



87-121900-00 STD

- A 85.50
- B- 21.20
- BØ 88.00
- D 133.50
-  50x101



AK KK RT TP

08-121900-00 STD

- 3.50  CK P
- 3.00  CR P
- 4.00 

15-260040-00 WH ¹

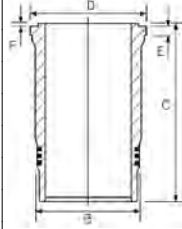

B 141.00 C 239.00 D 150.60 E 9.96 F 1.20

89-121900-30 ¹

87-121900-00 +
15-260040-00

¹ Includes seals

¹ Schließt Dichtungen ein

¹ Inclut des joints

¹ Incluye los sellos

¹ Comprende le guarnizioni

125.00

53

F6L 413 F	V6cyl.	9570cc	141kW (192PS)	Diesel	TD10483
F8L 413 F	V8cyl.	12763cc	162-212kW (220-288PS)	Diesel	TD10522
F10L 413 F	V10cyl.	15953cc	235kW (320PS)	Diesel Turbo	TD10527

P/PA	01/83→06/86	P/PA-Haubenfahrzeuge	07/83→09/90
------	-------------	----------------------	-------------

87-740300-00 STD

- A 87.40
- B- 47.65
- BØ 48.00
- B+ 5.25
- C 1.00
- C 1.20
- D 138.65
-  45x102



(12544)

HA RT

08-740300-10 STD

08-740307-10 0.50mm

- 3.00  CK P
- 2.50  P
- 4.00  CR P

14-900050-00 DH ¹

14-900030-00 DH ²

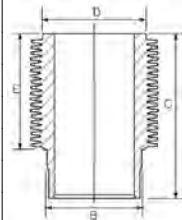

B 139.00 C 250.76 D 150.00 E 169.50

B 139.00 C 250.80 D 154.00 E 169.50

88-740300-00

87-740300-00 +
14-900050-00

88-740300-10

87-740300-00 +
14-900030-00

¹ Phosphated
² Hone-Lapped

¹ Phosphatiert
² Hongeläppt

¹ Phosphaté
² Rodée à la pierre

¹ Fosfatado
² Lapeado buñido

¹ Fosfatato
² Parzialmente rodati

130.00

54

203 A/61	6cyl.	11548cc	130kW (177PS)	Diesel	TD7375
203 H 61	6cyl.	11548cc	132kW (180PS)	Diesel	TD7348
310 H/61	6cyl.	11548cc		Diesel	MP3512

INDUSTRIAL, TRUCK & BUS

14-018002-00 D

B 136.10 C 282.00

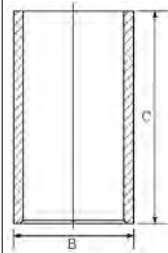

135.00

55

F3BE0681A (Euro 3 Cursor 13)	6cyl.	12880cc	397-412kW (540-560PS)	Diesel Turbo Intercooled	TD16505
F3BE0681B (Euro 3 Cursor 13)	6cyl.	12880cc	368kW (500PS)	Diesel Turbo Intercooled	TD16550
F3BE0681C (Euro 3 Cursor 13)	6cyl.	12880cc	324kW (440PS)	Diesel Turbo Intercooled	TD16507
F3BE0681D (Euro 3 Cursor 13)	6cyl.	12882cc	330kW (450PS)	Diesel Turbo Intercooled	TD20620
F3BE0681E (Euro 3 Cursor 13)	6cyl.	12880cc	353kW (480PS)	Diesel Turbo Intercooled	TD16506
F3BE0681F (Euro 3 Cursor 13)	6cyl.	12882cc	367kW (500PS)	Diesel Turbo Intercooled	TD20622





F3BE0681G (Euro 3 Cursor 13)	6cyl.	12880cc	280kW (380PS)	Diesel	Turbo Intercooled	TD16591
EUROCARGO I-III			01/08→12/10	HD 9		12/11→
EUROSTAR			01/93→02/02	POWERSTAR		01/06→12/08
EUROTRAKKER			01/00→11/04	STRALIS I		02/02→
HD 7-C			01/00→	TRAKKER I		09/04→
HD 8			01/05→			

87-122000-00 STD

- A 90.40
- B- 23.10
- BØ 94.00
- D 142.40
-  54x107

AK KK RT TP



08-122000-00 STD

- 4.00  CK P
- 3.00  CR P
- 5.00  CR P

15-260050-10 WH ①

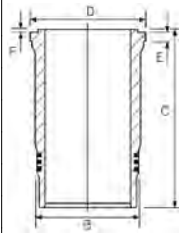

B 153.50 C 254.20 D 161.60 E 9.96 F 1.20

89-122000-30 ①

87-122000-00 +
15-260050-10

① Includes seals

① Schließt Dichtungen ein

① Inclut des joints

① Incluye los sellos

① Comprende le guarnizioni

 **135.00**

56

F3BE3681A (Euro 4/5 Cursor 13)	6cyl.	12882cc	412kW (560PS)	Diesel	Turbo Intercooled	TD20645
F3BE3681B (Euro 4/5 Cursor 13)	6cyl.	12880cc	368kW (500PS)	Diesel	Turbo Intercooled	TD21089
F3BE3681C (Euro 4/5 Cursor 13)	6cyl.	12880cc	332kW (450PS)	Diesel	Turbo Intercooled	TD21057
F3BE3681D (Euro 4/5 Cursor 13)	6cyl.	12882cc	302kW (411PS)	Diesel	Turbo Intercooled	TD20632
F3BE3681E (Euro 4/5 Cursor 13)	6cyl.	12882cc	382kW (520PS)	Diesel	Turbo Intercooled	TD20644
F3BE3681F (Euro 4/5 Cursor 13)	6cyl.	12882cc	353kW (480PS)	Diesel	Turbo Intercooled	TD20641
F3BE3681G (Euro 4/5 Cursor 13)	6cyl.	12882cc	324kW (440PS)	Diesel	Turbo Intercooled	TD20633
HD 8			01/05→	STRALIS II		09/12→
HD 9			12/11→	TRAKKER I		10/04→
PRIMA			01/10→12/15	TRAKKER II		09/12→
STRALIS I			08/05→			

87-428000-00 STD ①

- A 90.40
- B- 23.10
- BØ 94.00
- D 142.40
-  54x107

(13501B112)

AK KK NB RT TP



08-428000-00 STD

- 3.00  CK P
- 3.00  CR P
- 5.00  CR P

15-260050-10 WH ②

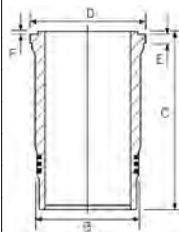

B 153.50 C 254.20 D 161.60 E 9.96 F 1.20

89-428000-00 ②

87-428000-00 +
15-260050-10

① Bowl capacity 99.70cm³

② Includes seals

① Volumen der Kolbenmulde 99.70cm³

② Schließt Dichtungen ein

① Volume de la cavité du piston 99.70cm³

② Inclut des joints

① Vol. cavidad pistón 99.70cm³

② Incluye los sellos

① Volume camera pistone 99.70cm³

② Comprende le guarnizioni

 **137.00**

57

8210.02	6cyl.	13800cc	191kW (260PS)	Diesel		TD10598
8210.02.000	6cyl.	13798cc	191kW (260PS)	Diesel		TD6868
8210.02.020	6cyl.	13798cc	191kW (260PS)	Diesel		TD6864
8210.02.022	6cyl.	13798cc	191kW (260PS)	Diesel		TD6877
8210.02.032	6cyl.	13798cc	191kW (260PS)	Diesel		TD6923
8210.02.053	6cyl.	13798cc	191kW (260PS)	Diesel		TD6266
8210.02.067	6cyl.	13798cc	191kW (260PS)	Diesel		TD10523
8210.02.069	6cyl.	13798cc	191kW (260PS)	Diesel		TD10525
8210.02.081	6cyl.	13798cc	191kW (260PS)	Diesel		TD6865
8210.02.266	6cyl.	13798cc	191kW (260PS)	Diesel		TD5635
8210.02.267	6cyl.	13798cc	191kW (260PS)	Diesel		TD5976
8210.02.371	6cyl.	13798cc	191kW (260PS)	Diesel		TD10507





8210.02.373	6cyl.	13798cc	191kW (260PS)	Diesel	TD10508
8210.02.377	6cyl.	13798cc	191kW (260PS)	Diesel	TD10509
8210.02.385	6cyl.	13798cc	191kW (260PS)	Diesel	TD6899
8210.02.393	6cyl.	13798cc	191kW (260PS)	Diesel	TD10510
8210.02.405	6cyl.	13798cc	191kW (260PS)	Diesel	TD7254
8210.02.426	6cyl.	13798cc	191kW (260PS)	Diesel	TD7359
8210.02.440	6cyl.	13798cc	191kW (260PS)	Diesel	TD10491
8210.02.441	6cyl.	13798cc	191kW (260PS)	Diesel	TD10492
8210.02.731	6cyl.	13798cc	191kW (260PS)	Diesel	TD10524
8211.02	6cyl.	13798cc		Diesel	MP10601
8211.02.032	6cyl.	13798cc	191kW (260PS)	Diesel	TD6376
8215.02	6cyl.	13798cc		Diesel	MP3514

INDUSTRIAL	Series 300	01/58→12/71
INDUSTRIAL, TRUCK & BUS	Series 600	01/70→12/80

87-207800-00 STD

- A 92.00
- B- 32.40
- BØ 67.00
- D 167.00
- 48x117



RT

08-207800-30 STD

- 4.00 CR P
- 3.00 P
- 3.00 P
- 5.50 CR P

- 14-021230-00 DH B 143.02 C 282.00 D 147.00 E 6.00
- 14-021232-00 DH B 143.27 C 282.00 D 147.00 E 6.00
- 14-021560-10 DH B 143.00 C 282.00 D 147.00 E 6.06
- 14-021561-10 DH B 143.05 C 282.00 D 147.00 E 6.06
- 14-021562-10 DH B 143.25 C 282.00 D 147.00 E 6.06
- 14-021563-10 DH B 143.50 C 282.00 D 147.00 E 6.06
- 14-021590-00 DH B 143.04 C 282.00 D 149.00 E 6.04

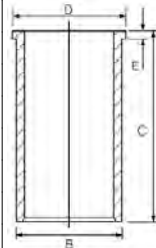

Nitrided

Nitriert

Nitrué

Nitruado

Nitrurato

137.00

58

8210.22	6cyl.	13798cc	221-224kW (300-305PS)	Diesel	Turbo	MP4024
8210.22.000	6cyl.	13798cc	224kW (305PS)	Diesel	Turbo	TD22223
8210.22.069	6cyl.	13798cc	221-224kW (300-305PS)	Diesel		TD6885
8210.22.101	6cyl.	13798cc	224kW (305PS)	Diesel	Turbo	TD6881
8210.22.175	6cyl.	13798cc	224kW (305PS)	Diesel	Turbo	TD10528
8210.22.183	6cyl.	13798cc	224kW (305PS)	Diesel	Turbo	TD10579
8210.22.235	6cyl.	13798cc	224kW (304PS)	Diesel	Turbo	TD7352
8210.22.269	6cyl.	13798cc	224kW (305PS)	Diesel	Turbo	TD10584
8210.22.317	6cyl.	13798cc	224kW (305PS)	Diesel	Turbo	TD10531
8210.22.373	6cyl.	13798cc	224kW (305PS)	Diesel	Turbo	TD6878
8210.22.385	6cyl.	13798cc	224kW (305PS)	Diesel	Turbo	TD10586
8210.22.406	6cyl.	13798cc	224kW (304PS)	Diesel	Turbo	TD7255
8210.22.523	6cyl.	13798cc	224kW (305PS)	Diesel	Turbo	TD11391
8210.22X.235	6cyl.	13798cc	224kW (305PS)	Diesel	Turbo	TD11407
8211.22	6cyl.	13798cc		Diesel	Turbo	MP24024

INDUSTRIAL	P/PA-Haubenfahrzeuge	04/87→12/93
P/PA	Series 300	01/58→12/71





87-207800-10 STD



- A** 92.00
- B-** 33.00
- BØ** 72.00
- D** 162.00
-  50x117



AK KK RT

08-207800-10 STD

- 4.00  CR P
- 3.00  P
- 5.50  CR P

- 14-021230-00** DH  **B** 143.02 **C** 282.00 **D** 147.00 **E** 6.00
- 14-021232-00** DH  **B** 143.27 **C** 282.00 **D** 147.00 **E** 6.00
- 14-021560-10** DH **B** 143.00 **C** 282.00 **D** 147.00 **E** 6.06
- 14-021561-10** DH **B** 143.05 **C** 282.00 **D** 147.00 **E** 6.06
- 14-021562-10** DH **B** 143.25 **C** 282.00 **D** 147.00 **E** 6.06
- 14-021563-10** DH **B** 143.50 **C** 282.00 **D** 147.00 **E** 6.06
- 14-021590-00** DH  **B** 143.04 **C** 282.00 **D** 149.00 **E** 6.04

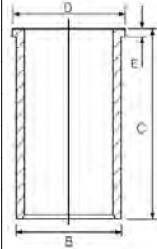

 Nitrided

 Nitriert

 Nituré

 Niturado

 Niturato

 **137.00**

59

8210.22.105	6cyl.	13798cc	243kW (330PS)	Diesel	Turbo Intercooled	TD10550
8210.22.171	6cyl.	13798cc	224kW (305PS)	Diesel	Turbo	TD10530
8210.22.210	6cyl.	13798cc	224kW (305PS)	Diesel	Turbo	TD11387
8210.22.236	6cyl.	13798cc	224kW (305PS)	Diesel	Turbo	TD11388
8210.22.327	6cyl.	13798cc	224kW (305PS)	Diesel	Turbo	TD10585
8210.22.511	6cyl.	13798cc	224kW (305PS)	Diesel	Turbo	TD11389
8210.22.521	6cyl.	13798cc	224kW (305PS)	Diesel	Turbo	TD11390
8210.22.525	6cyl.	13798cc	224kW (305PS)	Diesel	Turbo	TD11392
8210.22.535	6cyl.	13798cc	224kW (305PS)	Diesel	Turbo	TD11393
8210.22.537	6cyl.	13798cc	224kW (305PS)	Diesel	Turbo	TD11394
8210.22.569	6cyl.	13798cc	224kW (305PS)	Diesel	Turbo	TD10529
8210.22.800	6cyl.	13798cc		Diesel		MP5053
8210.22.869	6cyl.	13798cc	235kW (320PS)	Diesel	Turbo	TD10549
8210.22X.069	6cyl.	13798cc	224kW (305PS)	Diesel	Turbo	TD11329
8210.22X.523	6cyl.	13798cc	224kW (305PS)	Diesel	Turbo	TD11408
8210.22X.575	6cyl.	13798cc	224kW (305PS)	Diesel	Turbo	TD11330
8210.42.172	6cyl.	13798cc	277kW (377PS)	Diesel	Turbo Intercooled	TD10581
8210.42.500 (Euro 2)	6cyl.	13798cc	346kW (471PS)	Diesel	Turbo Intercooled	TD18332
8210.42K (TCA) (Euro 1)	6cyl.	13798cc	272kW (370PS)	Diesel	Turbo Intercooled	TD7377
8210.42M (TCA) (Euro 2)	6cyl.	13798cc	345kW (469PS)	Diesel	Turbo Intercooled	TD10576
8212.00	6cyl.	13800cc		Diesel		MP8846
8215.00	6cyl.	13800cc		Diesel		MP18846
8215.22.520	6cyl.	13798cc		Diesel	Turbo	MP9116
8217.00	6cyl.	13798cc		Diesel		MP28846
8217.32	6cyl.	13798cc		Diesel	Turbo	MP9116-1
8260.01	6cyl.	12800cc		Diesel		MP8847
EUROSTAR			01/93→02/02	P/PA		06/84→12/92
EUROTRAKKER			01/93→11/04	P/PA-Haubenfahrzeuge		10/87→12/92
INDUSTRIAL				TURBOTECH		01/90→12/92
INDUSTRIAL, TRUCK & BUS						



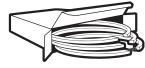

- 14-021230-00 DH B 143.02 C 282.00 D 147.00 E 6.00
- 14-021232-00 DH B 143.27 C 282.00 D 147.00 E 6.00
- 14-021560-10 DH B 143.00 C 282.00 D 147.00 E 6.06
- 14-021561-10 DH B 143.05 C 282.00 D 147.00 E 6.06
- 14-021562-10 DH B 143.25 C 282.00 D 147.00 E 6.06
- 14-021563-10 DH B 143.50 C 282.00 D 147.00 E 6.06
- 14-021590-00 DH B 143.04 C 282.00 D 149.00 E 6.04

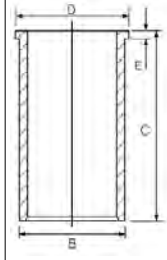

Nitrided Nitriert Nitruré Nitrurado Nitrurato

137.00 **60**

8210.42	6cyl.	13798cc	277kW (377PS)	Diesel	Turbo Intercooled	TD10564
8210.42.009	6cyl.	13798cc	265kW (360PS)	Diesel	Turbo Intercooled	TD7356
8210.42.101	6cyl.	13798cc	265kW (360PS)	Diesel	Turbo Intercooled	TD10563
8210.42.115	6cyl.	13798cc	265kW (360PS)	Diesel	Turbo Intercooled	TD10582
8210.42.151	6cyl.	13798cc	277kW (377PS)	Diesel	Turbo Intercooled	TD10552
8210.42.152	6cyl.	13798cc	277kW (377PS)	Diesel	Turbo Intercooled	TD10555
8210.42.154	6cyl.	13798cc	277kW (377PS)	Diesel	Turbo Intercooled	TD10556
8210.42.155	6cyl.	13798cc	277kW (377PS)	Diesel	Turbo Intercooled	TD10580
8210.42.161	6cyl.	13798cc	277kW (377PS)	Diesel	Turbo Intercooled	TD10553
8210.42.162	6cyl.	13798cc	277kW (377PS)	Diesel	Turbo Intercooled	TD10557
8210.42.165	6cyl.	13798cc	277kW (377PS)	Diesel	Turbo Intercooled	TD10588
8210.42.171	6cyl.	13798cc	277kW (377PS)	Diesel	Turbo Intercooled	TD10554
8210.42.175	6cyl.	13798cc	277kW (377PS)	Diesel	Turbo Intercooled	TD10590
8210.42.181	6cyl.	13798cc	277kW (377PS)	Diesel	Turbo Intercooled	TD10558
8210.42.182	6cyl.	13798cc	277kW (377PS)	Diesel	Turbo Intercooled	TD10559
8210.42.185	6cyl.	13798cc	277kW (377PS)	Diesel	Turbo Intercooled	TD10591
8210.42.186	6cyl.	13798cc	277kW (377PS)	Diesel	Turbo Intercooled	TD10592
8210.42.191	6cyl.	13798cc	277kW (377PS)	Diesel	Turbo Intercooled	TD10560
8210.42.195	6cyl.	13798cc	277kW (377PS)	Diesel	Turbo Intercooled	TD10593

TURBOSTAR 07/87→12/93 TURBOTECH 01/90→12/92

87-783000-00 STD

- A 92.00
- B- 33.00
- BØ 72.00
- D 157.00
- 50x117



AK KK RT TP

08-783000-00 STD

- 4.00 CR P
- 3.00 CR P
- 5.50 CR P

- 14-021230-00 DH B 143.02 C 282.00 D 147.00 E 6.00
- 14-021232-00 DH B 143.27 C 282.00 D 147.00 E 6.00
- 14-021560-10 DH B 143.00 C 282.00 D 147.00 E 6.06
- 14-021561-10 DH B 143.05 C 282.00 D 147.00 E 6.06
- 14-021562-10 DH B 143.25 C 282.00 D 147.00 E 6.06
- 14-021563-10 DH B 143.50 C 282.00 D 147.00 E 6.06
- 14-021590-00 DH B 143.04 C 282.00 D 149.00 E 6.04

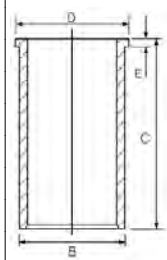

Nitrided Nitriert Nitruré Nitrurado Nitrurato



137.00 **61**

8210.42 K	6cyl.	13798cc	272kW (370PS)	Diesel		TD7358
8210.42K (Euro 2)	6cyl.	13798cc	272kW (370PS)	Diesel	Turbo Intercooled	TD10809
8210.42L.(TCA) (Euro 1)	6cyl.	13798cc	309kW (420PS)	Diesel	Turbo Intercooled	TD7366
8210.42L.400 (Euro 1)	6cyl.	13798cc	309kW (420PS)	Diesel	Turbo	TD10515
EURO CARGO I-III			03/95→08/01	EUROTRAKKER		01/93→11/04
EUROSTAR			01/93→02/02	HD 7		01/96→
EUROTECH MH			01/98→01/03	HD 8		01/05→
EUROTECH MP			01/92→	POWERSTAR		01/99→

87-783000-10 STD

- A** 92.00
- B-** 21.00
- BØ** 83.80
- D** 157.00
- 50x115



AK HA KK RT TP

08-783000-00 STD

- 4.00 CR P
- 3.00 CR P
- 5.50 CR P

- 14-021230-00** DH
- 14-021232-00** DH
- 14-021560-10** DH
- 14-021561-10** DH
- 14-021562-10** DH
- 14-021563-10** DH
- 14-021590-00** DH

- B** 143.02 **C** 282.00 **D** 147.00 **E** 6.00
- B** 143.27 **C** 282.00 **D** 147.00 **E** 6.00
- B** 143.00 **C** 282.00 **D** 147.00 **E** 6.06
- B** 143.05 **C** 282.00 **D** 147.00 **E** 6.06
- B** 143.25 **C** 282.00 **D** 147.00 **E** 6.06
- B** 143.50 **C** 282.00 **D** 147.00 **E** 6.06
- B** 143.04 **C** 282.00 **D** 149.00 **E** 6.04

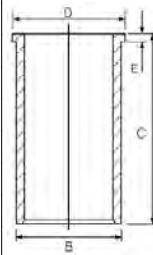

87-783000-15 STD

- A** 91.80
- B-** 21.00
- BØ** 83.80
- D** 156.80
- 50x115



AK HA KK RT TP

08-783000-00 STD

- 4.00 CR P
- 3.00 CR P
- 5.50 CR P

87-783000-30 STD

- A** 92.00
- B-** 25.50
- BØ** 72.00
- D** 157.00
- 50x115



AK KK NB RT TP

08-783000-00 STD

- 4.00 CR P
- 3.00 CR P
- 5.50 CR P

Euro 2 Nitridé Nitriert Nitrué Nitruado Nitruato

137.00 **62**

8210.42L (Euro 2)	6cyl.	13798cc	309kW (420PS)	Diesel	Turbo	TD10812
8210.42L (TCA) (Euro 2)	6cyl.	13798cc	309kW (420PS)	Diesel	Turbo Intercooled	TD7378
EUROSTAR			01/93→02/02	HD 7		01/96→
EUROTECH MP			01/92→	HD 8		01/05→
EUROTRAKKER			01/93→11/04			





87-783000-10 STD

A 92.00
B- 21.00
BØ 83.80
D 157.00
50x115



AK HA KK RT TP

08-783000-00 STD

4.00 CR P
3.00 CR P
5.50 CR P



14-021230-00 DH ① B 143.02 C 282.00 D 147.00 E 6.00
14-021232-00 DH ① B 143.27 C 282.00 D 147.00 E 6.00
14-021560-10 DH B 143.00 C 282.00 D 147.00 E 6.06
14-021561-10 DH B 143.05 C 282.00 D 147.00 E 6.06
14-021562-10 DH B 143.25 C 282.00 D 147.00 E 6.06
14-021563-10 DH B 143.50 C 282.00 D 147.00 E 6.06
14-021590-00 DH ① B 143.04 C 282.00 D 149.00 E 6.04

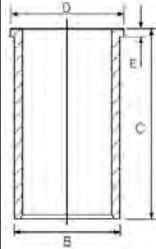

① Nitrided

① Nitriert

① Nitrué

① Nitrurado

① Nitrurato

145.00

63

8260.02	6cyl.	12880cc		Diesel	MP4023
8260.02.405	6cyl.	12880cc	191kW (260PS)	Diesel	TD7362
8261.1.002	6cyl.	12880cc		Diesel	MP14023
8261.02.002	6cyl.	12880cc	165kW (224PS)	Diesel	TD20430
8280.01	V8cyl.	17174cc		Diesel	MP603
8280.01.000	V8cyl.	17174cc	246kW (335PS)	Diesel	TD6869
8280.02.000	V8cyl.	17174cc	259kW (352PS)	Diesel	TD6879
8280.02.024	V8cyl.	17174cc	259kW (352PS)	Diesel	TD6873
8280.02.082	V8cyl.	17174cc	259kW (352PS)	Diesel	TD6882
8280.02.109	V8cyl.	17174cc	259kW (352PS)	Diesel	TD10551
8280.02.125-135	V8cyl.	17174cc	259kW (352PS)	Diesel	TD5638
8280.02.265	V8cyl.	17174cc		Diesel	MP4026
8280.02.269	V8cyl.	17174cc	259kW (352PS)	Diesel	TD20431
8280.02.273	V8cyl.	17174cc		Diesel	MP4026-1
8280.02.274	V8cyl.	17174cc	259kW (352PS)	Diesel	TD5639
8280.02.275	V8cyl.	17174cc	259kW (352PS)	Diesel	TD5980
8280.02.279	V8cyl.	17174cc		Diesel	MP4026-2
8280.02.289	V8cyl.	17174cc	259kW (352PS)	Diesel	TD7354
8280.02.405	V8cyl.	17174cc	259kW (352PS)	Diesel	TD7360
8280.02.410	V8cyl.	17174cc		Diesel	MP4026-3
8280.02.412	V8cyl.	17174cc		Diesel	MP4026-4
8281.02	V8cyl.	17174cc		Diesel	MP14026
8285.02	V8cyl.	17174cc		Diesel	MP9234

AGRICULTURAL

INDUSTRIAL, TRUCK & BUS

INDUSTRIAL

Series 300

01/58→12/71

87-782100-00 STD

A 95.00
B- 30.20
BØ 72.00
D 157.00
55x122



AK KK RT

08-782100-00 STD

4.00 CR P
3.00 CR P
6.00 CR P



15-260080-00 WH ① ② B 158.50 C 262.00 D 174.00 E 10.06 F 0.94
14-260080-00 WH ② B 158.50 C 262.00 D 174.00 E 10.06 F 0.94

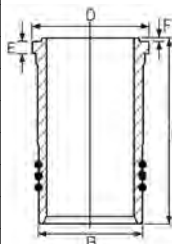

① Contains 3 seals of 3.00mm
② Nitrided

① Enthält drei 3,00mm Dichtungen
② Nitriert

① Contient 3 joints de 3 mm
② Nitrué

① Contiene 3 retenes de 3.00mm
② Nitrurado

① Contiene 3 OR di 3,00 millimetri
② Nitrurato



145.00

64

8280.22.000	V8cyl.	17174cc	280kW (381PS)	Diesel	Turbo	TD10565
8280.22.007	V8cyl.	17174cc	280kW (381PS)	Diesel	Turbo	TD10566
8280.22.009	V8cyl.	17200cc	280kW (381PS)	Diesel	Turbo	TD10583
8280.22.033	V8cyl.	17174cc	280kW (381PS)	Diesel	Turbo	TD10594
8280.22.054	V8cyl.	17174cc	280kW (381PS)	Diesel	Turbo	TD10567
8280.22.201	V8cyl.	17174cc	309kW (420PS)	Diesel	Turbo Intercooled	TD10569
8280.22.205	V8cyl.	17174cc	309kW (420PS)	Diesel	Turbo Intercooled	TD10570
8280.42.001	V8cyl.	17174cc	350kW (476PS)	Diesel	Turbo Intercooled	TD10572
8281.22.201	V8cyl.	17174cc	309kW (420PS)	Diesel	Turbo Intercooled	TD6378
8285.22	V8cyl.	17174cc		Diesel	Turbo	MP14027

INDUSTRIAL

TURBOSTAR

07/84→12/93

15-260080-00 WH ① ② B 158.50 C 262.00 D 174.00 E 10.06 F 0.94
 14-260080-00 WH ② B 158.50 C 262.00 D 174.00 E 10.06 F 0.94

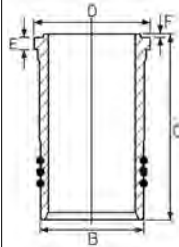

① Contains 3 seals of 3.00mm
 ② Nitrided

① Enthält drei 3,00mm Dichtungen
 ② Nitriert

① Contient 3 joints de 3 mm
 ② Nituré

① Contiene 3 retenes de 3.00mm
 ② Nitrurado

① Contiene 3 OR di 3,00 millimetri
 ② Niturato

ENGINE INDEX

Motorverzeichnis • Index de moteur • Índice de Motor
 Indeks silnika • Модель Двигателя • دليل المحرك

CCM
x

9

3.8	Petrol	3781	6	86.99	7
8L (85-87)	Petrol	4235	6	92.07	12
204PT	Petrol	1999	4	87.50	9
224DT	Diesel	2179	4	85.00	4
306DT (Euro 5)	Diesel	2993	V6	84.00	3
AJD	Diesel	2720	V6	81.00	1
AJV6D	Diesel	2993	V6	84.00	3
FMBA	Diesel	1998	4	86.00	5
FMBB	Diesel	1998	4	86.00	5
LJ46G (Duratorq-TDCi)	Diesel	2198	4	86.00	6
QJBA (Duratorq-TDCi)	Diesel	2198	4	86.00	6
V 12 (75-79)	Petrol	5343	V12	90.00	10
V 12 (90-93)	Petrol	5343	V12	90.00	11
XK (3.4)	Petrol	3442	6	82.99	2
XK (3.8)	Petrol	3781	6	86.99	8
XK 4.2 (-79)	Petrol	4235	6	92.07	12
XK 4.2 (82-87)	Petrol	4235	6	92.07	12



81.00

1

AJD	V6cyl.	2720cc	152kW (207PS)	Diesel	Turbo Intercooled	TD25810
S-TYPE II 2.7 D			06/04→10/07	XJ D 2.7		10/05→03/09
XF I 2.7 D			03/08→04/15			

87-432400-00 STD
87-432407-00 0.50mm

A 47.00
B- 14.05
BØ 44.00
C 0.50
D 71.00
29x62
(8165E-108)
AK KK RT TP



08-432400-00 STD
08-432407-00 0.50mm

2.00 CK P
2.00 P
2.00 P



82.99

2

XK (3.4)	6cyl.	3442cc	Petrol	MP895
XK 120 3.4			XK 150 3.4	01/57→12/61
XK 140 3.4			XK 150 S-type	01/58→12/61

87-529907-00 .020
87-529909-00 .030
87-529911-00 .040

A 43.05
B+ 12.01
D 103.42
22x72

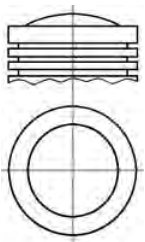

08-529907-00 .020
08-529909-00 .030
08-529911-00 .040

2.00 P
2.00 P
3.96 P



84.00

3

306DT (Euro 5)	V6cyl.	2993cc	155-221kW (211-300PS)	Diesel	Turbo Intercooled	TD27175
AJV6D	V6cyl.	2993cc	155-202kW (211-275PS)	Diesel	Turbo	TD25809
F-PACE 3.0 SDV6			09/15→	XF II 3.0 D		05/15→
XF 3.0 D			09/12→	XJ 3.0 SDV6		10/09→
XF I 3.0 D			03/09→04/15			

87-439100-10 STD 1 2
87-439107-10 0.50mm 1 2

A 46.00
B- 15.35
BØ 47.62
D 70.00
30x63
(0849D-408A)
AK KK RT TP



08-439100-10 STD 3
08-439107-10 0.50mm 3

1.75 GDC P
1.75 P
2.00 CR P



ECOTOUGH

1 Gen 2 piston can be retrofitted in Gen 1 engines

1 Kolben der 2. Generation können in Motoren der 1. Generation nachgerüstet werden

1 Les pistons de 2ème génération peuvent être montés sur des moteurs de 1ème génération

1 El pistón de la segunda generación se puede montar en los motores de primera generación

1 il pistone di seconda generazione può essere montato nei motori di prima generazione

2 Euro 6

3 For Gen 2 engines

3 Für Motoren der 2. Generation

3 Pour moteurs de 2ème génération

3 Para motores de segunda generación

3 Per i motori di seconda generazione

85.00

4

224DT	4cyl.	2179cc	110-147kW (150-200PS)	Diesel	Turbo Intercooled	TD26822
-------	-------	--------	-----------------------	--------	-------------------	---------









XF 2.2 D 09/12→04/14 XF I 2.2 D 04/11→04/15

87-436700-00 STD ①
87-436708-00 0.60mm ①

A 48.60
B- 15.12
BØ 50.40
C 0.38
D 74.61
 30x68
 (0850HA324)
AK KK RT TP

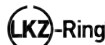

08-436700-00 STD
08-436708-00 0.60mm

2.50  GDC P
 2.00  P
 2.00  CK
 

① For pistons with a 24.3mm rod gap measured at pin centre line

① Für Kolben mit einem Pleuelaugenabstand von 24,3 MM, gemessen an der Kolbenbolzen-Mitte

① Pour pistons avec un écart de bielle de 24,3 mm mesuré au centre de l'axe bielle-piston

① Para pistones con una distancia de paso de biela en el centro del bulón de 24,3mm

① Per pistoni con passaggio biella di 24,3 mm misurato sull'asse foro spinotto

86.00 **5**

FMBA	4cyl.	1998cc	96kW (130PS)	Diesel	Turbo Intercooled	TD24398
FMBB	4cyl.	1998cc	96kW (130PS)	Diesel	Turbo Intercooled	TD24399

X-TYPE I 2.0 D 07/03→12/09

87-140800-10 STD ①
87-140807-10 0.50mm

A 47.70
B- 15.20
BØ 43.30
D 74.10
 30x66
 (8662)
KK RT TP



08-140800-00 STD ②
08-140807-00 0.50mm ②

2.00  CK P
 2.00  P
 2.00  NT ③

① Bowl capacity 21.49cm³

① Volumen der Kolbenmulde 21.49cm³

① Volume de la cavité du piston 21.49cm³
 ② Only fit to pistons equivalent to OE 24878 and 24879

① Vol. cavidad pistón 21.49cm³
 ② Cabido solamente a los pistones equivalentes a OE 24878 y 24 879

① Volume camera pistone 21.49cm³
 ② Adattato soltanto ai pistoni equivalenti a OE 24878 e 24879

③ Steel

③ Stahl

③ Acier

③ Acero

③ Acciaio

86.00 **6**

LJ46G (Duratorq-TDCi)	4cyl.	2198cc	107-114kW (146-155PS)	Diesel	Turbo Intercooled	TD24454
QJBA (Duratorq-TDCi)	4cyl.	2198cc	107-114kW (145-155PS)	Diesel	Turbo Intercooled	TD24400

X-TYPE I 2.2 D 10/05→12/09

87-427700-10 STD
87-427707-10 0.50mm

A 43.42
B- 15.85
BØ 46.90
D 69.82
 30x67
 (8648B105)
KK RT TP



08-427700-00 STD
08-427705-00 0.25mm
08-427707-00 0.50mm

2.00  CK P
 2.00  P
 2.00  NT ①

14-021120-00 D **B 89.00 C 156.00 D 90.90 E 5.00**

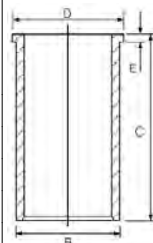

① Steel

① Stahl

① Acier

① Acero

① Acciaio

86.99 **7**

3.8	6cyl.	3781cc		Petrol		MP2524
MK IX 3.8			01/59→12/68	XK 150 3.8		01/59→12/68
MK X 3.8			01/59→12/68			





87-522600-00 *STD*
87-522607-00 *.020*

A 41.89
B+ 15.19
D 105.39
 22x76

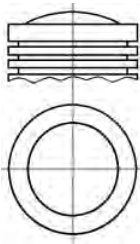

08-522600-00 *STD*
08-522607-00 *.020*

1.97 CR P
1.99 P
3.97 P

86.99

8

XK (3.8)	6cyl.	3781cc	Petrol	MP896
MK 9 3.8			01/58→12/61	XK 150 3.8
MK 10 3.8			01/61→12/65	01/59→12/61

87-525507-00 *.020*
87-525509-00 *.030*

A 42.52
B+ 10.03
D 100.86
 22x76

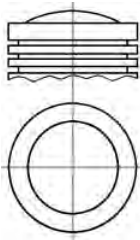

08-525507-00 *.020*

1.99 P
1.99 P
3.97 P

87.50

9

204PT	4cyl.	1999cc	147-184kW (200-250PS)	Petrol	Turbo Intercooled	TD26968
F-PACE 2.0 Ti4			05/16→	XF I 2.0		06/12→04/15
XE 2.0			03/15→	XF II 2.0		05/15→
XF 2.0 T			08/13→12/15	XJ 2.0 Ti4		05/12→

87-430200-00 *STD*
87-430207-00 *0.50mm*

A 34.98
B- 4.30
C 3.40
C 3.70
D 53.80
 23x56
(86540)
TP



08-430200-00 *STD*
08-430207-00 *0.50mm*

1.20 PVD
1.20 P
2.00 NT

Steel

Stahl

Acier

Acero

Acciaio

90.00

10

V 12 (75-79)	V12cyl.	5343cc	211kW (287PS)	Petrol	TD1731
XJ 12 5.3			05/75→02/93		





87-523600-00 STD

A 39.70
B- 7.15
BØ 77.20
D 80.98
 24x79

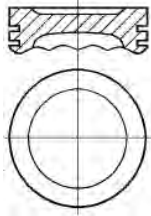

08-523600-00 STD

1.60
 2.00
 4.00
 CR P
 P

14-710010-00 WH

B 98.01 C 144.53 D 109.22 E 44.40

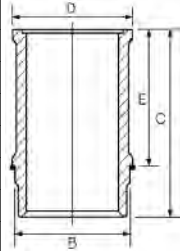

88-523600-00
 87-523600-00 +
 14-710010-00

90.00

11

V 12 (90-93)	V12cyl.	5343cc	197kW (268PS)	Petrol	TD4583
XJ 5.3			01/86→12/89	XJ Sovereign V12	07/85→12/92
XJSC 5.3			01/86→05/88		

14-710010-00 WH

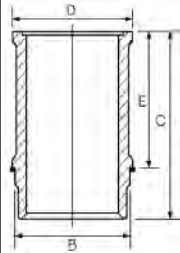

B 98.01 C 144.53 D 109.22 E 44.40



92.07

12

8L (85-87)	6cyl.	4235cc	127-133kW (173-181PS)	Petrol	TD5202
XK 4.2 (-79)	6cyl.	4235cc	124-137kW (169-186PS)	Petrol	TD1737
XK 4.2 (82-87)	6cyl.	4235cc	151-198kW (205-269PS)	Petrol	TD5199
E-TYPE 4.2			05/64→04/75	XJ 6 4.2	10/69→12/87

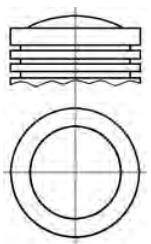

87-524000-00 STD 
87-524007-00 .020 
87-524009-00 .030 

A 41.50
B+ 11.05
D 85.49
 22x76



08-524000-00 STD
08-524007-00 .020

1.99
 1.99
 4.77
 CR P
 P
 CR P

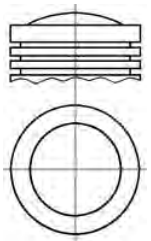

87-524000-10 STD 
87-524007-10 .020 

A 41.50
B+ 5.74
D 74.44
 22x76



08-524000-00 STD
08-524007-00 .020

1.99
 1.99
 4.77
 CR P
 P
 CR P

 Pistons to be replaced in Engine Sets only  Kolben nur in Motorsätzen zu ersetzen  Piston à remplacer dans jeu moteur  Pistones de repuesto para juegos de motores solamente  Il pistone può essere rimpiazzato solamente completo

Motorverzeichnis • Index de moteur • Índice de Motor
 Indeks silnika • Модель ДВИгателя • دليل المحرك

ENGINE INDEX



CCM

x



9

552 60 384	Diesel	1598	4	79.50	1
552 63 113	Diesel	1598	4	79.50	1
BMM	Diesel	1968	4	81.00	2
EJJ	Diesel	1598	4	79.50	1
EJK	Diesel	1598	4	79.50	1
ENO	Diesel	2499	4	92.00	4
OM 651.925	Diesel	2143	4	83.00	3
R 425 DOHC	Diesel	2499	4	92.00	4
VM 425HR (M51)	Diesel	2499	4	92.00	5
VM 425HS (M52)	Diesel	2499	4	92.00	5



79.50 1

552 60 384	4cyl.	1598cc	70-88kW (95-120PS)	Diesel	Turbo Intercooled	TD34807
552 63 113	4cyl.	1598cc	88kW (120PS)	Diesel	Turbo Intercooled	TD34813
EJJ	4cyl.	1598cc	70-88kW (95-120PS)	Diesel	Turbo Intercooled	TD34808
EJK	4cyl.	1598cc	88kW (120PS)	Diesel	Turbo Intercooled	TD32609



COMPASS 1.6 CRD	03/17→	RENEGADE 1.6 MultiJet	07/14→
RENEGADE 1.6 CRD	07/14→		

87-429300-10 STD ① ②
87-429306-10 0.40mm ① ②

08-429300-10 STD ③
08-429306-10 0.40mm ③

A 43.95
B- 13.80
BØ 41.70
C 1.01
C 1.03
D 68.95
 26x63



1.50  GDC P
 1.50  P
 2.00  CR P



(792A-765)
AK RT TP

- ① Pistons to be replaced in Engine Sets only ① Kolben nur in Motorsätzen zu ersetzen ① Piston à remplacer dans jeu moteur ① Pistones de repuesto para juegos de motores solamente ① Il pistone può essere rimpiazzato solamente completo
- ② Bowl capacity 19.65cm³ ② Volumen der Kolbenmulde 19.65cm³ ② Volume de la cavité du piston 19.65cm³ ② Vol. cavidad pistón 19.65cm³ ② Volume camera pistone 19.65cm³
- ③ Euro 6

81.00 2

BMM	4cyl.	1968cc	103kW (140PS)	Diesel	Turbo Intercooled	TD24007
------------	-------	---------------	----------------------	---------------	--------------------------	----------------

PATRIOT 2.0 D	01/07→		
---------------	--------	--	--

87-139500-10 STD ① ②
87-139507-10 0.50mm ① ③

08-139500-00 STD
08-139507-00 0.50mm

A 45.83
B- 17.50
BØ 38.00
C 0.70
D 68.80
 26x66



1.75  CK P
 2.00  P
 3.00  CR P

(07901D833)
AK KK NB RT TP

87-139500-20 STD ② ④
87-139507-20 0.50mm ③ ④

08-139500-00 STD
08-139507-00 0.50mm

A 45.83
B- 17.50
BØ 38.00
C 0.70
D 68.80
 26x66



1.75  CK P
 2.00  P
 3.00  CR P

(07901D834)
AK KK NB RT TP

- ① To cylinder 1 & 2 ① an Zylinder 1 & 2 ① sur cylindre 1 & 2 ① en el cilindro 1 & 2 ① a cilindro 1 & 2
- ② Bowl capacity 23.30cm³ ② Volumen der Kolbenmulde 23.30cm³ ② Volume de la cavité du piston 23.30cm³ ② Vol. cavidad pistón 23.30cm³ ② Volume camera pistone 23.30cm³
- ③ A = 45.550
- ④ To cylinder 3 & 4 ④ an Zylinder 3 & 4 ④ sur cylindre 3 & 4 ④ en el cilindro 3 & 4 ④ a cilindro 3 & 4

83.00 3

OM 651.925	4cyl.	2143cc	100-120kW (136-163PS)	Diesel	Turbo Intercooled	TD25244
-------------------	-------	---------------	------------------------------	---------------	--------------------------	----------------

COMPASS 2.2 CRD	12/10→		
-----------------	--------	--	--





87-433400-00 STD
87-433405-00 0.25mm
87-433407-00 0.50mm

A 48.50
B- 13.25
Bø 49.40
D 75.50
 30x66



(08349P202)
AK KK RT

08-433400-00 STD
08-433405-00 0.25mm
08-433407-00 0.50mm

2.00  GDC P
 1.75  P
 2.00  CR P



→120kW

92.00

4

ENO	4cyl.	2499cc	105kW (143PS)	Diesel	Turbo Intercooled	TD22110
R 425 DOHC	4cyl.	2499cc	105-125kW (143-170PS)	Diesel	Turbo Intercooled	TD22945

CHEROKEE 2.5 CRD 09/01→01/08

87-429200-00 STD

A 55.00
B- 18.00
Bø 44.00
D 83.00
 32x68



AK KK RT TP

08-429200-00 STD

2.50  GDC P
 1.50  P
 2.00  NT



92.00

5

VM 425HR (M51)	4cyl.	2499cc	85-89kW (115-121PS)	Diesel	Turbo	TD22949
VM 425HS (M52)	4cyl.	2499cc	85kW (115PS)	Diesel	Turbo	TD22950

15-676420-00 WH **B** 101.50 **C** 166.80 **D** 110.00 **E** 8.90 **F** 1.20
14-676420-00 WH **B** 101.50 **C** 166.80 **D** 110.00 **E** 8.90 **F** 1.20

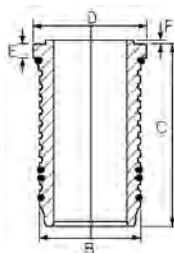

Includes seals

Schließt Dichtungen ein

Inclut des joints

Incluye los sellos

Comprende le guarnizioni

ENGINE INDEX

Motorverzeichnis • Index de moteur • Índice de Motor
 Indeks silnika • Модель Двигателя • دليل المحرك

CCM
x

9

300T	Diesel	5878	6	106.50	2
3164 DL 03	Diesel	2696	3	102.00	1
3179T	Diesel	2938	3	106.50	2
3239DL	Diesel	2983	3	106.50	3
4039T	Diesel	3920	4	106.50	2
4045D	Diesel	4525	4	106.50	2
4045T	Diesel	4525	4	106.50	2
4219 DL 01	Diesel	3588	4	102.00	1
4219 DL 03	Diesel	3588	4	102.00	1
4239A	Diesel	3918	4	106.50	2
4239DL	Diesel	3918	4	106.50	3
4239T	Diesel	3918	4	106.50	4
4276	Diesel	4524	4	106.50	4
6059T	Diesel	5878	6	106.50	2
6329 DL 03	Diesel	5395	6	102.00	1
6359A	Diesel	5876	6	106.50	2
6359DL	Diesel	5876	6	106.50	3
6414	Diesel	6800	6	106.50	4

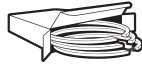





102.00

1

3164 DL 03	3cyl.	2696cc		Diesel	MP5568
4219 DL 01	4cyl.	3588cc	50-53kW (68-72PS)	Diesel	TD19035
4219 DL 03	4cyl.	3588cc	50-53kW (68-72PS)	Diesel	TD19033
6329 DL 03	6cyl.	5395cc	63-68kW (86-92PS)	Diesel	TD19034

AGRICULTURAL

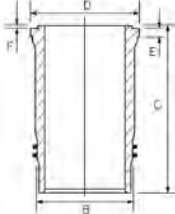
<p>A 66.30 B- 21.20 BØ 54.00 D 110.80  35x84 RT</p>		<p>08-181800-00 STD</p> <p>3.17  MO P 2.38  P 5.00  CR P</p>		<p>14-452740-00 WH</p> <p>B 111.00 C 197.00 D 125.00 E 6.04 F 0.81</p>	<p>88-181800-10 14-452740-00</p>
---	---	--	---	--	---

ⓘ Piston available in Kit Set only ⓘ Kolben nur im Assembly erhältlich ⓘ Piston disponible en kit seulement ⓘ Pistón disponible en conjuntos solamente. ⓘ I pistonni sono disponibili solo in kit motore

106.50

2

300T	6cyl.	5878cc	130kW (177PS)	Diesel	Turbo Intercooled	MP23185
3179T	3cyl.	2938cc	59kW (80PS)	Diesel	Turbo	MP13180
4039T	4cyl.	3920cc	59kW (80PS)	Diesel	Turbo	TD32193
4045D	4cyl.	4525cc	49kW (65PS)	Diesel		TD32246
4045T	4cyl.	4525cc	55kW (75PS)	Diesel	Turbo	TD32247
4239A	4cyl.	3918cc	87kW (118PS)	Diesel	Turbo Intercooled	MP18779
6059T	6cyl.	5878cc	123kW (167PS)	Diesel	Turbo	TD19032
6359A	6cyl.	5876cc	131kW (178PS)	Diesel	Turbo Intercooled	MP28781





AGRICULTURAL

Series 5010

01/98→12/01

Series 5000

01/96→12/00

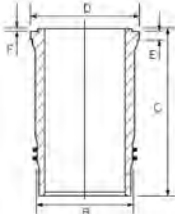



<p>87-181100-20 STD</p> <p>A 66.30 B- 18.80 BØ 58.50 D 112.00  41x84 RT</p>		<p>08-181100-00 STD</p> <p>3.15  MOL P 2.38  P 3.46  CR P</p>		<p>14-450710-00 WH</p> <p>B 115.69 C 196.00 D 126.00 E 6.86 F 0.81</p>	<p>88-181100-20 87-181100-20 + 14-450710-00</p>
--	---	---	---	--	--

106.50

3

3239DL	3cyl.	2983cc		Diesel	MP6423
4239DL	4cyl.	3918cc		Diesel	MP8779
6359DL	6cyl.	5876cc		Diesel	MP8781

AGRICULTURAL

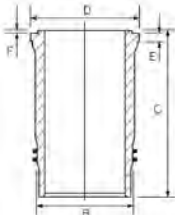
<p>87-181100-10 STD</p> <p>A 66.30 B- 18.75 BØ 58.40 D 112.00  35x84 RT</p>		<p>08-181100-00 STD</p> <p>3.15  MOL P 2.38  P 3.46  CR P</p>		<p>14-450710-00 WH</p> <p>B 115.69 C 196.00 D 126.00 E 6.86 F 0.81</p>	<p>88-181100-10 87-181100-10 + 14-450710-00</p>
--	---	---	---	--	--



106.50 **4**

4239T	4cyl.	3918cc	Diesel	Turbo	MP8780
4276	4cyl.	4524cc	Diesel		MP8848
6414	6cyl.	6800cc	Diesel		MP8849

AGRICULTURAL

14-450710-00 *WH*

B 115.69 C 196.00 D 126.00 E 6.86 F 0.81

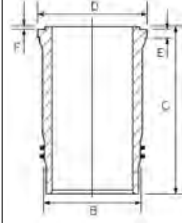



120.00

1

740.30 (Euro 2)	V8cyl.	10850cc	191kW (260PS)	Diesel	Turbo Intercooled	TD24482
740.35 (Euro 2)	V8cyl.	11760cc	294kW (400PS)	Diesel	Turbo	TD24484
740.50 (Euro 2)	V8cyl.	11760cc	265kW (360PS)	Diesel	Turbo Intercooled	TD24485
740.51 (Euro 2)	V8cyl.	11760cc	235kW (320PS)	Diesel	Turbo	TD24486

4326		05/11→		53229		05/99→
5360		05/86→		53605		05/05→
5460		05/03→		54112		05/78→
6450		05/02→		54115		05/95→
6460		10/03→		55111		05/82→
6520		01/03→		63501		05/03→
6522		05/05→		65111		01/03→
6540		05/02→		65115		05/90→
6560		05/05→		65116		05/08→
43118		05/87→		65117		05/06→
44108		01/03→		65201		05/06→
45141		05/90→		65221		05/13→
53205		05/06→		65222		05/08→
53212		05/94→		65224		05/05→
53213		05/89→		65225		05/04→
53228		05/99→		66062		05/95→

87-444700-00 STD

- A** 71.00
 - B-** 21.60
 - BØ** 70.00
 - C** 2.80
 - C** 2.50
 - D** 117.80
- 45x95



- 3.50 CR P
- 3.00 CR P
- 4.00 CR P

AK RT TP

ENGINE INDEX

Motorverzeichnis • Index de moteur • Índice de Motor
 Indeks silnika • Модель Двигателя • دليل المحرك



CCM

x



9

Engine Model	Fuel Type	CCM	x	Value	Count
D4CB (Euro 4)	Diesel	2497	4	91.00	11
D4EA (Euro 3)	Diesel	1991	4	83.00	9
D4FA (Euro 3)	Diesel	1493	4	75.00	3
D4FB (Euro 4)	Diesel	1582	4	77.20	8
D4FB-L (Euro 4)	Diesel	1582	4	77.20	8
G4ED (Euro 4)	Petrol	1599	4	76.50	5
G4EE (Euro 4)	Petrol	1399	4	75.50	4
G4FA (Euro 4)	Petrol	1396	4	77.00	6
G4FJ	Petrol	1591	4	77.00	7
G4LA	Petrol	1248	4	71.00	1
G4LC	Petrol	1368	4	72.00	2
R2	Diesel	2184	4	86.00	10



71.00

1

G4LA	4cyl.	1248cc	51-65kW (69-88PS)	Petrol	TD26878
PICANTO II 1.2			09/11→03/17	RIO III 1.25 LPG	09/11→12/17
PICANTO III 1.2			03/17→	RIO IV 1.25	01/17→
RIO III 1.2			09/11→12/17	RIO IV 1.25 LPG	07/20→
RIO III 1.25			06/11→12/17	STONIC 1.2	07/17→

87-448500-00 STD

87-448507-00 0.50mm

- A 24.70
- B- 3.00
- BØ 58.50
- C 2.82
- C 2.67
- D 43.90
- 18x48



08-448500-00 STD

08-448507-00 0.50mm

- 1.00 CR
- 1.20 P
- 2.00 PVD

Steel

Stahl

Acier

Acero

Acciaio

72.00

2

G4LC	4cyl.	1368cc	71-75kW (97-102PS)	Petrol	TD32502
CEED 1.4			03/18→	PRO CEE'D 1.4	07/13→07/18
CEE'D 1.4			04/15→07/18	RIO IV 1.4	01/17→
CEED 1.4 LPG			12/18→	STONIC 1.4	07/17→
PEGAS I 1.4			12/18→	STONIC 1.4 LPG	11/18→

87-423900-00 STD

87-423907-00 0.50mm

- A 24.70
- B- 3.60
- C 2.50
- D 42.70
- 18x48



08-423900-00 STD

08-423907-00 0.50mm

- 1.00 CR
- 1.20 P
- 2.00 PVD

Steel

Stahl

Acier

Acero

Acciaio

75.00

3

D4FA (Euro 3)	4cyl.	1493cc	54-85kW (73-116PS)	Diesel Turbo Intercooled	TD18454
CERATO I 1.5 CRDi			07/05→12/09	SELTOS 1.5 CRDi VGT	08/19→
PRIDE 1.5 CRDi LX			03/05→12/11	SONET 1.5 CRDi	09/20→
RIO II 1.5 CRDi			03/05→12/11		

87-849000-00 STD

87-849007-00 0.50mm

- A 41.95
- B- 12.20
- BØ 43.40
- C 0.50
- D 65.70
- 28x62



08-849000-00 STD

08-849007-00 0.50mm

- 1.75 NT
- 1.75 CR P
- 3.00 NT

Steel

Stahl

Acier

Acero

Acciaio

75.50

4

G4EE (Euro 4)	4cyl.	1399cc	55-71kW (75-97PS)	Petrol	TD19959
PRIDE 1.4 LX			03/05→12/11	RIO II 1.4 16V	03/05→12/11
RIO II 1.4			01/10→12/11	RIO II HEV	03/05→12/10





87-849200-00 STD
87-849207-00 0.50mm

08-849200-50 STD
08-849207-50 0.50mm

A 28.75
B+ 2.20
C 2.95
D 47.90
 18x48



1.20  CR
1.20  P
2.00 

Steel Stahl Acier Acero Acciaio

76.50 **5**

G4ED (Euro 4) 4cyl. **1599cc** **77-89kW** (105-121PS) **Petrol** **TD18452**

CERATO I 1.6	04/04→12/09	RIO II 1.6	03/05→12/11
PRIDE 1.6 LX	03/05→12/11	RIO II 1.6 16V	03/05→12/11

87-424200-00 STD
87-424207-00 0.50mm

08-424200-10 STD
08-424205-10 0.25mm
08-424207-10 0.50mm

A 28.14
B- 0.40
BØ 60.40
C 3.00
D 50.14
 18x48



1.20  CR FE
1.20  P
2.00  NT P

Steel Stahl Acier Acero Acciaio

77.00 **6**

G4FA (Euro 4) 4cyl. **1396cc** **64-80kW** (87-109PS) **Petrol** **TD19226**

CEE'D 1.4	12/06→07/18	VENGA	04/15→
CEE'D 1.4 LPG	01/09→07/18	VENGA 1.4	02/10→
PRO CEE'D 1.4	02/08→07/18	VENGA 1.4 LPG	02/10→
RIO III 1.4	06/11→		

87-424800-00 STD
87-424807-00 0.50mm

08-424800-30 STD
08-424805-30 0.25mm
08-424807-30 0.50mm

A 26.90
B+ 1.40
C 4.50
D 45.30
 18x52



1.20  CR FE
1.20  P
2.00  CR P

Steel Stahl Acier Acero Acciaio

77.00 **7**

G4FJ 4cyl. **1591cc** **118-152kW** (160-207PS) **Petrol** **Turbo Intercooled** **TD29359**

CEE'D 1.6 GT	06/13→07/18	PROCEED 1.6 T-GDI	10/18→
CEED 1.6 T-GDI GT	10/18→	PROCEED 1.6 T-GDI GT	10/18→
CEED T-GDI GT	10/18→	SELTOS 1.6 T-GDi	09/19→
CERATO III 1.6 Turbo	09/13→	SHUMA 1.6 TGDi	02/14→
CERATO IV 1.6 T-GDI	11/18→	SOUL II 1.6 TGDI	11/16→
CERATO KOUP II 1.6	09/13→	SOUL III 1.6 T-GDI	01/19→
CERATO KOUP III 1.6 T-GDI	12/13→	SPORTAGE IV 1.6 TGDI	09/15→





OPTIMA 1.6	09/15→	SPORTAGE IV 1.6 T-GDI	09/15→
OPTIMA 1.6 T-GDI	01/18→	XCEED 1.6 T-GDI	06/19→
PRO CEE'D 1.6 GT	06/13→07/18		

87-426900-00 STD ①
87-426907-00 0.50mm

A 28.00
B- 3.00
C 2.00
C 2.80
D 45.00
20x52



TP

08-426900-00 STD
08-426907-00 0.50mm

1.20 PVD ②
1.50 P
2.00 NT ②



87-426900-10 STD ③
87-426907-10 0.50mm

A 28.00
B- 3.00
C 2.00
C 2.80
D 45.00
20x52



RT TP

08-426900-00 STD
08-426907-00 0.50mm

1.20 PVD ②
1.50 P
2.00 NT ②



① OE 230412BCB0
② Steel
③ OE 230412BAA0

② Stahl

② Acier

② Acero

② Acciaio

77.20

8

D4FB (Euro 4)	4cyl.	1582cc	66-100kW (90-136PS)	Diesel	Turbo Intercooled	TD19228
D4FB-L (Euro 4)	4cyl.	1582cc	66kW (90PS)	Diesel	Turbo Intercooled	TD19229
CARENS III 1.6 CRDi 110			10/10→	PRO CEE'D 1.6 CRDi 110		03/13→07/18
CARENS III 1.6 CRDi 128			10/10→	PRO CEE'D 1.6 CRDi 115		02/08→09/12
CEE'D 1.6 CRDi			07/12→07/18	PRO CEE'D 1.6 CRDi 128		10/10→07/15
CEE'D 1.6 CRDi 90			12/06→12/12	PRO CEE'D 1.6 CRDi 136		07/15→07/18
CEE'D 1.6 CRDi 110			05/12→07/18	SOUL I 1.6 CRDi 115		02/09→12/14
CEE'D 1.6 CRDi 115			12/06→12/12	SOUL I 1.6 CRDi 128		02/09→12/14
CEE'D 1.6 CRDi 128			10/10→07/18	SOUL II 1.6 CRDi 128		02/14→
CEE'D 1.6 CRDi 136			07/15→07/18	SOUL II 1.6 CRDi 136		04/15→
CERATO I 1.6 CRDi			06/05→12/09	STONIC 1.6 CRDi		07/17→
CERATO III 1.6 CRDi			09/12→	VENGA 1.6 CRDi 115		02/10→
PRO CEE'D 1.6 CRDi			10/12→07/18	VENGA 1.6 CRDi 128		02/10→
PRO CEE'D 1.6 CRDi 90			02/08→09/12			

87-434200-00 STD
87-434207-00 0.50mm

A 41.95
B- 12.70
B- 2.80
BØ 18.20
C 0.50
D 65.70
28x62



AK KK RT

08-434200-00 STD
08-434207-00 0.50mm

1.75 PVD NT ①
1.75 CR P
3.00 NT ①



① Steel

① Stahl

① Acier

① Acero

① Acciaio



83.00 **9**

D4EA (Euro 3) 4cyl. **1991cc** **83-110kW** (113-150PS) **Diesel** **Turbo Intercooled** **TD18131**

CARENS II 2.0 CRDi	07/02→	CEE'D 2.0 CRDi 140	07/07→12/12
CARENS III 2.0 CRDi 115	05/07→	CERATO I 2.0 CRDi	04/04→05/06
CARENS III 2.0 CRDi 135	08/09→	MAGENTIS II 2.0 CRDi	11/05→12/10
CARENS III 2.0 CRDi 140	09/06→	PRO CEE'D 2.0 CRDi 140	02/08→09/12
CEE'D 2.0 CRDi	06/07→12/12	SPORTAGE II 2.0 CRDi	09/04→



87-431900-00 STD
87-431907-00 0.50mm
 →12/07

A 46.30
B- 13.90
Bø 46.95
D 72.30
 28x66

AK NB RT



08-431900-00 STD 1
08-431907-00 0.50mm 1

1.90  CK P 2
 2.00  CR P
 3.00  NT 2



87-430400-10 STD 3
87-430407-10 0.50mm
 01/08→

A 46.30
B- 16.95
Bø 42.70
D 72.30
 28x66

AK KK NB RT TP



08-430400-00 STD
08-430407-00 0.50mm

2.00  CK 2
 2.00  CR P
 3.00  NT 2

1 Oil ring radial width 3.75mm 1 Dicke Ölring: 3.75mm 1 Largeur radiale du segment d'huile 3.75mm 1 Ancho segmento de aceite 3,75mm 1 Spessore radiale segmento raschiaolio : 3.75 mm

2 Steel 2 Stahl 2 Acier 2 Acero 2 Acciaio

3 OE 2341027930 3 OE 2341027930 3 OE 2341027930 3 OE 2341027930 3 OE 2341027930

86.00 **10**

R2 4cyl. **2184cc** **48kW** (65PS) **Diesel** **TD11132**

BESTA 2.2 D	07/92→12/03
-------------	-------------

14-010840-00 *D* **B 90.00 C 179.96**

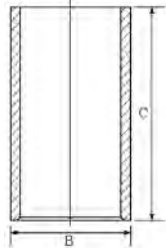

91.00 **11**

D4CB (Euro 4) 4cyl. **2497cc** **95-131kW** (129-178PS) **Diesel** **Turbo Intercooled** **TD19955**

BONGO 2.5 CRDi	01/12→	K2500 2.5 CRDi	01/10→
BONGO 2.5 CRDi	01/12→	SORENTO I 2.5 CRDi	08/02→12/11





87-431700-00 STD
87-431707-00 0.50mm

- A** 54.25
- B-** 15.00
- BØ** 52.00
- C** 0.30
- D** 83.75
-  33x75



AK KK RT

 Steel

 Stahl

08-431700-00 STD
08-431707-00 0.50mm

- 2.50  CK P
- 2.00  CR P
- 3.00  NT 

 Acier

 Acero

 Acciaio

ENGINE INDEX

Motorverzeichnis • Index de moteur • Índice de Motor
 Indeks silnika • Модель Двигателя • دليل المحرك



CCM

x



9

21126	Petrol	1597	4	82.00	3
BA3 2105	Petrol	1294	4	79.00	2
BA3 2106	Petrol	1570	4	79.00	2
C 20 XE	Petrol	1998	4	86.00	6
HR16DE	Petrol	1598	4	78.00	1
XUD9A	Diesel	1905	4	83.00	4
XUD9SD	Diesel	1905	4	83.00	5



78.00

1

HR16DE 4cyl. **1598cc** **81kW** (110PS) **Petrol** **TD35536**

XRAY 1.6 02/16→

87-437700-00 STD ①
87-437707-00 0.50mm ①

08-437700-00 STD
08-437707-00 0.50mm

A 28.50
B- 4.70
B0 65.00
B+ 2.20
C 1.80
D 49.20
 19x55

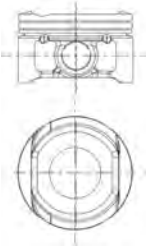

1.20  CR P ②
 1.20  P
 2.00  CR ②

RT

- ① Piston pin press fit in conrod ① Kolbenbolzen in Pleuel eingepreßt ① Axe serré sur bielle ① Bulón del pistón montado a presión en la biela ① Spinotto inserito a spinta nella biella
- ② Steel ② Stahl ② Acier ② Accero ② Acciaio

79.00

2

BA3 2105 4cyl. **1294cc** **48-68kW** (65-92PS) **Petrol** **TD5183**

BA3 2106 4cyl. **1570cc** **54-58kW** (73-79PS) **Petrol** **TD5190**

1200-1500 1.3 1300	10/74→10/79	NOVA 1.6	10/86→04/12
1200-1500 1300	01/81→12/82	NOVA 1300	09/83→12/97
1200-1600 1.3 2106	04/76→12/05	NOVA 1300/L	05/81→04/12
1200-1600 1300	08/74→08/84	NOVA 1600	01/88→10/01
1200-1600 1600	09/72→01/90	TOSCANA 1.6	10/85→05/12
1200-1600 1600 N/L	03/79→12/05	TOSCANA 1300	12/85→05/12

87-269806-00 0.40mm

08-269800-00 STD
08-269806-00 0.40mm

A 38.00
B- 2.00
B0 56.00
D 77.00
 22x64



1.50  CR P
 2.00  P
 3.94  P

82.00

3

21126 4cyl. **1597cc** **60-87kW** (82-118PS) **Petrol** **TD39439**

GRANTA 1.6	10/11→	PRIORA 1.6	04/07→07/18
KALINA 1.6	10/04→12/13	PRIORA 1.6 LPG	12/08→09/16
KALINA II 1.6	06/13→09/18		

87-425200-00 STD

08-425200-00 STD

A 25.40
C 1.70
C 1.49
D 45.40
 18x52



1.20  NT ①
 1.50  P
 2.00  P

TP

- ① Steel ① Stahl ① Acier ① Acero ① Acciaio

83.00

4

XUD9A 4cyl. **1905cc** **47-52kW** (64-71PS) **Diesel** **TD13350**

NIVA 1.9 D 01/93→





87-152000-10 STD
87-152007-10 0.50mm
87-152010-10 0.80mm

A 46.80
B- 2.20
D 84.30
 25x72



08-152000-00 STD
08-152003-00 0.125mm
08-152007-00 0.50mm
08-152010-00 0.80mm

2.00 CR P
 2.00 P
 3.00 CR P

14-020530-00 D

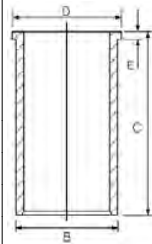

B 85.60 **C** 153.50 **D** 88.50 **E** 3.90

83.00

5

XUD9SD	4cyl.	1905cc	48-55kW (65-75PS)	Diesel	Turbo Intercooled	TD17345
NIVA 1900 Diesel 01/93→12/06						

87-105500-00 STD
87-105507-00 0.50mm

A 46.75
B- 3.50
D 75.00
 28x68



AK HA RT TP

08-105500-00 STD
08-105507-00 0.50mm

3.00 CK
 2.00 NT
 3.00 CR P

14-020530-00 D

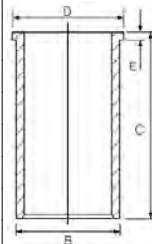

B 85.60 **C** 153.50 **D** 88.50 **E** 3.90

86.00

6

C 20 XE	4cyl.	1998cc	110kW (150PS)	Petrol		TD22868
110 2.0 i 08/96→07/00						

87-306800-10 STD
87-306807-10 0.50mm

A 30.43
B- 0.85
BØ 70.00
C 2.20
D 55.43
 21x62



08-306800-00 STD
08-306807-00 0.50mm
08-306811-00 1.00mm

1.50 CR P
 1.50 P
 3.00 CR

Steel

Stahl

Acier

Acero

Acciaio



CCM

x



9

4HP	Diesel	2179	4	85.00	27
4HR	Diesel	2179	4	85.00	27
4HS (Euro 4)	Diesel	2179	4	85.00	27
4HT (Euro 4)	Diesel	2179	4	85.00	27
149 C2.000	Petrol	1585	4	84.00	25
156 A2.000 (Fire)	Petrol	999	4	70.00	7
156 A2.100 (Fire)	Petrol	999	4	70.00	7
156 A2.246 (Fire)	Petrol	999	4	70.00	8
156 C.000	Petrol	1108	4	70.00	8
156 C.046	Petrol	1108	4	70.00	8
160 D1.000	Diesel	1929	4	82.60	22
175 A4.000	Petrol	1995	4	84.00	26
176 B2.000 (Euro 2 Fire)	Petrol	1108	4	70.00	9
176 B9.000 (Fire)	Petrol	1242	4	70.80	10
182 A2.000	Petrol	1747	4	82.00	18
182 B6.000	Petrol	1596	4	80.50	17
183 A1.000	Petrol	1747	4	82.00	18
188 A4.000 (Euro 3 Fire)	Petrol	1242	4	70.80	11
188 A5.000 (Euro 3 Fire)	Petrol	1242	4	70.80	12
188 A9.000	Diesel	1248	4	69.60	4
188 B2.000	Diesel	1910	4	82.00	19
192 B2.000	Petrol	1368	4	72.00	14
198 A5.000	Diesel	1956	4	83.00	24
199 A2.000	Diesel	1248	4	69.60	4
199 A3.000	Diesel	1248	4	69.60	5
199 B1.000 (Euro 5)	Diesel	1248	4	69.60	6
350 A1.000	Petrol	1368	4	72.00	15
828 B4.000	Petrol	1995	4	84.00	25
831 B4.000	Petrol	1995	4	84.00	25
831 B5.000	Petrol	1995	4	84.00	25
831 B7.000	Petrol	1585	4	84.00	25
831 C5.000	Petrol	1995	4	84.00	25
831 C5.046	Petrol	1995	4	84.00	25
831 D.000	Diesel	1929	4	82.60	23
831 D1.000	Diesel	1929	4	82.60	23
831 D5.000	Petrol	1995	4	84.00	25
831 E5.000	Petrol	1995	4	84.00	26
831 E5.046	Petrol	1995	4	84.00	26
834 B.000	Petrol	1995	4	84.00	25
834 B.048	Petrol	1995	4	84.00	25
834 B.146	Petrol	1995	4	84.00	25
834 B1.000	Petrol	1995	4	84.00	25
834 B2.246	Petrol	1995	4	84.00	25
834 C.000	Petrol	1995	4	84.00	25
834 C.146	Petrol	1995	4	84.00	25
834 C1.000	Petrol	1995	4	84.00	26
834 F1.000	Petrol	1995	4	84.00	25
834 F2.000	Petrol	1995	4	84.00	26
835 A2.000	Petrol	1756	4	84.00	25
835 A2.046	Petrol	1756	4	84.00	25
835 A4.000	Diesel	1929	4	82.60	22
835 A4.046	Diesel	1929	4	82.60	22
835 A5.046	Petrol	1995	4	84.00	25
835 A7.000	Petrol	1995	4	84.00	25
835 A7.046	Petrol	1995	4	84.00	25
835 C2.000	Petrol	1756	4	84.00	25
835 C4.000	Petrol	1756	4	84.00	25
836 A2.000	Petrol	1995	4	84.00	26
836 A3.000	Petrol	1995	4	84.00	25
836 A5.000	Petrol	1756	4	84.00	25

ENGINE INDEX

Motorverzeichnis • Index de moteur • Índice de Motor
 Indeks silnika • Модель Двигателя • دليل المحرك



CCM

x



9





836 A6.000	Petrol	1756	4	84.00	25
836 C4.000	Petrol	1756	4	84.00	25
838 A3.000	Diesel	2387	5	82.00	21
838 A4.000	Petrol	1995	4	84.00	26
838 A7.000	Diesel	2387	5	82.00	21
838 A8.000 (Euro 2)	Diesel	2387	5	82.00	21
839 A4.000	Petrol	1747	4	82.00	18
839 A5.000	Diesel	2387	5	82.00	21
839 A6.000 (Euro 3)	Diesel	2387	5	82.00	19
840 A3.000 (Fire)	Petrol	1242	4	70.80	13
841 C.000 (Euro 3)	Diesel	2387	5	82.00	19
841 G.000	Diesel	2387	5	82.00	20
841 M.000	Diesel	2387	5	82.00	20
841 N.000	Diesel	2387	5	82.00	20
843 A1.000	Petrol	1368	4	72.00	14
844 A2.000	Diesel	1956	4	83.00	24
937 A2.000 (Euro 3)	Diesel	1910	4	82.00	19
937 A5.000	Diesel	1910	4	82.00	20
944 A3.000	Diesel	1598	4	79.50	16
955 A4.000	Diesel	1598	4	79.50	16
8144. 97S	Diesel	2500	4	93.00	32
8144.91 (Sofim)	Diesel	2445	4	93.00	33
8144.97 (Sofim)	Diesel	2500	4	93.00	32
8144.97 Y (Sofim)	Diesel	2500	4	93.00	32
8144.97.2200	Diesel	2500	4	93.00	32
8144.97.2400	Diesel	2500	4	93.00	33
A112 A.000	Petrol	903	4	65.00	1
A112 A2.000	Petrol	1050	4	67.20	3
A112 A5.000	Petrol	903	4	65.00	2
A112 B2.000	Petrol	903	4	65.00	1
AR 32302	Diesel	1910	4	82.00	21
AR 32501	Diesel	2387	5	82.00	21
AR 37101	Diesel	1910	4	82.00	21
DW10ATED4 (RHW) (Euro 3)	Diesel	1997	4	85.00	28
DW12ATED4 (4HW)	Diesel	2179	4	85.00	29
RHK (DW10UTED4) (Euro 4)	Diesel	1997	4	85.00	30
RHM (DW10ATED4)	Diesel	1997	4	85.00	28
RHR (DW10BTED4) (Euro 4)	Diesel	1997	4	85.00	30
RHZ (DW10ATED)	Diesel	1997	4	85.00	31









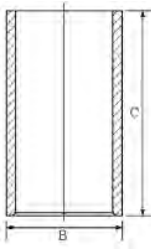

65.00

1

A112 A.000	4cyl.	903cc	21-32kW (29-44PS)	Petrol	TD1856
A112 B.2.000	4cyl.	903cc	29-32kW (40-44PS)	Petrol	TD4622
A 112 0.9 Junior		03/81→06/86			

<p>87-209800-00 STD 87-209806-00 0.40mm 87-209808-00 0.60mm</p> <p>A 30.75 D 61.25  20x54</p> 	<p>08-209800-00 STD 08-209806-00 0.40mm 08-209808-00 0.60mm</p> <p>1.75  CR P 2.00  P 3.94  P</p>	<p>14-011001-00 D</p> <p>B 68.04 C 115.00</p> 
---	---	--





<p>87-209800-10 STD  87-209806-10 0.40mm  87-209808-10 0.60mm </p> <p>A 31.25 D 61.75  20x54</p> 	<p>08-209800-00 STD 08-209806-00 0.40mm 08-209808-00 0.60mm</p> <p>1.75  CR P 2.00  P 3.94  P</p>	
--	---	--

 Without circlips  Ohne Sicherungsclips  Sans circlips  Sin anillos de retención  Pistone con spinotto montato a caldo

65.00

2

A112 A5.000	4cyl.	903cc	29-31kW (40-42PS)	Petrol	TD1803
A 112 0.9 Junior		03/81→06/86			

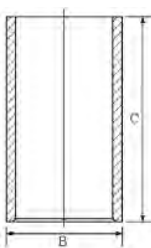
<p>87-209800-00 STD 87-209806-00 0.40mm 87-209808-00 0.60mm</p> <p>A 30.75 D 61.25  20x54</p> 	<p>08-209800-00 STD 08-209806-00 0.40mm 08-209808-00 0.60mm</p> <p>1.75  CR P 2.00  P 3.94  P</p>	<p>14-011001-00 D</p> <p>B 68.04 C 115.00</p> 
---	---	--

67.20

3

A112 A2.000	4cyl.	1050cc	51kW (69PS)	Petrol	TD4621
A 112 1.0 Abarth		03/78→02/84			









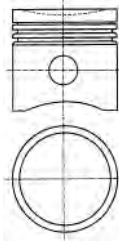

87-782606-00 0.40mm
87-782608-00 0.60mm

08-782600-00 STD
08-782606-00 0.40mm
08-782608-00 0.60mm

A 30.75
B- 1.50
D 54.75
 18x56



1.50  CR P
 1.75  P
 3.94  CR 

 Steel  Stahl  Acier  Acero  Acciaio

 69.60					4
188 A9.000	4cyl.	1248cc	51kW (70PS)	Diesel	TD18314
199 A2.000	4cyl.	1248cc	55kW (75PS)	Diesel Turbo Intercooled	TD20272
MUSA 1.3 D Multijet		10/04→09/12	YPSILON 1.3 JTD		10/03→12/11
YPSILON 1.3 D Multijet		09/06→12/11			

87-137600-00 STD
87-137606-00 0.40mm

08-137600-00 STD
08-137606-00 0.40mm

A 40.43
B- 12.40
BØ 37.00
C 1.00
C 1.20
D 63.43
 23x57



2.00  CK P
 1.50  P
 2.00  P

AK RT TP

14-022060-00 D **B 72.50 C 142.00 D 74.00 E 5.00**

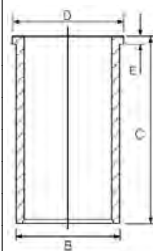

 69.60					5
199 A3.000	4cyl.	1248cc	66-77kW (90-105PS)	Diesel Turbo Intercooled	TD20273
MUSA 1.3 D Multijet		09/06→09/12	YPSILON 1.3 D Multijet		09/06→12/11

87-425600-00 STD
87-425606-00 0.40mm
87-425608-00 0.60mm

08-425600-00 STD
08-425606-00 0.40mm
08-425608-00 0.60mm

A 40.43
B- 12.41
BØ 38.00
C 0.91
C 0.91
D 62.43
 23x55





2.00  CK P
 1.50  NT
 2.00  CR P

(06933)

AK KK RT TP

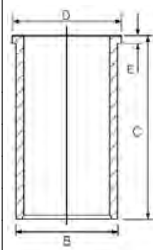
14-022060-00 D **B 72.50 C 142.00 D 74.00 E 5.00**



 69.60					6
199 B1.000 (Euro 5)	4cyl.	1248cc	57-70kW (77-95PS)	Diesel Turbo Intercooled	TD24672
MUSA 1.3 D Multijet		03/09→09/12	YPSILON 1.3 D Multijet		05/11→





87-435700-00 STD
87-435706-00 0.40mm

A 40.43
B- 12.70
BØ 37.00
C 1.15
C 0.90
D 62.43
 23x57



AK KK RT

08-435700-00 STD
08-435706-00 0.40mm

1.50  GDC P
 1.50  P
 2.00  CR P



With Stop/Start Technology Für Fahrzeuge mit Start/Stop Funktion Pour véhicules équipé du start & stop Para vehiculos con función start-stop Per veicoli con la funzione Start-Stop

70.00 **7**

156 A2.000 (Fire)	4cyl.	999cc	33-37kW (45-50PS)	Petrol	TD4592
156 A2.100 (Fire)	4cyl.	999cc	32kW (44PS)	Petrol	TD4593

Y10 1.0 Fire 03/85→02/92

87-154200-00 STD
87-154206-00 0.40mm
87-154208-00 0.60mm

A 33.90
B- 0.50
BØ 55.00
D 57.40
 18x53



08-154200-00 STD
08-154206-00 0.40mm
08-154208-00 0.60mm

1.50  CR P
 1.50  P
 3.00  CR

14-010991-00 D **B** 73.02 **C** 116.00

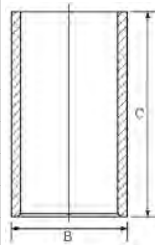

Steel Stahl Acier Acero Acciaio

70.00 **8**

156 A2.246 (Fire)	4cyl.	999cc	33kW (45PS)	Petrol	TD5423
156 C.000	4cyl.	1108cc	42kW (57PS)	Petrol	TD1854
156 C.046	4cyl.	1108cc	37-40kW (50-54PS)	Petrol	TD4597

Y10 1.0 Fire 10/87→02/92 Y10 1.1 i.e Fire 08/89→06/92
 Y10 1.1 i.e. Fire 07/89→12/95

87-154200-10 STD
87-154206-10 0.40mm

A 33.90
B- 1.50
D 57.40
 18x53



08-154200-00 STD
08-154206-00 0.40mm
08-154208-00 0.60mm

1.50  CR P
 1.50  P
 3.00  CR

14-010991-00 D **B** 73.02 **C** 116.00

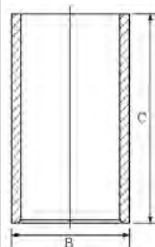

Steel Stahl Acier Acero Acciaio

70.00 **9**

176 B2.000 (Euro 2 Fire)	4cyl.	1108cc	40kW (54PS)	Petrol	TD11847
---------------------------------	-------	---------------	--------------------	---------------	----------------

Y 1.1 11/95→09/03 Y10 1.1 Fire 01/95→12/95





87-142300-00 STD
87-142306-00 0.40mm
87-142308-00 0.60mm

A 30.00
B- 1.80
BØ 60.00
D 50.00
E 18x53



08-142300-00 STD
08-142306-00 0.40mm
08-142308-00 0.60mm

1.20 CR P
 1.20 P
 2.50 P

14-010991-00 D **B** 73.02 **C** 116.00

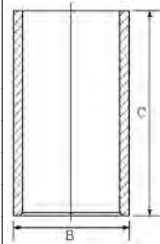

70.80

10

176 B9.000 (Fire) 4cyl. **1242cc** **63kW (86PS)** **Petrol** **TD11849**

Y 1.2 16V 04/97→09/03

87-138400-00 STD
87-138406-00 0.40mm

A 28.05
B- 5.70
C 1.50
D 48.00
E 18x53



08-138400-00 STD
08-138406-00 0.40mm
08-138408-00 0.60mm

1.19 NT P
 1.20 P
 2.50 P

14-021080-00 D **B** 73.80 **C** 128.00 **D** 75.00 **E** 5.00

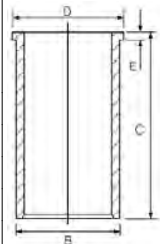

70.80

11

188 A4.000 (Euro 3 Fire) 4cyl. **1242cc** **44kW (60PS)** **Petrol** **TD15501**

Y 1.2 03/96→09/03 YPSILON 1.2 10/03→12/11

87-138400-40 STD
87-138406-40 0.40mm

A 28.00
B- 1.80
C 1.10
D 48.00
E 18x53



08-138400-00 STD
08-138406-00 0.40mm
08-138408-00 0.60mm

1.19 NT P
 1.20 P
 2.50 P

14-021080-00 D **B** 73.80 **C** 128.00 **D** 75.00 **E** 5.00

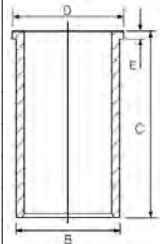

70.80

12

188 A5.000 (Euro 3 Fire) 4cyl. **1242cc** **59kW (80PS)** **Petrol** **TD15500**

Y 1.2 16V 10/00→09/03 YPSILON 1.2 10/03→12/11

87-138400-30 STD
87-138406-30 0.40mm

A 28.00
B- 5.10
D 48.00
E 18x49



08-138400-00 STD
08-138406-00 0.40mm
08-138408-00 0.60mm

1.19 NT P
 1.20 P
 2.50 P

14-021080-00 D **B** 73.80 **C** 128.00 **D** 75.00 **E** 5.00

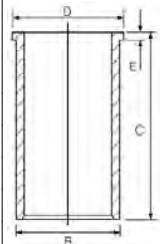



70.80

13

840 A3.000 (Fire) 4cyl. 1242cc 44kW (60PS) Petrol TD1839

Y 1.2 03/96→09/03

87-138400-10 STD
87-138406-10 0.40mm
87-138408-10 0.60mm

08-138400-00 STD
08-138406-00 0.40mm
08-138408-00 0.60mm

14-021080-00 D

B 73.80 C 128.00 D 75.00 E 5.00

A 28.00
B- 2.50
D 47.50
 18x53



1.19 NT P
1.20 P
2.50 P

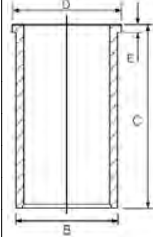

72.00

14

192 B2.000 4cyl. 1368cc 66kW (90PS) Petrol TD20952

843 A1.000 4cyl. 1368cc 70kW (95PS) Petrol TD17979

MUSA 1.4 10/04→09/12 YPSILON 1.4 16V 10/03→12/11

87-433200-00 STD
87-433206-00 0.40mm

08-433200-00 STD
08-433206-00 0.40mm

A 26.00
B- 7.80
BØ 57.60
C 1.40
C 2.20
D 46.00
 18x49



1.00 NT
1.20 P
2.00 P

66.00kW→
 Steel

Stahl

Acier

Acero

Acciaio

72.00

15

350 A1.000 4cyl. 1368cc 55-57kW (75-78PS) Petrol TD20274

MUSA 1.4 09/05→09/12 YPSILON 1.4 02/06→12/11

MUSA 1.4 LPG 11/10→09/12 YPSILON 1.4 LPG 11/10→12/11

87-436800-00 STD
87-436806-00 0.40mm

08-436800-00 STD
08-436806-00 0.40mm

A 26.00
B- 4.75
C 2.05
D 49.00
 18x49



1.00 NT
1.20 P
2.00 CR P

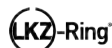

Steel

Stahl

Acier

Acero

Acciaio

79.50

16

944 A3.000 4cyl. 1598cc 77kW (105PS) Diesel Turbo Intercooled TD25422

955 A4.000 4cyl. 1598cc 85kW (116PS) Diesel Turbo Intercooled TD24651

DELTA III 1.6 D Multijet 08/08→08/14







87-429300-10 STD ① ②
87-429306-10 0.40mm ① ②

A 43.95
B- 13.80
BØ 41.70
C 1.01
C 1.03
D 68.95
 26x63



(792A-765)
AK RT TP

08-429300-10 STD ③
08-429306-10 0.40mm ③

1.50  GDC P
 1.50  P
 2.00  CR P



- ① Pistons to be replaced in Engine Sets only ① Kolben nur in Motorsätzen zu ersetzen ① Piston à remplacer dans jeu moteur ① Pistones de repuesto para juegos de motores solamente ① Il pistone può essere rimpiazzato solamente completo
- ② Bowl capacity 19.65cm³ ② Volumen der Kolbenmulde 19.65cm³ ② Volume de la cavité du piston 19.65cm³ ② Vol. cavidad pistón 19.65cm³ ② Volume camera pistone 19.65cm³
- ③ Euro 6

80.50 **17**

182 B6.000	4cyl.	1596cc	76kW (103PS)	Petrol	TD15632
LYBRA 1.6		10/00 → 10/05			

87-124800-00 STD
87-124806-00 0.40mm

A 28.65
B- 1.20
BØ 62.00
C 2.49
C 1.98
D 50.65
 21x56



08-124800-00 STD
08-124806-00 0.40mm
08-124808-00 0.60mm

1.20  NT P
 1.20  P
 2.00  P

82.00 **18**

182 A2.000	4cyl.	1747cc	66-83kW (90-113PS)	Petrol	TD9473
183 A1.000	4cyl.	1747cc	96kW (131PS)	Petrol	TD9474
839 A4.000	4cyl.	1747cc	96kW (131PS)	Petrol	TD14468
DEDRA 1.8 16V LE		03/96 → 07/99		DELTA II 1.8 i.e. 16V GT	
DEDRA 1.8 GT 16V		03/96 → 07/99		LYBRA 1.8 16V	
DELTA II 1.8 i.e. 16V		03/96 → 08/99		03/96 → 08/99 07/99 → 10/05	

87-118006-00 0.40mm

A 36.15
B- 0.50
D 60.15
 20x52



08-118000-00 STD
08-118006-00 0.40mm
08-118008-00 0.60mm

1.19  NT
 1.20  P
 2.00  P

82.00 **19**

188 B2.000	4cyl.	1910cc	74kW (101PS)	Diesel	Turbo Intercooled	TD18316
839 A6.000 (Euro 3)	5cyl.	2387cc	103kW (140PS)	Diesel	Turbo Intercooled	TD15631
841 C.000 (Euro 3)	5cyl.	2387cc	110kW (150PS)	Diesel	Turbo Intercooled	TD16472
937 A2.000 (Euro 3)	4cyl.	1910cc	85kW (116PS)	Diesel	Turbo Intercooled	TD18313
LYBRA 1.9 JTD		05/01 → 10/05		MUSA 1.9 D Multijet		10/04 → 09/12





LYBRA 2.4 JTD		09/00→10/05		THESIS 2.4 JTD		07/02→07/09	
87-124000-30 STD		08-124000-00 STD		14-021051-00 D	B 85.57 C 155.00 D 88.53 E 4.00		
87-124008-30 0.60mm		08-124008-00 0.60mm		14-028960-00 D	B 85.00 C 155.00 D 88.00 E 4.50		
A 46.50		2.00					
B- 17.45		2.00					
BØ 37.55		2.00					
C 0.65							
D 72.50							
26x61							
NB RT							

82.00							20
841 G.000	5cyl.	2387cc	129kW (175PS)	Diesel	Turbo Intercooled		TD18317
841 M.000	5cyl.	2387cc	120-147kW (163-200PS)	Diesel	Turbo Intercooled		TD19057
841 N.000	5cyl.	2387cc	120kW (163PS)	Diesel	Turbo Intercooled		TD19058
937 A5.000	4cyl.	1910cc	110kW (150PS)	Diesel	Turbo Intercooled		TD21086
THESIS 2.4 JTD		05/03→07/09					

87-146100-00 STD		08-146100-00 STD		14-021051-00 D	B 85.57 C 155.00 D 88.53 E 4.00		
87-146108-00 0.60mm		08-146106-00 0.40mm		14-028960-00 D	B 85.00 C 155.00 D 88.00 E 4.50		
87-146108-00 0.60mm		08-146108-00 0.60mm					
A 46.50		2.00					
B- 15.40		2.00					
BØ 41.50		2.00					
C 1.03							
D 72.50							
26x61							
(08256-102)							
AK KK NB RT TP							

82.00							21
838 A3.000	5cyl.	2387cc	91kW (124PS)	Diesel	Turbo Intercooled		TD4618
838 A7.000	5cyl.	2387cc	91kW (124PS)	Diesel	Turbo Intercooled		TD5437
838 A8.000 (Euro 2)	5cyl.	2387cc	100kW (136PS)	Diesel	Turbo Intercooled		TD11551
839 A5.000	5cyl.	2387cc	96-99kW (131-135PS)	Diesel	Turbo Intercooled		TD17399
AR 32302	4cyl.	1910cc	77kW (105PS)	Diesel	Turbo Intercooled		TD17398
AR 32501	5cyl.	2387cc	99-100kW (135-136PS)	Diesel	Turbo Intercooled		TD17400
AR 37101	4cyl.	1910cc	80-85kW (109-116PS)	Diesel	Turbo Intercooled		TD17890

KAPPA 2.4 JTD		06/98→10/01		LYBRA 1.9 JTD		07/99→09/01	
KAPPA 2.4 T.DS		08/94→10/01		LYBRA 2.4 JTD		07/99→02/01	
				14-021051-00 D	B 85.57 C 155.00 D 88.53 E 4.00		
				14-028960-00 D	B 85.00 C 155.00 D 88.00 E 4.50		

82.60							22
160 D1.000	4cyl.	1929cc	66kW (90PS)	Diesel	Turbo Intercooled		TD4610







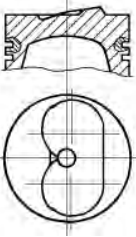

835 A4.000	4cyl.	1929cc	66kW (90PS)	Diesel	Turbo Intercooled	TD1846
835 A4.046	4cyl.	1929cc	66kW (90PS)	Diesel	Turbo Intercooled	TD5425
DEDRA 1.9 TDS		04/89→07/99		DELTA II 1.9 TD		10/94→08/99

87-783800-30 STD
87-783808-30 0.60mm

A 42.40
B+ 2.50
D 76.00
 26x69
HA RT



08-783800-00 STD
08-783808-00 0.60mm

3.00  MOL P
 2.00  P
 3.00  CR P

14-014730-00 D **B** 86.09 **C** 154.00

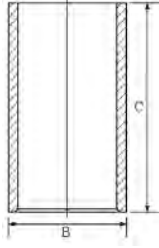

14-021311-00 D **B** 86.06 **C** 154.00 **D** 89.00 **E** 4.50
14-023560-00 D **B** 86.00 **C** 154.00 **D** 89.00 **E** 4.50
14-023751-00 D **B** 87.00 **C** 154.00 **D** 89.00 **E** 4.55

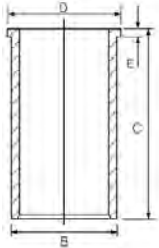

82.60 **23**

831 D.000	4cyl.	1929cc	48kW (65PS)	Diesel	TD1813
831 D1.000	4cyl.	1929cc	48-59kW (55-80PS)	Diesel	Turbo Intercooled TD4607
DELTA I 1.9 Turbo DS		10/86→12/89		PRISMA 1.9 Turbo Diesel	05/85→12/89
PRISMA 1.9 Diesel		01/83→02/92			

14-014730-00 D **B** 86.09 **C** 154.00

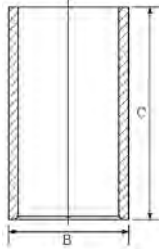

14-021311-00 D **B** 86.06 **C** 154.00 **D** 89.00 **E** 4.50
14-023560-00 D **B** 86.00 **C** 154.00 **D** 89.00 **E** 4.50
14-023751-00 D **B** 87.00 **C** 154.00 **D** 89.00 **E** 4.55

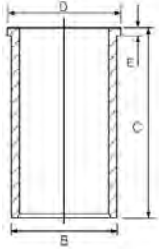



83.00 24

198 A5.000	4cyl.	1956cc	121kW (165PS)	Diesel	Turbo Intercooled	TD21043
844 A2.000	4cyl.	1956cc	120kW (163PS)	Diesel	Turbo Intercooled	TD24652

DELTA III 2.0 D Multijet 09/08→08/14

87-436500-00 STD
87-436506-00 0.40mm

08-436500-00 STD
08-436506-00 0.40mm

- A 46.63
- B- 15.80
- BØ 43.50
- D 72.63
- 30x66



- 1.50 GDC P
- 1.50 P
- 2.00 CR P



(08344A406)
AK KK RT TP

84.00 25

149 C2.000	4cyl.	1585cc	66kW (90PS)	Petrol		TD5432
828 B4.000	4cyl.	1995cc	90kW (122PS)	Petrol		TD4602
831 B4.000	4cyl.	1995cc	85kW (115PS)	Petrol		TD1812
831 B5.000	4cyl.	1995cc	122kW (166PS)	Petrol	Turbo Intercooled	TD1823
831 B7.000	4cyl.	1585cc	80kW (109PS)	Petrol		TD1817
831 C5.000	4cyl.	1995cc	133kW (181PS)	Petrol	Turbo Intercooled	TD1821
831 C5.046	4cyl.	1995cc	130kW (177PS)	Petrol	Turbo Intercooled	TD1822
831 D5.000	4cyl.	1995cc	144kW (196PS)	Petrol	Turbo Intercooled	TD1825
834 B.000	4cyl.	1995cc	88kW (120PS)	Petrol		TD1833
834 B1.000	4cyl.	1995cc	86kW (117PS)	Petrol		TD1830
834 B2.246	4cyl.	1995cc	104kW (141PS)	Petrol	Turbo Intercooled	TD1832
834 B.048	4cyl.	1995cc	83-85kW (112-113PS)	Petrol		TD1829
834 B.146	4cyl.	1995cc	85kW (116PS)	Petrol		TD1818
834 C.000	4cyl.	1995cc	122kW (166PS)	Petrol	Turbo Intercooled	TD1834
834 C.146	4cyl.	1995cc	110kW (150PS)	Petrol	Turbo Intercooled	TD1837
834 F1.000	4cyl.	1995cc	110-112kW (150-152PS)	Petrol		TD1831
835 A2.000	4cyl.	1756cc	80kW (108PS)	Petrol		TD1845
835 A2.046	4cyl.	1756cc	74-77kW (101-105PS)	Petrol		TD1844
835 A5.046	4cyl.	1995cc	82-83kW (112-113PS)	Petrol		TD1848
835 A7.000	4cyl.	1995cc	121kW (165PS)	Petrol	Turbo Intercooled	TD1849
835 A7.046	4cyl.	1995cc	124kW (169PS)	Petrol	Turbo Intercooled	TD1850
835 C2.000	4cyl.	1756cc	76kW (103PS)	Petrol		TD4612
835 C4.000	4cyl.	1756cc	66kW (90PS)	Petrol		TD5433
836 A3.000	4cyl.	1995cc	102-108kW (139-147PS)	Petrol		TD4614
836 A5.000	4cyl.	1756cc	74kW (101PS)	Petrol		TD4615
836 A6.000	4cyl.	1756cc	66kW (90PS)	Petrol		TD11918
836 C4.000	4cyl.	1756cc	66kW (90PS)	Petrol		TD5434

BETA 2000 i.e.	12/81→12/84	DELTA II 2.0 16V	06/93→08/99
BETAH.P.E. 2000 i.e.	05/81→09/84	PRISMA 1.6 i.e.	05/86→12/89
DEDRA 1.8 i.e.	09/89→07/99	PRISMA 1.6 i.e. Super	05/87→12/89
DEDRA 2.0 16V	07/94→07/99	PRISMA 2.0 i.e.	04/86→12/89
DEDRA 2.0 HF Integrale	11/90→07/94	THEMA 2000 16V	05/92→07/94
DEDRA 2.0 i.e.	09/89→07/99	THEMA 2000 i.e.	09/88→05/92
DEDRA 2.0 i.e. Turbo Integrale	04/90→08/91	THEMA 2000 i.e.	11/84→05/92
DEDRA 2.0 Integrale	07/94→07/99	THEMA 2000 i.e. 16V	02/89→05/92
DELTA I 1.6 GT i.e.	08/86→08/92	THEMA 2000 i.e. Turbo	11/84→07/94
DELTA I 2.0 16V HF Integrale	03/89→09/91	THEMA 2000 i.e. Turbo	07/86→05/90
DELTA I 2.0 HF Integrale	11/86→12/92	THEMA 2000 Turbo	12/88→03/92
DELTA II 1.8 i.e.	06/93→08/99	TREVI 2000 i.e.	05/80→01/87





14-011041-00 D B 88.06 C 152.00

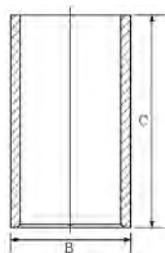

84.00

26

175 A4.000	4cyl.	1995cc	142kW (193PS)	Petrol	Turbo Intercooled	TD11827
831 E5.000	4cyl.	1995cc	151-158kW (205-215PS)	Petrol	Turbo Intercooled	TD1827
831 E5.046	4cyl.	1995cc	155kW (211PS)	Petrol	Turbo Intercooled	TD1826
834 C1.000	4cyl.	1995cc	133kW (181PS)	Petrol	Turbo Intercooled	TD1835
834 F2.000	4cyl.	1995cc	148kW (202PS)	Petrol	Turbo Intercooled	TD1840
836 A2.000	4cyl.	1995cc	137kW (186PS)	Petrol	Turbo Intercooled	TD5435
838 A4.000	4cyl.	1995cc	151kW (205PS)	Petrol	Turbo Intercooled	TD4619
DELTA I 2.0 16V HF Evo I Integrale			09/91→12/92	KAPPA 2.0 16V Turbo		02/95→10/01
DELTA I 2.0 16V HF Evo II Integrale			06/93→01/94	THEMA 2000 16V Turbo		12/88→07/94
DELTA I 2.0 16V HF Evo Integrale			06/91→01/94	THEMA 2000 i.e. 16V Turbo		12/88→06/90
DELTA II 2.0 16V Turbo			06/93→08/99	THEMA 2000 Turbo 16V		11/92→07/94

87-142400-00 STD

87-142406-00 0.40mm

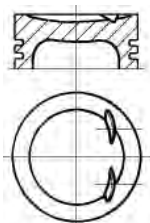

A 39.00
B- 6.00
BØ 72.00
C 2.00
D 69.00
 22x69

AK



08-142400-00 STD

08-142406-00 0.40mm

1.50  **CK**
 1.50  **P**
 3.00  **P**

14-011041-00 D B 88.06 C 152.00

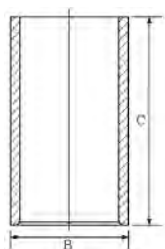

85.00

27

4HP	4cyl.	2179cc	120kW (163PS)	Diesel	Turbo Intercooled	TD24689
4HR	4cyl.	2179cc	120kW (163PS)	Diesel	Turbo Intercooled	TD24690
4HS (Euro 4)	4cyl.	2179cc	125kW (170PS)	Diesel	Turbo Intercooled	TD24688
4HT (Euro 4)	4cyl.	2179cc	125kW (170PS)	Diesel	Bi-Turbo Intercooled	TD24686

PHEDRA 2.2 D Multijet 03/08→11/10 PHEDRA 2.2 JTD 04/06→11/10

87-436700-10 STD 

87-436708-10 0.60mm 

A 48.70
B- 13.47
BØ 52.40
C 0.38
D 74.71
 30x68

(0850HA127)

AK KK RT TP





08-436700-00 STD

08-436708-00 0.60mm

2.50  **GDC P**
 2.00  **P**
 2.00  **CK**

GDC  **LKZ-Ring** 

 For pistons with a 24.3mm con rod gap measured at pin centre line

 Für Kolben mit einem Pleuelaugenabstand von 24,3 MM, gemessen an der Kolbenbolzen-Mitte

 Pour pistons avec un écart de bielle de 24,3 mm mesuré au centre de l'axe bielle-piston

 Para pistones con una distancia de paso de biela en el centro del bulón de 24,3mm

 Per pistoni con passaggio biella di 24,3 mm misurato sull'asse foro spinotto



85.00						28
DW10ATED4 (RHW) (Euro 3)	4cyl.	1997cc	80-81kW (109-110PS)	Diesel	Turbo Intercooled	TD16735
RHM (DW10ATED4)	4cyl.	1997cc	79kW (107PS)	Diesel	Turbo Intercooled	TD26957
PHEDRA 2.0 JTD	09/02→11/10		ZETA 2.0 JTD 16V		04/01→10/03	

87-114700-10 STD
87-114708-10 0.60mm

- A 46.73
- B- 18.80
- BØ 39.80
- C 1.67
- D 72.70

(08517-103)

AK KK RT TP



08-114700-00 STD
08-114708-00 0.60mm

- 3.50  CK P
- 2.00  P
- 3.00  CR P

85.00						29
DW12ATED4 (4HW)	4cyl.	2179cc	94kW (128PS)	Diesel	Turbo Intercooled	TD16736
PHEDRA 2.2 JTD	09/02→11/10					

87-114700-30 STD

- A 48.70
- B- 18.00
- BØ 40.80
- C 0.40
- C 0.40
- D 77.70

(30x68)

AK KK RT



08-114700-00 STD
08-114708-00 0.60mm

- 3.50  CK P
- 2.00  P
- 3.00  CR P

85.00						30
RHK (DW10UTED4) (Euro 4)	4cyl.	1997cc	79-88kW (107-120PS)	Diesel	Turbo Intercooled	TD26952
RHR (DW10BTED4) (Euro 4)	4cyl.	1997cc	100kW (136PS)	Diesel	Turbo Intercooled	TD26955
PHEDRA 2.0 D Multijet	07/06→11/10		PHEDRA 2.0 JTD		06/06→11/10	

87-114700-40 STD
87-114708-40 0.60mm

- A 46.70
- B- 15.40
- BØ 44.80
- C 0.57
- D 72.71

(08570-109)

AK KK RT TP



08-114700-00 STD
08-114708-00 0.60mm

- 3.50  CK P
- 2.00  P
- 3.00  CR P

85.00						31
RHZ (DW10ATED)	4cyl.	1997cc	80kW (109PS)	Diesel	Turbo Intercooled	TD26954
ZETA 2.0 JTD	09/99→09/02					





87-114700-00 STD
87-114708-00 0.60mm

08-114700-00 STD
08-114708-00 0.60mm

A 46.75
B- 18.30
BØ 38.00
C 1.00
D 80.75
 28x70



3.50  CK P
2.00  P
3.00  CR P

AK RT TP

93.00

32

8144.97 (Sofim)	4cyl.	2500cc	85kW (115PS)	Diesel	Turbo Intercooled	TD4601
8144.97.2200	4cyl.	2500cc	85-87kW (116-118PS)	Diesel	Turbo Intercooled	TD19036
8144. 97S	4cyl.	2500cc	77kW (105PS)	Diesel	Turbo	TD1785
8144.97 Y (Sofim)	4cyl.	2500cc	85kW (115PS)	Diesel	Turbo Intercooled	TD1786
THEMA 2500 Turbo DS		05/88 → 07/94				

14-021371-00 D B 96.01 C 171.00 D 98.92 E 5.00
14-021372-00 D B 96.05 C 171.00 D 98.92 E 5.00

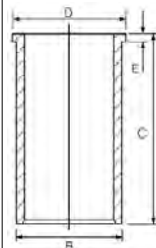

93.00

33

8144.91 (Sofim)	4cyl.	2445cc	74kW (101PS)	Diesel	Turbo Intercooled	TD4600
8144.97.2400	4cyl.	2500cc	83-87kW (113-118PS)	Diesel	Turbo Intercooled	TD22318
THEMA 2500 Turbo D		11/84 → 09/88		THEMA 2500 Turbo DS		03/87 → 09/90

14-022560-00 D B 96.00 C 167.30 D 98.90 E 5.00
14-028930-00 D B 97.50 C 167.00 D 100.90 E 5.00
14-028931-00 D B 97.58 C 167.00 D 100.90 E 5.00
14-028932-00 D B 97.70 C 167.00 D 100.90 E 5.00

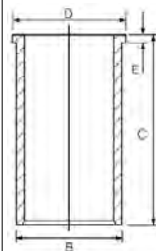



CCM

x









9

2 1/4L	Petrol	2286	4	90.47	16
2.3L (3 Main Bearing Crankshaft)	Diesel	2286	4	90.47	18
3.5L CARBURETTOR	Petrol	3528	V8	88.86	13
3.5L EFI	Petrol	3528	V8	88.86	13
10 H	Petrol	2286	4	90.47	16
10 J (5 Main Bearing Crankshaft)	Diesel	2286	4	90.47	18
11 A (VM492HT)	Diesel	2376	4	92.00	22
11 D	Petrol	3528	V8	88.86	13
11H	Petrol	2286	4	90.47	16
11 L (200TDI)	Diesel	2495	4	90.47	19
12 J	Diesel	2495	4	90.47	20
12 L (200TDI)	Diesel	2495	4	90.47	19
14 L (200TDI)	Diesel	2495	4	90.47	19
16 L (300TDI)	Diesel	2495	4	90.47	21
17 H	Petrol	2495	4	90.47	17
17 L (300TDI)	Diesel	2495	4	90.47	21
18 K4F (K Series)	Petrol	1796	4	80.00	1
19 J	Diesel	2495	4	90.47	18
19 L (300TDI)	Diesel	2495	4	90.47	21
20 T2N (L SERIES)	Diesel	1994	4	84.45	7
21 L (300TDI)	Diesel	2495	4	90.47	21
22 D	Petrol	3528	V8	88.86	14
22 L (300TDI)	Diesel	2496	4	90.47	21
23 L (300TDI)	Diesel	2495	4	90.47	21
24 D	Petrol	3528	8	88.86	14
25 D	Petrol	3528	V8	88.86	14
25 K4F	Petrol	2497	V6	80.00	2
30DDTX	Diesel	2993	V6	84.00	5
31 D	Petrol	3528	V8	88.86	13
46 D	Petrol	4553	V8	94.00	23
204PT	Petrol	1999	4	87.50	12
224DT	Diesel	2179	4	85.00	9
276DT (Euro 4)	Diesel	2720	V6	81.00	3
306DT (Euro 5)	Diesel	2993	V6	84.00	5
DT224 (Duratorq-TDCi)	Diesel	2198	4	86.00	11
DT244 (Duratorq)	Diesel	2402	4	89.90	15
DW12BTED4 (Euro 4)	Diesel	2179	4	85.00	10
M 47 R	Diesel	1951	4	84.00	4
M57 D30 (TD6)	Diesel	2926	6	84.00	6
TD5 (10P)	Diesel	2495	5	84.45	8
V8	Petrol	3950	V8	94.00	24







80.00 1

18 K4F (K Series)	4cyl.	1796cc	85-88kW (116-120PS)	Petrol	TD20740
FREELANDER I 1.8			10/00→10/06	FREELANDER I 1.8 i 16V	02/98→10/06
FREELANDER I 1.8 16V			04/98→10/06		

87-522700-00 STD	08-522700-00 STD	14-710020-00 WH	B 84.10 C 129.50 D 87.50 E 50.00	88-522700-00 87-522700-00 + 14-710020-00
A 22.70 B- 0.53 BØ 68.20 C 2.65 D 45.65  18x53 TP	 1.00  CR <input type="checkbox"/> 1.20  P 2.00  CR <input type="checkbox"/>			
<input type="checkbox"/> Steel	<input type="checkbox"/> Stahl	<input type="checkbox"/> Acier	<input type="checkbox"/> Acero	<input type="checkbox"/> Acciaio

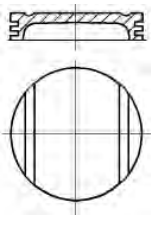



80.00 2

25 K4F	V6cyl.	2497cc	129-130kW (175-177PS)	Petrol	TD19716
FREELANDER I 2.5 V6			11/00→10/06		

87-521600-00 STD	08-521600-00 STD	14-710020-00 WH	B 84.10 C 129.50 D 87.50 E 50.00	
A 27.35 C 1.20 D 50.30  18x53	 1.20  CR 1.50  CR <input type="checkbox"/> 2.50  CR <input type="checkbox"/>			
<input type="checkbox"/> Steel	<input type="checkbox"/> Stahl	<input type="checkbox"/> Acier	<input type="checkbox"/> Acero	<input type="checkbox"/> Acciaio

81.00 3

276DT (Euro 4)	V6cyl.	2720cc	140kW (190PS)	Diesel Turbo Intercooled	TD24908
DISCOVERY III 2.7 TD			07/04→09/09	RANGE ROVER SPORT I 2.7 D	02/05→03/13
DISCOVERY IV 2.7 TD			09/09→12/18		

87-432400-00 STD 87-432407-00 0.50mm	08-432400-00 STD 08-432407-00 0.50mm			
A 47.00 B- 14.05 BØ 44.00 C 0.50 D 71.00  29x62 (8165E-108) AK KK RT TP	 2.00  CK P 2.00  P 2.00  P			

84.00 4

M 47 R	4cyl.	1951cc	85kW (116PS)	Diesel Turbo Intercooled	TD24392
FREELANDER 2.0 D			01/01→		







87-114400-00 STD
87-114405-00 0.25mm

A 47.00
B- 15.05
BØ 41.70
C 1.30
D 71.00
 30x66
 (08452-L160)
KK RT



08-114400-00 STD ¹
08-114405-00 0.25mm

3.00  CK P
 2.00  P
 3.00  CR P

¹ OE 1125 224 7383

84.00 **5**



30DDTX	V6cyl.	2993cc	155-200kW (211-272PS)	Diesel	Turbo Intercooled	TD25818
306DT (Euro 5)	V6cyl.	2993cc	155-250kW (211-340PS)	Diesel	Turbo Intercooled	TD24909
DISCOVERY IV 3.0 SDV6			11/09→12/18		RANGE ROVER IV 3.0 TDV6	08/12→
DISCOVERY IV 3.0 TD			09/09→12/18		RANGE ROVER SPORT I 3.0 D	09/09→03/13
DISCOVERY V 3.0 D			09/16→		RANGE ROVER SPORT II 3.0 SDV6	04/13→
DISCOVERY V 3.0 SDV6			09/18→		RANGE ROVER SPORT II 3.0 TDV6	04/13→
DISCOVERY V 3.0 Sdv6			09/18→		RANGE ROVER VELAR 3.0 D275 SDV6	04/18→
DISCOVERY V 3.0 Td6			09/16→		RANGE ROVER VELAR 3.0 D300 SDV6	03/17→
RANGE ROVER IV 3.0 SDV6			08/12→			



87-439100-10 STD ¹ ²
87-439107-10 0.50mm ¹ ²

A 46.00
B- 15.35
BØ 47.62
D 70.00
 30x63
 (0849D-408A)
AK KK RT TP



08-439100-10 STD ³
08-439107-10 0.50mm ³

1.75  GDC P
 1.75  P
 2.00  CR P

GDC  **LKZ-Ring** 

ECOTOUGH

- ¹ Gen 2 piston can be retrofitted in Gen 1 engines
- ² Euro 6
- ³ For Gen 2 engines
- ¹ Kolben der 2. Generation können in Motoren der 1. Generation nachgerüstet werden
- ³ Für Motoren der 2. Generation
- ¹ Les pistons de 2ème génération peuvent être montés sur des moteurs de 1ème génération
- ³ Pour moteurs de 2ème génération
- ¹ El pistón de la segunda generación se puede montar en los motores de primera generación
- ³ Para motores de segunda generación
- ¹ il pistone di seconda generazione può essere montato nei motori di prima generazione
- ³ Per i motori di seconda generazione

84.00 **6**



M57 D30 (TD6)	6cyl.	2926cc	130-142kW (177-193PS)	Diesel	Turbo Intercooled	TD22322
RANGE ROVER 2.9 D			03/02→			

87-114400-10 STD
87-114405-10 0.25mm

A 47.00
B- 16.55
BØ 41.60
C 1.40
D 71.10
 30x66
 (08452-L165)
AK KK RT



08-114400-00 STD ¹
08-114405-00 0.25mm

3.00  CK P
 2.00  P
 3.00  CR P

¹ OE 1125 224 7383



84.45 7

20 T2N (L SERIES) 4cyl. **1994cc** **72kW (98PS)** Diesel Turbo Intercooled **TD26632**

FREELANDER I 2.0 DI 02/98→10/06

87-119800-00 STD
87-119807-00 0.50mm

08-119800-00 STD
08-119807-00 0.50mm

A 47.97
B- 17.00
BØ 38.00
D 76.97
 30x70



3.00 PS
2.00 P
3.00 CR

AK RT TP

15 degree Wedge Top Ring 15-Grad Keiloberring Segment trapézoïdal angle 15 de grés. Anillo superior en cuña de 15 grados Segmento trapecio con inclinazione fianchi = 15

84.45 8

TD5 (10P) 5cyl. **2495cc** **90-102kW (122-139PS)** Diesel Turbo Intercooled **TD25823**

DEFENDER 2.5 Td5 06/98→02/16 DISCOVERY II 2.5 Td5 11/98→06/04

87-140000-00 STD
87-140007-00 0.50mm

08-140000-00 STD
08-140007-00 0.50mm

A 47.94
B- 17.40
BØ 39.00
D 78.94
 30x70



3.00 PS P
2.00 P
3.00 CR P

KK RT TP

85.00 9

224DT 4cyl. **2179cc** **110-140kW (150-190PS)** Diesel Turbo Intercooled **TD24922**

DISCOVERY SPORT 2.2 D 09/14→ RANGE ROVER EVOQUE SD4 05/15→12/19

RANGE ROVER EVOQUE 2.2 D 06/11→12/19 RANGE ROVER EVOQUE TD4 05/15→12/19

87-436700-00 STD
87-436708-00 0.60mm

08-436700-00 STD
08-436708-00 0.60mm

A 48.60
B- 15.12
BØ 50.40
C 0.38
D 74.61
 30x68



2.50 GDC P
2.00 P
2.00 CK

(0850HA324)

AK KK RT TP



For pistons with a 24.3mm con rod gap measured at pin centre line Für Kolben mit einem Plevelaugenabstand von 24,3 MM, gemessen an der Kolbenbolzen-Mitte Pour pistons avec un écart de bielle de 24,3 mm mesuré au centre de l'axe bielle-piston Para pistones con una distancia de paso de biela en el centro del bulón de 24,3mm Per pistoni con passaggio biella di 24,3 mm misurato sull'asse foro spinotto

85.00 10

DW12BTED4 (Euro 4) 4cyl. **2179cc** **110-118kW (150-160PS)** Diesel Turbo Intercooled **TD26064**





87-436700-10 STD ①
87-436708-10 0.60mm ①

A 48.70
B- 13.47
BØ 52.40
C 0.38
D 74.71



30x68
 (0850HA127)
AK KK RT TP

08-436700-00 STD
08-436708-00 0.60mm

2.50 GDC P
 2.00 P
 2.00 CK



① For pistons with a 24.3mm rod gap measured at pin centre line
 ① Für Kolben mit einem Pleuelagenabstand von 24,3 MM, gemessen an der Kolbenboizen-Mitte
 ① Pour pistons avec un écart de bielle de 24,3 mm mesuré au centre de l'axe bielle-piston
 ① Para pistones con una distancia de paso de biela en el centro del bulón de 24,3mm
 ① Per pistoni con passaggio biella di 24,3 mm misurato sull'asse foro spinotto

86.00

11

DT224 (Duratorq-TDCi) 4cyl. **2198cc** **90-110kW (122-150PS)** Diesel Turbo Intercooled **TD35046**

DEFENDER 2.2 Td4 08/11→02/16

87-427700-10 STD
87-427707-10 0.50mm

A 43.42
B- 15.85
BØ 46.90
D 69.82



30x67
 (8648B105)
KK RT TP

08-427700-00 STD
08-427705-00 0.25mm
08-427707-00 0.50mm

2.00 CK P
 2.00 P
 2.00 NT ①

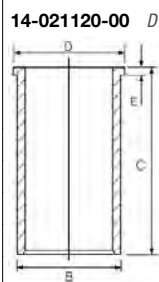
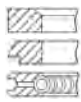

B 89.00 C 156.00 D 90.90 E 5.00

87-427700-40 STD ②
87-427707-40 0.50mm ②

A 48.42
B- 15.85
BØ 46.90
D 74.82



30x66
 (08683-101)
AK KK RT TP

08-427700-00 STD
08-427705-00 0.25mm
08-427707-00 0.50mm

2.00 CK P
 2.00 P
 2.00 NT ①



① Steel ① Stahl ① Acier ① Acero ① Acciaio
 ② *** CAUTION - CHECK BOWL DIAMETER *** ② *** ACHTUNG - MULDENDURCHMESSER ÜBERPRÜFEN *** ② ** Attention ¿ veuillez verifier le diamètre du bol** ② ** Precaución - verifica el diámetro del bulón ** ② ** attenzione ¿ controllare diametro camera di combustione **

87.50

12

204PT 4cyl. **1999cc** **176-179kW (240-243PS)** Petrol Turbo Intercooled **TD26312**

DISCOVERY SPORT 2.0	11/14→	RANGE ROVER EVOQUE 2.0	06/11→12/19
DISCOVERY SPORT Si4	01/17→	RANGE ROVER EVOQUE Si4	09/13→12/19
FREELANDER 2 2.0 Si4	10/11→10/14	RANGE ROVER SPORT II 2.0 GTDI	10/15→





87-430200-00 STD
87-430207-00 0.50mm

08-430200-00 STD
08-430207-00 0.50mm

A 34.98
B- 4.30
C 3.40
C 3.70
D 53.80
 23x56
(86540)
TP



1.20  PVD 
1.20  P 
2.00  NT 

 Steel  Stahl  Acier  Acero  Acciaio

 88.86				13
3.5L CARBURETTOR	V8cyl.	3528cc	Petrol	MP2683-2
3.5L EFI	V8cyl.	3528cc	Petrol	MP5059
11 D	V8cyl.	3528cc	86-97kW (117-132PS)	Petrol
31 D	V8cyl.	3528cc	107kW (146PS)	Petrol
90		01/83→12/90	RANGE ROVER	01/77→12/85
109 Series III		01/81→12/85	RANGE ROVER 3.5 V8	01/86→12/88
110		01/83→12/90	RANGE ROVER 3.5 Vogue	01/85→12/89
DEFENDER 3.5		09/90→08/93	RANGE ROVER I 3.5	10/69→08/91
DISCOVERY 3.5 V8		01/90→09/93	RANGE ROVER I 3.5 Vogue	08/81→09/90

87-520100-00 STD
87-520107-00 .020

08-520100-00 STD
08-520107-00 .020

A 47.37
B- 5.26
BØ 71.12
D 77.09
 22x73



1.58  CR P
1.58  P
4.73  P

 88.86				14
22 D	V8cyl.	3528cc	100-122kW (136-166PS)	Petrol
24 D	8cyl.	3528cc	120kW (163PS)	Petrol
25 D	V8cyl.	3528cc	120kW (163PS)	Petrol
DISCOVERY I 3.5		06/89→06/94	RANGE ROVER I 3.5 Vogue	10/85→09/90

87-520100-10 STD
87-520107-10 .020

08-520100-00 STD
08-520107-00 .020

A 47.17
B- 2.36
BØ 71.12
D 77.09
 22x73



1.58  CR P
1.58  P
4.73  P

 89.90				15
DT244 (Duratorq)	4cyl.	2402cc	90-103kW (122-140PS)	Diesel Turbo Intercooled
DEFENDER 2.4 Td4		10/06→05/16	DEFENDER 2.4 TD4	05/07→02/16





87-148100-30 STD
87-148105-30 0.25mm
87-148107-30 0.50mm

A 53.50
B- 16.30
BØ 49.00
D 80.50
 32x71



(08900B102)
AK KK RT TP

08-148100-00 STD
08-148105-00 0.25mm
08-148107-00 0.50mm

2.00  CK P
 2.00  P
 2.00  NT 

 Steel

 Stahl

 Acier

 Acero

 Acciaio

90.47

16

2 1/4L	4cyl.	2286cc	51-52kW (69-71PS)	Petrol	MP944
10 H	4cyl.	2286cc	51-52kW (69-71PS)	Petrol	TD25821
11H	4cyl.	2286cc	51-57kW (69-78PS)	Petrol	TD25824
88/109 MK III 2.3			11/71→12/86	90 I 2.3	01/84→08/87
88/109 MK IIA 2.3			12/61→10/71	109 Series II	01/58→12/85
88 Series II			01/58→12/85	109 Series III	01/58→12/85
88 Series III			01/58→12/85	109 Series IIA	01/58→12/85
88 Series IIA			01/58→12/85	110	01/83→08/86
90			01/84→12/85	110/127 2.3	06/84→08/87

87-263107-00 .020

A 58.52
D 99.92
 25x76



08-263100-00 STD
08-263107-00 .020

1.79  CR P
 1.79  P
 4.74  P

14-010920-00 D **B 94.50 C 191.36**

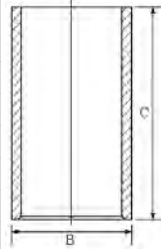

14-024710-00 D **B 94.52 C 191.36 D 99.70 E 4.76**

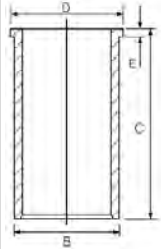

90.47

17

17 H	4cyl.	2495cc	61kW (83PS)	Petrol	TD19656
90 I 2.5			09/85→08/90	DEFENDER 2.5	09/90→12/94
110/127 2.5			10/85→07/90		





87-263100-10 STD
87-263107-10 .020

A 54.48
B- 0.91
D 89.23
E 25x76



08-263100-00 STD
08-263107-00 .020

1.79 CR P
1.79 P
4.74 P



14-010920-00 D B 94.50 C 191.36

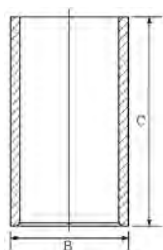

14-024710-00 D B 94.52 C 191.36 D 99.70 E 4.76

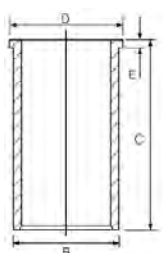

90.47

18

2.3L (3 Main Bearing Crankshaft)	4cyl.	2286cc		Diesel	MP945
10 J (5 Main Bearing Crankshaft)	4cyl.	2286cc	46-51kW (63-69PS)	Diesel	TD25822
19 J	4cyl.	2495cc	63kW (86PS)	Diesel Turbo	TD24369
88/109 MK III 2.3 D			11/71→12/86	90 Series III	01/58→12/85
88/109 MK IIA 2.3 D			09/63→10/71	90 Series IIA	01/58→12/85
88 Series II			01/58→12/85	109 Series III	01/71→12/84
88 Series III			01/58→12/85	109 Series IIA	09/61→12/71
88 Series IIA			01/58→12/85	110/127 2.3 D	06/84→08/87
90 I 2.5 TD			09/86→08/90	110/127 2.5 TD	09/86→07/90
90 Series II			01/58→12/85		

14-010920-00 D B 94.50 C 191.36

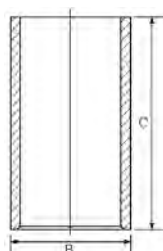

14-024710-00 D B 94.52 C 191.36 D 99.70 E 4.76

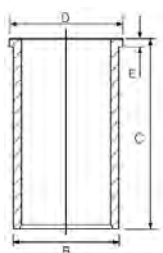

90.47



19

11 L (200TDI)	4cyl.	2495cc	79-85kW (107-116PS)	Diesel	Turbo Intercooled	TD20407
---------------	-------	--------	---------------------	--------	-------------------	---------





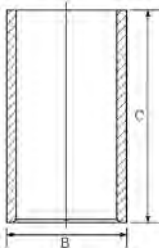
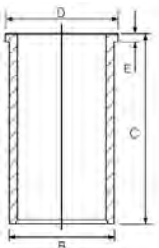

12 L (200TDI)	4cyl.	2495cc	83kW (113PS)	Diesel	Turbo Intercooled	TD20408
14 L (200TDI)	4cyl.	2495cc	83-89kW (113-121PS)	Diesel	Turbo Intercooled	TD19655
DEFENDER 2.5 TDI			08/90→12/98	RANGE ROVER I 2.5 TDi		11/92→04/96
DISCOVERY I 2.5 TDI			10/89→10/98			

87-524400-00 STD  A 55.40 B- 18.85 BØ 39.50 D 91.90  30x77 RT TP	08-524400-00 STD  2.50 CR P 2.00 P 3.00 CR P	14-010920-00 D  B 94.50 C 191.36	
		14-024710-00 D  B 94.52 C 191.36 D 99.70 E 4.76	

90.47						20
12 J	4cyl.	2495cc	51kW (69PS)	Diesel		TD24370
90 I 2.5 D			09/85→08/90	DEFENDER 2.5 D		09/90→07/94
110/127 2.5 D			09/83→07/90			

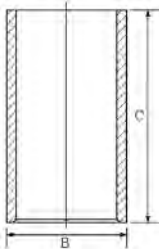
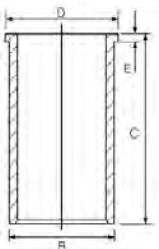
87-714400-00 STD ¹  A 54.60 B- 3.52 D 86.31  30x75 RT	08-714400-00 STD 08-714411-00 .040  2.00 CR P 2.00 P 4.00 CR P	14-010920-00 D  B 94.50 C 191.36	
		14-024710-00 D  B 94.52 C 191.36 D 99.70 E 4.76	

¹ Earlier pistons to be replaced in Engine sets only
 ¹ Frühere Kolben nur in Motorsätzen zu ersetzen
 ¹ Premier piston à remplacer dans le jeu moteur
 ¹ Pistones más antiguos para ser reemplados en juego de motore s solamente
 ¹ Con i pistone di vecchia versione è necessario sostituire tu tta la serie

90.47						21
16 L (300TDI)	4cyl.	2495cc	83kW (113PS)	Diesel	Turbo Intercooled	TD20411
17 L (300TDI)	4cyl.	2495cc	83-90kW (113-122PS)	Diesel	Turbo Intercooled	TD20412





19 L (300TDI)	4cyl.	2495cc	81-90kW (110-122PS)	Diesel	Turbo Intercooled	TD20409
21 L (300TDI)	4cyl.	2495cc	83-89kW (113-121PS)	Diesel	Turbo Intercooled	TD20410
22 L (300TDI)	4cyl.	2496cc	83-92kW (113-125PS)	Diesel	Turbo Intercooled	TD20413
23 L (300TDI)	4cyl.	2495cc	83-86kW (113-117PS)	Diesel	Turbo Intercooled	TD20406
DEFENDER 2.5 TD			08/98→12/05		DISCOVERY I 2.5 TDi	10/89→10/98
DEFENDER 2.5 TDi			08/90→12/98		RANGE ROVER I 2.5 TDi	11/92→04/96
DISCOVERY I 2.5 D			10/93→12/98			

87-521800-20 STD
87-521807-20 .020
87-521811-20 .040

A 55.40
B- 18.45
BØ 39.00
D 91.90
E 30x77



RT TP

08-521800-20 STD
08-521807-20 .020
08-521811-20 .040

3.00
2.50
3.00 CR



14-010920-00 D B 94.50 C 191.36

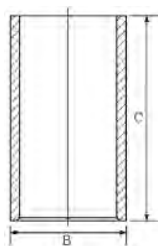

14-024710-00 D B 94.52 C 191.36 D 99.70 E 4.76

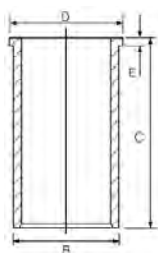

92.00

22

11 A (VM492HT)	4cyl.	2376cc	78-89kW (106-121PS)	Diesel	Turbo	TD22936
RANGE ROVER I 2.4 TD			10/85→07/94			

15-676420-00 WH 1 B 101.50 C 166.80 D 110.00 E 8.90 F 1.20
14-676420-00 WH B 101.50 C 166.80 D 110.00 E 8.90 F 1.20

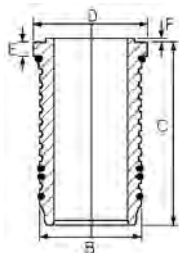

1 Includes seals

1 Schließt Dichtungen ein

1 Inclut des joints

1 Incluye los sellos

1 Comprende le guarnizioni



94.00

23

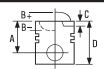

46 D	V8cyl.	4553cc	165-168kW (224-228PS)	Petrol		TD22931
DISCOVERY II 4.6			09/99→12/02		RANGE ROVER II 4.6	07/94→03/02





<p>87-521500-10 STD ①</p> <p>A 35.90 B- 5.83 BØ 77.00 D 66.35  24x60</p>  <p>① High Compression ② Steel</p>	<p>08-521500-00 STD</p> <p>1.20 1.50 3.00</p>  CR ② <p>① Une forte compression ② Acier</p>		
---	---	--	--

	94.00	24
V8	V8cyl. 3950cc	Petrol
RANGE ROVER 4.0 V8		09/94→
		MP6884

<p>87-521500-00 STD ①</p> <p>A 35.90 B- 3.38 BØ 77.00 D 66.35  24x60</p>  <p>① High Compression ② Steel</p>	<p>08-521500-00 STD</p> <p>1.20 1.50 3.00</p>  CR ② <p>① Une forte compression ② Acier</p>		
--	---	--	--

ENGINE INDEX

Motorverzeichnis • Index de moteur • Índice de Motor
 Indeks silnika • Модель Двигателя • دليل المحرك



CCM

x



9

3.5L CARBURETTOR	Petrol	3528	V8	88.86	2
12J	Diesel	2494	4	90.47	3
EN 55	Diesel	2498	4	94.00	5
ET 70 (XD3T)	Diesel	2496	4	94.00	6
R425	Diesel	2499	4	92.00	4
SC25R136Q4	Diesel	2499	4	92.00	4
SC25R136Q5	Diesel	2499	4	92.00	4
VM39C	Diesel	2499	4	92.00	4
VM40C	Diesel	2499	4	92.00	4
VMR425	Diesel	2499	4	92.00	4
XD3	Diesel	2498	4	94.00	7
XD3P	Diesel	2498	4	94.00	7
XUD9	Diesel	1905	4	83.00	1
XUD9B (Pilot)	Diesel	1905	4	83.00	1



83.00 **1**

XUD9	4cyl.	1905cc	47-52kW (64-71PS)	Diesel	TD26905
XUD9B (Pilot)	4cyl.	1905cc		Diesel	MP3219-1
200 1.9 D		10/94→03/96		PILOT 1.9 D	04/96→10/05

87-152000-10 STD
87-152007-10 0.50mm
87-152010-10 0.80mm

A 46.80
B- 2.20
D 84.30
F 25x72

08-152000-00 STD
08-152003-00 0.125mm
08-152007-00 0.50mm
08-152010-00 0.80mm

2.00 CR P
 2.00 P
 3.00 CR P

14-020530-00 D **B** 85.60 **C** 153.50 **D** 88.50 **E** 3.90

88.86 **2**

3.5L CARBURETTOR	V8cyl.	3528cc		Petrol	MP2683
SHERPA		11/85→12/89			

87-520100-00 STD
87-520107-00 .020

A 47.37
B- 5.26
BØ 71.12
D 77.09
F 22x73

08-520100-00 STD
08-520107-00 .020

1.58 CR P
 1.58 P
 4.73 P

90.47 **3**

12J	4cyl.	2494cc		Diesel	MP3610-1
SHERPA		01/84→12/89			

87-714400-00 STD 1

A 54.60
B- 3.52
D 86.31
F 30x75
RT

08-714400-00 STD
08-714411-00 .040

2.00 CR P
 2.00 P
 4.00 CR P

14-010920-00 D **B** 94.50 **C** 191.36

14-024710-00 D **B** 94.52 **C** 191.36 **D** 99.70 **E** 4.76

1 Earlier pistons to be replaced in Engine sets only
 1 Frühere Kolben nur in Motorsätzen zu ersetzen
 1 Premier piston à remplacer dans le jeu moteur
 1 Pistones más antiguos para ser reemplados en juego de motore solamente
 1 Con i pistone di vecchia versione è necessario sostituire tu tta la serie



92.00					4
R425	4cyl.	2499cc		Diesel	MP12303-1
SC25R136Q4	4cyl.	2499cc	100kW (136PS)	Diesel Turbo Intercooled	TD32070
SC25R136Q5	4cyl.	2499cc	100kW (136PS)	Diesel Turbo Intercooled	TD35042
VM39C	4cyl.	2499cc	70-88kW (95-120PS)	Diesel	TD26107
VM40C	4cyl.	2499cc	70kW (95PS)	Diesel Turbo	TD26108
VMR425	4cyl.	2499cc	70-99kW (95-135PS)	Diesel Turbo Intercooled	TD35043
MAXUS 2.5 D			02/05→12/09	V80 2.5 D	02/13→
MAXUS 2.5D			02/05→		

87-429200-00 STD

A 55.00
B- 18.00
BØ 44.00
D 83.00
 32x68





AK KK RT TP

08-429200-00 STD

2.50  GDC P
 1.50  P
 2.00  NT



94.00					5
EN 55	4cyl.	2498cc	53-56kW (72-76PS)	Diesel	TD22927
400 2.5 D			04/89→10/96	CONVOY 2.5 DI	10/98→04/09
CONVOY 2.5 D			04/96→02/02		

87-318700-00 STD 
87-318706-00 0.40mm 
87-318708-00 0.60mm 
87-318711-00 1.00mm 



A 57.42
B- 2.00
D 99.90
 30x79

08-318700-10 STD
08-318706-10 0.40mm
08-318708-10 0.60mm
08-318711-10 1.00mm

2.00  CR P
 2.00  P
 4.00  CR P

14-020660-00 D **B** 97.00 **C** 170.60 **D** 99.50 **E** 4.00
14-021520-00 D **B** 98.00 **C** 170.60 **D** 100.00 **E** 6.00

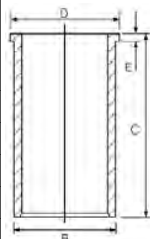

 Pistons to be replaced in Engine Sets only  Kolben nur in Motorsätzen zu ersetzen  Piston à remplacer dans jeu moteur  Pistones de repuesto para juegos de motores solamente  Il pistone può essere rimpiazzato solamente completo

94.00					6
ET 70 (XD3T)	4cyl.	2496cc	71-74kW (96-101PS)	Diesel Turbo Intercooled	TD22928
400 2.5 D			04/89→03/96	CONVOY 2.5 D	04/96→06/06
400 2.5 TD			11/95→10/98	CONVOY 2.5 TDI	10/98→04/09

14-020660-00 D **B** 97.00 **C** 170.60 **D** 99.50 **E** 4.00
14-021520-00 D **B** 98.00 **C** 170.60 **D** 100.00 **E** 6.00

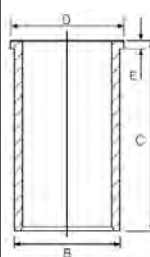

94.00					7
XD3	4cyl.	2498cc		Diesel	MP2303-2







XD3P 4cyl. **2498cc** Diesel **MP2303-1**



CONVOY

87-318700-10 STD
87-318706-10 0.40mm
 →12/93

A 54.00
B- 1.80
D 96.42
 30x79



08-318700-10 STD
08-318706-10 0.40mm
08-318708-10 0.60mm
08-318711-10 1.00mm

2.00  CR P
 2.00  P
 4.00  CR P

14-020660-00 D **B** 97.00 **C** 170.60 **D** 99.50 **E** 4.00
14-021520-00 D **B** 98.00 **C** 170.60 **D** 100.00 **E** 6.00

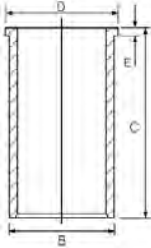



87-318700-30 STD
87-318710-30 0.80mm
 01/94→

A 54.00
B- 1.75
D 91.42
 30x79



08-318700-10 STD
08-318706-10 0.40mm
08-318708-10 0.60mm
08-318711-10 1.00mm

2.00  CR P
 2.00  P
 4.00  CR P

ENGINE INDEX

Motorverzeichnis • Index de moteur • Índice de Motor
 Indeks silnika • Модель Двигателя • دليل المحرك



CCM
x

9

4/98 DT	Diesel	3770	4	98.00	2
4/98 NT	Diesel	3770	4	98.00	3
4/98 NV	Diesel	3771	4	98.00	3
4/98 TT	Diesel	3770	4	98.00	2
4/98 TV	Diesel	3770	4	98.00	2
4.212	Diesel	3470	4	98.48	4
6/98 DT	Diesel	5650	6	98.00	3
6/98 DV	Diesel	5655	6	98.00	3
6/98 E	Diesel	5650	6	98.00	2
6/98 NT	Diesel	5650	6	98.00	3
6/98 NV	Diesel	5655	6	98.00	3
6/98 TV	Diesel	5650	6	98.00	2
22 UA	Diesel	2178	4	82.55	1
57J	Diesel	5655	6	100.00	6
57JC	Diesel	5655	6	100.00	6
57VD	Diesel	5655	6	100.00	6
6.354.2	Diesel	5800	6	98.48	4
6.354.4	Diesel	5800	6	98.48	5
KT 191	Diesel	11627	6	130.00	7
OEJ	Diesel	5655	6	100.00	6
WS 225 ATI	Diesel	11630	6	130.00	8
WS 259 ATI	Diesel	11630	6	130.00	8
WS 282 ATI	Diesel	11630	6	130.00	8

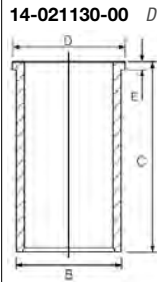

82.55					1
22 UA	4cyl.	2178cc	Diesel		MP101-1
INDUSTRIAL, TRUCK & BUS					



14-021130-00 *D* **B 86.59 C 193.68 D 89.61 E 4.70**

98.00					2
4/98 DT	4cyl.	3770cc	Diesel	Turbo	MP3751
4/98 TT	4cyl.	3770cc	Diesel	Turbo	MP6804
4/98 TV	4cyl.	3770cc	Diesel	Turbo	MP3750
6/98 E	6cyl.	5650cc	Diesel		MP2794
6/98 TV	6cyl.	5650cc	Diesel	Turbo	MP3748
AGRICULTURAL			INDUSTRIAL, TRUCK & BUS		

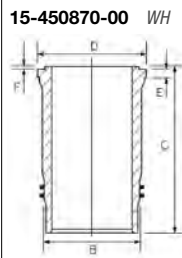

15-450870-00 *WH* **B 108.18 C 218.36 D 117.09 E 8.89 F 0.88**

Includes seals Schließt Dichtungen ein Inclut des joints Incluye los sellos Comprende le guarnizioni

98.00					3
4/98 NT	4cyl.	3770cc	Diesel	Turbo	MP6803
4/98 NV	4cyl.	3771cc	46-55kW (63-75PS)	Diesel	TD7513
6/98 DT	6cyl.	5650cc	Diesel		MP6806
6/98 DV	6cyl.	5655cc	71-84kW (97-114PS)	Diesel	TD7488
6/98 NT	6cyl.	5650cc	Diesel		MP6806-1
6/98 NV	6cyl.	5655cc	71-86kW (97-117PS)	Diesel	TD7490
AGRICULTURAL					

87-525300-00 *STD*

- A** 68.21
- B-** 25.00
- BØ** 56.00
- C** 2.40
- C** 0.01
- D** 116.31
-  35x83



08-525300-00 *STD*

- 2.38  CR P
- 2.38  P
- 2.38  P
- 6.35  P
- 4.76  P

15-450870-00 *WH*

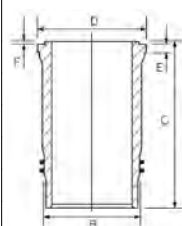

B 108.18 C 218.36 D 117.09 E 8.89 F 0.88

89-525300-00
87-525300-00 +
15-450870-00

Includes seals Schließt Dichtungen ein Inclut des joints Incluye los sellos Comprende le guarnizioni

98.48					4
4.212	4cyl.	3470cc	Diesel		MP1359
6.354.2	6cyl.	5800cc	Diesel		MP1364
INDUSTRIAL, TRUCK & BUS					





14-040200-00 *DH* ① **B 103.19 C 227.28 D 106.45 E 3.86 F 0.88**
 14-045820-00 *D* **B 103.33 C 227.28 D 106.42 E 3.80 F 0.90**
 14-045821-00 *D* **B 103.83 C 227.28 D 106.42 E 3.80 F 0.90**

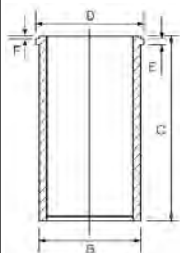

- ① Press fit cast iron liner to replace original steel liner
- ① Anpressbare Laufbuchse aus Gusseisen als Ersatz der original Stahlbüchse
- ① Chemise fonte à emmancher à la presse pour remplacer la che mise d'origine en acier
- ① Ajuste a presión la camisa de hierro fundido para reemplazar la camisa original de acero
- ① Canna in ghisa per sostituire canne originali in acciaio





98.48 **5**
6.354.4 6cyl. **5800cc** **Diesel** **MP1367**
 INDUSTRIAL, TRUCK & BUS

87-525200-00 *STD* ① ② ③

A 69.91
B- 25.61
BØ 53.90
D 120.71
 35x84



08-525200-00 *STD*

2.38  CR P
 2.38  P
 2.38  P
 6.35  P
 6.35  P

14-040200-00 *DH* ④
 14-045820-00 *D*
 14-045821-00 *D*

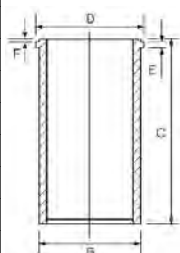

B 103.19 C 227.28 D 106.45 E 3.86 F 0.88
B 103.33 C 227.28 D 106.42 E 3.80 F 0.90
B 103.83 C 227.28 D 106.42 E 3.80 F 0.90

- ① Pre-topped piston which may require machining
- ① Vorgeschliffener Kolben, der möglicherweise gemäß den Empfehlungen des Herstellers bearbeitet werden muss
- ① Piston à tete semie finie pour ant nécessiter un usinage pou aux recommandations du constructeur.
- ① Pistón coronado que puede necesitar fresado para ajustarse a del fabricante.
- ① Il pistone a testa ribassata puo' richiedere una lavorazione adattar loalle prescrizioni del costruttore. fare riferiment alle istruzioni contenute nella confezione.
- ② For Cast Iron Bores only
- ② Nur für Gußeisenbohrungen
- ② Pour intérieur cylindre seulement
- ② Para diámetro internos de hierro fundido solamente
- ② Solo per cilindri in ghisa
- ③ Recommended maximum oversize is .040in/1.016mm
- ③ Empfohlenes Übermaß max .040in/1.016mm
- ③ Cote maxi recommandée de .040in/1.016mm
- ③ La sobremedida máxima recomendada es de .040in/1.016mm
- ③ Maggiorazione massima raccomandata .040in/1.016mm
- ④ Press fit cast iron liner to replace original steel liner
- ④ Anpressbare Laufbuchse aus Gusseisen als Ersatz der original Stahlbüchse
- ④ Chemise fonte à emmancher à la presse pour remplacer la che mise d'origine en acier
- ④ Ajuste a presión la camisa de hierro fundido para reemplazar la camisa original de acero
- ④ Canna in ghisa per sostituire canne originali in acciaio

100.00 **6**
57J 6cyl. **5655cc** **Diesel** **MP1012**
57JC 6cyl. **5655cc** **Diesel** **MP1012-1**
57VD 6cyl. **5655cc** **Diesel** **MP1012-2**
OEJ 6cyl. **5655cc** **Diesel** **MP116**
 INDUSTRIAL, TRUCK & BUS

15-450870-00 *WH* ① **B 108.18 C 218.36 D 117.09 E 8.89 F 0.88**

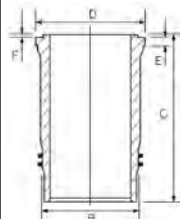

- ① Includes seals
- ① Schließt Dichtungen ein
- ① Inclut des joints
- ① Incluye los sellos
- ① Comprende le guarnizioni



130.00 **7**

KT 191 6cyl. **11627cc** **256kW** (348PS) **Diesel** **Turbo Intercooled** **MP5278-1**

INDUSTRIAL, TRUCK & BUS

87-174100-00 STD
01/89→

- A** 101.00
- B-** 29.30
- BØ** 74.50
- C** 3.00
- D** 169.50
- 48x111**

AK HA RT



08-174100-10 STD

- 3.16 CR P
- 3.16 CR P
- 6.33 CR P

14-021410-00 DH

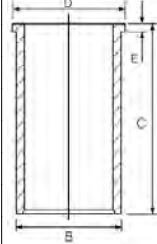

B 136.02 **C** 288.30 **D** 143.60 **E** 10.05

130.00 **8**

WS 225 ATI 6cyl. **11630cc** **225kW** (306PS) **Diesel** **Turbo Intercooled** **TD7533**

WS 259 ATI 6cyl. **11630cc** **259kW** (352PS) **Diesel** **Turbo Intercooled** **TD7534**

WS 282 ATI 6cyl. **11630cc** **282kW** (383PS) **Diesel** **Turbo Intercooled** **TD7535**

INDUSTRIAL, TRUCK & BUS

14-021410-00 DH

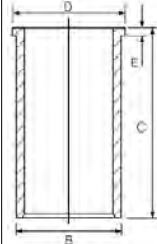

B 136.02 **C** 288.30 **D** 143.60 **E** 10.05

ENGINE INDEX

Motorverzeichnis • Index de moteur • Índice de Motor
 Indeks silnika • Модель Двигателя • دليل المحرك



CCM

x



9

PH1	Diesel	659	1	87.32	1
PH1W	Diesel	659	1	87.32	1
PH2	Diesel	1318	2	87.32	1
PH2W	Diesel	1318	2	87.32	1
ST1	Diesel	630	1	95.25	2
ST2	Diesel	1270	2	95.25	2
ST3	Diesel	1900	3	95.25	2
TS1	Diesel	635	1	95.25	2
TS2	Diesel	1270	2	95.25	2
TS3	Diesel	1900	3	95.25	2



87.32 **1**

PH1	1cyl.	659cc	Diesel	MP2516
PH1W	1cyl.	659cc	Diesel	MP3855
PH2	2cyl.	1318cc	Diesel	MP3856
PH2W	2cyl.	1318cc	Diesel	MP3857



INDUSTRIAL

87-525000-00 *STD*
 87-525007-00 *.020*
 87-525011-00 *.040*
 87-525014-00 *.060*

08-525000-00 *STD*
 08-525007-00 *.020*
 08-525011-00 *.040*
 08-525014-00 *.060*

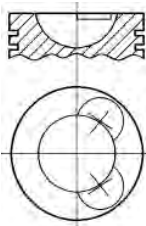
A 63.60
B- 25.10
C 0.61
C 0.61
D 105.99
 30x75



2.38  CR
 2.38  CR
 2.38  CR
 4.76  P

95.25 **2**

ST1	1cyl.	630cc	Diesel	MP965
ST2	2cyl.	1270cc	Diesel	MP5323
ST3	3cyl.	1900cc	Diesel	MP5324
TS1	1cyl.	635cc	Diesel	MP3398
TS2	2cyl.	1270cc	Diesel	MP5325
TS3	3cyl.	1900cc	Diesel	MP5326



INDUSTRIAL

87-523800-00 *STD*
 87-523807-00 *.020*
 87-523811-00 *.040*

08-523800-00 *STD*
 08-523807-00 *.020*
 08-523811-00 *.040*

A 65.09
B- 16.14
BØ 44.96
D 103.19
 33x79



3.18  CR
 2.39  CR
 4.75  CR
 4.76  CR



80.00 **1**

18 K4F (K Series) 4cyl. **1796cc** **85-101kW** (116-137PS) **Petrol** **TD18865**

ELISE 1.8 08/95→08/05

<p>87-522700-00 <i>STD</i></p> <p>A 22.70 B- 0.53 BØ 68.20 C 2.65 D 45.65 18x53 TP</p>	<p>08-522700-00 <i>STD</i></p> <p>1.00 CR <input type="checkbox"/> 1.20 P 2.00 CR <input type="checkbox"/></p>	<p>14-710020-00 <i>WH</i></p> <p>B 84.10 C 129.50 D 87.50 E 50.00</p>	<p>88-522700-00 87-522700-00 + 14-710020-00</p>
--	---	--	--

Steel Stahl Acier Acero Acciaio

80.00 **2**

18 K4K (VVC) (K Series) 4cyl. **1796cc** **107-142kW** (146-160PS) **Petrol** **TD22926**

ELISE 1.8 11/98→01/01 ELISE 111 S 03/99→11/00

<p>87-522700-10 <i>STD</i></p> <p>A 22.70 B- 0.53 BØ 68.00 C 1.00 D 45.65 18x53 TP</p>	<p>08-522700-00 <i>STD</i></p> <p>1.00 CR <input type="checkbox"/> 1.20 P 2.00 CR <input type="checkbox"/></p>	<p>14-710020-00 <i>WH</i></p> <p>B 84.10 C 129.50 D 87.50 E 50.00</p>	
--	---	--	--

Steel Stahl Acier Acero Acciaio



92.00 **1**

R425 DOHC 4cyl. **2499cc** **75-125kW** (102-170PS) **Diesel** **Turbo Intercooled** **TD29444**

TX 2.5 TD 01/06 →

87-429200-00 STD

- A 55.00
- B- 18.00
- BØ 44.00
- D 83.00
-  32x68



AK KK RT TP

08-429200-00 STD

- 2.50  GDC P
- 1.50  P
- 2.00  NT



96.00 **2**

TD27 4cyl. **2664cc** **60-73kW** (82-99PS) **Diesel** **TD20022**

TX 2.7 TD 01/97 →

14-020110-00 D

B 99.08 C 160.00 D 105.03 E 5.09

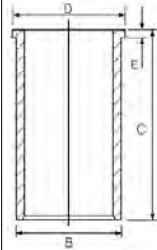

ENGINE INDEX

Motorverzeichnis • Index de moteur • Índice de Motor
 Indeks silnika • Модель Двигателя • دليل المحرك



CCM

x



9

D 0824 FL01 (Euro 1)	Diesel	4580	4	108.00	1
D 0824 GF	Diesel	4580	4	108.00	2
D 0824 GF01	Diesel	4580	4	108.00	2
D 0824 GF02 (Euro 1)	Diesel	4580	4	108.00	1
D 0824 GF03 (Euro 1)	Diesel	4580	4	108.00	1
D 0824 LF01 (Euro 1)	Diesel	4580	4	108.00	3
D 0824 LF02 (Euro 2)	Diesel	4580	4	108.00	4
D 0824 LF03 (Euro 1)	Diesel	4580	4	108.00	3
D 0824 LF04 (Euro 1)	Diesel	4580	4	108.00	3
D 0824 LF05 (Euro 1)	Diesel	4580	4	108.00	3
D 0824 LF06 (Euro 1)	Diesel	4580	4	108.00	3
D 0824 LF07 (Euro 1)	Diesel	4580	4	108.00	3
D 0824 LF08 (Euro 1)	Diesel	4580	4	108.00	3
D 0824 LF09 (Euro 1)	Diesel	4580	4	108.00	3
D 0824 LF10 (Euro 1)	Diesel	4580	4	108.00	3
D 0824 LF/D/LFL (Euro 1)	Diesel	4580	4	108.00	1
D 0824 LF/D/LFL (Euro 2)	Diesel	4580	4	108.00	1
D 0824 LFL01 (Euro 1)	Diesel	4580	4	108.00	3
D 0824 LFL02 (Euro 2)	Diesel	4580	4	108.00	4
D 0824 LFL04 (Euro 2)	Diesel	4580	4	108.00	4
D 0824 LFL05 (Euro 1)	Diesel	4580	4	108.00	3
D 0824 LFL06 (Euro 2)	Diesel	4580	4	108.00	4
D 0824 LFL07 (Euro 2)	Diesel	4580	4	108.00	4
D 0824 LFL08 (Euro 2)	Diesel	4580	4	108.00	4
D 0824 LFL09 (Euro 1)	Diesel	4580	4	108.00	3
D 0824 LFL10 (Euro 2)	Diesel	4580	4	108.00	4
D 0824 LFO (Euro 1)	Diesel	4580	4	108.00	1
D 0824 LFO01 (Euro 1)	Diesel	4580	4	108.00	4
D 0824 LOH01 (Euro 1)	Diesel	4580	4	108.00	3
D 0824 LOH02 (Euro 1)	Diesel	4580	4	108.00	4
D 0824 LOH03 (Euro 1)	Diesel	4580	4	108.00	4
D 0824 LOH04 (Euro 1)	Diesel	4580	4	108.00	4
D 0824 LOH05 (Euro 2)	Diesel	4580	4	108.00	4
D 0826 F01	Diesel	6871	6	108.00	2
D 0826 F02	Diesel	6871	6	108.00	2
D 0826 FG001	Diesel	6871	6	108.00	3
D 0826 FG002	Diesel	6871	6	108.00	3
D 0826 FO	Diesel	6871	6	108.00	2
D 0826 FO01	Diesel	6871	6	108.00	2
D 0826 FO02	Diesel	6871	6	108.00	2
D 0826 FR	Diesel	6871	6	108.00	2
D 0826 FR01	Diesel	6871	6	108.00	2
D 0826 GF	Diesel	6871	6	108.00	2
D 0826 GF01 (Euro 1)	Diesel	6871	6	108.00	1
D 0826 GF02	Diesel	6871	6	108.00	1
D 0826 GF03	Diesel	6871	6	108.00	1
D 0826 GF04 (Euro 1)	Diesel	6871	6	108.00	2
D 0826 GFA	Diesel	6871	6	108.00	2
D 0826 GFA03	Diesel	6871	6	108.00	2
D 0826 GFA04 (Euro 1)	Diesel	6871	6	108.00	2
D 0826 LE51	Diesel	6871	6	108.00	1
D 0826 LE52	Diesel	6871	6	108.00	1
D 0826 LE521	Diesel	6871	6	108.00	3
D 0826 LE522 (Euro 1)	Diesel	6871	6	108.00	1
D 0826 LE523 (Euro 1)	Diesel	6871	6	108.00	1
D 0826 LE524 (Euro 1)	Diesel	6871	6	108.00	1
D 0826 LE530 (Euro 1)	Diesel	6871	6	108.00	1
D 0826 LE531 (Euro 1)	Diesel	6871	6	108.00	1
D 0826 LF	Diesel	6590	6	108.00	1
D 0826 LF (Euro 1)	Diesel	6870	6	108.00	1



CCM



9

D 0826 LF01	Diesel	6871	6	108.00	3
D 0826 LF02 (Euro 1)	Diesel	6871	6	108.00	3
D 0826 LF04 (Euro 1)	Diesel	6871	6	108.00	3
D 0826 LF05	Diesel	6871	6	108.00	3
D 0826 LF06	Diesel	6871	6	108.00	3
D 0826 LF07 (Euro 1)	Diesel	6871	6	108.00	3
D 0826 LF08 (Euro 1)	Diesel	6871	6	108.00	3
D 0826 LF09 (Euro 1)	Diesel	6871	6	108.00	1
D 0826 LF11 (Euro 2)	Diesel	6871	6	108.00	4
D 0826 LF12 (Euro 2)	Diesel	6871	6	108.00	1
D 0826 LF13 (Euro 2)	Diesel	6871	6	108.00	1
D 0826 LF15 (Euro 2)	Diesel	6871	6	108.00	4
D 0826 LF17 (Euro 2)	Diesel	6871	6	108.00	4
D 0826 LF18 (Euro 2)	Diesel	6871	6	108.00	3
D 0826 LF/217/SILENT	Diesel	6870	6	108.00	1
D 0826 LFG15 (Euro 2)	Diesel	6871	6	108.00	4
D 0826 LFG16 (Euro 2)	Diesel	6871	6	108.00	4
D 0826 LFL (Euro 1)	Diesel	6871	6	108.00	3
D 0826 LFL02 (Euro 1)	Diesel	6871	6	108.00	3
D 0826 LFL03 (Euro 1)	Diesel	6871	6	108.00	3
D 0826 LFL05 (Euro 1)	Diesel	6871	6	108.00	3
D 0826 LFL06 (Euro 1)	Diesel	6871	6	108.00	3
D 0826 LFL07 (Euro 1)	Diesel	6871	6	108.00	3
D 0826 LFL08 (Euro 1)	Diesel	6871	6	108.00	3
D 0826 LFL09 (Euro 2)	Diesel	6871	6	108.00	4
D 0826 LFL10 (Euro 1)	Diesel	6871	6	108.00	3
D 0826 LFOH	Diesel	6871	6	108.00	1
D 0826 LOH	Diesel	6590	6	108.00	1
D 0826 LOH (Euro 2)	Diesel	6870	6	108.00	1
D 0826 LOH01	Diesel	6871	6	108.00	1
D 0826 LOH02	Diesel	6871	6	108.00	1
D 0826 LOH03	Diesel	6871	6	108.00	1
D 0826 LOH04	Diesel	6871	6	108.00	3
D 0826 LOH05	Diesel	6871	6	108.00	3
D 0826 LOH06 (Euro 1)	Diesel	6871	6	108.00	3
D 0826 LOH07 (Euro 1)	Diesel	6871	6	108.00	1
D 0826 LOH10 (Euro 1)	Diesel	6871	6	108.00	1
D 0826 LOH15 (Euro 2)	Diesel	6871	6	108.00	4
D 0826 LOH17 (Euro 2)	Diesel	6871	6	108.00	4
D 0826 LOH18 (Euro 2)	Diesel	6871	6	108.00	4
D 0826 LOH19 (Euro 2)	Diesel	6871	6	108.00	4
D 0826 LUE51 (Euro 1)	Diesel	6870	6	108.00	1
D 0826 LUH (Euro 1)	Diesel	6870	6	108.00	3
D 0826 LUH (Euro 2)	Diesel	6870	6	108.00	1
D 0826 LUH01 (Euro 1)	Diesel	6871	6	108.00	3
D 0826 LUH02 (Euro 1)	Diesel	6871	6	108.00	3
D 0826 LUH03 (Euro 1)	Diesel	6871	6	108.00	3
D 0826 LUH04	Diesel	6871	6	108.00	3
D 0826 LUH05 (Euro 1)	Diesel	6871	6	108.00	3
D 0826 LUH06 (Euro 1)	Diesel	6871	6	108.00	3
D 0826 LUH08 (Euro 2)	Diesel	6871	6	108.00	1
D 0826 LUH09 (Euro 2)	Diesel	6871	6	108.00	1
D 0826 LUH10 (Euro 1)	Diesel	6871	6	108.00	3
D 0826 LUH11 (Euro 2)	Diesel	6871	6	108.00	4
D 0826 LUH12 (Euro 1)	Diesel	6870	6	108.00	3
D 0826 LUH13 (Euro 2)	Diesel	6871	6	108.00	4
D 0826 LUH/213	Diesel	6871	6	108.00	4
D 0826 OH	Diesel	6871	6	108.00	9
D 0826 OH01	Diesel	6871	6	108.00	2
D 0826 OH02	Diesel	6871	6	108.00	2

ENGINE INDEX

Motorverzeichnis • Index de moteur • Índice de Motor
 Indeks silnika • Модель Двигателя • دليل المحرك



CCM

x



9

D 0826 OH03 (Euro 1)	Diesel	6871	6	108.00	2
D 0826 TE520	Diesel	6596	6	108.00	3
D 0826 TF	Diesel	6596	6	108.00	1
D 0826 TOH	Diesel	6596	6	108.00	1
D 0826 TUE51	Diesel	6871	6	108.00	1
D 0834 LFL01 (Euro 3)	Diesel	4580	4	108.00	5
D 0834 LFL02 (Euro 3)	Diesel	4580	4	108.00	5
D 0834 LFL03 (Euro 3)	Diesel	4580	4	108.00	5
D 0834 LFL04 (Euro 3)	Diesel	4580	4	108.00	5
D 0834 LFL10 (Euro 3)	Diesel	4580	4	108.00	5
D 0834 LFL11 (Euro 3)	Diesel	4580	4	108.00	5
D 0834 LFL20 (Euro 3)	Diesel	4580	4	108.00	5
D 0834 LFL40 (Euro 3)	Diesel	4580	4	108.00	6
D 0834 LFL41 (Euro 3)	Diesel	4580	4	108.00	6
D 0834 LFL42 (Euro 3)	Diesel	4580	4	108.00	6
D 0834 LFL50 (Euro 4)	Diesel	4580	4	108.00	7
D 0834 LFL51 (Euro 4)	Diesel	4580	4	108.00	7
D 0834 LFL52 (Euro 4)	Diesel	4580	4	108.00	7
D 0834 LFL53 (Euro 4)	Diesel	4580	4	108.00	7
D 0834 LFL54 (Euro 4)	Diesel	4580	4	108.00	7
D 0834 LFL55 (Euro 4)	Diesel	4580	4	108.00	7
D 0834 LFL57 (Euro 4)	Diesel	4580	4	108.00	7
D 0834 LFL60	Diesel	4580	4	108.00	8
D 0834 LFL61	Diesel	4580	4	108.00	8
D 0834 LFL62	Diesel	4580	4	108.00	8
D 0834 LFL63 (Euro 5)	Diesel	4580	4	108.00	8
D 0834 LFL64 (Euro 5)	Diesel	4580	4	108.00	8
D 0834 LFL65 (Euro 5)	Diesel	4580	4	108.00	8
D 0834 LFL66 (Euro 6)	Diesel	4580	4	108.00	8
D 0834 LFL67 (Euro 6)	Diesel	4580	4	108.00	8
D 0834 LFL68 (Euro 6)	Diesel	4580	4	108.00	8
D 0834 LFL75 (Euro 6)	Diesel	4580	4	108.00	8
D 0834 LOH01 (Euro 3)	Diesel	4580	4	108.00	5
D 0834 LOH02 (Euro 3)	Diesel	4580	4	108.00	5
D 0834 LOH03 (Euro 3)	Diesel	4580	4	108.00	5
D 0834 LOH40 (Euro 3)	Diesel	4580	4	108.00	1
D 0834 LOH51 (Euro 4)	Diesel	4580	4	108.00	7
D 0834 LOH52 (Euro 4)	Diesel	4580	4	108.00	7
D 0834 LOH53 (Euro 4)	Diesel	4580	4	108.00	7
D 0834 LOH61 (Euro 5)	Diesel	4580	4	108.00	8
D 0836 LE501	Diesel	6871	6	108.00	5
D 0836 LE503	Diesel	6871	6	108.00	5
D 0836 LE510	Diesel	6871	6	108.00	10
D 0836 LF01 (Euro 2)	Diesel	6871	6	108.00	5
D 0836 LF02 (Euro 3)	Diesel	6871	6	108.00	5
D 0836 LF03 (Euro 3)	Diesel	6871	6	108.00	5
D 0836 LF04 (Euro 3)	Diesel	6871	6	108.00	5
D 0836 LF05 (Euro 3)	Diesel	6871	6	108.00	5
D 0836 LF06 (Euro 3)	Diesel	6871	6	108.00	5
D 0836 LF10 (Euro 3)	Diesel	6871	6	108.00	5
D 0836 LF41 (Euro 3)	Diesel	6871	6	108.00	6
D 0836 LF44 (Euro 3)	Diesel	6871	6	108.00	6
D 0836 LFG50 (Euro 4/5)	Diesel	6871	6	108.00	7
D 0836 LFL01 (Euro 3)	Diesel	6871	6	108.00	5
D 0836 LFL02 (Euro 3)	Diesel	6871	6	108.00	5
D 0836 LFL03 (Euro 3)	Diesel	6871	6	108.00	5
D 0836 LFL04 (Euro 3)	Diesel	6871	6	108.00	5
D 0836 LFL05 (Euro 3)	Diesel	6871	6	108.00	5
D 0836 LFL06 (Euro 3)	Diesel	6871	6	108.00	5
D 0836 LFL07 (Euro 3)	Diesel	6871	6	108.00	5



CCM



9

D 0836 LFL10 (Euro 3)	Diesel	6871	6	108.00	5
D 0836 LFL40 (Euro 3)	Diesel	6871	6	108.00	6
D 0836 LFL41 (Euro 3)	Diesel	6871	6	108.00	6
D 0836 LFL44 (Euro 3)	Diesel	6871	6	108.00	6
D 0836 LFL50 (Euro 4)	Diesel	6871	6	108.00	7
D 0836 LFL51 (Euro 4)	Diesel	6871	6	108.00	7
D 0836 LFL52 (Euro 4)	Diesel	6871	6	108.00	7
D 0836 LFL53 (Euro 4)	Diesel	6871	6	108.00	7
D 0836 LFL54 (Euro 4)	Diesel	6871	6	108.00	7
D 0836 LFL55 (Euro 4)	Diesel	6871	6	108.00	7
D 0836 LFL60	Diesel	6871	6	108.00	8
D 0836 LFL61	Diesel	6871	6	108.00	8
D 0836 LFL62	Diesel	6871	6	108.00	8
D 0836 LFL63 (Euro 5)	Diesel	6871	6	108.00	8
D 0836 LFL64 (Euro 5)	Diesel	6871	6	108.00	8
D 0836 LFL65 (Euro 5)	Diesel	6871	6	108.00	8
D 0836 LFL66 (Euro 6)	Diesel	6871	6	108.00	8
D 0836 LFL67 (Euro 6)	Diesel	6871	6	108.00	8
D 0836 LFL68 (Euro 6)	Diesel	6871	6	108.00	8
D 0836 LFL69 (Euro 5)	Diesel	6871	6	108.00	8
D 0836 LFL70 (Euro 5)	Diesel	6871	6	108.00	8
D 0836 LFL71 (Euro 5)	Diesel	6871	6	108.00	8
D 0836 LFL75 (Euro 6)	Diesel	6871	6	108.00	8
D 0836 LFL76 (Euro 6)	Diesel	6871	6	108.00	8
D 0836 LFL77 (Euro 6)	Diesel	6871	6	108.00	8
D 0836 LOH01 (Euro 3)	Diesel	6871	6	108.00	5
D 0836 LOH02 (Euro 3)	Diesel	6871	6	108.00	5
D 0836 LOH03 (Euro 3)	Diesel	6871	6	108.00	5
D 0836 LOH40 (Euro 3)	Diesel	6871	6	108.00	6
D 0836 LOH41 (Euro 3)	Diesel	6871	6	108.00	6
D 0836 LOH51 (Euro 4)	Diesel	6871	6	108.00	7
D 0836 LOH52 (Euro 4)	Diesel	6871	6	108.00	7
D 0836 LOH55 (Euro 4)	Diesel	6871	6	108.00	7
D 0836 LOH56 (Euro 4)	Diesel	6871	6	108.00	7
D 0836 LOH60	Diesel	6871	6	108.00	7
D 0836 LOH61	Diesel	6871	6	108.00	7
D 0836 LOH62 (Euro 4)	Diesel	6871	6	108.00	7
D 0836 LOH63	Diesel	6871	6	108.00	7
D 0836 LOH64 (Euro 5)	Diesel	6871	6	108.00	8
D 0836 LOH65 (Euro 5)	Diesel	6871	6	108.00	8
D 0836 LOH66 (Euro 6)	Diesel	6871	6	108.00	8
D 0836 LOH67 (Euro 6)	Diesel	6871	6	108.00	8
D 0836 LOH70	Diesel	6871	6	108.00	8
D 0836 LOH71	Diesel	6871	6	108.00	8
D 0836 LOH72 (Euro 6)	Diesel	6871	6	108.00	8
D 0836 LOH73 (Euro 6)	Diesel	6871	6	108.00	8
D 0836 LOH74 (Euro 6)	Diesel	6871	6	108.00	8
D 0836 LUH01 (Euro 3)	Diesel	6871	6	108.00	5
D 0836 LUH02 (Euro 3)	Diesel	6871	6	108.00	5
D 0836 M2	Diesel	7030	6	108.00	11
D 0846 HM2	Diesel	7250	6	108.00	11
D 0846 HM42U	Diesel	7252	6	108.00	11
D 0846 HM81H	Diesel	7252	6	108.00	11
D 0846 HM82U	Diesel	7252	6	108.00	11
D 0846 HM91H	Diesel	7252	6	108.00	11
D 0846 HM91U	Diesel	7250	6	108.00	11
D 0846 HM95U	Diesel	7252	6	108.00	11
D 0846 HMN	Diesel	7252	6	108.00	11
D 0846 HMN2	Diesel	7252	6	108.00	11
D 0846 HMN80	Diesel	7252	6	108.00	11

ENGINE INDEX

Motorverzeichnis • Index de moteur • Índice de Motor
 Indeks silnika • Модель Двигателя • دليل المحرك



CCM

x



9

D 0846 HMX-011	Diesel	7250	6	108.00	11
D 0846 HMXU-015	Diesel	7250	6	108.00	11
D 0846 HMY-011	Diesel	7250	6	108.00	11
D 0846 HMYH	Diesel	7252	6	108.00	11
D 0846 HMYN-014	Diesel	7252	6	108.00	11
D 2066 LF (Euro 2/3)	Diesel	10518	6	120.00	14
D 2066 LF (Euro 3)	Diesel	10518	6	120.00	14
D 2066 LF01 (Euro 3)	Diesel	10518	6	120.00	15
D 2066 LF02 (Euro 3)	Diesel	10518	6	120.00	15
D 2066 LF03 (Euro 3)	Diesel	10518	6	120.00	15
D 2066 LF04 (Euro 3)	Diesel	10518	6	120.00	14
D 2066 LF06 (Euro 3)	Diesel	10518	6	120.00	15
D 2066 LF07 (Euro 3)	Diesel	10518	6	120.00	14
D 2066 LF11 (Euro 4)	Diesel	10518	6	120.00	15
D 2066 LF12 (Euro 4)	Diesel	10518	6	120.00	15
D 2066 LF13 (Euro 4)	Diesel	10518	6	120.00	15
D 2066 LF14 (Euro 4)	Diesel	10518	6	120.00	15
D 2066 LF17 (Euro 5)	Diesel	10518	6	120.00	16
D 2066 LF18 (Euro 5)	Diesel	10518	6	120.00	16
D 2066 LF19 (Euro 5)	Diesel	10518	6	120.00	16
D 2066 LF20 (Euro 5)	Diesel	10518	6	120.00	16
D 2066 LF21 (Euro 5)	Diesel	10518	6	120.00	16
D 2066 LF22 (Euro 5)	Diesel	10518	6	120.00	16
D 2066 LF23 (Euro 5)	Diesel	10518	6	120.00	16
D 2066 LF24 (Euro 5)	Diesel	10518	6	120.00	16
D 2066 LF25 (Euro 5)	Diesel	10518	6	120.00	17
D 2066 LF26 (Euro 5)	Diesel	10518	6	120.00	16
D 2066 LF27 (Euro 5)	Diesel	10518	6	120.00	16
D 2066 LF28 (Euro 5)	Diesel	10518	6	120.00	16
D 2066 LF29 (Euro 4)	Diesel	10518	6	120.00	15
D 2066 LF30 (Euro 4)	Diesel	10518	6	120.00	15
D 2066 LF31 (Euro 4)	Diesel	10518	6	120.00	15
D 2066 LF32 (Euro 4)	Diesel	10518	6	120.00	15
D 2066 LF33 (Euro 4)	Diesel	10518	6	120.00	15
D 2066 LF35 (Euro 4)	Diesel	10518	6	120.00	15
D 2066 LF36 (Euro 4)	Diesel	10518	6	120.00	15
D 2066 LF37 (Euro 4)	Diesel	10518	6	120.00	15
D 2066 LF38 (Euro 4)	Diesel	10518	6	120.00	15
D 2066 LF39 (Euro 4)	Diesel	10518	6	120.00	15
D 2066 LF40 (Euro 5)	Diesel	10518	6	120.00	16
D 2066 LF41 (Euro 5)	Diesel	10518	6	120.00	16
D 2066 LF42 (Euro 5)	Diesel	10518	6	120.00	16
D 2066 LF43 (Euro 5)	Diesel	10518	6	120.00	16
D 2066 LF44 (Euro 5)	Diesel	10518	6	120.00	16
D 2066 LF45 (Euro 5)	Diesel	10518	6	120.00	16
D 2066 LF46 (Euro 5)	Diesel	10518	6	120.00	16
D 2066 LF47 (Euro 5)	Diesel	10518	6	120.00	16
D 2066 LF48 (Euro 3)	Diesel	10518	6	120.00	14
D 2066 LF49 (Euro 3)	Diesel	10518	6	120.00	14
D 2066 LF50 (Euro 3)	Diesel	10518	6	120.00	14
D 2066 LF51 (Euro 5)	Diesel	10518	6	120.00	16
D 2066 LF52 (Euro 5)	Diesel	10518	6	120.00	16
D 2066 LF53 (Euro 5)	Diesel	10518	6	120.00	16
D 2066 LF57	Diesel	10518	6	120.00	18
D 2066 LF58	Diesel	10518	6	120.00	18
D 2066 LF59	Diesel	10518	6	120.00	18
D 2066 LF60	Diesel	10518	6	120.00	18
D 2066 LF61 (Euro 6)	Diesel	10518	6	120.00	19
D 2066 LF62 (Euro 4)	Diesel	10518	6	120.00	15
D 2066 LF63 (Euro 4)	Diesel	10518	6	120.00	15



CCM



9

D 2066 LF64 (Euro 4)	Diesel	10518	6	120.00	15
D 2066 LF65 (Euro 4)	Diesel	10518	6	120.00	15
D 2066 LF67 (Euro 6)	Diesel	10518	6	120.00	19
D 2066 LF69 (Euro 4)	Diesel	10518	6	120.00	15
D 2066 LF70 (Euro 4)	Diesel	10518	6	120.00	15
D 2066 LF71 (Euro 4)	Diesel	10518	6	120.00	15
D 2066 LF72 (Euro 4)	Diesel	10518	6	120.00	15
D 2066 LF76 (Euro 6)	Diesel	10518	6	120.00	19
D 2066 LF77 (Euro 6)	Diesel	10518	6	120.00	19
D 2066 LF80 (Euro 6)	Diesel	10518	6	120.00	19
D 2066 LF83 (Euro 6)	Diesel	10518	6	120.00	19
D 2066 LF85 (Euro 6)	Diesel	10518	6	120.00	19
D 2066 LF92 (Euro 6)	Diesel	10518	6	120.00	19
D 2066 LOH01 (Euro 4)	Diesel	10520	6	120.00	15
D 2066 LOH02 (Euro 4)	Diesel	10518	6	120.00	15
D 2066 LOH03 (Euro 4)	Diesel	10518	6	120.00	15
D 2066 LOH04 (Euro 4)	Diesel	10518	6	120.00	15
D 2066 LOH05 (Euro 4)	Diesel	10518	6	120.00	15
D 2066 LOH06 (Euro 4)	Diesel	10518	6	120.00	15
D 2066 LOH07 (Euro 4)	Diesel	10518	6	120.00	15
D 2066 LOH08 (Euro 4)	Diesel	10518	6	120.00	15
D 2066 LOH10 (Euro 3)	Diesel	10518	6	120.00	14
D 2066 LOH11 (Euro 3)	Diesel	10518	6	120.00	14
D 2066 LOH12 (Euro 3)	Diesel	10518	6	120.00	14
D 2066 LOH26	Diesel	10518	6	120.00	18
D 2066 LOH27	Diesel	10518	6	120.00	18
D 2066 LOH28 (Euro 5)	Diesel	10518	6	120.00	16
D 2066 LOH31 (Euro 6)	Diesel	10518	6	120.00	19
D 2066 LOH32 (Euro 6)	Diesel	10518	6	120.00	19
D 2066 LOH33 (Euro 4)	Diesel	10518	6	120.00	15
D 2066 LOH34 (Euro 4)	Diesel	10518	6	120.00	15
D 2066 LOH35 (Euro 4)	Diesel	10518	6	120.00	15
D 2066 LOH36 (Euro 4)	Diesel	10518	6	120.00	15
D 2066 LUH01 (Euro 4)	Diesel	10520	6	120.00	15
D 2066 LUH07 (Euro 3)	Diesel	10520	6	120.00	14
D 2066 LUH08 (Euro 3)	Diesel	10520	6	120.00	14
D 2066 LUH09 (Euro 3)	Diesel	10520	6	120.00	14
D 2066 LUH11 (Euro 4)	Diesel	10520	6	120.00	15
D 2066 LUH12 (Euro 4)	Diesel	10520	6	120.00	15
D 2066 LUH13 (Euro 4)	Diesel	10520	6	120.00	15
D 2066 LUH14 (Euro 4)	Diesel	10520	6	120.00	15
D 2066 LUH15 (Euro 4)	Diesel	10520	6	120.00	15
D 2066 LUH21 (Euro 4)	Diesel	10518	6	120.00	15
D 2066 LUH22 (Euro 4)	Diesel	10518	6	120.00	15
D 2066 LUH23 (Euro 4)	Diesel	10518	6	120.00	15
D 2066 LUH24 (Euro 4)	Diesel	10518	6	120.00	15
D 2066 LUH30 (Euro 6)	Diesel	10518	6	120.00	19
D 2066 LUH31 (Euro 6)	Diesel	10518	6	120.00	19
D 2066 LUH32 (Euro 5)	Diesel	10518	6	120.00	16
D 2066 LUH33 (Euro 5)	Diesel	10518	6	120.00	16
D 2066 LUH34 (Euro 5)	Diesel	10518	6	120.00	16
D 2066 LUH41	Diesel	10518	6	120.00	20
D 2066 LUH42	Diesel	10518	6	120.00	20
D 2066 LUH43	Diesel	10518	6	120.00	20
D 2066 LUH46	Diesel	10518	6	120.00	20
D 2066 LUH47	Diesel	10518	6	120.00	20
D 2066 LUH48	Diesel	10518	6	120.00	20
D 2066 LUH52 (Euro 6)	Diesel	10518	6	120.00	19
D 2066 LUH53 (Euro 6)	Diesel	10518	6	120.00	19
D 2146	Diesel	9660	6	121.00	21

ENGINE INDEX

Motorverzeichnis • Index de moteur • Índice de Motor
 Indeks silnika • Модель Двигателя • دليل المحرك



CCM

x



9

D 2156 HM2	Diesel	10344	6	121.00	21
D 2156 HM3	Diesel	10344	6	121.00	21
D 2156 HM9	Diesel	10344	6	121.00	21
D 2156 HMN1	Diesel	10344	6	121.00	21
D 2156 HMN6	Diesel	10344	6	121.00	21
D 2156 HNY	Diesel	10344	6	121.00	21
D 2156 MGN	Diesel	10344	6	121.00	21
D 2156 MNY	Diesel	10344	6	121.00	21
D 2156 MTN1	Diesel	10344	6	121.00	21
D 2156 MTX	Diesel	10344	6	121.00	21
D 2156 MY	Diesel	10344	6	121.00	21
D 2156 MYN	Diesel	10344	6	121.00	21
D 2156 MYN-31	Diesel	10344	6	121.00	21
D 2530 ME	Diesel	15945	V10	125.00	25
D 2530 MF	Diesel	15945	V10	125.00	25
D 2530 MTE	Diesel	15953	V10	125.00	25
D 2530 MTXF	Diesel	15953	V10	125.00	25
D 2530 MTXF/360	Diesel	15900	V10	125.00	25
D 2530 MXF	Diesel	15945	V10	125.00	25
D 2538 M	Diesel	12763	V8	125.00	25
D 2538 ME	Diesel	12763	V8	125.00	25
D 2538 MF	Diesel	12763	V8	125.00	25
D 2538 MT	Diesel	12763	V8	125.00	25
D 2538 MTE	Diesel	12763	V8	125.00	25
D 2540 MT	Diesel	17426	V10	125.00	25
D 2540 MTF	Diesel	17426	V10	125.00	25
D 2542 MLE	Diesel	20911	V12	125.00	25
D 2542 MTE	Diesel	20911	V12	125.00	25
D 2555 M	Diesel	9200	5	125.00	22
D 2555 MF	Diesel	9200	5	125.00	22
D 2555 MX	Diesel	9200	5	125.00	22
D 2555 MXF	Diesel	9200	5	125.00	22
D 2556 M	Diesel	11045	6	125.00	22
D 2556 MX	Diesel	11045	6	125.00	22
D 2556 MXF	Diesel	11045	6	125.00	22
D 2556 MXUH/175	Diesel	11045	6	125.00	22
D 2556 MXUH/192	Diesel	11045	6	125.00	22
D 2556 MXUH/240	Diesel	11045	6	125.00	22
D 2556 MXUM	Diesel	11045	6	125.00	22
D 2565 HM	Diesel	9510	5	125.00	23
D 2565 M	Diesel	9510	5	125.00	23
D 2565 ME	Diesel	9510	5	125.00	23
D 2565 MF	Diesel	9510	5	125.00	23
D 2565 MFR	Diesel	9510	5	125.00	23
D 2565 MK	Diesel	9510	5	125.00	24
D 2565 MKUL	Diesel	9510	5	125.00	24
D 2565 MR	Diesel	9510	5	125.00	22
D 2565 MT	Diesel	9510	5	125.00	24
D 2565 MUE	Diesel	9510	5	125.00	22
D 2565 MUH	Diesel	9510	5	125.00	23
D 2565 MUL	Diesel	9510	5	125.00	23
D 2566 M	Diesel	11413	6	125.00	23
D 2566 ME	Diesel	11413	6	125.00	23
D 2566 MF	Diesel	11413	6	125.00	23
D 2566 MH	Diesel	11413	6	125.00	23
D 2566 MK	Diesel	11413	6	125.00	24
D 2566 MKF	Diesel	11413	6	125.00	24
D 2566 MKUH/320	Diesel	11413	6	125.00	24
D 2566 MKUL	Diesel	11413	6	125.00	24
D 2566 MLUH	Diesel	11413	6	125.00	24



CCM



9

D 2566 MLUM	Diesel	11413	6	125.00	24
D 2566 MT	Diesel	11413	6	125.00	24
D 2566 MTE	Diesel	11413	6	125.00	24
D 2566 MTF	Diesel	11413	6	125.00	24
D 2566 MTH	Diesel	11413	6	125.00	24
D 2566 MTHO	Diesel	11413	6	125.00	24
D 2566 MTUH	Diesel	11413	6	125.00	24
D 2566 MUE	Diesel	11413	6	125.00	23
D 2566 MUH	Diesel	11413	6	125.00	23
D 2566 MUL	Diesel	11413	6	125.00	23
D 2566 MUM	Diesel	11413	6	125.00	23
D 2566 MXF	Diesel	11413	6	125.00	23
D 2566 UH	Diesel	11413	6	125.00	22
D 2676 LF01 (Euro 4)	Diesel	12419	6	126.00	26
D 2676 LF02 (Euro 3)	Diesel	12419	6	126.00	26
D 2676 LF03 (Euro 2)	Diesel	12419	6	126.00	26
D 2676 LF04 (Euro 2)	Diesel	12419	6	126.00	26
D 2676 LF05 (Euro 4)	Diesel	12419	6	126.00	26
D 2676 LF06 (Euro 5)	Diesel	12419	6	126.00	27
D 2676 LF07 (Euro 5)	Diesel	12419	6	126.00	26
D 2676 LF08 (Euro 5)	Diesel	12419	6	126.00	27
D 2676 LF10 (Euro 4)	Diesel	12419	6	126.00	26
D 2676 LF11 (Euro 4)	Diesel	12419	6	126.00	27
D 2676 LF12 (Euro 4)	Diesel	12419	6	126.00	26
D 2676 LF13 (Euro 5)	Diesel	12419	6	126.00	27
D 2676 LF14 (Euro 5)	Diesel	12419	6	126.00	26
D 2676 LF15 (Euro 5)	Diesel	12419	6	126.00	27
D 2676 LF16 (Euro 5)	Diesel	12419	6	126.00	26
D 2676 LF17	Diesel	12419	6	126.00	27
D 2676 LF18	Diesel	12419	6	126.00	26
D 2676 LF19 (Euro 4)	Diesel	12419	6	126.00	27
D 2676 LF20 (Euro 4)	Diesel	12419	6	126.00	26
D 2676 LF21 (Euro 5)	Diesel	12419	6	126.00	26
D 2676 LF22 (Euro 5)	Diesel	12419	6	126.00	26
D 2676 LF25 (Euro 6)	Diesel	12419	6	126.00	26
D 2676 LF26 (Euro 6)	Diesel	12419	6	126.00	26
D 2676 LF28 (Euro 5)	Diesel	12419	6	126.00	26
D 2676 LF31 (Euro 3)	Diesel	12419	6	126.00	26
D 2676 LF32 (Euro 4)	Diesel	12419	6	126.00	26
D 2676 LF33 (Euro 4)	Diesel	12419	6	126.00	26
D 2676 LF35 (Euro 6)	Diesel	12419	6	126.00	28
D 2676 LF36 (Euro 6)	Diesel	12419	6	126.00	28
D 2676 LF45 (Euro 6)	Diesel	12419	6	126.00	28
D 2676 LF46 (Euro 6)	Diesel	12419	6	126.00	28
D 2676 LF47 (Euro 6)	Diesel	12419	6	126.00	28
D 2676 LF48 (Euro 6)	Diesel	12419	6	126.00	28
D 2676 LF49 (Euro 6)	Diesel	12419	6	126.00	28
D 2676 LF50 (Euro 6)	Diesel	12419	6	126.00	28
D 2676 LF54 (Euro 6)	Diesel	12419	6	126.00	28
D 2676 LF55 (Euro 6)	Diesel	12419	6	126.00	28
D 2676 LF56 (Euro 6)	Diesel	12419	6	126.00	28
D 2676 LF57 (Euro 6)	Diesel	12419	6	126.00	28
D 2676 LF58 (Euro 6)	Diesel	12419	6	126.00	28
D 2676 LOH01 (Euro 4)	Diesel	12419	6	126.00	29
D 2676 LOH02 (Euro 4)	Diesel	12419	6	126.00	29
D 2676 LOH03 (Euro 4)	Diesel	12419	6	126.00	29
D 2676 LOH04 (Euro 4)	Diesel	12419	6	126.00	29
D 2676 LOH10 (Euro 3)	Diesel	12419	6	126.00	29
D 2676 LOH26 (Euro 5)	Diesel	12419	6	126.00	29
D 2676 LOH27 (Euro 5)	Diesel	12419	6	126.00	29

ENGINE INDEX

Motorverzeichnis • Index de moteur • Índice de Motor
 Indeks silnika • Модель Двигателя • دليل المحرك



CCM

x



9

D 2676 LOH28 (Euro 5)	Diesel	12419	6	126.00	30
D 2676 LOH31 (Euro 6)	Diesel	12419	6	126.00	28
D 2840 LE	Diesel	18273	V10	128.00	41
D 2840 LE403	Diesel	18273	V10	128.00	41
D 2840 LE423	Diesel	18273	V10	128.00	41
D 2840 LF01	Diesel	18273	V10	128.00	41
D 2840 LF04 (Euro 1)	Diesel	18273	V10	128.00	41
D 2840 LF06 (Euro 1)	Diesel	18273	V10	128.00	41
D 2840 LF20 (Euro 2)	Diesel	18273	V10	128.00	41
D 2840 LF21 (Euro 2)	Diesel	18273	V10	128.00	41
D 2840 LF25 (Euro 3)	Diesel	18273	V10	128.00	41
D 2840 LF/460	Diesel	18273	V10	128.00	41
D 2840 LXE	Diesel	18273	V10	128.00	41
D 2840 LXF	Diesel	18273	V10	128.00	41
D 2840 LYE	Diesel	18273	V10	128.00	41
D 2840 ME	Diesel	18273	V10	128.00	41
D 2840 MF	Diesel	18273	V10	128.00	41
D 2840 MFG	Diesel	18273	V10	128.00	41
D 2840 MFR	Diesel	18273	V10	128.00	41
D 2840 MH	Diesel	18273	V10	128.00	41
D 2840 TL	Diesel	18273	V10	128.00	41
D 2842 LE202	Diesel	21927	V12	128.00	42
D 2842 LE211	Diesel	21927	V12	128.00	41
D 2842 LE402	Diesel	21927	V12	128.00	41
D 2842 LE403	Diesel	21927	V12	128.00	41
D 2842 LE404	Diesel	21927	V12	128.00	42
D 2842 LE406	Diesel	21927	V12	128.00	41
D 2842 LE408	Diesel	21927	V12	128.00	41
D 2842 LE414	Diesel	21930	V12	128.00	42
D 2842 LE415	Diesel	21930	V12	128.00	42
D 2842 LE416	Diesel	21930	V12	128.00	42
D 2842 LE417	Diesel	21930	V12	128.00	42
D 2842 LE423	Diesel	21927	V12	128.00	41
D 2842 LE433	Diesel	21927	V12	128.00	41
D 2842 LE622	Diesel	21927	V12	128.00	41
D 2842 LF	Diesel	21927	V12	128.00	41
D 2842 LF10 (Euro 3)	Diesel	21927	V12	128.00	41
D 2842 LFX	Diesel	21927	V12	128.00	41
D 2842 LXE	Diesel	21927	V12	128.00	41
D 2842 LYE	Diesel	21927	V12	128.00	41
D 2842 LZE	Diesel	21927	V12	128.00	41
D 2842 ME	Diesel	21927	V12	128.00	41
D 2842 MF	Diesel	21927	V12	128.00	41
D 2848 LE	Diesel	14618	V8	128.00	41
D 2848 LE423	Diesel	14618	V8	128.00	41
D 2848 LXE	Diesel	14618	V8	128.00	41
D 2848 LYE	Diesel	14618	V8	128.00	41
D 2848 M	Diesel	14618	V8	128.00	41
D 2848 MF	Diesel	14618	V8	128.00	41
D 2848 MH	Diesel	14618	V8	128.00	41
D 2865 LF02	Diesel	9973	5	128.00	32
D 2865 LF03	Diesel	9973	5	128.00	32
D 2865 LF05 (Euro 1)	Diesel	9973	5	128.00	32
D 2865 LF06 (Euro 1)	Diesel	9973	5	128.00	32
D 2865 LF09	Diesel	9973	5	128.00	33
D 2865 LF10	Diesel	9973	5	128.00	32
D 2865 LF21 (Euro 2)	Diesel	9973	5	128.00	33
D 2865 LF22 (Euro 1)	Diesel	9973	5	128.00	32
D 2865 LF23 (Euro 1)	Diesel	9973	5	128.00	32
D 2865 LF24 (Euro 2)	Diesel	9973	5	128.00	33



CCM



9

D 2865 LF/260	Diesel	9973	5	128.00	31
D 2865 LFR	Diesel	9973	5	128.00	31
D 2865 LFR01	Diesel	9973	5	128.00	31
D 2865 LOH01 (Euro 1)	Diesel	9973	5	128.00	32
D 2865 LOH02 (Euro 1)	Diesel	9973	5	128.00	32
D 2865 LOH05 (Euro 1)	Diesel	9973	5	128.00	32
D 2865 LOH07 (Euro 2)	Diesel	9973	5	128.00	34
D 2865 LOH09 (Euro 2)	Diesel	9973	5	128.00	34
D 2865 LU01 (Euro 1)	Diesel	9973	5	128.00	32
D 2865 LU02	Diesel	9973	5	128.00	32
D 2865 LU03	Diesel	9973	5	128.00	32
D 2865 LU04 (Euro 1)	Diesel	9973	5	128.00	32
D 2865 LU06 (Euro 1)	Diesel	9973	5	128.00	32
D 2865 LUH02 (Euro 1)	Diesel	9973	5	128.00	32
D 2865 LUH03 (Euro 1)	Diesel	9973	5	128.00	32
D 2865 LUH05 (Euro 1)	Diesel	9973	5	128.00	32
D 2865 LUH06 (Euro 1)	Diesel	9973	5	128.00	32
D 2865 LUH07 (Euro 2)	Diesel	9973	5	128.00	33
D 2865 LUH08 (Euro 1)	Diesel	9973	5	128.00	32
D 2865 LUH09 (Euro 2)	Diesel	9973	5	128.00	33
D 2865 LXF	Diesel	9973	5	128.00	32
D 2865 LXFR	Diesel	9973	5	128.00	32
D 2866 F/240	Diesel	11967	6	128.00	34
D 2866 FG	Diesel	11967	6	128.00	34
D 2866 FR	Diesel	11967	6	128.00	34
D 2866 KF	Diesel	11967	6	128.00	31
D 2866 KFZ	Diesel	11967	6	128.00	31
D 2866 KOH360	Diesel	11967	6	128.00	31
D 2866 KOH/373	Diesel	11967	6	128.00	34
D 2866 KUH/360 (Euro 1)	Diesel	11967	6	128.00	31
D 2866 KUL	Diesel	11967	6	128.00	31
D 2866 LF	Diesel	11967	6	128.00	31
D 2866 LF01	Diesel	11967	6	128.00	34
D 2866 LF02	Diesel	11967	6	128.00	32
D 2866 LF03	Diesel	11967	6	128.00	32
D 2866 LF04	Diesel	11967	6	128.00	31
D 2866 LF05 (Euro 1)	Diesel	11967	6	128.00	35
D 2866 LF06	Diesel	11967	6	128.00	32
D 2866 LF07	Diesel	11967	6	128.00	31
D 2866 LF08	Diesel	11967	6	128.00	31
D 2866 LF09 (Euro 1)	Diesel	11967	6	128.00	32
D 2866 LF10 (Euro 1)	Diesel	11967	6	128.00	32
D 2866 LF14 (Euro 2)	Diesel	11967	6	128.00	33
D 2866 LF15 (Euro 1)	Diesel	11967	6	128.00	32
D 2866 LF16 (Euro 2)	Diesel	11967	6	128.00	33
D 2866 LF17 (Euro 2)	Diesel	11967	6	128.00	33
D 2866 LF20 (Euro 2)	Diesel	11967	6	128.00	33
D 2866 LF21 (Euro 1)	Diesel	11967	6	128.00	32
D 2866 LF22 (Euro 1)	Diesel	11967	6	128.00	32
D 2866 LF23 (Euro 3)	Diesel	11967	6	128.00	36
D 2866 LF24 (Euro 3)	Diesel	11967	6	128.00	36
D 2866 LF25 (Euro 3)	Diesel	11967	6	128.00	36
D 2866 LF26 (Euro 3)	Diesel	11967	6	128.00	36
D 2866 LF27 (Euro 3)	Diesel	11967	6	128.00	36
D 2866 LF28 (Euro 3)	Diesel	11967	6	128.00	36
D 2866 LF29 (Euro 2)	Diesel	11967	6	128.00	33
D 2866 LF30 (Euro 2)	Diesel	11967	6	128.00	33
D 2866 LF31 (Euro 2)	Diesel	11967	6	128.00	37
D 2866 LF32 (Euro 2)	Diesel	11967	6	128.00	37
D 2866 LF34 (Euro 2)	Diesel	11967	6	128.00	33

ENGINE INDEX

Motorverzeichnis • Index de moteur • Índice de Motor
 Indeks silnika • Модель Двигателя • دليل المحرك



CCM

x



9

D 2866 LF35 (Euro 2)	Diesel	11967	6	128.00	33
D 2866 LF36 (Euro 2)	Diesel	11967	6	128.00	33
D 2866 LF37 (Euro 2)	Diesel	11967	6	128.00	33
D 2866 LF39 (Euro 2)	Diesel	11967	6	128.00	37
D 2866 LF40 (Euro 2)	Diesel	11967	6	128.00	37
D 2866 LF41 (Euro 2)	Diesel	11967	6	128.00	37
D 2866 LF42 (Euro 2)	Diesel	11967	6	128.00	37
D 2866 LF43 (Euro 2)	Diesel	11967	6	128.00	37
D 2866 LF/290	Diesel	11967	6	128.00	31
D 2866 LFG	Diesel	11967	6	128.00	32
D 2866 LFG03 (Euro 1)	Diesel	11967	6	128.00	32
D 2866 LFG04 (Euro 1)	Diesel	11967	6	128.00	32
D 2866 LFG05 (Euro 2)	Diesel	11967	6	128.00	34
D 2866 LFG07 (Euro 3)	Diesel	11967	6	128.00	36
D 2866 LFZ/290	Diesel	11967	6	128.00	31
D 2866 LFZ/330	Diesel	11967	6	128.00	31
D 2866 LH01	Diesel	11967	6	128.00	31
D 2866 LOH	Diesel	11967	6	128.00	32
D 2866 LOH02	Diesel	11967	6	128.00	32
D 2866 LOH03	Diesel	11967	6	128.00	32
D 2866 LOH06 (Euro 1)	Diesel	11967	6	128.00	32
D 2866 LOH07	Diesel	11967	6	128.00	32
D 2866 LOH09 (Euro 1)	Diesel	11967	6	128.00	32
D 2866 LOH20 (Euro 1)	Diesel	11967	6	128.00	32
D 2866 LOH21 (Euro 1)	Diesel	11967	6	128.00	32
D 2866 LOH22 (Euro 1)	Diesel	11967	6	128.00	32
D 2866 LOH23 (Euro 2)	Diesel	11967	6	128.00	33
D 2866 LOH24 (Euro 1)	Diesel	11967	6	128.00	32
D 2866 LOH25 (Euro 2)	Diesel	11967	6	128.00	33
D 2866 LOH26 (Euro 2)	Diesel	11967	6	128.00	33
D 2866 LOH27 (Euro 3)	Diesel	11967	6	128.00	36
D 2866 LOH28 (Euro 3)	Diesel	11967	6	128.00	36
D 2866 LOH29 (Euro 3)	Diesel	11967	6	128.00	36
D 2866 LOH31 (Euro 2)	Diesel	11967	6	128.00	34
D 2866 LOH32 (Euro 3)	Diesel	11967	6	128.00	36
D 2866 LOH33 (Euro 3)	Diesel	11967	6	128.00	36
D 2866 LOH34 (Euro 3)	Diesel	11967	6	128.00	36
D 2866 LOH35 (Euro 3)	Diesel	11967	6	128.00	36
D 2866 LU	Diesel	11967	6	128.00	31
D 2866 LU01	Diesel	11967	6	128.00	32
D 2866 LU03 (Euro 1)	Diesel	11967	6	128.00	32
D 2866 LU04	Diesel	11967	6	128.00	32
D 2866 LU07	Diesel	11967	6	128.00	31
D 2866 LU08	Diesel	11967	6	128.00	31
D 2866 LU330	Diesel	11967	6	128.00	31
D 2866 LUH	Diesel	11967	6	128.00	31
D 2866 LUH04 (Euro 1)	Diesel	11967	6	128.00	31
D 2866 LUH05 (Euro 1)	Diesel	11967	6	128.00	32
D 2866 LUH21 (Euro 2)	Diesel	11967	6	128.00	33
D 2866 LUH22 (Euro 2)	Diesel	11967	6	128.00	33
D 2866 LUH23 (Euro 3)	Diesel	11967	6	128.00	36
D 2866 LUH24 (Euro 3)	Diesel	11967	6	128.00	36
D 2866 LUH25 (Euro 3)	Diesel	11967	6	128.00	36
D 2866 LUH26 (Euro 2)	Diesel	11967	6	128.00	33
D 2866 LUH27 (Euro 3)	Diesel	11967	6	128.00	36
D 2866 LUH28 (Euro 3)	Diesel	11967	6	128.00	36
D 2866 LUH29 (Euro 3)	Diesel	11967	6	128.00	36
D 2866 LUH30 (Euro 3)	Diesel	11967	6	128.00	36
D 2866 LUH51 (Euro 3)	Diesel	11967	6	128.00	36
D 2866 LUH330	Diesel	11967	6	128.00	31



CCM



9

D 2866 LUL330	Diesel	11967	6	128.00	31
D 2866 LX	Diesel	11967	6	128.00	32
D 2866 LXE40	Diesel	11967	6	128.00	31
D 2866 LXE47	Diesel	11967	6	128.00	31
D 2866 LXF	Diesel	11967	6	128.00	32
D 2866 LXFG	Diesel	11967	6	128.00	32
D 2866 LXOH	Diesel	11967	6	128.00	32
D 2866 LXU	Diesel	11967	6	128.00	32
D 2866 LXUH	Diesel	11967	6	128.00	32
D 2866 OH	Diesel	11967	6	128.00	34
D 2866 T	Diesel	11967	6	128.00	31
D 2866 TOH	Diesel	11967	6	128.00	31
D 2866 TOH/290	Diesel	11967	6	128.00	31
D 2866 TOH/310	Diesel	11967	6	128.00	31
D 2866 TUH	Diesel	11967	6	128.00	31
D 2866 TUH01	Diesel	11967	6	128.00	31
D 2866 TUH/290	Diesel	11967	6	128.00	31
D 2866 U	Diesel	11967	6	128.00	34
D 2866 UH	Diesel	11967	6	128.00	34
D 2866 UH/240	Diesel	11967	6	128.00	34
D 2866 UM	Diesel	11967	6	128.00	34
D 2876 LF01 (Euro 2)	Diesel	12816	6	128.00	34
D 2876 LF02 (Euro 2)	Diesel	12816	6	128.00	38
D 2876 LF03 (Euro 3)	Diesel	12816	6	128.00	39
D 2876 LF04 (Euro 3)	Diesel	12816	6	128.00	39
D 2876 LF05 (Euro 3)	Diesel	12816	6	128.00	34
D 2876 LF06 (Euro 2)	Diesel	12816	6	128.00	39
D 2876 LF07 (Euro 2)	Diesel	12816	6	128.00	39
D 2876 LF10 (Euro 2)	Diesel	12816	6	128.00	39
D 2876 LF11 (Euro 2)	Diesel	12816	6	128.00	34
D 2876 LF12 (Euro 3)	Diesel	12816	6	128.00	40
D 2876 LF13 (Euro 3)	Diesel	12816	6	128.00	40
D 2876 LF17	Diesel	12816	6	128.00	39
D 2876 LF25 (Euro 2)	Diesel	12816	6	128.00	40
D 2876 LOH01 (Euro 2)	Diesel	12816	6	128.00	38
D 2876 LOH02 (Euro 3)	Diesel	12816	6	128.00	39
D 2876 LOH03 (Euro 3)	Diesel	12816	6	128.00	39
D 2876 LOH20 (Euro 3)	Diesel	12816	6	128.00	40
D 2876 LOH21 (Euro 3)	Diesel	12816	6	128.00	40
D 2876 LUE604	Diesel	12816	6	128.00	34
D 2876 LUE605	Diesel	12816	6	128.00	34
D 2876 LUE606	Diesel	12816	6	128.00	34
D 2876 LUH01 (Euro 2)	Diesel	12816	6	128.00	38
D 2876 LUH02 (Euro 2)	Diesel	12816	6	128.00	38
E 0824 E301 (E0824)	CNG/Gas	4580	4	108.00	12
E 0826 E301 (E0826)	CNG/Gas	6871	6	108.00	12
E 0834 E302	CNG/Gas	4580	4	108.00	12
E 0834 E312	CNG/Gas	4580	4	108.00	12
E 0834 LE302	CNG/Gas	4580	4	108.00	13
E 0836 E302	CNG/Gas	6871	6	108.00	12
E 0836 E312	CNG/Gas	6871	6	108.00	12
E 0836 LE202	CNG/Gas	6871	6	108.00	13
E 0836 LE302	CNG/Gas	6871	6	108.00	13
E 2842 E312	CNG/Gas	21927	V12	128.00	41
E 2842 LE312	CNG/Gas	21927	V12	128.00	41
E 2842 LE322	CNG/Gas	21927	V12	128.00	41
E 2848 LE322	CNG/Gas	14618	V8	128.00	41
E 2876 LUH01	CNG/Gas	12816	6	128.00	43
E 2876 LUH02	CNG/Gas	12816	6	128.00	43
E 2876 LUH03	CNG/Gas	12816	6	128.00	43

ENGINE INDEX

Motorverzeichnis • Index de moteur • Índice de Motor
 Indeks silnika • Модель Двигателя • دليل المحرك



CCM

x



9

E 2876 LUH04

CNG/Gas

12816

6

128.00

43



108.00							1
D 0824 FL01 (Euro 1)	4cyl.	4580cc	75kW (102PS)	Diesel	Turbo Intercooled	TD7655	
D 0824 GF02 (Euro 1)	4cyl.	4580cc	75kW (102PS)	Diesel		TD7639	
D 0824 GF03 (Euro 1)	4cyl.	4580cc	75kW (102PS)	Diesel		TD21287	
D 0824 LF/D/LFL (Euro 1)	4cyl.	4580cc	114kW (155PS)	Diesel		MP5695	
D 0824 LF/D/LFL (Euro 2)	4cyl.	4580cc	83-162kW (113-220PS)	Diesel		MP5696	
D 0824 LFO (Euro 1)	4cyl.	4580cc	118kW (160PS)	Diesel	Turbo Intercooled	TD7657	
D 0826 GF01 (Euro 1)	6cyl.	6871cc	110-114kW (150-155PS)	Diesel		TD7649	
D 0826 GF02	6cyl.	6871cc	169kW (230PS)	Diesel		TD22328	
D 0826 GF03	6cyl.	6871cc	110kW (150PS)	Diesel		TD7648	
D 0826 LE51	6cyl.	6871cc	132kW (180PS)	Diesel	Turbo Intercooled	TD19441	
D 0826 LE52	6cyl.	6871cc	132kW (180PS)	Diesel	Turbo Intercooled	TD19442	
D 0826 LE522 (Euro 1)	6cyl.	6871cc	154kW (209PS)	Diesel	Turbo Intercooled	TD23144	
D 0826 LE523 (Euro 1)	6cyl.	6871cc	169kW (230PS)	Diesel	Turbo Intercooled	TD23146	
D 0826 LE524 (Euro 1)	6cyl.	6871cc	125-132kW (170-180PS)	Diesel	Turbo Intercooled	TD23147	
D 0826 LE530 (Euro 1)	6cyl.	6871cc	147kW (200PS)	Diesel	Turbo Intercooled	TD23149	
D 0826 LE531 (Euro 1)	6cyl.	6871cc	191kW (260PS)	Diesel	Turbo Intercooled	TD23150	
D 0826 LF	6cyl.	6590cc	169kW (230PS)	Diesel	Turbo Intercooled	MP6810-1	
D 0826 LF (Euro 1)	6cyl.	6870cc	114-198kW (190-270PS)	Diesel	Turbo Intercooled	MP5697	
D 0826 LF09 (Euro 1)	6cyl.	6871cc	169kW (230PS)	Diesel	Turbo Intercooled	TD22332	
D 0826 LF12 (Euro 2)	6cyl.	6871cc	140kW (190PS)	Diesel	Turbo Intercooled	TD22337	
D 0826 LF13 (Euro 2)	6cyl.	6871cc	191kW (260PS)	Diesel	Turbo Intercooled	TD7694	
D 0826 LF/217/SILENT	6cyl.	6870cc	160kW (217PS)	Diesel	Turbo Intercooled	TD7723	
D 0826 LFOH	6cyl.	6871cc	162kW (220PS)	Diesel	Turbo Intercooled	MP7026	
D 0826 LOH	6cyl.	6590cc	169kW (230PS)	Diesel	Turbo Intercooled	MP6810	
D 0826 LOH (Euro 2)	6cyl.	6870cc	162-191kW (220-260PS)	Diesel		MP5698	
D 0826 LOH01	6cyl.	6871cc	140kW (190PS)	Diesel	Turbo Intercooled	TD7601	
D 0826 LOH02	6cyl.	6871cc	140kW (190PS)	Diesel	Turbo Intercooled	TD7679	
D 0826 LOH03	6cyl.	6871cc	162-169kW (220-230PS)	Diesel	Turbo Intercooled	TD16465	
D 0826 LOH07 (Euro 1)	6cyl.	6871cc	169kW (230PS)	Diesel	Turbo Intercooled	TD16246	
D 0826 LOH10 (Euro 1)	6cyl.	6871cc	184kW (250PS)	Diesel	Turbo Intercooled	TD16247	
D 0826 LUE51 (Euro 1)	6cyl.	6870cc	132kW (180PS)	Diesel	Turbo Intercooled	TD19444	
D 0826 LUH (Euro 2)	6cyl.	6870cc	162-191kW (220-260PS)	Diesel		MP5698-1	
D 0826 LUH08 (Euro 2)	6cyl.	6871cc	162-169kW (220-230PS)	Diesel	Turbo Intercooled	TD21304	
D 0826 LUH09 (Euro 2)	6cyl.	6871cc	169-206kW (230-280PS)	Diesel	Turbo Intercooled	TD21305	
D 0826 TF	6cyl.	6596cc	137kW (186PS)	Diesel	Turbo	TD7689	
D 0826 TOH	6cyl.	6596cc	132-137kW (180-186PS)	Diesel	Turbo	TD7600	
D 0826 TUE51	6cyl.	6871cc	132kW (180-180PS)	Diesel	Turbo Intercooled	TD23162	
D 0834 LOH40 (Euro 3)	4cyl.	4580cc	132kW (180PS)	Diesel	Turbo Intercooled	TD23680	
COBRA			01/06→	M90		08/88→06/96	
Favorit			01/93→12/04	NL		05/95→12/04	
G90			09/87→05/95	NM		05/90→03/97	
HOCL			08/87→04/04	SL II		08/93→12/04	
Jetliner			09/90→09/93	SM		11/87→02/95	
L2000			10/93→	TRUCK & BUS			

14-027680-00 DH B 111.50 C 217.00 D 115.85 E 4.00
 14-027681-00 DH B 112.00 C 217.00 D 115.85 E 4.00

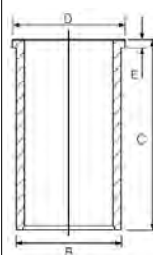

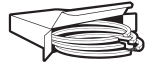

108.00						2
D 0824 GF	4cyl.	4580cc	75kW (102PS)	Diesel		TD5648
D 0824 GF01	4cyl.	4580cc	75kW (102PS)	Diesel		TD5988
D 0826 F01	6cyl.	6871cc	110-114kW (150-155PS)	Diesel		TD7681
D 0826 F02	6cyl.	6871cc	110kW (150PS)	Diesel		TD7682
D 0826 FO	6cyl.	6871cc	110-114kW (150-155PS)	Diesel		TD25847
D 0826 FO01	6cyl.	6871cc	114kW (155PS)	Diesel		TD23134
D 0826 FO02	6cyl.	6871cc	110kW (150PS)	Diesel		TD23135
D 0826 FR	6cyl.	6871cc	110kW (150PS)	Diesel		TD25848
D 0826 FR01	6cyl.	6871cc	110kW (150PS)	Diesel		TD25849
D 0826 GF	6cyl.	6871cc	110-114kW (150-155PS)	Diesel	Turbo	TD7647
D 0826 GF04 (Euro 1)	6cyl.	6871cc	110-114kW (150-155PS)	Diesel		TD19440
D 0826 GFA	6cyl.	6871cc	114kW (155PS)	Diesel		TD23139
D 0826 GFA03	6cyl.	6871cc	110kW (150PS)	Diesel		TD23142
D 0826 GFA04 (Euro 1)	6cyl.	6871cc	107kW (146PS)	Diesel		TD23143
D 0826 OH01	6cyl.	6871cc	114kW (155PS)	Diesel		TD23157
D 0826 OH02	6cyl.	6871cc	110-114kW (150-155PS)	Diesel		TD7599
D 0826 OH03 (Euro 1)	6cyl.	6871cc	107kW (146PS)	Diesel		TD23158
G90			09/87→05/95	NM		05/90→10/93
HOCL			08/87→04/04	SM		11/87→04/94
M90			12/88→05/94			

87-285800-00 STD

A 72.90
B- 21.52
BØ 63.00
D 115.90
40x83
(10830)
AK RT

08-285800-00 STD

2.50
2.50
4.00

CR P
P
CR P

14-027680-00 DH
14-027681-00 DH

B 111.50 C 217.00 D 115.85 E 4.00
B 112.00 C 217.00 D 115.85 E 4.00

108.00						3
D 0824 LF01 (Euro 1)	4cyl.	4580cc	114kW (155PS)	Diesel	Turbo Intercooled	TD7680
D 0824 LF03 (Euro 1)	4cyl.	4580cc	118kW (160PS)	Diesel	Turbo Intercooled	TD21278
D 0824 LF04 (Euro 1)	4cyl.	4580cc	118kW (160PS)	Diesel	Turbo Intercooled	TD21279
D 0824 LF05 (Euro 1)	4cyl.	4580cc	118kW (160PS)	Diesel	Turbo Intercooled	TD21280
D 0824 LF06 (Euro 1)	4cyl.	4580cc	118kW (160PS)	Diesel	Turbo Intercooled	TD21281
D 0824 LF07 (Euro 1)	4cyl.	4580cc	118kW (160PS)	Diesel	Turbo Intercooled	TD21282
D 0824 LF08 (Euro 1)	4cyl.	4580cc	118kW (160PS)	Diesel	Turbo Intercooled	TD21283
D 0824 LF09 (Euro 1)	4cyl.	4580cc	118kW (160PS)	Diesel	Turbo Intercooled	TD21284
D 0824 LF10 (Euro 1)	4cyl.	4580cc	118kW (160PS)	Diesel	Turbo Intercooled	TD21285
D 0824 LFL01 (Euro 1)	4cyl.	4580cc	114kW (155PS)	Diesel	Turbo Intercooled	TD7658
D 0824 LFL05 (Euro 1)	4cyl.	4580cc	114kW (155PS)	Diesel	Turbo Intercooled	TD7659
D 0824 LFL09 (Euro 1)	4cyl.	4580cc	114kW (155PS)	Diesel	Turbo Intercooled	TD9707
D 0824 LOH01 (Euro 1)	4cyl.	4580cc	114kW (155PS)	Diesel	Turbo Intercooled	TD7598
D 0826 FG001	6cyl.	6871cc	169kW (230PS)	Diesel		TD22324
D 0826 FG002	6cyl.	6871cc	169kW (230PS)	Diesel		TD22326
D 0826 LE521	6cyl.	6871cc	140kW (190PS)	Diesel	Turbo Intercooled	TD22331
D 0826 LF01	6cyl.	6871cc	140kW (190PS)	Diesel	Turbo Intercooled	TD7686
D 0826 LF02 (Euro 1)	6cyl.	6871cc	169kW (230PS)	Diesel	Turbo Intercooled	TD7691
D 0826 LF04 (Euro 1)	6cyl.	6871cc	198kW (270PS)	Diesel	Turbo Intercooled	TD7695
D 0826 LF05	6cyl.	6871cc	140kW (190PS)	Diesel	Turbo Intercooled	TD7687





D 0826 LF06	6cyl.	6871cc	169kW (230PS)	Diesel	Turbo Intercooled	TD7692
D 0826 LF07 (Euro 1)	6cyl.	6871cc	140kW (190PS)	Diesel	Turbo Intercooled	TD7688
D 0826 LF08 (Euro 1)	6cyl.	6871cc	169kW (230PS)	Diesel	Turbo Intercooled	TD7693
D 0826 LF18 (Euro 2)	6cyl.	6871cc	162kW (220PS)	Diesel	Turbo Intercooled	TD10227
D 0826 LFL (Euro 1)	6cyl.	6871cc	162-165kW (220-224PS)	Diesel	Turbo Intercooled	TD19443
D 0826 LFL02 (Euro 1)	6cyl.	6871cc	169kW (230PS)	Diesel	Turbo Intercooled	TD7664
D 0826 LFL03 (Euro 1)	6cyl.	6871cc	162kW (220PS)	Diesel	Turbo Intercooled	TD7663
D 0826 LFL05 (Euro 1)	6cyl.	6871cc	114kW (155PS)	Diesel	Turbo Intercooled	TD21291
D 0826 LFL06 (Euro 1)	6cyl.	6871cc	162kW (220PS)	Diesel	Turbo Intercooled	TD7665
D 0826 LFL07 (Euro 1)	6cyl.	6871cc	188kW (256PS)	Diesel	Turbo Intercooled	TD21292
D 0826 LFL08 (Euro 1)	6cyl.	6871cc	162kW (220PS)	Diesel	Turbo Intercooled	TD21293
D 0826 LFL10 (Euro 1)	6cyl.	6871cc	162kW (220PS)	Diesel	Turbo Intercooled	TD10207
D 0826 LOH04	6cyl.	6871cc	169kW (230PS)	Diesel	Turbo Intercooled	TD16466
D 0826 LOH05	6cyl.	6871cc	169kW (230PS)	Diesel	Turbo Intercooled	TD21295
D 0826 LOH06 (Euro 1)	6cyl.	6871cc	140kW (190PS)	Diesel	Turbo Intercooled	TD7587
D 0826 LUH (Euro 1)	6cyl.	6870cc	184kW (250PS)	Diesel	Turbo Intercooled	TD7583
D 0826 LUH01 (Euro 1)	6cyl.	6871cc	198kW (270PS)	Diesel	Turbo Intercooled	TD7596
D 0826 LUH02 (Euro 1)	6cyl.	6871cc	169-198kW (230-269PS)	Diesel	Turbo Intercooled	TD21301
D 0826 LUH03 (Euro 1)	6cyl.	6871cc	157kW (213PS)	Diesel	Turbo Intercooled	TD7584
D 0826 LUH04	6cyl.	6871cc	157-169kW (214-230PS)	Diesel	Turbo Intercooled	TD21302
D 0826 LUH05 (Euro 1)	6cyl.	6871cc	169kW (230PS)	Diesel	Turbo Intercooled	TD7585
D 0826 LUH06 (Euro 1)	6cyl.	6871cc	169-198kW (230-269PS)	Diesel	Turbo Intercooled	TD21303
D 0826 LUH10 (Euro 1)	6cyl.	6871cc	169-198kW (230-269PS)	Diesel	Turbo Intercooled	TD21306
D 0826 LUH12 (Euro 1)	6cyl.	6870cc	162kW (220PS)	Diesel	Turbo Intercooled	TD7586
D 0826 TE520	6cyl.	6596cc	121-125kW (165-170PS)	Diesel	Turbo	TD23159
Centroliner			10/98→	LION'S CITY		06/96→
ECM			04/02→12/07	M90		08/88→06/96
EL			01/93→10/97	M 2000 L		08/95→
EM			10/93→	M 2000 M		08/95→12/05
Favorit			01/93→12/04	ND		04/93→06/00
HOCL			08/93→04/04	NG		08/92→07/98
Jetliner			09/90→09/93	NL		04/91→
L2000			06/93→	NM		04/92→

87-285900-10 STD

- A** 72.90
- B-** 20.50
- BØ** 62.48
- C** 1.70
- C** 1.70
- D** 111.50
-  40x90

(10836B159)

AK RT



08-285900-00 STD

- 3.00  CR P
- 2.50  P
- 4.00  CR P

14-027680-00 DH
14-027681-00 DH

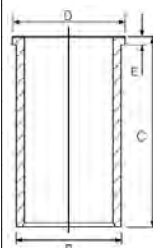

- B** 111.50 **C** 217.00 **D** 115.85 **E** 4.00
- B** 112.00 **C** 217.00 **D** 115.85 **E** 4.00

88-285900-10
87-285900-10 +
14-027680-00

108.00

4

D 0824 LF02 (Euro 2)	4cyl.	4580cc	118kW (160PS)	Diesel	Turbo Intercooled	TD7683
D 0824 LFL02 (Euro 2)	4cyl.	4580cc	114-118kW (155-160PS)	Diesel	Turbo Intercooled	TD7660
D 0824 LFL04 (Euro 2)	4cyl.	4580cc	81kW (110PS)	Diesel	Turbo Intercooled	TD7656
D 0824 LFL06 (Euro 2)	4cyl.	4580cc	114kW (155PS)	Diesel	Turbo Intercooled	TD7661
D 0824 LFL07 (Euro 2)	4cyl.	4580cc	104kW (141PS)	Diesel	Turbo Intercooled	TD7662
D 0824 LFL08 (Euro 2)	4cyl.	4580cc	83kW (113PS)	Diesel	Turbo Intercooled	TD16523





D 0824 LFL10 (Euro 2)	4cyl.	4580cc	92-162kW (125-220PS)	Diesel	Turbo Intercooled	TD21286
D 0824 LFO01 (Euro 1)	4cyl.	4580cc	114kW (155PS)	Diesel	Turbo Intercooled	TD23129
D 0824 LOH02 (Euro 1)	4cyl.	4580cc	114kW (155PS)	Diesel	Turbo Intercooled	TD21288
D 0824 LOH03 (Euro 1)	4cyl.	4580cc	114kW (155PS)	Diesel	Turbo Intercooled	TD21289
D 0824 LOH04 (Euro 1)	4cyl.	4580cc	114kW (155PS)	Diesel	Turbo Intercooled	TD21290
D 0824 LOH05 (Euro 2)	4cyl.	4580cc	114kW (155PS)	Diesel	Turbo Intercooled	TD20537
D 0826 LF11 (Euro 2)	6cyl.	6871cc	162kW (220PS)	Diesel	Turbo Intercooled	TD7690
D 0826 LF15 (Euro 2)	6cyl.	6871cc	162kW (220PS)	Diesel	Turbo Intercooled	TD7726
D 0826 LF17 (Euro 2)	6cyl.	6871cc	191kW (260PS)	Diesel	Turbo Intercooled	TD7727
D 0826 LFG15 (Euro 2)	6cyl.	6871cc	162kW (220PS)	Diesel	Turbo Intercooled	TD23154
D 0826 LFG16 (Euro 2)	6cyl.	6871cc	191kW (260PS)	Diesel	Turbo Intercooled	TD23155
D 0826 LFL09 (Euro 2)	6cyl.	6871cc	191kW (260PS)	Diesel	Turbo Intercooled	TD7725
D 0826 LOH15 (Euro 2)	6cyl.	6871cc	162kW (220PS)	Diesel	Turbo Intercooled	TD7588
D 0826 LOH17 (Euro 2)	6cyl.	6871cc	162kW (220PS)	Diesel	Turbo Intercooled	TD17419
D 0826 LOH18 (Euro 2)	6cyl.	6871cc	191kW (260PS)	Diesel	Turbo Intercooled	TD17420
D 0826 LOH19 (Euro 2)	6cyl.	6871cc	162kW (220PS)	Diesel	Turbo Intercooled	TD23156
D 0826 LUH11 (Euro 2)	6cyl.	6871cc	162kW (220PS)	Diesel	Turbo Intercooled	TD21307
D 0826 LUH13 (Euro 2)	6cyl.	6871cc	191kW (260PS)	Diesel	Turbo Intercooled	TD16248
D 0826 LUH/213	6cyl.	6871cc	157kW (213PS)	Diesel	Turbo Intercooled	TD7597

Centroliner	10/98→	M 2000 L	04/95→
COBRA	01/06→	M 2000 M	08/95→12/05
ECM	04/02→12/07	M-Serie	01/94→12/02
EL	05/95→02/01	NL	09/89→04/94
EM	08/87→	NM	08/87→
HOCL	08/93→	NÜ	07/98→
L2000	06/93→	SL II	05/95→12/04
LION'S CITY	07/98→	Sportliner	01/90→
LION'S CLASSIC	05/04→03/09	SÜ	04/99→12/04
M90	05/94→06/96	URBINO	01/99→

87-285900-00 STD

- A 72.90
- B- 17.80
- BØ 70.52
- C 1.70
- C 1.70
- D 111.50
-  40x90

(10836B170)

AK RT



08-285900-00 STD

- 3.00  CR P
- 2.50  P
- 4.00  CR P

14-027680-00 DH

14-027681-00 DH

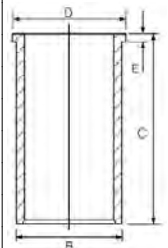

B 111.50 C 217.00 D 115.85 E 4.00

B 112.00 C 217.00 D 115.85 E 4.00

88-285900-00

87-285900-00 +
14-027680-00

 108.00

5

D 0834 LFL01 (Euro 3)	4cyl.	4580cc	125kW (170PS)	Diesel	Turbo Intercooled	TD41248
D 0834 LFL02 (Euro 3)	4cyl.	4580cc	103kW (140PS)	Diesel	Turbo Intercooled	TD6591
D 0834 LFL03 (Euro 3)	4cyl.	4580cc	132kW (180PS)	Diesel	Turbo Intercooled	TD16498
D 0834 LFL04 (Euro 3)	4cyl.	4580cc	110kW (150PS)	Diesel	Turbo Intercooled	TD18096
D 0834 LFL10 (Euro 3)	4cyl.	4580cc	125kW (170PS)	Diesel	Turbo Intercooled	TD28896
D 0834 LFL11 (Euro 3)	4cyl.	4580cc	103kW (140PS)	Diesel	Turbo Intercooled	TD28897
D 0834 LFL20 (Euro 3)	4cyl.	4580cc	125kW (170PS)	Diesel	Turbo Intercooled	TD16829
D 0834 LOH01 (Euro 3)	4cyl.	4580cc	125kW (170PS)	Diesel	Turbo Intercooled	TD16748
D 0834 LOH02 (Euro 3)	4cyl.	4580cc	125kW (170PS)	Diesel	Turbo Intercooled	TD16749
D 0834 LOH03 (Euro 3)	4cyl.	4580cc	125kW (170PS)	Diesel	Turbo Intercooled	TD16750
D 0836 LE501	6cyl.	6871cc	210kW (286PS)	Diesel	Turbo Intercooled	TD32899





D 0836 LE503	6cyl.	6871cc	162kW (220PS)	Diesel	Turbo Intercooled	TD32901
D 0836 LF01 (Euro 2)	6cyl.	6871cc	206kW (280PS)	Diesel	Turbo Intercooled	TD14289
D 0836 LF02 (Euro 3)	6cyl.	6871cc	162kW (220PS)	Diesel	Turbo Intercooled	TD17045
D 0836 LF03 (Euro 3)	6cyl.	6871cc	206kW (280PS)	Diesel	Turbo Intercooled	TD16503
D 0836 LF04 (Euro 3)	6cyl.	6871cc	162kW (220PS)	Diesel	Turbo Intercooled	TD16500
D 0836 LF05 (Euro 3)	6cyl.	6871cc	180kW (245PS)	Diesel	Turbo Intercooled	TD16504
D 0836 LF06 (Euro 3)	6cyl.	6871cc	260kW (354PS)	Diesel	Turbo Intercooled	TD28898
D 0836 LF10 (Euro 3)	6cyl.	6871cc	260kW (354PS)	Diesel	Turbo Intercooled	TD28899
D 0836 LFL01 (Euro 3)	6cyl.	6871cc	206-215kW (280-292PS)	Diesel	Turbo Intercooled	TD16875
D 0836 LFL02 (Euro 3)	6cyl.	6871cc	162kW (220PS)	Diesel	Turbo Intercooled	TD16499
D 0836 LFL03 (Euro 3)	6cyl.	6871cc	206kW (280PS)	Diesel	Turbo Intercooled	TD16502
D 0836 LFL04 (Euro 3)	6cyl.	6871cc	162kW (220PS)	Diesel	Turbo Intercooled	TD17049
D 0836 LFL05 (Euro 3)	6cyl.	6871cc	180kW (245PS)	Diesel	Turbo Intercooled	TD16501
D 0836 LFL06 (Euro 3)	6cyl.	6871cc	162kW (220PS)	Diesel	Turbo Intercooled	TD23163
D 0836 LFL07 (Euro 3)	6cyl.	6871cc	162kW (220PS)	Diesel	Turbo Intercooled	TD16830
D 0836 LFL10 (Euro 3)	6cyl.	6871cc	162kW (220PS)	Diesel	Turbo Intercooled	TD16831
D 0836 LOH01 (Euro 3)	6cyl.	6871cc	206kW (280PS)	Diesel	Turbo Intercooled	TD16753
D 0836 LOH02 (Euro 3)	6cyl.	6871cc	206kW (280PS)	Diesel	Turbo Intercooled	TD16752
D 0836 LOH03 (Euro 3)	6cyl.	6871cc	162kW (220PS)	Diesel	Turbo Intercooled	TD16751
D 0836 LUH01 (Euro 3)	6cyl.	6871cc	206kW (280PS)	Diesel	Turbo Intercooled	TD16756
D 0836 LUH02 (Euro 3)	6cyl.	6871cc	162kW (220PS)	Diesel	Turbo Intercooled	TD16757

5256	01/06→12/13	L2000	07/99→
A-Serie	01/04→	LION'S CITY	05/04→10/06
Centroliner	10/98→	LION'S CLASSIC	05/04→03/09
CLA	01/06→	M 2000 L	08/95→
ECL	04/02→	M 2000 M	08/95→12/05
ECM	04/02→12/07	NL	05/95→10/06
Hi-Ex	09/04→	SL II	05/95→12/04
HOCL	08/93→08/08	SÜ	04/99→

87-136500-10 STD
01/03→

- A** 63.90
- B-** 16.15
- BØ** 70.52
- C** 1.70
- D** 103.00
-  42x86

(10838W-151)

RT TP



08-136500-10 STD

- 3.00  CK P
- 2.50  P
- 3.00  CR P

14-027680-00 DH **B 111.50 C 217.00 D 115.85 E 4.00**
14-027681-00 DH **B 112.00 C 217.00 D 115.85 E 4.00**

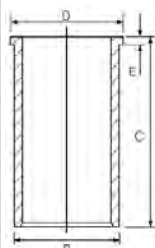

88-136500-10
87-136500-10 +
14-027680-00

87-136500-00 STD 

- A** 63.90
- B-** 16.15
- BØ** 70.52
- C** 1.70
- D** 103.00
-  42x85

(10838W-139)

RT TP



08-136500-00 STD

- 3.00  CK P
- 2.50  P
- 4.00  CR P

14-027680-00 DH **B 111.50 C 217.00 D 115.85 E 4.00**
14-027681-00 DH **B 112.00 C 217.00 D 115.85 E 4.00**

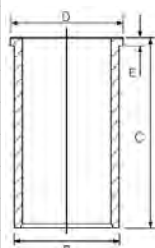



88-136500-00
87-136500-00 +
14-027680-00

 Bowl capacity 56.56cm³

 Volumen der Kolbenmulde 56.56cm³

 Volume de la cavité du piston 56.56cm³

 Vol. cavidad pistón 56.56cm³



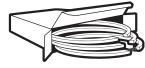

 Volume camera pistone 56.56cm³









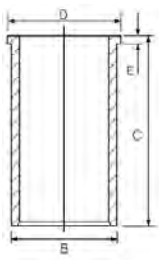



108.00 **6**

D 0834 LFL40 (Euro 3)	4cyl.	4580cc	110kW (150PS)	Diesel	Turbo Intercooled	TD18179
D 0834 LFL41 (Euro 3)	4cyl.	4580cc	132kW (180PS)	Diesel	Turbo Intercooled	TD18180
D 0834 LFL42 (Euro 3)	4cyl.	4580cc	151kW (206PS)	Diesel	Turbo Intercooled	TD18181
D 0836 LF41 (Euro 3)	6cyl.	6871cc	206kW (280PS)	Diesel	Turbo Intercooled	TD16827
D 0836 LF44 (Euro 3)	6cyl.	6871cc	240kW (326PS)	Diesel	Turbo Intercooled	TD16828
D 0836 LFL40 (Euro 3)	6cyl.	6871cc	176kW (240PS)	Diesel	Turbo Intercooled	TD18185
D 0836 LFL41 (Euro 3)	6cyl.	6871cc	206kW (280PS)	Diesel	Turbo Intercooled	TD18703
D 0836 LFL44 (Euro 3)	6cyl.	6871cc	240kW (326PS)	Diesel	Turbo Intercooled	TD18704
D 0836 LOH40 (Euro 3)	6cyl.	6871cc	206kW (280PS)	Diesel	Turbo Intercooled	TD16754
D 0836 LOH41 (Euro 3)	6cyl.	6871cc	176kW (239PS)	Diesel	Turbo Intercooled	TD16755

HOCL	08/02→12/14	TGA	03/01→
LION'S CITY	05/04→	TGL I	01/04→03/22
NL	05/00→	TGM I	05/05→03/22
SL II	03/00→12/04		

<p>87-136500-30 STD</p> <p>A 63.90 B- 17.39 BØ 65.40 C 1.70 D 103.00  42x86 (10838F109) RT TP</p> 	<p>08-136500-30 STD 08-136507-30 0.50mm</p> <p>3.00  CK P 2.50  P 3.00  CR P</p>	<p>14-027680-00 DH 14-027681-00 DH</p> <p>B 111.50 C 217.00 D 115.85 E 4.00 B 112.00 C 217.00 D 115.85 E 4.00</p> 
---	---	--

<p>87-136500-60 STD</p> <p>A 63.90 B- 17.39 BØ 65.40 C 1.70 D 103.00  42x86 (10843B101) KK RT TP</p> 	<p>08-136500-30 STD 08-136507-30 0.50mm</p> <p>3.00  CK P 2.50  P 3.00  CR P</p>	
---	---	--

<p>87-136500-70 STD</p> <p>A 63.70 B- 17.39 BØ 65.40 C 1.70 D 102.80  42x86 (10843B101) KK RT TP</p> 	<p>08-136500-30 STD 08-136507-30 0.50mm</p> <p>3.00  CK P 2.50  P 3.00  CR P</p>	
---	---	--

108.00 **7**

D 0834 LFL50 (Euro 4)	4cyl.	4580cc	110kW (150PS)	Diesel	Turbo Intercooled	TD18182
D 0834 LFL51 (Euro 4)	4cyl.	4580cc	132kW (180PS)	Diesel	Turbo Intercooled	TD18183
D 0834 LFL52 (Euro 4)	4cyl.	4580cc	151kW (206PS)	Diesel	Turbo Intercooled	TD18184
D 0834 LFL53 (Euro 4)	4cyl.	4580cc	110kW (150PS)	Diesel	Turbo Intercooled	TD22957
D 0834 LFL54 (Euro 4)	4cyl.	4580cc	132kW (180PS)	Diesel	Turbo Intercooled	TD22958
D 0834 LFL55 (Euro 4)	4cyl.	4580cc	151kW (206PS)	Diesel	Turbo Intercooled	TD22969





D 0834 LFL57 (Euro 4)	4cyl.	4580cc	151kW (206PS)	Diesel	Turbo Intercooled	TD31946
D 0834 LOH51 (Euro 4)	4cyl.	4580cc	151kW (205PS)	Diesel	Turbo Intercooled	TD19969
D 0834 LOH52 (Euro 4)	4cyl.	4580cc	132kW (180PS)	Diesel	Turbo Intercooled	TD23057
D 0834 LOH53 (Euro 4)	4cyl.	4580cc	151kW (206PS)	Diesel	Turbo Intercooled	TD23058
D 0836 LFG50 (Euro 4/5)	6cyl.	6871cc	240kW (326PS)	Diesel	Turbo Intercooled	TD20228
D 0836 LFL50 (Euro 4)	6cyl.	6871cc	176kW (240PS)	Diesel	Turbo Intercooled	TD18186
D 0836 LFL51 (Euro 4)	6cyl.	6871cc	206kW (280PS)	Diesel	Turbo Intercooled	TD19114
D 0836 LFL52 (Euro 4)	6cyl.	6871cc	240kW (326PS)	Diesel	Turbo Intercooled	TD19113
D 0836 LFL53 (Euro 4)	6cyl.	6871cc	176kW (240PS)	Diesel	Turbo Intercooled	TD22970
D 0836 LFL54 (Euro 4)	6cyl.	6871cc	206kW (280PS)	Diesel	Turbo Intercooled	TD22971
D 0836 LFL55 (Euro 4)	6cyl.	6871cc	240kW (326PS)	Diesel	Turbo Intercooled	TD22972
D 0836 LOH51 (Euro 4)	6cyl.	6871cc	206kW (280PS)	Diesel	Turbo Intercooled	TD19971
D 0836 LOH52 (Euro 4)	6cyl.	6871cc	176kW (239PS)	Diesel	Turbo Intercooled	TD19970
D 0836 LOH55 (Euro 4)	6cyl.	6871cc	206kW (280PS)	Diesel	Turbo Intercooled	TD23060
D 0836 LOH56 (Euro 4)	6cyl.	6871cc	176kW (239PS)	Diesel	Turbo Intercooled	TD23059
D 0836 LOH60	6cyl.	6871cc	213kW (290PS)	Diesel	Turbo Intercooled	TD23671
D 0836 LOH61	6cyl.	6871cc	184kW (250PS)	Diesel	Turbo Intercooled	TD23670
D 0836 LOH62 (Euro 4)	6cyl.	6871cc	191kW (260PS)	Diesel	Turbo Intercooled	TD23164
D 0836 LOH63	6cyl.	6871cc	191kW (260PS)	Diesel	Turbo Intercooled	TD23962

5292	01/04→	LION S INTERCITY	07/15→
6213	01/07→	NL	05/00→
Airliner	01/92→	NM	08/02→06/14
COBRA	05/04→	SL II	07/05→10/06
FOCL	08/07→	SÜ	09/03→
HOCL	08/93→	TEMPO	09/04→
LION'S CITY	05/04→	TGL I	01/04→03/22
LION'S CLASSIC	05/04→05/14	TGM I	05/05→03/22

87-136500-65 STD
87-136507-65 0.50mm

A 63.90
B- 17.39
BØ 65.00
C 1.70
D 103.00
 44x88
 (10844A113)
KK RT TP

08-136500-30 STD
08-136507-30 0.50mm

3.00 CK P
 2.50 P
 3.00 CR P

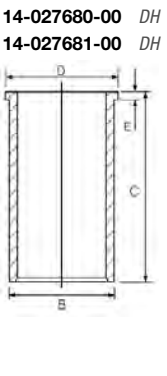

B 111.50 **C** 217.00 **D** 115.85 **E** 4.00
B 112.00 **C** 217.00 **D** 115.85 **E** 4.00

88-136500-65
 87-136500-65 +
 14-027680-00

87-136500-75 STD

A 63.70
B- 17.39
BØ 65.00
C 1.70
D 102.80
 44x88
 (10844A113)
KK RT TP

08-136500-30 STD
08-136507-30 0.50mm

3.00 CK P
 2.50 P
 3.00 CR P





87-136500-85 STD

- A 63.50
- B- 17.39
- BØ 65.00
- C 1.70
- D 102.60
-  44x88
- (10844A113)
- KK RT TP**



08-136500-30 STD
08-136507-30 0.50mm

- 3.00  CK P
- 2.50  P
- 3.00  CR P

108.00

8







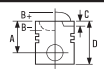





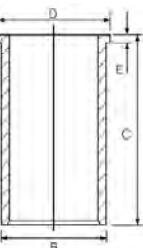

D 0834 LFL60	4cyl.	4580cc	110kW (150PS)	Diesel	Turbo Intercooled	TD22962
D 0834 LFL61	4cyl.	4580cc	132kW (180PS)	Diesel	Turbo Intercooled	TD22963
D 0834 LFL62	4cyl.	4580cc	162kW (220PS)	Diesel	Turbo Intercooled	TD22965
D 0834 LFL63 (Euro 5)	4cyl.	4580cc	110kW (150PS)	Diesel	Turbo Intercooled	TD22959
D 0834 LFL64 (Euro 5)	4cyl.	4580cc	132-137kW (180-186PS)	Diesel	Turbo Intercooled	TD22960
D 0834 LFL65 (Euro 5)	4cyl.	4580cc	162-166kW (220-226PS)	Diesel	Turbo Intercooled	TD22961
D 0834 LFL66 (Euro 6)	4cyl.	4580cc	110kW (150PS)	Diesel	Turbo Intercooled	TD27703
D 0834 LFL67 (Euro 6)	4cyl.	4580cc	132kW (180PS)	Diesel	Turbo Intercooled	TD27704
D 0834 LFL68 (Euro 6)	4cyl.	4580cc	162kW (220PS)	Diesel	Turbo Intercooled	TD27705
D 0834 LFL75 (Euro 6)	4cyl.	4580cc	132kW (180PS)	Diesel	Turbo Intercooled	TD31909
D 0834 LOH61 (Euro 5)	4cyl.	4580cc	132kW (180PS)	Diesel	Turbo Intercooled	TD23679
D 0836 LFL60	6cyl.	6871cc	184kW (250PS)	Diesel	Turbo Intercooled	TD22966
D 0836 LFL61	6cyl.	6871cc	213kW (290PS)	Diesel	Turbo Intercooled	TD23686
D 0836 LFL62	6cyl.	6871cc	250kW (340PS)	Diesel	Turbo Intercooled	TD23687
D 0836 LFL63 (Euro 5)	6cyl.	6871cc	184kW (250PS)	Diesel	Turbo Intercooled	TD22967
D 0836 LFL64 (Euro 5)	6cyl.	6871cc	202-213kW (275-290PS)	Diesel	Turbo Intercooled	TD22984
D 0836 LFL65 (Euro 5)	6cyl.	6871cc	250kW (340PS)	Diesel	Turbo Intercooled	TD22995
D 0836 LFL66 (Euro 6)	6cyl.	6871cc	184kW (250PS)	Diesel	Turbo Intercooled	TD27706
D 0836 LFL67 (Euro 6)	6cyl.	6871cc	213kW (290PS)	Diesel	Turbo Intercooled	TD27707
D 0836 LFL68 (Euro 6)	6cyl.	6871cc	250kW (340PS)	Diesel	Turbo Intercooled	TD27724
D 0836 LFL69 (Euro 5)	6cyl.	6871cc	184kW (250PS)	Diesel	Turbo Intercooled	TD27708
D 0836 LFL70 (Euro 5)	6cyl.	6871cc	213kW (290PS)	Diesel	Turbo Intercooled	TD27709
D 0836 LFL71 (Euro 5)	6cyl.	6871cc	250kW (340PS)	Diesel	Turbo Intercooled	TD27710
D 0836 LFL75 (Euro 6)	6cyl.	6871cc	184kW (250PS)	Diesel	Turbo Intercooled	TD31910
D 0836 LFL76 (Euro 6)	6cyl.	6871cc	213kW (290PS)	Diesel	Turbo Intercooled	TD31911
D 0836 LFL77 (Euro 6)	6cyl.	6871cc	250kW (340PS)	Diesel	Turbo Intercooled	TD31912
D 0836 LOH64 (Euro 5)	6cyl.	6871cc	209-213kW (284-290PS)	Diesel	Turbo Intercooled	TD23682
D 0836 LOH65 (Euro 5)	6cyl.	6871cc	184kW (250PS)	Diesel	Turbo Intercooled	TD23681
D 0836 LOH66 (Euro 6)	6cyl.	6871cc	213kW (290PS)	Diesel	Turbo Intercooled	TD30438
D 0836 LOH67 (Euro 6)	6cyl.	6871cc	184kW (250PS)	Diesel	Turbo Intercooled	TD30439
D 0836 LOH70	6cyl.	6871cc	213kW (290PS)	Diesel	Turbo Intercooled	TD30442
D 0836 LOH71	6cyl.	6871cc	184kW (250PS)	Diesel	Turbo Intercooled	TD30441
D 0836 LOH72 (Euro 6)	6cyl.	6871cc	213kW (290PS)	Diesel	Turbo Intercooled	TD31913
D 0836 LOH73 (Euro 6)	6cyl.	6871cc	184kW (250PS)	Diesel	Turbo Intercooled	TD31914
D 0836 LOH74 (Euro 6)	6cyl.	6871cc	184kW (250PS)	Diesel	Turbo Intercooled	TD31915

5292	05/07→	NL	05/07→
6213	05/07→	TGL I	01/04→03/22
COBRA	05/04→	TGL II	02/20→
CONSTELLATION	07/05→	TGM I	10/05→03/22
FOCL	08/04→	TGM II	02/20→





HOCL	05/07→	VECTIO	04/07→
LION'S CITY	05/04→	VIVE	05/10→
LION'S CLASSIC	05/04→05/14	VOLKSBUS	01/13→
LION S INTERCITY	07/15→	WORKER	07/05→
MD	11/10→		





<p>87-136500-55 STD ①</p> <p>A 63.90 B- 18.47 BØ 65.00 C 1.70 D 103.00  44x88 (10846A101) AK RT TP</p> 	<p>08-136500-30 STD 08-136507-30 0.50mm</p> <p>3.00  CK P 2.50  P 3.00  CR P</p>	<p>14-027680-00 DH 14-027681-00 DH</p> <p>B 111.50 C 217.00 D 115.85 E 4.00 B 112.00 C 217.00 D 115.85 E 4.00</p> 	
<p>87-136500-90 STD ②</p> <p>A 63.90 B- 18.47 BØ 77.60 C 1.70 D 103.00  44x88 (10848-311) AK KK NB RT TP</p> 	<p>08-136500-30 STD 08-136507-30 0.50mm</p> <p>3.00  CK P 2.50  P 3.00  CR P</p>		
<p>87-136500-91 STD ③</p> <p>A 63.70 B- 18.47 BØ 77.60 C 1.70 D 102.80  44x88 (10848-311) AK KK NB RT TP</p> 	<p>08-136500-30 STD 08-136507-30 0.50mm</p> <p>3.00  CK P 2.50  P 3.00  CR P</p>		

① OE 51.02500-6217
② OE 51.02500-6219
③ A = 63.700, D = 102.800

108.00 **9**

D 0826 OH 6cyl. **6871cc** **110kW** (150PS) **Diesel** **TD19445**

HOCL 08/87→04/04

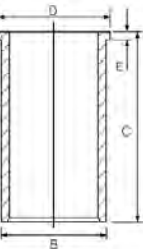
<p>87-285900-40 STD</p> <p>A 72.90 B- 21.35 BØ 62.48 D 115.90  40x90 (10830B) AK HA RT</p> 	<p>08-285900-00 STD</p> <p>3.00  CR P 2.50  P 4.00  CR P</p>	<p>14-027680-00 DH 14-027681-00 DH</p> <p>B 111.50 C 217.00 D 115.85 E 4.00 B 112.00 C 217.00 D 115.85 E 4.00</p> 	<p>88-285900-40 87-285900-40 + 14-027680-00</p>
---	--	---	--



108.00 **10**

D 0836 LE510	6cyl.	6871cc	221-228kW (301-310PS)	Diesel	Turbo Intercooled	TD32926
---------------------	-------	--------	-----------------------	--------	-------------------	----------------

87-136500-95 STD

B- 63.90
 B- 16.15
 BØ 70.52
 C 1.70
 D 103.00
 42x86
 (10843C101)
 KK RT TP

08-136500-10 STD

3.00 CK P
 2.50 P
 3.00 CR P

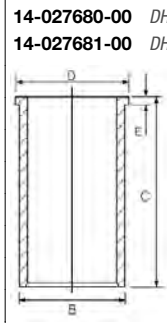

B 111.50 C 217.00 D 115.85 E 4.00
 B 112.00 C 217.00 D 115.85 E 4.00

108.00 **11**

D 0836 M2	6cyl.	7030cc	99kW (135PS)	Diesel	TD7644
D 0846 HM2	6cyl.	7250cc	117kW (160PS)	Diesel	TD7654
D 0846 HM42U	6cyl.	7252cc	117kW (160PS)	Diesel	TD8656
D 0846 HM81H	6cyl.	7252cc	117kW (160PS)	Diesel	TD8741
D 0846 HM82U	6cyl.	7252cc	117kW (160PS)	Diesel	TD8745
D 0846 HM91H	6cyl.	7252cc	117kW (160PS)	Diesel	TD7818
D 0846 HM91U	6cyl.	7250cc	117kW (160PS)	Diesel	TD7822
D 0846 HM95U	6cyl.	7252cc	117kW (160PS)	Diesel	TD7827
D 0846 HMN	6cyl.	7252cc	117kW (160PS)	Diesel	TD7651
D 0846 HMN2	6cyl.	7252cc	117-118kW (160-160PS)	Diesel	TD19037
D 0846 HMN80	6cyl.	7252cc	132kW (180PS)	Diesel	TD8779
D 0846 HMX-011	6cyl.	7250cc	117kW (160PS)	Diesel	TD8781
D 0846 HMXU-015	6cyl.	7250cc	117kW (160PS)	Diesel	TD7627
D 0846 HMY-011	6cyl.	7250cc	123kW (168PS)	Diesel	TD7707
D 0846 HMYH	6cyl.	7252cc	123kW (168PS)	Diesel	TD7168
D 0846 HMYN-014	6cyl.	7252cc	123kW (168PS)	Diesel	TD7702

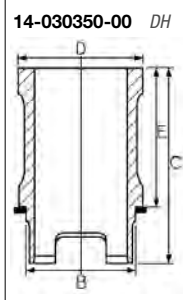

B 112.99 C 254.00 D 118.00 E 5.00

108.00 **12**

E 0824 E301 (E0824)	4cyl.	4580cc	47-58kW (64-79PS)	CNG/Gas	TD25680
E 0826 E301 (E0826)	6cyl.	6871cc	70-88kW (95-120PS)	CNG/Gas Turbo Intercooled	TD25681
E 0834 E302	4cyl.	4580cc	54-62kW (73-84PS)	CNG/Gas	TD25700
E 0834 E312	4cyl.	4580cc	37-53kW (50-72PS)	CNG/Gas	TD25699
E 0836 E302	6cyl.	6871cc	75-85kW (102-116PS)	CNG/Gas	TD23749
E 0836 E312	6cyl.	6871cc	56-64kW (76-87PS)	CNG/Gas	TD23748





87-429100-00 STD

A 62.80
B- 14.90
BØ 81.70
D 101.90
42x85

(10838F403)

RT TP



08-429100-00 STD

2.50 CK P
2.50 P
4.00 CR P

14-027680-00 DH
14-027681-00 DH

B 111.50 C 217.00 D 115.85 E 4.00
B 112.00 C 217.00 D 115.85 E 4.00

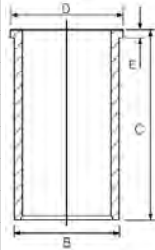

87-429100-10 STD

A 62.80
B- 14.90
BØ 81.70
D 101.90
42x86

(10838F416)

RT TP



08-429100-00 STD

2.50 CK P
2.50 P
4.00 CR P

108.00

13

E 0834 LE302	4cyl.	4580cc	68kW (92PS)	CNG/Gas Turbo Intercooled	TD28164
E 0836 LE202	6cyl.	6871cc	110kW (150PS)	CNG/Gas Turbo Intercooled	TD23747
E 0836 LE302	6cyl.	6871cc	68-85kW (92-116PS)	CNG/Gas Turbo Intercooled	TD23750

87-431600-10 STD

A 63.40
B- 20.35
BØ 70.00
D 102.50
42x85

RT TP



08-431600-00 STD

3.00 CK P
2.50 CR P
4.00 CR P

14-027680-00 DH
14-027681-00 DH

B 111.50 C 217.00 D 115.85 E 4.00
B 112.00 C 217.00 D 115.85 E 4.00

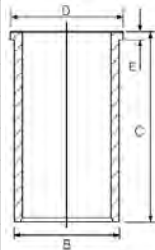

120.00

14

D 2066 LF (Euro 2/3)	6cyl.	10518cc	265-307kW (360-430PS)	Diesel Turbo Intercooled	MP16161
D 2066 LF (Euro 3)	6cyl.	10518cc	199-324kW (271-440PS)	Diesel Turbo Intercooled	MP46161
D 2066 LF04 (Euro 3)	6cyl.	10518cc	228kW (310PS)	Diesel Turbo Intercooled	TD17373
D 2066 LF07 (Euro 3)	6cyl.	10518cc	265kW (360PS)	Diesel Turbo Intercooled	TD22899
D 2066 LF48 (Euro 3)	6cyl.	10518cc	265kW (360PS)	Diesel Turbo Intercooled	TD25598
D 2066 LF49 (Euro 3)	6cyl.	10518cc	294kW (400PS)	Diesel Turbo Intercooled	TD25599
D 2066 LF50 (Euro 3)	6cyl.	10518cc	324kW (441PS)	Diesel Turbo Intercooled	TD25600
D 2066 LOH10 (Euro 3)	6cyl.	10518cc	316kW (430PS)	Diesel Turbo Intercooled	TD23073
D 2066 LOH11 (Euro 3)	6cyl.	10518cc	287kW (390PS)	Diesel Turbo Intercooled	TD23072
D 2066 LOH12 (Euro 3)	6cyl.	10518cc	257kW (350PS)	Diesel Turbo Intercooled	TD23070
D 2066 LUH07 (Euro 3)	6cyl.	10520cc	228kW (310PS)	Diesel Turbo Intercooled	TD23074
D 2066 LUH08 (Euro 3)	6cyl.	10520cc	257kW (350PS)	Diesel Turbo Intercooled	TD23075
D 2066 LUH09 (Euro 3)	6cyl.	10520cc	287kW (390PS)	Diesel Turbo Intercooled	TD23076

H92	01/09→12/14	TGA	09/02→
HOCL	01/06→12/14	TGS I	06/06→09/21





LION'S COACH SL II	08/05→10/09 01/06→10/09	TGX I TRUCK & BUS	06/06→09/21
-----------------------	----------------------------	----------------------	-------------

87-423000-10 STD

- A 76.80
- B- 20.00
- BØ 70.00
- C 2.00
- D 123.30
-  52x96
- (12081 B105)
- KK RT TP



08-423000-00 STD

- 3.50  CK P
- 3.00  CR P
- 4.00  CR P

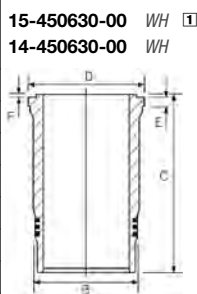

15-450630-00 WH 
14-450630-00 WH

B 139.50 C 260.00 D 150.00 E 8.07
B 139.50 C 260.00 D 150.00 E 8.07

88-423000-10
87-423000-10 +
14-450630-00

 Includes seals

 Schließt Dichtungen ein

 Inclut des joints

 Incluye los sellos

 Comprende le guarnizioni

 120.00 15

D 2066 LF01 (Euro 3)	6cyl.	10518cc	316kW (430PS)	Diesel	Turbo Intercooled	TD17370
D 2066 LF02 (Euro 3)	6cyl.	10518cc	287kW (390PS)	Diesel	Turbo Intercooled	TD17371
D 2066 LF03 (Euro 3)	6cyl.	10518cc	257kW (350PS)	Diesel	Turbo Intercooled	TD17372
D 2066 LF06 (Euro 3)	6cyl.	10518cc	294kW (400PS)	Diesel	Turbo Intercooled	TD19951
D 2066 LF11 (Euro 4)	6cyl.	10518cc	316kW (430PS)	Diesel	Turbo Intercooled	TD18098
D 2066 LF12 (Euro 4)	6cyl.	10518cc	287kW (390PS)	Diesel	Turbo Intercooled	TD18097
D 2066 LF13 (Euro 4)	6cyl.	10518cc	257kW (350PS)	Diesel	Turbo Intercooled	TD19111
D 2066 LF14 (Euro 4)	6cyl.	10518cc	228kW (310PS)	Diesel	Turbo Intercooled	TD19109
D 2066 LF29 (Euro 4)	6cyl.	10518cc	265kW (360PS)	Diesel	Turbo Intercooled	TD25603
D 2066 LF30 (Euro 4)	6cyl.	10518cc	235kW (320PS)	Diesel	Turbo Intercooled	TD25604
D 2066 LF31 (Euro 4)	6cyl.	10518cc	324kW (440PS)	Diesel	Turbo Intercooled	TD19094
D 2066 LF32 (Euro 4)	6cyl.	10518cc	294kW (400PS)	Diesel	Turbo Intercooled	TD19095
D 2066 LF33 (Euro 4)	6cyl.	10518cc	265kW (360PS)	Diesel	Turbo Intercooled	TD19096
D 2066 LF35 (Euro 4)	6cyl.	10518cc	235kW (320PS)	Diesel	Turbo Intercooled	TD19097
D 2066 LF36 (Euro 4)	6cyl.	10518cc	324kW (440PS)	Diesel	Turbo Intercooled	TD20368
D 2066 LF37 (Euro 4)	6cyl.	10518cc	294kW (400PS)	Diesel	Turbo Intercooled	TD20369
D 2066 LF38 (Euro 4)	6cyl.	10518cc	265kW (360PS)	Diesel	Turbo Intercooled	TD20370
D 2066 LF39 (Euro 4)	6cyl.	10518cc	235kW (320PS)	Diesel	Turbo Intercooled	TD20396
D 2066 LF62 (Euro 4)	6cyl.	10518cc	324kW (441PS)	Diesel	Turbo Intercooled	TD25612
D 2066 LF63 (Euro 4)	6cyl.	10518cc	294kW (400PS)	Diesel	Turbo Intercooled	TD25613
D 2066 LF64 (Euro 4)	6cyl.	10518cc	265kW (360PS)	Diesel	Turbo Intercooled	TD25614
D 2066 LF65 (Euro 4)	6cyl.	10518cc	235kW (320PS)	Diesel	Turbo Intercooled	TD25611
D 2066 LF69 (Euro 4)	6cyl.	10518cc	324kW (440PS)	Diesel	Turbo Intercooled	TD25620
D 2066 LF70 (Euro 4)	6cyl.	10518cc	294kW (400PS)	Diesel	Turbo Intercooled	TD25619
D 2066 LF71 (Euro 4)	6cyl.	10518cc	265kW (360PS)	Diesel	Turbo Intercooled	TD25618
D 2066 LF72 (Euro 4)	6cyl.	10518cc	235kW (320PS)	Diesel	Turbo Intercooled	TD25617
D 2066 LOH01 (Euro 4)	6cyl.	10520cc	235kW (320PS)	Diesel	Turbo Intercooled	TD19972
D 2066 LOH02 (Euro 4)	6cyl.	10518cc	265kW (360PS)	Diesel	Turbo Intercooled	TD19973
D 2066 LOH03 (Euro 4)	6cyl.	10518cc	294kW (400PS)	Diesel	Turbo Intercooled	TD19974
D 2066 LOH04 (Euro 4)	6cyl.	10518cc	324kW (440PS)	Diesel	Turbo Intercooled	TD19975
D 2066 LOH05 (Euro 4)	6cyl.	10518cc	225kW (320PS)	Diesel	Turbo Intercooled	TD23061
D 2066 LOH06 (Euro 4)	6cyl.	10518cc	265kW (360PS)	Diesel	Turbo Intercooled	TD23062
D 2066 LOH07 (Euro 4)	6cyl.	10518cc	294kW (400PS)	Diesel	Turbo Intercooled	TD23063
D 2066 LOH08 (Euro 4)	6cyl.	10518cc	324kW (440PS)	Diesel	Turbo Intercooled	TD23064
D 2066 LOH33 (Euro 4)	6cyl.	10518cc	235kW (320PS)	Diesel	Turbo Intercooled	TD30605
D 2066 LOH34 (Euro 4)	6cyl.	10518cc	265kW (360PS)	Diesel	Turbo Intercooled	TD30606
D 2066 LOH35 (Euro 4)	6cyl.	10518cc	294kW (400PS)	Diesel	Turbo Intercooled	TD30607





D 2066 LOH36 (Euro 4)	6cyl.	10518cc	324kW (440PS)	Diesel	Turbo Intercooled	TD30608
D 2066 LUH01 (Euro 4)	6cyl.	10520cc	228kW (310PS)	Diesel	Turbo Intercooled	TD28905
D 2066 LUH11 (Euro 4)	6cyl.	10520cc	199kW (271PS)	Diesel	Turbo Intercooled	TD19976
D 2066 LUH12 (Euro 4)	6cyl.	10520cc	228kW (310PS)	Diesel	Turbo Intercooled	TD19977
D 2066 LUH13 (Euro 4)	6cyl.	10520cc	257kW (350PS)	Diesel	Turbo Intercooled	TD19978
D 2066 LUH14 (Euro 4)	6cyl.	10520cc	287kW (390PS)	Diesel	Turbo Intercooled	TD19979
D 2066 LUH15 (Euro 4)	6cyl.	10520cc	316kW (430PS)	Diesel	Turbo Intercooled	TD19980
D 2066 LUH21 (Euro 4)	6cyl.	10518cc	199kW (271PS)	Diesel	Turbo Intercooled	TD22860
D 2066 LUH22 (Euro 4)	6cyl.	10518cc	228kW (310PS)	Diesel	Turbo Intercooled	TD23065
D 2066 LUH23 (Euro 4)	6cyl.	10518cc	257kW (350PS)	Diesel	Turbo Intercooled	TD23066
D 2066 LUH24 (Euro 4)	6cyl.	10518cc	287kW (390PS)	Diesel	Turbo Intercooled	TD23067

A-Series	05/06→	NG	01/06→12/14
Centroliner	10/98→	NL	01/06→10/09
Cityliner	09/06→	PANTHER	01/06→
DIAMOND	01/06→	SÜ	01/06→10/09
ECT	02/05→	TGA	12/00→
HOCL	01/06→	TGS I	10/05→
LION'S CITY	01/06→12/14	TGX I	06/06→
LION S MEX	01/06→12/12	Tourliner	06/06→

87-423000-00 STD

- A 76.80
- B- 19.70
- BØ 76.00
- C 2.00
- D 123.30
- E 52x96

(12081B154)

KK RT TP



08-423000-00 STD

- 3.50 CK P
- 3.00 CR P
- 4.00 CR P

15-450630-00 WH 1

14-450630-00 WH

B 139.50 C 260.00 D 150.00 E 8.07

B 139.50 C 260.00 D 150.00 E 8.07

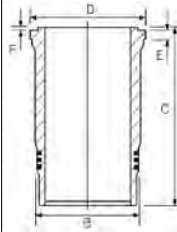

88-423000-00

87-423000-00 +
14-450630-00

1 Includes seals

1 Schließt Dichtungen ein

1 Inclut des joints

1 Incluye los sellos

1 Comprende le guarnizioni

120.00

16

D 2066 LF17 (Euro 5)	6cyl.	10518cc	324kW (440PS)	Diesel	Turbo Intercooled	TD23081
D 2066 LF18 (Euro 5)	6cyl.	10518cc	294kW (400PS)	Diesel	Turbo Intercooled	TD23083
D 2066 LF19 (Euro 5)	6cyl.	10518cc	265kW (360PS)	Diesel	Turbo Intercooled	TD23084
D 2066 LF20 (Euro 5)	6cyl.	10518cc	235kW (320PS)	Diesel	Turbo Intercooled	TD23085
D 2066 LF21 (Euro 5)	6cyl.	10518cc	321kW (437PS)	Diesel	Turbo Intercooled	TD20230
D 2066 LF22 (Euro 5)	6cyl.	10518cc	294kW (400PS)	Diesel	Turbo Intercooled	TD20229
D 2066 LF23 (Euro 5)	6cyl.	10518cc	324kW (440PS)	Diesel	Turbo Intercooled	TD19098
D 2066 LF24 (Euro 5)	6cyl.	10518cc	294kW (400PS)	Diesel	Turbo Intercooled	TD19099
D 2066 LF26 (Euro 5)	6cyl.	10518cc	294kW (400PS)	Diesel	Turbo Intercooled	TD20364
D 2066 LF27 (Euro 5)	6cyl.	10518cc	265kW (360PS)	Diesel	Turbo Intercooled	TD20365
D 2066 LF28 (Euro 5)	6cyl.	10518cc	235kW (320PS)	Diesel	Turbo Intercooled	TD20366
D 2066 LF40 (Euro 5)	6cyl.	10518cc	324kW (440PS)	Diesel	Turbo Intercooled	TD23119
D 2066 LF41 (Euro 5)	6cyl.	10518cc	294kW (400PS)	Diesel	Turbo Intercooled	TD23104
D 2066 LF42 (Euro 5)	6cyl.	10518cc	265kW (360PS)	Diesel	Turbo Intercooled	TD23094
D 2066 LF43 (Euro 5)	6cyl.	10518cc	235kW (320PS)	Diesel	Turbo Intercooled	TD23003
D 2066 LF44 (Euro 5)	6cyl.	10518cc	324kW (440PS)	Diesel	Turbo Intercooled	TD25456
D 2066 LF45 (Euro 5)	6cyl.	10518cc	294kW (400PS)	Diesel	Turbo Intercooled	TD25455
D 2066 LF46 (Euro 5)	6cyl.	10518cc	265kW (360PS)	Diesel	Turbo Intercooled	TD25454
D 2066 LF47 (Euro 5)	6cyl.	10518cc	235kW (320PS)	Diesel	Turbo Intercooled	TD25453
D 2066 LF51 (Euro 5)	6cyl.	10518cc	294kW (400PS)	Diesel	Turbo Intercooled	TD23436
D 2066 LF52 (Euro 5)	6cyl.	10518cc	265kW (360PS)	Diesel	Turbo Intercooled	TD23437





D 2066 LF53 (Euro 5)	6cyl.	10518cc	235kW (320PS)	Diesel	Turbo Intercooled	TD23438
D 2066 LOH28 (Euro 5)	6cyl.	10518cc	294kW (400PS)	Diesel	Turbo Intercooled	TD23396
D 2066 LUH32 (Euro 5)	6cyl.	10518cc	235kW (320PS)	Diesel	Turbo Intercooled	TD23683
D 2066 LUH33 (Euro 5)	6cyl.	10518cc	265kW (360PS)	Diesel	Turbo Intercooled	TD23684
D 2066 LUH34 (Euro 5)	6cyl.	10518cc	294kW (400PS)	Diesel	Turbo Intercooled	TD23685



Centroliner	10/98→	ND	06/13→
C Series	10/10→	SÜ	09/03→
HOCL	01/06→	TGA	02/04→
LEMBERG	01/12→	TGS I	06/06→09/21
LION'S CITY	05/07→	TGX I	06/06→
LION'S COACH	05/07→	T-Serie	10/05→
L Series	10/10→		

87-428600-00 STD ①

A 76.80
B- 19.70
BØ 68.77
C 2.00
C 1.60
D 123.30

 52x96
 (12081B113)
KK RT TP

08-428600-00 STD

3.50  CK P
 3.00  CR P
 4.00  CR P

15-450630-00 WH ②
14-450630-00 WH

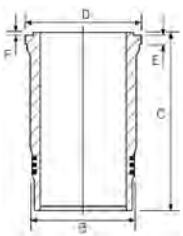

B 139.50 **C** 260.00 **D** 150.00 **E** 8.07
B 139.50 **C** 260.00 **D** 150.00 **E** 8.07

88-428600-00
 87-428600-00 +
 14-450630-00
89-428600-00 ②
 87-428600-00 +
 15-450630-00

① OE 51.02500-6263 ② Schließt Dichtungen ein ③ OE 51.02500-6263 ④ Incluye los sellos ⑤ OE 51.02500-6263
 ② Includes seals ② Schließt Dichtungen ein ② Inclut des joints ② Incluye los sellos ② Comprende le guarnizioni

120.00 **17**



D 2066 LF25 (Euro 5)	6cyl.	10518cc	324kW (440PS)	Diesel	Turbo Intercooled	TD20363
TGA	05/04→	TGX I	06/06→09/21			
TGS I	06/06→09/21					

87-428600-00 STD ①

A 76.80
B- 19.70
BØ 68.77
C 2.00
C 1.60
D 123.30

 52x96
 (12081B113)
KK RT TP

08-428600-00 STD

3.50  CK P
 3.00  CR P
 4.00  CR P

15-450630-00 WH ②
14-450630-00 WH

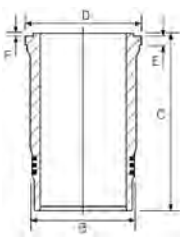

B 139.50 **C** 260.00 **D** 150.00 **E** 8.07
B 139.50 **C** 260.00 **D** 150.00 **E** 8.07



88-428600-00
 87-428600-00 +
 14-450630-00
89-428600-00 ②
 87-428600-00 +
 15-450630-00

87-451700-00 STD ③

A 76.800mm
B- 19.700mm
BØ 68.767mm
C 1.600mm
C 2.000mm
D 123.300mm

 52.00mmx96.00mm
KK RT TP

08-451700-00 STD

3.50mm  PVD ④
 3.00mm  CR
 4.00  CR

15-450630-00 WH ②
14-450630-00 WH



B 139.50 **C** 260.00 **D** 150.00 **E** 8.07
B 139.50 **C** 260.00 **D** 150.00 **E** 8.07

88-428600-00
 87-428600-00 +
 14-450630-00
89-428600-00 ②
 87-428600-00 +
 15-450630-00

① OE 51.02500-6263 ② Schließt Dichtungen ein ③ OE 51.02500-6296 ④ Incluye los sellos ⑤ OE 51.02500-6296
 ② Includes seals ② Schließt Dichtungen ein ③ OE 51.02500-6296 ④ Incluye los sellos ⑤ OE 51.02500-6296
 ③ Steel ④ Stahl ④ Acier ④ Acciaio



120.00

18

D 2066 LF57	6cyl.	10518cc	324kW (440PS)	Diesel	Turbo Intercooled	TD25452
D 2066 LF58	6cyl.	10518cc	294kW (400PS)	Diesel	Turbo Intercooled	TD25451
D 2066 LF59	6cyl.	10518cc	265kW (360PS)	Diesel	Turbo Intercooled	TD23688
D 2066 LF60	6cyl.	10518cc	235kW (320PS)	Diesel	Turbo Intercooled	TD23689
D 2066 LOH26	6cyl.	10518cc	235kW (320PS)	Diesel	Turbo Intercooled	TD23672
D 2066 LOH27	6cyl.	10518cc	265kW (360PS)	Diesel	Turbo Intercooled	TD23673
HOCL		01/06→	TGS I			06/06→09/21
LION'S COACH		08/05→12/14	TGX I			06/06→09/21
SL II		05/07→05/14				

15-450630-00 WH ① B 139.50 C 260.00 D 150.00 E 8.07
 14-450630-00 WH B 139.50 C 260.00 D 150.00 E 8.07

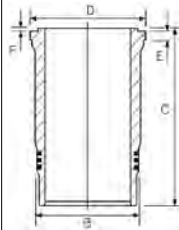

① Includes seals ① Schließt Dichtungen ein ① Inclut des joints ① Incluye los sellos ① Comprende le guarnizioni

120.00

19

D 2066 LF61 (Euro 6)	6cyl.	10518cc	294kW (400PS)	Diesel	Turbo Intercooled	TD27711
D 2066 LF67 (Euro 6)	6cyl.	10518cc	265kW (360PS)	Diesel	Turbo Intercooled	TD27712
D 2066 LF76 (Euro 6)	6cyl.	10518cc	294kW (400PS)	Diesel	Turbo Intercooled	TD31921
D 2066 LF77 (Euro 6)	6cyl.	10518cc	265kW (360PS)	Diesel	Turbo Intercooled	TD31922
D 2066 LF80 (Euro 6)	6cyl.	10518cc	265kW (360PS)	Diesel	Turbo Intercooled	TD31924
D 2066 LF83 (Euro 6)	6cyl.	10518cc	265kW (360PS)	Diesel	Turbo Intercooled	TD31926
D 2066 LF85 (Euro 6)	6cyl.	10518cc	265kW (360PS)	Diesel	Turbo Intercooled	TD34871
D 2066 LF92 (Euro 6)	6cyl.	10518cc	265kW (360PS)	Diesel	Turbo Intercooled	TD38379
D 2066 LOH31 (Euro 6)	6cyl.	10518cc	265kW (360PS)	Diesel	Turbo Intercooled	TD30599
D 2066 LOH32 (Euro 6)	6cyl.	10518cc	294kW (400PS)	Diesel	Turbo Intercooled	TD30600
D 2066 LUH30 (Euro 6)	6cyl.	10518cc	324kW (441PS)	Diesel	Turbo Intercooled	TD41161
D 2066 LUH31 (Euro 6)	6cyl.	10518cc	353kW (480PS)	Diesel	Turbo Intercooled	TD41162
D 2066 LUH52 (Euro 6)	6cyl.	10518cc	265kW (360PS)	Diesel	Turbo Intercooled	TD30515
D 2066 LUH53 (Euro 6)	6cyl.	10518cc	294kW (400PS)	Diesel	Turbo Intercooled	TD30516
LION'S CITY		05/07→	ND			06/13→
LION'S COACH		01/06→	TGS I			06/06→09/21
LION'S REGIO		01/15→	TGX I			06/06→

87-441600-00 STD

- A 76.80
- B- 22.46
- BØ 66.00
- C 2.00
- C 1.60
- D 123.30
- 52x96



KK NB RT TP

08-441600-00 STD

- 3.50 PVD NT ①
- 2.50 NT ①
- 3.50 NT ①



① Steel ① Stahl ① Acier ① Acero ① Acciaio

120.00

20

D 2066 LUH41	6cyl.	10518cc	206kW (280PS)	Diesel	Turbo Intercooled	TD23963
D 2066 LUH42	6cyl.	10518cc	235kW (320PS)	Diesel	Turbo Intercooled	TD23964





D 2066 LUH43	6cyl.	10518cc	257-265kW (350-360PS)	Diesel	Turbo Intercooled	TD23965
D 2066 LUH46	6cyl.	10518cc	206kW (280PS)	Diesel	Turbo Intercooled	TD23674
D 2066 LUH47	6cyl.	10518cc	235kW (320PS)	Diesel	Turbo Intercooled	TD23675
D 2066 LUH48	6cyl.	10518cc	265kW (360PS)	Diesel	Turbo Intercooled	TD23676
AVANCITY		10/08→	LION'S CITY			05/07→
Centroliner		10/98→	ND			06/13→
HOCL		05/07→	NG			05/07→12/14
LANDER		03/08→	NL			05/07→

87-428600-10 STD ¹

- A 76.80
- B- 11.39
- B- 22.45
- BØ 68.00
- C 2.00
- D 123.30
-  52x96



(12081 B167)
KK RT TP

08-428600-00 STD

- 3.50  CK P
- 3.00  CR P
- 4.00  CR P

15-450630-00 WH ²

14-450630-00 WH

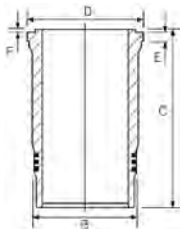

B 139.50 C 260.00 D 150.00 E 8.07

B 139.50 C 260.00 D 150.00 E 8.07

¹ Bowl capacity 90.10cm³
² Includes seals

¹ Volumen der Kolbenmulde 90.10cm³
² Schließt Dichtungen ein

¹ Volume de la cavité du piston 90.10cm³
² Inclut des joints

¹ Vol. cavidad pistón 90.10cm³
² Incluye los sellos

¹ Volume camera pistone 90.10cm³
² Comprende le guarnizioni

121.00

21

D 2146	6cyl.	9660cc	123kW (186PS)	Diesel		TD7666
D 2156 HM2	6cyl.	10344cc	141-173kW (192-235PS)	Diesel		TD23165
D 2156 HM3	6cyl.	10344cc	158-169kW (215-230PS)	Diesel		TD7675
D 2156 HM9	6cyl.	10344cc	158-169kW (215-230PS)	Diesel		TD7734
D 2156 HMN1	6cyl.	10344cc	158kW (215PS)	Diesel		TD7700
D 2156 HMN6	6cyl.	10344cc	172kW (235PS)	Diesel		TD8783
D 2156 HNY	6cyl.	10344cc	141-169kW (192-230PS)	Diesel		TD19066
D 2156 MGN	6cyl.	10344cc	141-169kW (192-230PS)	Diesel		TD19067
D 2156 MNY	6cyl.	10344cc	141-169kW (192-230PS)	Diesel		TD19068
D 2156 MTN1	6cyl.	10344cc	188kW (256PS)	Diesel	Turbo Intercooled	TD7715
D 2156 MTX	6cyl.	10344cc	188kW (256PS)	Diesel	Turbo	TD19116
D 2156 MY	6cyl.	10344cc	141-169kW (192-230PS)	Diesel		TD19069
D 2156 MYN	6cyl.	10344cc	141-169kW (192-230PS)	Diesel		TD19070
D 2156 MYN-31	6cyl.	10344cc	141kW (192PS)	Diesel		TD7697

14-022830-00 DH

B 125.99 C 287.00 D 132.00 E 8.00

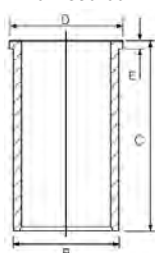

125.00

22

D 2555 M	5cyl.	9200cc	123kW (168PS)	Diesel		TD7708
D 2555 MF	5cyl.	9200cc	123kW (168PS)	Diesel		TD7703
D 2555 MX	5cyl.	9200cc	141kW (192PS)	Diesel		TD7710
D 2555 MXF	5cyl.	9200cc	141kW (192PS)	Diesel		TD7705
D 2556 M	6cyl.	11045cc	147kW (200PS)	Diesel		TD7730





D 2556 MX	6cyl.	11045cc	147-194kW (200-264PS)	Diesel	TD7733
D 2556 MXF	6cyl.	11045cc	172-177kW (232-240PS)	Diesel	TD7731
D 2556 MXUH/175	6cyl.	11045cc	129kW (175PS)	Diesel	TD7613
D 2556 MXUH/192	6cyl.	11045cc	141kW (192PS)	Diesel	TD7606
D 2556 MXUH/240	6cyl.	11045cc	177kW (240PS)	Diesel	TD7607
D 2556 MXUM	6cyl.	11045cc	161kW (220PS)	Diesel	TD7439
D 2565 MR	5cyl.	9510cc	141kW (192PS)	Diesel	TD23168
D 2565 MUE	5cyl.	9510cc	141kW (192PS)	Diesel	TD23169
D 2566 UH	6cyl.	11413cc	155kW (211PS)	Diesel	TD7616

SD 04/74→04/94 SL II 06/84→04/93

14-450370-00 WH B 140.00 C 270.00 D 152.00 E 10.05 F 1.00

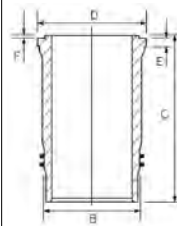

125.00 **23**

D 2565 HM	5cyl.	9510cc	92-141kW (125-192PS)	Diesel	TD19039
D 2565 M	5cyl.	9510cc	141kW (192PS)	Diesel	TD7711
D 2565 ME	5cyl.	9510cc	84-141kW (114-192PS)	Diesel	TD19040
D 2565 MF	5cyl.	9510cc	141kW (192PS)	Diesel	TD7706
D 2565 MFR	5cyl.	9510cc	92-141kW (125-192PS)	Diesel	TD19041
D 2565 MUH	5cyl.	9510cc	92-141kW (125-192PS)	Diesel	TD19042
D 2565 MUL	5cyl.	9510cc	141kW (192PS)	Diesel	TD7721
D 2566 M	6cyl.	11413cc	177kW (240PS)	Diesel	TD7735
D 2566 ME	6cyl.	11413cc	125-177kW (170-241PS)	Diesel	TD19451
D 2566 MF	6cyl.	11413cc	177kW (240PS)	Diesel	TD7732
D 2566 MH	6cyl.	11413cc	177kW (240PS)	Diesel	TD7414
D 2566 MUE	6cyl.	11413cc	125-177kW (170-241PS)	Diesel	TD19452
D 2566 MUH	6cyl.	11413cc	177kW (240PS)	Diesel Turbo	TD7407
D 2566 MUL	6cyl.	11413cc	177kW (240PS)	Diesel	TD7803
D 2566 MUM	6cyl.	11413cc	147-177kW (200-241PS)	Diesel	TD7440
D 2566 MXF	6cyl.	11413cc	125-177kW (211-241PS)	Diesel	TD19043

F9 01/83→12/86

87-280200-10 STD

- A 89.87
- B- 45.87
- BØ 49.50
- D 141.87
- 46x105
- (12572)
- AK HA RT**



08-280200-00 STD

- 3.00 CR P
- 3.00 P
- 5.00 CR P

14-450370-00 WH

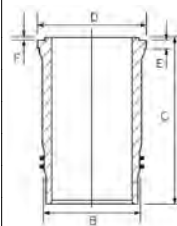

B 140.00 C 270.00 D 152.00 E 10.05 F 1.00

89-280200-10
87-280200-10 +
14-450370-00

Includes seals

Schließt Dichtungen ein

Inclut des joints

Incluye los sellos

Comprende le guarnizioni

125.00 **24**

D 2565 MK	5cyl.	9510cc	169kW (230PS)	Diesel Turbo	TD19117
------------------	-------	---------------	----------------------	---------------------	----------------





D 2565 MKUL	5cyl.	9510cc	169kW (230PS)	Diesel	Turbo	TD19072
D 2565 MT	5cyl.	9510cc	169kW (230PS)	Diesel	Turbo	TD19073
D 2566 MK	6cyl.	11413cc	235kW (320PS)	Diesel	Turbo	TD7801
D 2566 MKF	6cyl.	11413cc	235kW (320PS)	Diesel	Turbo Intercooled	TD7758
D 2566 MKUH/320	6cyl.	11413cc	235kW (320PS)	Diesel	Turbo Intercooled	TD7633
D 2566 MKUL	6cyl.	11413cc	235kW (320PS)	Diesel	Turbo Intercooled	TD7804
D 2566 MLUH	6cyl.	11413cc	192kW (260PS)	Diesel	Turbo Intercooled	TD7632
D 2566 MLUM	6cyl.	11413cc	227kW (310PS)	Diesel	Turbo Intercooled	TD7625
D 2566 MT	6cyl.	11413cc	206kW (280PS)	Diesel	Turbo	TD7799
D 2566 MTE	6cyl.	11413cc	162-235kW (220-320PS)	Diesel	Turbo	TD19074
D 2566 MTF	6cyl.	11413cc	206kW (280PS)	Diesel	Turbo	TD7738
D 2566 MTH	6cyl.	11413cc	213kW (290PS)	Diesel	Turbo	TD7418
D 2566 MTHO	6cyl.	11413cc	206-235kW (280-320PS)	Diesel	Turbo	TD7744
D 2566 MTUH	6cyl.	11413cc	206-235kW (280-320PS)	Diesel	Turbo	TD7603
AS 280			01/80→12/87	SR		01/77→11/86
Favorit			01/81→12/85	SÜ		11/82→01/86
SG			09/81→			

87-280400-00 STD

- A** 89.80
- B-** 43.00
- BØ** 52.50
- C** 1.70
- D** 141.80
-  **F** 46x105



(12574)
AK HA KK RT

08-280400-10 STD

- 3.50  CR P
- 3.00  P
- 5.00  CR P

14-450370-00 WH

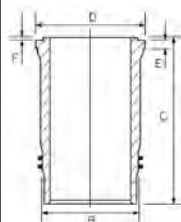

B 140.00 C 270.00 D 152.00 E 10.05 F 1.00

89-280400-00 

87-280400-00 +
14-450370-00

 Includes seals

 Schließt Dichtungen ein

 Inclut des joints

 Incluye los sellos

 Comprende le guarnizioni

 **125.00**

25

D 2530 ME	V10cyl.	15945cc	156-235kW (212-320PS)	Diesel		TD19446
D 2530 MF	V10cyl.	15945cc	235kW (320PS)	Diesel		TD5650
D 2530 MTE	V10cyl.	15953cc	223-294kW (303-400PS)	Diesel	Turbo	TD19065
D 2530 MTXF	V10cyl.	15953cc	294kW (400PS)	Diesel	Turbo	TD7813
D 2530 MTXF/360	V10cyl.	15900cc	265kW (360PS)	Diesel	Turbo	TD7760
D 2530 MXF	V10cyl.	15945cc	156-235kW (212-320PS)	Diesel		TD19038
D 2538 M	V8cyl.	12763cc	188kW (256PS)	Diesel		TD7743
D 2538 ME	V8cyl.	12763cc	188kW (256PS)	Diesel		TD19447
D 2538 MF	V8cyl.	12763cc	188kW (256PS)	Diesel		TD7737
D 2538 MT	V8cyl.	12763cc	178-235kW (242-320PS)	Diesel	Turbo	TD7748
D 2538 MTE	V8cyl.	12763cc	178-235kW (242-320PS)	Diesel	Turbo	TD19064
D 2540 MT	V10cyl.	17426cc	287-324kW (390-441PS)	Diesel	Turbo	TD19448
D 2540 MTF	V10cyl.	17426cc	324kW (440PS)	Diesel	Turbo	TD7814
D 2542 MLE	V12cyl.	20911cc	420-515kW (571-700PS)	Diesel	Turbo Intercooled	TD19449
D 2542 MTE	V12cyl.	20911cc	283-405kW (385-551PS)	Diesel	Turbo	TD19450





14-451090-00 WH B 140.00 C 253.00 D 152.00 E 10.05 F 1.00

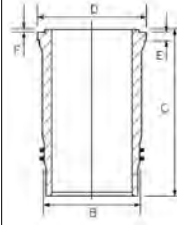

126.00

26

D 2676 LF01 (Euro 4)	6cyl.	12419cc	353kW (480PS)	Diesel	Turbo Intercooled	TD19100
D 2676 LF02 (Euro 3)	6cyl.	12419cc	353kW (480PS)	Diesel	Turbo Intercooled	TD20542
D 2676 LF03 (Euro 2)	6cyl.	12419cc	353kW (480PS)	Diesel	Turbo Intercooled	TD20543
D 2676 LF04 (Euro 2)	6cyl.	12419cc	324-324kW (440-441PS)	Diesel	Turbo Intercooled	TD22906
D 2676 LF05 (Euro 4)	6cyl.	12419cc	353kW (480PS)	Diesel	Turbo Intercooled	TD20371
D 2676 LF07 (Euro 5)	6cyl.	12419cc	353kW (480PS)	Diesel	Turbo Intercooled	TD23137
D 2676 LF10 (Euro 4)	6cyl.	12419cc	324kW (440PS)	Diesel	Turbo Intercooled	TD27718
D 2676 LF12 (Euro 4)	6cyl.	12419cc	353kW (480PS)	Diesel	Turbo Intercooled	TD19103
D 2676 LF14 (Euro 5)	6cyl.	12419cc	353kW (480PS)	Diesel	Turbo Intercooled	TD20373
D 2676 LF16 (Euro 5)	6cyl.	12419cc	353kW (480PS)	Diesel	Turbo Intercooled	TD23088
D 2676 LF18	6cyl.	12419cc	353kW (480PS)	Diesel	Turbo Intercooled	TD25461
D 2676 LF20 (Euro 4)	6cyl.	12419cc	353kW (480PS)	Diesel	Turbo Intercooled	TD25616
D 2676 LF21 (Euro 5)	6cyl.	12419cc	353kW (480PS)	Diesel	Turbo Intercooled	TD23691
D 2676 LF22 (Euro 5)	6cyl.	12419cc	324kW (441PS)	Diesel	Turbo Intercooled	TD23692
D 2676 LF25 (Euro 6)	6cyl.	12419cc	353kW (480PS)	Diesel	Turbo Intercooled	TD27720
D 2676 LF26 (Euro 6)	6cyl.	12419cc	324kW (441PS)	Diesel	Turbo Intercooled	TD27722
D 2676 LF28 (Euro 5)	6cyl.	12419cc	324kW (440PS)	Diesel	Turbo Intercooled	TD27723
D 2676 LF31 (Euro 3)	6cyl.	12419cc	353kW (480PS)	Diesel	Turbo Intercooled	TD25610
D 2676 LF32 (Euro 4)	6cyl.	12419cc	397kW (540PS)	Diesel	Turbo Intercooled	TD25621
D 2676 LF33 (Euro 4)	6cyl.	12419cc	353kW (480PS)	Diesel	Turbo Intercooled	TD25623

TGA 02/04→ TGX I 06/06→
TGS I 06/06→

87-431000-00 STD 1

- A 76.25
- B- 20.10
- BØ 71.40
- C 2.00
- D 121.84
- 52x103

AK KK NB RT



08-431000-00 STD

- 4.00 GDC P
- 3.00 CR P
- 4.00 CR P



15-451040-00 WH 2
14-451040-00 WH

B 139.50 C 257.50 D 150.00 E 8.07
B 139.50 C 257.50 D 150.00 E 8.07

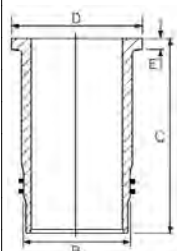

89-431000-00 2
87-431000-00 +
15-451040-00





87-443200-00 STD

- A 76.20
- B- 22.00
- BØ 73.25
- C 2.00
- D 121.80
-  52x103



AK KK NB

08-443200-00 STD

- 3.50  PVD NT
- 2.50  NT
- 3.50  NT^③

① Bowl diameter = 95mm

① Muldendurchmesser = 95mm

① Diamètre de la cuvette = 95mm

① Diámetro de cámara = 95mm

① Diametro camera di combustione = 95 mm

② Includes seals

② Schließt Dichtungen ein

② Inclut des joints

② Incluye los sellos

② Comprende le guarnizioni

③ Steel

③ Stahl

③ Acier

③ Acero

③ Acciaio

126.00

27

D 2676 LF06 (Euro 5)	6cyl.	12419cc	397kW (540PS)	Diesel	Turbo Intercooled	TD23145
D 2676 LF08 (Euro 5)	6cyl.	12419cc	397kW (540PS)	Diesel	Turbo Intercooled	TD25462
D 2676 LF11 (Euro 4)	6cyl.	12419cc	397kW (540PS)	Diesel	Turbo Intercooled	TD19104
D 2676 LF13 (Euro 5)	6cyl.	12419cc	397kW (540PS)	Diesel	Turbo Intercooled	TD20372
D 2676 LF15 (Euro 5)	6cyl.	12419cc	397kW (540PS)	Diesel	Turbo Intercooled	TD23087
D 2676 LF17	6cyl.	12419cc	397kW (540PS)	Diesel	Turbo Intercooled	TD25460
D 2676 LF19 (Euro 4)	6cyl.	12419cc	397kW (540PS)	Diesel	Turbo Intercooled	TD25615

TGA 01/06→ TGX I 06/06→

TGX I 06/06→09/21

87-431000-00 STD ^①

- A 76.25
- B- 20.10
- BØ 71.40
- C 2.00
- D 121.84
-  52x103



AK KK NB RT

08-431000-00 STD

- 4.00  GDC P
- 3.00  CR P
- 4.00  CR P



① Bowl diameter = 95mm

① Muldendurchmesser = 95mm

① Diamètre de la cuvette = 95mm

① Diámetro de cámara = 95mm

① Diametro camera di combustione = 95 mm

② Includes seals

② Schließt Dichtungen ein

② Inclut des joints

② Incluye los sellos

② Comprende le guarnizioni

126.00

28

D 2676 LF35 (Euro 6)	6cyl.	12419cc	353kW (480PS)	Diesel	Turbo Intercooled	TD31931
D 2676 LF36 (Euro 6)	6cyl.	12419cc	324kW (440PS)	Diesel	Turbo Intercooled	TD31932
D 2676 LF45 (Euro 6)	6cyl.	12419cc	353kW (480PS)	Diesel	Turbo Intercooled	TD31933
D 2676 LF46 (Euro 6)	6cyl.	12419cc	324kW (440PS)	Diesel	Turbo Intercooled	TD31934
D 2676 LF47 (Euro 6)	6cyl.	12419cc	294kW (400PS)	Diesel	Turbo Intercooled	TD31935
D 2676 LF48 (Euro 6)	6cyl.	12419cc	353kW (480PS)	Diesel	Turbo Intercooled	TD31936
D 2676 LF49 (Euro 6)	6cyl.	12419cc	324kW (440PS)	Diesel	Turbo Intercooled	TD31937
D 2676 LF50 (Euro 6)	6cyl.	12419cc	294kW (400PS)	Diesel	Turbo Intercooled	TD31938
D 2676 LF54 (Euro 6)	6cyl.	12419cc	353kW (480PS)	Diesel	Turbo Intercooled	TD31939
D 2676 LF55 (Euro 6)	6cyl.	12419cc	324kW (440PS)	Diesel	Turbo Intercooled	TD31940
D 2676 LF56 (Euro 6)	6cyl.	12419cc	353kW (480PS)	Diesel	Turbo Intercooled	TD31941
D 2676 LF57 (Euro 6)	6cyl.	12419cc	324kW (440PS)	Diesel	Turbo Intercooled	TD31942
D 2676 LF58 (Euro 6)	6cyl.	12419cc	294kW (400PS)	Diesel	Turbo Intercooled	TD31943
D 2676 LOH31 (Euro 6)	6cyl.	12419cc	353kW (480PS)	Diesel	Turbo Intercooled	TD30485

LION'S COACH 10/15→ TGX I 06/06→12/21

TGX I 06/06→09/21





87-443200-00 STD

A 76.20
B- 22.00
BØ 73.25
C 2.00
D 121.80
 52x103



AK KK NB

① Steel

① Stahl

08-443200-00 STD

3.50  PVD NT
2.50  NT
3.50  NT ①

① Acier

① Acero

① Acciaio

 126.00

29

D 2676 LOH01 (Euro 4)	6cyl.	12419cc	338kW (460PS)	Diesel	Turbo Intercooled	TD19102
D 2676 LOH02 (Euro 4)	6cyl.	12419cc	353kW (480PS)	Diesel	Turbo Intercooled	TD19101
D 2676 LOH03 (Euro 4)	6cyl.	12419cc	338kW (460PS)	Diesel	Turbo Intercooled	TD23068
D 2676 LOH04 (Euro 4)	6cyl.	12419cc	353kW (480PS)	Diesel	Turbo Intercooled	TD23069
D 2676 LOH10 (Euro 3)	6cyl.	12419cc	338kW (460PS)	Diesel	Turbo Intercooled	TD23077
D 2676 LOH26 (Euro 5)	6cyl.	12419cc	324kW (440PS)	Diesel	Turbo Intercooled	TD23400
D 2676 LOH27 (Euro 5)	6cyl.	12419cc	353kW (480PS)	Diesel	Turbo Intercooled	TD23401

HOCL
LION'S COACH

01/06→
03/06→12/14

LION S MEX
T-Serie

03/06→12/12
10/05→

87-431000-10 STD ①

A 76.25
B- 20.00
BØ 70.90
C 2.00
D 121.84
 52x103



AK KK NB RT

08-431000-00 STD

4.00  GDC P
3.00  CR P
4.00  CR P

15-451040-00 WH ②
14-451040-00 WH

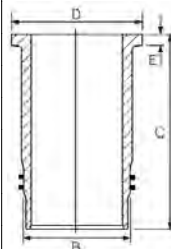

B 139.50 C 257.50 D 150.00 E 8.07
B 139.50 C 257.50 D 150.00 E 8.07

89-431000-10 ②
87-431000-10 +
15-451040-00

87-443200-00 STD

A 76.20
B- 22.00
BØ 73.25
C 2.00
D 121.80
 52x103



AK KK NB

08-443200-00 STD

3.50  PVD NT
2.50  NT
3.50  NT ③

① Bowl diameter = 95mm

① Muldendurchmesser = 95mm

① Diamètre de la cuvette = 95mm

① Diámetro de cámara = 95mm

① Diametro camera di combustione = 95 mm

② Includes seals

② Schließt Dichtungen ein

② Includ des joints

② Incluye los sellos

② Comprende le guarnizioni

③ Steel

③ Stahl

③ Acier

③ Acero

③ Acciaio

 126.00

30

D 2676 LOH28 (Euro 5)	6cyl.	12419cc	371kW (505PS)	Diesel	Turbo Intercooled	TD23678
-----------------------	-------	---------	---------------	--------	-------------------	---------





87-431000-10 STD ①

- A 76.25
- B- 20.00
- BØ 70.90
- C 2.00
- D 121.84
- 52x103



AK KK NB RT

08-431000-00 STD

- 4.00 GDC P
- 3.00 CR P
- 4.00 CR P



15-451040-00 WH ②
14-451040-00 WH

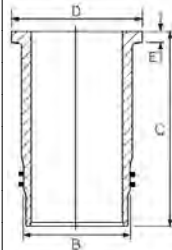

B 139.50 C 257.50 D 150.00 E 8.07
B 139.50 C 257.50 D 150.00 E 8.07

89-431000-10 ②
87-431000-10 +
15-451040-00

① Bowl diameter = 95mm

① Muldendurchmesser = 95mm

① Diamètre de la cuvette = 95mm

① Diámetro de cámara = 95mm

① Diametro camera di combustione = 95mm

② Includes seals

② Schließt Dichtungen ein

② Includ des joints

② Incluye los sellos

② Comprende le guarnizioni

128.00







31

D 2865 LF/260	5cyl.	9973cc	191kW (260PS)	Diesel	Turbo Intercooled	TD7776
D 2865 LFR	5cyl.	9973cc	191-235kW (260-320PS)	Diesel	Turbo Intercooled	TD25851
D 2865 LFR01	5cyl.	9973cc	191-235kW (260-320PS)	Diesel	Turbo Intercooled	TD25852
D 2866 KF	6cyl.	11967cc	265kW (360PS)	Diesel	Turbo Intercooled	TD5651
D 2866 KFZ	6cyl.	11967cc	265kW (360PS)	Diesel	Turbo Intercooled	TD7761
D 2866 KOH360	6cyl.	11967cc	265kW (360PS)	Diesel	Turbo Intercooled	TD16487
D 2866 KUH/360 (Euro 1)	6cyl.	11967cc	265kW (360PS)	Diesel	Turbo Intercooled	TD7591
D 2866 KUL	6cyl.	11967cc	265kW (360PS)	Diesel	Turbo Intercooled	TD7786
D 2866 LF	6cyl.	11967cc	243kW (330PS)	Diesel	Turbo Intercooled	TD28926
D 2866 LF04	6cyl.	11967cc	220kW (300PS)	Diesel	Turbo Intercooled	TD7779
D 2866 LF07	6cyl.	11967cc	213kW (290PS)	Diesel	Turbo Intercooled	TD28929
D 2866 LF08	6cyl.	11967cc	243kW (330PS)	Diesel	Turbo Intercooled	TD28930
D 2866 LF/290	6cyl.	11967cc	213kW (290PS)	Diesel	Turbo Intercooled	TD7778
D 2866 LFZ/290	6cyl.	11967cc	213kW (290PS)	Diesel	Turbo Intercooled	TD7757
D 2866 LFZ/330	6cyl.	11967cc	243kW (330PS)	Diesel	Turbo Intercooled	TD7759
D 2866 LH01	6cyl.	11967cc	220kW (299PS)	Diesel	Turbo Intercooled	TD28938
D 2866 LU	6cyl.	11967cc	243kW (330PS)	Diesel	Turbo Intercooled	TD28945
D 2866 LU07	6cyl.	11967cc	272kW (370PS)	Diesel	Turbo Intercooled	TD28948
D 2866 LU08	6cyl.	11967cc	230kW (313PS)	Diesel	Turbo Intercooled	TD28949
D 2866 LU330	6cyl.	11967cc	243kW (330PS)	Diesel	Turbo Intercooled	TD7809
D 2866 LUH	6cyl.	11967cc	243kW (330PS)	Diesel	Turbo Intercooled	TD28950
D 2866 LUH04 (Euro 1)	6cyl.	11967cc	272kW (370PS)	Diesel	Turbo Intercooled	TD28951
D 2866 LUH330	6cyl.	11967cc	243kW (330PS)	Diesel	Turbo Intercooled	TD7593
D 2866 LUL330	6cyl.	11967cc	243kW (330PS)	Diesel	Turbo Intercooled	TD7783
D 2866 LXE40	6cyl.	11967cc	190-294kW (258-400PS)	Diesel	Turbo Intercooled	TD27926
D 2866 LXE47	6cyl.	11967cc	221kW (301PS)	Diesel	Turbo Intercooled	TD27929
D 2866 T	6cyl.	11967cc	213kW (290PS)	Diesel	Turbo Intercooled	TD7580
D 2866 TOH	6cyl.	11967cc	229kW (311PS)	Diesel	Turbo Intercooled	TD7745
D 2866 TOH/290	6cyl.	11967cc	213kW (290PS)	Diesel	Turbo Intercooled	TD7746
D 2866 TOH/310	6cyl.	11967cc	229kW (311PS)	Diesel	Turbo Intercooled	TD7747
D 2866 TUH	6cyl.	11967cc	224-229kW (305-311PS)	Diesel	Turbo Intercooled	TD7186
D 2866 TUH01	6cyl.	11967cc	222kW (302PS)	Diesel	Turbo Intercooled	TD7176
D 2866 TUH/290	6cyl.	11967cc	213-224kW (290-305PS)	Diesel	Turbo Intercooled	TD7589

Cityliner	09/90→09/92	R	05/85→01/93
F90	07/86→04/95	SG	11/84→04/94
F90 Unterflur	07/86→01/91	Skyliner	09/90→09/92
HELICON	05/86→10/92	SÜ	01/86→04/93
HOCL	04/81→09/96	Transliner	09/90→09/93



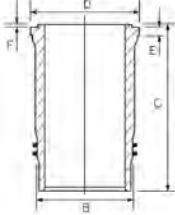



Jetliner	09/90→09/92	ÜL	09/89→03/93
87-283100-30 STD A 89.80 B- 32.20 BØ 69.60 C 2.30 D 141.80  46x105 (12828) AK RT	08-283100-00 STD 3.50 3.00 5.00  CR P P CR P	15-452920-00 WH  14-452920-00 WH 15-450030-00 WH  14-450030-00 WH 15-452930-00 WH  14-452930-00 WH 	89-283100-30  87-283100-30 + 15-452920-00 B 144.50 C 270.00 D 153.80 E 10.07 F 1.00 B 144.50 C 270.00 D 153.80 E 10.07 F 1.00 B 144.50 C 270.00 D 153.80 E 10.27 F 1.00 B 144.50 C 270.00 D 153.80 E 10.57 F 1.00 B 144.50 C 270.00 D 153.80 E 10.57 F 1.00

 Includes seals

 Schließt Dichtungen ein

 Inclut des joints

 Incluye los sellos

 Comprende le guarnizioni

128.00							32
D 2865 LF02	5cyl.	9973cc	198kW (270PS)	Diesel	Turbo Intercooled	TD7696	
D 2865 LF03	5cyl.	9973cc	235kW (320PS)	Diesel	Turbo Intercooled	TD7780	
D 2865 LF05 (Euro 1)	5cyl.	9973cc	198kW (270PS)	Diesel	Turbo Intercooled	TD7777	
D 2865 LF06 (Euro 1)	5cyl.	9973cc	235kW (320PS)	Diesel	Turbo Intercooled	TD7781	
D 2865 LF10	5cyl.	9973cc	235kW (320PS)	Diesel	Turbo Intercooled	TD28917	
D 2865 LF22 (Euro 1)	5cyl.	9973cc	198kW (270PS)	Diesel	Turbo Intercooled	TD7764	
D 2865 LF23 (Euro 1)	5cyl.	9973cc	235kW (320PS)	Diesel	Turbo Intercooled	TD7767	
D 2865 LOH01 (Euro 1)	5cyl.	9973cc	198kW (270PS)	Diesel	Turbo Intercooled	TD9087	
D 2865 LOH02 (Euro 1)	5cyl.	9973cc	235kW (320PS)	Diesel	Turbo Intercooled	TD7754	
D 2865 LOH05 (Euro 1)	5cyl.	9973cc	191-235kW (260-320PS)	Diesel	Turbo Intercooled	TD25854	
D 2865 LU01 (Euro 1)	5cyl.	9973cc	198kW (270PS)	Diesel	Turbo Intercooled	TD7724	
D 2865 LU02	5cyl.	9973cc	198kW (270PS)	Diesel	Turbo Intercooled	TD28918	
D 2865 LU03	5cyl.	9973cc	235kW (320PS)	Diesel	Turbo Intercooled	TD28919	
D 2865 LU04 (Euro 1)	5cyl.	9973cc	198kW (270PS)	Diesel	Turbo Intercooled	TD28920	
D 2865 LU06 (Euro 1)	5cyl.	9973cc	235kW (320PS)	Diesel	Turbo Intercooled	TD28921	
D 2865 LUH02 (Euro 1)	5cyl.	9973cc	198kW (270PS)	Diesel	Turbo Intercooled	TD7578	
D 2865 LUH03 (Euro 1)	5cyl.	9973cc	235kW (320PS)	Diesel	Turbo Intercooled	TD28922	
D 2865 LUH05 (Euro 1)	5cyl.	9973cc	198kW (270PS)	Diesel	Turbo Intercooled	TD7579	
D 2865 LUH06 (Euro 1)	5cyl.	9973cc	191kW (260PS)	Diesel	Turbo Intercooled	TD28923	
D 2865 LUH08 (Euro 1)	5cyl.	9973cc	235kW (320PS)	Diesel	Turbo Intercooled	TD7612	
D 2865 LXF	5cyl.	9973cc	191-235kW (260-320PS)	Diesel	Turbo Intercooled	TD25860	
D 2865 LXFR	5cyl.	9973cc	191-235kW (260-320PS)	Diesel	Turbo Intercooled	TD25861	
D 2866 LF02	6cyl.	11967cc	250kW (340PS)	Diesel	Turbo Intercooled	TD28928	
D 2866 LF03	6cyl.	11967cc	272kW (370PS)	Diesel	Turbo Intercooled	TD7787	
D 2866 LF06	6cyl.	11967cc	309kW (420PS)	Diesel	Turbo Intercooled	TD7792	
D 2866 LF09 (Euro 1)	6cyl.	11967cc	309kW (420PS)	Diesel	Turbo Intercooled	TD7793	
D 2866 LF10 (Euro 1)	6cyl.	11967cc	309kW (420PS)	Diesel	Turbo Intercooled	TD7794	
D 2866 LF15 (Euro 1)	6cyl.	11967cc	272kW (370PS)	Diesel	Turbo Intercooled	TD7789	
D 2866 LF21 (Euro 1)	6cyl.	11967cc	272kW (370PS)	Diesel	Turbo Intercooled	TD7770	
D 2866 LF22 (Euro 1)	6cyl.	11967cc	309kW (420PS)	Diesel	Turbo Intercooled	TD7772	
D 2866 LFG	6cyl.	11967cc	243kW (330PS)	Diesel	Turbo Intercooled	TD28932	
D 2866 LFG03 (Euro 1)	6cyl.	11967cc	272kW (370PS)	Diesel	Turbo Intercooled	TD28933	
D 2866 LFG04 (Euro 1)	6cyl.	11967cc	309kW (420PS)	Diesel	Turbo Intercooled	TD28934	
D 2866 LOH	6cyl.	11967cc	243-309kW (330-420PS)	Diesel	Turbo Intercooled	TD7750	





D 2866 LOH02	6cyl.	11967cc	272kW (370PS)	Diesel	Turbo Intercooled	TD28939
D 2866 LOH03	6cyl.	11967cc	309kW (420PS)	Diesel	Turbo Intercooled	TD7808
D 2866 LOH06 (Euro 1)	6cyl.	11967cc	309kW (420PS)	Diesel	Turbo Intercooled	TD7755
D 2866 LOH07	6cyl.	11967cc	272kW (370PS)	Diesel	Turbo Intercooled	TD7602
D 2866 LOH09 (Euro 1)	6cyl.	11967cc	230kW (313PS)	Diesel	Turbo Intercooled	TD28940
D 2866 LOH20 (Euro 1)	6cyl.	11967cc	309kW (420PS)	Diesel	Turbo Intercooled	TD5647
D 2866 LOH21 (Euro 1)	6cyl.	11967cc	309kW (420PS)	Diesel	Turbo Intercooled	TD28941
D 2866 LOH22 (Euro 1)	6cyl.	11967cc	272kW (370PS)	Diesel	Turbo Intercooled	TD7420
D 2866 LOH24 (Euro 1)	6cyl.	11967cc	230kW (310PS)	Diesel	Turbo Intercooled	TD7752
D 2866 LU01	6cyl.	11967cc	272kW (370PS)	Diesel	Turbo Intercooled	TD21312
D 2866 LU03 (Euro 1)	6cyl.	11967cc	272kW (370PS)	Diesel	Turbo Intercooled	TD21313
D 2866 LU04	6cyl.	11967cc	309kW (420PS)	Diesel	Turbo Intercooled	TD28947
D 2866 LUH05 (Euro 1)	6cyl.	11967cc	272kW (370PS)	Diesel	Turbo Intercooled	TD28952
D 2866 LX	6cyl.	11967cc	198-344kW (269-468PS)	Diesel	Turbo Intercooled	TD19128
D 2866 LXF	6cyl.	11967cc	198-274kW (269-372PS)	Diesel	Turbo Intercooled	TD7785
D 2866 LXFG	6cyl.	11967cc	274kW (372PS)	Diesel	Turbo Intercooled	TD28961
D 2866 LXOH	6cyl.	11967cc	265-274kW (360-373PS)	Diesel	Turbo Intercooled	TD6728
D 2866 LXU	6cyl.	11967cc	265kW (360PS)	Diesel	Turbo Intercooled	TD28962
D 2866 LXUH	6cyl.	11967cc	265kW (360PS)	Diesel	Turbo Intercooled	TD28963

Cityliner	09/90→	Megashuttle	01/94→
EOS	01/92→	NG	09/94→05/99
F90	07/86→12/97	SG	02/94→06/97
F90 Unterflur	02/90→05/94	Skyliner	09/90→
F2000	01/94→	Spaceliner	09/90→
HOCL	01/85→	SÜ	04/93→06/97
Jetliner	09/90→09/93	Transliner	09/92→
LION'S STAR	01/93→09/96	ÜL	04/92→
M90	09/91→05/95		

87-283100-00 STD

- A 89.75
- B- 24.40
- BØ 75.60
- C 2.05
- D 141.75
- 46x105



AK RT

08-283100-00 STD

- 3.50 CR P
- 3.00 P
- 5.00 CR P

- 15-452920-00 WH B 144.50 C 270.00 D 153.80 E 10.07 F 1.00
- 14-452920-00 WH B 144.50 C 270.00 D 153.80 E 10.07 F 1.00
- 15-452930-00 WH B 144.50 C 270.00 D 153.80 E 10.57 F 1.00
- 14-452930-00 WH B 144.50 C 270.00 D 153.80 E 10.57 F 1.00
- 15-450030-00 WH B 144.50 C 270.00 D 153.80 E 10.27 F 1.00
- 14-450030-00 WH B 144.50 C 270.00 D 153.80 E 10.27 F 1.00

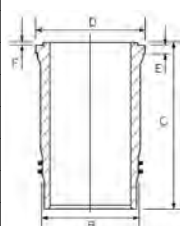

89-283100-00

- 87-283100-00 + 15-452920-00
- 89-283100-40
- 87-283100-00 + 15-452930-00

Includes seals

Schließt Dichtungen ein

Inclut des joints

Incluye los sellos

Comprende le guarnizioni

128.00

33

D 2865 LF09	5cyl.	9973cc	250kW (340PS)	Diesel	Turbo Intercooled	TD7784
D 2865 LF21 (Euro 2)	5cyl.	9973cc	250kW (340PS)	Diesel	Turbo Intercooled	TD7769
D 2865 LF24 (Euro 2)	5cyl.	9973cc	213kW (290PS)	Diesel	Turbo Intercooled	TD7766
D 2865 LUH07 (Euro 2)	5cyl.	9973cc	228kW (310PS)	Diesel	Turbo Intercooled	TD7581
D 2865 LUH09 (Euro 2)	5cyl.	9973cc	191kW (260PS)	Diesel	Turbo Intercooled	TD7594
D 2866 LF14 (Euro 2)	6cyl.	11967cc	294-309kW (400-420PS)	Diesel	Turbo Intercooled	TD21308
D 2866 LF16 (Euro 2)	6cyl.	11967cc	294-309kW (400-420PS)	Diesel	Turbo Intercooled	TD7791
D 2866 LF17 (Euro 2)	6cyl.	11967cc	260kW (354PS)	Diesel	Turbo Intercooled	TD21309





D 2866 LF20 (Euro 2)	6cyl.	11967cc	294-309kW (400-420PS)	Diesel	Turbo Intercooled	TD7771
D 2866 LF29 (Euro 2)	6cyl.	11967cc	294kW (400PS)	Diesel	Turbo Intercooled	TD21310
D 2866 LF30 (Euro 2)	6cyl.	11967cc	301kW (409PS)	Diesel	Turbo Intercooled	TD21311
D 2866 LF34 (Euro 2)	6cyl.	11967cc	228kW (310PS)	Diesel	Turbo Intercooled	TD14308
D 2866 LF35 (Euro 2)	6cyl.	11967cc	265kW (360PS)	Diesel	Turbo Intercooled	TD14311
D 2866 LF36 (Euro 2)	6cyl.	11967cc	228kW (310PS)	Diesel	Turbo Intercooled	TD16202
D 2866 LF37 (Euro 2)	6cyl.	11967cc	265kW (360PS)	Diesel	Turbo Intercooled	TD16203
D 2866 LOH23 (Euro 2)	6cyl.	11967cc	294kW (400PS)	Diesel	Turbo Intercooled	TD7592
D 2866 LOH25 (Euro 2)	6cyl.	11967cc	228kW (310PS)	Diesel	Turbo Intercooled	TD7753
D 2866 LOH26 (Euro 2)	6cyl.	11967cc	257kW (350PS)	Diesel	Turbo Intercooled	TD7590
D 2866 LUH21 (Euro 2)	6cyl.	11967cc	257kW (350PS)	Diesel	Turbo Intercooled	TD11167
D 2866 LUH22 (Euro 2)	6cyl.	11967cc	191kW (260PS)	Diesel	Turbo Intercooled	TD11133
D 2866 LUH26 (Euro 2)	6cyl.	11967cc	228kW (310PS)	Diesel	Turbo	TD11134

A-Serie	01/04→	NG	09/94→
Centroliner	01/99→	NL	11/95→
ECT	04/02→	NÜ	09/96→
EL	05/94→02/01	R	04/98→02/03
EOS	01/98→	Series 300	09/94→02/02
F90	04/94→12/97	SG	02/94→08/08
F2000	01/94→	Starliner	09/96→
HOCL	01/92→	SÜ	04/99→10/01
LION'S CITY	08/96→	TGA	04/00→
LION'S COACH	09/95→	ÜL	04/92→
LION'S COMFORT	09/96→	URBINO	01/99→
LION'S STAR	09/95→02/02		

87-283100-80 STD



- A** 89.75
- B-** 21.60
- BØ** 81.20
- C** 2.10
- D** 141.75
-  46x105

AK RT



08-283100-00 STD

- 3.50  CR P
- 3.00  P
- 5.00  CR P

- 15-452920-00** WH  B 144.50 C 270.00 D 153.80 E 10.07 F 1.00
- 14-452920-00** WH B 144.50 C 270.00 D 153.80 E 10.07 F 1.00
- 15-450030-00** WH  B 144.50 C 270.00 D 153.80 E 10.27 F 1.00
- 14-450030-00** WH B 144.50 C 270.00 D 153.80 E 10.27 F 1.00
- 15-452930-00** WH  B 144.50 C 270.00 D 153.80 E 10.57 F 1.00
- 14-452930-00** WH B 144.50 C 270.00 D 153.80 E 10.57 F 1.00

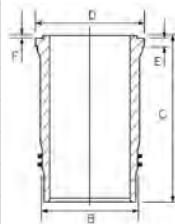

89-283100-80 

87-283100-80 +
15-452920-00

87-283100-85 STD

- A** 89.55
- B-** 21.60
- BØ** 81.20
- C** 2.10
- D** 141.55
-  46x105

AK RT



08-283100-00 STD

- 3.50  CR P
- 3.00  P
- 5.00  CR P

- 15-452920-00** WH  B 144.50 C 270.00 D 153.80 E 10.07 F 1.00
- 14-452920-00** WH B 144.50 C 270.00 D 153.80 E 10.07 F 1.00

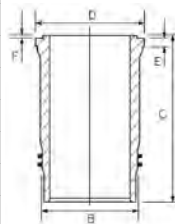



89-283100-85 

87-283100-85 +
15-452920-00

 Includes seals

 Schließt Dichtungen ein

 Inclut des joints

 Incluye los sellos

 Comprende le guarnizioni

 **128.00**

34

D 2865 LOH07 (Euro 2)	5cyl.	9973cc	191-250kW (260-340PS)	Diesel	Turbo Intercooled	TD25855
D 2865 LOH09 (Euro 2)	5cyl.	9973cc	228kW (310PS)	Diesel	Turbo Intercooled	TD25858





D 2866 F/240	6cyl.	11967cc	177kW (240PS)	Diesel		TD7775
D 2866 FG	6cyl.	11967cc	185kW (252PS)	Diesel		TD28924
D 2866 FR	6cyl.	11967cc	177-213kW (241-290PS)	Diesel		TD19127
D 2866 KOH/373	6cyl.	11967cc	274kW (373PS)	Diesel	Turbo Intercooled	TD7415
D 2866 LF01	6cyl.	11967cc	265kW (360PS)	Diesel	Turbo Intercooled	TD28927
D 2866 LFG05 (Euro 2)	6cyl.	11967cc	294kW (400PS)	Diesel	Turbo Intercooled	TD28935
D 2866 LOH31 (Euro 2)	6cyl.	11967cc	191kW (260PS)	Diesel	Turbo Intercooled	TD28942
D 2866 OH	6cyl.	11967cc	177-213kW (241-290PS)	Diesel		TD23745
D 2866 U	6cyl.	11967cc	160-180kW (218-245PS)	Diesel		TD28964
D 2866 UH	6cyl.	11967cc	177-186kW (241-253PS)	Diesel		TD7419
D 2866 UH/240	6cyl.	11967cc	177kW (240PS)	Diesel	Turbo	TD7577
D 2866 UM	6cyl.	11967cc	152-177kW (206-241PS)	Diesel		TD7174
D 2876 LF01 (Euro 2)	6cyl.	12816cc	338kW (460PS)	Diesel	Turbo Intercooled	TD28965
D 2876 LF05 (Euro 3)	6cyl.	12816cc	375kW (510PS)	Diesel	Turbo Intercooled	TD16206
D 2876 LF11 (Euro 2)	6cyl.	12816cc	338kW (460PS)	Diesel	Turbo Intercooled	TD20603
D 2876 LUE604	6cyl.	12816cc	375kW (510PS)	Diesel	Turbo Intercooled	TD27939
D 2876 LUE605	6cyl.	12816cc	338kW (460PS)	Diesel	Turbo Intercooled	TD27938
D 2876 LUE606	6cyl.	12816cc	301kW (409PS)	Diesel	Turbo Intercooled	TD27937

Cityliner	09/90→	Skyliner	09/90→
F90	01/88→06/97	SL	01/86→04/87
F2000	01/94→	SL II	05/83→04/97
HOCL	01/79→10/06	Spaceliner	09/90→
Jetliner	09/90→09/93	SÜ	01/86→04/93
M-Serie	01/96→12/01	TGA	06/99→
Series 300	09/91→02/02	Transliner	09/90→
SG	09/85→04/94	ÜL	09/89→03/93

- 15-450030-00 WH ⓘ B 144.50 C 270.00 D 153.80 E 10.27 F 1.00
- 14-450030-00 WH B 144.50 C 270.00 D 153.80 E 10.27 F 1.00
- 15-452920-00 WH ⓘ B 144.50 C 270.00 D 153.80 E 10.07 F 1.00
- 14-452920-00 WH B 144.50 C 270.00 D 153.80 E 10.07 F 1.00
- 15-452930-00 WH ⓘ B 144.50 C 270.00 D 153.80 E 10.57 F 1.00
- 14-452930-00 WH B 144.50 C 270.00 D 153.80 E 10.57 F 1.00

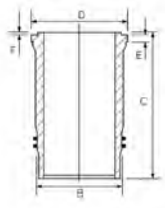

ⓘ Includes seals

ⓘ Schließt Dichtungen ein

ⓘ Inclut des joints

ⓘ Incluye los sellos

ⓘ Comprende le guarnizioni

128.00						35
D 2866 LF05 (Euro 1)	6cyl.	11967cc	272kW (370PS)	Diesel	Turbo Intercooled	TD7788
F90		02/90→12/97		F90 Unterflur		02/90→05/94





87-283100-00 STD







- A 89.75
- B- 24.40
- BØ 75.60
- C 2.05
- D 141.75
-  46x105

AK RT



08-283100-00 STD

- 3.50  CR P
- 3.00  P
- 5.00  CR P

- 15-452920-00 WH 
- 14-452920-00 WH 
- 15-450030-00 WH 
- 14-450030-00 WH 
- 15-452930-00 WH 
- 14-452930-00 WH 

- B 144.50 C 270.00 D 153.80 E 10.07 F 1.00
- B 144.50 C 270.00 D 153.80 E 10.07 F 1.00
- B 144.50 C 270.00 D 153.80 E 10.27 F 1.00
- B 144.50 C 270.00 D 153.80 E 10.27 F 1.00
- B 144.50 C 270.00 D 153.80 E 10.57 F 1.00
- B 144.50 C 270.00 D 153.80 E 10.57 F 1.00

89-283100-00 
87-283100-00 +
15-452920-00

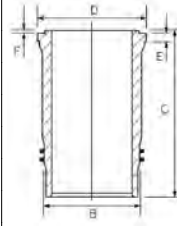

 Includes seals

 Schließt Dichtungen ein

 Inclut des joints

 Incluye los sellos

 Comprende le guarnizioni

 **128.00** **36**

D 2866 LF23 (Euro 3)	6cyl.	11967cc	228kW (310PS)	Diesel	Turbo Intercooled	TD16521
D 2866 LF24 (Euro 3)	6cyl.	11967cc	265kW (360PS)	Diesel	Turbo Intercooled	TD16522
D 2866 LF25 (Euro 3)	6cyl.	11967cc	301kW (409PS)	Diesel	Turbo Intercooled	TD16467
D 2866 LF26 (Euro 3)	6cyl.	11967cc	228kW (310PS)	Diesel	Turbo Intercooled	TD16204
D 2866 LF27 (Euro 3)	6cyl.	11967cc	265kW (360PS)	Diesel	Turbo Intercooled	TD16205
D 2866 LF28 (Euro 3)	6cyl.	11967cc	301kW (410PS)	Diesel	Turbo Intercooled	TD15050
D 2866 LFG07 (Euro 3)	6cyl.	11967cc	301kW (409PS)	Diesel	Turbo Intercooled	TD28937
D 2866 LOH27 (Euro 3)	6cyl.	11967cc	228kW (310PS)	Diesel	Turbo Intercooled	TD16760
D 2866 LOH28 (Euro 3)	6cyl.	11967cc	265kW (360PS)	Diesel	Turbo Intercooled	TD16761
D 2866 LOH29 (Euro 3)	6cyl.	11967cc	301kW (410PS)	Diesel	Turbo Intercooled	TD16493
D 2866 LOH32 (Euro 3)	6cyl.	11967cc	228kW (310PS)	Diesel	Turbo Intercooled	TD16746
D 2866 LOH33 (Euro 3)	6cyl.	11967cc	265kW (360PS)	Diesel	Turbo Intercooled	TD16747
D 2866 LOH34 (Euro 3)	6cyl.	11967cc	301kW (410PS)	Diesel	Turbo Intercooled	TD16297
D 2866 LOH35 (Euro 3)	6cyl.	11967cc	191kW (260PS)	Diesel	Turbo Intercooled	TD28943
D 2866 LUH23 (Euro 3)	6cyl.	11967cc	191kW (260PS)	Diesel	Turbo Intercooled	TD16764
D 2866 LUH24 (Euro 3)	6cyl.	11967cc	228kW (310PS)	Diesel	Turbo Intercooled	TD16765
D 2866 LUH25 (Euro 3)	6cyl.	11967cc	265kW (360PS)	Diesel	Turbo Intercooled	TD16766
D 2866 LUH27 (Euro 3)	6cyl.	11967cc	191kW (260PS)	Diesel	Turbo Intercooled	TD28953
D 2866 LUH28 (Euro 3)	6cyl.	11967cc	228kW (310PS)	Diesel	Turbo Intercooled	TD28954
D 2866 LUH29 (Euro 3)	6cyl.	11967cc	265kW (360PS)	Diesel	Turbo Intercooled	TD18040
D 2866 LUH30 (Euro 3)	6cyl.	11967cc	301-302kW (409-411PS)	Diesel	Turbo Intercooled	TD16767
D 2866 LUH51 (Euro 3)	6cyl.	11967cc	228kW (310PS)	Diesel	Turbo Intercooled	TD28163

6110	01/08→	LION'S COACH	01/00→
6122	01/08→12/13	LION'S STAR	06/00→04/07
A-Serie	01/04→	ND	08/01→04/07
Bravo	09/01→	NL	04/99→10/06
Centroliner	05/04→	NÜ	04/99→03/06
Cityliner	05/04→	Serie 9	01/98→
E2000	08/97→	Serie 200	01/05→
ECM	04/02→12/07	SG	05/00→08/08
ECT	04/02→	Starliner	01/02→
Euroliner	07/97→	SÜ	04/99→
F2000	06/98→	TGA	04/00→
F 2000	10/98→	Tourliner	01/03→
HOCL	01/92→	Trendliner	09/04→
LION'S CITY	05/04→	T-Serie	01/05→
LION'S CLASSIC	05/04→03/09	ÜL	04/99→05/05





87-143800-30 STD



- A 89.75
- B- 22.00
- BØ 80.00
- C 1.90
- D 141.75
-  46x105



AK RT

08-143800-00 STD

- 4.00  CK P
- 3.00  CR P
- 4.00  CR P

- 15-452920-00** WH 
- 14-452920-00** WH
- 15-450030-00** WH 
- 14-450030-00** WH
- 15-452930-00** WH 
- 14-452930-00** WH

- B** 144.50 **C** 270.00 **D** 153.80 **E** 10.07 **F** 1.00
- B** 144.50 **C** 270.00 **D** 153.80 **E** 10.07 **F** 1.00
- B** 144.50 **C** 270.00 **D** 153.80 **E** 10.27 **F** 1.00
- B** 144.50 **C** 270.00 **D** 153.80 **E** 10.27 **F** 1.00
- B** 144.50 **C** 270.00 **D** 153.80 **E** 10.57 **F** 1.00
- B** 144.50 **C** 270.00 **D** 153.80 **E** 10.57 **F** 1.00

89-143800-30 

87-143800-30 +
15-452920-00

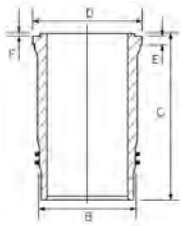

87-143800-40 STD

- A 89.55
- B- 22.00
- BØ 80.00
- C 1.90
- D 141.75
-  46x105



AK RT

08-143800-00 STD

- 4.00  CK P
- 3.00  CR P
- 4.00  CR P

 Includes seals

 Schließt Dichtungen ein

 Inclut des joints

 Incluye los sellos

 Comprende le guarnizioni

 128.00							37
D 2866 LF31 (Euro 2)	6cyl.	11967cc	301kW (409PS)	Diesel	Turbo Intercooled	TD14312	
D 2866 LF32 (Euro 2)	6cyl.	11967cc	301kW (410PS)	Diesel	Turbo Intercooled	TD15048	
D 2866 LF39 (Euro 2)	6cyl.	11967cc	265kW (360PS)	Diesel	Turbo Intercooled	TD28931	
D 2866 LF40 (Euro 2)	6cyl.	11967cc	301kW (409PS)	Diesel	Turbo Intercooled	TD23662	
D 2866 LF41 (Euro 2)	6cyl.	11967cc	301kW (410PS)	Diesel	Turbo Intercooled	TD23005	
D 2866 LF42 (Euro 2)	6cyl.	11967cc	228-301kW (310-410PS)	Diesel	Turbo Intercooled	MP157034	
D 2866 LF43 (Euro 2)	6cyl.	11967cc	265kW (360PS)	Diesel	Turbo Intercooled	TD23004	
ECM		04/02→12/07		TGA		04/00→	
F2000		06/98→		TRUCK & BUS			
F 2000		10/98→					

87-104300-00 STD



- A 89.75
- B- 22.70
- BØ 80.00
- C 1.90
- D 141.75
-  46x105



AK RT

08-104300-00 STD

- 4.00  CK P
- 3.00  P
- 4.00  CR P

- 15-452920-00** WH 
- 14-452920-00** WH
- 15-450030-00** WH 
- 14-450030-00** WH
- 15-452930-00** WH 
- 14-452930-00** WH

- B** 144.50 **C** 270.00 **D** 153.80 **E** 10.07 **F** 1.00
- B** 144.50 **C** 270.00 **D** 153.80 **E** 10.07 **F** 1.00
- B** 144.50 **C** 270.00 **D** 153.80 **E** 10.27 **F** 1.00
- B** 144.50 **C** 270.00 **D** 153.80 **E** 10.27 **F** 1.00
- B** 144.50 **C** 270.00 **D** 153.80 **E** 10.57 **F** 1.00
- B** 144.50 **C** 270.00 **D** 153.80 **E** 10.57 **F** 1.00

88-104300-00 

87-104300-00 +
14-452920-00

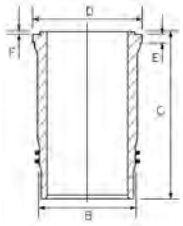



87-104300-10 STD

- A 89.55
- B- 22.70
- BØ 80.00
- C 1.90
- D 141.55
- 46x105



AK RT

08-104300-00 STD

- 4.00 CK P
- 3.00 P
- 4.00 CR P

Includes seals

Schließt Dichtungen ein

Includ des joints

Incluye los sellos

Comprende le guarnizioni

128.00

38

D 2876 LF02 (Euro 2)	6cyl.	12816cc	338kW (460PS)	Diesel	Turbo Intercooled	TD7773
D 2876 LOH01 (Euro 2)	6cyl.	12816cc	338kW (460PS)	Diesel	Turbo Intercooled	TD16249
D 2876 LUH01 (Euro 2)	6cyl.	12816cc	294kW (400PS)	Diesel	Turbo Intercooled	TD28969
D 2876 LUH02 (Euro 2)	6cyl.	12816cc	316kW (430PS)	Diesel	Turbo Intercooled	TD28970

F2000
HOCL

01/94→
01/97→10/06

LION'S COACH
Starliner

01/00→
09/96→

87-124500-00 STD

- A 79.25
- B- 23.10
- BØ 81.28
- C 2.10
- D 134.25
- 50x107



AK RT TP

08-124500-00 STD

- 4.00 CK P
- 3.00 P
- 4.00 CR P

- 15-452920-00** WH B 144.50 C 270.00 D 153.80 E 10.07 F 1.00
- 14-452920-00** WH B 144.50 C 270.00 D 153.80 E 10.07 F 1.00
- 15-450030-00** WH B 144.50 C 270.00 D 153.80 E 10.27 F 1.00
- 14-450030-00** WH B 144.50 C 270.00 D 153.80 E 10.27 F 1.00
- 15-452930-00** WH B 144.50 C 270.00 D 153.80 E 10.57 F 1.00
- 14-452930-00** WH B 144.50 C 270.00 D 153.80 E 10.57 F 1.00

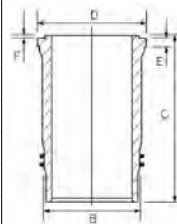

89-124500-00
87-124500-00 +
15-452920-00

87-124500-20 STD

- A 78.85
- B- 23.10
- BØ 81.28
- C 2.10
- D 133.85
- 50x107



AK RT TP

08-124500-00 STD

- 4.00 CK P
- 3.00 P
- 4.00 CR P

Includes seals

Schließt Dichtungen ein

Includ des joints

Incluye los sellos

Comprende le guarnizioni

128.00











39







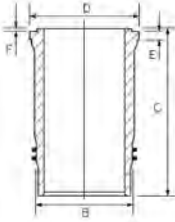

D 2876 LF03 (Euro 3)	6cyl.	12816cc	338kW (460PS)	Diesel	Turbo Intercooled	TD17050
D 2876 LF04 (Euro 3)	6cyl.	12816cc	338kW (460PS)	Diesel	Turbo Intercooled	TD15051
D 2876 LF06 (Euro 2)	6cyl.	12816cc	338kW (460PS)	Diesel	Turbo Intercooled	TD14313
D 2876 LF07 (Euro 2)	6cyl.	12816cc	338kW (460PS)	Diesel	Turbo Intercooled	TD15049
D 2876 LF10 (Euro 2)	6cyl.	12816cc	338kW (460PS)	Diesel	Turbo Intercooled	TD28966
D 2876 LF17	6cyl.	12816cc	338kW (460PS)	Diesel	Turbo Intercooled	TD28967
D 2876 LOH02 (Euro 3)	6cyl.	12816cc	338kW (460PS)	Diesel	Turbo Intercooled	TD16509
D 2876 LOH03 (Euro 3)	6cyl.	12816cc	338kW (460PS)	Diesel	Turbo Intercooled	TD16298







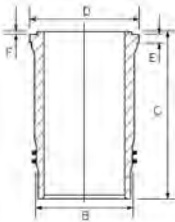





Cityliner	05/04→	HOCL	01/00→08/09
E2000	08/97→	LION'S COACH	01/00→
ECT	04/02→	LION'S STAR	06/00→04/07
F2000	01/94→	TGA	04/00→
F 2000	10/98→	Tourliner	01/03→

<p>87-143800-00 STD</p> <p>A 79.25 B- 21.74 BØ 85.05 C 1.90 D 134.25  50x107</p> <p>AK RT TP</p> 	<p>08-143800-00 STD</p> <p>4.00  CK P 3.00  CR P 4.00  CR P</p>	<p>15-452920-00 WH  14-452920-00 WH 15-450030-00 WH  14-450030-00 WH 15-452930-00 WH  14-452930-00 WH</p> <p>B 144.50 C 270.00 D 153.80 E 10.07 F 1.00 B 144.50 C 270.00 D 153.80 E 10.07 F 1.00 B 144.50 C 270.00 D 153.80 E 10.27 F 1.00 B 144.50 C 270.00 D 153.80 E 10.57 F 1.00 B 144.50 C 270.00 D 153.80 E 10.57 F 1.00</p> 	<p>89-143800-00  87-143800-00 + 15-452920-00</p>
---	---	---	--

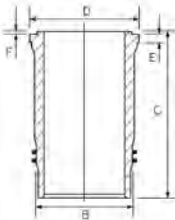
<p>87-143800-10 STD</p> <p>A 79.05 B- 21.74 BØ 85.05 C 1.90 D 134.05  50x107</p> <p>AK RT TP</p> 	<p>08-143800-00 STD</p> <p>4.00  CK P 3.00  CR P 4.00  CR P</p>	<p>15-452920-00 WH  14-452920-00 WH</p> <p>B 144.50 C 270.00 D 153.80 E 10.07 F 1.00 B 144.50 C 270.00 D 153.80 E 10.07 F 1.00</p> 	<p>89-143800-10  87-143800-10 + 15-452920-00</p>
--	--	--	--

<p>87-143800-20 STD</p> <p>A 78.85 B- 21.74 BØ 85.05 C 1.90 D 133.85  50x107</p> <p>AK RT TP</p> 	<p>08-143800-00 STD</p> <p>4.00  CK P 3.00  CR P 4.00  CR P</p>	<p>15-452920-00 WH  14-452920-00 WH</p> <p>B 144.50 C 270.00 D 153.80 E 10.07 F 1.00 B 144.50 C 270.00 D 153.80 E 10.07 F 1.00</p> 	<p>89-143800-20  87-143800-20 + 15-452920-00</p>
---	---	---	--

 Includes seals

 Schließt Dichtungen ein

 Inclut des joints

 Incluye los sellos

 Comprende le guarnizioni

 128.00							40
D 2876 LF12 (Euro 3)	6cyl.	12816cc	353kW (480PS)	Diesel	Turbo Intercooled	TD16825	
D 2876 LF13 (Euro 3)	6cyl.	12816cc	390kW (530PS)	Diesel	Turbo Intercooled	TD16826	
D 2876 LF25 (Euro 2)	6cyl.	12816cc	353kW (480PS)	Diesel	Turbo Intercooled	TD19115	
D 2876 LOH20 (Euro 3)	6cyl.	12816cc	353kW (480PS)	Diesel	Turbo Intercooled	TD16762	
D 2876 LOH21 (Euro 3)	6cyl.	12816cc	390kW (530PS)	Diesel	Turbo Intercooled	TD18041	

ECT	02/05→	Starliner	05/05→
LION'S STAR	08/04→04/07	TGA	01/01→
Skyliner	05/04→		





87-143800-50 STD

- A 79.25
- B- 23.75
- BØ 76.16
- C 1.90
- D 134.25
-  52x103

KK RT TP



08-143800-00 STD

- 4.00  CK P
- 3.00  CR P
- 4.00  CR P

15-670050-00 WH
14-670050-00 WH

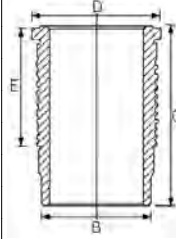

B 144.50 C 268.00 D 153.80 E 8.07
B 144.50 C 268.00 D 153.80 E 8.07

88-143800-50
87-143800-50 +
14-670050-00

87-143800-60 STD

- A 79.05
- B- 23.75
- BØ 76.16
- D 134.05
-  52x103

AK RT TP



08-143800-00 STD

- 4.00  CK P
- 3.00  CR P
- 4.00  CR P

 128.00

41

D 2840 LE	V10cyl.	18273cc	346-460kW (471-626PS)	Diesel	Turbo Intercooled	TD19453
D 2840 LE403	V10cyl.	18273cc	772kW (1050PS)	Diesel	Turbo Intercooled	TD27911
D 2840 LE423	V10cyl.	18273cc	809kW (1100PS)	Diesel	Turbo Intercooled	TD27921
D 2840 LF01	V10cyl.	18273cc	368kW (500PS)	Diesel	Turbo Intercooled	TD7796
D 2840 LF04 (Euro 1)	V10cyl.	18273cc	368kW (500PS)	Diesel	Turbo Intercooled	TD7797
D 2840 LF06 (Euro 1)	V10cyl.	18273cc	368kW (500PS)	Diesel	Turbo Intercooled	TD7798
D 2840 LF20 (Euro 2)	V10cyl.	18273cc	441kW (600PS)	Diesel	Turbo Intercooled	TD7774
D 2840 LF21 (Euro 2)	V10cyl.	18273cc	441kW (600PS)	Diesel	Turbo Intercooled	TD18099
D 2840 LF25 (Euro 3)	V10cyl.	18273cc	485-515kW (660-700PS)	Diesel	Turbo Intercooled	TD16824
D 2840 LF/460	V10cyl.	18273cc	338kW (460PS)	Diesel	Turbo Intercooled	TD7795
D 2840 LXE	V10cyl.	18273cc	603kW (820PS)	Diesel	Turbo Intercooled	TD19454
D 2840 LXF	V10cyl.	18273cc	338kW (460PS)	Diesel	Turbo Intercooled	TD19455
D 2840 LYE	V10cyl.	18273cc	603-670kW (820-911PS)	Diesel	Turbo Intercooled	TD19124
D 2840 ME	V10cyl.	18273cc	244-268kW (332-364PS)	Diesel		TD19125
D 2840 MF	V10cyl.	18273cc	268kW (365PS)	Diesel		TD7811
D 2840 MFG	V10cyl.	18273cc	268kW (365PS)	Diesel		TD7812
D 2840 MFR	V10cyl.	18273cc	245-268kW (333-364PS)	Diesel		TD19456
D 2840 MH	V10cyl.	18273cc	244-268kW (332-364PS)	Diesel		TD19126
D 2840 TL	V10cyl.	18273cc	603kW (820PS)	Diesel	Turbo Intercooled	MP5425
D 2842 LE211	V12cyl.	21927cc	590-695kW (802-945PS)	Diesel	Turbo Intercooled	TD27955
D 2842 LE402	V12cyl.	21927cc	809kW (1100PS)	Diesel	Turbo Intercooled	TD27861
D 2842 LE403	V12cyl.	21927cc	529kW (719PS)	Diesel	Turbo Intercooled	TD27862
D 2842 LE406	V12cyl.	21927cc	882kW (1200PS)	Diesel	Turbo Intercooled	TD27864
D 2842 LE408	V12cyl.	21927cc	735kW (1000PS)	Diesel	Turbo Intercooled	TD27866
D 2842 LE423	V12cyl.	21927cc	1000kW (1360PS)	Diesel	Turbo Intercooled	TD27922
D 2842 LE433	V12cyl.	21927cc	1140kW (1550PS)	Diesel	Turbo Intercooled	TD27923
D 2842 LE622	V12cyl.	21927cc	588kW (800PS)	Diesel	Turbo Intercooled	TD20231
D 2842 LF	V12cyl.	21927cc	735kW (1000PS)	Diesel	Turbo Intercooled	MP5426
D 2842 LF10 (Euro 3)	V12cyl.	21927cc	735kW (1000PS)	Diesel	Turbo Intercooled	TD20177
D 2842 LFX	V12cyl.	21927cc	735kW (1000PS)	Diesel	Turbo Intercooled	MP5426-1





D 2842 LXE	V12cyl.	21927cc	662-735kW (900-1000PS)	Diesel	Turbo Intercooled	TD19121
D 2842 LYE	V12cyl.	21927cc	735-808kW (100-1099PS)	Diesel	Turbo Intercooled	TD19122
D 2842 LZE	V12cyl.	21927cc	735-808kW (100-1099PS)	Diesel	Turbo Intercooled	TD19123
D 2842 ME	V12cyl.	21927cc	275-338kW (374-460PS)	Diesel		TD19120
D 2842 MF	V12cyl.	21927cc	338kW (460PS)	Diesel		MP5423
D 2848 LE	V8cyl.	14618cc	206-500kW (280-680PS)	Diesel		MP25422
D 2848 LE423	V8cyl.	14618cc	662kW (900PS)	Diesel	Turbo Intercooled	TD27920
D 2848 LXE	V8cyl.	14618cc	500kW (680PS)	Diesel	Turbo Intercooled	TD19118
D 2848 LYE	V8cyl.	14618cc	500kW (680PS)	Diesel	Turbo Intercooled	TD19119
D 2848 M	V8cyl.	14618cc	206kW (280PS)	Diesel		TD19075
D 2848 MF	V8cyl.	14618cc	206kW (280PS)	Diesel		MP5422
D 2848 MH	V8cyl.	14618cc	206kW (280PS)	Diesel		TD19076
E 2842 E312	V12cyl.	21927cc	250-280kW (340-381PS)	CNG/Gas		TD28171
E 2842 LE312	V12cyl.	21927cc	360-420kW (490-571PS)	CNG/Gas	Turbo Intercooled	TD27925
E 2842 LE322	V12cyl.	21927cc	380-420kW (517-571PS)	CNG/Gas	Turbo Intercooled	TD27639
E 2848 LE322	V8cyl.	14618cc	265-295kW (360-401PS)	CNG/Gas	Turbo Intercooled	TD28166

E2000	05/00→	MARINE	
F90	05/87→06/96	TGA	09/02→
F2000	01/96→	TRUCK & BUS	

14-452910-00 WH 1 B 144.50 C 253.00 D 153.80 E 10.05 F 1.00

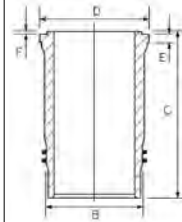

1 Interference fit = 145.8mm 2 Presssitz = 145,8mm 3 Ajustement pressé = 145.8mm 4 Encaje a presi'n = 145.8mm 5 Interferenza di montaggio=145.8mm

128.00 **42**

D 2842 LE202	V12cyl.	21927cc	446-587kW (607-798PS)	Diesel	Turbo Intercooled	TD25682
D 2842 LE404	V12cyl.	21927cc	956kW (1300PS)	Diesel	Turbo Intercooled	TD27702
D 2842 LE414	V12cyl.	21930cc		Diesel	Turbo Intercooled	MP45426
D 2842 LE415	V12cyl.	21930cc		Diesel	Turbo Intercooled	MP55426
D 2842 LE416	V12cyl.	21930cc		Diesel	Turbo Intercooled	MP65426
D 2842 LE417	V12cyl.	21930cc		Diesel	Turbo Intercooled	MP75426

TRUCK & BUS

87-124500-30 STD

- A 81.25
- B- 27.10
- BØ 80.20
- C 1.30
- D 130.00
- ⊕ 46x105



AK KK NB RT

08-124500-00 STD

- 4.00 CK P
- 3.00 P
- 4.00 CR P

14-452910-00 WH 1

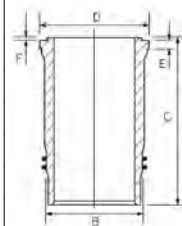

B 144.50 C 253.00 D 153.80 E 10.05 F 1.00

88-124500-30

87-124500-30 +
14-452910-00

1 Interference fit = 145.8mm 2 Presssitz = 145,8mm 3 Ajustement pressé = 145.8mm 4 Encaje a presi'n = 145.8mm 5 Interferenza di montaggio=145.8mm

128.00 **43**

E 2876 LUH01	6cyl.	12816cc	228kW (310PS)	CNG/Gas	Turbo Intercooled	TD28243
E 2876 LUH02	6cyl.	12816cc	228kW (310PS)	CNG/Gas	Turbo Intercooled	TD19966





E 2876 LUH03	6cyl.	12816cc	228-235kW (310-320PS)	CNG/Gas Turbo Intercooled	TD23804
E 2876 LUH04	6cyl.	12816cc	200kW (272PS)	CNG/Gas Turbo Intercooled	TD25459
AVANCITY			01/13→	LION'S CLASSIC	10/07→08/10
HOCL			05/07→	NG	05/07→12/14
LION'S CITY			05/07→	NL	05/07→12/14

87-433800-00 *STD*

- A** 78.70
- B-** 28.75
- BØ** 93.43
- D** 133.75
-  50x107



AK RT TP

08-433800-00 *STD*

- 3.50  **CK**
- 3.00 
- 4.00  **CR**



ENGINE INDEX

Motorverzeichnis • Index de moteur • Índice de Motor
 Indeks silnika • Модель Двигателя • دليل المحرك

CCM
x

9

F6JA	Diesel	1399	4	73.70	1
F6JB	Diesel	1399	4	73.70	1
FXJA	Petrol	1388	4	76.00	5
FYJA	Petrol	1596	4	79.00	8
HR16DE	Petrol	1598	4	78.00	6
J4R	Petrol	1299	4	74.00	2
J4T	Petrol	1299	4	74.00	2
JJA (Endura-E)	Petrol	1299	4	74.00	2
JJK	Petrol	1299	4	74.00	2
JJM	Petrol	1299	4	74.00	2
L5-VE	Petrol	2488	4	89.00	11
LF17	Petrol	1999	4	87.50	10
LF18	Petrol	1999	4	87.50	10
LFF7	Petrol	1999	4	87.50	10
R2	Diesel	2184	4	86.00	9
RF55	Diesel	1998	4	86.00	9
Y601	Diesel	1560	4	75.00	4
Y642	Diesel	1560	4	75.00	4
ZJ-VE (Euro 4)	Petrol	1349	4	74.00	3
ZY-DE	Petrol	1498	4	78.00	7



73.70

1

F6JA	4cyl.	1399cc	50kW (68PS)	Diesel	Turbo Intercooled	TD18693
F6JB	4cyl.	1399cc	50kW (68PS)	Diesel	Turbo Intercooled	TD20951
2 1.4 CD		04/03→06/07				

87-135300-00 STD
87-135307-00 0.50mm

08-135300-00 STD
08-135305-00 0.25mm
08-135307-00 0.50mm

14-020760-00 D
14-020761-00 D
B 76.95 C 136.00 D 78.45 E 5.25
B 76.95 C 136.00 D 78.45 E 5.25

A 42.94
B- 14.70
BØ 37.16
C 1.55
D 65.44
E 25x60



2.50 CK P
1.95 P
2.50 CR P

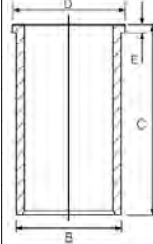

AK RT TP

74.00

2

J4R	4cyl.	1299cc	44kW (60PS)	Petrol	TD24680
J4T	4cyl.	1299cc	44kW (60PS)	Petrol	TD24681
JJA (Endura-E)	4cyl.	1299cc	37kW (50PS)	Petrol	TD25845
JJK	4cyl.	1299cc	37kW (50PS)	Petrol	TD24678
JJM	4cyl.	1299cc	37kW (50PS)	Petrol	TD24679

87-785000-00 STD
87-785007-00 0.50mm
87-785011-00 1.00mm

08-785000-00 STD
08-785007-00 0.50mm
08-785011-00 1.00mm

A 29.40
D 53.90
E 18x64



1.50 CR P
1.75 P
3.00 CR



Steel

Stahl

Acier

Acero

Acciaio

74.00

3

ZJ-VE (Euro 4)	4cyl.	1349cc	55-67kW (75-91PS)	Petrol	TD24828
2 1.3		07/07→11/14		2 1.3 MZR	

87-424600-00 STD
87-424607-00 0.50mm

08-424600-00 STD
08-424607-00 0.50mm

A 27.40
B- 3.30
BØ 53.50
C 1.20
D 46.00
E 18x59



1.00 CR
1.00 P
2.00 CR



Steel

Stahl

Acier

Acero

Acciaio

75.00

4

Y601	4cyl.	1560cc	80-81kW (109-110PS)	Diesel	Turbo Intercooled	TD18512
Y642	4cyl.	1560cc	80kW (109PS)	Diesel	Turbo	TD31288
3 1.6 DI Turbo		06/04→06/09		3 1.6 MZR CD		12/08→05/13
3 1.6 MZ-CD		12/08→05/13				



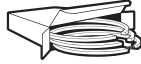

87-424000-00 STD
87-424008-00 0.60mm

A 41.70
B- 13.25
BØ 41.80
C 1.20
D 65.30
 26x61



AK KK RT TP

08-424000-00 STD
08-424007-00 0.50mm
08-424008-00 0.60mm

3.00  CK P
 1.95  P
 2.50  CR P





76.00

5

FXJA 4cyl. **1388cc** **59-62kW** (80-84PS) **Petrol** **TD18695**

2 1.4 02/03→06/07

87-426100-00 STD 
87-426107-00 0.50mm 

A 28.25
B+ 1.25
D 55.50
 19x50



08-426100-00 STD
08-426107-00 0.50mm

1.20  NT 
 1.50  P
 2.50  NT 

 Elastoval ®

 Steel

 Stahl

 Acier

 Acero

 Acciaio

78.00

6

HR16DE 4cyl. **1598cc** **80kW** (109PS) **Petrol** **TD30817**

FAMILIA VAN 1.6 01/07→05/18

87-437700-00 STD 
87-437707-00 0.50mm 

A 28.50
B- 4.70
BØ 65.00
B+ 2.20
C 1.80
D 49.20
 19x55

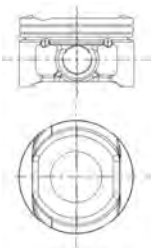

RT

08-437700-00 STD
08-437707-00 0.50mm

1.20  CR P 
 1.20  P
 2.00  CR 

 Piston pin press fit in conrod

 Kolbenbolzen in Pleuel eingepreßt

 Axe serré sur bielle

 Bulón del pistón montado a presión en la biela

 Spinotto inserto a spinta nella biella

 Steel

 Stahl

 Acier

 Acero

 Acciaio

78.00

7

ZY-DE 4cyl. **1498cc** **76kW** (103PS) **Petrol** **TD25012**

2 1.5 i 05/10→06/15





87-424700-00 STD
87-424707-00 0.50mm

A 26.90
C 1.62
C 2.30
D 45.40
19x58



TP

08-424700-00 STD
08-424707-00 0.50mm

1.20
1.20
2.50
CR P ①
P
NT ①



① Steel

① Stahl

① Acier

① Acero

① Acciaio

79.00

8

FYJA 4cyl. 1596cc 74kW (100PS) Petrol TD18692

2 1.6 02/03→06/07

87-141300-00 STD ①
87-141307-00 0.50mm ①

A 25.05
D 48.10
18x50



08-141300-00 STD
08-141307-00 0.50mm

1.20
1.50
2.00
NT ②
P
CR ②



① Elastoval®

② Steel

② Stahl

② Acier

② Acero

② Acciaio

86.00

9

R2 4cyl. 2184cc 47-52kW (64-71PS) Diesel TD2030

RF55 4cyl. 1998cc 55-56kW (75-76PS) Diesel TD31533

626 IV 2.0 D 05/94→06/97 E E2200 D 01/87→05/03

626 IV 2.0 D GLX Complex 10/92→04/97 SPECTRON 2.2 TD 08/86→10/95

B-SERIE 2.2 D 03/85→10/89

14-010840-00 D

B 90.00 C 179.96

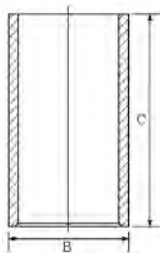

87.50

10

LF17 4cyl. 1999cc 104-110kW (141-150PS) Petrol TD18206

LF18 4cyl. 1999cc 104kW (141PS) Petrol TD18207

LFF7 4cyl. 1999cc 107kW (146PS) Petrol TD19205

5 2.0 02/05→05/10 6 2.0 MZR 08/07→07/13

6 2.0 06/02→08/07





87-423400-00 STD
87-423407-00 0.50mm

A 28.50
B- 0.35
BØ 76.50
D 51.00
 21x60



08-423400-00 STD
08-423407-00 0.50mm

1.20  CR P 
 1.20  P
 2.50  CR 

 Steel

 Stahl

 Acier

 Acero

 Acciaio

 **89.00**

11

L5-VE	4cyl.	2488cc	117-125kW (159-170PS)	Petrol	TD23706
3 2.5			03/09→09/14	6 2.5 MZR	08/07→07/13
5 2.5			09/11→	CX-7 2.5 MZR	07/09→03/13
6 2.5break			10/12→07/13		

87-424500-00 STD
87-424507-00 0.50mm

A 28.50
B- 6.60
BØ 73.80
C 2.50
D 50.70
 20x55

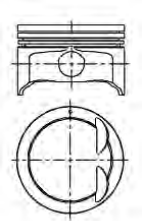

08-424500-00 STD
08-424507-00 0.50mm

1.20  PVD P 
 1.20  P
 2.50  NT 

 Steel

 Stahl

 Acier

 Acero

 Acciaio



CCM



9

M 102.910	Petrol	1797	4	89.00	30
M 102.919	Petrol	1797	4	89.00	30
M 102.920	Petrol	1997	4	89.00	31
M 102.921	Petrol	1997	4	89.00	31
M 102.922	Petrol	1997	4	89.00	31
M 102.924	Petrol	1997	4	89.00	31
M 102.938	Petrol	1997	4	89.00	30
M 102.939	Petrol	1997	4	89.00	30
M 102.961	Petrol	1997	4	89.00	31
M 102.962	Petrol	1997	4	89.00	31
M 102.963	Petrol	1997	4	89.00	31
M 102.964	Petrol	1997	4	89.00	31
M 102.965	Petrol	1997	4	89.00	30
M 103.980	Petrol	2960	6	88.50	29
M 103.981	Petrol	2960	6	88.50	29
M 103.982	Petrol	2960	6	88.50	29
M 103.983	Petrol	2960	6	88.50	29
M 103.984	Petrol	2960	6	88.50	29
M 103.985	Petrol	2960	6	88.50	29
M 103.987	Petrol	2960	6	88.50	29
M 104.941	Petrol	2799	6	89.90	36
M 104.942	Petrol	2799	6	89.90	36
M 104.943	Petrol	2799	6	89.90	36
M 104.944	Petrol	2799	6	89.90	36
M 104.945	Petrol	2799	6	89.90	36
M 104.990	Petrol	3199	6	89.90	37
M 104.991	Petrol	3199	6	89.90	37
M 104.992	Petrol	3199	6	89.90	37
M 104.994	Petrol	3199	6	89.90	37
M 104.995	Petrol	3199	6	89.90	37
M 104.996	Petrol	3199	6	89.90	37
M 110.921	Petrol	2746	6	86.00	14
M 110.922	Petrol	2746	6	86.00	14
M 110.923	Petrol	2746	6	86.00	14
M 110.924	Petrol	2746	6	86.00	14
M 110.926	Petrol	2746	6	86.00	14
M 110.981	Petrol	2746	6	86.00	14
M 110.982	Petrol	2746	6	86.00	14
M 110.983	Petrol	2746	6	86.00	14
M 110.984	Petrol	2746	6	86.00	14
M 110.985	Petrol	2746	6	86.00	14
M 110.986	Petrol	2746	6	86.00	14
M 110.987	Petrol	2746	6	86.00	14
M 110.988	Petrol	2746	6	86.00	14
M 110.989	Petrol	2746	6	86.00	14
M 110.990	Petrol	2746	6	86.00	14
M 111.970	Petrol	2295	4	90.90	39
M 111.973	Petrol	2295	4	90.90	40
M 111.974	Petrol	2295	4	90.90	39
M 111.975	Petrol	2295	4	90.90	40
M 111.977	Petrol	2295	4	90.90	41
M 111.978	Petrol	2295	4	90.90	40
M 111.979	Petrol	2295	4	90.90	40
M 111.980	Petrol	2295	4	90.90	41
M 111.981	Petrol	2295	4	90.90	40
M 111.982	Petrol	2295	4	90.90	40
M 111.983	Petrol	2295	4	90.90	40
M 111.984	Petrol	2295	4	90.90	39
M 112.940	Petrol	3199	V6	89.90	38
M 112.941	Petrol	3199	V6	89.90	38

ENGINE INDEX

Motorverzeichnis • Index de moteur • Índice de Motor
 Indeks silnika • Модель Двигателя • دليل المحرك

CCM

9

M 112.942	Petrol	3199	V6	89.90	38
M 112.943	Petrol	3199	V6	89.90	38
M 112.944	Petrol	3199	V6	89.90	38
M 112.945	Petrol	3199	V6	89.90	38
M 112.946	Petrol	3199	V6	89.90	38
M 112.947	Petrol	3199	V6	89.90	38
M 112.949	Petrol	3199	V6	89.90	38
M 112.951	Petrol	3199	V6	89.90	38
M 112.953	Petrol	3199	V6	89.90	38
M 112.954	Petrol	3199	V6	89.90	38
M 112.955	Petrol	3199	V6	89.90	38
M 113.940	Petrol	4266	V8	89.90	38
M 113.941	Petrol	4266	V8	89.90	38
M 113.942	Petrol	4266	V8	89.90	38
M 113.943	Petrol	4266	V8	89.90	38
M 113.944	Petrol	4266	V8	89.90	38
M 160 B03 (SMART)	Petrol	599	3	63.50	1
M 160 B04 (SMART)	Petrol	599	3	63.50	1
M 160 B05 (SMART)	Petrol	599	3	63.50	1
M 161.971	Petrol	2295	4	90.90	40
M 271.860	Petrol	1796	4	82.00	4
M 271.861	Petrol	1796	4	82.00	4
M 271.948	Petrol	1796	4	82.00	5
M 271.950	Petrol	1796	4	82.00	5
M 271.951	CNG	1796	4	82.00	5
M 271.954	Petrol	1796	4	82.00	5
M 271.955	Petrol	1796	4	82.00	5
M 271.956	Petrol	1796	4	82.00	5
M 271.957	Petrol	1796	4	82.00	5
M 272.911	Petrol	2496	V6	88.00	20
M 272.920	Petrol	2496	V6	88.00	20
M 272.921	Petrol	2496	V6	88.00	20
M 272.922	Petrol	2496	V6	88.00	20
M 272.940	Petrol	2996	V6	88.00	20
M 272.941	Petrol	2996	V6	88.00	20
M 272.942	Petrol	2996	V6	88.00	20
M 272.943	Petrol	2996	V6	88.00	20
M 272.944	Petrol	2996	V6	88.00	20
M 272.945	Petrol	2996	V6	88.00	20
M 272.946	Petrol	2996	V6	88.00	20
M 272.947	Petrol	2996	V6	88.00	20
M 272.949	Petrol	2996	V6	88.00	20
M 272.952	Petrol	2996	V6	88.00	20
M 274.920	Petrol	1991	4	83.00	6
M 476.921 (M 447 G)	Petrol	11967	6	128.00	65
M 476.925 (M 447 HG)	Petrol	11967	6	128.00	65
M 476.926 (M 447 HG)	Petrol	11967	6	128.00	65
M 476.927 (M 447 HG)	Petrol	11967	6	128.00	65
M 476.930 (Euro 2 M447 hLAG)	Petrol	11967	6	128.00	65
OM 314.900	Diesel	3784	4	97.00	44
OM 314.910	Diesel	3784	4	97.00	44
OM 314.914	Diesel	3784	4	97.00	44
OM 314.915	Diesel	3784	4	97.00	44
OM 314.916	Diesel	3784	4	97.00	44
OM 314.917	Diesel	3784	4	97.00	44
OM 314.918	Diesel	3784	4	97.00	44
OM 314.919	Diesel	3784	4	97.00	44
OM 314.920	Diesel	3784	4	97.00	44
OM 314.921	Diesel	3784	4	97.00	44
OM 314.922	Diesel	3784	4	97.00	44



CCM



9

OM 314.940	Diesel	3784	4	97.00	44
OM 314.941	Diesel	3784	4	97.00	44
OM 314.942	Diesel	3784	4	97.00	44
OM 314.943	Diesel	3784	4	97.00	44
OM 314.944	Diesel	3784	4	97.00	44
OM 314.945	Diesel	3784	4	97.00	44
OM 314.946	Diesel	3784	4	97.00	44
OM 314.947	Diesel	3784	4	97.00	44
OM 314.948	Diesel	3784	4	97.00	44
OM 314.949	Diesel	3784	4	97.00	44
OM 314.950	Diesel	3784	4	97.00	44
OM 314.951	Diesel	3784	4	97.00	44
OM 314.953	Diesel	3784	4	97.00	44
OM 314.954	Diesel	3784	4	97.00	44
OM 314.956	Diesel	3784	4	97.00	44
OM 314.957	Diesel	3784	4	97.00	44
OM 314.958	Diesel	3784	4	97.00	44
OM 314.959	Diesel	3784	4	97.00	44
OM 314.960	Diesel	3784	4	97.00	44
OM 314.961	Diesel	3784	4	97.00	44
OM 314.962	Diesel	3784	4	97.00	44
OM 314.963	Diesel	3784	4	97.00	44
OM 314.964	Diesel	3784	4	97.00	44
OM 314.965	Diesel	3784	4	97.00	44
OM 314.970	Diesel	3784	4	97.00	45
OM 335.910	Diesel	11581	6	128.00	66
OM 335.930	Diesel	11581	6	128.00	66
OM 335.932	Diesel	11581	6	128.00	66
OM 340.930	Diesel	3784	4	97.00	44
OM 340.932	Diesel	3784	4	97.00	44
OM 341.910	Diesel	5675	6	97.00	44
OM 341.911	Diesel	5675	6	97.00	44
OM 341.912	Diesel	5675	6	97.00	44
OM 341.915	Diesel	5675	6	97.00	44
OM 341.918	Diesel	5675	6	97.00	44
OM 341.919	Diesel	5675	6	97.00	44
OM 341.931	Diesel	5675	6	97.00	44
OM 341.932	Diesel	5675	6	97.00	44
OM 341.934	Diesel	5675	6	97.00	44
OM 341.935	Diesel	5675	6	97.00	44
OM 341.936	Diesel	5675	6	97.00	44
OM 341.938	Diesel	5675	6	97.00	44
OM 341.941	Diesel	5675	6	97.00	44
OM 341.946	Diesel	5675	6	97.00	44
OM 341.948	Diesel	5675	6	97.00	44
OM 341.949	Diesel	5675	6	97.00	44
OM 341.995	Diesel	5675	6	97.00	44
OM 343.910	Diesel	3784	4	97.00	44
OM 343.932	Diesel	3784	4	97.00	44
OM 343.934	Diesel	3784	4	97.00	44
OM 344.905 (OM352)	Diesel	5675	6	97.00	44
OM 344.912 (OM352)	Diesel	5675	6	97.00	44
OM 344.930 (OM352)	Diesel	5675	6	97.00	44
OM 344.932 (OM352)	Diesel	5675	6	97.00	44
OM 344.933 (OM352)	Diesel	5675	6	97.00	44
OM 344.940 (OM352 A)	Diesel	5675	6	97.00	44
OM 344.941 (OM352 A)	Diesel	5675	6	97.00	44
OM 344.943 (OM352)	Diesel	5675	6	97.00	44
OM 344.944 (OM352)	Diesel	5675	6	97.00	44
OM 344.945 (OM352)	Diesel	5675	6	97.00	44

ENGINE INDEX

Motorverzeichnis • Index de moteur • Índice de Motor
 Indeks silnika • Модель Двигателя • دليل المحرك



CCM



9

OM 344.946 (OM352)	Diesel	5675	6	97.00	44
OM 344.949	Diesel	5675	6	97.00	44
OM 344.963 (OM352)	Diesel	5675	6	97.00	44
OM 345.910 (OM355)	Diesel	11581	6	128.00	66
OM 345.912 (OM355)	Diesel	11581	6	128.00	66
OM 345.913 (OM355)	Diesel	11581	6	128.00	67
OM 345.914 (OM355)	Diesel	11581	6	128.00	66
OM 345.915 (OM355)	Diesel	9651	5	128.00	66
OM 345.919 (OM355)	Diesel	9651	5	128.00	66
OM 345.932 (OM355)	Diesel	11581	6	128.00	66
OM 345.933 (OM355)	Diesel	11581	6	128.00	66
OM 345.936 (OM355)	Diesel	11581	6	128.00	66
OM 345.937 (OM355)	Diesel	11581	6	128.00	66
OM 345.941 (OM355)	Diesel	9651	5	128.00	66
OM 345.942 (OM355)	Diesel	9651	5	128.00	66
OM 345.945 (OM355)	Diesel	9651	5	128.00	66
OM 345.946 (OM355)	Diesel	9651	5	128.00	66
OM 345.947 (OM355)	Diesel	9651	5	128.00	66
OM 345.949 (OM355)	Diesel	9651	5	128.00	66
OM 345.960 (OM355 A)	Diesel	11581	6	128.00	67
OM 345.972 (OM355)	Diesel	9651	5	128.00	66
OM 345.973 (OM355)	Diesel	9651	5	128.00	66
OM 345.975 (OM355)	Diesel	9651	5	128.00	66
OM 347.915 (OM355)	Diesel	9651	5	128.00	66
OM 347.942 (OM355)	Diesel	9651	5	128.00	66
OM 347.943 (OM355)	Diesel	9651	5	128.00	66
OM 352.901	Diesel	5675	6	97.00	44
OM 352.902	Diesel	5675	6	97.00	44
OM 352.903	Diesel	5675	6	97.00	44
OM 352.904	Diesel	5675	6	97.00	44
OM 352.905	Diesel	5675	6	97.00	44
OM 352.906	Diesel	5675	6	97.00	44
OM 352.907	Diesel	5675	6	97.00	44
OM 352.908	Diesel	5675	6	97.00	44
OM 352.909	Diesel	5675	6	97.00	44
OM 352.910	Diesel	5675	6	97.00	44
OM 352.911	Diesel	5675	6	97.00	44
OM 352.912	Diesel	5675	6	97.00	44
OM 352.913	Diesel	5675	6	97.00	46
OM 352.914	Diesel	5675	6	97.00	44
OM 352.915	Diesel	5675	6	97.00	44
OM 352.916	Diesel	5675	6	97.00	46
OM 352.917	Diesel	5675	6	97.00	44
OM 352.918	Diesel	5675	6	97.00	46
OM 352.919	Diesel	5675	6	97.00	44
OM 352.930	Diesel	5675	6	97.00	44
OM 352.931	Diesel	5675	6	97.00	44
OM 352.932	Diesel	5675	6	97.00	44
OM 352.933	Diesel	5675	6	97.00	44
OM 352.934	Diesel	5675	6	97.00	44
OM 352.935	Diesel	5675	6	97.00	44
OM 352.936	Diesel	5675	6	97.00	44
OM 352.937	Diesel	5675	6	97.00	46
OM 352.938	Diesel	5675	6	97.00	44
OM 352.939	Diesel	5675	6	97.00	44
OM 352.942	Diesel	5675	6	97.00	44
OM 352.943	Diesel	5675	6	97.00	44
OM 352.944	Diesel	5675	6	97.00	44
OM 352.945	Diesel	5675	6	97.00	44
OM 352.946	Diesel	5675	6	97.00	46



CCM



9

OM 352.948	Diesel	5675	6	97.00	44
OM 352.949	Diesel	5675	6	97.00	46
OM 352.950	Diesel	5675	6	97.00	46
OM 352.953	Diesel	5675	6	97.00	44
OM 352.954	Diesel	5675	6	97.00	44
OM 352.955	Diesel	5675	6	97.00	44
OM 352.959 (OM 352)	Diesel	5675	6	97.00	44
OM 352.963	Diesel	5675	6	97.00	44
OM 352.964	Diesel	5675	6	97.00	44
OM 352.965 (OM 352)	Diesel	5675	6	97.00	44
OM 352.966 (OM 352)	Diesel	5675	6	97.00	44
OM 352.967 (OM 352)	Diesel	5675	6	97.00	44
OM 352.968	Diesel	5675	6	97.00	46
OM 352.969	Diesel	5675	6	97.00	44
OM 352.970	Diesel	5675	6	97.00	44
OM 352.971	Diesel	5675	6	97.00	44
OM 352.972	Diesel	5675	6	97.00	44
OM 352.973	Diesel	5675	6	97.00	44
OM 352.974	Diesel	5675	6	97.00	44
OM 352.975	Diesel	5675	6	97.00	44
OM 352.976	Diesel	5675	6	97.00	44
OM 352.978 (OM 352)	Diesel	5675	6	97.00	44
OM 352.979	Diesel	5675	6	97.00	44
OM 352.980	Diesel	5675	6	97.00	44
OM 352.981	Diesel	5675	6	97.00	44
OM 352.982	Diesel	5675	6	97.00	44
OM 352.983	Diesel	5675	6	97.00	44
OM 352.984	Diesel	5675	6	97.00	44
OM 352.985	Diesel	5675	6	97.00	44
OM 352.986	Diesel	5675	6	97.00	44
OM 352.987	Diesel	5675	6	97.00	44
OM 352.988	Diesel	5675	6	97.00	46
OM 352.989	Diesel	5675	6	97.00	44
OM 352.990	Diesel	5675	6	97.00	44
OM 352.991	Diesel	5675	6	97.00	44
OM 352.992 (OM 352)	Diesel	5675	6	97.00	44
OM 352.993	Diesel	5675	6	97.00	44
OM 352.994	Diesel	5675	6	97.00	46
OM 352.996	Diesel	5675	6	97.00	44
OM 352.997	Diesel	5675	6	97.00	44
OM 352.998	Diesel	5675	6	97.00	44
OM 352.999 (OM 352)	Diesel	5675	6	97.00	44
OM 353.900 (OM352)	Diesel	5675	6	97.00	44
OM 353.901 (OM352)	Diesel	5675	6	97.00	44
OM 353.902 (OM352)	Diesel	5675	6	97.00	44
OM 353.903 (OM352)	Diesel	5675	6	97.00	44
OM 353.904 (OM352)	Diesel	5675	6	97.00	44
OM 353.905 (OM352)	Diesel	5675	6	97.00	44
OM 353.907 (OM352)	Diesel	5675	6	97.00	44
OM 353.909 (OM352 A)	Diesel	5675	6	97.00	45
OM 353.910 (OM352 A)	Diesel	5675	6	97.00	45
OM 353.911 (OM352 A)	Diesel	5675	6	97.00	46
OM 353.912 (OM352 A)	Diesel	5675	6	97.00	46
OM 353.913 (OM352 A)	Diesel	5675	6	97.00	46
OM 353.914 (OM352 A)	Diesel	5675	6	97.00	46
OM 353.915 (OM352)	Diesel	5675	6	97.00	44
OM 353.916 (OM352)	Diesel	5675	6	97.00	44
OM 353.917 (OM352)	Diesel	5675	6	97.00	44
OM 353.922 (OM352 MBSA)	Diesel	5675	6	97.00	44
OM 353.923 (OM352 MBSA)	Diesel	5675	6	97.00	44

ENGINE INDEX

Motorverzeichnis • Index de moteur • Índice de Motor
 Indeks silnika • Модель Двигателя • دليل المحرك



CCM

x



9

OM 353.930 (OM352 MBSA)	Diesel	5675	6	97.00	44
OM 353.931 (OM352 MBSA)	Diesel	5675	6	97.00	44
OM 353.932 (OM352 MBSA)	Diesel	5675	6	97.00	44
OM 353.933 (OM352 MBSA)	Diesel	5675	6	97.00	44
OM 353.934 (OM352 MBSA)	Diesel	5675	6	97.00	44
OM 353.935 (OM352 MBSA)	Diesel	5675	6	97.00	44
OM 353.936 (OM352 MBSA)	Diesel	5675	6	97.00	44
OM 353.938 (OM352 MBSA)	Diesel	5675	6	97.00	44
OM 353.940 (OM352)	Diesel	5675	6	97.00	44
OM 353.941 (OM352)	Diesel	5675	6	97.00	44
OM 353.942 (OM352)	Diesel	5675	6	97.00	44
OM 353.943 (OM352)	Diesel	5675	6	97.00	44
OM 353.944 (OM352)	Diesel	5675	6	97.00	44
OM 353.945 (OM352)	Diesel	5675	6	97.00	44
OM 353.946 (OM352)	Diesel	5675	6	97.00	44
OM 353.949 (OM352)	Diesel	5675	6	97.00	44
OM 353.950 (OM352 A)	Diesel	5675	6	97.00	46
OM 353.951 (OM352 A)	Diesel	5675	6	97.00	46
OM 353.952 (OM352 A)	Diesel	5675	6	97.00	46
OM 353.953 (OM352 A)	Diesel	5675	6	97.00	46
OM 353.954 (OM352 A)	Diesel	5675	6	97.00	46
OM 353.957 (OM352 A)	Diesel	5675	6	97.00	44
OM 353.958 (OM352/3)	Diesel	5675	6	97.00	46
OM 353.959 (OM352 A)	Diesel	5675	6	97.00	46
OM 353.960 (OM352)	Diesel	5675	6	97.00	44
OM 353.961 (OM352)	Diesel	5675	6	97.00	44
OM 353.962 (OM352)	Diesel	5675	6	97.00	44
OM 353.963 (OM352)	Diesel	5675	6	97.00	44
OM 353.964 (OM352)	Diesel	5675	6	97.00	44
OM 353.965 (OM352)	Diesel	5675	6	97.00	44
OM 353.966 (OM352)	Diesel	5675	6	97.00	44
OM 353.967 (OM352)	Diesel	5675	6	97.00	44
OM 353.968 (OM352)	Diesel	5675	6	97.00	44
OM 353.969 (OM352)	Diesel	5675	6	97.00	44
OM 353.970 (OM352 A)	Diesel	5675	6	97.00	46
OM 353.971 (OM352 A)	Diesel	5675	6	97.00	46
OM 353.972 (OM352 A)	Diesel	5675	6	97.00	46
OM 353.973 (OM352 A)	Diesel	5675	6	97.00	46
OM 353.974 (OM352 A)	Diesel	5675	6	97.00	46
OM 353.975 (OM352 A)	Diesel	5675	6	97.00	46
OM 353.976 (OM352 A)	Diesel	5675	6	97.00	46
OM 353.977 (OM352 A)	Diesel	5675	6	97.00	45
OM 353.978 (OM352 A)	Diesel	5675	6	97.00	46
OM 353.980 (OM352)	Diesel	5675	6	97.00	44
OM 353.981 (OM352)	Diesel	5675	6	97.00	44
OM 353.982 (OM352)	Diesel	5675	6	97.00	44
OM 353.983 (OM352)	Diesel	5675	6	97.00	44
OM 353.984 (OM352)	Diesel	5675	6	97.00	44
OM 353.985 (OM352)	Diesel	5675	6	97.00	44
OM 353.989 (OM352)	Diesel	5675	6	97.00	44
OM 353.991 (OM352 A)	Diesel	5675	6	97.00	46
OM 353.995 (OM352 A)	Diesel	5675	6	97.00	44
OM 353.996 (OM352)	Diesel	5675	6	97.00	45
OM 353.997 (OM352 A)	Diesel	5675	6	97.00	46
OM 354.900 (Euro 2)	Diesel	3972	4	97.50	47
OM 354.901 (Euro 2 OM364 LA)	Diesel	3972	4	97.50	47
OM 354.902 (Euro 2 OM364 LA)	Diesel	3972	4	97.50	47
OM 354.903 (Euro 2 OM364 LA)	Diesel	3972	4	97.50	47
OM 354.920 (Euro 2 OM364 LA)	Diesel	3972	4	97.50	47
OM 354.921 (Euro 2 OM364 LA)	Diesel	3972	4	97.50	47



CCM



9

OM 354.922 (Euro 2 OM364 LA)	Diesel	3972	4	97.50	47
OM 354.923 (Euro 2 OM364 LA)	Diesel	3972	4	97.50	47
OM 354.924 (Euro 2 OM364 LA)	Diesel	3972	4	97.50	47
OM 354.925 (Euro 2 OM364 LA)	Diesel	3972	4	97.50	47
OM 354.926 (Euro 2)	Diesel	3972	4	97.50	47
OM 355.910	Diesel	11581	6	128.00	66
OM 355.911	Diesel	11581	6	128.00	66
OM 355.912	Diesel	11581	6	128.00	66
OM 355.913	Diesel	11581	6	128.00	66
OM 355.914	Diesel	11581	6	128.00	66
OM 355.915	Diesel	11581	6	128.00	66
OM 355.916	Diesel	11581	6	128.00	66
OM 355.918	Diesel	11581	6	128.00	66
OM 355.960	Diesel	11581	6	128.00	66
OM 355.961	Diesel	11581	6	128.00	66
OM 355.962	Diesel	11581	6	128.00	66
OM 355.963	Diesel	11581	6	128.00	66
OM 355.964	Diesel	11581	6	128.00	66
OM 355.966	Diesel	11581	6	128.00	66
OM 355.967	Diesel	11581	6	128.00	66
OM 355.968	Diesel	11581	6	128.00	67
OM 355.969	Diesel	11581	6	128.00	67
OM 355.970	Diesel	11581	6	128.00	66
OM 355.972	Diesel	11581	6	128.00	66
OM 355.973	Diesel	11581	6	128.00	66
OM 355.974	Diesel	11581	6	128.00	66
OM 355.975	Diesel	11581	6	128.00	66
OM 355.976	Diesel	11581	6	128.00	66
OM 355.977	Diesel	11581	6	128.00	67
OM 355.978	Diesel	11581	6	128.00	66
OM 355.979	Diesel	11581	6	128.00	66
OM 355.980	Diesel	11581	6	128.00	66
OM 355.981	Diesel	11581	6	128.00	66
OM 355.982	Diesel	11581	6	128.00	66
OM 355.983	Diesel	11581	6	128.00	66
OM 355.984	Diesel	11581	6	128.00	66
OM 356.901 (Euro 1 OM366)	Diesel	5958	6	97.50	49
OM 356.902 (Euro 1 OM366)	Diesel	5958	6	97.50	49
OM 356.903 (Euro 1 OM366)	Diesel	5958	6	97.50	49
OM 356.904 (Euro 1 OM366)	Diesel	5958	6	97.50	49
OM 356.905 (Euro 1 OM366)	Diesel	5958	6	97.50	49
OM 356.906 (Euro 1 OM366)	Diesel	5958	6	97.50	49
OM 356.907 (Euro 1 OM366)	Diesel	5958	6	97.50	49
OM 356.908 (Euro 1 OM366)	Diesel	5958	6	97.50	49
OM 356.909 (Euro 1 OM366)	Diesel	5958	6	97.50	49
OM 356.910 (Euro 1 OM366)	Diesel	5958	6	97.50	49
OM 356.911 (Euro 1 OM366)	Diesel	5958	6	97.50	49
OM 356.913 (Euro 1 OM366)	Diesel	5958	6	97.50	49
OM 356.914 (Euro 1 OM366)	Diesel	5958	6	97.50	49
OM 356.915 (Euro 1 OM366)	Diesel	5958	6	97.50	49
OM 356.916 (Euro 1 OM366)	Diesel	5958	6	97.50	49
OM 356.940 (Euro 1 OM366 A)	Diesel	5958	6	97.50	50
OM 356.941 (Euro 1 OM366 A)	Diesel	5958	6	97.50	51
OM 356.943 (Euro 1 OM366 A)	Diesel	5958	6	97.50	51
OM 356.944 (Euro 1 OM366 A)	Diesel	5958	6	97.50	51
OM 356.945 (Euro 1 OM366 A)	Diesel	5958	6	97.50	51
OM 356.946 (Euro 1 OM366 A)	Diesel	5958	6	97.50	51
OM 356.947 (Euro 1 OM366 A)	Diesel	5958	6	97.50	51
OM 356.948 (Euro 1 OM366 A)	Diesel	5958	6	97.50	51
OM 356.949 (Euro 1 OM366 A)	Diesel	5958	6	97.50	51

ENGINE INDEX

Motorverzeichnis • Index de moteur • Índice de Motor
 Indeks silnika • Модель Двигателя • دليل المحرك

CCM
x

9

OM 356.951 (Euro 1 OM366 A)	Diesel	5958	6	97.50	51
OM 356.952 (Euro 1 OM366 A)	Diesel	5958	6	97.50	51
OM 356.953 (Euro 1 OM366 A)	Diesel	5958	6	97.50	51
OM 356.956 (Euro 1 OM366 A)	Diesel	5958	6	97.50	51
OM 356.958 (Euro 1 OM366 A)	Diesel	5958	6	97.50	51
OM 356.959 (Euro 1 OM366 A)	Diesel	5958	6	97.50	51
OM 356.977 (Euro 1 OM366 LA)	Diesel	5958	6	97.50	52
OM 356.978 (Euro 1 OM366 LA)	Diesel	5958	6	97.50	52
OM 356.979 (OM366 LA)	Diesel	5958	6	97.50	52
OM 356.980 (OM366 LA)	Diesel	5958	6	97.50	52
OM 356.981 (OM366 LA)	Diesel	5958	6	97.50	48
OM 356.983 (Euro 1 OM366 LA)	Diesel	5958	6	97.50	52
OM 356.984 (OM366 LA)	Diesel	5958	6	97.50	50
OM 356.985 (OM366 LA)	Diesel	5958	6	97.50	50
OM 356.986 (OM366 LA)	Diesel	5958	6	97.50	52
OM 356.987 (Euro 1 OM366 LA)	Diesel	5958	6	97.50	52
OM 356.988 (Euro 1)	Diesel	5958	6	97.50	52
OM 356.989 (OM366 LA)	Diesel	5958	6	97.50	52
OM 356.990 (OM366 LA)	Diesel	5958	6	97.50	52
OM 356.991 (OM366 LA)	Diesel	5958	6	97.50	52
OM 356.992 (OM366 LA)	Diesel	5958	6	97.50	52
OM 356.993 (OM366 LA)	Diesel	5958	6	97.50	52
OM 356.994 (OM366 LA)	Diesel	5958	6	97.50	52
OM 356.995 (OM366 LA)	Diesel	5958	6	97.50	52
OM 356.996 (OM366 LA)	Diesel	5958	6	97.50	52
OM 356.997 (OM366 LA)	Diesel	5958	6	97.50	52
OM 356.998 (OM366 LA)	Diesel	5958	6	97.50	52
OM 356.999 (OM366 LA)	Diesel	5958	6	97.50	52
OM 357.900 (OM366 LA)	Diesel	5958	6	97.50	47
OM 357.901 (OM366 LA)	Diesel	5958	6	97.50	47
OM 357.902 (OM366 LA)	Diesel	5958	6	97.50	47
OM 357.903 (OM366 LA)	Diesel	5958	6	97.50	47
OM 357.904 (OM366 LA)	Diesel	5958	6	97.50	47
OM 357.906 (OM366 LA)	Diesel	5958	6	97.50	47
OM 357.907 (OM366 LA)	Diesel	5958	6	97.50	47
OM 357.908 (OM366 LA)	Diesel	5958	6	97.50	47
OM 357.909 (OM366 LA)	Diesel	5958	6	97.50	47
OM 357.910 (OM366 LA)	Diesel	5958	6	97.50	47
OM 357.915 (OM366 LA)	Diesel	5958	6	97.50	47
OM 357.916 (OM366 LA)	Diesel	5958	6	97.50	47
OM 357.917 (OM366 LA)	Diesel	5958	6	97.50	47
OM 357.918 (OM366 LA)	Diesel	5958	6	97.50	47
OM 357.919 (OM366 LA)	Diesel	5958	6	97.50	47
OM 357.920 (OM366 LA)	Diesel	5958	6	97.50	47
OM 357.921 (OM366 LA)	Diesel	5958	6	97.50	47
OM 357.922 (OM366 LA)	Diesel	5958	6	97.50	47
OM 357.924 (Euro 2 OM366 LA)	Diesel	5958	6	97.50	47
OM 357.925 (OM366 LA)	Diesel	5958	6	97.50	47
OM 357.926 (OM366 LA)	Diesel	5958	6	97.50	47
OM 357.927 (OM366 LA)	Diesel	5958	6	97.50	47
OM 357.929 (OM366 LA)	Diesel	5958	6	97.50	47
OM 357.930 (OM366 LA)	Diesel	5958	6	97.50	47
OM 357.931 (Euro 2 OM366 LA)	Diesel	5958	6	97.50	47
OM 357.932 (OM366 LA)	Diesel	5958	6	97.50	47
OM 357.933 (OM366 LA)	Diesel	5958	6	97.50	47
OM 357.934 (OM366 LA)	Diesel	5958	6	97.50	47
OM 357.935 (OM366 LA)	Diesel	5958	6	97.50	47
OM 357.936 (Euro 2 OM366 LA)	Diesel	5958	6	97.50	47
OM 357.937 (Euro 2 OM366 LA)	Diesel	5958	6	97.50	47
OM 357.938 (Euro 2)	Diesel	5958	6	97.50	47



CCM



9

OM 357.940 (OM366 LA)	Diesel	5958	6	97.50	47
OM 357.941 (OM366 LA)	Diesel	5958	6	97.50	47
OM 357.942 (OM366 LA)	Diesel	5958	6	97.50	47
OM 357.943 (OM366 LA)	Diesel	5958	6	97.50	47
OM 357.944 (OM366 LA)	Diesel	5958	6	97.50	47
OM 357.945 (Euro 2 OM366 LA)	Diesel	5958	6	97.50	47
OM 357.946 (OM366 LA)	Diesel	5958	6	97.50	47
OM 357.947 (OM366 LA)	Diesel	5958	6	97.50	47
OM 357.948 (OM366 LA)	Diesel	5958	6	97.50	47
OM 357.949 (Euro 2 OM366 LA)	Diesel	5958	6	97.50	47
OM 357.961 (OM366 LA)	Diesel	5958	6	97.50	47
OM 357.962 (OM366 LA)	Diesel	5958	6	97.50	47
OM 357.963 (OM366 LA)	Diesel	5958	6	97.50	47
OM 360.911	Diesel	8720	6	115.00	59
OM 360.912	Diesel	8720	6	115.00	59
OM 360.914	Diesel	8720	6	115.00	59
OM 360.915	Diesel	8720	6	115.00	59
OM 360.916	Diesel	8720	6	115.00	59
OM 360.917	Diesel	8720	6	115.00	59
OM 360.918	Diesel	8720	6	115.00	59
OM 360.931	Diesel	8720	6	115.00	59
OM 360.933	Diesel	8720	6	115.00	59
OM 360.934	Diesel	8720	6	115.00	59
OM 360.936	Diesel	8725	6	115.00	59
OM 360.937	Diesel	8725	6	115.00	59
OM 360.938	Diesel	8725	6	115.00	59
OM 360.939	Diesel	8720	6	115.00	59
OM 360.940	Diesel	8725	6	115.00	59
OM 360.941	Diesel	8725	6	115.00	59
OM 360.942	Diesel	8725	6	115.00	59
OM 360.943	Diesel	8725	6	115.00	59
OM 360.944	Diesel	8725	6	115.00	59
OM 360.946	Diesel	8725	6	115.00	59
OM 360.947	Diesel	8725	6	115.00	59
OM 360.948	Diesel	8725	6	115.00	59
OM 360.949	Diesel	8725	6	115.00	59
OM 360.954	Diesel	8725	6	115.00	59
OM 360.955	Diesel	8725	6	115.00	59
OM 360.956	Diesel	8725	6	115.00	59
OM 360.959	Diesel	8725	6	115.00	59
OM 360.974	Diesel	8725	6	115.00	59
OM 360.976	Diesel	8725	6	115.00	59
OM 360.978	Diesel	8725	6	115.00	59
OM 360.980	Diesel	8720	6	115.00	59
OM 360.981	Diesel	8720	6	115.00	59
OM 360.984	Diesel	8720	6	115.00	59
OM 360.985	Diesel	8720	6	115.00	59
OM 360.986	Diesel	8720	6	115.00	59
OM 362.906	Diesel	5675	6	97.00	45
OM 362.909	Diesel	5675	6	97.00	45
OM 362.910	Diesel	5675	6	97.00	45
OM 364.901	Diesel	3972	4	97.50	47
OM 364.906	Diesel	3972	4	97.50	48
OM 364.907	Diesel	3970	4	97.50	48
OM 364.908	Diesel	3972	4	97.50	48
OM 364.909	Diesel	3972	4	97.50	48
OM 364.911	Diesel	3972	4	97.50	48
OM 364.912	Diesel	3972	4	97.50	48
OM 364.913	Diesel	3972	4	97.50	48
OM 364.918	Diesel	3970	4	97.50	49

ENGINE INDEX

Motorverzeichnis • Index de moteur • Índice de Motor
 Indeks silnika • Модель Двигателя • دليل المحرك

CCM
x

9

OM 364.919	Diesel	3972	4	97.50	49
OM 364.920	Diesel	3972	4	97.50	49
OM 364.921 (Euro 1)	Diesel	3972	4	97.50	49
OM 364.950	Diesel	3972	4	97.50	50
OM 364.951	Diesel	3972	4	97.50	50
OM 364.952	Diesel	3972	4	97.50	50
OM 364.954	Diesel	3972	4	97.50	50
OM 364.957	Diesel	3972	4	97.50	51
OM 364.958	Diesel	3972	4	97.50	51
OM 364.959 (Euro 1)	Diesel	3972	4	97.50	51
OM 364.980	Diesel	3972	4	97.50	50
OM 364.981	Diesel	3972	4	97.50	50
OM 364.984	Diesel	3972	4	97.50	50
OM 364.985	Diesel	3972	4	97.50	52
OM 364.987	Diesel	3972	4	97.50	52
OM 366.901	Diesel	5958	6	97.50	51
OM 366.905	Diesel	5958	6	97.50	48
OM 366.906	Diesel	5960	6	97.50	48
OM 366.907	Diesel	5958	6	97.50	48
OM 366.908	Diesel	5958	6	97.50	48
OM 366.909	Diesel	5960	6	97.50	48
OM 366.910	Diesel	5958	6	97.50	48
OM 366.912	Diesel	5958	6	97.50	48
OM 366.913	Diesel	5958	6	97.50	48
OM 366.914	Diesel	5958	6	97.50	48
OM 366.917	Diesel	5958	6	97.50	48
OM 366.918	Diesel	5960	6	97.50	48
OM 366.919	Diesel	5958	6	97.50	48
OM 366.930	Diesel	5958	6	97.50	48
OM 366.931	Diesel	5958	6	97.50	48
OM 366.932	Diesel	5958	6	97.50	48
OM 366.933	Diesel	5958	6	97.50	48
OM 366.935	Diesel	5958	6	97.50	48
OM 366.936	Diesel	5960	6	97.50	48
OM 366.937	Diesel	5960	6	97.50	48
OM 366.938	Diesel	5958	6	97.50	48
OM 366.939	Diesel	5958	6	97.50	48
OM 366.940	Diesel	5958	6	97.50	48
OM 366.941 (Euro 1)	Diesel	5958	6	97.50	51
OM 366.942 (Euro 1)	Diesel	5958	6	97.50	51
OM 366.943 (Euro 1)	Diesel	5958	6	97.50	51
OM 366.944	Diesel	5958	6	97.50	50
OM 366.945	Diesel	5958	6	97.50	50
OM 366.946	Diesel	5960	6	97.50	50
OM 366.947	Diesel	5958	6	97.50	50
OM 366.948	Diesel	5958	6	97.50	50
OM 366.949	Diesel	5958	6	97.50	50
OM 366.951	Diesel	5960	6	97.50	50
OM 366.952	Diesel	5958	6	97.50	50
OM 366.953	Diesel	5958	6	97.50	50
OM 366.954	Diesel	5958	6	97.50	50
OM 366.955	Diesel	5958	6	97.50	50
OM 366.956	Diesel	5958	6	97.50	47
OM 366.957	Diesel	5958	6	97.50	50
OM 366.958	Diesel	5958	6	97.50	50
OM 366.960	Diesel	5960	6	97.50	50
OM 366.962	Diesel	5960	6	97.50	50
OM 366.963	Diesel	5958	6	97.50	50
OM 366.965	Diesel	5958	6	97.50	50
OM 366.966	Diesel	5958	6	97.50	50



CCM



9

OM 366.967	Diesel	5958	6	97.50	50
OM 366.968	Diesel	5958	6	97.50	50
OM 366.969	Diesel	5958	6	97.50	50
OM 366.970	Diesel	5958	6	97.50	50
OM 366.971	Diesel	5958	6	97.50	50
OM 366.972	Diesel	5958	6	97.50	50
OM 366.973	Diesel	5958	6	97.50	50
OM 366.974	Diesel	5958	6	97.50	50
OM 366.975	Diesel	5958	6	97.50	50
OM 366.976	Diesel	5958	6	97.50	50
OM 366.977	Diesel	5958	6	97.50	50
OM 366.978	Diesel	5958	6	97.50	50
OM 366.979	Diesel	5958	6	97.50	50
OM 366.980	Diesel	5960	6	97.50	50
OM 366.981	Diesel	5958	6	97.50	50
OM 366.983	Diesel	5958	6	97.50	50
OM 366.984	Diesel	5958	6	97.50	50
OM 366.988	Diesel	5960	6	97.50	50
OM 366.990	Diesel	5958	6	97.50	50
OM 366.992	Diesel	5958	6	97.50	50
OM 366.993	Diesel	5958	6	97.50	50
OM 366.994	Diesel	5958	6	97.50	50
OM 366.995	Diesel	5958	6	97.50	50
OM 366.996	Diesel	5958	6	97.50	50
OM 366.997 (Euro 1)	Diesel	5960	6	97.50	50
OM 366.999 (Euro 1)	Diesel	5958	6	97.50	52
OM 370.905 (OM364)	Diesel	3972	4	97.50	48
OM 370.950 (OM364 A)	Diesel	3972	4	97.50	50
OM 370.951 (OM364 A)	Diesel	3972	4	97.50	50
OM 370.952 (OM364 A)	Diesel	3972	4	97.50	48
OM 372.906 (OM 366)	Diesel	5958	6	97.50	48
OM 372.907 (OM 366)	Diesel	5958	6	97.50	48
OM 372.930 (OM 366)	Diesel	5958	6	97.50	48
OM 372.950 (OM364 A)	Diesel	5958	6	97.50	50
OM 372.951 (OM364 A)	Diesel	5958	6	97.50	50
OM 372.953 (OM364 A)	Diesel	5958	6	97.50	50
OM 372.956 (OM364 A)	Diesel	5958	6	97.50	50
OM 372.958 (OM364 A)	Diesel	5958	6	97.50	50
OM 372.980 (OM364 LA)	Diesel	5958	6	97.50	50
OM 372.981 (OM364 LA)	Diesel	5958	6	97.50	50
OM 376.905 (OM366)	Diesel	5958	6	97.50	48
OM 376.906 (OM366)	Diesel	5958	6	97.50	48
OM 376.907 (OM366)	Diesel	5958	6	97.50	48
OM 376.908 (OM366)	Diesel	5958	6	97.50	48
OM 376.909 (OM366)	Diesel	5958	6	97.50	48
OM 376.930 (OM366)	Diesel	5958	6	97.50	48
OM 376.941 (OM366 LA)	Diesel	5958	6	97.50	50
OM 376.945 (OM366 A)	Diesel	5958	6	97.50	50
OM 376.946 (OM366 A)	Diesel	5958	6	97.50	50
OM 376.947 (OM366 A)	Diesel	5958	6	97.50	50
OM 376.950 (OM366 A)	Diesel	5958	6	97.50	50
OM 376.951 (OM366 A)	Diesel	5958	6	97.50	50
OM 376.953 (OM366 A)	Diesel	5958	6	97.50	50
OM 376.954 (OM366 A)	Diesel	5958	6	97.50	50
OM 376.955 (OM366 A)	Diesel	5958	6	97.50	50
OM 376.956 (OM366 A)	Diesel	5958	6	97.50	50
OM 376.957 (OM366 A)	Diesel	5958	6	97.50	50
OM 376.958 (OM366 A)	Diesel	5958	6	97.50	50
OM 376.961 (OM366 A)	Diesel	5958	6	97.50	50
OM 376.962 (OM366 A)	Diesel	5958	6	97.50	50

ENGINE INDEX

Motorverzeichnis • Index de moteur • Índice de Motor
 Indeks silnika • Модель Двигателя • دليل المحرك



CCM



9

OM 376.963 (OM366 LA)	Diesel	5958	6	97.50	50
OM 376.964 (OM366 A)	Diesel	5958	6	97.50	50
OM 376.980 (OM366 LA MBTC-USA)	Diesel	5958	6	97.50	48
OM 376.981 (OM366 LA MBTC-USA)	Diesel	5958	6	97.50	48
OM 376.982 (OM366 LA MBTC-USA)	Diesel	5958	6	97.50	48
OM 376.987 (OM366 LA MBTC-USA)	Diesel	5958	6	97.50	48
OM 376.988 (OM366 LA MBTC-USA)	Diesel	5958	6	97.50	48
OM 376.989 (OM366 LA MBTC-USA)	Diesel	5958	6	97.50	48
OM 376.998 (OM366 LA MBTC-USA)	Diesel	5958	6	97.50	48
OM 376.999 (OM366 LA MBTC-USA)	Diesel	5958	6	97.50	48
OM 380.942	Diesel	3972	4	97.50	50
OM 382.912	Diesel	5958	6	97.50	48
OM 382.913	Diesel	5958	6	97.50	50
OM 382.919	Diesel	5958	6	97.50	50
OM 382.971	Diesel	5958	6	97.50	50
OM 384.906	Diesel	3972	4	97.50	48
OM 384.907	Diesel	3972	4	97.50	50
OM 386.950	Diesel	5958	6	97.50	50
OM 386.951	Diesel	5958	6	97.50	50
OM 386.952	Diesel	5958	6	97.50	50
OM 386.980	Diesel	5958	6	97.50	50
OM 386.981	Diesel	5958	6	97.50	50
OM 386.983	Diesel	5958	6	97.50	50
OM 401.905	Diesel	9572	V6	125.00	60
OM 401.906	Diesel	9572	V6	125.00	60
OM 401.907	Diesel	9572	V6	125.00	60
OM 401.908	Diesel	9572	V6	125.00	60
OM 401.909	Diesel	9572	V6	125.00	60
OM 401.912	Diesel	9572	V6	125.00	60
OM 401.913	Diesel	9572	V6	125.00	60
OM 401.914	Diesel	9572	V6	125.00	60
OM 401.915	Diesel	9572	V6	125.00	60
OM 401.916	Diesel	9572	V6	125.00	60
OM 401.917	Diesel	9572	V6	125.00	60
OM 401.918	Diesel	9572	V6	125.00	60
OM 401.919	Diesel	9572	V6	125.00	60
OM 401.921	Diesel	9572	V6	125.00	60
OM 401.922	Diesel	9572	V6	125.00	60
OM 401.923	Diesel	9572	V6	125.00	60
OM 401.925	Diesel	9572	V6	125.00	60
OM 401.926	Diesel	9572	V6	125.00	60
OM 401.927	Diesel	9572	V6	125.00	60
OM 401.928	Diesel	9572	V6	125.00	60
OM 401.970	Diesel	9572	V6	125.00	61
OM 401.972	Diesel	9572	V6	125.00	61
OM 401.973	Diesel	9572	V6	125.00	61
OM 401.974 (Euro 1)	Diesel	9572	V6	125.00	62
OM 401.975 (Euro 1)	Diesel	9572	V6	125.00	62
OM 401.977 (Euro 1)	Diesel	9572	V6	125.00	62
OM 401.978 (Euro 1)	Diesel	9572	V6	125.00	62
OM 401.979 (Euro 1)	Diesel	9572	V6	125.00	62
OM 401.980 (Euro 1)	Diesel	9572	V6	125.00	62
OM 401.981 (Euro 1)	Diesel	9572	V6	125.00	62
OM 401.982 (Euro 1)	Diesel	9572	V6	125.00	62
OM 401.983	Diesel	9572	V6	125.00	63
OM 401.984	Diesel	9572	V6	125.00	61
OM 401.985	Diesel	9572	V6	125.00	61
OM 401.986	Diesel	9572	V6	125.00	61
OM 401.987	Diesel	9572	V6	125.00	61
OM 401.989	Diesel	9572	V6	125.00	61



CCM

x



9

OM 401.990	Diesel	9572	V6	125.00	61
OM 401.991	Diesel	9572	V6	125.00	61
OM 401.992	Diesel	9572	V6	125.00	61
OM 401.993	Diesel	9572	V6	125.00	61
OM 401.994	Diesel	9572	V6	125.00	61
OM 402.905	Diesel	12800	V8	125.00	60
OM 402.906	Diesel	12800	V8	125.00	60
OM 402.907	Diesel	12800	V8	125.00	60
OM 402.910	Diesel	12800	V8	125.00	60
OM 402.912	Diesel	12800	V8	125.00	60
OM 402.913	Diesel	12760	V8	125.00	60
OM 402.914	Diesel	12800	V8	125.00	60
OM 402.916	Diesel	12800	V8	125.00	60
OM 402.917	Diesel	12760	V8	125.00	60
OM 402.919	Diesel	12800	V8	125.00	60
OM 402.921	Diesel	12760	V8	125.00	60
OM 402.923	Diesel	12800	V8	125.00	60
OM 402.924	Diesel	12800	V8	125.00	60
OM 402.925	Diesel	12760	V8	125.00	60
OM 402.926	Diesel	12800	V8	125.00	60
OM 402.927	Diesel	12800	V8	125.00	60
OM 402.928	Diesel	12800	V8	125.00	60
OM 402.970 (Euro 1)	Diesel	12763	V8	125.00	62
OM 402.971 (Euro 1)	Diesel	12763	V8	125.00	62
OM 402.972 (Euro 1)	Diesel	12763	V8	125.00	62
OM 402.973 (Euro 1)	Diesel	12763	V8	125.00	62
OM 402.974 (Euro 1)	Diesel	12763	V8	125.00	62
OM 402.975 (Euro 1)	Diesel	12763	V8	125.00	62
OM 402.977 (Euro 1)	Diesel	12763	V8	125.00	62
OM 402.978 (Euro 1)	Diesel	12763	V8	125.00	62
OM 402.982 (Euro 1)	Diesel	12763	V8	125.00	62
OM 402.983 (Euro 1)	Diesel	12763	V8	125.00	62
OM 402.984 (Euro 1)	Diesel	12763	V8	125.00	61
OM 402.985 (Euro 1)	Diesel	12763	V8	125.00	62
OM 402.986 (Euro 1)	Diesel	12763	V8	125.00	62
OM 402.987 (Euro 1)	Diesel	12763	V8	125.00	62
OM 402.989 (Euro 1)	Diesel	12763	V8	125.00	62
OM 402.990 (Euro 1)	Diesel	12763	V8	125.00	62
OM 402.995	Diesel	12763	V8	125.00	63
OM 402.996 (Euro 1)	Diesel	12763	V8	125.00	62
OM 403.910	Diesel	15953	V10	125.00	63
OM 403.915	Diesel	15953	V10	125.00	60
OM 403.916	Diesel	15953	V10	125.00	60
OM 403.917	Diesel	15953	V10	125.00	60
OM 403.918	Diesel	15953	V10	125.00	60
OM 403.919	Diesel	15953	V10	125.00	60
OM 403.930	Diesel	15953	V10	125.00	60
OM 403.931	Diesel	15953	V10	125.00	60
OM 403.932	Diesel	15953	V10	125.00	60
OM 403.933	Diesel	15953	V10	125.00	63
OM 403.934	Diesel	15953	V10	125.00	60
OM 403.935	Diesel	15953	V10	125.00	63
OM 404	Diesel	20911	V12	125.00	60
OM 404 A	Diesel	20911	V12	125.00	63
OM 421.905	Diesel	10964	V6	128.00	68
OM 421.906	Diesel	10964	V6	128.00	68
OM 421.907	Diesel	10964	V6	128.00	68
OM 421.908	Diesel	10964	V6	128.00	68
OM 421.909	Diesel	10964	V6	128.00	68
OM 421.910	Diesel	10964	V6	128.00	68

ENGINE INDEX

Motorverzeichnis • Index de moteur • Índice de Motor
 Indeks silnika • Модель Двигателя • دليل المحرك

CCM
x

9

OM 421.951	Diesel	10964	V6	128.00	69
OM 422.901	Diesel	14618	V8	128.00	69
OM 422.905	Diesel	14618	V8	128.00	68
OM 422.906	Diesel	14618	V8	128.00	68
OM 422.907	Diesel	14618	V8	128.00	68
OM 422.908	Diesel	14618	V8	128.00	68
OM 422.909	Diesel	14618	V8	128.00	68
OM 422.910	Diesel	14618	V8	128.00	68
OM 422.911	Diesel	14618	V8	128.00	68
OM 422.912	Diesel	14618	V8	128.00	68
OM 422.913	Diesel	14618	V8	128.00	68
OM 422.914	Diesel	14618	V8	128.00	68
OM 422.915	Diesel	14618	V8	128.00	68
OM 422.916	Diesel	14618	V8	128.00	68
OM 422.917	Diesel	14618	V8	128.00	68
OM 422.918	Diesel	14618	V8	128.00	68
OM 422.919	Diesel	14618	V8	128.00	68
OM 422.920	Diesel	14618	V8	128.00	68
OM 422.921	Diesel	14618	V8	128.00	68
OM 422.922	Diesel	14618	V8	128.00	68
OM 422.923	Diesel	14618	V8	128.00	68
OM 422.951	Diesel	14618	V8	128.00	69
OM 422.952	Diesel	14618	V8	128.00	69
OM 422.953	Diesel	14618	V8	128.00	69
OM 422.954	Diesel	14618	V8	128.00	69
OM 422.955	Diesel	14618	V8	128.00	69
OM 422.956	Diesel	14618	V8	128.00	69
OM 422.957	Diesel	14618	V8	128.00	69
OM 422.958	Diesel	14618	V8	128.00	69
OM 422.959	Diesel	14618	V8	128.00	69
OM 422.963	Diesel	14618	V8	128.00	69
OM 423.901	Diesel	18273	V10	128.00	71
OM 423.905	Diesel	18273	V10	128.00	68
OM 423.906	Diesel	18273	V10	128.00	68
OM 423.907	Diesel	18273	V10	128.00	68
OM 423.908	Diesel	18273	V10	128.00	68
OM 423.909	Diesel	18273	V10	128.00	68
OM 423.950	Diesel	18273	V10	128.00	69
OM 424.900	Diesel	21927	V12	128.00	68
OM 424.901	Diesel	21927	V12	128.00	69
OM 427 A	Diesel	11967	6	128.00	65
OM 427 LA	Diesel	11967	6	128.00	65
OM 427.905	Diesel	11967	6	128.00	65
OM 427.910	Diesel	11967	6	128.00	65
OM 427.911	Diesel	11967	6	128.00	65
OM 427.950	Diesel	11967	6	128.00	65
OM 427.951	Diesel	11967	6	128.00	65
OM 427.952	Diesel	11967	6	128.00	65
OM 429.951	Diesel	9973	5	128.00	65
OM 429.952	Diesel	9973	5	128.00	65
OM 429.953	Diesel	9973	5	128.00	65
OM 429.955	Diesel	9973	5	128.00	65
OM 440.907 (Euro 1 OM442)	Diesel	15078	V8	130.00	85
OM 440.908 (Euro 1 OM442)	Diesel	15078	V8	130.00	85
OM 440.909 (OM442)	Diesel	15078	V8	130.00	86
OM 440.910 (Euro 1 OM442)	Diesel	15078	V8	130.00	85
OM 440.911 (Euro 1 OM442)	Diesel	15078	V8	130.00	85
OM 440.940 (OM442 A)	Diesel	14618	V8	128.00	82
OM 440.941 (OM442 A)	Diesel	14618	V8	128.00	82
OM 440.942 (OM442 A)	Diesel	14618	V8	128.00	82



CCM

x



9

OM 440.943 (OM442 A)	Diesel	14618	V8	128.00	82
OM 440.945 (Euro 1 OM442 A)	Diesel	14618	V8	128.00	83
OM 440.948 (OM442 A)	Diesel	14618	V8	128.00	71
OM 440.949 (OM442 A)	Diesel	14618	V8	128.00	71
OM 440.970 (Euro 1 OM442 LA)	Diesel	14618	V8	128.00	72
OM 440.971 (Euro 1 OM442 LA)	Diesel	14618	V8	128.00	72
OM 440.972 (Euro 1 OM442 LA)	Diesel	14618	V8	128.00	72
OM 440.973 (Euro 1 OM442 LA)	Diesel	14618	V8	128.00	72
OM 440.974 (OM442 LA)	Diesel	14618	V8	128.00	71
OM 440.975 (Euro 1 OM442 LA)	Diesel	14618	V8	128.00	72
OM 440.976 (Euro 1 OM442 LA)	Diesel	14618	V8	128.00	72
OM 440.978 (Euro 1 OM442 LA)	Diesel	14618	V8	128.00	72
OM 440.979 (Euro 1 OM442 LA)	Diesel	14618	V8	128.00	72
OM 440.980 (Euro 1 OM442 LA)	Diesel	14618	V8	128.00	72
OM 440.981 (Euro 1 OM442 LA)	Diesel	14618	V8	128.00	72
OM 440.982 (Euro 1 OM442 LA)	Diesel	14618	V8	128.00	72
OM 440.983 (Euro 1 OM442 LA)	Diesel	14618	V8	128.00	72
OM 440.984 (Euro 1 OM442 LA)	Diesel	14618	V8	128.00	72
OM 440.985 (Euro 1 OM442 LA)	Diesel	14618	V8	128.00	72
OM 440.986 (Euro 1 OM442 LA)	Diesel	14618	V8	128.00	72
OM 440.987 (Euro 1 OM442 LA)	Diesel	14618	V8	128.00	72
OM 440.988 (Euro 1 OM442 LA)	Diesel	14618	V8	128.00	72
OM 440.989 (Euro 1 OM442 LA)	Diesel	14618	V8	128.00	72
OM 440.990 (Euro 1 OM442 LA)	Diesel	14618	V8	128.00	72
OM 440.991 (Euro 1 OM442 LA)	Diesel	14618	V8	128.00	72
OM 441	Diesel	10964	6	130.00	85
OM 441 (Euro 1)	Diesel	11309	6	130.00	85
OM 441.905	Diesel	11309	V6	130.00	86
OM 441.906	Diesel	11309	V6	130.00	86
OM 441.907	Diesel	11309	V6	130.00	86
OM 441.908	Diesel	11309	V6	130.00	86
OM 441.909	Diesel	11309	V6	130.00	86
OM 441.911	Diesel	11309	V6	130.00	86
OM 441.912	Diesel	11309	V6	130.00	86
OM 441.913	Diesel	11309	V6	130.00	86
OM 441.914	Diesel	11309	V6	130.00	86
OM 441.915	Diesel	11309	V6	130.00	86
OM 441.916	Diesel	11309	V6	130.00	86
OM 441.917	Diesel	11309	V6	130.00	86
OM 441.918	Diesel	11309	V6	130.00	86
OM 441.919	Diesel	11309	V6	130.00	86
OM 441.920	Diesel	11309	V6	130.00	86
OM 441.922 (Euro 1)	Diesel	11309	V6	130.00	85
OM 441.923	Diesel	11309	V6	130.00	86
OM 441.924	Diesel	11309	V6	130.00	86
OM 441.925	Diesel	11309	V6	130.00	86
OM 441.926	Diesel	11309	V6	130.00	86
OM 441.927	Diesel	11309	V6	130.00	86
OM 441.932	Diesel	11309	V6	130.00	86
OM 441.933 (Euro 1)	Diesel	11309	V6	130.00	85
OM 441.950	Diesel	10964	V6	128.00	70
OM 441.951	Diesel	10964	V6	128.00	70
OM 441.952	Diesel	10964	V6	128.00	71
OM 441.953	Diesel	10964	V6	128.00	70
OM 441.960	Diesel	10964	V6	128.00	70
OM 441.961	Diesel	10964	V6	128.00	70
OM 441.962	Diesel	10964	V6	128.00	70
OM 441.980	Diesel	10964	V6	128.00	72
OM 441.981	Diesel	10964	V6	128.00	70
OM 441.982	Diesel	10964	V6	128.00	70

ENGINE INDEX

Motorverzeichnis • Index de moteur • Índice de Motor
 Indeks silnika • Модель Двигателя • دليل المحرك



CCM



9

OM 441.983	Diesel	10964	V6	128.00	70
OM 441.985	Diesel	10964	V6	128.00	70
OM 441.986 (Euro 1)	Diesel	10964	V6	128.00	72
OM 441.987 (Euro 1)	Diesel	10964	V6	128.00	72
OM 441.988 (Euro 1)	Diesel	10964	V6	128.00	72
OM 441.989 (Euro 1)	Diesel	10964	V6	128.00	72
OM 441.990 (Euro 1)	Diesel	10964	V6	128.00	72
OM 441.991 (Euro 1)	Diesel	10964	V6	128.00	72
OM 441.992 (Euro 1)	Diesel	10964	V6	128.00	72
OM 441.993 (Euro 1)	Diesel	10964	V6	128.00	72
OM 441.994 (Euro 1)	Diesel	10964	V6	128.00	72
OM 441.995 (Euro 1)	Diesel	10964	V6	128.00	72
OM 441.996 (Euro 1)	Diesel	10964	V6	128.00	72
OM 441.997 (Euro 1)	Diesel	10964	V6	128.00	72
OM 441.998 (Euro 1)	Diesel	10964	V6	128.00	72
OM 441.999 (Euro 1)	Diesel	10964	V6	128.00	72
OM 442	Diesel	15080	V8	130.00	85
OM 442 (Euro 1)	Diesel	15080	V8	130.00	85
OM 442 A	Diesel	14618	V8	128.00	71
OM 442 A (Euro 1)	Diesel	14618	V8	128.00	83
OM 442.901	Diesel	14618	V8	128.00	70
OM 442.905	Diesel	15078	V8	130.00	86
OM 442.906	Diesel	15078	V8	130.00	86
OM 442.907	Diesel	15078	V8	130.00	86
OM 442.908	Diesel	15078	V8	130.00	86
OM 442.909	Diesel	15078	V8	130.00	86
OM 442.910	Diesel	15078	V8	130.00	86
OM 442.911	Diesel	15078	V8	130.00	86
OM 442.914	Diesel	15078	V8	130.00	86
OM 442.915	Diesel	15078	V8	130.00	86
OM 442.916	Diesel	15078	V8	130.00	86
OM 442.917	Diesel	15078	V8	130.00	86
OM 442.918	Diesel	15078	V8	130.00	86
OM 442.919	Diesel	15078	V8	130.00	86
OM 442.920	Diesel	15078	V8	130.00	86
OM 442.921	Diesel	15078	V8	130.00	86
OM 442.922	Diesel	15078	V8	130.00	86
OM 442.923	Diesel	15078	V8	130.00	86
OM 442.924	Diesel	15078	V8	130.00	86
OM 442.925	Diesel	15078	V8	130.00	86
OM 442.926	Diesel	15078	V8	130.00	86
OM 442.927	Diesel	15078	V8	130.00	86
OM 442.928	Diesel	15078	V8	130.00	86
OM 442.929	Diesel	15078	V8	130.00	86
OM 442.930	Diesel	15078	V8	130.00	86
OM 442.931	Diesel	15078	V8	130.00	85
OM 442.932	Diesel	15078	V8	130.00	86
OM 442.933	Diesel	15078	V8	130.00	86
OM 442.934	Diesel	15078	V8	130.00	86
OM 442.935	Diesel	15078	V8	130.00	86
OM 442.939	Diesel	15078	V8	130.00	86
OM 442.940	Diesel	14618	V8	128.00	70
OM 442.941	Diesel	14618	V8	128.00	70
OM 442.942	Diesel	14618	V8	128.00	70
OM 442.943	Diesel	14618	V8	128.00	70
OM 442.944	Diesel	14618	V8	128.00	70
OM 442.945	Diesel	14618	V8	128.00	70
OM 442.946	Diesel	14618	V8	128.00	70
OM 442.950	Diesel	14618	V8	128.00	84
OM 442.951	Diesel	14618	V8	128.00	70



CCM



9

OM 442.952	Diesel	14618	V8	128.00	84
OM 442.953	Diesel	14618	V8	128.00	70
OM 442.954	Diesel	14618	V8	128.00	70
OM 442.955	Diesel	14618	V8	128.00	70
OM 442.957	Diesel	14618	V8	128.00	70
OM 442.958	Diesel	14618	V8	128.00	70
OM 442.959	Diesel	14618	V8	128.00	70
OM 442.960	Diesel	14618	V8	128.00	70
OM 442.961	Diesel	14618	V8	128.00	70
OM 442.962	Diesel	14618	V8	128.00	84
OM 442.963	Diesel	14618	V8	128.00	70
OM 442.964	Diesel	14618	V8	128.00	70
OM 442.965	Diesel	14618	V8	128.00	70
OM 442.966	Diesel	14618	V8	128.00	70
OM 442.967	Diesel	14618	V8	128.00	70
OM 442.968	Diesel	14618	V8	128.00	70
OM 442.970	Diesel	14618	V8	128.00	70
OM 442.971	Diesel	14618	V8	128.00	70
OM 442.972	Diesel	14618	V8	128.00	70
OM 442.976	Diesel	14618	V8	128.00	70
OM 442.977	Diesel	14618	V8	128.00	83
OM 442.978	Diesel	14618	V8	128.00	83
OM 442.980	Diesel	14618	V8	128.00	70
OM 442.982	Diesel	14618	V8	128.00	70
OM 442.983	Diesel	14618	V8	128.00	70
OM 442.985	Diesel	14618	V8	128.00	70
OM 442.989	Diesel	14618	V8	128.00	70
OM 442.991	Diesel	14618	V8	128.00	70
OM 442.992	Diesel	14618	V8	128.00	70
OM 442.993	Diesel	14618	V8	128.00	70
OM 442.994	Diesel	14618	V8	128.00	70
OM 442.995 (Euro 1)	Diesel	14618	V8	128.00	72
OM 442.996 (Euro 1)	Diesel	14618	V8	128.00	72
OM 442.997 (Euro 1)	Diesel	14618	V8	128.00	72
OM 442.998 (Euro 1)	Diesel	14618	V8	128.00	72
OM 442.999 (Euro 1)	Diesel	14618	V8	128.00	72
OM 443.900	Diesel	18848	V10	130.00	85
OM 443.901	Diesel	18273	V10	128.00	70
OM 443.905	Diesel	18848	V10	130.00	86
OM 443.940	Diesel	18273	V10	128.00	70
OM 443.980	Diesel	18273	V10	128.00	70
OM 444	Diesel	22618	V12	130.00	86
OM 444 LA	Diesel	21927	V12	128.00	71
OM 444.901	Diesel	21927	V12	128.00	70
OM 445.920 (Euro 2 OM441 LA)	Diesel	10964	V6	128.00	73
OM 445.921 (Euro 2 OM441 LA)	Diesel	10964	V6	128.00	73
OM 445.922 (Euro 2 OM441 LA)	Diesel	10964	V6	128.00	73
OM 445.923 (Euro 2 OM441 LA)	Diesel	10964	V6	128.00	73
OM 445.924 (Euro 2 OM441 LA)	Diesel	10964	V6	128.00	73
OM 445.925 (Euro 2 OM441 LA)	Diesel	10964	V6	128.00	73
OM 445.926 (Euro 2 OM441 LA)	Diesel	10964	V6	128.00	73
OM 445.927 (Euro 2 OM441 LA)	Diesel	10964	V6	128.00	73
OM 445.929 (Euro 2 OM441 LA)	Diesel	10964	V6	128.00	73
OM 445.930 (Euro 2 OM441 LA)	Diesel	10964	V6	128.00	73
OM 445.931 (Euro 2 OM441 LA)	Diesel	10964	V6	128.00	73
OM 445.933 (Euro 2 OM441 LA)	Diesel	10964	V6	128.00	73
OM 445.934 (Euro 2 OM441 LA)	Diesel	10964	V6	128.00	73
OM 445.935 (Euro 2 OM441 LA)	Diesel	10964	V6	128.00	73
OM 445.936 (Euro 2 OM441 LA)	Diesel	10964	V6	128.00	73
OM 445.937 (Euro 2 OM441 LA)	Diesel	10964	V6	128.00	73

ENGINE INDEX

Motorverzeichnis • Index de moteur • Índice de Motor
 Indeks silnika • Модель Двигателя • دليل المحرك

CCM
x

9

OM 445.938 (Euro 2 OM441 LA)	Diesel	10964	V6	128.00	73
OM 445.939 (Euro 2 OM441 LA)	Diesel	10964	V6	128.00	73
OM 445.940 (Euro 2 OM441 LA)	Diesel	10964	V6	128.00	73
OM 445.941 (Euro 2 OM441 LA)	Diesel	10964	V6	128.00	73
OM 446.920 (Euro 2 OM442 LA)	Diesel	14618	V8	128.00	73
OM 446.922 (Euro 2 OM442 LA)	Diesel	14618	V8	128.00	73
OM 446.923 (OM442 LA)	Diesel	14618	V8	128.00	73
OM 446.924 (Euro 2 OM442 LA)	Diesel	14618	V8	128.00	73
OM 446.925 (Euro 2 OM442 LA)	Diesel	14618	V8	128.00	73
OM 446.926 (Euro 2 OM442 LA)	Diesel	14618	V8	128.00	73
OM 446.927 (Euro 2 OM442 LA)	Diesel	14618	V8	128.00	73
OM 446.928 (Euro 2 OM442 LA)	Diesel	14618	V8	128.00	73
OM 446.929 (Euro 2 OM442 LA)	Diesel	14618	V8	128.00	73
OM 446.930 (Euro 2 OM442 LA)	Diesel	14618	V8	128.00	73
OM 446.931 (Euro 2 OM442 LA)	Diesel	14618	V8	128.00	73
OM 446.932 (Euro 2 OM442 LA)	Diesel	14618	V8	128.00	73
OM 446.933 (Euro 2 OM442 LA)	Diesel	14618	V8	128.00	73
OM 446.934 (Euro 2 OM442 LA)	Diesel	14618	V8	128.00	73
OM 446.935 (Euro 2 OM442 LA)	Diesel	14618	V8	128.00	73
OM 446.936 (Euro 2 OM442 LA)	Diesel	14618	V8	128.00	73
OM 446.938 (Euro 2 OM442 LA)	Diesel	14618	V8	128.00	73
OM 446.939 (Euro 2 OM442 LA)	Diesel	14618	V8	128.00	73
OM 446.940 (Euro 2 OM442 LA)	Diesel	14618	V8	128.00	73
OM 446.941 (Euro 2 OM442 LA)	Diesel	14618	V8	128.00	73
OM 446.942 (Euro 2 OM442 LA)	Diesel	14618	V8	128.00	73
OM 446.943 (Euro 2 OM442 LA)	Diesel	14618	V8	128.00	73
OM 446.945 (Euro 2 OM442 LA)	Diesel	14618	V8	128.00	73
OM 446.946 (Euro 2 OM442 LA)	Diesel	14618	V8	128.00	73
OM 446.948 (Euro 2 OM442 LA)	Diesel	14618	V8	128.00	73
OM 447	Diesel	11967	6	128.00	65
OM 447 A/LA	Diesel	11967	6	128.00	65
OM 447 LA	Diesel	11967	6	128.00	65
OM 447.900	Diesel	11967	6	128.00	65
OM 447.905	Diesel	11967	6	128.00	65
OM 447.906	Diesel	11967	6	128.00	65
OM 447.907	Diesel	11967	6	128.00	65
OM 447.908	Diesel	11967	6	128.00	65
OM 447.910	Diesel	11967	6	128.00	65
OM 447.911	Diesel	11967	6	128.00	65
OM 447.912	Diesel	11967	6	128.00	65
OM 447.913 (Euro 1)	Diesel	11967	6	128.00	65
OM 447.914 (Euro 1)	Diesel	11967	6	128.00	65
OM 447.915	Diesel	11967	6	128.00	65
OM 447.916	Petrol	11967	6	128.00	65
OM 447.947 (Euro 1)	Diesel	11967	6	128.00	65
OM 447.948 (Euro 2)	Diesel	11967	6	128.00	65
OM 447.949 (Euro 2)	Diesel	11967	6	128.00	65
OM 447.950	Diesel	11967	6	128.00	65
OM 447.951	Diesel	11967	6	128.00	65
OM 447.952 (Euro 1)	Diesel	11967	6	128.00	65
OM 447.953 (Euro 1)	Diesel	11967	6	128.00	65
OM 447.954 (Euro 1)	Diesel	11967	6	128.00	74
OM 447.955 (Euro 1)	Diesel	11967	6	128.00	74
OM 447.956 (Euro 1)	Diesel	11967	6	128.00	74
OM 447.957 (Euro 1)	Diesel	11967	6	128.00	74
OM 447.958 (Euro 1)	Diesel	11967	6	128.00	74
OM 447.959 (Euro 1)	Diesel	11967	6	128.00	74
OM 447.960 (Euro 1)	Diesel	11967	6	128.00	65
OM 447.970 (Euro 2)	Diesel	11967	6	128.00	75
OM 447.971 (Euro 2)	Diesel	11967	6	128.00	75



CCM



9

OM 447.972 (Euro 2)	Diesel	11967	6	128.00	75
OM 447.973 (Euro 2)	Diesel	11967	6	128.00	75
OM 447.974 (Euro 2)	Diesel	11967	6	128.00	75
OM 447.975 (Euro 1)	Diesel	11967	6	128.00	75
OM 447.976 (Euro 2)	Diesel	11967	6	128.00	75
OM 447.977 (Euro 2)	Diesel	11967	6	128.00	75
OM 447.978	Diesel	11967	6	128.00	75
OM 447.979 (Euro 2)	Diesel	11967	6	128.00	75
OM 447.980 (Euro 1)	Diesel	11967	6	128.00	74
OM 447.981 (Euro 1)	Diesel	11967	6	128.00	74
OM 447.982 (Euro 1)	Diesel	11967	6	128.00	74
OM 447.983 (Euro 1)	Diesel	11967	6	128.00	74
OM 447.984 (Euro 1)	Diesel	11967	6	128.00	74
OM 447.985 (Euro 1)	Diesel	11967	6	128.00	74
OM 447.986 (Euro 1)	Diesel	11967	6	128.00	74
OM 447.987 (Euro 1)	Diesel	11967	6	128.00	74
OM 447.988 (Euro 2)	Diesel	11967	6	128.00	75
OM 447.990 (Euro 2)	Diesel	11967	6	128.00	75
OM 447.991 (Euro 2)	Diesel	11967	6	128.00	75
OM 447.992 (Euro 2)	Diesel	11967	6	128.00	75
OM 447.993 (Euro 2)	Diesel	11967	6	128.00	75
OM 447.994 (Euro 2)	Diesel	11967	6	128.00	75
OM 447.995 (Euro 1)	Diesel	11967	6	128.00	74
OM 447.996 (Euro 2)	Diesel	11967	6	128.00	75
OM 447.998 (Euro 2)	Diesel	11967	6	128.00	75
OM 447.999 (Euro 2)	Diesel	11967	6	128.00	75
OM 457.910 (Euro 5)	Diesel	11967	6	128.00	76
OM 457.914 (Euro 3)	Diesel	11967	6	128.00	77
OM 457.915 (Euro 3)	Diesel	11967	6	128.00	77
OM 457.916 (Euro 3)	Diesel	11967	6	128.00	77
OM 457.917 (Euro 2/3)	Diesel	11967	6	128.00	77
OM 457.918 (Euro 3)	Diesel	11967	6	128.00	77
OM 457.919 (Euro 3)	Diesel	11967	6	128.00	77
OM 457.920 (Euro 3)	Diesel	11967	6	128.00	77
OM 457.922 (Euro 3)	Diesel	11967	6	128.00	77
OM 457.923 (Euro 3)	Diesel	11967	6	128.00	77
OM 457.924 (Euro 3)	Diesel	11967	6	128.00	77
OM 457.925 (Euro 3)	Diesel	11967	6	128.00	77
OM 457.926 (Euro 3)	Diesel	11967	6	128.00	77
OM 457.927 (Euro 3)	Diesel	11967	6	128.00	77
OM 457.928 (Euro 3)	Diesel	11967	6	128.00	77
OM 457.929 (Euro 3)	Diesel	11967	6	128.00	78
OM 457.931 (Euro 3)	Diesel	11967	6	128.00	77
OM 457.932 (Euro 3)	Diesel	11967	6	128.00	77
OM 457.933 (Euro 2/3)	Diesel	11967	6	128.00	79
OM 457.934 (Euro 2/3)	Diesel	11967	6	128.00	79
OM 457.935 (Euro 2/3)	Diesel	11967	6	128.00	79
OM 457.936 (Euro 2)	Diesel	11967	6	128.00	79
OM 457.937 (Euro 2/3)	Diesel	11967	6	128.00	79
OM 457.938 (Euro 2)	Diesel	11967	6	128.00	79
OM 457.939 (Euro 2)	Diesel	11967	6	128.00	79
OM 457.940 (Euro 2/3)	Diesel	11967	6	128.00	79
OM 457.941 (Euro 2/3)	Diesel	11967	6	128.00	79
OM 457.942 (Euro 2/3)	Diesel	11967	6	128.00	79
OM 457.943 (Euro 2/3)	Diesel	11967	6	128.00	79
OM 457.944 (Euro 2/3)	Diesel	11967	6	128.00	79
OM 457.945 (Euro 2)	Diesel	11967	6	128.00	79
OM 457.946 (Euro 2)	Diesel	11967	6	128.00	79
OM 457.947 (Euro 2)	Diesel	11967	6	128.00	78
OM 457.948 (Euro 3)	Diesel	11967	6	128.00	80

ENGINE INDEX

Motorverzeichnis • Index de moteur • Índice de Motor
 Indeks silnika • Модель Двигателя • دليل المحرك



CCM



9

OM 457.949 (Euro 2)	Diesel	11967	6	128.00	79
OM 457.950 (Euro 4)	Diesel	11967	6	128.00	80
OM 457.951 (Euro 4)	Diesel	11967	6	128.00	80
OM 457.952 (Euro 4)	Diesel	11967	6	128.00	80
OM 457.953 (Euro 4)	Diesel	11967	6	128.00	80
OM 457.954 (Euro 4)	Diesel	11967	6	128.00	80
OM 457.955 (Euro 3)	Diesel	11967	6	128.00	78
OM 457.956 (Euro 3)	Diesel	11967	6	128.00	80
OM 457.957 (Euro 3)	Diesel	11967	6	128.00	80
OM 457.958 (Euro 2/3)	Diesel	11967	6	128.00	78
OM 457.959 (Euro 4)	Diesel	11967	6	128.00	80
OM 457.960 (Euro 2)	Diesel	11967	6	128.00	78
OM 457.961 (Euro 3)	Diesel	11967	6	128.00	80
OM 457.962 (Euro 3)	Diesel	11967	6	128.00	78
OM 457.964 (Euro 4)	Diesel	11967	6	128.00	80
OM 457.965 (Euro 4)	Diesel	11967	6	128.00	80
OM 457.966 (Euro 4)	Diesel	11967	6	128.00	80
OM 457.967 (Euro 4)	Diesel	11967	6	128.00	80
OM 457.968 (Euro 4)	Diesel	11967	6	128.00	80
OM 457.969 (Euro 4)	Diesel	11967	6	128.00	80
OM 457.973 (Euro 4)	Diesel	11967	6	128.00	80
OM 457.974 (Euro 4)	Diesel	11967	6	128.00	80
OM 457.976 (Euro 3)	Diesel	11967	6	128.00	80
OM 457.977 (Euro 4)	Diesel	11967	6	128.00	80
OM 457.980 (Euro 2)	Diesel	11967	6	128.00	80
OM 457.981 (Euro 3)	Diesel	11967	6	128.00	80
OM 457.984 (Euro 4)	Diesel	11967	6	128.00	80
OM 458.960 (Euro 3)	Diesel	11967	6	128.00	77
OM 458.970 (Euro 3)	Diesel	11967	6	128.00	77
OM 458.980 (Euro 3)	Diesel	11967	6	128.00	77
OM 458.990	Diesel	11967	6	128.00	76
OM 458.991	Diesel	11967	6	128.00	76
OM 460.900 (Euro 3)	Diesel	12816	6	128.00	78
OM 460.901 (Euro 3)	Diesel	12816	6	128.00	78
OM 460.902 (Euro 3)	Diesel	12816	6	128.00	78
OM 460.903 (Euro 3)	Diesel	12816	6	128.00	78
OM 460.904 (Euro 3)	Diesel	12816	6	128.00	78
OM 460.905 (Euro 3)	Diesel	12816	6	128.00	78
OM 460.906 (Euro 3)	Diesel	12816	6	128.00	78
OM 460.907 (Euro 3)	Diesel	12816	6	128.00	78
OM 460.908 (Euro 3)	Diesel	12816	6	128.00	78
OM 460.909 (Euro 3)	Diesel	12816	6	128.00	78
OM 460.910 (Euro 3)	Diesel	12816	6	128.00	78
OM 460.911 (Euro 3)	Diesel	12816	6	128.00	78
OM 460.912 (Euro 3)	Diesel	12816	6	128.00	78
OM 460.913 (Euro 3)	Diesel	12816	6	128.00	78
OM 460.914 (Euro 3)	Diesel	12816	6	128.00	78
OM 460.915 (Euro 3)	Diesel	12816	6	128.00	78
OM 460.916 (Euro 3)	Diesel	12816	6	128.00	78
OM 460.917 (Euro 3)	Diesel	12816	6	128.00	78
OM 460.918 (Euro 3)	Diesel	12816	6	128.00	78
OM 460.919 (Euro 3)	Diesel	12816	6	128.00	78
OM 460.920 (Euro 3)	Diesel	12816	6	128.00	78
OM 460.921 (Euro 3)	Diesel	12816	6	128.00	78
OM 460.922 (Euro 3)	Diesel	12816	6	128.00	78
OM 460.923 (Euro 3)	Diesel	12816	6	128.00	78
OM 460.925 (Euro 3)	Diesel	12816	6	128.00	78
OM 460.926	Diesel	12816	6	128.00	81
OM 460.927	Diesel	12816	6	128.00	81
OM 460.929 (Euro 3)	Diesel	12816	6	128.00	78



CCM



9

OM 460.931 (Euro 3)	Diesel	12816	6	128.00	78
OM 460.932	Diesel	12816	6	128.00	81
OM 460.933	Diesel	12816	6	128.00	81
OM 460.934	Diesel	12816	6	128.00	81
OM 460.935	Diesel	12816	6	128.00	81
OM 460.936	Diesel	12816	6	128.00	81
OM 460.937	Diesel	12816	6	128.00	81
OM 460.938	Diesel	12816	6	128.00	81
OM 460.939	Diesel	12816	6	128.00	81
OM 460.940	Diesel	12816	6	128.00	81
OM 460.941	Diesel	12816	6	128.00	81
OM 460.942	Diesel	12816	6	128.00	81
OM 460.943	Diesel	12816	6	128.00	81
OM 460.944	Diesel	12816	6	128.00	81
OM 460.945	Diesel	12816	6	128.00	81
OM 460.946	Diesel	12816	6	128.00	81
OM 460.947	Diesel	12816	6	128.00	81
OM 460.948	Diesel	12816	6	128.00	81
OM 460.949	Diesel	12816	6	128.00	81
OM 460.961 (Euro 3)	Diesel	12816	6	128.00	81
OM 460.982 (Euro 3)	Diesel	12816	6	128.00	81
OM 460.983 (Euro 3)	Diesel	12816	6	128.00	81
OM 470.903 (Euro 6)	Diesel	10677	6	125.00	64
OM 470.904 (Euro 6)	Diesel	10677	6	125.00	64
OM 470.906 (Euro 6)	Diesel	10677	6	125.00	64
OM 470.908 (Euro 6)	Diesel	10677	6	125.00	64
OM 470.910 (Euro 6)	Diesel	10677	6	125.00	64
OM 470.913 (Euro 6)	Diesel	10677	6	125.00	64
OM 470.921 (Euro 6)	Diesel	10677	6	125.00	64
OM 470.923 (Euro 6)	Diesel	10677	6	125.00	64
OM 471.900 (Euro 6)	Diesel	12809	6	132.00	92
OM 471.902 (Euro 6)	Diesel	12809	6	132.00	92
OM 471.906 (Euro 6)	Diesel	12809	6	132.00	92
OM 471.909 (Euro 6)	Diesel	12809	6	132.00	92
OM 471.915 (Euro 6)	Diesel	12809	6	132.00	92
OM 471.919 (Euro 6)	Diesel	12809	6	132.00	92
OM 471.922 (Euro 6)	Diesel	12809	6	132.00	92
OM 471.926 (Euro 6)	Diesel	12809	6	132.00	92
OM 471.937 (Euro 6)	Diesel	12809	6	132.00	92
OM 471.944 (Euro 6)	Diesel	12809	6	132.00	92
OM 471.946 (Euro 6)	Diesel	12809	6	132.00	92
OM 475.950 (OM449 A)	Diesel	9973	5	128.00	65
OM 475.951 (OM449 A)	Diesel	9973	5	128.00	65
OM 475.952 (OM449 A)	Diesel	9973	5	128.00	65
OM 475.953 (OM449 A)	Diesel	9973	5	128.00	65
OM 475.954 (OM449 A)	Diesel	9973	5	128.00	65
OM 475.974 (OM449 LA)	Diesel	9973	5	128.00	65
OM 475.976 (OM449 LA)	Diesel	9973	5	128.00	65
OM 475.977 (OM449 LA)	Diesel	9973	5	128.00	65
OM 475.978 (OM449 LA)	Diesel	9973	5	128.00	65
OM 475.979 (OM449 LA)	Diesel	9973	5	128.00	65
OM 475.982 (OM449 LA)	Diesel	9973	5	128.00	65
OM 475.984 (OM449 LA)	Diesel	9973	5	128.00	65
OM 475.985 (OM449 LA)	Diesel	9973	5	128.00	65
OM 475.986 (OM449 LA)	Diesel	9973	5	128.00	65
OM 475.989 (OM449 LA)	Diesel	9973	5	128.00	65
OM 475.991 (OM449 LA)	Diesel	9973	5	128.00	65
OM 475.994 (OM449 LA)	Diesel	9973	5	128.00	65
OM 475.997 (OM449 LA)	Diesel	9973	5	128.00	65
OM 475.998 (OM449 LA)	Diesel	9973	5	128.00	65

ENGINE INDEX

Motorverzeichnis • Index de moteur • Índice de Motor
 Indeks silnika • Модель Двигателя • دليل المحرك

CCM

9

OM 476.916 (OM447 A)	Diesel	11967	6	128.00	65
OM 476.917 (OM447 LA)	Diesel	11967	6	128.00	65
OM 476.950 (OM447 A)	Diesel	11967	6	128.00	65
OM 476.971 (Euro 2 OM447 LA)	Diesel	11967	6	128.00	65
OM 476.972 (Euro 2 OM447 LA)	Diesel	11967	6	128.00	65
OM 476.973 (Euro 2 OM447 LA)	Diesel	11967	6	128.00	65
OM 476.977 (Euro 2 OM447 LA)	Diesel	11967	6	128.00	65
OM 476.978 (Euro 2 OM447 LA)	Diesel	11967	6	128.00	65
OM 476.979 (Euro 2 OM447 LA)	Diesel	11967	6	128.00	65
OM 476.980 (Euro 2 OM447 LA)	Diesel	11967	6	128.00	65
OM 476.981 (OM447 LA)	Diesel	11967	6	128.00	65
OM 476.982 (OM447 LA)	Diesel	11967	6	128.00	65
OM 476.983 (Euro 2 OM447 LA)	Diesel	11967	6	128.00	65
OM 476.985 (Euro 1 OM447 LA)	Diesel	11967	6	128.00	65
OM 476.988 (OM447 LA)	Diesel	11967	6	128.00	65
OM 476.991 (OM447 LA)	Diesel	11967	6	128.00	65
OM 476.992 (OM447 LA)	Diesel	11967	6	128.00	65
OM 481.902	Diesel	10964	V6	128.00	71
OM 481.904	Diesel	10964	V6	128.00	71
OM 482.912	Diesel	14618	V8	128.00	71
OM 482.930	Diesel	14618	V8	128.00	71
OM 482.940	Diesel	14618	V8	128.00	71
OM 482.941	Diesel	14618	V8	128.00	71
OM 485.980	Diesel	9973	5	128.00	65
OM 489.960 (Euro 1)	Diesel	9973	5	128.00	65
OM 489.961 (Euro 1)	Diesel	9973	5	128.00	65
OM 521.940 (Euro 2 OM501 LA)	Diesel	11946	V6	130.00	87
OM 521.950 (Euro 2 OM501 LA)	Diesel	11946	V6	130.00	87
OM 521.951 (Euro 2 OM501 LA)	Diesel	11946	V6	130.00	87
OM 522 LA (Euro 2)	Diesel	15928	V8	130.00	91
OM 522.940 (Euro 2 OM502 LA)	Diesel	15928	V8	130.00	87
OM 522.941 (Euro 2 OM502 LA)	Diesel	15928	V8	130.00	87
OM 522.942 (Euro 2 OM502 LA)	Diesel	15928	V8	130.00	87
OM 522.943 (Euro 2 OM502 LA)	Diesel	15928	V8	130.00	87
OM 522.950 (Euro 2 OM502 LA)	Diesel	15928	V8	130.00	87
OM 541.920 (Euro 2 OM501 LA)	Diesel	11946	V6	130.00	87
OM 541.921 (Euro 2 OM501 LA)	Diesel	11946	V6	130.00	87
OM 541.922 (Euro 2 OM501 LA)	Diesel	11946	V6	130.00	87
OM 541.923 (Euro 2 OM501 LA)	Diesel	11946	V6	130.00	87
OM 541.924 (Euro 2 OM501 LA)	Diesel	11946	V6	130.00	87
OM 541.925 (Euro 2 OM501 LA)	Diesel	11946	V6	130.00	87
OM 541.926 (Euro 2 OM501 LA)	Diesel	11946	V6	130.00	87
OM 541.927 (Euro 2 OM501 LA)	Diesel	11946	V6	130.00	87
OM 541.928 (Euro 2 OM501 LA)	Diesel	11946	V6	130.00	87
OM 541.940 (Euro 2/3 OM501 LA)	Diesel	11946	V6	130.00	87
OM 541.941 (Euro 2/3 OM501 LA)	Diesel	11946	V6	130.00	87
OM 541.942 (Euro 3 OM501 LA)	Diesel	11946	V6	130.00	88
OM 541.943 (Euro 3 OM501 LA)	Diesel	11946	V6	130.00	88
OM 541.944 (Euro 3 OM501 LA)	Diesel	11946	V6	130.00	88
OM 541.945 (Euro 3 OM501 LA)	Diesel	11946	V6	130.00	88
OM 541.946 (Euro 3 OM501 LA)	Diesel	11946	V6	130.00	88
OM 541.947 (Euro 3 OM501 LA)	Diesel	11946	V6	130.00	88
OM 541.948 (Euro 3 OM501 LA)	Diesel	11946	V6	130.00	88
OM 541.949 (Euro 3 OM501 LA)	Diesel	11946	V6	130.00	88
OM 541.950 (Euro 3 OM501 LA)	Diesel	11946	V6	130.00	88
OM 541.951 (Euro 2/3 OM501 LA)	Diesel	11946	V6	130.00	87
OM 541.952 (Euro 2/3 OM501 LA)	Diesel	11946	V6	130.00	87
OM 541.953 (Euro 4/5 OM501 LA)	Diesel	11946	V6	130.00	89
OM 541.959 (Euro 4/5 OM501 LA)	Diesel	11946	V6	130.00	89
OM 541.960 (Euro 2 OM501 LA)	Diesel	11946	V6	130.00	87



CCM

x



9

OM 541.970 (Euro 4 OM501 LA)	Diesel	11946	V6	130.00	89
OM 541.971 (Euro 4/5 OM501 LA)	Diesel	11946	V6	130.00	89
OM 541.972 (Euro 4 OM501 LA)	Diesel	11946	V6	130.00	89
OM 541.973 (Euro 4 OM501 LA)	Diesel	11946	V6	130.00	89
OM 541.974 (Euro 4 OM501 LA)	Diesel	11946	V6	130.00	89
OM 541.975 (Euro 4 OM501 LA)	Diesel	11946	V6	130.00	89
OM 541.976 (Euro 4 OM501 LA)	Diesel	11946	V6	130.00	89
OM 541.977 (Euro 4 OM501 LA)	Diesel	11946	V6	130.00	89
OM 541.978 (Euro 4 OM501 LA)	Diesel	11946	V6	130.00	89
OM 541.979 (Euro 4/5 OM501 LA)	Diesel	11946	V6	130.00	89
OM 541.980 (Euro 4 OM501 LA)	Diesel	11946	V6	130.00	89
OM 541.981 (Euro 4 OM501 LA)	Diesel	11946	V6	130.00	89
OM 541.990 (Euro 5 OM501 LA)	Diesel	11946	V6	130.00	89
OM 541.991 (OM501 LA)	Diesel	11946	V6	130.00	90
OM 541.992 (Euro 5 OM501 LA)	Diesel	11946	V6	130.00	89
OM 541.994 (Euro 5 OM501 LA)	Diesel	11946	V6	130.00	89
OM 541.995 (OM501 LA)	Diesel	11946	V6	130.00	88
OM 541.996 (Euro 5 OM501 LA)	Diesel	11946	V6	130.00	89
OM 541.997 (OM501 LA)	Diesel	11946	V6	130.00	89
OM 541.998 (Euro 5 OM501 LA)	Diesel	11946	V6	130.00	89
OM 541.999 (OM501 LA)	Diesel	11946	V6	130.00	89
OM 542.920 (OM502 LA)	Diesel	15928	V8	130.00	87
OM 542.921 (OM502 LA)	Diesel	15928	V8	130.00	87
OM 542.922 (OM502 LA)	Diesel	15928	V8	130.00	87
OM 542.923 (OM502 LA)	Diesel	15928	V8	130.00	87
OM 542.924 (OM502 LA)	Diesel	15928	V8	130.00	87
OM 542.925 (Euro 2 OM502 LA)	Diesel	15928	V8	130.00	87
OM 542.926 (OM502 LA)	Diesel	15928	V8	130.00	87
OM 542.940 (Euro 3 OM502 LA)	Diesel	15928	V8	130.00	88
OM 542.941 (Euro 3 OM502 LA)	Diesel	15928	V8	130.00	88
OM 542.942 (Euro 3 OM502 LA)	Diesel	15928	V8	130.00	88
OM 542.943 (Euro 3 OM502 LA)	Diesel	15928	V8	130.00	88
OM 542.944 (Euro 3 OM502 LA)	Diesel	15928	V8	130.00	88
OM 542.945 (Euro 3 OM502 LA)	Diesel	15928	V8	130.00	88
OM 542.947 (OM502 LA)	Diesel	15928	V8	130.00	87
OM 542.948 (Euro 3 OM502 LA)	Diesel	15928	V8	130.00	88
OM 542.956 (Euro 3 OM502 LA)	Diesel	15928	V8	130.00	88
OM 542.957 (Euro 3 OM502 LA)	Diesel	15928	V8	130.00	88
OM 542.958 (Euro 3 OM502 LA)	Diesel	15928	V8	130.00	87
OM 542.960 (Euro 5)	Diesel	15928	V8	130.00	89
OM 542.961 (Euro 5)	Diesel	15928	V8	130.00	89
OM 542.962 (Euro 5 OM502 LA)	Diesel	15928	V8	130.00	89
OM 542.963 (Euro 5 OM502 LA)	Diesel	15928	V8	130.00	89
OM 542.964 (Euro 5)	Diesel	15928	V8	130.00	89
OM 542.965	Diesel	15928	V8	130.00	89
OM 542.966 (Euro 5)	Diesel	15928	V8	130.00	89
OM 542.970 (Euro 5)	Diesel	15928	V8	130.00	89
OM 542.971 (Euro 5)	Diesel	15928	V8	130.00	89
OM 542.972 (Euro 5)	Diesel	15928	V8	130.00	89
OM 601A.970	Diesel	2299	4	89.00	33
OM 601.900 (Euro 2)	Diesel	2299	4	89.00	32
OM 601.911	Diesel	1997	4	87.00	15
OM 601.912	Diesel	1997	4	87.00	15
OM 601.913	Diesel	1997	4	87.00	15
OM 601.915	Diesel	1997	4	87.00	15
OM 601.940	Diesel	2299	4	89.00	32
OM 601.941	Diesel	2299	4	89.00	32
OM 601.942	Diesel	2299	4	89.00	32
OM 601.943	Diesel	2299	4	89.00	32
OM 602A.962	Diesel	2497	5	87.00	18

ENGINE INDEX

Motorverzeichnis • Index de moteur • Índice de Motor
 Indeks silnika • Модель Двигателя • دليل المحرك

CCM
x

9

OM 602A.993	Diesel	2497	5	87.00	18
OM 602.911	Diesel	2497	5	87.00	15
OM 602.912	Diesel	2497	5	87.00	15
OM 602.930	Diesel	2497	5	87.00	15
OM 602.931	Diesel	2497	5	87.00	15
OM 602.938	Diesel	2497	5	87.00	15
OM 602.939	Diesel	2497	5	87.00	15
OM 602.940	Diesel	2874	5	89.00	32
OM 602.941	Diesel	2874	5	89.00	32
OM 602.942	Diesel	2874	5	89.00	32
OM 602.946	Diesel	2874	5	89.00	32
OM 602.947	Diesel	2874	5	89.00	32
OM 602.948	Diesel	2874	5	89.00	32
OM 602.961	Diesel	2497	5	87.00	18
OM 602.980	Diesel	2874	5	89.00	35
OM 602.981 (Euro 2)	Diesel	2874	5	89.00	35
OM 602.982 (OM 602 DE 29 LA)	Diesel	2874	5	89.00	35
OM 602.983 (OM 602 DE 29 LA)	Diesel	2874	5	89.00	35
OM 602.984	Diesel	2874	5	89.00	35
OM 602.985	Diesel	2874	5	89.00	35
OM 602.986	Diesel	2874	5	89.00	35
OM 602.989 (Euro 2)	Diesel	2874	5	89.00	35
OM 602.990	Diesel	2497	5	87.00	15
OM 602.991	Diesel	2874	5	89.00	32
OM 602.994	Diesel	2874	5	89.00	32
OM 602.995	Diesel	2874	5	89.00	32
OM 603A.960 (OM 603 D 30 A)	Diesel	2996	6	87.00	18
OM 603A.963 (OM 603 D 30 A)	Diesel	2996	6	87.00	18
OM 603A.970 (OM 603 D 35 A)	Diesel	3449	6	89.00	33
OM 603A.971 (OM 603 D 35 A)	Diesel	3449	6	89.00	33
OM 603A.972 (OM 603 D 35 A)	Diesel	3449	6	89.00	33
OM 603.912 (OM 603 D 30)	Diesel	2996	6	87.00	15
OM 603.913 (OM 603 D 30)	Diesel	2996	6	87.00	15
OM 603.931 (OM 603 D 30)	Diesel	2996	6	87.00	15
OM 603.950 (OM 603 D 30 A)	Diesel	2996	6	87.00	19
OM 603.961 (OM 603 D 30 A)	Diesel	2996	6	87.00	18
OM 603.962 (OM 603 D 30 A)	Diesel	2996	6	87.00	19
OM 604.910	Diesel	2155	4	89.00	34
OM 604.912	Diesel	2155	4	89.00	34
OM 604.915	Diesel	1997	4	87.00	16
OM 604.917	Diesel	1997	4	87.00	16
OM 605.910	Diesel	2497	5	87.00	16
OM 605.911	Diesel	2497	5	87.00	16
OM 605.912	Diesel	2497	5	87.00	16
OM 605.960	Diesel	2497	5	87.00	19
OM 605.962	Diesel	2497	5	87.00	19
OM 606.910	Diesel	2996	6	87.00	16
OM 606.912	Diesel	2996	6	87.00	16
OM 606.961	Diesel	2996	6	87.00	19
OM 606.962	Diesel	2996	6	87.00	19
OM 606.964	Diesel	2996	6	87.00	19
OM 611A (60 KW CDI)	Diesel	2151	4	88.00	25
OM 611LA (75 KW CDI)	Diesel	2151	4	88.00	22
OM 611.960	Diesel	2151	4	88.00	21
OM 611.961	Diesel	2151	4	88.00	22
OM 611.962	Diesel	2151	4	88.00	23
OM 611.980 (Euro 3)	Diesel	2151	4	88.00	22
OM 611.981 (Euro 3)	Diesel	2151	4	88.00	23
OM 611.987 (Euro 3)	Diesel	2151	4	88.00	24
OM 612.961	Diesel	2685	5	88.00	24



CCM



9

OM 612.962	Diesel	2685	5	88.00	24
OM 612.963	Diesel	2685	5	88.00	23
OM 612.965	Diesel	2685	5	88.00	24
OM 612.966	Diesel	2685	5	88.00	24
OM 612.967	Diesel	2685	5	88.00	24
OM 612.981	Diesel	2685	5	88.00	24
OM 612.983 (Euro 3)	Diesel	2685	5	88.00	24
OM 613.960	Diesel	3222	6	88.00	23
OM 613.961	Diesel	3226	6	88.00	23
OM 615	Diesel	2197	4	87.00	17
OM 615.910	Diesel	2197	4	87.00	17
OM 615.911	Diesel	2197	4	87.00	17
OM 615.912 (OM 615 D 22)	Diesel	2197	4	87.00	17
OM 615.913 (OM 615 D 20)	Diesel	1988	4	87.00	17
OM 615.914	Diesel	2197	4	87.00	17
OM 615.915 (OM 615 D 20)	Diesel	1988	4	87.00	17
OM 615.916	Diesel	2197	4	87.00	17
OM 615.917 (OM 615 D 22)	Diesel	2197	4	87.00	17
OM 615.918	Diesel	2197	4	87.00	17
OM 615.919	Diesel	2197	4	87.00	17
OM 615.930	Diesel	2197	4	87.00	17
OM 615.932	Diesel	2197	4	87.00	17
OM 615.936	Diesel	2197	4	87.00	17
OM 615.937	Diesel	2197	4	87.00	17
OM 615.938	Diesel	2197	4	87.00	17
OM 615.939	Diesel	2197	4	87.00	17
OM 615.940 (OM 615 D 20)	Diesel	1988	4	87.00	17
OM 615.941 (OM 615 D 22)	Diesel	2197	4	87.00	17
OM 615.942	Diesel	1988	4	87.00	17
OM 615.943	Diesel	1988	4	87.00	17
OM 615.944	Diesel	1988	4	87.00	17
OM 615.961	Diesel	1988	4	87.00	17
OM 615.963	Diesel	1988	4	87.00	17
OM 615.964	Diesel	1988	4	87.00	17
OM 615.965	Diesel	1988	4	87.00	17
OM 615.966	Diesel	1988	4	87.00	17
OM 615.967	Diesel	1988	4	87.00	17
OM 615.968	Diesel	1988	4	87.00	17
OM 615.969	Diesel	1988	4	87.00	17
OM 615.970	Diesel	1988	4	87.00	17
OM 616	Diesel	2399	4	90.90	42
OM 616.910	Diesel	2399	4	90.90	42
OM 616.911	Diesel	2404	4	90.90	43
OM 616.912 (OM 616 D 24)	Diesel	2399	4	90.90	42
OM 616.913	Diesel	2399	4	90.90	42
OM 616.914	Diesel	2404	4	90.90	42
OM 616.916 (OM 616 D 24)	Diesel	2404	4	90.90	43
OM 616.917	Diesel	2399	4	90.90	42
OM 616.918	Diesel	2399	4	90.90	42
OM 616.919	Diesel	2399	4	90.90	43
OM 616.930	Diesel	2399	4	90.90	42
OM 616.932	Diesel	2404	4	90.90	43
OM 616.933	Diesel	2404	4	90.90	43
OM 616.934	Diesel	2404	4	90.90	42
OM 616.936 (OM 616 D 24)	Diesel	2399	4	90.90	42
OM 616.937	Diesel	2399	4	90.90	42
OM 616.938 (OM 616 D 24)	Diesel	2399	4	90.90	42
OM 616.939	Diesel	2399	4	90.90	42
OM 616.940	Diesel	2399	4	90.90	42
OM 616.942	Diesel	2404	4	90.90	42

ENGINE INDEX

Motorverzeichnis • Index de moteur • Índice de Motor
 Indeks silnika • Модель Двигателя • دليل المحرك



CCM



9

OM 616.943	Diesel	2404	4	90.90	42
OM 616.944	Diesel	2399	4	90.90	43
OM 616.960	Diesel	2399	4	90.90	43
OM 616.961	Diesel	2404	4	90.90	43
OM 616.962	Diesel	2404	4	90.90	42
OM 616.963	Diesel	2399	4	90.90	42
OM 617.910 (OM 617 D30)	Diesel	3005	5	90.90	43
OM 617.912 (OM 617 D30)	Diesel	3005	5	90.90	42
OM 617.913	Diesel	2998	5	90.90	42
OM 617.919	Diesel	3005	5	90.90	42
OM 617.931 (OM 617 D30)	Diesel	2998	5	90.90	42
OM 617.932 (OM 617 D30)	Diesel	2998	5	90.90	42
OM 617.933 (OM 617 D30)	Diesel	2998	5	90.90	43
OM 617.950 (OM 617 D30 A)	Diesel	2998	5	90.90	43
OM 617.951 (OM 617 D30 A)	Diesel	2998	5	90.90	43
OM 617.952 (OM 617 D30 A)	Diesel	2998	5	90.90	43
OM 621.912	Diesel	1990	4	87.00	17
OM 621.913	Diesel	1990	4	87.00	17
OM 621.914	Diesel	1988	4	87.00	17
OM 621.915	Diesel	1988	4	87.00	17
OM 621.916	Diesel	1988	4	87.00	17
OM 621.918	Diesel	1988	4	87.00	17
OM 621.919	Diesel	1988	4	87.00	17
OM 621.930	Diesel	1988	4	87.00	17
OM 621.932	Diesel	1990	4	87.00	17
OM 622.951 (R9M)	Diesel	1598	4	80.00	3
OM 639.939 (Euro 4)	Diesel	1493	3	83.00	7
OM 640.940	Diesel	1991	4	83.00	7
OM 640.941	Diesel	1991	4	83.00	7
OM 640.942	Diesel	1991	4	83.00	7
OM 642.820	Diesel	2987	V6	83.00	10
OM 642.830	Diesel	2987	V6	83.00	10
OM 642.832	Diesel	2987	V6	83.00	10
OM 642.836	Diesel	2987	V6	83.00	10
OM 642.838	Diesel	2987	V6	83.00	11
OM 642.850	Diesel	2987	V6	83.00	10
OM 642.853	Diesel	2987	V6	83.00	11
OM 642.854	Diesel	2987	V6	83.00	11
OM 642.856	Diesel	2987	V6	83.00	10
OM 642.858	Diesel	2987	V6	83.00	11
OM 642.862	Diesel	2987	V6	83.00	11
OM 642.868	Diesel	2987	V6	83.00	11
OM 642.870	Diesel	2987	V6	83.00	10
OM 642.872	Diesel	2987	V6	83.00	11
OM 642.884	Diesel	2987	V6	83.00	12
OM 642.896	Diesel	2987	V6	83.00	12
OM 642.898	Diesel	2987	V6	83.00	12
OM 642.899	Diesel	2987	V6	83.00	12
OM 642.910	Diesel	2987	V6	83.00	13
OM 642.920	Diesel	2987	V6	83.00	13
OM 642.921	Diesel	2987	V6	83.00	13
OM 642.930	Diesel	2987	V6	83.00	13
OM 642.932	Diesel	2987	V6	83.00	13
OM 642.940	Diesel	2987	V6	83.00	13
OM 642.950	Diesel	2987	V6	83.00	13
OM 642.960	Diesel	2987	V6	83.00	13
OM 642.961	Diesel	2987	V6	83.00	13
OM 642.970	Diesel	2987	V6	83.00	13
OM 642.975	Diesel	2987	V6	83.00	13
OM 642.990	Diesel	2987	V6	83.00	13



CCM

x



9

OM 642.992	Diesel	2987	V6	83.00	13
OM 642.993	Diesel	2987	V6	83.00	13
OM 646.811	Diesel	2148	4	88.00	26
OM 646.812	Diesel	2148	4	88.00	26
OM 646.820	Diesel	2148	4	88.00	26
OM 646.821	Diesel	2148	4	88.00	26
OM 646.951	Diesel	2148	4	88.00	27
OM 646.961	Diesel	2148	4	88.00	27
OM 646.962	Diesel	2148	4	88.00	27
OM 646.963	Diesel	2148	4	88.00	27
OM 646.966	Diesel	2148	4	88.00	27
OM 646.980	Diesel	2148	4	88.00	27
OM 646.981	Diesel	2148	4	88.00	27
OM 646.982 (Euro 4)	Diesel	2148	4	88.00	27
OM 646.983	Diesel	2148	4	88.00	27
OM 646.984	Diesel	2148	4	88.00	27
OM 646.985	Diesel	2148	4	88.00	27
OM 646.986 (Euro 4)	Diesel	2148	4	88.00	28
OM 646.989	Diesel	2148	4	88.00	27
OM 646.990	Diesel	2148	4	88.00	27
OM 647.961	Diesel	2685	5	88.00	27
OM 647.981	Diesel	2685	5	88.00	27
OM 648.960	Diesel	3222	6	88.00	27
OM 648.961	Diesel	3222	6	88.00	27
OM 651.911	Diesel	2143	4	83.00	8
OM 651.912	Diesel	2143	4	83.00	8
OM 651.913	Diesel	2143	4	83.00	9
OM 651.916	Diesel	2143	4	83.00	9
OM 651.924	Diesel	2143	4	83.00	8
OM 651.925	Diesel	2143	4	83.00	9
OM 651.930	Diesel	2143	4	83.00	9
OM 651.940	Diesel	2143	4	83.00	9
OM 651.950	Diesel	2143	4	83.00	9
OM 651.955 (Euro 5/6)	Diesel	2143	4	83.00	9
OM 651.956	Diesel	2143	4	83.00	9
OM 651.957	Diesel	2143	4	83.00	9
OM 651.960	Diesel	2143	4	83.00	8
OM 651.961	Diesel	2143	4	83.00	8
OM 651.980	Diesel	2143	4	83.00	8
OM 660.950	Diesel	799	3	65.50	2
OM 661.911	Diesel	2299	4	89.00	32
OM 661.940	Diesel	2299	4	89.00	32
OM 662.911 (OM 662 D 29)	Diesel	2874	5	89.00	32
OM 900.911 (Euro 4 OM904 LA)	Diesel	4249	4	102.00	53
OM 900.912 (Euro 4 OM904 LA)	Diesel	4249	4	102.00	53
OM 900.913 (Euro 4 OM904 LA)	Diesel	4249	4	102.00	53
OM 900.915 (Euro 4 OM904 LA)	Diesel	4249	4	102.00	53
OM 900.916 (Euro 4 OM904 LA)	Diesel	4249	4	102.00	53
OM 900.917 (Euro 4 OM904 LA)	Diesel	4249	4	102.00	53
OM 900.918 (Euro 4 OM904 LA)	Diesel	4249	4	102.00	53
OM 900.919 (Euro 4 OM904 LA)	Diesel	4249	4	102.00	53
OM 900.920 (Euro 4 OM904 LA)	Diesel	4249	4	102.00	53
OM 900.921 (Euro 4 OM904 LA)	Diesel	4249	4	102.00	53
OM 900.922 (Euro 4 OM904 LA)	Diesel	4249	4	102.00	53
OM 902.910 (Euro 4 OM906 LA)	Diesel	6374	6	102.00	53
OM 902.911 (Euro 4 OM906 LA)	Diesel	6374	6	102.00	53
OM 902.912 (Euro 4 OM906 LA)	Diesel	6374	6	102.00	54
OM 902.913 (Euro 4 OM906 LA)	Diesel	6374	6	102.00	53
OM 902.914 (Euro 4 OM906 LA)	Diesel	6374	6	102.00	53
OM 902.915 (Euro 4 OM906 LA)	Diesel	6374	6	102.00	53

ENGINE INDEX

Motorverzeichnis • Index de moteur • Índice de Motor
 Indeks silnika • Модель Двигателя • دليل المحرك



CCM



9

OM 902.916 (Euro 4 OM906 LA)	Diesel	6374	6	102.00	53
OM 902.917 (Euro 4 OM906 LA)	Diesel	6374	6	102.00	53
OM 902.918 (Euro 4 OM906 LA)	Diesel	6374	6	102.00	53
OM 902.919 (Euro 4 OM906 LA)	Diesel	6374	6	102.00	53
OM 902.920 (Euro 4 OM906 LA)	Diesel	6374	6	102.00	53
OM 902.921 (Euro 4 OM906 LA)	Diesel	6374	6	102.00	53
OM 902.922 (Euro 4 OM906 LA)	Diesel	6374	6	102.00	53
OM 902.923 (Euro 4 OM906 LA)	Diesel	6374	6	102.00	53
OM 902.924 (Euro 4 OM906 LA)	Diesel	6374	6	102.00	53
OM 902.925 (Euro 4 OM906 LA)	Diesel	6374	6	102.00	53
OM 902.926 (Euro 4 OM906 hLA)	Diesel	6374	6	102.00	53
OM 902.927 (Euro 4 OM906 LA)	Diesel	6374	6	102.00	53
OM 902.930 (Euro 4 OM906 LA)	Diesel	6374	6	102.00	53
OM 902.931 (Euro 4 OM906 LA)	Diesel	6374	6	102.00	53
OM 902.932 (Euro 4 OM906 LA)	Diesel	6374	6	102.00	53
OM 902.933 (Euro 4 OM906 LA)	Diesel	6374	6	102.00	53
OM 902.934 (Euro 4 OM906 hLA)	Diesel	6374	6	102.00	53
OM 902.936 (Euro 4 OM906 LA)	Diesel	6374	6	102.00	53
OM 904.903 (Euro 2)	Diesel	4250	4	102.00	54
OM 904.904 (Euro 2)	Diesel	4250	4	102.00	54
OM 904.905 (Euro 2)	Diesel	4249	4	102.00	54
OM 904.906 (Euro 2)	Diesel	4249	4	102.00	54
OM 904.907 (Euro 2)	Diesel	4249	4	102.00	54
OM 904.908 (Euro 2)	Diesel	4250	4	102.00	54
OM 904.909 (Euro 2)	Diesel	4249	4	102.00	54
OM 904.910 (Euro 2)	Diesel	4249	4	102.00	54
OM 904.911 (Euro 2)	Diesel	4249	4	102.00	54
OM 904.912 (Euro 2)	Diesel	4249	4	102.00	54
OM 904.914 (Euro 2)	Diesel	4249	4	102.00	54
OM 904.915 (Euro 2)	Diesel	4249	4	102.00	54
OM 904.916 (Euro 2)	Diesel	4249	4	102.00	54
OM 904.917 (Euro 2)	Diesel	4249	4	102.00	54
OM 904.918 (Euro 2)	Diesel	4249	4	102.00	54
OM 904.919 (Euro 2)	Diesel	4249	4	102.00	54
OM 904.920 (Euro 2)	Diesel	4249	4	102.00	54
OM 904.921 (Euro 2)	Diesel	4249	4	102.00	54
OM 904.922 (Euro 2)	Diesel	4249	4	102.00	54
OM 904.923 (Euro 2)	Diesel	4250	4	102.00	54
OM 904.924 (Euro 2)	Diesel	4249	4	102.00	54
OM 904.925 (Euro 2)	Diesel	4249	4	102.00	54
OM 904.926 (Euro 2)	Diesel	4249	4	102.00	54
OM 904.927 (Euro 3)	Diesel	4249	4	102.00	54
OM 904.928 (Euro 3)	Diesel	4249	4	102.00	54
OM 904.929 (Euro 2)	Diesel	4249	4	102.00	54
OM 904.930 (Euro 2)	Diesel	4249	4	102.00	54
OM 904.931 (Euro 2)	Diesel	4249	4	102.00	54
OM 904.932 (Euro 2)	Diesel	4249	4	102.00	54
OM 904.933 (Euro 2)	Diesel	4249	4	102.00	54
OM 904.934 (Euro 2)	Diesel	4249	4	102.00	54
OM 904.935 (Euro 2)	Diesel	4249	4	102.00	54
OM 904.936 (Euro 3)	Diesel	4250	4	102.00	54
OM 904.937 (Euro 2)	Diesel	4249	4	102.00	54
OM 904.938 (Euro 2)	Diesel	4249	4	102.00	54
OM 904.939 (Euro 2)	Diesel	4249	4	102.00	54
OM 904.940 (Euro 2)	Diesel	4249	4	102.00	54
OM 904.941 (Euro 2)	Diesel	4249	4	102.00	54
OM 904.942 (Euro 3)	Diesel	4249	4	102.00	54
OM 904.943 (Euro 2)	Diesel	4249	4	102.00	54
OM 904.944 (Euro 2)	Diesel	4249	4	102.00	54
OM 904.945 (Euro 2)	Diesel	4249	4	102.00	54



CCM



9

OM 904.946 (Euro 2)	Diesel	4249	4	102.00	54
OM 904.947 (Euro 3)	Diesel	4249	4	102.00	54
OM 904.948 (Euro 2)	Diesel	4249	4	102.00	54
OM 904.949 (Euro 2)	Diesel	4249	4	102.00	54
OM 904.950 (Euro 2)	Diesel	4249	4	102.00	54
OM 904.951 (Euro 3)	Diesel	4249	4	102.00	54
OM 904.952 (Euro 3)	Diesel	4249	4	102.00	54
OM 904.953 (Euro 3)	Diesel	4249	4	102.00	54
OM 904.954 (Euro 2)	Diesel	4249	4	102.00	54
OM 904.955 (Euro 3)	Diesel	4250	4	102.00	54
OM 904.956 (Euro 2)	Diesel	4249	4	102.00	54
OM 904.957 (Euro 3)	Diesel	4249	4	102.00	54
OM 904.959 (Euro 2)	Diesel	4249	4	102.00	54
OM 904.961 (Euro 3)	Diesel	4250	4	102.00	54
OM 904.962 (Euro 3)	Diesel	4249	4	102.00	54
OM 904.964 (Euro 3)	Diesel	4249	4	102.00	55
OM 904.965 (Euro 3)	Diesel	4249	4	102.00	54
OM 904.966 (Euro 3)	Diesel	4249	4	102.00	54
OM 904.967 (Euro 3)	Diesel	4249	4	102.00	54
OM 904.968 (Euro 3)	Diesel	4249	4	102.00	54
OM 904.970 (Euro 3)	Diesel	4249	4	102.00	54
OM 904.972 (Euro 3)	Diesel	4249	4	102.00	54
OM 904.973 (Euro 3)	Diesel	4249	4	102.00	55
OM 904.974 (Euro 2)	Diesel	4249	4	102.00	54
OM 904.975 (Euro 3)	Diesel	4249	4	102.00	55
OM 904.976 (Euro 3)	Diesel	4249	4	102.00	55
OM 904.977	Diesel	4249	4	102.00	55
OM 904.978	Diesel	4249	4	102.00	55
OM 904.979	Diesel	4249	4	102.00	55
OM 904.980	Diesel	4249	4	102.00	55
OM 904.981	Diesel	4249	4	102.00	55
OM 906.910 (Euro 2)	Diesel	6374	6	102.00	54
OM 906.911 (Euro 2)	Diesel	6374	6	102.00	54
OM 906.912 (Euro 2)	Diesel	6374	6	102.00	54
OM 906.913 (Euro 2)	Diesel	6374	6	102.00	54
OM 906.914 (Euro 2)	Diesel	6374	6	102.00	54
OM 906.915 (Euro 2)	Diesel	6374	6	102.00	54
OM 906.916 (Euro 2)	Diesel	6374	6	102.00	54
OM 906.917 (Euro 2)	Diesel	6374	6	102.00	54
OM 906.918 (Euro 2)	Diesel	6374	6	102.00	54
OM 906.919 (Euro 2)	Diesel	6374	6	102.00	54
OM 906.920 (Euro 2)	Diesel	6374	6	102.00	54
OM 906.921 (Euro 2)	Diesel	6374	6	102.00	54
OM 906.922 (Euro 2)	Diesel	6374	6	102.00	54
OM 906.923 (Euro 2)	Diesel	6374	6	102.00	54
OM 906.924 (Euro 2)	Diesel	6374	6	102.00	54
OM 906.925 (Euro 3)	Diesel	6374	6	102.00	55
OM 906.926 (Euro 3)	Diesel	6374	6	102.00	55
OM 906.927 (Euro 3)	Diesel	6374	6	102.00	55
OM 906.928 (Euro 3)	Diesel	6374	6	102.00	55
OM 906.929 (Euro 2)	Diesel	6374	6	102.00	54
OM 906.930 (Euro 2)	Diesel	6374	6	102.00	54
OM 906.931 (Euro 2)	Diesel	6374	6	102.00	54
OM 906.932 (Euro 2)	Diesel	6374	6	102.00	54
OM 906.933 (Euro 2)	Diesel	6374	6	102.00	54
OM 906.934 (Euro 2)	Diesel	6374	6	102.00	54
OM 906.935 (Euro 3)	Diesel	6374	6	102.00	55
OM 906.936 (Euro 2)	Diesel	6374	6	102.00	54
OM 906.937 (Euro 2)	Diesel	6374	6	102.00	54
OM 906.938 (Euro 3)	Diesel	6374	6	102.00	54

ENGINE INDEX

Motorverzeichnis • Index de moteur • Índice de Motor
 Indeks silnika • Модель Двигателя • دليل المحرك

CCM

9

OM 906.939 (Euro 3)	Diesel	6374	6	102.00	55
OM 906.940 (Euro 2)	Diesel	6374	6	102.00	54
OM 906.941 (Euro 2)	Diesel	6374	6	102.00	54
OM 906.944 (Euro 2)	Diesel	6374	6	102.00	54
OM 906.945 (Euro 2)	Diesel	6374	6	102.00	54
OM 906.946 (Euro 2)	Diesel	6374	6	102.00	54
OM 906.947 (Euro 2)	Diesel	6374	6	102.00	54
OM 906.948 (Euro 2)	Diesel	6374	6	102.00	54
OM 906.949 (Euro 3)	Diesel	6374	6	102.00	55
OM 906.950 (Euro 3)	Diesel	6374	6	102.00	55
OM 906.951	Diesel	6374	6	102.00	55
OM 906.952 (Euro 3)	Diesel	6374	6	102.00	54
OM 906.953 (Euro 3)	Diesel	6374	6	102.00	54
OM 906.954 (Euro 2)	Diesel	6374	6	102.00	54
OM 906.955 (Euro 3)	Diesel	6374	6	102.00	54
OM 906.956 (Euro 2)	Diesel	6374	6	102.00	54
OM 906.957 (Euro 2)	Diesel	6374	6	102.00	54
OM 906.958 (Euro 2)	Diesel	6374	6	102.00	54
OM 906.959 (Euro 2)	Diesel	6374	6	102.00	54
OM 906.960 (Euro 3)	Diesel	6374	6	102.00	55
OM 906.961 (Euro 3)	Diesel	6374	6	102.00	54
OM 906.962 (Euro 3)	Diesel	6374	6	102.00	55
OM 906.963 (Euro 3)	Diesel	6374	6	102.00	55
OM 906.964	Diesel	6374	6	102.00	55
OM 906.965	Diesel	6374	6	102.00	54
OM 906.966 (Euro 2)	Diesel	6374	6	102.00	54
OM 906.967 (Euro 2)	Diesel	6374	6	102.00	54
OM 906.968 (Euro 2)	Diesel	6374	6	102.00	54
OM 906.970 (Euro 2)	Diesel	6374	6	102.00	54
OM 906.971	Diesel	6374	6	102.00	54
OM 906.973 (Euro 3)	Diesel	6374	6	102.00	55
OM 906.974 (Euro 2)	Diesel	6374	6	102.00	54
OM 906.975 (Euro 2)	Diesel	6374	6	102.00	54
OM 906.976 (Euro 2)	Diesel	6374	6	102.00	54
OM 906.977 (Euro 2)	Diesel	6374	6	102.00	54
OM 906.978 (Euro 2)	Diesel	6374	6	102.00	54
OM 906.979 (Euro 2)	Diesel	6374	6	102.00	54
OM 906.980 (Euro 2)	Diesel	6374	6	102.00	54
OM 906.981 (Euro 2)	Diesel	6374	6	102.00	54
OM 906.982	Diesel	6374	6	102.00	55
OM 906.983 (Euro 3)	Diesel	6374	6	102.00	55
OM 906.985 (Euro 3)	Diesel	6374	6	102.00	54
OM 906.986 (Euro 3)	Diesel	6374	6	102.00	54
OM 906.988 (Euro 3)	Diesel	6374	6	102.00	54
OM 906.991 (Euro 3)	Diesel	6374	6	102.00	55
OM 906.992 (Euro 3)	Diesel	6374	6	102.00	55
OM 906.993 (Euro 3)	Diesel	6374	6	102.00	55
OM 906.995 (Euro 3)	Diesel	6374	6	102.00	54
OM 906.998 (Euro 3)	Diesel	6374	6	102.00	55
OM 907.910 (Euro 2 OM904 LA)	Diesel	4250	4	102.00	54
OM 907.920 (Euro 2 OM904 LA)	Diesel	4250	4	102.00	54
OM 907.930 (Euro 2 OM904 LA)	Diesel	4249	4	102.00	54
OM 907.940 (Euro 2 OM904 LA)	Diesel	4250	4	102.00	54
OM 907.941 (Euro 2 OM904 LA)	Diesel	4249	4	102.00	54
OM 907.960 (Euro 2 OM904 LA)	Diesel	4250	4	102.00	54
OM 907.970 (Euro 2 OM904 LA)	Diesel	4250	4	102.00	54
OM 907.980 (Euro 2 OM904 LA)	Diesel	4249	4	102.00	54
OM 907.990 (Euro 2 OM904 LA)	Diesel	4250	4	102.00	54
OM 909.900 (OM906 hLA)	Diesel	6374	6	102.00	54
OM 909.901 (OM906 hLA)	Diesel	6374	6	102.00	54



CCM



9

OM 909.910 (OM906 LA)	Diesel	6374	6	102.00	54
OM 909.911 (OM906 LA)	Diesel	6374	6	102.00	54
OM 909.920 (OM906 LA)	Diesel	6374	6	102.00	54
OM 909.921 (OM906 LA)	Diesel	6374	6	102.00	54
OM 909.960 (OM906 LA)	Diesel	6374	6	102.00	54
OM 909.970 (OM906 LA)	Diesel	6374	6	102.00	54
OM 909.971 (OM906 LA)	Diesel	6374	6	102.00	54
OM 924.913 (Euro 3)	Diesel	4801	4	106.00	56
OM 924.915 (Euro 3)	Diesel	4801	4	106.00	56
OM 924.916 (Euro 3)	Diesel	4801	4	106.00	56
OM 924.919 (Euro 3)	Diesel	4801	4	106.00	56
OM 924.920 (Euro 3)	Diesel	4801	4	106.00	56
OM 924.924 (Euro 3)	Diesel	4801	4	106.00	56
OM 924.928	Diesel	4801	4	106.00	56
OM 924.932 (Euro 5)	Diesel	4801	4	106.00	56
OM 926.913 (Euro 3)	Diesel	7201	6	106.00	56
OM 926.914 (Euro 2)	Diesel	7201	6	106.00	56
OM 926.915 (Euro 3)	Diesel	7201	6	106.00	56
OM 926.917 (Euro 3)	Diesel	7201	6	106.00	56
OM 926.921 (Euro 3)	Diesel	7201	6	106.00	56
OM 926.924 (Euro 3)	Diesel	7201	6	106.00	56
OM 926.926 (Euro 3)	Diesel	7201	6	106.00	56
OM 926.929 (Euro 3)	Diesel	7201	6	106.00	56
OM 926.930 (Euro 3)	Diesel	7201	6	106.00	56
OM 926.932 (Euro 3)	Diesel	7201	6	106.00	56
OM 926.933 (Euro 3)	Diesel	7201	6	106.00	56
OM 926.935 (Euro 3)	Diesel	7201	6	106.00	56
OM 926.938 (Euro 3)	Diesel	7201	6	106.00	56
OM 926.940	Diesel	7201	6	106.00	56
OM 926.941 (Euro 4)	Diesel	7201	6	106.00	56
OM 926.968	Diesel	7201	6	106.00	56
OM 926.969	Diesel	7201	6	106.00	56
OM 933.911 (Euro 6 OM934 LA)	Diesel	5132	4	110.00	57
OM 933.911-913,915,916 (OM 934 LA)	Diesel	5132	4	110.00	57
OM 933.912 (Euro 6 OM934 LA)	Diesel	5132	4	110.00	57
OM 933.913 (Euro 6 OM934 LA)	Diesel	5132	4	110.00	57
OM 933.915 (Euro 6 OM934 LA)	Diesel	5132	4	110.00	57
OM 933.916 (Euro 6 OM934 LA)	Diesel	5132	4	110.00	57
OM 933.951 (Euro 6 OM934 LA)	Diesel	5132	4	110.00	58
OM 933.951,952 (OM 934 LA)	Diesel	5132	4	110.00	58
OM 933.952 (Euro 6 OM934 LA)	Diesel	5132	4	110.00	58
OM 934.911 (Euro 6)	Diesel	5132	4	110.00	58
OM 934.912	Diesel	5132	4	110.00	57
OM 934.912 (Euro 6)	Diesel	5132	4	110.00	57
OM 934.913 (Euro 6)	Diesel	5132	4	110.00	58
OM 934.971 (Euro 6)	Diesel	5132	4	110.00	58
OM 934.972 (Euro 6)	Diesel	5132	4	110.00	58
OM 934.974 (Euro 6)	Diesel	5132	4	110.00	57
OM 934.976 (Euro 6)	Diesel	5132	4	110.00	57
OM 934.976,978	Diesel	5132	4	110.00	57
OM 934.978 (Euro 6)	Diesel	5132	4	110.00	57
OM 935.911 (Euro 6 OM936)	Diesel	7698	6	110.00	58
OM 935.911-914,951-954 (OM 936 LA)	Diesel	5132	4	110.00	58
OM 935.912 (Euro 6 OM936)	Diesel	7698	6	110.00	58
OM 935.913 (Euro 6 OM936)	Diesel	7698	6	110.00	58
OM 935.914 (Euro 6 OM936)	Diesel	7698	6	110.00	58
OM 935.951 (Euro 6 OM936)	Diesel	7698	6	110.00	58
OM 935.952 (Euro 6 OM936)	Diesel	7698	6	110.00	58
OM 935.953 (Euro 6 OM936)	Diesel	7698	6	110.00	58
OM 935.954 (Euro 6 OM936)	Diesel	7698	6	110.00	58

ENGINE INDEX

Motorverzeichnis • Index de moteur • Índice de Motor
 Indeks silnika • Модель Двигателя • دليل المحرك

CCM
x

9

OM 936.910	Diesel	5132	4	110.00	58
OM 936.910 (Euro 6)	Diesel	7698	6	110.00	58
OM 936.912 (Euro 6)	Diesel	7698	6	110.00	58
OM 936.915 (Euro 6)	Diesel	7698	6	110.00	58
OM 936.916 (Euro 6)	Diesel	7698	6	110.00	58
OM 936.919 (Euro 6)	Diesel	7698	6	110.00	58
OM 936.919,923	Diesel	5132	4	110.00	58
OM 936.923 (Euro 6)	Diesel	7698	6	110.00	58
OM 936.971 (Euro 6)	Diesel	7698	6	110.00	58
OM 936.972 (Euro 6)	Diesel	7698	6	110.00	58
OM 936.973 (Euro 6)	Diesel	7698	6	110.00	58
OM 936.975	Diesel	5132	4	110.00	58
OM 936.975 (Euro 6)	Diesel	7698	6	110.00	58
OM 936.977	Diesel	5132	4	110.00	58
OM 936.977 (Euro 6)	Diesel	7698	6	110.00	58
OM 936.980 (Euro 6)	Diesel	7698	6	110.00	58
OM 941.910 (Euro 2 OM501 LA)	Diesel	11946	V6	130.00	87
OM 941.920 (Euro 2 OM501 LA)	Diesel	11946	V6	130.00	87
OM 941.921 (Euro 2 OM501 LA)	Diesel	11946	V6	130.00	87
OM 941.929 (Euro 2 OM501 LA)	Diesel	11946	V6	130.00	87
OM 941.930 (Euro 2 OM501 LA)	Diesel	11946	V6	130.00	87
OM 941.940 (Euro 2 OM501 LA)	Diesel	11946	V6	130.00	87
OM 941.960 (Euro 2 OM501 LA)	Diesel	11946	V6	130.00	87
OM 941.970 (Euro 2 OM501 LA)	Diesel	11946	V6	130.00	87
OM 941.980 (Euro 2 OM501 LA)	Diesel	11946	V6	130.00	87
OM 941.981 (Euro 2 OM501 LA)	Diesel	11946	V6	130.00	87
OM 941.990 (Euro 2 OM501 LA)	Diesel	11946	V6	130.00	87
OM 941.991 (OM501 LA)	Diesel	11946	V6	130.00	90
OM 942.900 (Euro 2 OM502 LA)	Diesel	15928	V8	130.00	87
OM 942.910 (Euro 2 OM502 LA)	Diesel	15928	V8	130.00	87
OM 942.911 (Euro 2 OM502 LA)	Diesel	15928	V8	130.00	87
OM 942.912 (Euro 2 OM502 LA)	Diesel	15928	V8	130.00	87
OM 942.925 (Euro 2 OM502 LA)	Diesel	15928	V8	130.00	87
OM 942.930 (Euro 2 OM502 LA)	Diesel	15928	V8	130.00	87
OM 942.960 (Euro 2 OM502 LA)	Diesel	15928	V8	130.00	87
OM 942.967 (Euro 2 OM502 LA)	Diesel	15928	V8	130.00	87
OM 942.970 (Euro 2 OM502 LA)	Diesel	15928	V8	130.00	87
OM 942.980 (Euro 2 OM502 LA)	Diesel	15928	V8	130.00	87
OM 942.990 (Euro 2 OM502 LA)	Diesel	15928	V8	130.00	87
OM 424.901.510	Diesel	21927	V12	128.00	69



63.50

1

M 160 B03 (SMART)	3cyl.	599cc	40kW (55PS)	Petrol	Turbo Intercooled	TD9520
M 160 B04 (SMART)	3cyl.	599cc	33kW (45PS)	Petrol	Turbo Intercooled	TD16490
M 160 B05 (SMART)	3cyl.	599cc	45kW (61PS)	Petrol	Turbo Intercooled	TD16491

SMART 600 07/98→

87-136700-00 *STD*

87-136705-00 *0.25mm*

87-136707-00 *0.50mm*

08-136700-00 *STD*

08-136705-00 *0.25mm*

08-136707-00 *0.50mm*

A 27.00

B- 2.75

BØ 50.00

D 43.50

16x48



1.20 CR

1.50 P

2.50 CR

Steel

Stahl

Acier

Acero

Acciaio

65.50

2

OM 660.950	3cyl.	799cc	33kW (45PS)	Diesel	Turbo Intercooled	TD23765
-------------------	-------	--------------	--------------------	---------------	--------------------------	----------------

FORTWO 800 CDI 04/07→

87-140600-00 *STD*

08-140600-00 *STD*

A 36.00

B- 11.10

BØ 38.70

C 0.95

C 0.95

D 60.00

23x53

RT



1.50 CK P

1.50 P

2.50 CR P

80.00

3

OM 622.951 (R9M)	4cyl.	1598cc	65-84kW (88-114PS)	Diesel	Turbo Intercooled	TD29598
-------------------------	-------	---------------	---------------------------	---------------	--------------------------	----------------

MARCO POLO Camper 160 CDI 03/15→ VITO 111 CDI 10/14→

MARCO POLO Camper 180 CDI 03/15→ VITO 111 CDI / 111 10/14→

VITO 109 CDI 10/14→ VITO Mixto 109 CDI 10/14→

VITO 109 CDI / 109 10/14→ VITO Mixto 111 CDI 10/14→

87-424900-00 *STD*

87-424907-00 *0.50mm*

08-424900-00 *STD*

08-424907-00 *0.50mm*

A 46.00

B- 12.35

BØ 46.50

C 0.30

D 70.50

30x60

AK KK RT TP



2.00 CK P

1.75 P

2.00 CR P

82.00

4

M 271.860	4cyl.	1796cc	135-150kW (184-204PS)	Petrol	Turbo Intercooled	TD23724
------------------	-------	---------------	------------------------------	---------------	--------------------------	----------------

M 271.861	4cyl.	1796cc	135-150kW (184-204PS)	Petrol	Turbo Intercooled	TD25100
------------------	-------	---------------	------------------------------	---------------	--------------------------	----------------

C-CLASS C 200 CGI 01/07→ E-CLASS E 250 CGI 01/09→12/16

C-CLASS C 250 06/11→ SLK 200 02/11→

C-CLASS C 250 CGI 07/09→08/14 SLK 250 02/11→





E-CLASS E 200 CGI 08/09→12/16

87-430600-00 STD

08-430600-00 STD

87-430607-00

08-430607-00

07/09→

A 30.00
B- 4.45
C 0.62
C 3.48
D 50.00
 20x56



1.20  NT
1.50  P
2.00  CR

Steel Stahl Acier Acero Acciaio

82.00 **5**

M 271.948	4cyl.	1796cc	141kW (192PS)	Petrol	Supercharged	TD17434
M 271.950	4cyl.	1796cc	120-135kW (163-184PS)	Petrol	Supercharged	TD20359
M 271.954	4cyl.	1796cc	135kW (184PS)	Petrol	Supercharged	TD21027
M 271.955	4cyl.	1796cc	135kW (184PS)	Petrol	Supercharged	TD20858
M 271.956	4cyl.	1796cc	135kW (184PS)	Petrol	Supercharged	TD22141
M 271.957	4cyl.	1796cc	120-135kW (163-184PS)	Petrol	Supercharged	TD23994
M 271.951	4cyl.	1796cc	115kW (156PS)	CNG		TD23995

C-CLASS C 200	01/07→08/14	SPRINTER 3,5-t 316	09/08→
C-CLASS C 230	05/02→05/08	SPRINTER 3,5-t 316 LGT	09/08→
CLC-CLASS CLC 200	05/08→06/11	SPRINTER 3,5-t 316 NGT	09/08→
CLK CLK 200	10/06→03/10	SPRINTER 3-t 216	09/08→
E-CLASS E 200	04/06→07/09	SPRINTER 5-t 516	09/08→
SLK 200	01/08→02/11	SPRINTER 5-t 516 NGT	09/08→

87-427600-10 STD

08-427600-10 STD

A 29.90
B- 4.61
BØ 71.20
C 1.00
C 4.00
D 50.90
 20x56



1.20  NT
1.50  P
2.50  NT

Steel Stahl Acier Acero Acciaio

83.00 **6**

M 274.920	4cyl.	1991cc	115-245kW (156-333PS)	Petrol	Turbo Intercooled	TD28178
C-CLASS C 200			12/13→08/18	GLC 250 CNG		06/15→04/19
C-CLASS C 250			03/14→05/18	GLC 300		07/15→
C-CLASS C 300			12/13→12/18	GLC 300 e		11/19→
C-CLASS C 300 e			07/19→	GLC 350 e		01/16→04/19
C-CLASS C 350 e			02/15→08/18	GLE GLE 350 e		06/20→
CLS CLS 260			01/15→12/17	GLK-CLASS 200		08/13→06/15
E-CLASS E 200			11/12→	GLK-CLASS 250		08/13→06/15
E-CLASS E 200 NGT			07/13→12/15	SLC 200		01/16→
E-CLASS E 250			11/12→	SLC 260		05/18→
E-CLASS E 300			07/16→	SLC 300		01/16→
E-CLASS E 300 e			11/18→	SLK 200		04/15→
E-CLASS E 350 e			07/16→	SLK 300		07/15→
GLC 200			06/16→	V-CLASS V 250		03/14→
GLC 250			06/15→04/19	VITO 2.0		09/15→





87-440500-00 STD ① ②

- A 33.80
- B- 7.20
- BØ 75.00
- C 1.78
- C 1.63
- D 51.10
-  20x54

(0830FA111)

KK



08-440500-00 STD ③

- 1.20  PVD NT ④
- 1.20  PVD P
- 2.00  PVD NT ④

- ① 3 piece steel oil ring
- ② Elastothermic ®
- ③ For Nüral OE piston
- ④ Steel

- ① 3-teiliger Stahlgöhring
- ③ Für OE-Kolben von Nüral
- ④ Stahl

- ① Anneau acier 3 pièces pour l'huile
- ③ Pour les pistones d'origine Nüral
- ④ Acier

- ① Segmento de aceite de 3 piezas de acero
- ③ Para pistones originales Nüral
- ④ Acero

- ① Segmento raschiaolio 3 pezzi in acciaio
- ③ Per pistoni Nüral OE
- ④ Acciaio

83.00

7

OM 639.939 (Euro 4)	3cyl.	1493cc	50-70kW (68-95PS)	Diesel	Turbo Intercooled	TD23799
OM 640.940	4cyl.	1991cc	80kW (109PS)	Diesel	Turbo Intercooled	TD18151
OM 640.941	4cyl.	1991cc	100-103kW (136-140PS)	Diesel	Turbo Intercooled	TD18152
OM 640.942	4cyl.	1991cc	60kW (82PS)	Diesel	Turbo Intercooled	TD18153

A-CLASS A 160 CDI	09/04→06/12	B-CLASS B 180 CDI	03/05→11/11
A-CLASS A 180 CDI	09/04→06/12	B-CLASS B 200 CDI	03/05→11/11
A-CLASS A 200 CDI	09/04→06/12		

87-427500-00 STD
87-427507-00 0.50mm

- A 45.65
- B- 14.65
- BØ 43.40
- C 1.18
- C 1.02
- D 71.65
-  30x66

(8340A401)

AK KK RT



08-427500-00 STD
08-427507-00 0.50mm

- 2.00  CK
- 2.00  P
- 2.00  CR P



83.00

8

OM 651.911	4cyl.	2143cc	120-150kW (163-204PS)	Diesel	Turbo Intercooled	TD23727
OM 651.912	4cyl.	2143cc	120-150kW (163-204PS)	Diesel	Turbo Intercooled	TD23754
OM 651.924	4cyl.	2143cc	120-150kW (163-204PS)	Diesel	Turbo Intercooled	TD23782
OM 651.960	4cyl.	2143cc	150-152kW (204-207PS)	Diesel	Turbo Intercooled	TD26549
OM 651.961	4cyl.	2143cc	150kW (204PS)	Diesel	Turbo Intercooled	TD25277
OM 651.980	4cyl.	2143cc	150kW (204PS)	Diesel	Turbo Intercooled	TD26369

C-CLASS C 220 CDI	10/08→	E-CLASS E 300	12/11→12/16
C-CLASS C 250 CDI	08/08→	GLE 250 d	04/15→10/18
CLS CLS 220	05/14→12/17	GLK-CLASS 220 CDI	12/08→06/15
CLS CLS 250	05/14→12/17	GLK-CLASS 250 CDI	09/09→06/15
CLS CLS 250 CDI	04/11→12/17	M-CLASS ML 250 CDI	06/11→12/15
E-CLASS E 220	05/14→12/16	S-CLASS S 250 CDI	01/11→12/13
E-CLASS E 220 CDI	01/09→12/16	SLC 250 d	01/16→10/17
E-CLASS E 250 CDI	01/09→12/16	SLK 250 CDI	01/12→





87-433400-10 STD ① ②
87-433407-10 0.50mm ① ②

A 48.50
B- 13.25
B- 4.00
BØ 49.40
C 1.55
D 75.50
 30x66



(08349F416)
AK KK NB RT TP

08-433400-00 STD
08-433405-00 0.25mm
08-433407-00 0.50mm

2.00  GDC P
 1.75  P
 2.00  CR P



① Bowl capacity 25.52cm³
 ② 125kW→

① Volumen der Kolbenmulde 25.52cm³

① Volume de la cavité du piston 25.52cm³

① Vol. cavidad pistón 25.52cm³

① Volume camera pistone 25.52cm³

83.00

9

OM 651.913	4cyl.	2143cc	88-105kW (120-143PS)	Diesel	Turbo Intercooled	TD24407
OM 651.916	4cyl.	2143cc	100-125kW (136-170PS)	Diesel	Turbo Intercooled	TD23755
OM 651.925	4cyl.	2143cc	100kW (136PS)	Diesel	Turbo Intercooled	TD23783
OM 651.930	4cyl.	2143cc	80-130kW (109-177PS)	Diesel	Turbo Intercooled	TD26817
OM 651.940	4cyl.	2143cc	70-120kW (95-163PS)	Diesel	Turbo Intercooled	TD25280
OM 651.950	4cyl.	2143cc	84-140kW (114-190PS)	Diesel	Turbo Intercooled	TD29251
OM 651.955 (Euro 5/6)	4cyl.	2143cc	70-120kW (95-163PS)	Diesel	Turbo Intercooled	TD24545
OM 651.956	4cyl.	2143cc	70-120kW (95-163PS)	Diesel	Turbo Intercooled	TD25279
OM 651.957	4cyl.	2143cc	85-120kW (116-163PS)	Diesel	Turbo Intercooled	TD24544

A-CLASS A 180 CDI	06/13→10/14	SPRINTER 3-t 216 CDI	06/06→
A-CLASS A 200 CDI	02/14→05/18	SPRINTER 4,6-t 411 CDI	04/16→
A-CLASS A 220 CDI	09/12→05/18	SPRINTER 4,6-t 413 CDI	06/06→
A-CLASS A 220 d	07/15→05/18	SPRINTER 4,6-t 414 CDI	05/16→
B-CLASS B 180 CDI	06/13→08/14	SPRINTER 4,6-t 415 CDI	06/06→
B-CLASS B 200 CDI	08/14→12/18	SPRINTER 4,6-t 416 CDI	03/09→
B-CLASS B 220 CDI	11/11→12/18	SPRINTER 4-t 411 CDI	02/18→
B-CLASS B 220 d	06/18→12/18	SPRINTER 4-t 414 CDI	02/18→
C-CLASS C 180 CDI	04/10→08/14	SPRINTER 5-t 510 CDI	03/09→
C-CLASS C 200 CDI	11/09→08/14	SPRINTER 5-t 511 CDI	05/16→
CLA CLA 200 CDI	07/14→03/19	SPRINTER 5-t 513 CDI	06/06→
CLA CLA 220 CDI	01/13→03/19	SPRINTER 5-t 514 CDI	05/16→
CLA CLA 220 d	07/18→03/19	SPRINTER 5-t 515 CDI	06/06→
E-CLASS E 200 CDI	01/09→12/16	SPRINTER 5-t 516 CDI	06/06→
GLA-CLASS GLA 200 CDI	12/13→	V-CLASS V 200 CDI	03/14→
GLA-CLASS GLA 220 CDI	12/13→	V-CLASS V 220 CDI	03/14→
GLA-CLASS GLA 220 d	07/15→	V-CLASS V 250	03/14→
GLK-CLASS 200 CDI	07/10→06/15	VIANO CDI 2.2	07/10→
GLK-CLASS 220 CDI	12/08→06/15	VITO 110 CDI	09/10→08/14
MARCO POLO Camper 200 CDI	03/15→	VITO 113 CDI	09/10→
MARCO POLO Camper 220 CDI	03/15→	VITO 114 CDI	10/14→
MARCO POLO Camper 250 CDI	03/15→	VITO 114 CDI / 114	10/14→
SPRINTER 3,5-t 310 CDI	03/09→	VITO 116 CDI	09/10→
SPRINTER 3,5-t 311 CDI	06/11→	VITO 116 CDI / 116	10/14→
SPRINTER 3,5-t 313 CDI	06/06→	VITO 119 CDI	10/14→
SPRINTER 3,5-t 314 CDI	05/16→	VITO 119 CDI / 119	10/14→
SPRINTER 3,5-t 315 CDI	06/13→	VITO / MIXTO 110 CDI	09/10→
SPRINTER 3,5-t 316 CDI	03/09→	VITO / MIXTO 113 CDI	09/10→
SPRINTER 3-t 210 CDI	03/09→	VITO Mixto 114 CDI	10/14→
SPRINTER 3-t 211 CDI	04/16→	VITO / MIXTO 116 CDI	09/10→
SPRINTER 3-t 213 CDI	06/06→	VITO Mixto 116 CDI	10/14→
SPRINTER 3-t 214 CDI	04/16→	VITO Mixto 119	10/14→





87-433400-00 STD ①
87-433405-00 0.25mm ①
87-433407-00 0.50mm ①

A 48.50
B- 13.25
BØ 49.40
D 75.50
 30x66



(08349P202)
AK KK RT

08-433400-00 STD
08-433405-00 0.25mm
08-433407-00 0.50mm

2.00  GDC P
 1.75  P
 2.00  CR P



① →120kW

83.00							10
OM 642.820	V6cyl.	2987cc	150-170kW	(204-231PS)	Diesel	Turbo Intercooled	TD23810
OM 642.830	V6cyl.	2987cc	165-170kW	(224-231PS)	Diesel	Turbo Intercooled	TD23772
OM 642.832	V6cyl.	2987cc	150-170kW	(204-231PS)	Diesel	Turbo Intercooled	TD23751
OM 642.836	V6cyl.	2987cc	170kW	(231PS)	Diesel	Turbo Intercooled	TD23723
OM 642.850	V6cyl.	2987cc	150-170kW	(204-231PS)	Diesel	Turbo Intercooled	TD23781
OM 642.856	V6cyl.	2987cc	170kW	(231PS)	Diesel	Turbo Intercooled	TD23790
OM 642.870	V6cyl.	2987cc	140-157kW	(190-214PS)	Diesel	Turbo Intercooled	TD24810
C-CLASS C 300 CDI			01/11→08/14		M-CLASS ML 300 CDI		02/10→12/11
C-CLASS C 350 CDI			08/07→08/14		M-CLASS ML 320 CDI		07/05→07/11
E-CLASS E 300 CDI			11/09→12/16		M-CLASS ML 350 CDI		09/09→12/11
E-CLASS E 350			01/09→12/15		R-CLASS R 280 CDI		05/06→12/12
E-CLASS E 350 CDI			01/09→12/15		R-CLASS R 300 CDI		07/09→12/12
GL-CLASS GL 320 CDI / 350			12/09→08/12		R-CLASS R 320 CDI		01/06→12/12
GL-CLASS GL 350 CDI			09/09→12/10		R-CLASS R 350 CDI		01/06→12/14
GLK-CLASS 350 CDI			07/09→06/15				

87-427400-80 STD ① ②

A 45.65
B- 15.51
BØ 51.10
C 1.43
C 1.07
D 71.65
 30x66



(08370-106)
AK KK RT TP

08-427400-00 STD
08-427407-00 0.50mm

2.00  CK P
 2.00  P
 2.00  CR P



87-427400-90 STD ① ③

A 45.65
B- 15.51
BØ 51.10
C 1.43
C 1.07
D 71.65
 30x66



(08370-206)
AK KK RT TP

08-427400-00 STD
08-427407-00 0.50mm

2.00  CK P
 2.00  P
 2.00  CR P



① Euro 5
 ② To cylinder 1-2-3
 ③ To cylinder 4-5-6

② an Zylinder 1-2-3
 ③ an Zylinder 4-5-6

② sur cylindre 1-2-3
 ③ sur cylindre 4-5-6

② en el cilindro 1-2-3
 ③ en el cilindro 4-5-6

② a cilindro 1-2-3
 ③ a cilindro 4-5-6



83.00							11
OM 642.838	V6cyl.	2987cc	185-195kW	(252-265PS)	Diesel	Turbo Intercooled	TD26599
OM 642.853	V6cyl.	2987cc	185-195kW	(252-265PS)	Diesel	Turbo Intercooled	TD26065
OM 642.854	V6cyl.	2987cc	185-195kW	(252-265PS)	Diesel	Turbo Intercooled	TD26045
OM 642.858	V6cyl.	2987cc	185-195kW	(252-265PS)	Diesel	Turbo Intercooled	TD23791
OM 642.862	V6cyl.	2987cc	190kW	(258PS)	Diesel	Turbo Intercooled	TD26082
OM 642.868	V6cyl.	2987cc	190kW	(258PS)	Diesel	Turbo Intercooled	TD25099
OM 642.872	V6cyl.	2987cc	140-195kW	(190-265PS)	Diesel	Turbo Intercooled	TD25098
CLS CLS 350			02/13→12/17		R-CLASS R 280 CDI		05/06→12/12
CLS CLS 350 CDI			01/11→08/14		R-CLASS R 300 CDI		07/09→12/12
CLS CLS 350 d			04/15→12/17		R-CLASS R 350 CDI		08/10→12/14
E-CLASS E 350			11/12→12/16		S-CLASS S 350		04/11→12/13
E-CLASS E 350 CDI			03/11→12/15		S-CLASS S 350 BlueTec		04/11→12/13

87-427400-20 STD ①

- A 45.65
- B- 15.51
- BØ 47.10
- C 1.49
- C 1.33
- D 71.65
- 30x65
- (8370B110)



AK KK NB RT TP

08-427400-00 STD

08-427407-00 0.50mm

- 2.00 CK P
- 2.00 P
- 2.00 CR P



DuraBowl™

87-427400-30 STD ②

- A 45.65
- B- 15.51
- BØ 47.10
- C 1.49
- C 1.33
- D 71.65
- 30x65
- (8370B210)



AK KK NB RT TP

08-427400-00 STD

08-427407-00 0.50mm

- 2.00 CK P
- 2.00 P
- 2.00 CR P

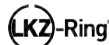

DuraBowl™

① To cylinder 1 - 3
② To cylinder 4 - 6

① an Zylinder 1-3
② an Zylinder 4-6

① sur cylindre 1-3
② sur cylindre 4-6

① en el cilindro 1-3
② en el cilindro 4-6

① a cilindro 1-3
② a cilindro 4-6

83.00							12
OM 642.884	V6cyl.	2987cc	135kW	(184PS)	Diesel	Turbo Intercooled	TD25842
OM 642.896	V6cyl.	2987cc	135-140kW	(184-190PS)	Diesel	Turbo Intercooled	TD25841
OM 642.898	V6cyl.	2987cc	140-155kW	(190-211PS)	Diesel	Turbo Intercooled	TD25843
OM 642.899	V6cyl.	2987cc	140kW	(190PS)	Diesel	Turbo Intercooled	TD35872
G-CLASS G 280 CDI			04/09→		SPRINTER 4,6-t 418 CDI		06/06→05/16
G-CLASS G 300 CDI			04/10→		SPRINTER 4,6-t 419 CDI		03/09→
SPRINTER 3,5-t 318 CDI			06/06→12/09		SPRINTER 4-t 419 CDI		02/18→
SPRINTER 3,5-t 319 CDI			03/09→		SPRINTER 4-t 419 CDI RWD		02/18→
SPRINTER 3,5-t 319 CDI RWD			02/18→		SPRINTER 5-t 518 CDI		06/06→12/09
SPRINTER 3-t 218 CDI			06/06→		SPRINTER 5-t 519 CDI		03/09→
SPRINTER 3-t 219 CDI			03/09→				





87-427400-60 STD ①

A 45.65
B- 14.65
BØ 43.40
C 1.33
C 1.49
D 71.65
30x66



(8370-301)
AK KK RT TP

08-427400-00 STD
08-427407-00 0.50mm

2.00 CK P
2.00 P
2.00 CR P

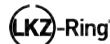

87-427400-70 STD ②

A 45.65
B- 14.65
BØ 43.40
C 1.33
C 1.49
D 71.65
30x66



(8370-401)
AK KK RT TP

08-427400-00 STD
08-427407-00 0.50mm

2.00 CK P
2.00 P
2.00 CR P



① To cylinder 1-3
② To cylinder 4-6

① an Zylinder 1-3
② an Zylinder 4-6

① sur cylindre 1-3
② sur cylindre 4-6

① en el cilindro 1-3
② en el cilindro 4-6

① a cilindro 1-3
② a cilindro 4-6

83.00

13













OM 642.910	V6cyl.	2987cc	165kW (224PS)	Diesel	Turbo Intercooled	TD18416
OM 642.920	V6cyl.	2987cc	140-200kW (190-272PS)	Diesel	Turbo Intercooled	TD18431
OM 642.921	V6cyl.	2987cc	140-165kW (190-224PS)	Diesel	Turbo Intercooled	TD18428
OM 642.930	V6cyl.	2987cc	155-173kW (211-235PS)	Diesel	Turbo Intercooled	TD19213
OM 642.932	V6cyl.	2987cc	155-173kW (211-235PS)	Diesel	Turbo Intercooled	TD23761
OM 642.940	V6cyl.	2987cc	140-170kW (190-231PS)	Diesel	Turbo Intercooled	TD18197
OM 642.950	V6cyl.	2987cc	140-165kW (190-224PS)	Diesel	Turbo Intercooled	TD19206
OM 642.960	V6cyl.	2987cc	165kW (224PS)	Diesel	Turbo Intercooled	TD20361
OM 642.961	V6cyl.	2987cc	165kW (224PS)	Diesel	Turbo Intercooled	TD20986
OM 642.970	V6cyl.	2987cc	165kW (224PS)	Diesel	Turbo Intercooled	TD20729
OM 642.975	V6cyl.	2987cc	135kW (184PS)	Diesel	Turbo Intercooled	TD28790
OM 642.990	V6cyl.	2987cc	150-165kW (204-224PS)	Diesel	Turbo Intercooled	TD22148
OM 642.992	V6cyl.	2987cc	135-140kW (184-190PS)	Diesel	Turbo Intercooled	TD22149
OM 642.993	V6cyl.	2987cc	135kW (184PS)	Diesel	Turbo Intercooled	TD25661

C-CLASS C 320 CDI	01/05→08/14	M-CLASS ML 320 CDI	07/05→07/11
C-CLASS C 350 CDI	08/07→01/14	M-CLASS ML 350 CDI	07/09→02/15
CLK CLK 320 CDI	01/05→03/10	R-CLASS R 280 CDI	05/06→12/12
CLS CLS 320 CDI	01/05→12/10	R-CLASS R 300 CDI	07/09→12/12
CLS CLS 350 CDI	04/09→12/10	R-CLASS R 320 CDI	01/06→12/12
E-CLASS E 280 CDI	03/05→07/09	R-CLASS R 350 CDI	01/06→12/14
E-CLASS E 280 T CDI	03/05→07/09	S-CLASS S 320 CDI	10/05→12/13
E-CLASS E 300	09/07→12/08	S-CLASS S 350 CDI	01/09→12/13
E-CLASS E 320	09/08→03/09	SPRINTER 3,5-t 318 CDI	06/06→12/09
E-CLASS E 320 CDI	03/05→12/08	SPRINTER 3,5-t 319 CDI	03/09→
E-CLASS E320 CDI	09/06→12/08	SPRINTER 3-t 218 CDI	06/06→
E-CLASS E 320 T CDI	03/05→07/09	SPRINTER 3-t 219 CDI	03/09→
G-CLASS G 280 CDI	04/09→	SPRINTER 4,6-t 418 CDI	06/06→05/16
G-CLASS G 320 CDI	09/06→	SPRINTER 4,6-t 419 CDI	03/09→





G-CLASS G 350 CDI	06/09→12/11	SPRINTER 5-t 518 CDI	06/06→12/09
GL-CLASS GL 320 CDI	09/06→12/09	SPRINTER 5-t 519 CDI	03/09→
GL-CLASS GL 350 CDI	05/09→08/12	VIANO CDI 3.0	03/06→
GLK-CLASS 320 CDI	06/08→06/15	VITO 120 CDI	07/06→
M-CLASS ML 280 CDI	07/05→07/09	VITO / MIXTO 120 CDI	07/06→
M-CLASS ML 300 CDI	07/09→12/11		

<p>87-427400-00 STD ①</p> <p>87-427407-00 0.50mm ①</p> <p>A 45.65</p> <p>B- 14.65</p> <p>BØ 43.40</p> <p>C 1.49</p> <p>C 1.33</p> <p>D 71.65</p> <p> 30x65</p> <p>(08340F111)</p> <p>AK KK RT</p> 	<p>08-427400-00 STD</p> <p>08-427407-00 0.50mm</p> <p>2.00  CK P</p> <p>2.00  P</p> <p>2.00  CR P</p> <p></p>		
<p>87-427400-10 STD ②</p> <p>87-427407-10 0.50mm ②</p> <p>A 45.65</p> <p>B- 14.65</p> <p>BØ 43.40</p> <p>C 1.49</p> <p>C 1.33</p> <p>D 71.65</p> <p> 30x65</p> <p>(08340F211)</p> <p>AK KK RT</p> 	<p>08-427400-00 STD</p> <p>08-427407-00 0.50mm</p> <p>2.00  CK P</p> <p>2.00  P</p> <p>2.00  CR P</p> <p></p>		

① To cylinder 1 - 3
② To cylinder 4 - 6

① an Zylinder 1-3
② an Zylinder 4-6

① sur cylindre 1-3
② sur cylindre 4-6

① en el cilindro 1-3
② en el cilindro 4-6

① a cilindro 1-3
② a cilindro 4-6

 86.00					14
M 110.921	6cyl.	2746cc	118kW (160PS)	Petrol	TD2115
M 110.922	6cyl.	2746cc	115-118kW (156-160PS)	Petrol	TD2116
M 110.923	6cyl.	2746cc	115kW (156PS)	Petrol	TD2117
M 110.924	6cyl.	2746cc	115kW (156PS)	Petrol	TD2118
M 110.926	6cyl.	2746cc	115kW (156PS)	Petrol	TD2119
M 110.981	6cyl.	2746cc	136kW (185PS)	Petrol	TD2120
M 110.982	6cyl.	2746cc	130-136kW (177-185PS)	Petrol	TD2121
M 110.983	6cyl.	2746cc	130-136kW (177-185PS)	Petrol	TD2122
M 110.984	6cyl.	2746cc	105-136kW (185PS)	Petrol	TD4659
M 110.985	6cyl.	2746cc	101-136kW (137-185PS)	Petrol	TD2124
M 110.986	6cyl.	2746cc	130-136kW (177-185PS)	Petrol	TD2125
M 110.987	6cyl.	2746cc	136kW (185PS)	Petrol	TD2126
M 110.988	6cyl.	2746cc	130-136kW (177-185PS)	Petrol	TD2127
M 110.989	6cyl.	2746cc	136kW (185PS)	Petrol	TD2128
M 110.990	6cyl.	2746cc	130-136kW (177-185PS)	Petrol	TD2129
/8 280			06/72→11/76	123 280 E	02/76→11/85
/8 280 C			06/72→02/77	123 280 TE	09/77→11/85
/8 280 CE			06/72→01/77	S-CLASS 280 S	08/72→07/85
/8 280 E			06/72→11/76	S-CLASS 280 SE, SEL	08/72→07/85
123 280			02/76→08/81	SL 280 SL	08/74→07/85





123 280 C	03/77→12/80	SL 280 SLC	08/74→09/81
123 280 CE	03/77→11/85		

87-176600-00 STD
87-176607-00 0.50mm
87-176611-00 1.00mm

08-176600-00 STD
08-176607-00 0.50mm
08-176611-00 1.00mm

A 42.70
B+ 14.90
D 89.60
 23x69



1.75 MOL P
 2.50 P
 4.00 CR P

(08614A)

A = 41.900

87.00 **15**

OM 601.911	4cyl.	1997cc	53-55kW (72-75PS)	Diesel	TD2206
OM 601.912	4cyl.	1997cc	53-55kW (72-75PS)	Diesel	TD2207
OM 601.913	4cyl.	1997cc	55kW (75PS)	Diesel	TD2208
OM 601.915	4cyl.	1997cc	55kW (75PS)	Diesel	TD5237
OM 602.911	5cyl.	2497cc	66-69kW (90-94PS)	Diesel	TD2211
OM 602.912	5cyl.	2497cc	66-69kW (90-94PS)	Diesel	TD2212
OM 602.930	5cyl.	2497cc	62-69kW (84-94PS)	Diesel	TD2213
OM 602.931	5cyl.	2497cc	69kW (94PS)	Diesel	TD2214
OM 602.938	5cyl.	2497cc	68kW (92PS)	Diesel	TD17816
OM 602.939	5cyl.	2497cc	68kW (92PS)	Diesel	TD9422
OM 602.990	5cyl.	2497cc	63kW (86PS)	Diesel	TD17819
OM 603.912 (OM 603 D 30)	6cyl.	2996cc	80-83kW (109-113PS)	Diesel	TD2218
OM 603.913 (OM 603 D 30)	6cyl.	2996cc	80-83kW (109-113PS)	Diesel	TD2219
OM 603.931 (OM 603 D 30)	6cyl.	2996cc	83kW (113PS)	Diesel	TD2220

124 200 D	12/84→06/93	190 D 2.5	04/85→08/93
124 200 T D	09/85→08/91	C-CLASS C 200 D	03/93→05/00
124 250 D	04/85→06/93	E-CLASS E 200 D	06/93→06/95
124 250 T D	09/85→06/93	G-CLASS 250 GD	10/87→05/93
124 300 D	12/84→06/93	G-CLASS 300 GD	09/89→08/93
124 300 T D	09/86→06/93	G-CLASS G 300 Diesel	09/93→08/94
190 D 2.0	08/83→08/93	O 405	01/84→

87-743600-10 STD
87-743607-10 0.50mm

08-743600-00 STD
08-743607-00 0.50mm

14-026240-00 D

B 90.10 C 148.50 D 92.57 E 4.70

A 44.85
B- 9.05
C 1.25
C 1.05
D 74.85
 26x55



2.50 CR P
 2.00 P
 3.00 CR P

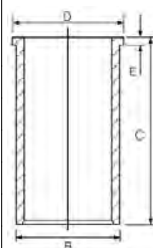

(08753B)

RT

Conrod guided in Piston
 Conrod gap 22.15mm

Kolbengeführtes Pleuel
 Pleuelaugenabstand 22.15mm

Bielle guidée dans le piston
 Distance entre bielle 22.15mm

Biela montada en el pistón
 Distancia del biela 22.15mm

Billea montata sul pistone
 Distanza dalla biella 22.15mm

87.00 **16**

OM 604.915	4cyl.	1997cc	65-85kW (88-116PS)	Diesel	TD4677
OM 604.917	4cyl.	1997cc	65kW (88PS)	Diesel	TD9424
OM 605.910	5cyl.	2497cc	83kW (113PS)	Diesel	TD2228





OM 605.911	5cyl.	2497cc	83kW (113PS)	Diesel	TD2229
OM 605.912	5cyl.	2497cc	83kW (113PS)	Diesel	TD4678
OM 606.910	6cyl.	2996cc	100kW (136PS)	Diesel	TD2230
OM 606.912	6cyl.	2996cc	100kW (136PS)	Diesel	TD4680
C-CLASS C 200 D			10/96→05/00	E-CLASS E 250 d	06/96→06/98
C-CLASS C 200 T D			10/96→03/01	E-CLASS E 250 TD	06/93→06/96
C-CLASS C 250 D			05/93→05/00	E-CLASS E 250 T D	06/96→07/99
E-CLASS E 200 D			01/96→03/02	E-CLASS E 300 D	07/93→06/97
E-CLASS E 250 D			07/93→07/99	E-CLASS E 300 TD	06/93→06/96

87-743600-30 STD
87-743607-30 0.50mm

- A 44.90
- B- 4.60
- B+ 1.32
- C 2.26
- C 2.41
- D 76.22
-  26x55



08-743600-00 STD
08-743607-00 0.50mm

- 2.50  CR P
- 2.00  P
- 3.00  CR P

14-026240-00 D **B 90.10 C 148.50 D 92.57 E 4.70**

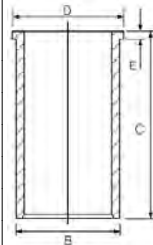

87.00

17

OM 615	4cyl.	2197cc	40-44kW (55-60PS)	Diesel	TD2231
OM 615.910	4cyl.	2197cc	44kW (60PS)	Diesel	TD2232
OM 615.911	4cyl.	2197cc	33kW (45PS)	Diesel	TD7970
OM 615.912 (OM 615 D 22)	4cyl.	2197cc	44kW (60PS)	Diesel	TD2233
OM 615.913 (OM 615 D 20)	4cyl.	1988cc	40kW (55PS)	Diesel	TD2234
OM 615.914	4cyl.	2197cc	40kW (55PS)	Diesel	TD7972
OM 615.915 (OM 615 D 20)	4cyl.	1988cc	40-44kW (54-60PS)	Diesel	TD17732
OM 615.916	4cyl.	2197cc	40kW (55PS)	Diesel	TD22823
OM 615.917 (OM 615 D 22)	4cyl.	2197cc	44kW (60PS)	Diesel	TD5683
OM 615.918	4cyl.	2197cc	40kW (55PS)	Diesel	TD22824
OM 615.919	4cyl.	2197cc	38-40kW (52-54PS)	Diesel	TD28785
OM 615.930	4cyl.	2197cc	38kW (52PS)	Diesel	TD22825
OM 615.932	4cyl.	2197cc	44kW (60PS)	Diesel	TD7989
OM 615.936	4cyl.	2197cc	37kW (50PS)	Diesel	TD20151
OM 615.937	4cyl.	2197cc	44kW (60PS)	Diesel	TD2236
OM 615.938	4cyl.	2197cc	44kW (60PS)	Diesel	TD22826
OM 615.939	4cyl.	2197cc	44kW (60PS)	Diesel	TD2237
OM 615.940 (OM 615 D 20)	4cyl.	1988cc	40-44kW (55-60PS)	Diesel	TD2238
OM 615.941 (OM 615 D 22)	4cyl.	2197cc	44-49kW (60-67PS)	Diesel	TD2239
OM 615.942	4cyl.	1988cc	40kW (54PS)	Diesel	TD22827
OM 615.943	4cyl.	1988cc	40kW (55PS)	Diesel	TD2240
OM 615.944	4cyl.	1988cc	40kW (55PS)	Diesel	TD2241
OM 615.961	4cyl.	1988cc	44kW (60PS)	Diesel	TD22829
OM 615.963	4cyl.	1988cc	43kW (58PS)	Diesel	TD2242
OM 615.964	4cyl.	1988cc	40kW (54PS)	Diesel	TD22830
OM 615.965	4cyl.	1988cc	40kW (54PS)	Diesel	TD22831
OM 615.966	4cyl.	1988cc	40kW (54PS)	Diesel	TD22832
OM 615.967	4cyl.	1988cc	40kW (54PS)	Diesel	TD22833
OM 615.968	4cyl.	1988cc	40kW (54PS)	Diesel	TD22834
OM 615.969	4cyl.	1988cc	40kW (54PS)	Diesel	TD22835





OM 615.970	4cyl.	1988cc	43-46kW (58-62PS)	Diesel	TD2243
OM 621.912	4cyl.	1990cc	40kW (54PS)	Diesel	TD2268
OM 621.913	4cyl.	1990cc	36-40kW (50-54PS)	Diesel	TD2269
OM 621.914	4cyl.	1988cc	35kW (48PS)	Diesel	TD2270
OM 621.915	4cyl.	1988cc	40kW (54PS)	Diesel	TD22837
OM 621.916	4cyl.	1988cc	25-29kW (34-39PS)	Diesel	TD7986
OM 621.918	4cyl.	1988cc	40kW (55PS)	Diesel	TD2271
OM 621.919	4cyl.	1988cc	40kW (54PS)	Diesel	TD22838
OM 621.930	4cyl.	1988cc	40kW (54PS)	Diesel	TD22839
OM 621.932	4cyl.	1990cc	40kW (55PS)	Diesel	TD2272

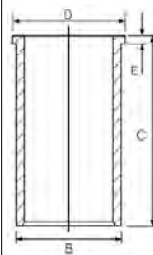

/8 200 D	01/68→01/77	HENSCHEL 2-t 206 D 2.2	02/73→12/77
/8 220 D	01/68→01/77	MB 2.0 D	04/88→04/96
123 200 D	07/76→11/85	O 309	01/68→12/74
123 220 D	01/76→03/79	T2/L L 405 D	01/72→12/80
HECKFLOSSE 190 DC	06/61→08/65	T2/L L 406 DG	01/68→12/74
HECKFLOSSE 200 D	07/65→02/68	UNIMOG	01/66→

14-022190-00 D B 90.00 C 158.40 D 92.00 E 4.70



87.00	18				
OM 602.961	5cyl.	2497cc	90-93kW (122-126PS)	Diesel Turbo	TD2216
OM 602A.962	5cyl.	2497cc	90-93kW (126PS)	Diesel Turbo	TD2217
OM 602A.993	5cyl.	2497cc	93kW (126PS)	Diesel	TD17821
OM 603.961 (OM 603 D 30 A)	6cyl.	2996cc	107-110kW (143-148PS)	Diesel Turbo	TD2222
OM 603A.960 (OM 603 D 30 A)	6cyl.	2996cc	100-108kW (136-147PS)	Diesel Turbo	TD2221
OM 603A.963 (OM 603 D 30 A)	6cyl.	2996cc	105-108kW (143-147PS)	Diesel Turbo	TD2223

124 250 TD Turbo	03/88→07/93	190 Turbo-D 2.5	02/88→08/93
124 250 Turbo-D	09/88→06/93	E-CLASS E 250 Turbo D	06/93→06/96
124 300 D	09/89→06/93	E-CLASS E 250 Turbo-D	06/93→06/95
124 300 TD T	06/92→05/93	E-CLASS E 300 T Turbo-D	06/93→06/96
124 300 T Turbo-D	09/86→06/93	E-CLASS E 300 Turbo-D	06/93→06/95
124 300 Turbo-D	09/86→06/93	S-CLASS 300 SDL	09/85→12/87



87-183300-00 STD 
87-183307-00 0.50mm 

A 44.85
B- 9.10
C 1.05
C 1.25
D 74.85
 28x70

(08762P)
HA KK RT



08-183300-00 STD
08-183307-00 0.50mm

2.50  PS P
 2.00  PS P
 3.00  CR P

14-026240-00 D B 90.10 C 148.50 D 92.57 E 4.70

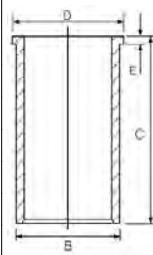

 Conrod guided in Piston

 Kolbengeführtes Pleuel

 Bielle guidée dans le piston

 Biela montada en el pistón

 Billea montata sul pistone

87.00	19				
OM 603.950 (OM 603 D 30 A)	6cyl.	2996cc	100-105kW (136-143PS)	Diesel Turbo	TD21143





OM 603.962 (OM 603 D 30 A)	6cyl.	2996cc	105kW (143PS)	Diesel	Turbo	TD21144
OM 605.960	5cyl.	2497cc	110kW (150PS)	Diesel	Turbo Intercooled	TD4679
OM 605.962	5cyl.	2497cc	110kW (150PS)	Diesel	Turbo Intercooled	TD9892
OM 606.961	6cyl.	2996cc	130kW (177PS)	Diesel	Turbo Intercooled	TD5238
OM 606.962	6cyl.	2996cc	130kW (177PS)	Diesel	Turbo Intercooled	TD9416
OM 606.964	6cyl.	2996cc	130kW (177PS)	Diesel	Turbo Intercooled	TD9425

C-CLASS C 250 T Turbo-D	06/96→03/01	E-CLASS E 300 T Turbo-D	12/96→07/99
C-CLASS C 250 Turbo-D	10/95→05/00	E-CLASS E 300 Turbo-D	12/96→07/99
E-CLASS E 250 T Turbo-D	06/97→07/99	G-CLASS G 300 TD	08/96→07/00
E-CLASS E 250 Turbo-D	06/97→07/99	S-CLASS S 300 Turbo-D	05/96→10/98

14-026240-00 D B 90.10 C 148.50 D 92.57 E 4.70

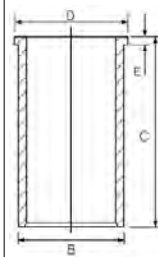

88.00 **20**

M 272.911	V6cyl.	2496cc	150kW (204PS)	Petrol	TD22142
M 272.920	V6cyl.	2496cc	150kW (204PS)	Petrol	TD18425
M 272.921	V6cyl.	2496cc	150kW (204PS)	Petrol	TD20357
M 272.922	V6cyl.	2496cc	150kW (204PS)	Petrol	TD22143
M 272.940	V6cyl.	2996cc	170kW (231PS)	Petrol	TD18420
M 272.941	V6cyl.	2996cc	170kW (231PS)	Petrol	TD18423
M 272.942	V6cyl.	2996cc	170kW (231PS)	Petrol	TD18427
M 272.943	V6cyl.	2996cc	170kW (231PS)	Petrol	TD18430
M 272.944	V6cyl.	2996cc	170kW (231PS)	Petrol	TD23758
M 272.945	V6cyl.	2996cc	170-180kW (231-245PS)	Petrol	TD20570
M 272.946	V6cyl.	2996cc	170-180kW (231-245PS)	Petrol	TD26966
M 272.947	V6cyl.	2996cc	170kW (231PS)	Petrol	TD20356
M 272.949	V6cyl.	2996cc	170kW (231PS)	Petrol	TD20863
M 272.952	V6cyl.	2996cc	161-170kW (219-231PS)	Petrol	TD25212

C-CLASS C 230	01/05→08/14	E-CLASS E 280 T	03/05→07/09
C-CLASS C 250	02/08→12/12	E-CLASS E 300	01/09→12/13
C-CLASS C 280	01/05→08/14	M-CLASS ML 300	03/10→12/11
C-CLASS C 300	08/07→08/14	R-CLASS R 280	01/07→12/14
CLC-CLASS CLC 230	05/08→06/11	R-CLASS R 300	07/09→12/14
CLC-CLASS CLC 250	06/09→06/11	S-CLASS S 280	08/06→12/13
CLK CLK 280	01/05→03/10	S-CLASS S 300	08/06→12/13
CLS CLS 280	07/08→12/10	SL 280	03/08→01/12
CLS CLS 300	04/09→12/10	SL 300	04/09→01/12
E-CLASS E 230	09/07→12/08	SLK 280	01/05→02/11
E-CLASS E 230 T	05/07→07/09	SLK 300	04/09→02/11
E-CLASS E 280	03/05→12/08		





87-440900-00 STD

A 30.85
B+ 4.41
C 1.39
C 1.39
D 56.16
 22x47
 (7.08861D104)



08-440900-00 STD

1.50  NT 
 1.75  P
 2.50  NT 

 Steel

 Stahl

 Acier

 Acero

 Acciaio

 **88.00**

21

OM 611.960	4cyl.	2151cc	75-92kW (102-125PS)	Diesel	Turbo Intercooled	TD9529
C-CLASS C 200 CDI			03/98→05/00	C-CLASS C 220 CDI		09/97→05/00
C-CLASS C 200 T CDI			03/98→03/01	C-CLASS C 220 T CDI		09/97→03/01

87-117900-10 STD

87-117907-10 0.50mm
 →12/99

A 42.30
B- 13.30
BØ 43.10
C 2.48
D 72.30
 28x68
 (08853-110)
AK KK RT



08-117900-00 STD

08-117907-00 0.50mm

2.50  CK P
 2.00  P
 3.00  CR P

14-020300-00 D

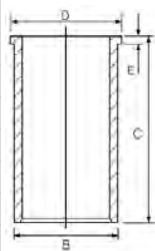

B 91.00 C 147.00 D 93.00 E 5.00

87-117900-00 STD

87-117907-00 0.50mm

A 42.30
B- 13.80
BØ 43.50
C 2.48
D 72.30
 30x70
 (08857-118)
AK KK RT



08-117900-00 STD

08-117907-00 0.50mm

2.50  CK P
 2.00  P
 3.00  CR P

 **88.00**

22

OM 611.961	4cyl.	2151cc	75-105kW (102-143PS)	Diesel	Turbo Intercooled	TD17005
OM 611.980 (Euro 3)	4cyl.	2151cc	60-90kW (82-122PS)	Diesel	Turbo Intercooled	TD14350
OM 611LA (75 kW CDI)	4cyl.	2151cc	75kW (102PS)	Diesel	Turbo Intercooled	TD14349
E-CLASS E 200 CDI			06/98→03/02	V-CLASS V 200 CDI		03/99→07/03
E-CLASS E 220 CDI			06/98→03/02	V-CLASS V 220		02/99→07/03
E-CLASS E 220 CDi			07/99→12/02	V-CLASS V 220 CDI		03/99→07/03
E-CLASS E 220 T CDI			06/98→03/03	VITO 110 CDI 2.2		03/99→07/03
V-CLASS V 200			03/99→07/03	VITO 112 CDI 2.2		03/99→07/03



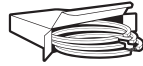

87-117900-10 STD
87-117907-10 0.50mm
 →Eng.063815

A 42.30
B- 13.30
BØ 43.10
C 2.48
D 72.30
 28x68

(08853-110)
AK KK RT



08-117900-00 STD
08-117907-00 0.50mm

2.50  CK P
 2.00  P
 3.00  CR P

14-020300-00 D

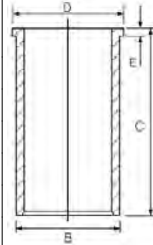

B 91.00 **C** 147.00 **D** 93.00 **E** 5.00

87-117900-20 STD
87-117907-20 0.50mm
 Eng.063816→

A 42.30
B- 13.80
BØ 43.50
C 2.48
D 72.30
 30x70

(08854-209)
AK KK RT TP



08-117900-00 STD
08-117907-00 0.50mm

2.50  CK P
 2.00  P
 3.00  CR P

88.00

23

OM 611.962	4cyl.	2151cc	75-105kW (102-143PS)	Diesel	Turbo Intercooled	TD15449
OM 611.981 (Euro 3)	4cyl.	2151cc	80-95kW (109-129PS)	Diesel	Turbo Intercooled	TD17729
OM 612.963	5cyl.	2685cc	120kW (163PS)	Diesel	Turbo Intercooled	TD17009
OM 613.960	6cyl.	3222cc	145kW (197PS)	Diesel	Turbo Intercooled	TD15461
OM 613.961	6cyl.	3226cc	145kW (197PS)	Diesel	Turbo Intercooled	TD15454
C-CLASS C 200 CDI			09/00→08/07		SPRINTER 2-t 211 CDI	04/00→05/06
C-CLASS C 220 CDI			05/00→08/07		SPRINTER 2-t 213 CDI	04/00→05/06
E-CLASS E 320 CDI			07/99→03/02		SPRINTER 3-t 311 CDI	04/00→05/06
E-CLASS E 320 T CDI			07/99→03/03		SPRINTER 3-t 313 CDI	04/00→05/06
M-CLASS ML 270 CDI			12/99→06/05		SPRINTER 4-t 411 CDI	04/00→05/06
S-CLASS S 320 CDI			08/99→09/02		SPRINTER 4-t 413 CDI	04/00→05/06

87-117900-00 STD
87-117907-00 0.50mm
 →01/03, →Eng.007289

A 42.30
B- 13.80
BØ 43.50
C 2.48
D 72.30
 30x70

(08857-118)
AK KK RT



08-117900-00 STD
08-117907-00 0.50mm

2.50  CK P
 2.00  P
 3.00  CR P

14-020300-00 D

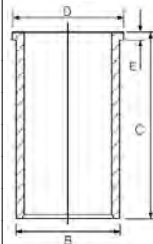

B 91.00 **C** 147.00 **D** 93.00 **E** 5.00





87-117900-20 STD
87-117907-20 0.50mm
 01/03 →, Eng.007290 →

- A** 42.30
- B-** 13.80
- BØ** 43.50
- C** 2.48
- D** 72.30
-  30x70

(08854-209)
AK KK RT TP



08-117900-00 STD
08-117907-00 0.50mm

- 2.50  CK P
- 2.00  P
- 3.00  CR P

88.00

24

OM 611.987 (Euro 3)	4cyl.	2151cc	60kW (82PS)	Diesel	Turbo Intercooled	TD17730
OM 612.961	5cyl.	2685cc	120-125kW (163-170PS)	Diesel	Turbo Intercooled	TD15455
OM 612.962	5cyl.	2685cc	120-125kW (163-170PS)	Diesel	Turbo Intercooled	TD15451
OM 612.965	5cyl.	2685cc	115-120kW (156-163PS)	Diesel	Turbo Intercooled	TD21145
OM 612.966	5cyl.	2685cc	115kW (156PS)	Diesel	Turbo Intercooled	TD16895
OM 612.967	5cyl.	2685cc	120-125kW (163-170PS)	Diesel	Turbo Intercooled	TD17323
OM 612.981	5cyl.	2685cc	110-115kW (150-156PS)	Diesel	Turbo Intercooled	TD17731
OM 612.983 (Euro 3)	5cyl.	2685cc	115kW (156PS)	Diesel	Turbo Intercooled	TD25649

ACCELO	05/03 →	SPRINTER 2-t 216 CDI	04/00 → 05/06
C-CLASS C 270 CDI	12/00 → 08/07	SPRINTER 3-t 308 CDI	04/00 → 05/06
CLK CLK 270 CDI	10/02 → 05/09	SPRINTER 3-t 316 CDI	04/00 → 05/06
E-CLASS E 270 CDI	07/99 → 12/02	SPRINTER 4-t 408 CDI	04/00 → 05/06
E-CLASS E 270 T CDI	07/99 → 03/03	SPRINTER 4-t 416 CDI	04/00 → 05/06
G-CLASS G 270 CDI	10/01 →	SPRINTER 5-t 616 CDI	04/01 → 05/06
SPRINTER 2-t 208 CDI	04/00 → 05/06		

87-117900-20 STD
87-117907-20 0.50mm

- A** 42.30
- B-** 13.80
- BØ** 43.50
- C** 2.48
- D** 72.30
-  30x70

(08854-209)
AK KK RT TP



08-117900-00 STD
08-117907-00 0.50mm

- 2.50  CK P
- 2.00  P
- 3.00  CR P

14-020300-00 D

B 91.00 C 147.00 D 93.00 E 5.00

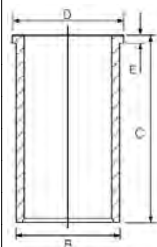

88.00

25

OM 611A (60 KW CDI)	4cyl.	2151cc	60kW (82PS)	Diesel	Turbo Intercooled	TD14348
VITO 108 CDI 2.2						03/99 → 07/03

14-020300-00 D

B 91.00 C 147.00 D 93.00 E 5.00

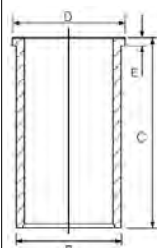

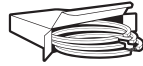

88.00							26
OM 646.811	4cyl.	2148cc	100-125kW (136-170PS)	Diesel	Turbo Intercooled		TD20360
OM 646.812	4cyl.	2148cc	100kW (136PS)	Diesel	Turbo Intercooled		TD22694
OM 646.820	4cyl.	2148cc	100kW (136PS)	Diesel	Turbo Intercooled		TD20362
OM 646.821	4cyl.	2148cc	100-125kW (136-170PS)	Diesel	Turbo Intercooled		TD20334
C-CLASS C 200 CDI			01/07→12/09		E-CLASS E 220 CDI		03/03→07/09
C-CLASS C 220 CDI			01/07→11/08		E-CLASS E 220 T CDI		03/03→07/09
E-CLASS E 200 CDI			04/06→07/09				

87-136400-30 STD

87-136407-30 0.50mm

08-136400-10 STD

A 44.30
B- 13.80
BØ 47.00
C 2.29
D 74.30
 30x70



2.50 GDC P
2.00 CR P
3.00 CR P



(08892G103)

AK KK RT TP

Bowl capacity 22.150cm³ Volumen der Kolbenmulde 22.150cm³ Volume de la cavité du piston 22.150cm³ Vol. cavidad pistón 22.150cm³ Volume camera pistone 22.150cm³

88.00							27
OM 646.951	4cyl.	2148cc	75-90kW (102-122PS)	Diesel			TD18129
OM 646.961	4cyl.	2148cc	100-110kW (136-150PS)	Diesel	Turbo Intercooled		TD17007
OM 646.962	4cyl.	2148cc	75-110kW (102-150PS)	Diesel	Turbo Intercooled		TD17542
OM 646.963	4cyl.	2148cc	90-110kW (122-150PS)	Diesel	Turbo Intercooled		TD17543
OM 646.966	4cyl.	2148cc	100-110kW (136-150PS)	Diesel	Turbo Intercooled		TD22844
OM 646.980	4cyl.	2148cc	70-110kW (95-150PS)	Diesel	Turbo Intercooled		TD24573
OM 646.981	4cyl.	2148cc	70kW (95PS)	Diesel	Turbo Intercooled		TD20984
OM 646.982 (Euro 4)	4cyl.	2148cc	80-110kW (109-150PS)	Diesel	Turbo Intercooled		TD18289
OM 646.983	4cyl.	2148cc	65-80kW (88-109PS)	Diesel	Turbo Intercooled		TD20921
OM 646.984	4cyl.	2148cc	65kW (88PS)	Diesel	Turbo Intercooled		TD22140
OM 646.985	4cyl.	2148cc	80kW (109PS)	Diesel	Turbo Intercooled		TD20730
OM 646.989	4cyl.	2148cc	110kW (150PS)	Diesel	Turbo Intercooled		TD26257
OM 646.990	4cyl.	2148cc	110kW (150PS)	Diesel	Turbo Intercooled		TD23618
OM 647.961	5cyl.	2685cc	120-130kW (163-177PS)	Diesel	Turbo Intercooled		TD17008
OM 647.981	5cyl.	2685cc	60-130kW (82-177PS)	Diesel	Turbo Intercooled		TD21142
OM 648.960	6cyl.	3222cc	150kW (204PS)	Diesel	Turbo Intercooled		TD17187
OM 648.961	6cyl.	3222cc	130-150kW (177-204PS)	Diesel	Turbo Intercooled		TD17328
C-CLASS C 200 CDI			03/03→05/08		SPRINTER 3-t 209 CDI		06/06→
C-CLASS C 220 CDI			02/03→05/08		SPRINTER 3-t 211 CDI		06/06→12/09
CLC-CLASS CLC 200 CDI			05/08→06/11		SPRINTER 3-t 215 CDI		06/06→12/09
CLC-CLASS CLC 220 CDI			05/08→06/11		SPRINTER 3-t 316 CDI		04/00→05/06
CLK CLK 220 CDI			01/05→05/09		SPRINTER 4,6-t 411 CDI		06/09→12/18
E-CLASS E 200 CDI			07/02→12/08		SPRINTER 4,6-t 415 CDI		06/06→12/09
E-CLASS E 220 CDI			03/02→07/09		SPRINTER 4-t 416 CDI		04/00→05/06
E-CLASS E 220 T CDI			03/03→07/09		SPRINTER 5-t 509 CDI		06/06→12/09
E-CLASS E 270 CDI			03/02→07/09		SPRINTER 5-t 511 CDI		06/06→12/09
E-CLASS E 270 T CDI			03/03→07/09		SPRINTER 5-t 515 CDI		06/06→12/09
E-CLASS E 280 CDI			05/04→12/08		VIANO CDI 2.0		09/03→
E-CLASS E 280 T CDI			05/04→07/09		VIANO CDI 2.2		09/03→
E-CLASS E 320 CDI			11/02→12/08		VITO 109 CDI		09/03→
E-CLASS E 320 T CDI			03/03→07/09		VITO 111 CDI		09/03→
S-CLASS S 320 CDI			09/02→08/05		VITO 115 CDI		09/03→
SPRINTER 3,5-t 309 CDI			06/06→		VITO / MIXTO 109 CDI		09/03→
SPRINTER 3,5-t 311 CDI			06/06→12/09		VITO / MIXTO 111 CDI		09/03→
SPRINTER 3,5-t 315 CDI			06/06→12/09		VITO / MIXTO 115 CDI		09/03→





87-136400-00 STD
87-136407-00 0.50mm

A 42.30
B- 14.10
BØ 46.00
C 2.29
D 72.30
 30x70

(08854-108)
KK RT TP



08-136400-00 STD
08-136407-00 0.50mm

2.50  CK P
 2.00  P
 3.00  CR P

14-020300-00 D

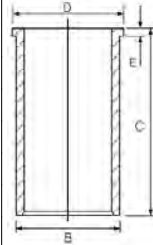

B 91.00 **C** 147.00 **D** 93.00 **E** 5.00

88.00

28

OM 646.986 (Euro 4)	4cyl.	2148cc	95-110kW (129-150PS)	Diesel	Turbo Intercooled	TD23620
SPRINTER 3,5-t 313 CDI			06/06→	SPRINTER 4,6-t 415 CDI		06/06→12/09
SPRINTER 3,5-t 315 CDI			06/06→12/09	SPRINTER 5-t 513 CDI		06/06→
SPRINTER 3-t 213 CDI			06/06→12/09	SPRINTER 5-t 515 CDI		06/06→12/09
SPRINTER 3-t 215 CDI			06/06→12/09			

87-428700-00 STD
87-428707-00 0.50mm

A 42.30
B- 14.10
BØ 46.00
C 2.03
C 1.78
D 72.30
 30x70

(8867A-101)
KK NB RT TP



08-428700-00 STD
08-428707-00 0.50mm

2.50  GDC P
 2.00  CR P
 2.00  CR P



88.50

29

M 103.980	6cyl.	2960cc	138kW (188PS)	Petrol	TD2099
M 103.981	6cyl.	2960cc	132-138kW (180-188PS)	Petrol	TD9436
M 103.982	6cyl.	2960cc	132-138kW (180-188PS)	Petrol	TD9444
M 103.983	6cyl.	2960cc	132-138kW (179-188PS)	Petrol	TD9437
M 103.984	6cyl.	2960cc	140kW (190PS)	Petrol	TD2103
M 103.985	6cyl.	2960cc	132kW (180PS)	Petrol	TD2104
M 103.987	6cyl.	2960cc	125-128kW (170-174PS)	Petrol	TD2105
124 300 CE			03/87→05/93	G-CLASS 300 GE	09/89→09/97
124 300 E			01/85→06/93	G-CLASS G 300	06/93→08/97
124 300 TE			01/86→06/93	S-CLASS 300 SE, SEL	09/85→06/91
E-CLASS E 300			06/93→06/95	SL 300 SL	09/85→08/93
E-CLASS E 300 T			06/93→06/96		

87-183000-00 STD
87-183007-00 0.50mm 

A 33.00
B- 2.70
C 0.82
C 2.02
D 63.00
 22x52
 (08942A/08946A)



08-183000-00 STD
08-183007-00 0.50mm

1.50  CK P
 1.75  P
 3.00  CR P

 B = 3.300



89.00					30
M 102.910	4cyl.	1797cc	80kW (109PS)	Petrol	TD2061
M 102.919	4cyl.	1797cc	77kW (105PS)	Petrol	TD2062
M 102.938	4cyl.	1997cc	63kW (86PS)	Petrol	TD22701
M 102.939	4cyl.	1997cc	74-80kW (100-109PS)	Petrol	TD2069
M 102.965	4cyl.	1997cc	80-85kW (109-116PS)	Petrol	TD2080
123 200		06/80→11/85	190 E 1.8		04/90→08/93
123 200 T		11/80→11/85	G-CLASS 200 GE		01/90→07/93

14-025480-00 D B 92.02 C 165.00 D 95.05 E 4.10

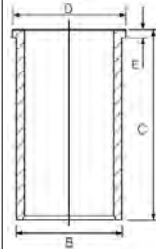

89.00					31
M 102.920	4cyl.	1997cc	74-80kW (100-109PS)	Petrol	TD2063
M 102.921	4cyl.	1997cc	63-77kW (86-105PS)	Petrol	TD2064
M 102.922	4cyl.	1997cc	75-80kW (102-109PS)	Petrol	TD2065
M 102.924	4cyl.	1997cc	75-77kW (102-105PS)	Petrol	TD4653
M 102.961	4cyl.	1997cc	83-93kW (113-126PS)	Petrol	TD5050
M 102.962	4cyl.	1997cc	83-90kW (115-122PS)	Petrol	TD4655
M 102.963	4cyl.	1997cc	87-90kW (118-122PS)	Petrol	TD2078
M 102.964	4cyl.	1997cc	80kW (109PS)	Petrol	TD17723
123 200		06/80→11/85	124 200 TE		09/88→08/92
123 200 T		11/80→11/85	190 2.0		10/82→05/90
124 200		12/85→10/92	190 E 2.0		10/82→08/93
124 200 CE		03/90→12/92	G-CLASS 200 G		07/82→08/89
124 200 E		09/88→08/93	G-CLASS 200 GE		07/82→08/89
124 200 T		09/85→05/90			

14-025480-00 D B 92.02 C 165.00 D 95.05 E 4.10

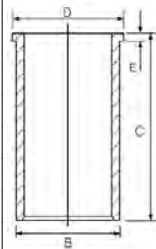

87-179500-10 STD ① ②
87-179507-10 0.50mm ② ③

A 43.20
BØ 50.00
C 2.15
D 1.62
E 79.70
④ 22x56



(08941/08937A)

08-179500-00 STD
08-179505-00 0.25mm
08-179507-00 0.50mm

1.75 CR P
2.00 P
3.50 CR P



① Std Piston no combustion cavity

① Std Kolben-keine Mulde

① Piston de contrepresion, sans cavité

① Pistón estándar sin concavidad

① Pistoni standard senza cavità di combustione

② Conrod gap 22.00mm

② Pleuelaugenabstand 22.00mm

② Distance entre bielle 22.00mm

② Distancia del biela 22.00mm

② diametro esterno

③ A = 42.900, D = 70.900, B = 1.100

89.00					32
OM 601.900 (Euro 2)	4cyl.	2299cc	62kW (85PS)	Diesel	TD16185
OM 601.940	4cyl.	2299cc	58-60kW (79-82PS)	Diesel	TD2210
OM 601.941	4cyl.	2299cc	58-60kW (79-82PS)	Diesel	TD8041
OM 601.942	4cyl.	2299cc	58kW (79PS)	Diesel	TD5398
OM 601.943	4cyl.	2299cc	58-60kW (79-82PS)	Diesel	TD5400
OM 602.940	5cyl.	2874cc	70-72kW (95-98PS)	Diesel	TD2215
OM 602.941	5cyl.	2874cc	65-70kW (88-95PS)	Diesel	TD8013





OM 602.942	5cyl.	2874cc	70-72kW (95-98PS)	Diesel	TD2054
OM 602.946	5cyl.	2874cc	70kW (95PS)	Diesel	TD17817
OM 602.947	5cyl.	2874cc	72kW (98PS)	Diesel	TD17818
OM 602.948	5cyl.	2874cc	71kW (97PS)	Diesel	TD8014
OM 602.991	5cyl.	2874cc	70kW (95PS)	Diesel	TD17820
OM 602.994	5cyl.	2874cc	72kW (98PS)	Diesel	TD17822
OM 602.995	5cyl.	2874cc	72kW (98PS)	Diesel	TD28784
OM 661.911	4cyl.	2299cc	57-58kW (77-79PS)	Diesel	TD8942
OM 661.940	4cyl.	2299cc	58kW (79PS)	Diesel	TD28791
OM 662.911 (OM 662 D 29)	5cyl.	2874cc	70kW (95PS)	Diesel	TD22700
G-CLASS 290 GD/G 290 D			06/93→07/00	T1 210 D 2.8	10/88→02/96
MB 100 2.3 D			11/99→01/03	T1 210 D 2.9	11/88→02/96
MB 100 2.9 D			10/01→05/05	T1 308 D 2.3	11/88→02/96
MB 140 2.9 D			11/99→05/05	T1 310 D 2.9	06/89→02/96
O 100			01/94→	T1/TN 408 D	11/88→06/95
O 405			01/84→	T1/TN 410 D	11/88→06/95
SPRINTER 2-t 208 D			01/95→04/00	T2/LN1 508 D	03/89→12/94
SPRINTER 3-t 308 D			02/95→04/00	T2/LN1 Dump Truck 508 D	03/89→12/94
SPRINTER 3-t 308 D 2.3			02/95→04/00	Tremo	09/98→
SPRINTER 4-t 408 D			02/96→05/06	UNIMOG	11/92→
T1 208 D 2.3			10/88→02/96	VITO 108 D 2.3	02/96→07/03

87-743100-10 STD
 87-743107-10 0.50mm
 87-743120-10 0.70mm

A 44.65
 B- 8.25
 C 1.25
 C 1.50
 D 74.65
 26x62
 (08953-209)



AK RT

08-743100-00 STD
 08-743107-00 0.50mm
 08-743120-00 0.70mm

2.50 CR P
 2.00 P
 3.00 CR P

14-026380-00 D B 91.50 C 156.50 D 96.55 E 4.70
 14-027210-00 D B 91.50 C 156.50 D 94.05 E 4.70

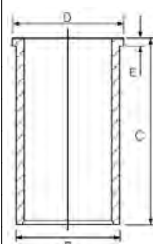

Conrod guided in Piston

Kolbengeführtes Pleuel

Bielle guidée dans le piston

Biela montada en el pistón

Billea montata sul pistone

89.00

33

OM 601A.970	4cyl.	2299cc	72kW (98PS)	Diesel	Turbo Intercooled	TD4674
OM 603A.970 (OM 603 D 35 A)	6cyl.	3449cc	100kW (136PS)	Diesel	Turbo	TD2224
OM 603A.971 (OM 603 D 35 A)	6cyl.	3449cc	100-110kW (136-150PS)	Diesel	Turbo	TD2225
OM 603A.972 (OM 603 D 35 A)	6cyl.	3449cc	100kW (136PS)	Diesel	Turbo	TD2226
G-CLASS 350 G Turbo-D			09/91→09/97	V-CLASS V 230		08/96→02/99
G-CLASS 350 Turbo GD			09/91→08/96	V-CLASS V 230 TD		09/96→07/03
G-CLASS G 320 CDI			09/96→08/99	VITO 110 D 2.3		03/97→07/03
S-CLASS S 350 Turbo-D			01/93→10/98	VITO 110 TD 2.3		02/96→07/03

87-743100-40 STD
 87-743107-40 0.50mm

A 44.65
 B- 8.25
 C 1.05
 C 1.25
 D 74.65
 28x70
 (08981)



KK RT

08-743100-00 STD
 08-743107-00 0.50mm
 08-743120-00 0.70mm

2.50 CR P
 2.00 P
 3.00 CR P

14-026380-00 D B 91.50 C 156.50 D 96.55 E 4.70
 14-027210-00 D B 91.50 C 156.50 D 94.05 E 4.70

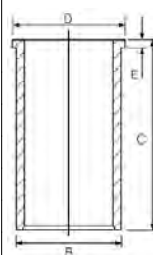



89.00					34
OM 604.910	4cyl.	2155cc	55-70kW (75-95PS)	Diesel	TD2227
OM 604.912	4cyl.	2155cc	55-70kW (75-95PS)	Diesel	TD4676
C-CLASS C 220 D		08/93→05/00		E-CLASS E 220 D	06/95→03/02
C-CLASS C 220 T D		06/96→03/01			

14-027210-00 D B 91.50 C 156.50 D 94.05 E 4.70

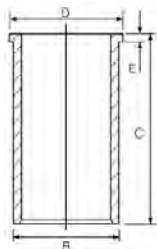

89.00					35	
OM 602.980	5cyl.	2874cc	75-90kW (102-122PS)	Diesel	Turbo Intercooled	TD8032
OM 602.981 (Euro 2)	5cyl.	2874cc	85-90kW (116-122PS)	Diesel	Turbo Intercooled	TD14670
OM 602.982 (OM 602 DE 29 LA)	5cyl.	2874cc	95kW (129PS)	Diesel	Turbo Intercooled	TD4675
OM 602.983 (OM 602 DE 29 LA)	5cyl.	2874cc	88kW (120PS)	Diesel	Turbo Intercooled	TD12910
OM 602.984	5cyl.	2874cc	90kW (122PS)	Diesel	Turbo Intercooled	TD5682
OM 602.985	5cyl.	2874cc	90kW (122PS)	Diesel	Turbo Intercooled	TD6020
OM 602.986	5cyl.	2874cc	75-90kW (102-122PS)	Diesel	Turbo	TD9459
OM 602.989 (Euro 2)	5cyl.	2874cc	85-90kW (116-122PS)	Diesel	Turbo Intercooled	TD14672
E-CLASS E 290 TD		07/96→07/99		SPRINTER 4-t 412 D	02/96→05/06	
E-CLASS E 290 T Turbo-D		06/96→07/99		SPRINTER 4-t 414 D	05/97→05/06	
E-CLASS E 290 Turbo-D		03/96→07/99		UNIMOG	07/96→	
G-CLASS G 290 TD		07/97→		UX100	01/99→	
SPRINTER 2-t 210 D		01/97→04/00		VARIO 512 D	09/96→12/10	
SPRINTER 2-t 212 D		02/95→04/00		VARIO 612 D	09/96→12/10	
SPRINTER 3-t 310 D		01/97→08/02		VARIO 812 D	09/96→12/10	
SPRINTER 3-t 310 D 2.9		02/95→04/00		VARIO Dump Truck 612 D	09/96→12/10	
SPRINTER 3-t 312 D 2.9		02/95→08/02		VARIO Dump Truck 812 D	09/96→12/10	
SPRINTER 4-t 410 D		02/96→05/06		VARIO O 812	09/96→12/10	

87-743100-00 STD
87-743107-00 0.50mm

A 44.75
B- 16.73
BØ 42.00
C 0.60
C 0.30
D 71.25
 28x70

(08980C)
AK KK RT

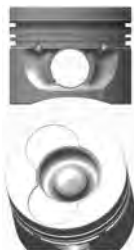

08-743100-00 STD
08-743107-00 0.50mm
08-743120-00 0.70mm

2.50 CR P
 2.00 P
 3.00 CR P

14-026380-00 D B 91.50 C 156.50 D 96.55 E 4.70
14-027210-00 D B 91.50 C 156.50 D 94.05 E 4.70

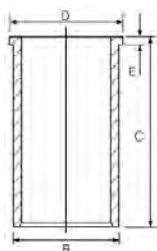



87-743107-50 0.50mm

- A 44.55
- B- 16.74
- BØ 42.00
- C 0.30
- C 0.60
- D 74.55
-  28x70

(08980C)

KK RT



08-743100-00 STD
08-743107-00 0.50mm
08-743120-00 0.70mm

- 2.50  CR P
- 2.00  P
- 3.00  CR P

89.90

36

M 104.941	6cyl.	2799cc	142kW (193PS)	Petrol	TD2106
M 104.942	6cyl.	2799cc	142-145kW (193-197PS)	Petrol	TD2107
M 104.943	6cyl.	2799cc	142-150kW (193-204PS)	Petrol	TD2108
M 104.944	6cyl.	2799cc	142-145kW (193-197PS)	Petrol	TD2109
M 104.945	6cyl.	2799cc	142kW (193PS)	Petrol	TD9423
124 280 E			10/92→06/93	E-CLASS E 280 T	06/93→06/96
124 280 TE			10/92→06/93	S-CLASS 300 SE 2.8	01/93→10/98
C-CLASS C 280			05/93→05/00	S-CLASS S 280	02/93→10/98
E-CLASS E 280			06/93→06/97	SL 280	08/93→10/01

87-287500-20 STD
87-287507-20 0.50mm ①

- A 32.38
- B- 2.54
- BØ 59.00
- C 1.20
- D 58.58
-  22x56

(09029)



08-287500-00 STD
08-287505-00 0.25mm
08-287507-00 0.50mm

- 1.50  NT ②
- 1.75  P
- 3.00  CR P

① A = 32.075, D = 58.075

② Steel

② Stahl

② Acier

② Accero

② Acciaio

89.90

37

M 104.990	6cyl.	3199cc	162-170kW (220-231PS)	Petrol	TD2112
M 104.991	6cyl.	3199cc	162-170kW (220-231PS)	Petrol	TD2113
M 104.992	6cyl.	3199cc	162kW (220PS)	Petrol	TD2114
M 104.994	6cyl.	3199cc	170kW (231PS)	Petrol	TD11250
M 104.995	6cyl.	3199cc	162kW (220PS)	Petrol	TD4658
M 104.996	6cyl.	3199cc	155kW (211PS)	Petrol	TD11251
124 320 CE			10/92→05/93	G-CLASS G 320	09/94→12/97
124 320 E			10/92→06/93	S-CLASS 300 SE, SEL/S320	03/91→10/98
124 320 TE			10/92→06/93	S-CLASS S 320	10/95→08/98
E-CLASS E 320			06/93→03/98	SL 320	09/93→10/01
E-CLASS E 320 T			06/93→06/96	SL SL 320	09/94→12/97
G-CLASS 320 GE			09/94→11/97		



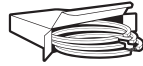

87-287500-30 STD 1
87-287505-30 0.25mm 1
87-287507-30 0.50mm 1

08-287500-00 STD
08-287505-00 0.25mm
08-287507-00 0.50mm

A 31.12
B- 1.20
BØ 74.00
C 1.60
D 2.50
D 56.10
 22x56
 (09024)



1.50  NT 2
 1.75  P
 3.00  CR P

1 Elastoval®
2 Steel

2 Stahl

2 Acier

2 Acero

2 Acciaio

89.90

38

M 112.940	V6cyl.	3199cc	160-162kW (218-220PS)	Petrol	TD9407
M 112.941	V6cyl.	3199cc	160-165kW (218-224PS)	Petrol	TD9418
M 112.942	V6cyl.	3199cc	160kW (218PS)	Petrol	TD9898
M 112.943	V6cyl.	3199cc	165kW (224PS)	Petrol	TD11494
M 112.944	V6cyl.	3199cc	165kW (224PS)	Petrol	TD11491
M 112.945	V6cyl.	3199cc	158kW (215PS)	Petrol	TD9888
M 112.946	V6cyl.	3199cc	160kW (218PS)	Petrol	TD15452
M 112.947	V6cyl.	3199cc	160kW (218PS)	Petrol	TD14773
M 112.949	V6cyl.	3199cc	165kW (224PS)	Petrol	TD16894
M 112.951	V6cyl.	3199cc	140-160kW (190-218PS)	Petrol	TD18435
M 112.953	V6cyl.	3199cc	160kW (218PS)	Petrol	TD17535
M 112.954	V6cyl.	3199cc	165kW (224PS)	Petrol	TD17331
M 112.955	V6cyl.	3199cc	160kW (218PS)	Petrol	TD16885
M 113.940	V8cyl.	4266cc	205kW (279PS)	Petrol	TD9889
M 113.941	V8cyl.	4266cc	205kW (279PS)	Petrol	TD11492
M 113.942	V8cyl.	4266cc	199kW (271PS)	Petrol	TD10949
M 113.943	V8cyl.	4266cc	205kW (279PS)	Petrol	TD10947
M 113.944	V8cyl.	4266cc	205-225kW (279-306PS)	Petrol	TD11489

C-CLASS C 43 AMG	08/97→03/01	M-CLASS ML 430	02/98→06/05
C-CLASS C 320	05/00→05/08	S-CLASS S 320	10/98→08/05
CLK CLK 320	06/97→03/10	S-CLASS S 430	10/98→08/05
CLK CLK 430	07/98→06/02	SL 320	05/98→10/01
E-CLASS E 320	06/97→12/08	SLK 320	03/00→04/04
E-CLASS E 320 T	12/96→07/09	VIANO 3.2	09/03→
E-CLASS E 430	06/97→03/02	VITO 119	09/03→
E-CLASS E 430 T	06/97→03/03	VITO 122	09/03→
G-CLASS G 320	07/97→08/04	VITO / MIXTO 119	09/03→
M-CLASS ML 320	02/98→08/02	VITO / MIXTO 122	09/03→

87-119000-00 STD

08-119000-00 STD

A 31.30
B- 2.42
BØ 65.82
C 1.82
D 53.30
 22x52
 (09044)



1.50  NT 1
 1.75  P
 3.00  CR 1

1 Steel

1 Stahl

1 Acier

1 Acero

1 Acciaio



90.90

39

M 111.970	4cyl.	2295cc	110kW (150PS)	Petrol	TD4664
M 111.974	4cyl.	2295cc	110kW (150PS)	Petrol	TD4666
M 111.984	4cyl.	2295cc	92-105kW (125-143PS)	Petrol	TD17850
C-CLASS C 230			06/96→06/97	SPRINTER 2-t 214 NGT	02/95→05/06
C-CLASS C 230 T			06/96→06/98	SPRINTER 3-t 314	02/95→05/06
E-CLASS E 230			06/95→06/97	SPRINTER 3-t 314 NGT	02/95→05/06
E-CLASS E 230 T			06/96→06/97	SPRINTER 4-t 414	02/95→05/06
SPRINTER 2-t 214			02/95→05/06	SPRINTER 4-t 414 NGT	02/95→05/06

87-109100-00 STD
87-109107-00 0.50mm ①
 →12/95

A 30.00
B+ 2.90
C 1.00
D 57.90

22x56
 (09128)

08-109100-00 STD
08-109107-00 0.50mm

1.50 NT②
 1.75
 3.00 NT②

87-109100-10 STD
87-109107-10 0.50mm
 01/96→

A 30.00
B- 1.10
BØ 70.00
C 0.85
D 55.00

22x56
 (09130)

08-109100-00 STD
08-109107-00 0.50mm

1.50 NT②
 1.75
 3.00 NT②

① B+ = 1.700

② Steel

② Stahl

② Acier

② Acero

② Acciaio

90.90

40

M 111.973	4cyl.	2295cc	138-142kW (188-193PS)	Petrol Supercharged	TD4665
M 111.975	4cyl.	2295cc	138-142kW (188-193PS)	Petrol Supercharged	TD4667
M 111.978	4cyl.	2295cc	105kW (143PS)	Petrol	TD4668
M 111.979	4cyl.	2295cc	95-105kW (129-143PS)	Petrol	TD5241
M 111.981	4cyl.	2295cc	143-145kW (194-197PS)	Petrol Supercharged	TD17177
M 111.982	4cyl.	2295cc	145kW (197PS)	Petrol Supercharged	TD16884
M 111.983	4cyl.	2295cc	143-145kW (194-197PS)	Petrol Supercharged	TD14750
M 161.971	4cyl.	2295cc	90-110kW (143-150PS)	Petrol	TD23184
C-CLASS C 230			10/95→12/02	SPRINTER 2-t 214 NGT	02/95→05/06
C-CLASS C 230 T			06/97→09/00	SPRINTER 3-t 314	02/95→05/06
CLK CLK 230			06/97→06/02	SPRINTER 3-t 314 NGT	02/95→05/06
MB 100 2.3 i			11/99→05/05	SPRINTER 4-t 414	02/95→05/06
MB 140 2.3 i			11/99→05/05	SPRINTER 4-t 414 NGT	02/95→05/06
SLK 230			09/96→04/04	V-CLASS V 230	08/96→07/03
SPRINTER 2-t 214			02/95→05/06	VITO 114 2.3	12/96→07/03





87-109100-10 STD
87-109107-10 0.50mm

A 30.00
B- 1.10
BØ 70.00
C 0.85
D 55.00
 22x56
(09130)



08-109100-00 STD
08-109107-00 0.50mm

1.50 NT①
1.75 NT①
3.00 NT①

① Steel ① Stahl ① Acier ① Acero ① Acciaio

90.90					41
M 111.977	4cyl.	2295cc	110kW (150PS)	Petrol	TD10948
M 111.980	4cyl.	2295cc	105kW (143PS)	Petrol	TD22703
M-CLASS ML 230			02/98→06/05	VITO 114 2.3	12/96→07/03
V-CLASS V 230			08/96→07/03		

87-109100-00 STD
87-109107-00 0.50mm ①

A 30.00
B+ 2.90
C 1.00
D 57.90
 22x56
(09128)



08-109100-00 STD
08-109107-00 0.50mm

1.50 NT②
1.75 NT②
3.00 NT②



① B+ = 1.700
② Steel ② Stahl ② Acier ② Acero ② Acciaio

90.90					42
OM 616	4cyl.	2399cc	41-55kW (56-75PS)	Diesel	TD2244
OM 616.910	4cyl.	2399cc	48-53kW (65-72PS)	Diesel	TD2245
OM 616.912 (OM 616 D 24)	4cyl.	2399cc	46-53kW (63-72PS)	Diesel	TD9432
OM 616.913	4cyl.	2399cc	53kW (72PS)	Diesel	TD2247
OM 616.914	4cyl.	2404cc	53kW (72PS)	Diesel	TD8040
OM 616.917	4cyl.	2399cc	48kW (65PS)	Diesel	TD2249
OM 616.918	4cyl.	2399cc	35-48kW (48-65PS)	Diesel	TD28786
OM 616.930	4cyl.	2399cc	44kW (60PS)	Diesel	TD5677
OM 616.934	4cyl.	2404cc	48kW (65PS)	Diesel	TD2250
OM 616.936 (OM 616 D 24)	4cyl.	2399cc	53kW (72PS)	Diesel	TD2251
OM 616.937	4cyl.	2399cc	48-53kW (65-72PS)	Diesel	TD2252
OM 616.938 (OM 616 D 24)	4cyl.	2399cc	53kW (72PS)	Diesel	TD17733
OM 616.939	4cyl.	2399cc	53kW (72PS)	Diesel	TD2253
OM 616.940	4cyl.	2399cc	53kW (72PS)	Diesel	TD22836
OM 616.942	4cyl.	2404cc	38kW (52PS)	Diesel	TD7991
OM 616.943	4cyl.	2404cc	44kW (60PS)	Diesel	TD7992
OM 616.962	4cyl.	2404cc	33-53kW (45-72PS)	Diesel	TD28788
OM 616.963	4cyl.	2399cc	41-61kW (56-83PS)	Diesel	TD2257
OM 617.912 (OM 617 D30)	5cyl.	3005cc	59-65kW (80-88PS)	Diesel	TD2260
OM 617.913	5cyl.	2998cc	65kW (88PS)	Diesel	TD2261
OM 617.919	5cyl.	3005cc	39kW (53PS)	Diesel	TD28789
OM 617.931 (OM 617 D30)	5cyl.	2998cc	65kW (88PS)	Diesel	TD2262





OM 617.932 (OM 617 D30)	5cyl.	2998cc	65kW (88PS)	Diesel	TD17743
123 240 D			02/76→11/85	T1 209 D 2.9	12/82→01/90
123 240 T D			09/77→12/85	T1 307 D 2.4	04/77→01/90
123 300 D			02/76→11/85	T1 309 D 3.0	10/82→01/90
123 300 T D			09/77→11/85	T1 407 D 2.4	04/81→07/82
G-CLASS 240 GD			03/79→08/89	T1/TN 407 D	07/81→01/89
G-CLASS 300 GD			11/79→12/91	T1/TN 409 D	04/82→01/89
MB 2.4 D			01/93→01/96	T2/L L 407 D	01/75→12/88
MB D			02/88→02/96	T2/LN1 507 D	04/86→04/89
O 309			01/75→12/88	T2/LN1 Dump Truck 507 DK	04/86→04/89
T1 207 D 2.4			04/77→01/90	UNIMOG	05/88→

87-176700-00 STD 
87-176708-00 0.60mm 

A 48.35
B- 8.75
C 1.15
D 79.65
 26x74

(09105H/09113C)
RT





08-176700-00 STD
08-176707-00 0.50mm
08-176708-00 0.60mm

3.00  MOL P
 2.00  P
 4.00  CR P

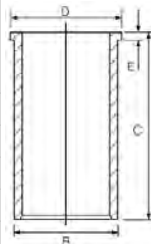
14-021350-00 D **B 94.00 C 158.40 D 96.00 E 4.70**



 Bore = 90.90mm

 Bohrung = 90.90mm

 Alésage = 90.90mm

 Tamaño del diámetro = 90.90mm

 Alessagio = 90.90mm

90.90

43

OM 616.911	4cyl.	2404cc	38kW (52PS)	Diesel	TD5675
OM 616.916 (OM 616 D 24)	4cyl.	2404cc	48kW (65PS)	Diesel	TD2248
OM 616.919	4cyl.	2399cc	38-48kW (52-65PS)	Diesel	TD28787
OM 616.932	4cyl.	2404cc	44kW (60PS)	Diesel	TD6015
OM 616.933	4cyl.	2404cc	44kW (60PS)	Diesel	TD16998
OM 616.944	4cyl.	2399cc	44kW (60PS)	Diesel	TD16937
OM 616.960	4cyl.	2399cc	53kW (72PS)	Diesel	TD2255
OM 616.961	4cyl.	2404cc	53kW (72PS)	Diesel	TD2256
OM 617.910 (OM 617 D30)	5cyl.	3005cc	59kW (80PS)	Diesel	TD2259
OM 617.933 (OM 617 D30)	5cyl.	2998cc	65kW (88PS)	Diesel	TD26550
OM 617.950 (OM 617 D30 A)	5cyl.	2998cc	85kW (116PS)	Diesel Turbo	TD2263
OM 617.951 (OM 617 D30 A)	5cyl.	2998cc	92kW (125PS)	Diesel Turbo	TD2264
OM 617.952 (OM 617 D30 A)	5cyl.	2998cc	92kW (125PS)	Diesel Turbo	TD2265
/8 240 D			08/73→01/77	123 300 Turbo-D	08/81→07/85
/8 240 D 3.0			08/74→11/76	S-CLASS 300 SD	09/80→12/85
123 300 C Turbo-D			09/81→07/85	UNIMOG	01/77→05/88
123 300 T Turbo-D			10/80→11/85		

14-021350-00 D **B 94.00 C 158.40 D 96.00 E 4.70**

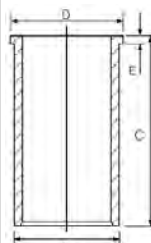

97.00

44

OM 314.900	4cyl.	3784cc	46-63kW (63-86PS)	Diesel	TD22733
OM 314.910	4cyl.	3784cc	63-63kW (85-86PS)	Diesel	TD5691



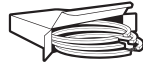

OM 314.914	4cyl.	3784cc	35-62kW (48-84PS)	Diesel	TD22546
OM 314.915	4cyl.	3784cc	63kW (85PS)	Diesel	TD16557
OM 314.916	4cyl.	3784cc	40kW (54PS)	Diesel	TD7971
OM 314.917	4cyl.	3784cc	48-55kW (66-75PS)	Diesel	TD7973
OM 314.918	4cyl.	3784cc	53kW (72PS)	Diesel	TD22545
OM 314.919	4cyl.	3784cc	53kW (72PS)	Diesel	TD22547
OM 314.920	4cyl.	3784cc	55kW (75PS)	Diesel	TD28222
OM 314.921	4cyl.	3784cc	48kW (65PS)	Diesel	TD28223
OM 314.922	4cyl.	3784cc	57kW (78PS)	Diesel	TD28585
OM 314.940	4cyl.	3784cc	35-62kW (48-84PS)	Diesel	TD22548
OM 314.941	4cyl.	3784cc	35-62kW (48-84PS)	Diesel	TD22549
OM 314.942	4cyl.	3784cc	35-62kW (48-84PS)	Diesel	TD22550
OM 314.943	4cyl.	3784cc	35-62kW (48-84PS)	Diesel	TD22551
OM 314.944	4cyl.	3784cc	63kW (85PS)	Diesel	TD6028
OM 314.945	4cyl.	3784cc	35-62kW (48-84PS)	Diesel	TD22552
OM 314.946	4cyl.	3784cc	63kW (85PS)	Diesel	TD2202
OM 314.947	4cyl.	3784cc	35-62kW (48-84PS)	Diesel	TD22553
OM 314.948	4cyl.	3784cc	63kW (85PS)	Diesel	TD2203
OM 314.949	4cyl.	3784cc	35-62kW (48-84PS)	Diesel	TD22554
OM 314.950	4cyl.	3784cc	35-62kW (48-84PS)	Diesel	TD22555
OM 314.951	4cyl.	3784cc	35-66kW (48-90PS)	Diesel	TD22556
OM 314.953	4cyl.	3784cc	59kW (80PS)	Diesel	TD7975
OM 314.954	4cyl.	3784cc	35-62kW (48-84PS)	Diesel	TD22557
OM 314.956	4cyl.	3784cc	48kW (65PS)	Diesel	TD16999
OM 314.957	4cyl.	3784cc	53kW (72PS)	Diesel	TD17000
OM 314.958	4cyl.	3784cc	35-62kW (48-84PS)	Diesel	TD22558
OM 314.959	4cyl.	3784cc	63kW (85PS)	Diesel	TD2204
OM 314.960	4cyl.	3784cc	35-62kW (48-84PS)	Diesel	TD22559
OM 314.961	4cyl.	3784cc	63kW (85PS)	Diesel	TD16552
OM 314.962	4cyl.	3784cc	63kW (85PS)	Diesel	TD16553
OM 314.963	4cyl.	3784cc	63kW (85PS)	Diesel	TD16554
OM 314.964	4cyl.	3784cc	63kW (85PS)	Diesel	TD16555
OM 314.965	4cyl.	3784cc	63kW (85PS)	Diesel	TD16556
OM 340.930	4cyl.	3784cc	63kW (86PS)	Diesel	TD28271
OM 340.932	4cyl.	3784cc	62kW (84PS)	Diesel	TD28460
OM 341.910	6cyl.	5675cc	74kW (101PS)	Diesel	TD28463
OM 341.911	6cyl.	5675cc	81kW (110PS)	Diesel	TD28464
OM 341.912	6cyl.	5675cc	96kW (131PS)	Diesel	TD28465
OM 341.915	6cyl.	5675cc	96kW (131PS)	Diesel	TD28467
OM 341.918	6cyl.	5675cc	66kW (90PS)	Diesel	TD28468
OM 341.919	6cyl.	5675cc	74kW (101PS)	Diesel	TD28472
OM 341.931	6cyl.	5675cc	74kW (101PS)	Diesel	TD28469
OM 341.932	6cyl.	5675cc	96kW (131PS)	Diesel	TD28473
OM 341.934	6cyl.	5675cc	62kW (84PS)	Diesel	TD28476
OM 341.935	6cyl.	5675cc	96kW (131PS)	Diesel	TD28477
OM 341.936	6cyl.	5675cc	96kW (131PS)	Diesel	TD28478
OM 341.938	6cyl.	5675cc	66kW (90PS)	Diesel	TD28480
OM 341.941	6cyl.	5675cc	96kW (131PS)	Diesel	TD28482
OM 341.946	6cyl.	5675cc	96kW (131PS)	Diesel	TD28484
OM 341.948	6cyl.	5675cc	96kW (131PS)	Diesel	TD28486





OM 341.949	6cyl.	5675cc	96kW (131PS)	Diesel		TD28487
OM 341.995	6cyl.	5675cc	96kW (131PS)	Diesel		TD28489
OM 343.910	4cyl.	3784cc	62kW (84PS)	Diesel		TD28491
OM 343.932	4cyl.	3784cc	63kW (86PS)	Diesel		TD28492
OM 343.934	4cyl.	3784cc	63kW (86PS)	Diesel		TD28493
OM 344.905 (OM352)	6cyl.	5675cc	96kW (131PS)	Diesel		TD28587
OM 344.912 (OM352)	6cyl.	5675cc	96kW (131PS)	Diesel		TD28588
OM 344.930 (OM352)	6cyl.	5675cc	96kW (131PS)	Diesel		TD28589
OM 344.932 (OM352)	6cyl.	5675cc	96kW (131PS)	Diesel		TD28591
OM 344.933 (OM352)	6cyl.	5675cc	96kW (131PS)	Diesel		TD28592
OM 344.940 (OM352 A)	6cyl.	5675cc	96kW (131PS)	Diesel	Turbo	TD23174
OM 344.941 (OM352 A)	6cyl.	5675cc	96kW (131PS)	Diesel	Turbo	TD28272
OM 344.943 (OM352)	6cyl.	5675cc	96kW (131PS)	Diesel		TD28593
OM 344.944 (OM352)	6cyl.	5675cc	96kW (131PS)	Diesel		TD28594
OM 344.945 (OM352)	6cyl.	5675cc	96kW (131PS)	Diesel		TD28595
OM 344.946 (OM352)	6cyl.	5675cc	96kW (131PS)	Diesel		TD28596
OM 344.949	6cyl.	5675cc	96kW (131PS)	Diesel	Turbo	TD22735
OM 344.963 (OM352)	6cyl.	5675cc	96kW (131PS)	Diesel		TD28597
OM 352.901	6cyl.	5675cc	95-96kW (129-131PS)	Diesel		TD16626
OM 352.902	6cyl.	5675cc	52kW (70PS)	Diesel		TD7974
OM 352.903	6cyl.	5675cc	66kW (90PS)	Diesel		TD7977
OM 352.904	6cyl.	5675cc	93kW (126PS)	Diesel		TD16627
OM 352.905	6cyl.	5675cc	96kW (130PS)	Diesel		TD7966
OM 352.906	6cyl.	5675cc	81kW (110PS)	Diesel		TD5700
OM 352.907	6cyl.	5675cc	81kW (110PS)	Diesel		TD5702
OM 352.908	6cyl.	5675cc	81-96kW (110-131PS)	Diesel		TD5701
OM 352.909	6cyl.	5675cc	81kW (110PS)	Diesel		TD16606
OM 352.910	6cyl.	5675cc	74kW (100PS)	Diesel		TD16615
OM 352.911	6cyl.	5675cc	81kW (110PS)	Diesel		TD16607
OM 352.912	6cyl.	5675cc	96-97kW (130-132PS)	Diesel		TD16628
OM 352.914	6cyl.	5675cc	81kW (110PS)	Diesel		TD7921
OM 352.915	6cyl.	5675cc	93kW (126PS)	Diesel		TD7922
OM 352.917	6cyl.	5675cc	93kW (126PS)	Diesel		TD16629
OM 352.919	6cyl.	5675cc	48kW (65PS)	Diesel		TD7984
OM 352.930	6cyl.	5675cc	96kW (130PS)	Diesel		TD16630
OM 352.931	6cyl.	5675cc	96kW (130PS)	Diesel		TD16631
OM 352.932	6cyl.	5675cc	81kW (110PS)	Diesel		TD16608
OM 352.933	6cyl.	5675cc	81kW (110PS)	Diesel		TD16609
OM 352.934	6cyl.	5675cc	96kW (130PS)	Diesel		TD16632
OM 352.935	6cyl.	5675cc	96kW (130PS)	Diesel		TD16633
OM 352.936	6cyl.	5675cc	96kW (130PS)	Diesel		TD8158
OM 352.938	6cyl.	5675cc	96kW (130PS)	Diesel		TD5738
OM 352.939	6cyl.	5675cc	96kW (130PS)	Diesel		TD16634
OM 352.942	6cyl.	5675cc	74kW (100PS)	Diesel		TD16616
OM 352.943	6cyl.	5675cc	81kW (110PS)	Diesel		TD16610
OM 352.944	6cyl.	5675cc	93kW (126PS)	Diesel		TD16635
OM 352.945	6cyl.	5675cc	96kW (130PS)	Diesel		TD16637
OM 352.948	6cyl.	5675cc	93kW (126PS)	Diesel		TD16638
OM 352.953	6cyl.	5675cc	93kW (126PS)	Diesel		TD16639
OM 352.954	6cyl.	5675cc	93kW (126PS)	Diesel		TD16640





OM 352.955	6cyl.	5675cc	93kW (126PS)	Diesel	TD17012
OM 352.959 (OM 352)	6cyl.	5675cc	96kW (130PS)	Diesel	TD22737
OM 352.963	6cyl.	5675cc	96kW (130PS)	Diesel	TD6071
OM 352.964	6cyl.	5675cc	96kW (130PS)	Diesel	TD5714
OM 352.965 (OM 352)	6cyl.	5675cc	69kW (94PS)	Diesel	TD22738
OM 352.966 (OM 352)	6cyl.	5675cc	79kW (107PS)	Diesel	TD22739
OM 352.967 (OM 352)	6cyl.	5675cc	74kW (101PS)	Diesel	TD22740
OM 352.969	6cyl.	5675cc	96kW (130PS)	Diesel	TD8089
OM 352.970	6cyl.	5675cc	81kW (110PS)	Diesel	TD16611
OM 352.971	6cyl.	5675cc	74kW (100PS)	Diesel	TD16617
OM 352.972	6cyl.	5675cc	74kW (100PS)	Diesel	TD16618
OM 352.973	6cyl.	5675cc	74kW (100PS)	Diesel	TD16619
OM 352.974	6cyl.	5675cc	74kW (100PS)	Diesel	TD16620
OM 352.975	6cyl.	5675cc	74kW (100PS)	Diesel	TD16621
OM 352.976	6cyl.	5675cc	81kW (110PS)	Diesel	TD16612
OM 352.978 (OM 352)	6cyl.	5675cc	96kW (131PS)	Diesel	TD22741
OM 352.979	6cyl.	5675cc	81kW (110PS)	Diesel	TD16613
OM 352.980	6cyl.	5675cc	96kW (130PS)	Diesel	TD17015
OM 352.981	6cyl.	5675cc	81kW (110PS)	Diesel	TD16622
OM 352.982	6cyl.	5675cc	81kW (110PS)	Diesel	TD16614
OM 352.983	6cyl.	5675cc	81kW (110PS)	Diesel	TD16623
OM 352.984	6cyl.	5675cc	59kW (80PS)	Diesel	TD7976
OM 352.985	6cyl.	5675cc	81kW (110PS)	Diesel	TD16624
OM 352.986	6cyl.	5675cc	81kW (110PS)	Diesel	TD6037
OM 352.987	6cyl.	5675cc	93kW (126PS)	Diesel	TD17013
OM 352.989	6cyl.	5675cc	81kW (110PS)	Diesel	TD16625
OM 352.990	6cyl.	5675cc	81kW (110PS)	Diesel	TD6036
OM 352.991	6cyl.	5675cc	93kW (126PS)	Diesel	TD17014
OM 352.992 (OM 352)	6cyl.	5675cc	93kW (126PS)	Diesel	TD22742
OM 352.993	6cyl.	5675cc	96kW (130PS)	Diesel	TD7891
OM 352.996	6cyl.	5675cc	96kW (130PS)	Diesel	TD6281
OM 352.997	6cyl.	5675cc	96kW (130PS)	Diesel	TD5713
OM 352.998	6cyl.	5675cc	96kW (130PS)	Diesel	TD6047
OM 352.999 (OM 352)	6cyl.	5675cc	79kW (107PS)	Diesel	TD22743
OM 353.900 (OM352)	6cyl.	5675cc	96kW (130PS)	Diesel	TD16651
OM 353.901 (OM352)	6cyl.	5675cc	74kW (100PS)	Diesel	TD7979
OM 353.902 (OM352)	6cyl.	5675cc	62kW (84PS)	Diesel	TD5678
OM 353.903 (OM352)	6cyl.	5675cc	81kW (110PS)	Diesel	TD16652
OM 353.904 (OM352)	6cyl.	5675cc	96kW (130PS)	Diesel	TD5697
OM 353.905 (OM352)	6cyl.	5675cc	74kW (100PS)	Diesel	TD7988
OM 353.907 (OM352)	6cyl.	5675cc	92kW (125PS)	Diesel	TD7982
OM 353.915 (OM352)	6cyl.	5675cc	81kW (110PS)	Diesel	TD16653
OM 353.916 (OM352)	6cyl.	5675cc	81kW (110PS)	Diesel	TD16654
OM 353.917 (OM352)	6cyl.	5675cc	96kW (130PS)	Diesel	TD16655
OM 353.922 (OM352 MBSA)	6cyl.	5675cc	88kW (120PS)	Diesel	TD26352
OM 353.923 (OM352 MBSA)	6cyl.	5675cc	81kW (110PS)	Diesel	TD26353
OM 353.930 (OM352 MBSA)	6cyl.	5675cc	62kW (84PS)	Diesel	TD26354
OM 353.931 (OM352 MBSA)	6cyl.	5675cc	81kW (110PS)	Diesel	TD26356
OM 353.932 (OM352 MBSA)	6cyl.	5675cc	88kW (120PS)	Diesel	TD26355
OM 353.933 (OM352 MBSA)	6cyl.	5675cc	88kW (120PS)	Diesel	TD26357



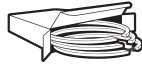

OM 353.934 (OM352 MBSA)	6cyl.	5675cc	88kW (120PS)	Diesel		TD26358
OM 353.935 (OM352 MBSA)	6cyl.	5675cc	88kW (120PS)	Diesel		TD26359
OM 353.936 (OM352 MBSA)	6cyl.	5675cc	81kW (110PS)	Diesel		TD26360
OM 353.938 (OM352 MBSA)	6cyl.	5675cc	88kW (120PS)	Diesel		TD26362
OM 353.940 (OM352)	6cyl.	5675cc	81kW (110PS)	Diesel		TD6016
OM 353.941 (OM352)	6cyl.	5675cc	96kW (130PS)	Diesel		TD16656
OM 353.942 (OM352)	6cyl.	5675cc	96kW (130PS)	Diesel		TD5709
OM 353.943 (OM352)	6cyl.	5675cc	96kW (130PS)	Diesel		TD5727
OM 353.944 (OM352)	6cyl.	5675cc	96kW (130PS)	Diesel		TD5728
OM 353.945 (OM352)	6cyl.	5675cc	96kW (130PS)	Diesel		TD5710
OM 353.946 (OM352)	6cyl.	5675cc	96kW (130PS)	Diesel		TD6044
OM 353.949 (OM352)	6cyl.	5675cc	81kW (110PS)	Diesel		TD16994
OM 353.957 (OM352 A)	6cyl.	5675cc	92kW (125PS)	Diesel	Turbo	TD16995
OM 353.960 (OM352)	6cyl.	5675cc	88kW (120PS)	Diesel		TD7980
OM 353.961 (OM352)	6cyl.	5675cc	96kW (130PS)	Diesel		TD7998
OM 353.962 (OM352)	6cyl.	5675cc	70kW (95PS)	Diesel		TD7978
OM 353.963 (OM352)	6cyl.	5675cc	96kW (130PS)	Diesel		TD5690
OM 353.964 (OM352)	6cyl.	5675cc	96kW (130PS)	Diesel		TD6284
OM 353.965 (OM352)	6cyl.	5675cc	96kW (130PS)	Diesel		TD5715
OM 353.966 (OM352)	6cyl.	5675cc	96kW (130PS)	Diesel		TD6027
OM 353.967 (OM352)	6cyl.	5675cc	74kW (101PS)	Diesel		TD16657
OM 353.968 (OM352)	6cyl.	5675cc	96kW (130PS)	Diesel		TD16658
OM 353.969 (OM352)	6cyl.	5675cc	96kW (130PS)	Diesel		TD16659
OM 353.980 (OM352)	6cyl.	5675cc	81kW (110PS)	Diesel		TD7996
OM 353.981 (OM352)	6cyl.	5675cc	96kW (130PS)	Diesel		TD6034
OM 353.982 (OM352)	6cyl.	5675cc	96kW (130PS)	Diesel		TD6048
OM 353.983 (OM352)	6cyl.	5675cc	96kW (130PS)	Diesel		TD17016
OM 353.984 (OM352)	6cyl.	5675cc	96kW (130PS)	Diesel		TD17017
OM 353.985 (OM352)	6cyl.	5675cc	70kW (95PS)	Diesel		TD17856
OM 353.989 (OM352)	6cyl.	5675cc	96kW (130PS)	Diesel		TD16663
OM 353.995 (OM352 A)	6cyl.	5675cc	92kW (125PS)	Diesel	Turbo	TD7999
AGL (RoundNose)			01/67→		T2/L	01/68→12/95
FPN (FlatNose)			07/87→07/97		T2/L Dump Truck L 608 D	02/84→12/88
LO			09/73→01/87		T2/L Dump Truck LKO 508 DG	09/72→06/88
LP			09/63→12/84		T2/L L 408 DG	01/70→12/74
MB-TRAC			07/73→12/91		T2/L L 508 DG	01/70→12/88
NG			08/73→09/96		T2/L L 608 D	01/70→12/88
O 302			11/64→11/75		T2/L L 613 D	04/77→12/88
O 309			01/70→02/89		T2/L LKO 508 DG	06/72→02/77
OF			01/83→		UNIMOG	01/62→









87-174300-00 STD
 87-174307-00 0.50mm ①
 87-174311-00 1.00mm ②

A 65.20
 B- 20.00
 BØ 55.00
 D 115.70
 36x83



RT

08-174300-10 STD ③
 08-174305-10 0.25mm ③
 08-174307-10 0.50mm ③
 08-174309-10 0.75mm ③
 08-174311-10 1.00mm ③
 08-174314-10 1.50mm ③

3.00  CR P
 3.00  P
 3.00  P
 5.50  CR P
 5.50  P

14-021850-00 D B 101.00 C 222.00 D 103.50 E 5.50
 14-025800-00 D B 100.40 C 222.00 D 103.50 E 5.20
 14-025801-00 D B 101.00 C 222.00 D 104.00 E 5.20
 14-025802-00 D B 102.00 C 222.00 D 105.00 E 5.20
 14-025804-00 D B 103.00 C 222.00 D 106.00 E 5.20
 14-025881-00 D B 101.50 C 222.00 D 104.50 E 4.75
 14-025883-00 D B 103.00 C 222.00 D 106.00 E 4.75

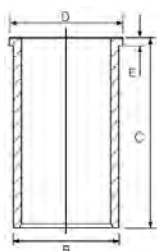



87-178800-00 STD
 87-178807-00 0.50mm ④
 87-178811-00 1.00mm ②

A 65.20
 B- 20.00
 BØ 55.00
 D 115.70
 36x83



RT

08-178800-00 STD
 08-178807-00 0.50mm
 08-178811-00 1.00mm

3.00  CR P
 3.00  P
 3.00  P
 5.50  CR P

① A = 64.800, D = 115.300
 ② A = 64.600, D = 115.100
 ③ For 5 ring piston
 ④ A = 64.900, D = 115.400

③ Für den Kolben mit 5 Ringen

③ Pour le piston de 5 anneaux

③ Para el pistón de 5 anillos

③ Per un pistone dei 5 anelli

97.00

45

OM 314.970	4cyl.	3784cc	63kW (85PS)	Diesel	Turbo	TD17852
OM 353.909 (OM352 A)	6cyl.	5675cc	124-125kW (168-170PS)	Diesel	Turbo	TD8091
OM 353.910 (OM352 A)	6cyl.	5675cc	124kW (168PS)	Diesel	Turbo	TD8162
OM 353.977 (OM352 A)	6cyl.	5675cc	124kW (169PS)	Diesel	Turbo	TD22744
OM 353.996 (OM352)	6cyl.	5675cc	51-96kW (69-131PS)	Diesel		TD28655
OM 362.906	6cyl.	5675cc	141kW (192PS)	Diesel	Turbo Intercooled	TD5750
OM 362.909	6cyl.	5675cc	141kW (192PS)	Diesel	Turbo Intercooled	TD6080
OM 362.910	6cyl.	5675cc	141kW (192PS)	Diesel	Turbo Intercooled	TD16699

AGL (RoundNose)
 MB-TRAC

11/85→06/97
 09/81→12/91

NG

08/73→09/96

14-012260-00 D B 100.40 C 224.00

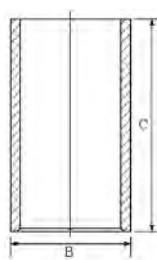



14-021850-00	D	B 101.00 C 222.00 D 103.50 E 5.50
14-025800-00	D	B 100.40 C 222.00 D 103.50 E 5.20
14-025801-00	D	B 101.00 C 222.00 D 104.00 E 5.20
14-025802-00	D	B 102.00 C 222.00 D 105.00 E 5.20
14-025804-00	D	B 103.00 C 222.00 D 106.00 E 5.20
14-025881-00	D	B 101.50 C 222.00 D 104.50 E 4.75
14-025883-00	D	B 103.00 C 222.00 D 106.00 E 4.75

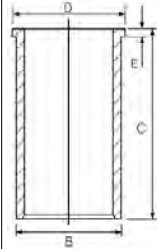

97.00							46
OM 352.913	6cyl.	5675cc	115kW (156PS)	Diesel	Turbo		TD16643
OM 352.916	6cyl.	5675cc	110-111kW (150-151PS)	Diesel	Turbo		TD7923
OM 352.918	6cyl.	5675cc	110kW (150PS)	Diesel	Turbo		TD16641
OM 352.937	6cyl.	5675cc	110kW (150PS)	Diesel	Turbo		TD16644
OM 352.946	6cyl.	5675cc	110kW (150PS)	Diesel	Turbo		TD16645
OM 352.949	6cyl.	5675cc	115kW (156PS)	Diesel	Turbo		TD16646
OM 352.950	6cyl.	5675cc	110kW (150PS)	Diesel	Turbo		TD16647
OM 352.968	6cyl.	5675cc	115kW (156PS)	Diesel	Turbo		TD16648
OM 352.988	6cyl.	5675cc	96kW (130PS)	Diesel	Turbo		TD16649
OM 352.994	6cyl.	5675cc	110kW (150PS)	Diesel	Turbo		TD16650
OM 353.911 (OM352 A)	6cyl.	5675cc	124kW (168PS)	Diesel	Turbo		TD8090
OM 353.912 (OM352 A)	6cyl.	5675cc	124kW (168PS)	Diesel	Turbo		TD8159
OM 353.913 (OM352 A)	6cyl.	5675cc	124kW (168PS)	Diesel	Turbo		TD8097
OM 353.914 (OM352 A)	6cyl.	5675cc	124kW (168PS)	Diesel	Turbo		TD16662
OM 353.950 (OM352 A)	6cyl.	5675cc	124kW (168PS)	Diesel	Turbo		TD5711
OM 353.951 (OM352 A)	6cyl.	5675cc	124kW (168PS)	Diesel	Turbo		TD5747
OM 353.952 (OM352 A)	6cyl.	5675cc	124kW (168PS)	Diesel	Turbo		TD6045
OM 353.953 (OM352 A)	6cyl.	5675cc	124kW (168PS)	Diesel	Turbo		TD6092
OM 353.954 (OM352 A)	6cyl.	5675cc	124kW (168PS)	Diesel	Turbo		TD8096
OM 353.958 (OM352/3)	6cyl.	5675cc	110kW (150PS)	Diesel	Turbo		TD7990
OM 353.959 (OM352 A)	6cyl.	5675cc	124kW (168PS)	Diesel	Turbo		TD8009
OM 353.970 (OM352 A)	6cyl.	5675cc	124kW (168PS)	Diesel	Turbo		TD5712
OM 353.971 (OM352 A)	6cyl.	5675cc	124kW (168PS)	Diesel	Turbo		TD6060
OM 353.972 (OM352 A)	6cyl.	5675cc	124kW (168PS)	Diesel	Turbo		TD16660
OM 353.973 (OM352 A)	6cyl.	5675cc	92kW (125PS)	Diesel	Turbo		TD7981
OM 353.974 (OM352 A)	6cyl.	5675cc	127kW (172PS)	Diesel	Turbo		TD16661
OM 353.975 (OM352 A)	6cyl.	5675cc	124kW (168PS)	Diesel	Turbo		TD6321
OM 353.976 (OM352 A)	6cyl.	5675cc	110kW (150PS)	Diesel	Turbo		TD17860
OM 353.978 (OM352 A)	6cyl.	5675cc	127kW (172PS)	Diesel	Turbo		TD16664
OM 353.991 (OM352 A)	6cyl.	5675cc	124kW (168PS)	Diesel	Turbo		TD16665
OM 353.997 (OM352 A)	6cyl.	5675cc	124kW (168PS)	Diesel	Turbo		TD16666
AGL (RoundNose)			01/74→03/99	NG			08/73→09/96
HPN (LongNose)			01/83→12/88	T2/L			01/72→12/95
LP			11/76→12/84	UNIMOG			01/77→09/88
MB-TRAC			07/80→12/87				





87-178200-20 STD
 87-178207-20 0.50mm
 87-178211-20 1.00mm

A 65.20
 B- 20.00
 BØ 55.00
 C 2.20
 D 105.20
 36x83



RT

08-178200-10 STD
 08-178207-10 0.50mm
 08-178211-10 1.00mm

2.50 CK P
 2.50mm CK P
 4.00 CR P

14-021850-00 D B 101.00 C 222.00 D 103.50 E 5.50
 14-025800-00 D B 100.40 C 222.00 D 103.50 E 5.20
 14-025801-00 D B 101.00 C 222.00 D 104.00 E 5.20
 14-025802-00 D B 102.00 C 222.00 D 105.00 E 5.20
 14-025804-00 D B 103.00 C 222.00 D 106.00 E 5.20
 14-025881-00 D B 101.50 C 222.00 D 104.50 E 4.75
 14-025883-00 D B 103.00 C 222.00 D 106.00 E 4.75

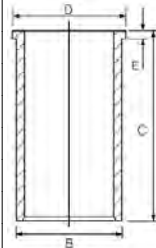

A = 64.900, D = 104.900
 A = 64.600, D = 104.600

97.50						47
OM 354.900 (Euro 2)	4cyl.	3972cc	77kW (105PS)	Diesel	Turbo Intercooled	TD8054
OM 354.901 (Euro 2 OM364 LA)	4cyl.	3972cc	77kW (105PS)	Diesel	Turbo Intercooled	TD8084
OM 354.902 (Euro 2 OM364 LA)	4cyl.	3972cc	77kW (105PS)	Diesel	Turbo Intercooled	TD5695
OM 354.903 (Euro 2 OM364 LA)	4cyl.	3972cc	77kW (105PS)	Diesel	Turbo Intercooled	TD8083
OM 354.920 (Euro 2 OM364 LA)	4cyl.	3972cc	103kW (140PS)	Diesel	Turbo Intercooled	TD8059
OM 354.921 (Euro 2 OM364 LA)	4cyl.	3972cc	103kW (140PS)	Diesel	Turbo Intercooled	TD8066
OM 354.922 (Euro 2 OM364 LA)	4cyl.	3972cc	103kW (140PS)	Diesel	Turbo Intercooled	TD8061
OM 354.923 (Euro 2 OM364 LA)	4cyl.	3972cc	103kW (140PS)	Diesel	Turbo Intercooled	TD8057
OM 354.924 (Euro 2 OM364 LA)	4cyl.	3972cc	103kW (140PS)	Diesel	Turbo Intercooled	TD8085
OM 354.925 (Euro 2 OM364 LA)	4cyl.	3972cc	103kW (140PS)	Diesel	Turbo Intercooled	TD8087
OM 354.926 (Euro 2)	4cyl.	3972cc	103kW (140PS)	Diesel	Turbo Intercooled	TD22745
OM 357.900 (OM366 LA)	6cyl.	5958cc	125kW (170PS)	Diesel	Turbo Intercooled	TD8069
OM 357.901 (OM366 LA)	6cyl.	5958cc	125kW (170PS)	Diesel	Turbo Intercooled	TD5708
OM 357.902 (OM366 LA)	6cyl.	5958cc	125kW (170PS)	Diesel	Turbo Intercooled	TD5740
OM 357.903 (OM366 LA)	6cyl.	5958cc	125kW (170PS)	Diesel	Turbo Intercooled	TD5742
OM 357.904 (OM366 LA)	6cyl.	5958cc	125kW (170PS)	Diesel	Turbo Intercooled	TD16528
OM 357.906 (OM366 LA)	6cyl.	5958cc	125kW (170PS)	Diesel	Turbo Intercooled	TD8095
OM 357.907 (OM366 LA)	6cyl.	5958cc	125kW (170PS)	Diesel	Turbo Intercooled	TD8138
OM 357.908 (OM366 LA)	6cyl.	5958cc	125kW (170PS)	Diesel	Turbo Intercooled	TD8074
OM 357.909 (OM366 LA)	6cyl.	5958cc	125kW (170PS)	Diesel	Turbo Intercooled	TD5706
OM 357.910 (OM366 LA)	6cyl.	5958cc	125kW (170PS)	Diesel	Turbo Intercooled	TD6041
OM 357.915 (OM366 LA)	6cyl.	5958cc	125kW (170PS)	Diesel	Turbo Intercooled	TD8147
OM 357.916 (OM366 LA)	6cyl.	5958cc	125kW (170PS)	Diesel	Turbo Intercooled	TD8075
OM 357.917 (OM366 LA)	6cyl.	5958cc	125kW (170PS)	Diesel	Turbo Intercooled	TD8079
OM 357.918 (OM366 LA)	6cyl.	5958cc	125kW (170PS)	Diesel	Turbo Intercooled	TD6043
OM 357.919 (OM366 LA)	6cyl.	5958cc	125kW (170PS)	Diesel	Turbo Intercooled	TD8106
OM 357.920 (OM366 LA)	6cyl.	5958cc	155kW (211PS)	Diesel	Turbo Intercooled	TD5720
OM 357.921 (OM366 LA)	6cyl.	5958cc	155kW (211PS)	Diesel	Turbo Intercooled	TD5743
OM 357.922 (OM366 LA)	6cyl.	5958cc	155kW (211PS)	Diesel	Turbo Intercooled	TD8166
OM 357.924 (Euro 2 OM366 LA)	6cyl.	5958cc	155kW (211PS)	Diesel	Turbo Intercooled	TD14688
OM 357.925 (OM366 LA)	6cyl.	5958cc	155kW (211PS)	Diesel	Turbo Intercooled	TD8196
OM 357.926 (OM366 LA)	6cyl.	5958cc	155kW (211PS)	Diesel	Turbo Intercooled	TD16931
OM 357.927 (OM366 LA)	6cyl.	5958cc	155kW (211PS)	Diesel	Turbo Intercooled	TD5723
OM 357.929 (OM366 LA)	6cyl.	5958cc	155kW (211PS)	Diesel	Turbo Intercooled	TD8113





OM 357.930 (OM366 LA)	6cyl.	5958cc	155kW (211PS)	Diesel	Turbo Intercooled	TD8168
OM 357.931 (Euro 2 OM366 LA)	6cyl.	5958cc	155kW (211PS)	Diesel	Turbo Intercooled	TD16820
OM 357.932 (OM366 LA)	6cyl.	5958cc	155kW (211PS)	Diesel	Turbo Intercooled	TD6056
OM 357.933 (OM366 LA)	6cyl.	5958cc	155kW (211PS)	Diesel	Turbo Intercooled	TD8115
OM 357.934 (OM366 LA)	6cyl.	5958cc	155kW (211PS)	Diesel	Turbo Intercooled	TD17097
OM 357.935 (OM366 LA)	6cyl.	5958cc	155kW (211PS)	Diesel	Turbo Intercooled	TD17098
OM 357.936 (Euro 2 OM366 LA)	6cyl.	5958cc	155kW (211PS)	Diesel	Turbo Intercooled	TD16821
OM 357.937 (Euro 2 OM366 LA)	6cyl.	5958cc	155kW (211PS)	Diesel	Turbo Intercooled	TD16822
OM 357.938 (Euro 2)	6cyl.	5958cc	155kW (211PS)	Diesel	Turbo Intercooled	TD22748
OM 357.940 (OM366 LA)	6cyl.	5958cc	177kW (240PS)	Diesel	Turbo Intercooled	TD5746
OM 357.941 (OM366 LA)	6cyl.	5958cc	177kW (240PS)	Diesel	Turbo Intercooled	TD8169
OM 357.942 (OM366 LA)	6cyl.	5958cc	177kW (240PS)	Diesel	Turbo Intercooled	TD8116
OM 357.943 (OM366 LA)	6cyl.	5958cc	177kW (240PS)	Diesel	Turbo Intercooled	TD5725
OM 357.944 (OM366 LA)	6cyl.	5958cc	177kW (240PS)	Diesel	Turbo Intercooled	TD6058
OM 357.945 (Euro 2 OM366 LA)	6cyl.	5958cc	177kW (241PS)	Diesel	Turbo Intercooled	TD14690
OM 357.946 (OM366 LA)	6cyl.	5958cc	177kW (240PS)	Diesel	Turbo Intercooled	TD8125
OM 357.947 (OM366 LA)	6cyl.	5958cc	177kW (240PS)	Diesel	Turbo Intercooled	TD8170
OM 357.948 (OM366 LA)	6cyl.	5958cc	177kW (240PS)	Diesel	Turbo Intercooled	TD6077
OM 357.949 (Euro 2 OM366 LA)	6cyl.	5958cc	177kW (240PS)	Diesel	Turbo Intercooled	TD16823
OM 357.961 (OM366 LA)	6cyl.	5958cc	125kW (170PS)	Diesel	Turbo Intercooled	TD6073
OM 357.962 (OM366 LA)	6cyl.	5958cc	125kW (170PS)	Diesel	Turbo Intercooled	TD6074
OM 357.963 (OM366 LA)	6cyl.	5958cc	125kW (170PS)	Diesel	Turbo Intercooled	TD6090
OM 364.901	4cyl.	3972cc	83kW (113PS)	Diesel	Turbo	TD21464
OM 366.956	6cyl.	5958cc	100kW (136PS)	Diesel	Turbo	TD6320
LK/LN2			01/84→12/05		T2/LN1 714 D	06/94→12/94
MK			12/87→09/96		T2/LN1 811 D	04/86→12/94
T2/LN1 609 D			06/94→12/94		T2/LN1 814 D	11/87→12/94
T2/LN1 611 D			06/94→12/94		T2/LN1 Dump Truck 611 DK	06/94→12/94
T2/LN1 711 D			04/86→12/94		UNIMOG	01/88→

87-740000-30 STD

A 63.00
B- 23.00
BØ 54.50
D 108.00
36x83



RT TP

08-740000-00 STD

08-740007-00 0.50mm

2.50 MOL P
2.50 CR P
4.00 CR P



14-012260-00 D

B 100.40 C 224.00

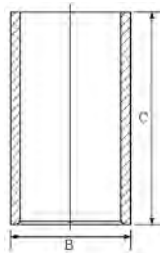

14-025800-00 D

B 100.40 C 222.00 D 103.50 E 5.20

14-025801-00 D

B 101.00 C 222.00 D 104.00 E 5.20

14-025802-00 D

B 102.00 C 222.00 D 105.00 E 5.20

14-025804-00 D

B 103.00 C 222.00 D 106.00 E 5.20

14-025881-00 D

B 101.50 C 222.00 D 104.50 E 4.75

14-025883-00 D

B 103.00 C 222.00 D 106.00 E 4.75

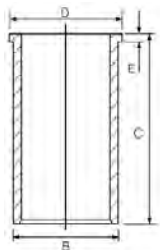

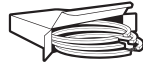

97.50							48
OM 356.981 (OM366 LA)	6cyl.	5958cc	127kW (170PS)	Diesel	Turbo Intercooled		TD8011
OM 364.906	4cyl.	3972cc	66kW (90PS)	Diesel			TD8048
OM 364.907	4cyl.	3970cc	66kW (90PS)	Diesel			TD8052
OM 364.908	4cyl.	3972cc	50kW (68PS)	Diesel			TD17853
OM 364.909	4cyl.	3972cc	50kW (68PS)	Diesel			TD17854
OM 364.911	4cyl.	3972cc	63-66kW (86-90PS)	Diesel			TD8081
OM 364.912	4cyl.	3972cc	66kW (90PS)	Diesel			TD16804
OM 364.913	4cyl.	3972cc	66kW (90PS)	Diesel			TD8044
OM 366.905	6cyl.	5958cc	100kW (136PS)	Diesel	Turbo Intercooled		TD5698
OM 366.906	6cyl.	5960cc	100kW (136PS)	Diesel			TD5748
OM 366.907	6cyl.	5958cc	100kW (136PS)	Diesel			TD5716
OM 366.908	6cyl.	5958cc	81kW (110PS)	Diesel			TD17858
OM 366.909	6cyl.	5960cc	100kW (136PS)	Diesel			TD6078
OM 366.910	6cyl.	5958cc	100kW (136PS)	Diesel			TD8065
OM 366.912	6cyl.	5958cc	74kW (100PS)	Diesel			TD17857
OM 366.913	6cyl.	5958cc	100kW (136PS)	Diesel			TD17100
OM 366.914	6cyl.	5958cc	100kW (136PS)	Diesel			TD6049
OM 366.917	6cyl.	5958cc	100kW (136PS)	Diesel			TD7887
OM 366.918	6cyl.	5960cc	100kW (136PS)	Diesel			TD5739
OM 366.919	6cyl.	5958cc	100kW (136PS)	Diesel			TD16808
OM 366.930	6cyl.	5958cc	100kW (136PS)	Diesel			TD8094
OM 366.931	6cyl.	5958cc	100kW (136PS)	Diesel			TD5717
OM 366.932	6cyl.	5958cc	100kW (136PS)	Diesel			TD8068
OM 366.933	6cyl.	5958cc	100kW (136PS)	Diesel			TD8100
OM 366.935	6cyl.	5958cc	100kW (136PS)	Diesel			TD6050
OM 366.936	6cyl.	5960cc	100kW (136PS)	Diesel			TD8135
OM 366.937	6cyl.	5960cc	100kW (136PS)	Diesel			TD6072
OM 366.938	6cyl.	5958cc	100kW (136PS)	Diesel			TD16809
OM 366.939	6cyl.	5958cc	81kW (110PS)	Diesel			TD7993
OM 366.940	6cyl.	5958cc	100kW (136PS)	Diesel			TD6040
OM 370.905 (OM364)	4cyl.	3972cc	66kW (90PS)	Diesel			TD28664
OM 370.952 (OM364 A)	4cyl.	3972cc	80kW (109PS)	Diesel	Turbo		TD28667
OM 372.906 (OM 366)	6cyl.	5958cc	100kW (136PS)	Diesel			TD23200
OM 372.907 (OM 366)	6cyl.	5958cc	100kW (136PS)	Diesel			TD23201
OM 372.930 (OM 366)	6cyl.	5958cc	100kW (136PS)	Diesel			TD23202
OM 376.905 (OM366)	6cyl.	5958cc	100kW (136PS)	Diesel			TD23006
OM 376.906 (OM366)	6cyl.	5958cc	100kW (136PS)	Diesel			TD23009
OM 376.907 (OM366)	6cyl.	5958cc	100kW (136PS)	Diesel			TD23011
OM 376.908 (OM366)	6cyl.	5958cc	95kW (129PS)	Diesel			TD23010
OM 376.909 (OM366)	6cyl.	5958cc	95kW (129PS)	Diesel			TD23012
OM 376.930 (OM366)	6cyl.	5958cc	100kW (136PS)	Diesel			TD23014
OM 376.980 (OM366 LA MBTC-USA)	6cyl.	5958cc	127kW (173PS)	Diesel	Turbo Intercooled		TD23040
OM 376.981 (OM366 LA MBTC-USA)	6cyl.	5958cc	142kW (193PS)	Diesel	Turbo Intercooled		TD23041
OM 376.982 (OM366 LA MBTC-USA)	6cyl.	5958cc	142kW (193PS)	Diesel	Turbo Intercooled		TD23042
OM 376.987 (OM366 LA MBTC-USA)	6cyl.	5958cc	127kW (173PS)	Diesel	Turbo Intercooled		TD23045
OM 376.988 (OM366 LA MBTC-USA)	6cyl.	5958cc	142kW (193PS)	Diesel	Turbo Intercooled		TD23046
OM 376.989 (OM366 LA MBTC-USA)	6cyl.	5958cc	142kW (193PS)	Diesel	Turbo Intercooled		TD23047
OM 376.998 (OM366 LA MBTC-USA)	6cyl.	5958cc	134kW (182PS)	Diesel	Turbo Intercooled		TD23048
OM 376.999 (OM366 LA MBTC-USA)	6cyl.	5958cc	134kW (182PS)	Diesel	Turbo Intercooled		TD23049
OM 382.912	6cyl.	5958cc	100kW (136PS)	Diesel			TD22783
OM 384.906	4cyl.	3972cc	66-100kW (90-137PS)	Diesel	Turbo		TD23199





B-Series	07/84→	T2/LN1 609 D	04/86→12/94
FPN (FlatNose)	12/85→12/01	T2/LN1 709 D	04/86→12/94
HPN (LongNose)	04/89→02/01	T2/LN1 809 D	04/86→12/94
LK/LN2	01/84→12/05	T2/LN1 Cab with engine 809 DT	04/86→12/94
MB-TRAC	02/87→12/91	T2/LN1 Dump Truck 609 DK	04/86→12/94
NG	04/84→03/91	T2/LN1 Dump Truck 709 DK	04/86→12/94
O 301	06/86→05/87	T2/LN1 Dump Truck 809 DK	04/86→12/94
O 402	02/86→12/91	T2/LN1 O 609 D	07/87→12/92
OF	01/83→	UNIMOG	09/88→

87-740000-40 STD
87-740007-40 0.50mm

A 62.80
B- 22.70
BØ 48.00
D 107.80
 36x82



RT

08-740000-10 STD
08-740007-10 0.50mm

2.50 CK P
 2.50 CR P
 4.00 CR P

14-012260-00 D **B** 100.40 **C** 224.00

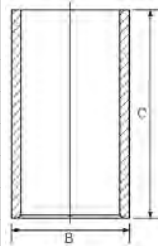

14-025800-00 D **B** 100.40 **C** 222.00 **D** 103.50 **E** 5.20
14-025801-00 D **B** 101.00 **C** 222.00 **D** 104.00 **E** 5.20
14-025802-00 D **B** 102.00 **C** 222.00 **D** 105.00 **E** 5.20
14-025804-00 D **B** 103.00 **C** 222.00 **D** 106.00 **E** 5.20
14-025881-00 D **B** 101.50 **C** 222.00 **D** 104.50 **E** 4.75
14-025883-00 D **B** 103.00 **C** 222.00 **D** 106.00 **E** 4.75

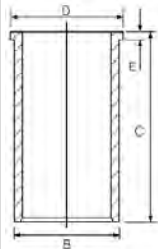

A = 62.500, D = 107.500

97.50						49
OM 356.901 (Euro 1 OM366)	6cyl.	5958cc	95kW (129PS)	Diesel		TD5704
OM 356.902 (Euro 1 OM366)	6cyl.	5958cc	95kW (129PS)	Diesel		TD8064
OM 356.903 (Euro 1 OM366)	6cyl.	5958cc	95kW (129PS)	Diesel		TD8093
OM 356.904 (Euro 1 OM366)	6cyl.	5958cc	95kW (129PS)	Diesel		TD8098
OM 356.905 (Euro 1 OM366)	6cyl.	5958cc	95kW (129PS)	Diesel		TD8062
OM 356.906 (Euro 1 OM366)	6cyl.	5958cc	95kW (129PS)	Diesel		TD8067
OM 356.907 (Euro 1 OM366)	6cyl.	5958cc	95kW (129PS)	Diesel		TD8099
OM 356.908 (Euro 1 OM366)	6cyl.	5958cc	95kW (129PS)	Diesel		TD8134
OM 356.909 (Euro 1 OM366)	6cyl.	5958cc	95kW (129PS)	Diesel		TD8133
OM 356.910 (Euro 1 OM366)	6cyl.	5958cc	95kW (129PS)	Diesel		TD8132
OM 356.911 (Euro 1 OM366)	6cyl.	5958cc	95kW (129PS)	Diesel		TD6039
OM 356.913 (Euro 1 OM366)	6cyl.	5958cc	100kW (136PS)	Diesel		TD16810
OM 356.914 (Euro 1 OM366)	6cyl.	5958cc	75kW (102PS)	Diesel		TD7994
OM 356.915 (Euro 1 OM366)	6cyl.	5958cc	97kW (132PS)	Diesel		TD16811
OM 356.916 (Euro 1 OM366)	6cyl.	5958cc	97kW (132PS)	Diesel		TD17096
OM 364.918	4cyl.	3970cc	63kW (86PS)	Diesel		TD8053
OM 364.919	4cyl.	3972cc	63kW (86PS)	Diesel		TD5692





OM 364.920	4cyl.	3972cc	63kW (86PS)	Diesel	TD8082
OM 364.921 (Euro 1)	4cyl.	3972cc	63kW (86PS)	Diesel	TD6029
LK/LN2			01/84→12/98	T2/LN1 Dump Truck 609 DK	04/86→12/94
T2/LN1 609 D			04/86→12/94	T2/LN1 Dump Truck 709 DK	04/86→12/94
T2/LN1 709 D			04/86→12/94	T2/LN1 Dump Truck 809 DK	04/86→12/94
T2/LN1 809 D			04/86→12/94	UNIMOG	01/88→

14-012260-00 *D* **B 100.40 C 224.00**

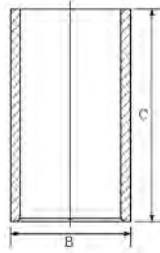

14-021850-00 *D* **B 101.00 C 222.00 D 103.50 E 5.50**
14-025800-00 *D* **B 100.40 C 222.00 D 103.50 E 5.20**
14-025801-00 *D* **B 101.00 C 222.00 D 104.00 E 5.20**
14-025802-00 *D* **B 102.00 C 222.00 D 105.00 E 5.20**
14-025804-00 *D* **B 103.00 C 222.00 D 106.00 E 5.20**
14-025881-00 *D* **B 101.50 C 222.00 D 104.50 E 4.75**
14-025883-00 *D* **B 103.00 C 222.00 D 106.00 E 4.75**

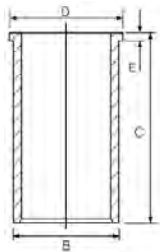

97.50					50
OM 356.940 (Euro 1 OM366 A)	6cyl.	5958cc	129kW (175PS)	Diesel Turbo	TD6098
OM 356.984 (OM366 LA)	6cyl.	5958cc	155kW (211PS)	Diesel Turbo Intercooled	TD8148
OM 356.985 (OM366 LA)	6cyl.	5958cc	150kW (204PS)	Diesel Turbo Intercooled	TD8189
OM 364.950	4cyl.	3972cc	85kW (115PS)	Diesel Turbo	TD5696
OM 364.951	4cyl.	3972cc	66kW (90PS)	Diesel Turbo	TD17855
OM 364.952	4cyl.	3972cc	85kW (115PS)	Diesel Turbo	TD6033
OM 364.954	4cyl.	3972cc	85kW (115PS)	Diesel Turbo	TD8045
OM 364.980	4cyl.	3972cc	100kW (136PS)	Diesel Turbo Intercooled	TD8047
OM 364.981	4cyl.	3972cc	100kW (136PS)	Diesel Turbo Intercooled	TD8086
OM 364.984	4cyl.	3972cc	100kW (136PS)	Diesel Turbo Intercooled	TD8088
OM 366.944	6cyl.	5958cc	125kW (170PS)	Diesel Turbo	TD5703
OM 366.945	6cyl.	5958cc	125kW (170PS)	Diesel Turbo	TD5757
OM 366.946	6cyl.	5960cc	125kW (170PS)	Diesel Turbo	TD5741
OM 366.947	6cyl.	5958cc	100kW (136PS)	Diesel Turbo	TD5679
OM 366.948	6cyl.	5958cc	100-115kW (136-156PS)	Diesel Turbo	TD6017
OM 366.949	6cyl.	5958cc	92-115kW (125-156PS)	Diesel Turbo	TD6277
OM 366.951	6cyl.	5960cc	125kW (170PS)	Diesel Turbo	TD5749
OM 366.952	6cyl.	5958cc	116-129kW (158-175PS)	Diesel Turbo	TD5766
OM 366.953	6cyl.	5958cc	125kW (170PS)	Diesel Turbo	TD5718
OM 366.954	6cyl.	5958cc	115-132kW (156-180PS)	Diesel Turbo	TD17862



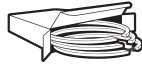

OM 366.955	6cyl.	5958cc	100kW (136PS)	Diesel	Turbo	TD6276
OM 366.957	6cyl.	5958cc	125kW (170PS)	Diesel	Turbo	TD16816
OM 366.958	6cyl.	5958cc	100kW (136PS)	Diesel	Turbo	TD17861
OM 366.960	6cyl.	5960cc	125kW (170PS)	Diesel	Turbo	TD17101
OM 366.962	6cyl.	5960cc	125kW (170PS)	Diesel	Turbo	TD5745
OM 366.963	6cyl.	5958cc	125kW (170PS)	Diesel	Turbo	TD8006
OM 366.965	6cyl.	5958cc	125kW (170PS)	Diesel	Turbo	TD7888
OM 366.966	6cyl.	5958cc	125kW (170PS)	Diesel	Turbo	TD5707
OM 366.967	6cyl.	5958cc	125kW (170PS)	Diesel	Turbo	TD5699
OM 366.968	6cyl.	5958cc	125kW (170PS)	Diesel	Turbo	TD8077
OM 366.969	6cyl.	5958cc	125kW (170PS)	Diesel	Turbo	TD8080
OM 366.970	6cyl.	5958cc	125kW (170PS)	Diesel	Turbo	TD8104
OM 366.971	6cyl.	5958cc	125kW (170PS)	Diesel	Turbo	TD8107
OM 366.972	6cyl.	5958cc	125kW (170PS)	Diesel	Turbo	TD17112
OM 366.973	6cyl.	5958cc	125kW (170PS)	Diesel	Turbo	TD6035
OM 366.974	6cyl.	5958cc	125kW (170PS)	Diesel	Turbo	TD6042
OM 366.975	6cyl.	5958cc	125kW (170PS)	Diesel	Turbo	TD5719
OM 366.976	6cyl.	5958cc	125kW (170PS)	Diesel	Turbo	TD6052
OM 366.977	6cyl.	5958cc	92kW (125PS)	Diesel	Turbo	TD17859
OM 366.978	6cyl.	5958cc	125kW (170PS)	Diesel	Turbo	TD6279
OM 366.979	6cyl.	5958cc	125kW (170PS)	Diesel	Turbo	TD6091
OM 366.980	6cyl.	5960cc	148kW (201PS)	Diesel	Turbo Intercooled	TD8141
OM 366.981	6cyl.	5958cc	148kW (201PS)	Diesel	Turbo Intercooled	TD16817
OM 366.983	6cyl.	5958cc	150kW (204PS)	Diesel	Turbo Intercooled	TD8150
OM 366.984	6cyl.	5958cc	150-157kW (204-214PS)	Diesel	Turbo Intercooled	TD8007
OM 366.988	6cyl.	5960cc	148-150kW (201-204PS)	Diesel	Turbo Intercooled	TD5744
OM 366.990	6cyl.	5958cc	150kW (204PS)	Diesel	Turbo Intercooled	TD16818
OM 366.992	6cyl.	5958cc	150kW (204PS)	Diesel	Turbo Intercooled	TD5722
OM 366.993	6cyl.	5958cc	150kW (204PS)	Diesel	Turbo Intercooled	TD8114
OM 366.994	6cyl.	5958cc	150kW (204PS)	Diesel	Turbo Intercooled	TD6055
OM 366.995	6cyl.	5958cc	150kW (204PS)	Diesel	Turbo Intercooled	TD8167
OM 366.996	6cyl.	5958cc	150kW (204PS)	Diesel	Turbo Intercooled	TD16819
OM 366.997 (Euro 1)	6cyl.	5960cc	148-150kW (201-204PS)	Diesel	Turbo Intercooled	TD6075
OM 370.950 (OM364 A)	4cyl.	3972cc	85kW (116PS)	Diesel	Turbo	TD28665
OM 370.951 (OM364 A)	4cyl.	3972cc	85kW (116PS)	Diesel	Turbo	TD28666
OM 372.950 (OM364 A)	6cyl.	5958cc	125kW (170PS)	Diesel	Turbo	TD28669
OM 372.951 (OM364 A)	6cyl.	5958cc	125kW (170PS)	Diesel	Turbo	TD28671
OM 372.953 (OM364 A)	6cyl.	5958cc	100kW (136PS)	Diesel	Turbo	TD28672
OM 372.956 (OM364 A)	6cyl.	5958cc	125-135kW (170-184PS)	Diesel	Turbo	TD28673
OM 372.958 (OM364 A)	6cyl.	5958cc	125kW (170PS)	Diesel	Turbo	TD28674
OM 372.980 (OM364 LA)	6cyl.	5958cc	150kW (204PS)	Diesel	Turbo Intercooled	TD28680
OM 372.981 (OM364 LA)	6cyl.	5958cc	150kW (204PS)	Diesel	Turbo Intercooled	TD28681
OM 376.941 (OM366 LA)	6cyl.	5958cc	150kW (204PS)	Diesel	Turbo Intercooled	TD23015
OM 376.945 (OM366 A)	6cyl.	5958cc	125-135kW (170-184PS)	Diesel	Turbo Intercooled	TD23016
OM 376.946 (OM366 A)	6cyl.	5958cc	131-135kW (178-184PS)	Diesel	Turbo Intercooled	TD23017
OM 376.947 (OM366 A)	6cyl.	5958cc	131kW (178PS)	Diesel	Turbo Intercooled	TD23018
OM 376.950 (OM366 A)	6cyl.	5958cc	125kW (170PS)	Diesel	Turbo Intercooled	TD23019
OM 376.951 (OM366 A)	6cyl.	5958cc	125kW (170PS)	Diesel	Turbo Intercooled	TD23020
OM 376.953 (OM366 A)	6cyl.	5958cc	125kW (170PS)	Diesel	Turbo Intercooled	TD23022
OM 376.954 (OM366 A)	6cyl.	5958cc	125kW (170PS)	Diesel	Turbo Intercooled	TD23023





OM 376.955 (OM366 A)	6cyl.	5958cc	125-135kW (170-184PS)	Diesel	Turbo	TD23024
OM 376.956 (OM366 A)	6cyl.	5958cc	125-135kW (170-184PS)	Diesel	Turbo Intercooled	TD23025
OM 376.957 (OM366 A)	6cyl.	5958cc	125kW (170PS)	Diesel	Turbo Intercooled	TD23026
OM 376.958 (OM366 A)	6cyl.	5958cc	125-135kW (170-184PS)	Diesel	Turbo Intercooled	TD23027
OM 376.961 (OM366 A)	6cyl.	5958cc	125kW (170PS)	Diesel	Turbo Intercooled	TD23028
OM 376.962 (OM366 A)	6cyl.	5958cc	125-135kW (170-184PS)	Diesel	Turbo	TD23029
OM 376.963 (OM366 LA)	6cyl.	5958cc	125kW (170PS)	Diesel	Turbo Intercooled	TD23030
OM 376.964 (OM366 A)	6cyl.	5958cc	125kW (170PS)	Diesel	Turbo Intercooled	TD23031
OM 380.942	4cyl.	3972cc	85kW (116PS)	Diesel	Turbo	TD22777
OM 382.913	6cyl.	5958cc	125kW (170PS)	Diesel	Turbo	TD22784
OM 382.919	6cyl.	5958cc	150kW (204PS)	Diesel	Turbo	TD22785
OM 382.971	6cyl.	5958cc	150kW (204PS)	Diesel	Turbo	TD22787
OM 384.907	4cyl.	3972cc	85kW (116PS)	Diesel	Turbo	TD22788
OM 386.950	6cyl.	5958cc	125kW (170PS)	Diesel	Turbo	TD22794
OM 386.951	6cyl.	5958cc	125kW (170PS)	Diesel	Turbo	TD22795
OM 386.952	6cyl.	5958cc	125kW (170PS)	Diesel	Turbo	TD22796
OM 386.980	6cyl.	5958cc	150kW (204PS)	Diesel	Turbo Intercooled	TD22797
OM 386.981	6cyl.	5958cc	150kW (204PS)	Diesel	Turbo Intercooled	TD22798
OM 386.983	6cyl.	5958cc	150kW (204PS)	Diesel	Turbo Intercooled	TD22799

AGL (RoundNose)	03/84→05/00	OF	01/83→
FPN (FlatNose)	01/89→04/99	OH	01/70→
HPN (LongNose)	04/89→12/05	T2/LN1 711 D	04/86→12/94
LK/LN2	01/84→12/98	T2/LN1 811 D	04/86→12/94
MB-TRAC	02/82→12/91	T2/LN1 814 D	11/87→12/94
MK	12/87→09/96	T2/LN1 814 DA	11/87→12/94
NG	08/73→09/96	T2/LN1 Dump Truck 811 DK	04/86→12/94
O 301	02/86→05/87	T2/LN1 O 611 D	07/87→12/92
O 371	01/91→12/02	T2/LN1 O 614 D	07/87→12/92
O 402	02/86→12/91	UNIMOG	01/88→

87-740000-50 STD
87-740007-50 0.50mm

A 62.80
B- 22.35
BØ 55.50
D 107.80
 **36x82**



RT

08-740000-10 STD
08-740007-10 0.50mm

2.50  CK P
 2.50  CR P
 4.00  CR P

14-012260-00 D **B** 100.40 **C** 224.00

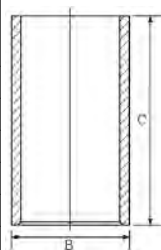

14-025800-00 D **B** 100.40 **C** 222.00 **D** 103.50 **E** 5.20
14-025801-00 D **B** 101.00 **C** 222.00 **D** 104.00 **E** 5.20
14-025802-00 D **B** 102.00 **C** 222.00 **D** 105.00 **E** 5.20
14-025804-00 D **B** 103.00 **C** 222.00 **D** 106.00 **E** 5.20
14-025881-00 D **B** 101.50 **C** 222.00 **D** 104.50 **E** 4.75
14-025883-00 D **B** 103.00 **C** 222.00 **D** 106.00 **E** 4.75

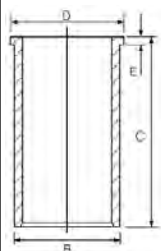



97.50

51

OM 356.941 (Euro 1 OM366 A)	6cyl.	5958cc	116kW (158PS)	Diesel	Turbo	TD5705
OM 356.943 (Euro 1 OM366 A)	6cyl.	5958cc	121kW (165PS)	Diesel	Turbo	TD8146
OM 356.944 (Euro 1 OM366 A)	6cyl.	5958cc	116kW (158PS)	Diesel	Turbo	TD8136
OM 356.945 (Euro 1 OM366 A)	6cyl.	5958cc	116kW (158PS)	Diesel	Turbo	TD8137
OM 356.946 (Euro 1 OM366 A)	6cyl.	5958cc	116kW (158PS)	Diesel	Turbo	TD5756
OM 356.947 (Euro 1 OM366 A)	6cyl.	5958cc	116kW (158PS)	Diesel	Turbo	TD8103
OM 356.948 (Euro 1 OM366 A)	6cyl.	5958cc	116kW (158PS)	Diesel	Turbo	TD8078
OM 356.949 (Euro 1 OM366 A)	6cyl.	5958cc	116kW (158PS)	Diesel	Turbo	TD8105
OM 356.951 (Euro 1 OM366 A)	6cyl.	5958cc	116kW (158PS)	Diesel	Turbo	TD8073
OM 356.952 (Euro 1 OM366 A)	6cyl.	5958cc	116kW (158PS)	Diesel	Turbo	TD16941
OM 356.953 (Euro 1 OM366 A)	6cyl.	5958cc	116kW (158PS)	Diesel	Turbo	TD6089
OM 356.956 (Euro 1 OM366 A)	6cyl.	5958cc	114-115kW (155-156PS)	Diesel	Turbo	TD6018
OM 356.958 (Euro 1 OM366 A)	6cyl.	5958cc	116kW (158PS)	Diesel	Turbo	TD16812
OM 356.959 (Euro 1 OM366 A)	6cyl.	5958cc	121kW (165PS)	Diesel	Turbo	TD16813
OM 364.957	4cyl.	3972cc	77kW (105PS)	Diesel	Turbo	TD5693
OM 364.958	4cyl.	3972cc	77kW (105PS)	Diesel	Turbo	TD6030
OM 364.959 (Euro 1)	4cyl.	3972cc	77kW (105PS)	Diesel	Turbo	TD22773
OM 366.901	6cyl.	5958cc	135-136kW (184-185PS)	Diesel	Turbo	TD28662
OM 366.941 (Euro 1)	6cyl.	5958cc	116kW (158PS)	Diesel	Turbo	TD8102
OM 366.942 (Euro 1)	6cyl.	5958cc	121kW (165PS)	Diesel	Turbo	TD8076
OM 366.943 (Euro 1)	6cyl.	5958cc	116kW (158PS)	Diesel	Turbo	TD8070

LK/LN2	01/84→12/98	T2/LN1 711 D	04/86→12/94
MK	07/89→09/96	T2/LN1 811 D	04/86→12/94
OH	01/70→	UNIMOG	01/88→

87-740000-10 STD
87-740007-10 0.50mm

A 62.80
B- 23.00
BØ 54.30
D 107.80
 36x83

RT



08-740000-10 STD
08-740007-10 0.50mm

2.50 CK P
2.50 CR P
4.00 CR P

14-012260-00 D B 100.40 C 224.00

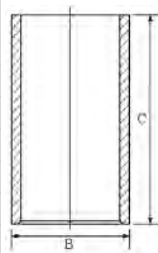

14-025800-00 D B 100.40 C 222.00 D 103.50 E 5.20
14-025801-00 D B 101.00 C 222.00 D 104.00 E 5.20
14-025802-00 D B 102.00 C 222.00 D 105.00 E 5.20
14-025804-00 D B 103.00 C 222.00 D 106.00 E 5.20
14-025881-00 D B 101.50 C 222.00 D 104.50 E 4.75
14-025883-00 D B 103.00 C 222.00 D 106.00 E 4.75

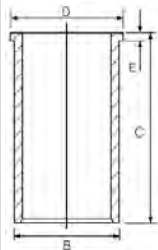

A = 62.500, D = 107.500

97.50

52

OM 356.977 (Euro 1 OM366 LA)	6cyl.	5958cc	177kW (240PS)	Diesel	Turbo Intercooled	TD16814
OM 356.978 (Euro 1 OM366 LA)	6cyl.	5958cc	155kW (211PS)	Diesel	Turbo Intercooled	TD16815





OM 356.979 (OM366 LA)	6cyl.	5958cc	177kW (240PS)	Diesel	Turbo Intercooled	TD5726
OM 356.980 (OM366 LA)	6cyl.	5958cc	177kW (240PS)	Diesel	Turbo Intercooled	TD8005
OM 356.983 (Euro 1 OM366 LA)	6cyl.	5958cc	177kW (240PS)	Diesel	Turbo Intercooled	TD5724
OM 356.986 (OM366 LA)	6cyl.	5958cc	155kW (211PS)	Diesel	Turbo Intercooled	TD8108
OM 356.987 (Euro 1 OM366 LA)	6cyl.	5958cc	155kW (211PS)	Diesel	Turbo Intercooled	TD8149
OM 356.988 (Euro 1)	6cyl.	5958cc	177kW (241PS)	Diesel	Turbo Intercooled	TD22747
OM 356.989 (OM366 LA)	6cyl.	5958cc	177kW (240PS)	Diesel	Turbo Intercooled	TD6057
OM 356.990 (OM366 LA)	6cyl.	5958cc	155kW (211PS)	Diesel	Turbo Intercooled	TD8165
OM 356.991 (OM366 LA)	6cyl.	5958cc	177kW (240PS)	Diesel	Turbo Intercooled	TD6282
OM 356.992 (OM366 LA)	6cyl.	5958cc	155kW (211PS)	Diesel	Turbo Intercooled	TD8140
OM 356.993 (OM366 LA)	6cyl.	5958cc	155kW (211PS)	Diesel	Turbo Intercooled	TD8112
OM 356.994 (OM366 LA)	6cyl.	5958cc	155kW (211PS)	Diesel	Turbo Intercooled	TD5721
OM 356.995 (OM366 LA)	6cyl.	5958cc	155kW (211PS)	Diesel	Turbo Intercooled	TD6054
OM 356.996 (OM366 LA)	6cyl.	5958cc	155kW (211PS)	Diesel	Turbo Intercooled	TD8110
OM 356.997 (OM366 LA)	6cyl.	5958cc	157kW (214PS)	Diesel	Turbo Intercooled	TD5681
OM 356.998 (OM366 LA)	6cyl.	5958cc	132kW (180PS)	Diesel	Turbo Intercooled	TD6019
OM 356.999 (OM366 LA)	6cyl.	5958cc	177kW (240PS)	Diesel	Turbo Intercooled	TD8124
OM 364.985	4cyl.	3972cc	100-103kW (136-140PS)	Diesel	Turbo Intercooled	TD8017
OM 364.987	4cyl.	3972cc	100kW (136PS)	Diesel	Turbo Intercooled	TD6031
OM 366.999 (Euro 1)	6cyl.	5958cc	170kW (231PS)	Diesel	Turbo Intercooled	TD8126

LK/LN2	01/84→12/98	T2/LN1 814 DA	11/87→12/94
MK	12/87→09/96	UNIMOG	05/88→

87-740000-20 STD
87-740007-20 0.50mm

A 62.80
B- 22.60
BØ 54.65
D 107.80
 36x83

RT TP

08-740000-10 STD
08-740007-10 0.50mm

2.50 CK P
2.50 CR P
4.00 CR P

14-012260-00 D B 100.40 C 224.00

14-025800-00 D B 100.40 C 222.00 D 103.50 E 5.20
14-025801-00 D B 101.00 C 222.00 D 104.00 E 5.20
14-025802-00 D B 102.00 C 222.00 D 105.00 E 5.20
14-025804-00 D B 103.00 C 222.00 D 106.00 E 5.20
14-025881-00 D B 101.50 C 222.00 D 104.50 E 4.75
14-025883-00 D B 103.00 C 222.00 D 106.00 E 4.75

A = 62.500, D = 107.500

102.00							53
OM 900.911 (Euro 4 OM904 LA)	4cyl.	4249cc	95kW (129PS)	Diesel	Turbo Intercooled	TD18918	
OM 900.912 (Euro 4 OM904 LA)	4cyl.	4249cc	115kW (156PS)	Diesel	Turbo Intercooled	TD18919	
OM 900.913 (Euro 4 OM904 LA)	4cyl.	4249cc	130kW (177PS)	Diesel	Turbo Intercooled	TD18920	





OM 900.915 (Euro 4 OM904 LA)	4cyl.	4249cc	110-115kW (150-156PS)	Diesel	Turbo Intercooled	TD23299
OM 900.916 (Euro 4 OM904 LA)	4cyl.	4249cc	110-115kW (150-156PS)	Diesel	Turbo Intercooled	TD23300
OM 900.917 (Euro 4 OM904 LA)	4cyl.	4249cc	95kW (129PS)	Diesel	Turbo Intercooled	TD18921
OM 900.918 (Euro 4 OM904 LA)	4cyl.	4249cc	115kW (156PS)	Diesel	Turbo Intercooled	TD18922
OM 900.919 (Euro 4 OM904 LA)	4cyl.	4249cc	130kW (177PS)	Diesel	Turbo Intercooled	TD18923
OM 900.920 (Euro 4 OM904 LA)	4cyl.	4249cc	115kW (156PS)	Diesel	Turbo Intercooled	TD22696
OM 900.921 (Euro 4 OM904 LA)	4cyl.	4249cc	130kW (177PS)	Diesel	Turbo Intercooled	TD22697
OM 900.922 (Euro 4 OM904 LA)	4cyl.	4249cc	95kW (129PS)	Diesel	Turbo Intercooled	TD22698
OM 902.910 (Euro 4 OM906 LA)	6cyl.	6374cc	187kW (250PS)	Diesel	Turbo Intercooled	TD20244
OM 902.911 (Euro 4 OM906 LA)	6cyl.	6374cc	172kW (230PS)	Diesel	Turbo Intercooled	TD20247
OM 902.913 (Euro 4 OM906 LA)	6cyl.	6374cc	175kW (238PS)	Diesel	Turbo Intercooled	TD20250
OM 902.914 (Euro 4 OM906 LA)	6cyl.	6374cc	188kW (256PS)	Diesel	Turbo Intercooled	TD20251
OM 902.915 (Euro 4 OM906 LA)	6cyl.	6374cc	210kW (286PS)	Diesel	Turbo Intercooled	TD20252
OM 902.916 (Euro 4 OM906 LA)	6cyl.	6374cc	175kW (238PS)	Diesel	Turbo Intercooled	TD18924
OM 902.917 (Euro 4 OM906 LA)	6cyl.	6374cc	188kW (256PS)	Diesel	Turbo Intercooled	TD18930
OM 902.918 (Euro 4 OM906 LA)	6cyl.	6374cc	210kW (286PS)	Diesel	Turbo Intercooled	TD18931
OM 902.919 (Euro 4 OM906 LA)	6cyl.	6374cc	157-172kW (213-234PS)	Diesel	Turbo Intercooled	TD20253
OM 902.920 (Euro 4 OM906 LA)	6cyl.	6374cc	172kW (230PS)	Diesel	Turbo Intercooled	TD20254
OM 902.921 (Euro 4 OM906 LA)	6cyl.	6374cc	194kW (264PS)	Diesel	Turbo Intercooled	TD20255
OM 902.922 (Euro 4 OM906 LA)	6cyl.	6374cc	142kW (190PS)	Diesel	Turbo Intercooled	TD20256
OM 902.923 (Euro 4 OM906 LA)	6cyl.	6374cc	175kW (238PS)	Diesel	Turbo Intercooled	TD23293
OM 902.924 (Euro 4 OM906 LA)	6cyl.	6374cc	210kW (286PS)	Diesel	Turbo Intercooled	TD23294
OM 902.925 (Euro 4 OM906 LA)	6cyl.	6374cc	210kW (286PS)	Diesel	Turbo Intercooled	TD23295
OM 902.926 (Euro 4 OM906 hLA)	6cyl.	6374cc	210kW (286PS)	Diesel	Turbo Intercooled	TD23296
OM 902.927 (Euro 4 OM906 LA)	6cyl.	6374cc	210kW (286PS)	Diesel	Turbo Intercooled	TD20257
OM 902.930 (Euro 4 OM906 LA)	6cyl.	6374cc	175kW (238PS)	Diesel	Turbo Intercooled	TD20258
OM 902.931 (Euro 4 OM906 LA)	6cyl.	6374cc	188kW (256PS)	Diesel	Turbo Intercooled	TD20259
OM 902.932 (Euro 4 OM906 LA)	6cyl.	6374cc	210kW (286PS)	Diesel	Turbo Intercooled	TD20260
OM 902.933 (Euro 4 OM906 LA)	6cyl.	6374cc	175kW (238PS)	Diesel	Turbo Intercooled	TD20261
OM 902.934 (Euro 4 OM906 hLA)	6cyl.	6374cc	210kW (286PS)	Diesel	Turbo Intercooled	TD23297
OM 902.936 (Euro 4 OM906 LA)	6cyl.	6374cc	210kW (286PS)	Diesel	Turbo Intercooled	TD23298
ATEGO			01/98→10/04		VARIO 813 D, 814 D	09/96→12/13
ATEGO 2			10/04→		VARIO 815 D, 816 D	09/96→12/13
AXOR 2			10/04→		VARIO 818 D	09/06→
CITARO (O 530)			01/98→		VARIO Cab with engine 613 D, 614 D	01/06→12/13
CONECTO (O 345)			11/01→		VARIO Cab with engine 615 D, 616 D	01/06→12/13
ECONIC			03/98→		VARIO Cab with engine 618 D	09/06→12/13
HEAVY-DUTY			09/12→		VARIO Dump Truck 613 D, 614 D	09/96→12/13
OMC			02/06→		VARIO Dump Truck 615 D, 616 D	09/98→
Series 400			01/05→		VARIO Dump Truck 618 D	09/06→
SOLO			05/08→		VARIO Dump Truck 813 D, 814 D	09/96→12/13
SOLO SR			10/07→		VARIO Dump Truck 815 D, 816 D	09/96→12/13
TORO			01/08→		VARIO Dump Truck 818 D	09/06→
UNIMOG			08/02→		VARIO O 813	01/06→12/13
VARIO 613 D, 614 D			09/96→12/13		VARIO O 816 D	01/06→12/13
VARIO 615 D, 616 D			09/98→		VARIO O 818 D	09/06→
VARIO 618 D			09/06→		VERSA	11/06→





87-428900-00 STD

A 64.40
B- 13.90
BØ 73.23
D 102.40
42x80



AK RT TP

08-428900-00 STD

3.50 GDC P
2.50 CR P
4.00 CK P



14-028610-00 D

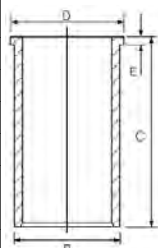

B 106.00 C 220.00 D 109.50 E 6.20

OE: A906 030 0924

102.00 **54**

OM 902.912 (Euro 4 OM906 LA)	6cyl.	6374cc	194kW (264PS)	Diesel	Turbo Intercooled	TD20249
OM 904.903 (Euro 2)	4cyl.	4250cc	112kW (152PS)	Diesel	Turbo Intercooled	TD28795
OM 904.904 (Euro 2)	4cyl.	4250cc	75kW (102PS)	Diesel	Turbo Intercooled	TD16441
OM 904.905 (Euro 2)	4cyl.	4249cc	90kW (122PS)	Diesel	Turbo Intercooled	TD8055
OM 904.906 (Euro 2)	4cyl.	4249cc	100kW (136PS)	Diesel	Turbo Intercooled	TD8060
OM 904.907 (Euro 2)	4cyl.	4249cc	125-130kW (170-177PS)	Diesel	Turbo Intercooled	TD8072
OM 904.908 (Euro 2)	4cyl.	4250cc	95-100kW (129-136PS)	Diesel	Turbo Intercooled	TD8024
OM 904.909 (Euro 2)	4cyl.	4249cc	90kW (122PS)	Diesel	Turbo Intercooled	TD12528
OM 904.910 (Euro 2)	4cyl.	4249cc	100kW (136PS)	Diesel	Turbo Intercooled	TD12529
OM 904.911 (Euro 2)	4cyl.	4249cc	125kW (170PS)	Diesel	Turbo Intercooled	TD12530
OM 904.912 (Euro 2)	4cyl.	4249cc	134kW (182PS)	Diesel	Turbo Intercooled	TD17711
OM 904.914 (Euro 2)	4cyl.	4249cc	100kW (136PS)	Diesel	Turbo Intercooled	TD16833
OM 904.915 (Euro 2)	4cyl.	4249cc	90kW (122PS)	Diesel	Turbo Intercooled	TD16834
OM 904.916 (Euro 2)	4cyl.	4249cc	100kW (136PS)	Diesel	Turbo Intercooled	TD16835
OM 904.917 (Euro 2)	4cyl.	4249cc	95-125kW (129-170PS)	Diesel	Turbo Intercooled	TD16836
OM 904.918 (Euro 2)	4cyl.	4249cc	90kW (122PS)	Diesel	Turbo Intercooled	TD17752
OM 904.919 (Euro 2)	4cyl.	4249cc	100kW (136PS)	Diesel	Turbo Intercooled	TD17705
OM 904.920 (Euro 2)	4cyl.	4249cc	125kW (170PS)	Diesel	Turbo Intercooled	TD17706
OM 904.921 (Euro 2)	4cyl.	4249cc	112kW (152PS)	Diesel	Turbo Intercooled	TD16837
OM 904.922 (Euro 2)	4cyl.	4249cc	112kW (152PS)	Diesel	Turbo Intercooled	TD12531
OM 904.923 (Euro 2)	4cyl.	4250cc	112-115kW (152-156PS)	Diesel	Turbo Intercooled	TD16438
OM 904.924 (Euro 2)	4cyl.	4249cc	100kW (136PS)	Diesel	Turbo Intercooled	TD17707
OM 904.925 (Euro 2)	4cyl.	4249cc	112kW (152PS)	Diesel	Turbo Intercooled	TD17708
OM 904.926 (Euro 2)	4cyl.	4249cc	113kW (154PS)	Diesel	Turbo Intercooled	TD17709
OM 904.927 (Euro 3)	4cyl.	4249cc	110kW (150PS)	Diesel	Turbo Intercooled	TD17324
OM 904.928 (Euro 3)	4cyl.	4249cc	130kW (177PS)	Diesel	Turbo Intercooled	TD17325
OM 904.929 (Euro 2)	4cyl.	4249cc	125kW (170PS)	Diesel	Turbo Intercooled	TD17710
OM 904.930 (Euro 2)	4cyl.	4249cc	100kW (136PS)	Diesel	Turbo Intercooled	TD16838
OM 904.931 (Euro 2)	4cyl.	4249cc	135kW (180PS)	Diesel	Turbo Intercooled	TD16839
OM 904.932 (Euro 2)	4cyl.	4249cc	142-147kW (193-200PS)	Diesel	Turbo Intercooled	TD17712
OM 904.933 (Euro 2)	4cyl.	4249cc	128kW (174PS)	Diesel	Turbo Intercooled	TD17713
OM 904.934 (Euro 2)	4cyl.	4249cc	134kW (174PS)	Diesel	Turbo Intercooled	TD17714
OM 904.935 (Euro 2)	4cyl.	4249cc	134kW (174PS)	Diesel	Turbo Intercooled	TD17715
OM 904.936 (Euro 3)	4cyl.	4250cc	110kW (150PS)	Diesel	Turbo Intercooled	TD16916
OM 904.937 (Euro 2)	4cyl.	4249cc	142kW (193PS)	Diesel	Turbo Intercooled	TD17716
OM 904.938 (Euro 2)	4cyl.	4249cc	125kW (170PS)	Diesel	Turbo Intercooled	TD17717
OM 904.939 (Euro 2)	4cyl.	4249cc	128kW (174PS)	Diesel	Turbo Intercooled	TD17718
OM 904.940 (Euro 2)	4cyl.	4249cc	113kW (154PS)	Diesel	Turbo Intercooled	TD17719
OM 904.941 (Euro 2)	4cyl.	4249cc	112kW (152PS)	Diesel	Turbo Intercooled	TD17720





OM 904.942 (Euro 3)	4cyl.	4249cc	130kW (177PS)	Diesel	Turbo Intercooled	TD17721
OM 904.943 (Euro 2)	4cyl.	4249cc	112kW (152PS)	Diesel	Turbo Intercooled	TD17722
OM 904.944 (Euro 2)	4cyl.	4249cc	90kW (122PS)	Diesel	Turbo Intercooled	TD17734
OM 904.945 (Euro 2)	4cyl.	4249cc	125kW (170PS)	Diesel	Turbo Intercooled	TD17735
OM 904.946 (Euro 2)	4cyl.	4249cc	90-110kW (122-150PS)	Diesel	Turbo Intercooled	TD17736
OM 904.947 (Euro 3)	4cyl.	4249cc	130kW (177PS)	Diesel	Turbo Intercooled	TD17737
OM 904.948 (Euro 2)	4cyl.	4249cc	113kW (154PS)	Diesel	Turbo Intercooled	TD17738
OM 904.949 (Euro 2)	4cyl.	4249cc	128-130kW (174-177PS)	Diesel	Turbo Intercooled	TD17739
OM 904.950 (Euro 2)	4cyl.	4249cc	90-110kW (122-150PS)	Diesel	Turbo Intercooled	TD17740
OM 904.951 (Euro 3)	4cyl.	4249cc	130kW (177PS)	Diesel	Turbo Intercooled	TD17741
OM 904.952 (Euro 3)	4cyl.	4249cc	130kW (177PS)	Diesel	Turbo Intercooled	TD17183
OM 904.953 (Euro 3)	4cyl.	4249cc	110kW (150PS)	Diesel	Turbo Intercooled	TD17184
OM 904.954 (Euro 2)	4cyl.	4249cc	128kW (174PS)	Diesel	Turbo Intercooled	TD17742
OM 904.955 (Euro 3)	4cyl.	4250cc	110kW (150PS)	Diesel	Turbo Intercooled	TD16915
OM 904.956 (Euro 2)	4cyl.	4249cc	140-142kW (190-193PS)	Diesel	Turbo Intercooled	TD17744
OM 904.957 (Euro 3)	4cyl.	4249cc	110kW (150PS)	Diesel	Turbo Intercooled	TD17745
OM 904.959 (Euro 2)	4cyl.	4249cc	128kW (174PS)	Diesel	Turbo Intercooled	TD17746
OM 904.961 (Euro 3)	4cyl.	4250cc	90kW (122PS)	Diesel	Turbo Intercooled	TD16918
OM 904.962 (Euro 3)	4cyl.	4249cc	130kW (177PS)	Diesel	Turbo Intercooled	TD17747
OM 904.965 (Euro 3)	4cyl.	4249cc	110kW (150PS)	Diesel	Turbo Intercooled	TD17748
OM 904.966 (Euro 3)	4cyl.	4249cc	110kW (150PS)	Diesel	Turbo Intercooled	TD17749
OM 904.967 (Euro 3)	4cyl.	4249cc	130kW (177PS)	Diesel	Turbo Intercooled	TD17750
OM 904.968 (Euro 3)	4cyl.	4249cc	130kW (177PS)	Diesel	Turbo Intercooled	TD17751
OM 904.970 (Euro 3)	4cyl.	4249cc	110kW (150PS)	Diesel	Turbo Intercooled	TD24856
OM 904.972 (Euro 3)	4cyl.	4249cc	130kW (177PS)	Diesel	Turbo Intercooled	TD24857
OM 904.974 (Euro 2)	4cyl.	4249cc	125kW (170PS)	Diesel	Turbo Intercooled	TD28797
OM 906.910 (Euro 2)	6cyl.	6374cc	170kW (231PS)	Diesel	Turbo Intercooled	TD11309
OM 906.911 (Euro 2)	6cyl.	6374cc	205kW (279PS)	Diesel	Turbo Intercooled	TD11310
OM 906.912 (Euro 2)	6cyl.	6374cc	194kW (264PS)	Diesel	Turbo Intercooled	TD17757
OM 906.913 (Euro 2)	6cyl.	6374cc	172kW (234PS)	Diesel	Turbo Intercooled	TD17758
OM 906.914 (Euro 2)	6cyl.	6374cc	157kW (231PS)	Diesel	Turbo Intercooled	TD17759
OM 906.915 (Euro 2)	6cyl.	6374cc	170kW (231PS)	Diesel	Turbo Intercooled	TD11311
OM 906.916 (Euro 2)	6cyl.	6374cc	205kW (279PS)	Diesel	Turbo Intercooled	TD11312
OM 906.917 (Euro 2)	6cyl.	6374cc	170kW (231PS)	Diesel	Turbo Intercooled	TD17760
OM 906.918 (Euro 2)	6cyl.	6374cc	180kW (245PS)	Diesel	Turbo Intercooled	TD17761
OM 906.919 (Euro 2)	6cyl.	6374cc	180kW (245PS)	Diesel	Turbo Intercooled	TD11313
OM 906.920 (Euro 2)	6cyl.	6374cc	170-172kW (231-234PS)	Diesel	Turbo Intercooled	TD11314
OM 906.921 (Euro 2)	6cyl.	6374cc	205kW (279PS)	Diesel	Turbo Intercooled	TD11315
OM 906.922 (Euro 2)	6cyl.	6374cc	170kW (231PS)	Diesel	Turbo Intercooled	TD11316
OM 906.923 (Euro 2)	6cyl.	6374cc	205kW (279PS)	Diesel	Turbo Intercooled	TD11317
OM 906.924 (Euro 2)	6cyl.	6374cc	170kW (231PS)	Diesel	Turbo Intercooled	TD17762
OM 906.929 (Euro 2)	6cyl.	6374cc	172kW (234PS)	Diesel	Turbo Intercooled	TD17763
OM 906.930 (Euro 2)	6cyl.	6374cc	205kW (279PS)	Diesel	Turbo Intercooled	TD11318
OM 906.931 (Euro 2)	6cyl.	6374cc	170kW (231PS)	Diesel	Turbo Intercooled	TD11319
OM 906.932 (Euro 2)	6cyl.	6374cc	172kW (234PS)	Diesel	Turbo Intercooled	TD17764
OM 906.933 (Euro 2)	6cyl.	6374cc	209kW (284PS)	Diesel	Turbo Intercooled	TD17765
OM 906.934 (Euro 2)	6cyl.	6374cc	209kW (284PS)	Diesel	Turbo Intercooled	TD17766
OM 906.936 (Euro 2)	6cyl.	6374cc	172kW (234PS)	Diesel	Turbo Intercooled	TD17767
OM 906.937 (Euro 2)	6cyl.	6374cc	170kW (231PS)	Diesel	Turbo Intercooled	TD17768
OM 906.938 (Euro 3)	6cyl.	6374cc	205kW (279PS)	Diesel	Turbo Intercooled	TD17769





OM 906.940 (Euro 2)	6cyl.	6374cc	170kW (231PS)	Diesel	Turbo Intercooled	TD11320
OM 906.941 (Euro 2)	6cyl.	6374cc	205kW (279PS)	Diesel	Turbo Intercooled	TD11321
OM 906.944 (Euro 2)	6cyl.	6374cc	142kW (193PS)	Diesel	Turbo Intercooled	TD17770
OM 906.945 (Euro 2)	6cyl.	6374cc	157kW (214PS)	Diesel	Turbo Intercooled	TD17771
OM 906.946 (Euro 2)	6cyl.	6374cc	187kW (254PS)	Diesel	Turbo Intercooled	TD17772
OM 906.947 (Euro 2)	6cyl.	6374cc	191-194kW (260-264PS)	Diesel	Turbo Intercooled	TD17774
OM 906.948 (Euro 2)	6cyl.	6374cc	224kW (305PS)	Diesel	Turbo Intercooled	TD17775
OM 906.952 (Euro 3)	6cyl.	6374cc	205kW (279PS)	Diesel	Turbo Intercooled	TD16925
OM 906.953 (Euro 3)	6cyl.	6374cc	205kW (279PS)	Diesel	Turbo Intercooled	TD17779
OM 906.954 (Euro 2)	6cyl.	6374cc	172kW (234PS)	Diesel	Turbo Intercooled	TD17780
OM 906.955 (Euro 3)	6cyl.	6374cc	205kW (279PS)	Diesel	Turbo Intercooled	TD17327
OM 906.956 (Euro 2)	6cyl.	6374cc	209kW (284PS)	Diesel	Turbo Intercooled	TD17781
OM 906.957 (Euro 2)	6cyl.	6374cc	142kW (193PS)	Diesel	Turbo Intercooled	TD17782
OM 906.958 (Euro 2)	6cyl.	6374cc	157kW (214PS)	Diesel	Turbo Intercooled	TD17783
OM 906.959 (Euro 2)	6cyl.	6374cc	157kW (214PS)	Diesel	Turbo Intercooled	TD17784
OM 906.961 (Euro 3)	6cyl.	6374cc	205kW (279PS)	Diesel	Turbo Intercooled	TD17459
OM 906.965	6cyl.	6374cc	205kW (279PS)	Diesel	Turbo Intercooled	TD17824
OM 906.966 (Euro 2)	6cyl.	6374cc	172kW (230PS)	Diesel	Turbo Intercooled	TD17825
OM 906.967 (Euro 2)	6cyl.	6374cc	209kW (284PS)	Diesel	Turbo Intercooled	TD17826
OM 906.968 (Euro 2)	6cyl.	6374cc	172-187kW (230-254PS)	Diesel	Turbo Intercooled	TD17827
OM 906.970 (Euro 2)	6cyl.	6374cc	191-209kW (260-284PS)	Diesel	Turbo Intercooled	TD17828
OM 906.971	6cyl.	6374cc	170-180kW (231-245PS)	Diesel	Turbo Intercooled	TD17829
OM 906.974 (Euro 2)	6cyl.	6374cc	209kW (280PS)	Diesel	Turbo Intercooled	TD17830
OM 906.975 (Euro 2)	6cyl.	6374cc	180kW (245PS)	Diesel	Turbo Intercooled	TD17831
OM 906.976 (Euro 2)	6cyl.	6374cc	209kW (284PS)	Diesel	Turbo Intercooled	TD17773
OM 906.977 (Euro 2)	6cyl.	6374cc	209kW (280PS)	Diesel	Turbo Intercooled	TD17833
OM 906.978 (Euro 2)	6cyl.	6374cc	142-157kW (193-214PS)	Diesel	Turbo Intercooled	TD17834
OM 906.979 (Euro 2)	6cyl.	6374cc	172-187kW (193-254PS)	Diesel	Turbo Intercooled	TD17835
OM 906.980 (Euro 2)	6cyl.	6374cc	194-209kW (264-284PS)	Diesel	Turbo Intercooled	TD17836
OM 906.981 (Euro 2)	6cyl.	6374cc	224kW (300PS)	Diesel	Turbo Intercooled	TD17837
OM 906.985 (Euro 3)	6cyl.	6374cc	180kW (245PS)	Diesel	Turbo Intercooled	TD17840
OM 906.986 (Euro 3)	6cyl.	6374cc	205kW (279PS)	Diesel	Turbo Intercooled	TD25471
OM 906.988 (Euro 3)	6cyl.	6374cc	180kW (245PS)	Diesel	Turbo Intercooled	TD17841
OM 906.995 (Euro 3)	6cyl.	6374cc	206kW (279PS)	Diesel	Turbo Intercooled	TD25657
OM 907.910 (Euro 2 OM904 LA)	4cyl.	4250cc	75kW (102PS)	Diesel	Turbo Intercooled	TD16840
OM 907.920 (Euro 2 OM904 LA)	4cyl.	4250cc	90kW (122PS)	Diesel	Turbo Intercooled	TD16841
OM 907.930 (Euro 2 OM904 LA)	4cyl.	4249cc	100kW (136PS)	Diesel	Turbo Intercooled	TD17754
OM 907.940 (Euro 2 OM904 LA)	4cyl.	4250cc	125kW (170PS)	Diesel	Turbo Intercooled	TD16842
OM 907.941 (Euro 2 OM904 LA)	4cyl.	4249cc	125kW (170PS)	Diesel	Turbo Intercooled	TD17753
OM 907.960 (Euro 2 OM904 LA)	4cyl.	4250cc	75kW (102PS)	Diesel	Turbo Intercooled	TD16843
OM 907.970 (Euro 2 OM904 LA)	4cyl.	4250cc	90kW (122PS)	Diesel	Turbo Intercooled	TD16844
OM 907.980 (Euro 2 OM904 LA)	4cyl.	4249cc	100kW (136PS)	Diesel	Turbo Intercooled	TD17755
OM 907.990 (Euro 2 OM904 LA)	4cyl.	4250cc	125kW (170PS)	Diesel	Turbo Intercooled	TD16845
OM 909.900 (OM906 hLA)	6cyl.	6374cc	170kW (231PS)	Diesel	Turbo Intercooled	TD17443
OM 909.901 (OM906 hLA)	6cyl.	6374cc	205kW (279PS)	Diesel	Turbo Intercooled	TD17445
OM 909.910 (OM906 LA)	6cyl.	6374cc	170kW (231PS)	Diesel	Turbo Intercooled	TD16846
OM 909.911 (OM906 LA)	6cyl.	6374cc	170kW (231PS)	Diesel	Turbo Intercooled	TD17444
OM 909.920 (OM906 LA)	6cyl.	6374cc	205kW (279PS)	Diesel	Turbo Intercooled	TD16847
OM 909.921 (OM906 LA)	6cyl.	6374cc	205kW (279PS)	Diesel	Turbo Intercooled	TD17446
OM 909.960 (OM906 LA)	6cyl.	6374cc	170kW (231PS)	Diesel	Turbo Intercooled	TD16848





OM 909.970 (OM906 LA)	6cyl.	6374cc	205kW (279PS)	Diesel	Turbo Intercooled	TD16849
OM 909.971 (OM906 LA)	6cyl.	6374cc	205kW (279PS)	Diesel	Turbo Intercooled	TD16850
ACCELO			05/03→	UNIMOG		03/00→
ALLEGRO			01/02→12/13	VARIO 613 D, 614 D		09/96→
ATEGO			01/98→10/04	VARIO 615 D, 616 D		09/98→
ATEGO 2			10/04→	VARIO 813 D, 814 D		09/96→12/13
AXOR			01/02→10/04	VARIO 813 DA, 814 DA		09/96→12/13
AXOR 2			10/04→	VARIO 815 D		09/96→12/13
BEAVER			01/05→	VARIO 815 D, 816 D		09/96→12/13
BOXER			01/02→12/13	VARIO 815 DA, 816 DA		09/96→12/13
B-Series			05/99→	VARIO Cab with engine 810 DT		09/96→06/06
CITARO (O 530)			01/98→	VARIO Cab with engine 812 DT		09/96→06/06
CITO (O 520)			06/99→	VARIO Cab with engine 814 DT		09/96→06/06
CONECTO (O 345)			11/01→	VARIO Cab with engine 816 DT		09/96→06/06
ECONIC			01/98→	VARIO Dump Truck 613 D, 614 D		09/96→12/13
FPN (FlatNose)			07/01→12/05	VARIO Dump Truck 615 D, 616 D		09/98→
HEAVY-DUTY			01/14→08/19	VARIO Dump Truck 813 D, 814 D		09/96→12/13
HPN (LongNose)			07/01→12/05	VARIO Dump Truck 813 DA, 814 DA		09/96→12/13
LK/LN2			03/96→12/98	VARIO Dump Truck 815 D, 816 D		09/96→
LO			01/90→03/04	VARIO Dump Truck 815 DA, 816 DA		09/96→12/13
OF			01/01→	VARIO O 810		09/96→12/10
OH			01/70→	VARIO O 814		09/96→12/10
OMC			02/06→	VARIO O 815		08/96→12/10
TOURINO (O 510)			10/03→	ZEUS		03/08→
TOURO (O 500)			01/01→			

87-289300-00 STD

A 64.40
B- 13.90
BØ 73.00
D 102.40
40x78



AK RT TP

08-289300-00 STD

3.00 CK P
2.50 CR P
4.00 CR P



14-028610-00 D

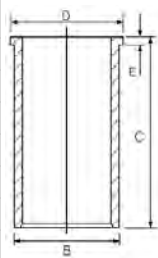

B 106.00 C 220.00 D 109.50 E 6.20

88-289300-00

87-289300-00 +
14-028610-00

87-289300-10 STD

A 64.40
B- 13.90
BØ 73.00
D 102.50
42x80



AK RT TP

08-289300-00 STD

3.00 CK P
2.50 CR P
4.00 CR P



OE A003 030 9724

102.00

55

OM 904.964 (Euro 3)	4cyl.	4249cc	130kW (177PS)	Diesel	Turbo Intercooled	TD16919
OM 904.973 (Euro 3)	4cyl.	4249cc	130kW (177PS)	Diesel	Turbo Intercooled	TD24858
OM 904.975 (Euro 3)	4cyl.	4249cc	75-110kW (102-150PS)	Diesel	Turbo Intercooled	TD28798
OM 904.976 (Euro 3)	4cyl.	4249cc	130kW (177PS)	Diesel	Turbo Intercooled	TD24859
OM 904.977	4cyl.	4249cc	110kW (150PS)	Diesel	Turbo Intercooled	TD28799
OM 904.978	4cyl.	4249cc	130kW (177PS)	Diesel	Turbo Intercooled	TD28800
OM 904.979	4cyl.	4249cc	112kW (152PS)	Diesel	Turbo Intercooled	TD28801
OM 904.980	4cyl.	4249cc	130kW (177PS)	Diesel	Turbo Intercooled	TD28802
OM 904.981	4cyl.	4249cc	110kW (150PS)	Diesel	Turbo Intercooled	TD28803





OM 906.925 (Euro 3)	6cyl.	6374cc	170kW (231PS)	Diesel	Turbo Intercooled	TD16920
OM 906.926 (Euro 3)	6cyl.	6374cc	205kW (279PS)	Diesel	Turbo Intercooled	TD16923
OM 906.927 (Euro 3)	6cyl.	6374cc	170kW (231PS)	Diesel	Turbo Intercooled	TD16921
OM 906.928 (Euro 3)	6cyl.	6374cc	205kW (279PS)	Diesel	Turbo Intercooled	TD16924
OM 906.935 (Euro 3)	6cyl.	6374cc	170kW (231PS)	Diesel	Turbo Intercooled	TD17326
OM 906.939 (Euro 3)	6cyl.	6374cc	180kW (245PS)	Diesel	Turbo Intercooled	TD16926
OM 906.949 (Euro 3)	6cyl.	6374cc	180kW (245PS)	Diesel	Turbo Intercooled	TD17776
OM 906.950 (Euro 3)	6cyl.	6374cc	205kW (279PS)	Diesel	Turbo Intercooled	TD17777
OM 906.951	6cyl.	6374cc	170kW (231PS)	Diesel	Turbo Intercooled	TD17778
OM 906.960 (Euro 3)	6cyl.	6374cc	205kW (279PS)	Diesel	Turbo Intercooled	TD17447
OM 906.962 (Euro 3)	6cyl.	6374cc	180kW (245PS)	Diesel	Turbo Intercooled	TD17460
OM 906.963 (Euro 3)	6cyl.	6374cc	180kW (245PS)	Diesel	Turbo Intercooled	TD17449
OM 906.964	6cyl.	6374cc	170-180kW (231-245PS)	Diesel	Turbo Intercooled	TD17823
OM 906.973 (Euro 3)	6cyl.	6374cc	170kW (231PS)	Diesel	Turbo Intercooled	TD24855
OM 906.982	6cyl.	6374cc	170kW (231PS)	Diesel	Turbo Intercooled	TD17838
OM 906.983 (Euro 3)	6cyl.	6374cc	180kW (245PS)	Diesel	Turbo Intercooled	TD17839
OM 906.991 (Euro 3)	6cyl.	6374cc	130-205kW (177-279PS)	Diesel	Turbo Intercooled	TD28805
OM 906.992 (Euro 3)	6cyl.	6374cc	180kW (245PS)	Diesel	Turbo Intercooled	TD28806
OM 906.993 (Euro 3)	6cyl.	6374cc	205kW (279PS)	Diesel	Turbo Intercooled	TD28807
OM 906.998 (Euro 3)	6cyl.	6374cc	191kW (260PS)	Diesel	Turbo Intercooled	TD28809
OM 906.998 (Euro 3)	6cyl.	6374cc	172-194kW (234-264PS)	Diesel	Turbo Intercooled	TD28810
ALLIADO			01/10→	TOURINO (0 510)		10/03→
ATEGO			01/98→10/04	TOURO (0 500)		01/01→
ATEGO 2			10/04→	UNIMOG		03/00→
AXOR 2			10/04→	VARIO 618 D		09/06→
CITARO (0 530)			01/98→	VARIO 818 D		09/06→
CONECTO (0 345)			11/01→	VARIO 818 DA		09/06→
ECONIC			03/98→	VARIO Dump Truck 618 D		09/06→
HEAVY-DUTY			06/12→12/19	VARIO Dump Truck 818 D		09/06→
HPN (LongNose)			05/99→12/11	VARIO Dump Truck 818 DA		09/06→
OH			01/70→			

14-028610-00 D

B 106.00 C 220.00 D 109.50 E 6.20

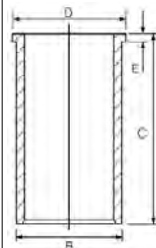

106.00

56

OM 924.913 (Euro 3)	4cyl.	4801cc	160kW (218PS)	Diesel	Turbo Intercooled	TD25040
OM 924.915 (Euro 3)	4cyl.	4801cc	142-160kW (193-218PS)	Diesel	Turbo Intercooled	TD19185
OM 924.916 (Euro 3)	4cyl.	4801cc	160kW (218PS)	Diesel	Turbo Intercooled	TD17185
OM 924.919 (Euro 3)	4cyl.	4801cc	160kW (218PS)	Diesel	Turbo Intercooled	TD19187
OM 924.920 (Euro 3)	4cyl.	4801cc	160kW (218PS)	Diesel	Turbo Intercooled	TD18917
OM 924.924 (Euro 3)	4cyl.	4801cc	160kW (218PS)	Diesel	Turbo Intercooled	TD19191
OM 924.928	4cyl.	4801cc	160kW (218PS)	Diesel	Turbo Intercooled	TD28813
OM 924.932 (Euro 5)	4cyl.	4801cc	145kW (197PS)	Diesel	Turbo Intercooled	TD28816
OM 926.913 (Euro 3)	6cyl.	7201cc	240kW (326PS)	Diesel	Turbo Intercooled	TD19160
OM 926.914 (Euro 2)	6cyl.	7201cc	240kW (326PS)	Diesel	Turbo Intercooled	TD19161



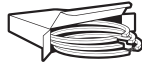

OM 926.915 (Euro 3)	6cyl.	7201cc	240kW (326PS)	Diesel	Turbo Intercooled	TD19162
OM 926.917 (Euro 3)	6cyl.	7201cc	240kW (326PS)	Diesel	Turbo Intercooled	TD19164
OM 926.921 (Euro 3)	6cyl.	7201cc	240kW (326PS)	Diesel	Turbo Intercooled	TD19168
OM 926.924 (Euro 3)	6cyl.	7201cc	240kW (326PS)	Diesel	Turbo Intercooled	TD19169
OM 926.926 (Euro 3)	6cyl.	7201cc	225kW (306PS)	Diesel	Turbo Intercooled	TD19171
OM 926.929 (Euro 3)	6cyl.	7201cc	220-240kW (299-326PS)	Diesel	Turbo Intercooled	TD19174
OM 926.930 (Euro 3)	6cyl.	7201cc	225kW (306PS)	Diesel	Turbo Intercooled	TD19175
OM 926.932 (Euro 3)	6cyl.	7201cc	225kW (306PS)	Diesel	Turbo Intercooled	TD19176
OM 926.933 (Euro 3)	6cyl.	7201cc	225kW (306PS)	Diesel	Turbo Intercooled	TD28833
OM 926.935 (Euro 3)	6cyl.	7201cc	240kW (326PS)	Diesel	Turbo Intercooled	TD21087
OM 926.938 (Euro 3)	6cyl.	7201cc	205kW (279PS)	Diesel	Turbo Intercooled	TD19179
OM 926.940	6cyl.	7201cc	220-240kW (299-326PS)	Diesel	Turbo Intercooled	TD28834
OM 926.941 (Euro 4)	6cyl.	7201cc	205kW (279PS)	Diesel	Turbo Intercooled	TD25472
OM 926.968	6cyl.	7201cc	225kW (306PS)	Diesel	Turbo Intercooled	TD28841
OM 926.969	6cyl.	7201cc	225-240kW (306-326PS)	Diesel	Turbo Intercooled	TD28842

ATEGO 2	10/04→	OH	05/99→
AXOR 2	10/04→	TOURO (0 500)	01/01→
BOXER	01/02→	UNIMOG	09/02→
ECONIC	10/01→	ZETROS	09/08→

87-146400-00 STD ⓘ

A	61.35
B-	14.20
BØ	76.00
D	99.50
	42x80



AK KK RT TP

08-146400-00 STD

3.00		GDC P
2.50		CR P
4.00		CR P



ⓘ Bowl capacity 57.000cm³

ⓘ Volumen der Kolbenmulde 57.000cm³

ⓘ Volume de la cavité du piston 57.000cm³

ⓘ Vol. cavidad pistón 57.000cm³

ⓘ Volume camera pistone 57.000cm³

110.00

57

OM 933.911 (Euro 6 OM934 LA)	4cyl.	5132cc	115-170kW (156-231PS)	Diesel	Turbo Intercooled	TD38666
OM 933.911-913,915,916 (OM 934 LA)	4cyl.	5132cc		Diesel	Turbo Intercooled	MP17004
OM 933.912 (Euro 6 OM934 LA)	4cyl.	5132cc	115-170kW (156-231PS)	Diesel	Turbo Intercooled	TD38667
OM 933.913 (Euro 6 OM934 LA)	4cyl.	5132cc	115-170kW (156-231PS)	Diesel	Turbo Intercooled	TD38668
OM 933.915 (Euro 6 OM934 LA)	4cyl.	5132cc	115-170kW (156-231PS)	Diesel	Turbo Intercooled	TD38669
OM 933.916 (Euro 6 OM934 LA)	4cyl.	5132cc	115-170kW (156-231PS)	Diesel	Turbo Intercooled	TD38670
OM 934.912	4cyl.	5132cc		Diesel	Turbo Intercooled	MP37004
OM 934.912 (Euro 6)	4cyl.	5132cc	115-170kW (156-231PS)	Diesel	Turbo Intercooled	TD37093
OM 934.974 (Euro 6)	4cyl.	5132cc	170kW (231PS)	Diesel	Turbo Intercooled	TD29322
OM 934.976 (Euro 6)	4cyl.	5132cc	115-170kW (156-231PS)	Diesel	Turbo Intercooled	TD37095
OM 934.976,978	4cyl.	5132cc		Diesel	Turbo Intercooled	MP57004
OM 934.978 (Euro 6)	4cyl.	5132cc	115-170kW (156-231PS)	Diesel	Turbo Intercooled	TD37096

INDUSTRIAL	UNIMOG 405 HEAVY	05/13→
UNIMOG		05/13→





87-444600-10 STD I

- A 70.90
- B- 17.55
- BØ 61.50
- C 2.30
- D 110.00
- 46x80

(11099)

AK KK NB RT TP



08-444600-00 STD

- 3.50 GDC P
- 2.50 CR P
- 4.00 GDC P



DuraBowl[®]

I Increased power

I Increased power

I Increased power

I Increased power

I Increased power

110.00							58
OM 933.951 (Euro 6 OM934 LA)	4cyl.	5132cc	115-170kW	(156-231PS)	Diesel	Turbo Intercooled	TD38673
OM 933.951,952 (OM 934 LA)	4cyl.	5132cc			Diesel	Turbo Intercooled	MP27004
OM 933.952 (Euro 6 OM934 LA)	4cyl.	5132cc	115-170kW	(156-231PS)	Diesel	Turbo Intercooled	TD38674
OM 934.911 (Euro 6)	4cyl.	5132cc	115-130kW	(156-177PS)	Diesel	Turbo Intercooled	TD28096
OM 934.913 (Euro 6)	4cyl.	5132cc	155-170kW	(211-231PS)	Diesel	Turbo Intercooled	TD28097
OM 934.971 (Euro 6)	4cyl.	5132cc	115-130kW	(156-177PS)	Diesel	Turbo Intercooled	TD34251
OM 934.972 (Euro 6)	4cyl.	5132cc	170kW	(231PS)	Diesel	Turbo Intercooled	TD34252
OM 935.911 (Euro 6 OM936)	6cyl.	7698cc	175-260kW	(238-354PS)	Diesel	Turbo Intercooled	TD38656
OM 935.911-914,951-954 (OM 936 LA)	4cyl.	5132cc			Diesel	Turbo Intercooled	MP67004
OM 935.912 (Euro 6 OM936)	6cyl.	7698cc	175-260kW	(238-354PS)	Diesel	Turbo Intercooled	TD38657
OM 935.913 (Euro 6 OM936)	6cyl.	7698cc	175-260kW	(238-354PS)	Diesel	Turbo Intercooled	TD38658
OM 935.914 (Euro 6 OM936)	6cyl.	7698cc	175-260kW	(238-354PS)	Diesel	Turbo Intercooled	TD38659
OM 935.951 (Euro 6 OM936)	6cyl.	7698cc	175-260kW	(238-354PS)	Diesel	Turbo Intercooled	TD38662
OM 935.952 (Euro 6 OM936)	6cyl.	7698cc	175-260kW	(238-354PS)	Diesel	Turbo Intercooled	TD38663
OM 935.953 (Euro 6 OM936)	6cyl.	7698cc	175-260kW	(238-354PS)	Diesel	Turbo Intercooled	TD38664
OM 935.954 (Euro 6 OM936)	6cyl.	7698cc	175-260kW	(238-354PS)	Diesel	Turbo Intercooled	TD38665
OM 936.910	4cyl.	5132cc			Diesel	Turbo Intercooled	MP77004
OM 936.910 (Euro 6)	6cyl.	7698cc	175-220kW	(238-299PS)	Diesel	Turbo Intercooled	TD34945
OM 936.912 (Euro 6)	6cyl.	7698cc	175-220kW	(238-299PS)	Diesel	Turbo Intercooled	TD27609
OM 936.915 (Euro 6)	6cyl.	7698cc	220-260kW	(299-354PS)	Diesel	Turbo Intercooled	TD30265
OM 936.916 (Euro 6)	6cyl.	7698cc	235-260kW	(320-354PS)	Diesel	Turbo Intercooled	TD27610
OM 936.919 (Euro 6)	6cyl.	7698cc	220-260kW	(299-354PS)	Diesel	Turbo Intercooled	TD34946
OM 936.919,923	4cyl.	5132cc			Diesel	Turbo Intercooled	MP87004
OM 936.923 (Euro 6)	6cyl.	7698cc	220-260kW	(299-354PS)	Diesel	Turbo Intercooled	TD35745
OM 936.971 (Euro 6)	6cyl.	7698cc	200-220kW	(272-299PS)	Diesel	Turbo Intercooled	TD32230
OM 936.972 (Euro 6)	6cyl.	7698cc	220-260kW	(299-354PS)	Diesel	Turbo Intercooled	TD32229
OM 936.973 (Euro 6)	6cyl.	7698cc	220kW	(299PS)	Diesel	Turbo Intercooled	TD32231
OM 936.975	4cyl.	5132cc			Diesel	Turbo Intercooled	MP97004
OM 936.975 (Euro 6)	6cyl.	7698cc	175-260kW	(238-354PS)	Diesel	Turbo Intercooled	TD37101
OM 936.977	4cyl.	5132cc			Diesel	Turbo Intercooled	MP97004-1
OM 936.977 (Euro 6)	6cyl.	7698cc	175-260kW	(238-354PS)	Diesel	Turbo Intercooled	TD37102
OM 936.980 (Euro 6)	6cyl.	7698cc	220-260kW	(299-354PS)	Diesel	Turbo Intercooled	TD34257
ACTROS MP4 / MP5			07/11→		INTEGRO (0 550)		02/13→
ANTOS			07/12→12/18		INTOURO		11/13→
AROCS			01/13→		Series 400		01/13→
ATEGO 3			04/13→		Series 500		01/14→
ECONIC 2			04/13→		UNIMOG		05/13→





INDUSTRIAL

87-444600-00 STD 1

A 70.90
B- 17.55
BØ 61.50
C 2.30
D 110.00

 46x80

(11099)

AK KK NB RT TP



08-444600-00 STD

3.50  GDC P
2.50  CR P
4.00  GDC P



1 Bowl capacity 59.370cm³

1 Volumen der Kolbenmulde 59.370cm³

1 Volume de la cavité du piston 59.370cm³

1 Vol. cavidad pistón 59.370cm³

1 Volume camera pistone 59.370cm³

 115.00						59
OM 360.911	6cyl.	8720cc	125kW (170PS)	Diesel	Turbo Intercooled	TD7902
OM 360.912	6cyl.	8720cc	125-141kW (170-192PS)	Diesel		TD23186
OM 360.914	6cyl.	8720cc	141kW (192PS)	Diesel		TD5658
OM 360.915	6cyl.	8720cc	141kW (192PS)	Diesel		TD5996
OM 360.916	6cyl.	8720cc	125kW (170PS)	Diesel		TD5659
OM 360.917	6cyl.	8720cc	125kW (170PS)	Diesel		TD5997
OM 360.918	6cyl.	8720cc	125kW (170PS)	Diesel		TD7894
OM 360.931	6cyl.	8720cc	141kW (192PS)	Diesel		TD6269
OM 360.933	6cyl.	8720cc	125kW (170PS)	Diesel		TD6270
OM 360.934	6cyl.	8720cc	125-141kW (170-192PS)	Diesel		TD23188
OM 360.936	6cyl.	8725cc	125kW (170PS)	Diesel		TD16688
OM 360.937	6cyl.	8725cc	127kW (172PS)	Diesel		TD16689
OM 360.938	6cyl.	8725cc	127kW (172PS)	Diesel		TD16690
OM 360.939	6cyl.	8720cc	125kW (170PS)	Diesel		TD8195
OM 360.940	6cyl.	8725cc	127kW (172PS)	Diesel		TD16691
OM 360.941	6cyl.	8725cc	141kW (192PS)	Diesel		TD16698
OM 360.942	6cyl.	8725cc	127kW (172PS)	Diesel		TD16692
OM 360.943	6cyl.	8725cc	127kW (172PS)	Diesel		TD16693
OM 360.944	6cyl.	8725cc	127kW (172PS)	Diesel		TD16694
OM 360.946	6cyl.	8725cc	127kW (172PS)	Diesel		TD16695
OM 360.947	6cyl.	8725cc	125-141kW (170-192PS)	Diesel		TD23189
OM 360.948	6cyl.	8725cc	125kW (170PS)	Diesel		TD16696
OM 360.949	6cyl.	8725cc	125kW (170PS)	Diesel		TD16697
OM 360.954	6cyl.	8725cc	125-141kW (170-192PS)	Diesel		TD23190
OM 360.955	6cyl.	8725cc	125-141kW (170-192PS)	Diesel		TD23191
OM 360.956	6cyl.	8725cc	125-141kW (170-192PS)	Diesel		TD23192
OM 360.959	6cyl.	8725cc	125-141kW (170-192PS)	Diesel		TD23193
OM 360.974	6cyl.	8725cc	125-141kW (170-192PS)	Diesel		TD23194
OM 360.976	6cyl.	8725cc	125-141kW (170-192PS)	Diesel		TD23195
OM 360.978	6cyl.	8725cc	125-141kW (170-192PS)	Diesel		TD23196
OM 360.980	6cyl.	8720cc	141kW (192PS)	Diesel		TD17020
OM 360.981	6cyl.	8720cc	141kW (192PS)	Diesel		TD17021
OM 360.984	6cyl.	8720cc	154kW (210PS)	Diesel	Turbo	TD17022
OM 360.985	6cyl.	8720cc	141kW (192PS)	Diesel	Turbo	TD17024
OM 360.986	6cyl.	8720cc	154kW (210PS)	Diesel	Turbo	TD17023

0 302

05/69→12/74

OF

01/83→





87-176407-00 0.50mm

A 85.30
B- 22.00
BØ 65.00
C 0.70
D 133.30
 42x98



RT

08-176400-10 STD

3.50  MOL P
 3.00  MO P
 5.50  CR P

14-024241-00 D

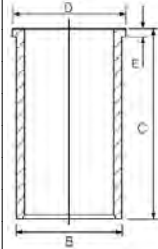

B 121.00 **C** 253.50 **D** 126.00 **E** 6.00

 **125.00**

60

OM 401.905	V6cyl.	9572cc	141kW (192PS)	Diesel		TD5730
OM 401.906	V6cyl.	9572cc	141kW (192PS)	Diesel		TD6062
OM 401.907	V6cyl.	9572cc	141kW (192PS)	Diesel		TD16942
OM 401.908	V6cyl.	9572cc	141kW (192PS)	Diesel		TD16943
OM 401.909	V6cyl.	9572cc	141kW (192PS)	Diesel		TD5767
OM 401.912	V6cyl.	9572cc	141kW (192PS)	Diesel		TD7895
OM 401.913	V6cyl.	9572cc	141kW (192PS)	Diesel		TD16944
OM 401.914	V6cyl.	9572cc	141kW (192PS)	Diesel		TD5729
OM 401.915	V6cyl.	9572cc	141kW (192PS)	Diesel		TD6061
OM 401.916	V6cyl.	9572cc	141kW (192PS)	Diesel		TD6099
OM 401.917	V6cyl.	9572cc	188kW (256PS)	Diesel	Turbo	TD16949
OM 401.918	V6cyl.	9572cc	141kW (192PS)	Diesel		TD8118
OM 401.919	V6cyl.	9572cc	141kW (192PS)	Diesel		TD9596
OM 401.921	V6cyl.	9572cc	141kW (192PS)	Diesel		TD16945
OM 401.922	V6cyl.	9572cc	141kW (192PS)	Diesel		TD16946
OM 401.923	V6cyl.	9572cc	141kW (192PS)	Diesel		TD6081
OM 401.925	V6cyl.	9572cc	141kW (192PS)	Diesel		TD8229
OM 401.926	V6cyl.	9572cc	141kW (192PS)	Diesel		TD9597
OM 401.927	V6cyl.	9572cc	141kW (192PS)	Diesel		TD9598
OM 401.928	V6cyl.	9572cc	141kW (192PS)	Diesel		TD16948
OM 402.905	V8cyl.	12800cc	188kW (256PS)	Diesel		TD8179
OM 402.906	V8cyl.	12800cc	188kW (256PS)	Diesel		TD5814
OM 402.907	V8cyl.	12800cc	188kW (256PS)	Diesel		TD7896
OM 402.910	V8cyl.	12800cc	176kW (240PS)	Diesel		TD5752
OM 402.912	V8cyl.	12800cc	188kW (256PS)	Diesel		TD5758
OM 402.913	V8cyl.	12760cc	177kW (240PS)	Diesel		TD17803
OM 402.914	V8cyl.	12800cc	176kW (240PS)	Diesel		TD8230
OM 402.916	V8cyl.	12800cc	188kW (256PS)	Diesel		TD5798
OM 402.917	V8cyl.	12760cc	177kW (240PS)	Diesel		TD17804
OM 402.919	V8cyl.	12800cc	176kW (240PS)	Diesel		TD8154
OM 402.921	V8cyl.	12760cc	177kW (240PS)	Diesel		TD17805
OM 402.923	V8cyl.	12800cc	176kW (240PS)	Diesel		TD8183
OM 402.924	V8cyl.	12800cc	188kW (256PS)	Diesel		TD6291
OM 402.925	V8cyl.	12760cc	188kW (256PS)	Diesel		TD17806
OM 402.926	V8cyl.	12800cc	188kW (256PS)	Diesel		TD6296
OM 402.927	V8cyl.	12800cc	176kW (240PS)	Diesel		TD9606
OM 402.928	V8cyl.	12800cc	176kW (240PS)	Diesel		TD9607
OM 403.915	V10cyl.	15953cc	236kW (320PS)	Diesel		TD8180
OM 403.916	V10cyl.	15953cc	235kW (320PS)	Diesel		TD5816
OM 403.917	V10cyl.	15953cc	236kW (320PS)	Diesel		TD16953





OM 403.918	V10cyl.	15953cc	235kW (320PS)	Diesel	TD7897
OM 403.919	V10cyl.	15953cc	236kW (320PS)	Diesel	TD16954
OM 403.930	V10cyl.	15953cc	236kW (320PS)	Diesel	TD16955
OM 403.931	V10cyl.	15953cc	235kW (320PS)	Diesel	TD5759
OM 403.932	V10cyl.	15953cc	235kW (320PS)	Diesel	TD6133
OM 403.934	V10cyl.	15953cc	236kW (320PS)	Diesel	TD16957
OM 404	V12cyl.	20911cc	184-236kW (250-320PS)	Diesel	MP3816

Cityliner	04/73→	0 303	10/74→06/83
INDUSTRIAL		Series 200	01/77→
NG	08/73→09/96	Transliner	12/88→

87-176800-00 STD

- A** 87.25
- B-** 23.50
- BØ** 65.00
- D** 137.25
-  46x97



AK RT

08-176800-10 STD

- 3.00  CR P
- 3.00  P
- 6.00  CR P

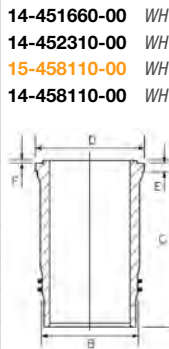

- 14-451660-00** WH **B** 140.00 **C** 253.00 **D** 152.00 **E** 10.07 **F** 1.00
- 14-452310-00** WH ① **B** 140.00 **C** 253.00 **D** 152.00 **E** 10.07 **F** 1.00
- 15-458110-00** WH ② **B** 144.50 **C** 253.00 **D** 153.80 **E** 9.92 **F** 1.00
- 14-458110-00** WH **B** 144.50 **C** 253.00 **D** 153.80 **E** 9.92 **F** 1.00

88-176800-00

87-176800-00 +
14-451660-00

① 4 O-ring = HT020
② Includes seals

① 4 Ringdichtungen = HT020
② Schließt Dichtungen ein

① 4 Joints toriques = HT020
② Inclut des joints

① 4 Juntas tóricas para = HT020
② Incluye los sellos

① 4 Gommini a Corredo = HT020
② Comprende le guarnizioni

 **125.00**

61

OM 401.970	V6cyl.	9572cc	213kW (290PS)	Diesel	Turbo Intercooled	TD7938
OM 401.972	V6cyl.	9572cc	230kW (313PS)	Diesel	Turbo Intercooled	TD5777
OM 401.973	V6cyl.	9572cc	200kW (272PS)	Diesel	Turbo Intercooled	TD5733
OM 401.984	V6cyl.	9572cc	180kW (245PS)	Diesel	Turbo Intercooled	TD8127
OM 401.985	V6cyl.	9572cc	200kW (272PS)	Diesel	Turbo Intercooled	TD5753
OM 401.986	V6cyl.	9572cc	230kW (313PS)	Diesel	Turbo Intercooled	TD8199
OM 401.987	V6cyl.	9572cc	230kW (313PS)	Diesel	Turbo Intercooled	TD6163
OM 401.989	V6cyl.	9572cc	200kW (272PS)	Diesel	Turbo Intercooled	TD6068
OM 401.990	V6cyl.	9572cc	180kW (245PS)	Diesel	Turbo Intercooled	TD16950
OM 401.991	V6cyl.	9572cc	200kW (272PS)	Diesel	Turbo Intercooled	TD6086
OM 401.992	V6cyl.	9572cc	200kW (272PS)	Diesel	Turbo Intercooled	TD17113
OM 401.993	V6cyl.	9572cc	230kW (313PS)	Diesel	Turbo Intercooled	TD6113
OM 401.994	V6cyl.	9572cc	180kW (245PS)	Diesel	Turbo Intercooled	TD6084
OM 402.984 (Euro 1)	V8cyl.	12763cc	280kW (381PS)	Diesel	Turbo Intercooled	TD11268

MK	12/87→09/96	0 404	09/91→10/99
0 304	08/92→	SK	07/87→09/96
0 340	01/91→12/95		





87-176000-10 STD

A 87.45
B- 25.00
BØ 66.84
D 132.45
 46x102

(12581E)
AK HA RT TP

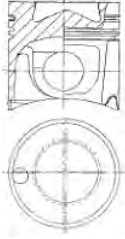

08-176000-00 STD

3.00  MOL ①
 3.00  MO P
 4.00  CR P

15-458110-00 WH ②
14-458110-00 WH
14-451660-00 WH
14-452310-00 WH ③

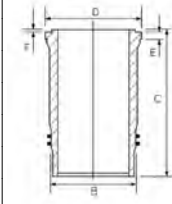

B 144.50 **C** 253.00 **D** 153.80 **E** 9.92 **F** 1.00
B 144.50 **C** 253.00 **D** 153.80 **E** 9.92 **F** 1.00
B 140.00 **C** 253.00 **D** 152.00 **E** 10.07 **F** 1.00
B 140.00 **C** 253.00 **D** 152.00 **E** 10.07 **F** 1.00

89-176000-10 ②
 87-176000-10 +
 15-458110-00

① Steel
 ② Includes seals
 ③ 4 O-ring = HT020

① Stahl
 ② Schließt Dichtungen ein
 ③ 4 Ringdichtungen = HT020

① Acier
 ② Inclut des joints
 ③ 4 Joints toriques = HT020

① Acero
 ② Incluye los sellos
 ③ 4 Juntas tóricas para = HT020

① Acciaio
 ② Comprende le guarnizioni
 ③ 4 Gomme a Corredo = HT020

125.00

62

OM 401.974 (Euro 1)	V6cyl.	9572cc	200kW (272PS)	Diesel	Turbo Intercooled	TD7939
OM 401.975 (Euro 1)	V6cyl.	9572cc	180kW (245PS)	Diesel	Turbo Intercooled	TD5751
OM 401.977 (Euro 1)	V6cyl.	9572cc	200kW (272PS)	Diesel	Turbo Intercooled	TD5801
OM 401.978 (Euro 1)	V6cyl.	9572cc	200kW (272PS)	Diesel	Turbo Intercooled	TD6065
OM 401.979 (Euro 1)	V6cyl.	9572cc	230kW (313PS)	Diesel	Turbo Intercooled	TD5780
OM 401.980 (Euro 1)	V6cyl.	9572cc	200kW (272PS)	Diesel	Turbo Intercooled	TD6293
OM 401.981 (Euro 1)	V6cyl.	9572cc	230kW (313PS)	Diesel	Turbo Intercooled	TD6162
OM 401.982 (Euro 1)	V6cyl.	9572cc	230kW (313PS)	Diesel	Turbo Intercooled	TD17103
OM 402.970 (Euro 1)	V8cyl.	12763cc	280kW (381PS)	Diesel	Turbo Intercooled	TD7940
OM 402.971 (Euro 1)	V8cyl.	12763cc	280kW (381PS)	Diesel	Turbo Intercooled	TD5783
OM 402.972 (Euro 1)	V8cyl.	12763cc	280kW (381PS)	Diesel	Turbo Intercooled	TD5784
OM 402.973 (Euro 1)	V8cyl.	12763cc	280kW (381PS)	Diesel	Turbo Intercooled	TD5832
OM 402.974 (Euro 1)	V8cyl.	12763cc	280-295kW (381-401PS)	Diesel	Turbo Intercooled	TD17807
OM 402.975 (Euro 1)	V8cyl.	12763cc	280kW (381PS)	Diesel	Turbo Intercooled	TD5818
OM 402.977 (Euro 1)	V8cyl.	12763cc	280kW (381PS)	Diesel	Turbo Intercooled	TD5826
OM 402.978 (Euro 1)	V8cyl.	12763cc	280kW (381PS)	Diesel	Turbo Intercooled	TD5786
OM 402.982 (Euro 1)	V8cyl.	12763cc	280kW (381PS)	Diesel	Turbo Intercooled	TD5830
OM 402.983 (Euro 1)	V8cyl.	12763cc	280kW (381PS)	Diesel	Turbo Intercooled	TD6182
OM 402.985 (Euro 1)	V8cyl.	12763cc	280kW (381PS)	Diesel	Turbo Intercooled	TD5806
OM 402.986 (Euro 1)	V8cyl.	12763cc	280kW (381PS)	Diesel	Turbo Intercooled	TD6151
OM 402.987 (Euro 1)	V8cyl.	12763cc	280kW (381PS)	Diesel	Turbo Intercooled	TD6178
OM 402.989 (Euro 1)	V8cyl.	12763cc	280kW (381PS)	Diesel	Turbo Intercooled	TD5807
OM 402.990 (Euro 1)	V8cyl.	12763cc	280kW (381PS)	Diesel	Turbo Intercooled	TD6153
OM 402.996 (Euro 1)	V8cyl.	12763cc	280kW (381PS)	Diesel	Turbo Intercooled	TD6121

E-Serie	01/90→12/96	O 404	09/91→10/99
MK	12/87→09/96	SK	07/87→09/96
O 403	09/03→	TOURISMO (O 350)	08/95→







87-176000-00 STD

- A** 87.30
- B-** 25.00
- BØ** 68.20
- D** 133.30
-  46x102

AK HA RT TP



08-176000-10 STD

- 3.00  **MOL** ①
- 3.00  **CK P**
- 4.00  **CR P**

15-458110-00 WH ②

14-458110-00 WH

14-451660-00 WH

14-452310-00 WH ③

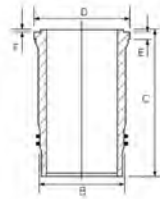

B 144.50 **C** 253.00 **D** 153.80 **E** 9.92 **F** 1.00

B 144.50 **C** 253.00 **D** 153.80 **E** 9.92 **F** 1.00

B 140.00 **C** 253.00 **D** 152.00 **E** 10.07 **F** 1.00

B 140.00 **C** 253.00 **D** 152.00 **E** 10.07 **F** 1.00

89-176000-00 ②

87-176000-00 +

15-458110-00

- ① Steel
- ② Includes seals
- ③ 4 O-ring = HT020

- ① Stahl
- ② Schließt Dichtungen ein
- ③ 4 Ringdichtungen = HT020

- ① Acier
- ② Inclut des joints
- ③ 4 Joints toriques = HT020

- ① Acero
- ② Incluye los sellos
- ③ 4 Juntas tóricas para = HT020

- ① Acciaio
- ② Comprende le guarnizioni
- ③ 4 Gommmini a Corredo = HT020

125.00							63
OM 401.983	V6cyl.	9572cc	180kW (245PS)	Diesel	Turbo Intercooled	TD17104	
OM 402.995	V8cyl.	12763cc	280kW (381PS)	Diesel	Turbo Intercooled	TD11267	
OM 403.910	V10cyl.	15953cc	184-236kW (250-321PS)	Diesel		TD28696	
OM 403.933	V10cyl.	15953cc	261kW (355PS)	Diesel		TD16956	
OM 403.935	V10cyl.	15953cc	236kW (320PS)	Diesel		TD6299	
OM 404 A	V12cyl.	20911cc	386kW (525PS)	Diesel	Turbo	MP4262	
Cityliner		04/73→		0 340		08/92→08/95	
INDUSTRIAL				Skyliner		01/79→	
NG		08/73→09/83					

- 14-451660-00** WH **B** 140.00 **C** 253.00 **D** 152.00 **E** 10.07 **F** 1.00
- 14-452310-00** WH ① **B** 140.00 **C** 253.00 **D** 152.00 **E** 10.07 **F** 1.00
- 15-458110-00** WH ② **B** 144.50 **C** 253.00 **D** 153.80 **E** 9.92 **F** 1.00
- 14-458110-00** WH **B** 144.50 **C** 253.00 **D** 153.80 **E** 9.92 **F** 1.00

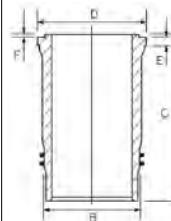

- ① 4 O-ring = HT020
- ② Includes seals

- ① 4 Ringdichtungen = HT020
- ② Schließt Dichtungen ein

- ① 4 Joints toriques = HT020
- ② Inclut des joints

- ① 4 Juntas tóricas para = HT020
- ② Incluye los sellos

- ① 4 Gommmini a Corredo = HT020
- ② Comprende le guarnizioni

125.00							64
OM 470.903 (Euro 6)	6cyl.	10677cc	240-315kW (326-428PS)	Diesel	Turbo Intercooled	TD29602	
OM 470.904 (Euro 6)	6cyl.	10677cc	240-335kW (326-456PS)	Diesel	Turbo Intercooled	TD35000	
OM 470.906 (Euro 6)	6cyl.	10677cc	240-375kW (326-510PS)	Diesel	Turbo Intercooled	TD27605	
OM 470.908 (Euro 6)	6cyl.	10677cc	240-315kW (326-428PS)	Diesel	Turbo Intercooled	TD30264	
OM 470.910 (Euro 6)	6cyl.	10677cc	240-335kW (326-455PS)	Diesel	Turbo Intercooled	TD28084	
OM 470.913 (Euro 6)	6cyl.	10677cc	240-335kW (326-456PS)	Diesel	Turbo Intercooled	TD33911	
OM 470.921 (Euro 6)	6cyl.	10677cc	240-335kW (326-456PS)	Diesel	Turbo Intercooled	TD35007	
OM 470.923 (Euro 6)	6cyl.	10677cc	240-335kW (326-456PS)	Diesel	Turbo Intercooled	TD35009	
ACTROS MP4 / MP5		07/11→		CAPACITY		01/15→	
ANTOS		07/12→12/18		Series 400		08/16→	
AROCS		01/13→		Series 500		01/13→	





87-444500-00 STD 1 2

A 68.00
 B- 14.22
 B- 6.00
 BØ 98.00
 C 3.00
 D 105.00
 55x82



(X6027F06)
 AK KK TP

08-444500-00 STD

3.50 GDC 3
 2.50 CR P
 3.50 CK P



1 Bowl capacity 75.740cm³

2 MonoSteel®

3 Steel

1 Volumen der Kolbenmulde 75.740cm³

3 Stahl

1 Volume de la cavité du piston 75.740cm³

3 Acier

1 Vol. cavidad pistón 75.740cm³

3 Acero

1 Volume camera pistone 75.740cm³

3 Acciaio

128.00							65
M 476.921 (M 447 G)	6cyl.	11967cc	175kW (238PS)	Petrol	Turbo Intercooled	TD22729	
M 476.925 (M 447 HG)	6cyl.	11967cc	177kW (241PS)	Petrol	Turbo Intercooled	TD22730	
M 476.926 (M 447 HG)	6cyl.	11967cc	177kW (241PS)	Petrol	Turbo Intercooled	TD22731	
M 476.927 (M 447 HG)	6cyl.	11967cc	177kW (241PS)	Petrol	Turbo Intercooled	TD22732	
M 476.930 (Euro 2 M447 hLAG)	6cyl.	11967cc	240kW (326PS)	Petrol	Turbo Intercooled	TD17490	
OM 447.916	6cyl.	11967cc	185kW (252PS)	Petrol		TD16987	
OM 427.905	6cyl.	11967cc	150kW (204PS)	Diesel		TD7951	
OM 427.910	6cyl.	11967cc	177kW (240PS)	Diesel		TD5671	
OM 427.911	6cyl.	11967cc	177kW (240PS)	Diesel		TD6010	
OM 427.950	6cyl.	11967cc	206kW (280PS)	Diesel	Turbo	TD7946	
OM 427.951	6cyl.	11967cc	206kW (280PS)	Diesel	Turbo	TD16964	
OM 427.952	6cyl.	11967cc	206kW (280PS)	Diesel	Turbo	TD16965	
OM 427 A	6cyl.	11967cc	206kW (280PS)	Diesel	Turbo	MP7065	
OM 427 LA	6cyl.	11967cc		Diesel	Turbo Intercooled	MP6707	
OM 429.951	5cyl.	9973cc	175kW (235PS)	Diesel	Turbo Intercooled	TD8164	
OM 429.952	5cyl.	9973cc	175kW (235PS)	Diesel	Turbo Intercooled	TD18818	
OM 429.953	5cyl.	9973cc	186kW (250PS)	Diesel	Turbo	TD5755	
OM 429.955	5cyl.	9973cc	186kW (250PS)	Diesel	Turbo Intercooled	TD6088	
OM 447	6cyl.	11967cc	147kW (200PS)	Diesel		MP7067	
OM 447.900	6cyl.	11967cc	147kW (200PS)	Diesel		TD28722	
OM 447.905	6cyl.	11967cc	150-177kW (204-241PS)	Diesel		TD7947	
OM 447.906	6cyl.	11967cc	177-184kW (240-250PS)	Diesel		TD5674	
OM 447.907	6cyl.	11967cc	177-184kW (240-250PS)	Diesel		TD5672	
OM 447.908	6cyl.	11967cc	177-184kW (240-250PS)	Diesel		TD6011	
OM 447.910	6cyl.	11967cc	177-184kW (240-250PS)	Diesel		TD7956	
OM 447.911	6cyl.	11967cc	150-157kW (204-214PS)	Diesel		TD7957	
OM 447.912	6cyl.	11967cc	184kW (250PS)	Diesel		TD7961	
OM 447.913 (Euro 1)	6cyl.	11967cc	150-157kW (204-214PS)	Diesel		TD7948	
OM 447.914 (Euro 1)	6cyl.	11967cc	150-157kW (204-214PS)	Diesel		TD7958	
OM 447.915	6cyl.	11967cc	185kW (252PS)	Diesel		TD16986	
OM 447.947 (Euro 1)	6cyl.	11967cc	220kW (299PS)	Diesel	Turbo Intercooled	TD22805	
OM 447.948 (Euro 2)	6cyl.	11967cc	220kW (299PS)	Diesel	Turbo Intercooled	TD22806	
OM 447.949 (Euro 2)	6cyl.	11967cc	157kW (214PS)	Diesel	Turbo Intercooled	TD22807	
OM 447.950	6cyl.	11967cc	206kW (280PS)	Diesel	Turbo	TD5673	
OM 447.951	6cyl.	11967cc	206kW (280PS)	Diesel	Turbo	TD6012	
OM 447.952 (Euro 1)	6cyl.	11967cc	206kW (280PS)	Diesel	Turbo	TD16988	





OM 447.953 (Euro 1)	6cyl.	11967cc	206kW (280PS)	Diesel	Turbo	TD16989
OM 447.960 (Euro 1)	6cyl.	11967cc	184kW (250PS)	Diesel	Turbo Intercooled	TD22808
OM 447 A/LA	6cyl.	11967cc	206kW (280PS)	Diesel	Turbo	MP7004
OM 447 LA	6cyl.	11967cc		Diesel	Turbo Intercooled	MP6705
OM 475.950 (OM449 A)	5cyl.	9973cc	184kW (250PS)	Diesel	Turbo	TD23240
OM 475.951 (OM449 A)	5cyl.	9973cc	184kW (250PS)	Diesel	Turbo	TD23241
OM 475.952 (OM449 A)	5cyl.	9973cc	184kW (250PS)	Diesel	Turbo	TD23242
OM 475.953 (OM449 A)	5cyl.	9973cc	184kW (250PS)	Diesel	Turbo	TD23243
OM 475.954 (OM449 A)	5cyl.	9973cc	184kW (250PS)	Diesel	Turbo	TD23244
OM 475.974 (OM449 LA)	5cyl.	9973cc	205kW (279PS)	Diesel	Turbo	TD28761
OM 475.976 (OM449 LA)	5cyl.	9973cc	205kW (279PS)	Diesel	Turbo	TD28762
OM 475.977 (OM449 LA)	5cyl.	9973cc	205kW (279PS)	Diesel	Turbo	TD28763
OM 475.978 (OM449 LA)	5cyl.	9973cc	235kW (320PS)	Diesel	Turbo	TD28764
OM 475.979 (OM449 LA)	5cyl.	9973cc	235kW (320PS)	Diesel	Turbo Intercooled	TD23245
OM 475.982 (OM449 LA)	5cyl.	9973cc	221kW (300PS)	Diesel	Turbo Intercooled	TD23246
OM 475.984 (OM449 LA)	5cyl.	9973cc	224kW (305PS)	Diesel	Turbo Intercooled	TD28765
OM 475.985 (OM449 LA)	5cyl.	9973cc	224kW (305PS)	Diesel	Turbo Intercooled	TD28766
OM 475.986 (OM449 LA)	5cyl.	9973cc	184kW (250PS)	Diesel	Turbo Intercooled	TD28767
OM 475.989 (OM449 LA)	5cyl.	9973cc	221kW (300PS)	Diesel	Turbo Intercooled	TD28768
OM 475.991 (OM449 LA)	5cyl.	9973cc	184kW (250PS)	Diesel	Turbo Intercooled	TD28769
OM 475.994 (OM449 LA)	5cyl.	9973cc	184kW (250PS)	Diesel	Turbo Intercooled	TD28770
OM 475.997 (OM449 LA)	5cyl.	9973cc	184-224kW (250-305PS)	Diesel	Turbo Intercooled	TD28771
OM 475.998 (OM449 LA)	5cyl.	9973cc	184kW (250PS)	Diesel	Turbo Intercooled	TD28772
OM 476.916 (OM447 A)	6cyl.	11967cc	213-246kW (290-335PS)	Diesel	Turbo	TD23807
OM 476.917 (OM447 LA)	6cyl.	11967cc	287-310kW (390-422PS)	Diesel	Turbo Intercooled	TD23806
OM 476.950 (OM447 A)	6cyl.	11967cc	215kW (292PS)	Diesel	Turbo	TD23809
OM 476.971 (Euro 2 OM447 LA)	6cyl.	11967cc	264kW (359PS)	Diesel	Turbo Intercooled	TD23227
OM 476.972 (Euro 2 OM447 LA)	6cyl.	11967cc	264kW (359PS)	Diesel	Turbo Intercooled	TD23228
OM 476.973 (Euro 2 OM447 LA)	6cyl.	11967cc	264kW (359PS)	Diesel	Turbo Intercooled	TD23229
OM 476.977 (Euro 2 OM447 LA)	6cyl.	11967cc	264kW (359PS)	Diesel	Turbo Intercooled	TD23230
OM 476.978 (Euro 2 OM447 LA)	6cyl.	11967cc	264kW (359PS)	Diesel	Turbo Intercooled	TD23231
OM 476.979 (Euro 2 OM447 LA)	6cyl.	11967cc	264kW (359PS)	Diesel	Turbo Intercooled	TD23232
OM 476.980 (Euro 2 OM447 LA)	6cyl.	11967cc	257kW (350PS)	Diesel	Turbo Intercooled	TD23233
OM 476.981 (OM447 LA)	6cyl.	11967cc	257kW (350PS)	Diesel	Turbo Intercooled	TD23234
OM 476.982 (OM447 LA)	6cyl.	11967cc	257kW (350PS)	Diesel	Turbo Intercooled	TD23235
OM 476.983 (Euro 2 OM447 LA)	6cyl.	11967cc	257-260kW (350-354PS)	Diesel	Turbo Intercooled	TD23236
OM 476.985 (Euro 1 OM447 LA)	6cyl.	11967cc	261kW (355PS)	Diesel	Turbo Intercooled	TD23237
OM 476.988 (OM447 LA)	6cyl.	11967cc	257kW (350PS)	Diesel	Turbo Intercooled	TD23238
OM 476.991 (OM447 LA)	6cyl.	11967cc	257kW (350PS)	Diesel	Turbo Intercooled	TD23239
OM 476.992 (OM447 LA)	6cyl.	11967cc	257kW (350PS)	Diesel	Turbo Intercooled	TD23805
OM 485.980	5cyl.	9973cc	221kW (301PS)	Diesel	Turbo Intercooled	TD28774
OM 489.960 (Euro 1)	5cyl.	9973cc	155kW (211PS)	Diesel	Turbo Intercooled	TD22820
OM 489.961 (Euro 1)	5cyl.	9973cc	184kW (250PS)	Diesel	Turbo Intercooled	TD22821
AGL (RoundNose)			05/90→05/05			0 371
BASIC ENGINE						0 400
CITARO (O 530)			04/00→			0 405
CONECTO (O 345)			11/01→			0 407
HPN (LongNose)			05/90→			0 408
INDUSTRIAL						
						01/91→12/02
						01/02→12/06
						12/84→
						03/87→11/01
						01/91→12/98



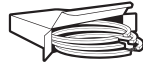

15-456980-00 WH ¹ B 144.50 C 270.00 D 153.80 E 9.92 F 1.00
 14-456980-00 WH B 144.50 C 270.00 D 153.80 E 9.92 F 1.00

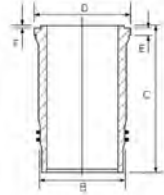

¹ Includes seals

¹ Schließt Dichtungen ein

¹ Inclut des joints

¹ Incluye los sellos

¹ Comprende le guarnizioni

128.00						66
OM 335.910	6cyl.	11581cc	176kW (239PS)	Diesel	TD28457	
OM 335.930	6cyl.	11581cc	154kW (209PS)	Diesel	TD28458	
OM 335.932	6cyl.	11581cc	176kW (239PS)	Diesel	TD28459	
OM 345.910 (OM355)	6cyl.	11581cc	177kW (241PS)	Diesel	TD28599	
OM 345.912 (OM355)	6cyl.	11581cc	177kW (241PS)	Diesel	TD28600	
OM 345.914 (OM355)	6cyl.	11581cc	103-135kW (140-184PS)	Diesel	TD28602	
OM 345.915 (OM355)	5cyl.	9651cc	141kW (192PS)	Diesel	TD28603	
OM 345.919 (OM355)	5cyl.	9651cc	114-127kW (155-173PS)	Diesel	TD28604	
OM 345.932 (OM355)	6cyl.	11581cc	147kW (200PS)	Diesel	TD28605	
OM 345.933 (OM355)	6cyl.	11581cc	137kW (186PS)	Diesel	TD28606	
OM 345.936 (OM355)	6cyl.	11581cc	154kW (209PS)	Diesel	TD28607	
OM 345.937 (OM355)	6cyl.	11581cc	177kW (241PS)	Diesel	TD28608	
OM 345.941 (OM355)	5cyl.	9651cc	125kW (170PS)	Diesel	TD28636	
OM 345.942 (OM355)	5cyl.	9651cc	141kW (192PS)	Diesel	TD28637	
OM 345.945 (OM355)	5cyl.	9651cc	125kW (170PS)	Diesel	TD28638	
OM 345.946 (OM355)	5cyl.	9651cc	141kW (192PS)	Diesel	TD28639	
OM 345.947 (OM355)	5cyl.	9651cc	132kW (180PS)	Diesel	TD28640	
OM 345.949 (OM355)	5cyl.	9651cc	150kW (204PS)	Diesel	TD28641	
OM 345.972 (OM355)	5cyl.	9651cc	143kW (194PS)	Diesel	TD28643	
OM 345.973 (OM355)	5cyl.	9651cc	147kW (200PS)	Diesel	TD28644	
OM 345.975 (OM355)	5cyl.	9651cc	143kW (194PS)	Diesel	TD28645	
OM 347.915 (OM355)	5cyl.	9651cc	141kW (192PS)	Diesel	TD28652	
OM 347.942 (OM355)	5cyl.	9651cc	147kW (200PS)	Diesel	TD28653	
OM 347.943 (OM355)	5cyl.	9651cc	147kW (200PS)	Diesel	TD28654	
OM 355.910	6cyl.	11581cc	169kW (230PS)	Diesel	TD16668	
OM 355.911	6cyl.	11581cc	169kW (230PS)	Diesel	TD16669	
OM 355.912	6cyl.	11581cc	169kW (230PS)	Diesel	TD16670	
OM 355.913	6cyl.	11581cc	169kW (230PS)	Diesel	TD16671	
OM 355.914	6cyl.	11581cc	169kW (230PS)	Diesel	TD16672	
OM 355.915	6cyl.	11581cc	169kW (230PS)	Diesel	TD7892	
OM 355.916	6cyl.	11581cc	169kW (230PS)	Diesel	TD22746	
OM 355.918	6cyl.	11581cc	169kW (230PS)	Diesel	TD16673	
OM 355.960	6cyl.	11581cc	176kW (240PS)	Diesel	TD5813	
OM 355.961	6cyl.	11581cc	155kW (210PS)	Diesel	TD16675	
OM 355.962	6cyl.	11581cc	177kW (240PS)	Diesel	TD16676	
OM 355.963	6cyl.	11581cc	176kW (240PS)	Diesel	TD5812	
OM 355.964	6cyl.	11581cc	177kW (240PS)	Diesel	TD16677	
OM 355.966	6cyl.	11581cc	155kW (210PS)	Diesel	TD16678	





OM 355.967	6cyl.	11581cc	177kW (240PS)	Diesel	TD7893
OM 355.970	6cyl.	11581cc	191kW (260PS)	Diesel	TD16679
OM 355.972	6cyl.	11581cc	136kW (185PS)	Diesel	TD16680
OM 355.973	6cyl.	11581cc	177kW (240PS)	Diesel	TD16681
OM 355.974	6cyl.	11581cc	177kW (240PS)	Diesel	TD16682
OM 355.975	6cyl.	11581cc	176kW (240PS)	Diesel	TD6160
OM 355.976	6cyl.	11581cc	176kW (240PS)	Diesel	TD6159
OM 355.978	6cyl.	11581cc	177kW (240PS)	Diesel	TD16684
OM 355.979	6cyl.	11581cc	177kW (240PS)	Diesel	TD16685
OM 355.980	6cyl.	11581cc	177kW (240PS)	Diesel	TD16686
OM 355.981	6cyl.	11581cc	184kW (250PS)	Diesel	TD16687
OM 355.982	6cyl.	11581cc	184kW (250PS)	Diesel	TD16674
OM 355.983	6cyl.	11581cc	177kW (240PS)	Diesel	TD5811
OM 355.984	6cyl.	11581cc	177kW (240PS)	Diesel	TD6158

AGL (RoundNose) 01/73→ 0 364 01/85→
 HPN (LongNose) 01/76→05/97 T2/L 01/59→01/95

87-176900-00 STD
87-176911-00 1.00mm □

A 90.26
B- 27.00
BØ 70.00
C 1.10
D 161.26
 48x108



RT

08-176900-30 STD

3.50 CK P
 3.50 P
 3.50 P
 6.50 CR P



14-025890-00 D B 133.56 C 287.50 D 137.50 E 5.50
14-025891-00 D B 134.06 C 287.50 D 138.00 E 5.50
14-025892-00 D B 134.56 C 287.50 D 138.50 E 5.50

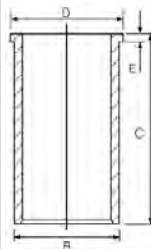

□ A = 90.060, B- = 26.800, D = 161.060

128.00

67

OM 345.913 (OM355)	6cyl.	11581cc	210kW (286PS)	Diesel Turbo	TD28601
OM 345.960 (OM355 A)	6cyl.	11581cc	210kW (286PS)	Diesel Turbo	TD28642
OM 355.968	6cyl.	11581cc	191kW (260PS)	Diesel	TD23185
OM 355.969	6cyl.	11581cc	206kW (280PS)	Diesel Turbo	TD8212
OM 355.977	6cyl.	11581cc	205kW (275PS)	Diesel Turbo	TD16683

HPN (LongNose) 04/83→04/98 T2/L 01/59→01/95

14-025890-00 D B 133.56 C 287.50 D 137.50 E 5.50
14-025891-00 D B 134.06 C 287.50 D 138.00 E 5.50
14-025892-00 D B 134.56 C 287.50 D 138.50 E 5.50

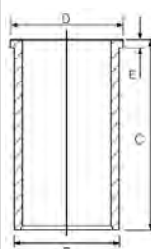

128.00

68

OM 421.905	V6cyl.	10964cc	159kW (216PS)	Diesel	TD5799
OM 421.906	V6cyl.	10964cc	159kW (216PS)	Diesel	TD8120
OM 421.907	V6cyl.	10964cc	159kW (216PS)	Diesel	TD6139





OM 421.908	V6cyl.	10964cc	159kW (216PS)	Diesel		TD7898
OM 421.909	V6cyl.	10964cc	159kW (216PS)	Diesel		TD17056
OM 421.910	V6cyl.	10964cc	159kW (216PS)	Diesel		TD16958
OM 422.905	V8cyl.	14618cc	206kW (280PS)	Diesel		TD5760
OM 422.906	V8cyl.	14618cc	206kW (280PS)	Diesel		TD6093
OM 422.907	V8cyl.	14618cc	206kW (280PS)	Diesel		TD5805
OM 422.908	V8cyl.	14618cc	206kW (280PS)	Diesel		TD7900
OM 422.909	V8cyl.	14618cc	184kW (250PS)	Diesel		TD8157
OM 422.910	V8cyl.	14618cc	206kW (280PS)	Diesel		TD6132
OM 422.911	V8cyl.	14618cc	206kW (280PS)	Diesel		TD6140
OM 422.912	V8cyl.	14618cc	184kW (250PS)	Diesel		TD8231
OM 422.913	V8cyl.	14618cc	206kW (280PS)	Diesel		TD6149
OM 422.914	V8cyl.	14618cc	206kW (280PS)	Diesel		TD5828
OM 422.915	V8cyl.	14618cc	184kW (250PS)	Diesel		TD16959
OM 422.916	V8cyl.	14618cc	206kW (280PS)	Diesel		TD17111
OM 422.917	V8cyl.	14618cc	206kW (280PS)	Diesel		TD11029
OM 422.918	V8cyl.	14618cc	206kW (280PS)	Diesel		TD16960
OM 422.919	V8cyl.	14618cc	206kW (280PS)	Diesel		TD5821
OM 422.920	V8cyl.	14618cc	184kW (250PS)	Diesel		TD8249
OM 422.921	V8cyl.	14618cc	206kW (280PS)	Diesel		TD6173
OM 422.922	V8cyl.	14618cc	206kW (280PS)	Diesel		TD16961
OM 422.923	V8cyl.	14618cc	206kW (280PS)	Diesel		TD16962
OM 423.905	V10cyl.	18273cc	261kW (355PS)	Diesel		TD5762
OM 423.906	V10cyl.	18273cc	261kW (355PS)	Diesel	Turbo	TD6126
OM 423.907	V10cyl.	18273cc	261kW (355PS)	Diesel	Turbo	TD6289
OM 423.908	V10cyl.	18273cc	261kW (355PS)	Diesel	Turbo	TD6096
OM 423.909	V10cyl.	18273cc	261kW (355PS)	Diesel		TD16963
OM 424.900	V12cyl.	21927cc	309kW (420PS)	Diesel		TD18815

Cityliner	04/73→	O 303	01/80→09/87
Jetliner	09/90→09/93	OH	01/70→
NG	08/73→09/96	SK	07/87→09/96
O 302	11/64→12/75	Z-Serie	01/81→12/92

87-181700-00 STD

- A 81.35
- B- 24.10
- BØ 70.00
- D 126.35
- 46x99
- (12814E)
- RT



08-181700-00 STD

- 3.00 MOL P
- 3.00 MO P
- 4.00 CR P



- 15-451160-00 WH
- 14-451160-00 WH
- 15-452030-00 WH
- 14-452030-00 WH

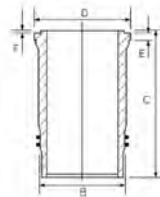

- 89-181700-60
- 87-181700-00 + 15-451160-00
- 89-181700-61
- 87-181700-00 + 15-452030-00

Includes seals

Schließt Dichtungen ein

Inclut des joints

Incluye los sellos

Comprende le guarnizioni

128.00

69

OM 421.951	V6cyl.	10964cc	184kW (250PS)	Diesel	Turbo	TD7899
OM 422.901	V8cyl.	14618cc	243-276kW (330-375PS)	Diesel	Turbo	TD18973
OM 422.951	V8cyl.	14618cc	243kW (330PS)	Diesel	Turbo	TD7901
OM 422.952	V8cyl.	14618cc	243kW (330PS)	Diesel	Turbo	TD5761
OM 422.953	V8cyl.	14618cc	276kW (375PS)	Diesel	Turbo Intercooled	TD5763





OM 422.954	V8cyl.	14618cc	243kW (330PS)	Diesel	Turbo	TD6095
OM 422.955	V8cyl.	14618cc	276kW (375PS)	Diesel	Turbo Intercooled	TD5800
OM 422.956	V8cyl.	14618cc	243kW (330PS)	Diesel	Turbo	TD6134
OM 422.957	V8cyl.	14618cc	243kW (330PS)	Diesel	Turbo	TD9613
OM 422.958	V8cyl.	14618cc	243kW (330PS)	Diesel	Turbo	TD9614
OM 422.959	V8cyl.	14618cc	276kW (375PS)	Diesel	Turbo	TD6141
OM 422.963	V8cyl.	14618cc	243kW (330PS)	Diesel	Turbo	TD11028
OM 423.950	V10cyl.	18273cc	368kW (500PS)	Diesel	Turbo Intercooled	TD5827
OM 424.901	V12cyl.	21927cc	441kW (600PS)	Diesel	Turbo Intercooled	TD18816
OM 424.901.510	V12cyl.	21927cc	441kW (600PS)	Diesel	Turbo Intercooled	TD18817

Cityliner	11/91→	SK	07/87→09/96
NG	08/73→09/96	Skyliner	09/90→
0 303	08/80→04/89		

87-179300-70 STD

- A 81.35
- B- 25.40
- BØ 70.00
- D 126.35
-  46x105
- (12824C)
- AK RT



08-179300-10 STD

- 3.00  MOL ¹
- 3.00  CR P
- 4.00  CR P

- 15-451160-00 WH ² B 144.50 C 253.00 D 153.80 E 10.07 F 1.00
- 14-451160-00 WH B 144.50 C 253.00 D 153.80 E 10.07 F 1.00
- 15-452030-00 WH ² B 144.50 C 253.00 D 153.80 E 9.92 F 1.00
- 14-452030-00 WH B 144.50 C 253.00 D 153.80 E 9.92 F 1.00

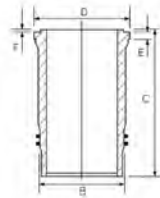

89-179300-70

87-179300-70 +
15-451160-00

89-179300-71 ²

87-179300-70 +
15-452030-00

- ¹ Steel
- ² Includes seals

- ¹ Stahl
- ² Schließt Dichtungen ein

- ¹ Acier
- ² Inclut des joints

- ¹ Acero
- ² Incluye los sellos

- ¹ Acciaio
- ² Comprende le guarnizioni

128.00 70

OM 441.950	V6cyl.	10964cc	191-200kW (260-272PS)	Diesel	Turbo	TD5661
OM 441.951	V6cyl.	10964cc	243kW (330PS)	Diesel	Turbo Intercooled	TD8187
OM 441.953	V6cyl.	10964cc	191-200kW (260-272PS)	Diesel	Turbo	TD5999
OM 441.960	V6cyl.	10964cc	243-250kW (330-340PS)	Diesel	Turbo Intercooled	TD5772
OM 441.961	V6cyl.	10964cc	250kW (340PS)	Diesel	Turbo Intercooled	TD16973
OM 441.962	V6cyl.	10964cc	243-249kW (330-340PS)	Diesel	Turbo Intercooled	TD6104
OM 441.981	V6cyl.	10964cc	243-249kW (330-340PS)	Diesel	Turbo Intercooled	TD6103
OM 441.982	V6cyl.	10964cc	250kW (340PS)	Diesel	Turbo Intercooled	TD5824
OM 441.983	V6cyl.	10964cc	243-249kW (330-340PS)	Diesel	Turbo Intercooled	TD6322
OM 441.985	V6cyl.	10964cc	250kW (340PS)	Diesel	Turbo Intercooled	TD6176
OM 442.901	V8cyl.	14618cc	320-362kW (435-492PS)	Diesel	Turbo Intercooled	TD28718
OM 442.940	V8cyl.	14618cc	260kW (354PS)	Diesel	Turbo	TD17131
OM 442.941	V8cyl.	14618cc	269kW (366PS)	Diesel	Turbo	TD16978
OM 442.942	V8cyl.	14618cc	260-269kW (354-366PS)	Diesel	Turbo	TD5774
OM 442.943	V8cyl.	14618cc	269kW (366PS)	Diesel	Turbo	TD5793
OM 442.944	V8cyl.	14618cc	260-269kW (354-366PS)	Diesel	Turbo	TD5773
OM 442.945	V8cyl.	14618cc	269kW (366PS)	Diesel	Turbo	TD5829
OM 442.946	V8cyl.	14618cc	266kW (366PS)	Diesel	Turbo	TD5831
OM 442.951	V8cyl.	14618cc	320kW (435PS)	Diesel	Turbo Intercooled	TD5765
OM 442.953	V8cyl.	14618cc	320-329kW (435-447PS)	Diesel	Turbo Intercooled	TD5819
OM 442.954	V8cyl.	14618cc	269kW (366PS)	Diesel	Turbo	TD10972
OM 442.955	V8cyl.	14618cc	269kW (366PS)	Diesel	Turbo	TD10973
OM 442.957	V8cyl.	14618cc	266-269kW (366-366PS)	Diesel	Turbo	TD6183





OM 442.958	V8cyl.	14618cc	260-269kW (354-366PS)	Diesel	Turbo	TD6290
OM 442.959	V8cyl.	14618cc	269kW (366PS)	Diesel	Turbo	TD6161
OM 442.960	V8cyl.	14618cc	260-269kW (354-365PS)	Diesel	Turbo	TD5663
OM 442.961	V8cyl.	14618cc	260-269kW (354-365PS)	Diesel	Turbo	TD6001
OM 442.963	V8cyl.	14618cc	260-269kW (354-366PS)	Diesel	Turbo	TD5802
OM 442.964	V8cyl.	14618cc	260-269kW (354-366PS)	Diesel	Turbo	TD6146
OM 442.965	V8cyl.	14618cc	260-269kW (354-366PS)	Diesel	Turbo	TD6292
OM 442.966	V8cyl.	14618cc	260-269kW (354-366PS)	Diesel	Turbo	TD6300
OM 442.967	V8cyl.	14618cc	269kW (366PS)	Diesel	Turbo	TD17809
OM 442.968	V8cyl.	14618cc	260-269kW (354-366PS)	Diesel	Turbo	TD6147
OM 442.970	V8cyl.	14618cc	260kW (354PS)	Diesel	Turbo	TD17132
OM 442.971	V8cyl.	14618cc	269kW (366PS)	Diesel	Turbo	TD5795
OM 442.972	V8cyl.	14618cc	269kW (366PS)	Diesel	Turbo	TD6131
OM 442.976	V8cyl.	14618cc	260-269kW (354-366PS)	Diesel	Turbo	TD6323
OM 442.980	V8cyl.	14618cc	320kW (435PS)	Diesel	Turbo Intercooled	TD6169
OM 442.982	V8cyl.	14618cc	320-362kW (435-492PS)	Diesel	Turbo Intercooled	TD5796
OM 442.983	V8cyl.	14618cc	329kW (447PS)	Diesel	Turbo Intercooled	TD8248
OM 442.985	V8cyl.	14618cc	320-362kW (435-492PS)	Diesel	Turbo Intercooled	TD5775
OM 442.989	V8cyl.	14618cc	362kW (492PS)	Diesel	Turbo Intercooled	TD5817
OM 442.991	V8cyl.	14618cc	362kW (492PS)	Diesel	Turbo Intercooled	TD17137
OM 442.992	V8cyl.	14618cc	320-362kW (435-492PS)	Diesel	Turbo Intercooled	TD6301
OM 442.993	V8cyl.	14618cc	362kW (492PS)	Diesel	Turbo Intercooled	TD8259
OM 442.994	V8cyl.	14618cc	362kW (492PS)	Diesel	Turbo Intercooled	TD6165
OM 443.901	V10cyl.	18273cc	331kW (450PS)	Diesel	Turbo	TD28721
OM 443.940	V10cyl.	18273cc	340kW (462PS)	Diesel	Turbo	TD8214
OM 443.980	V10cyl.	18273cc	412kW (560PS)	Diesel	Turbo Intercooled	TD8254
OM 444.901	V12cyl.	21927cc	344-422kW (468-574PS)	Diesel	Turbo	TD36935

MK	12/87→09/96	O 330	01/90→
NG	08/73→09/96	Series 300	09/91→02/02
O 303	11/85→09/92	SK	07/87→09/96

87-179300-65 STD 
→02/91, →Eng.622823



A 81.35
B- 27.50
BØ 66.60
D 126.35
 46x105

AK HA NB RT





08-179300-10 STD

3.00  MOL 
3.00  CR P
4.00  CR P

15-451160-00 WH 
14-451160-00 WH
15-452030-00 WH 
14-452030-00 WH

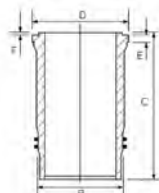
B 144.50 C 253.00 D 153.80 E 10.07 F 1.00
B 144.50 C 253.00 D 153.80 E 10.07 F 1.00
B 144.50 C 253.00 D 153.80 E 9.92 F 1.00
B 144.50 C 253.00 D 153.80 E 9.92 F 1.00



89-179300-65 
87-179300-65 +
15-451160-00
89-179300-66 
87-179300-65 +
15-452030-00





87-179300-85 STD
03/91 →, Eng.622824 →

A 81.45
B- 27.50
BØ 66.60
D 126.45
 46x105



HA KK RT TP

08-179300-10 STD

3.00  MOL ²
3.00  CR P
4.00  CR P

15-451160-00 WH ³ **B** 144.50 **C** 253.00 **D** 153.80 **E** 10.07 **F** 1.00
14-451160-00 WH **B** 144.50 **C** 253.00 **D** 153.80 **E** 10.07 **F** 1.00
15-452030-00 WH ³ **B** 144.50 **C** 253.00 **D** 153.80 **E** 9.92 **F** 1.00
14-452030-00 WH **B** 144.50 **C** 253.00 **D** 153.80 **E** 9.92 **F** 1.00

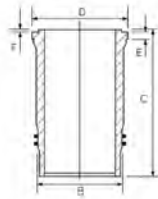

89-179300-85 ³
87-179300-85 +
15-451160-00
89-179300-86 ³
87-179300-85 +
15-452030-00

87-179300-90 STD
03/91 →, Eng.622824 →

A 81.35
B- 27.50
BØ 66.17
D 126.35
 46x105
(12827A201)



AK HA RT TP

08-179300-10 STD

3.00  MOL ²
3.00  CR P
4.00  CR P

15-451160-00 WH ³ **B** 144.50 **C** 253.00 **D** 153.80 **E** 10.07 **F** 1.00
14-451160-00 WH **B** 144.50 **C** 253.00 **D** 153.80 **E** 10.07 **F** 1.00
15-452030-00 WH ³ **B** 144.50 **C** 253.00 **D** 153.80 **E** 9.92 **F** 1.00
14-452030-00 WH **B** 144.50 **C** 253.00 **D** 153.80 **E** 9.92 **F** 1.00

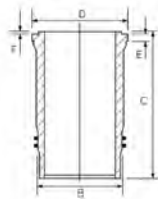

89-179300-90 ³
87-179300-90 +
15-451160-00
89-179300-91 ³
87-179300-90 +
15-452030-00

¹ Version with domed crown bowl

¹ Version mit Erhebung in der Mulde

¹ Version avec dôme de chambre arrondi

¹ Versión con cabeza convexa

¹ Versione con camera di combustione convessa

² Steel

² Stahl

² Acier

² Acero

² Acciaio

³ Includes seals

³ Schließt Dichtungen ein

³ Inclut des joints

³ Incluye los sellos

³ Comprende le guarnizioni

 **128.00**

71

OM 423.901	V10cyl.	18273cc	184-418kW (250-568PS)	Diesel		TD28707
OM 440.948 (OM442 A)	V8cyl.	14618cc	269kW (366PS)	Diesel	Turbo	TD17123
OM 440.949 (OM442 A)	V8cyl.	14618cc	250kW (340PS)	Diesel	Turbo	TD17124
OM 440.974 (OM442 LA)	V8cyl.	14618cc	320kW (435PS)	Diesel	Turbo Intercooled	TD17125
OM 441.952	V6cyl.	10964cc	191kW (260PS)	Diesel	Turbo	TD17128
OM 442 A	V8cyl.	14618cc	269kW (366PS)	Diesel	Turbo	MP7006
OM 444 LA	V12cyl.	21927cc	478-610kW (530-830PS)	Diesel	Turbo Intercooled	MP6642
OM 481.902	V6cyl.	10964cc	159kW (216PS)	Diesel		TD17814
OM 481.904	V6cyl.	10964cc	159kW (216PS)	Diesel		TD17815
OM 482.912	V8cyl.	14618cc	206kW (280PS)	Diesel		TD22816
OM 482.930	V8cyl.	14618cc	206kW (280PS)	Diesel		TD22817
OM 482.940	V8cyl.	14618cc	269kW (366PS)	Diesel	Turbo	TD22818
OM 482.941	V8cyl.	14618cc	269kW (366PS)	Diesel	Turbo	TD22819

INDUSTRIAL

0 302

11/64 →12/75





15-451160-00 WH B 144.50 C 253.00 D 153.80 E 10.07 F 1.00
14-451160-00 WH B 144.50 C 253.00 D 153.80 E 10.07 F 1.00
15-452030-00 WH B 144.50 C 253.00 D 153.80 E 9.92 F 1.00
14-452030-00 WH B 144.50 C 253.00 D 153.80 E 9.92 F 1.00

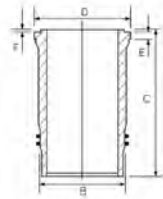

Includes seals

Schließt Dichtungen ein

Inclut des joints

Incluye los sellos

Comprende le guarnizioni

128.00							72
OM 440.970 (Euro 1 OM442 LA)	V8cyl.	14618cc	320kW (435PS)	Diesel	Turbo Intercooled	TD5797	
OM 440.971 (Euro 1 OM442 LA)	V8cyl.	14618cc	370kW (503PS)	Diesel	Turbo Intercooled	TD5788	
OM 440.972 (Euro 1 OM442 LA)	V8cyl.	14618cc	320kW (435PS)	Diesel	Turbo Intercooled	TD16968	
OM 440.973 (Euro 1 OM442 LA)	V8cyl.	14618cc	370kW (503PS)	Diesel	Turbo Intercooled	TD6124	
OM 440.975 (Euro 1 OM442 LA)	V8cyl.	14618cc	370kW (503PS)	Diesel	Turbo Intercooled	TD5833	
OM 440.976 (Euro 1 OM442 LA)	V8cyl.	14618cc	370kW (503PS)	Diesel	Turbo Intercooled	TD8227	
OM 440.978 (Euro 1 OM442 LA)	V8cyl.	14618cc	320kW (435PS)	Diesel	Turbo Intercooled	TD5787	
OM 440.979 (Euro 1 OM442 LA)	V8cyl.	14618cc	320kW (435PS)	Diesel	Turbo Intercooled	TD6138	
OM 440.980 (Euro 1 OM442 LA)	V8cyl.	14618cc	320kW (435PS)	Diesel	Turbo Intercooled	TD6179	
OM 440.981 (Euro 1 OM442 LA)	V8cyl.	14618cc	370kW (503PS)	Diesel	Turbo Intercooled	TD6152	
OM 440.982 (Euro 1 OM442 LA)	V8cyl.	14618cc	370kW (503PS)	Diesel	Turbo Intercooled	TD6185	
OM 440.983 (Euro 1 OM442 LA)	V8cyl.	14618cc	370kW (503PS)	Diesel	Turbo Intercooled	TD6306	
OM 440.984 (Euro 1 OM442 LA)	V8cyl.	14618cc	320kW (435PS)	Diesel	Turbo Intercooled	TD6305	
OM 440.985 (Euro 1 OM442 LA)	V8cyl.	14618cc	320kW (435PS)	Diesel	Turbo Intercooled	TD8256	
OM 440.986 (Euro 1 OM442 LA)	V8cyl.	14618cc	320kW (435PS)	Diesel	Turbo Intercooled	TD16969	
OM 440.987 (Euro 1 OM442 LA)	V8cyl.	14618cc	280kW (381PS)	Diesel	Turbo Intercooled	TD16970	
OM 440.988 (Euro 1 OM442 LA)	V8cyl.	14618cc	280kW (381PS)	Diesel	Turbo Intercooled	TD17126	
OM 440.989 (Euro 1 OM442 LA)	V8cyl.	14618cc	280kW (381PS)	Diesel	Turbo Intercooled	TD16971	
OM 440.990 (Euro 1 OM442 LA)	V8cyl.	14618cc	280kW (381PS)	Diesel	Turbo Intercooled	TD8225	
OM 440.991 (Euro 1 OM442 LA)	V8cyl.	14618cc	320kW (435PS)	Diesel	Turbo Intercooled	TD6122	
OM 441.980	V6cyl.	10964cc	250kW (340PS)	Diesel	Turbo Intercooled	TD7943	
OM 441.986 (Euro 1)	V6cyl.	10964cc	250kW (340PS)	Diesel	Turbo Intercooled	TD5779	
OM 441.987 (Euro 1)	V6cyl.	10964cc	250kW (340PS)	Diesel	Turbo Intercooled	TD5782	
OM 441.988 (Euro 1)	V6cyl.	10964cc	250kW (340PS)	Diesel	Turbo Intercooled	TD5825	
OM 441.989 (Euro 1)	V6cyl.	10964cc	250kW (340PS)	Diesel	Turbo Intercooled	TD5736	
OM 441.990 (Euro 1)	V6cyl.	10964cc	250kW (340PS)	Diesel	Turbo Intercooled	TD6177	
OM 441.991 (Euro 1)	V6cyl.	10964cc	250kW (340PS)	Diesel	Turbo Intercooled	TD6118	
OM 441.992 (Euro 1)	V6cyl.	10964cc	250kW (340PS)	Diesel	Turbo Intercooled	TD6302	
OM 441.993 (Euro 1)	V6cyl.	10964cc	250kW (340PS)	Diesel	Turbo Intercooled	TD6069	
OM 441.994 (Euro 1)	V6cyl.	10964cc	250kW (340PS)	Diesel	Turbo Intercooled	TD16974	
OM 441.995 (Euro 1)	V6cyl.	10964cc	250kW (340PS)	Diesel	Turbo Intercooled	TD16975	
OM 441.996 (Euro 1)	V6cyl.	10964cc	250kW (340PS)	Diesel	Turbo Intercooled	TD6116	
OM 441.997 (Euro 1)	V6cyl.	10964cc	230kW (313PS)	Diesel	Turbo Intercooled	TD16976	
OM 441.998 (Euro 1)	V6cyl.	10964cc	230kW (313PS)	Diesel	Turbo Intercooled	TD8222	
OM 441.999 (Euro 1)	V6cyl.	10964cc	250kW (340PS)	Diesel	Turbo Intercooled	TD16977	
OM 442.995 (Euro 1)	V8cyl.	14618cc	320kW (435PS)	Diesel	Turbo Intercooled	TD16979	
OM 442.996 (Euro 1)	V8cyl.	14618cc	370kW (503PS)	Diesel	Turbo Intercooled	TD16980	





OM 442.997 (Euro 1)	V8cyl.	14618cc	370kW (503PS)	Diesel	Turbo Intercooled	TD5810
OM 442.998 (Euro 1)	V8cyl.	14618cc	370kW (503PS)	Diesel	Turbo Intercooled	TD6157
OM 442.999 (Euro 1)	V8cyl.	14618cc	370kW (503PS)	Diesel	Turbo Intercooled	TD17810
HPN (LongNose)			11/91→12/05	0 403		01/03→
Megaliner			01/93→	0 404		01/91→12/99
MK			12/87→09/96	SK		07/87→09/96
0 304			01/90→	TOURISMO (0 350)		08/95→
0 340			01/91→06/95	Transliner		12/88→

87-179300-15 STD

- A** 81.35
- B-** 24.30
- BØ** 66.90
- D** 126.35
-  46x105

(12833H101)

AK HA KK RT TP



08-179300-10 STD

- 3.00  MOL ¹
- 3.00  CR P
- 4.00  CR P

- 15-452030-00** WH ² **B** 144.50 **C** 253.00 **D** 153.80 **E** 9.92 **F** 1.00
- 14-452030-00** WH **B** 144.50 **C** 253.00 **D** 153.80 **E** 9.92 **F** 1.00
- 15-451160-00** WH ² **B** 144.50 **C** 253.00 **D** 153.80 **E** 10.07 **F** 1.00
- 14-451160-00** WH **B** 144.50 **C** 253.00 **D** 153.80 **E** 10.07 **F** 1.00

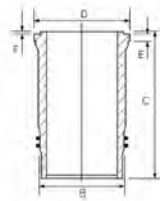

89-179300-15 ²

87-179300-15 +
15-452030-00

- ¹ Steel
- ² Includes seals

- ¹ Stahl
- ² Schließt Dichtungen ein

- ¹ Acier
- ² Inclut des joints

- ¹ Acero
- ² Incluye los sellos

- ¹ Acciaio
- ² Comprende le guarnizioni

128.00

73





OM 445.920 (Euro 2 OM441 LA)	V6cyl.	10964cc	250kW (340PS)	Diesel	Turbo Intercooled	TD5781
OM 445.921 (Euro 2 OM441 LA)	V6cyl.	10964cc	250kW (340PS)	Diesel	Turbo Intercooled	TD8200
OM 445.922 (Euro 2 OM441 LA)	V6cyl.	10964cc	250kW (340PS)	Diesel	Turbo Intercooled	TD8252
OM 445.923 (Euro 2 OM441 LA)	V6cyl.	10964cc	250kW (340PS)	Diesel	Turbo Intercooled	TD5737
OM 445.924 (Euro 2 OM441 LA)	V6cyl.	10964cc	180kW (245PS)	Diesel	Turbo Intercooled	TD5754
OM 445.925 (Euro 2 OM441 LA)	V6cyl.	10964cc	180kW (245PS)	Diesel	Turbo Intercooled	TD8197
OM 445.926 (Euro 2 OM441 LA)	V6cyl.	10964cc	200kW (272PS)	Diesel	Turbo Intercooled	TD5776
OM 445.927 (Euro 2 OM441 LA)	V6cyl.	10964cc	200kW (272PS)	Diesel	Turbo Intercooled	TD8235
OM 445.929 (Euro 2 OM441 LA)	V6cyl.	10964cc	230kW (313PS)	Diesel	Turbo Intercooled	TD5778
OM 445.930 (Euro 2 OM441 LA)	V6cyl.	10964cc	230kW (313PS)	Diesel	Turbo Intercooled	TD6164
OM 445.931 (Euro 2 OM441 LA)	V6cyl.	10964cc	230kW (313PS)	Diesel	Turbo Intercooled	TD6298
OM 445.933 (Euro 2 OM441 LA)	V6cyl.	10964cc	200kW (272PS)	Diesel	Turbo Intercooled	TD6070
OM 445.934 (Euro 2 OM441 LA)	V6cyl.	10964cc	250kW (340PS)	Diesel	Turbo Intercooled	TD10969
OM 445.935 (Euro 2 OM441 LA)	V6cyl.	10964cc	213kW (290PS)	Diesel	Turbo Intercooled	TD10970
OM 445.936 (Euro 2 OM441 LA)	V6cyl.	10964cc	200kW (272PS)	Diesel	Turbo Intercooled	TD6109
OM 445.937 (Euro 2 OM441 LA)	V6cyl.	10964cc	230kW (313PS)	Diesel	Turbo Intercooled	TD6112
OM 445.938 (Euro 2 OM441 LA)	V6cyl.	10964cc	180kW (245PS)	Diesel	Turbo Intercooled	TD6087
OM 445.939 (Euro 2 OM441 LA)	V6cyl.	10964cc	250kW (340PS)	Diesel	Turbo Intercooled	TD6117
OM 445.940 (Euro 2 OM441 LA)	V6cyl.	10964cc	200kW (272PS)	Diesel	Turbo Intercooled	TD6148
OM 445.941 (Euro 2 OM441 LA)	V6cyl.	10964cc	180kW (245PS)	Diesel	Turbo Intercooled	TD6288
OM 446.920 (Euro 2 OM442 LA)	V8cyl.	14618cc	390kW (530PS)	Diesel	Turbo Intercooled	TD5789
OM 446.922 (Euro 2 OM442 LA)	V8cyl.	14618cc	320kW (435PS)	Diesel	Turbo Intercooled	TD8207
OM 446.923 (OM442 LA)	V8cyl.	14618cc	320kW (435PS)	Diesel	Turbo Intercooled	TD16935
OM 446.924 (Euro 2 OM442 LA)	V8cyl.	14618cc	280kW (381PS)	Diesel	Turbo Intercooled	TD5785
OM 446.925 (Euro 2 OM442 LA)	V8cyl.	14618cc	280kW (381PS)	Diesel	Turbo Intercooled	TD6120
OM 446.926 (Euro 2 OM442 LA)	V8cyl.	14618cc	280kW (381PS)	Diesel	Turbo Intercooled	TD5834
OM 446.927 (Euro 2 OM442 LA)	V8cyl.	14618cc	280kW (381PS)	Diesel	Turbo Intercooled	TD8203
OM 446.928 (Euro 2 OM442 LA)	V8cyl.	14618cc	280kW (381PS)	Diesel	Turbo Intercooled	TD5808
OM 446.929 (Euro 2 OM442 LA)	V8cyl.	14618cc	280kW (381PS)	Diesel	Turbo Intercooled	TD6155



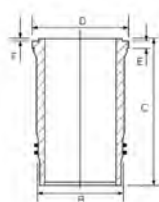

OM 446.930 (Euro 2 OM442 LA)	V8cyl.	14618cc	280kW (381PS)	Diesel	Turbo Intercooled	TD6186
OM 446.931 (Euro 2 OM442 LA)	V8cyl.	14618cc	280kW (381PS)	Diesel	Turbo Intercooled	TD8257
OM 446.932 (Euro 2 OM442 LA)	V8cyl.	14618cc	390kW (530PS)	Diesel	Turbo Intercooled	TD8260
OM 446.933 (Euro 2 OM442 LA)	V8cyl.	14618cc	390kW (530PS)	Diesel	Turbo Intercooled	TD5820
OM 446.934 (Euro 2 OM442 LA)	V8cyl.	14618cc	280kW (381PS)	Diesel	Turbo Intercooled	TD10974
OM 446.935 (Euro 2 OM442 LA)	V8cyl.	14618cc	320kW (435PS)	Diesel	Turbo Intercooled	TD16982
OM 446.936 (Euro 2 OM442 LA)	V8cyl.	14618cc	320kW (435PS)	Diesel	Turbo Intercooled	TD8247
OM 446.938 (Euro 2 OM442 LA)	V8cyl.	14618cc	280kW (381PS)	Diesel	Turbo Intercooled	TD10975
OM 446.939 (Euro 2 OM442 LA)	V8cyl.	14618cc	320kW (435PS)	Diesel	Turbo Intercooled	TD5835
OM 446.940 (Euro 2 OM442 LA)	V8cyl.	14618cc	320kW (435PS)	Diesel	Turbo Intercooled	TD6187
OM 446.941 (Euro 2 OM442 LA)	V8cyl.	14618cc	320kW (435PS)	Diesel	Turbo Intercooled	TD16983
OM 446.942 (Euro 2 OM442 LA)	V8cyl.	14618cc	320kW (435PS)	Diesel	Turbo Intercooled	TD5809
OM 446.943 (Euro 2 OM442 LA)	V8cyl.	14618cc	320kW (435PS)	Diesel	Turbo Intercooled	TD8204
OM 446.945 (Euro 2 OM442 LA)	V8cyl.	14618cc	390kW (530PS)	Diesel	Turbo Intercooled	TD6171
OM 446.946 (Euro 2 OM442 LA)	V8cyl.	14618cc	390kW (530PS)	Diesel	Turbo Intercooled	TD6125
OM 446.948 (Euro 2 OM442 LA)	V8cyl.	14618cc	320kW (435PS)	Diesel	Turbo Intercooled	TD6156

MK	12/87→09/96	Series 300	09/91→
O 403	01/03→	SK	07/87→09/96
O 404	09/91→10/99	TOURISMO (O 350)	08/95→
OH	01/70→		

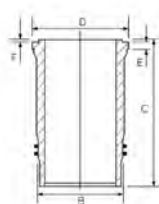
<p>87-179300-05 STD</p> <p>A 81.35 B- 24.00 BØ 72.60 D 126.35 46x105 (12833E102) AK KK RT TP</p> 	<p>08-179300-10 STD</p> <p>3.00 MOL 1 3.00 CR P 4.00 CR P</p> 	<p>15-452030-00 WH 2 B 144.50 C 253.00 D 153.80 E 9.92 F 1.00 14-452030-00 WH B 144.50 C 253.00 D 153.80 E 9.92 F 1.00 15-451160-00 WH 2 B 144.50 C 253.00 D 153.80 E 10.07 F 1.00 14-451160-00 WH B 144.50 C 253.00 D 153.80 E 10.07 F 1.00</p> 	<p>89-179300-05 2 87-179300-05 + 15-452030-00</p>
<p>87-179300-06 STD</p> <p>A 81.05 B- 24.00 BØ 72.60 D 126.05 46x105 (12833E102) AK KK RT TP</p> 	<p>08-179300-10 STD</p> <p>3.00 MOL 1 3.00 CR P 4.00 CR P</p> 	<p>15-452030-00 WH 2 B 144.50 C 253.00 D 153.80 E 9.92 F 1.00 14-452030-00 WH B 144.50 C 253.00 D 153.80 E 9.92 F 1.00</p> 	<p>89-179300-06 2 87-179300-06 + 15-452030-00</p>

1 Steel 2 Includes seals 1 Stahl 2 Schließt Dichtungen ein 1 Acier 2 Inclut des joints 1 Acero 2 Incluye los sellos 1 Acciaio 2 Comprende le guarnizioni

128.00						74
OM 447.954 (Euro 1)	6cyl.	11967cc	184kW (250PS)	Diesel	Turbo	TD10976
OM 447.955 (Euro 1)	6cyl.	11967cc	184kW (250PS)	Diesel	Turbo	TD10977
OM 447.956 (Euro 1)	6cyl.	11967cc	184kW (250PS)	Diesel	Turbo	TD7949
OM 447.957 (Euro 1)	6cyl.	11967cc	184kW (250PS)	Diesel	Turbo	TD7959
OM 447.958 (Euro 1)	6cyl.	11967cc	184kW (250PS)	Diesel	Turbo	TD7962
OM 447.959 (Euro 1)	6cyl.	11967cc	184kW (250PS)	Diesel	Turbo	TD7954





OM 447.980 (Euro 1)	6cyl.	11967cc	220kW (299PS)	Diesel	Turbo Intercooled	TD11008
OM 447.981 (Euro 1)	6cyl.	11967cc	220kW (300PS)	Diesel	Turbo Intercooled	TD7950
OM 447.982 (Euro 1)	6cyl.	11967cc	220kW (300PS)	Diesel	Turbo Intercooled	TD17811
OM 447.983 (Euro 1)	6cyl.	11967cc	220kW (300PS)	Diesel	Turbo Intercooled	TD17812
OM 447.984 (Euro 1)	6cyl.	11967cc	220kW (300PS)	Diesel	Turbo Intercooled	TD7955
OM 447.985 (Euro 1)	6cyl.	11967cc	220kW (299PS)	Diesel	Turbo Intercooled	TD10986
OM 447.986 (Euro 1)	6cyl.	11967cc	220kW (300PS)	Diesel	Turbo Intercooled	TD7960
OM 447.987 (Euro 1)	6cyl.	11967cc	220kW (300PS)	Diesel	Turbo Intercooled	TD7963
OM 447.995 (Euro 1)	6cyl.	11967cc	184kW (250PS)	Diesel	Turbo	TD17813

0 405 11/85→ 0 408 01/91→12/98
0 407 03/87→11/01

87-179300-20 STD

A 90.00
B- 24.00
BØ 75.00
D 139.85
46x105



AK HA RT

08-179300-10 STD

3.00 MOL ①
3.00 CR P
4.00 CR P



15-456980-00 WH ②

14-456980-00 WH

B 144.50 C 270.00 D 153.80 E 9.92 F 1.00
B 144.50 C 270.00 D 153.80 E 9.92 F 1.00

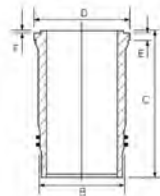

89-179300-21 ②

87-179300-20 +
15-456980-00

① Steel
② Includes seals

① Stahl
② Schließt Dichtungen ein

① Acier
② Inclut des joints

① Acero
② Incluye los sellos

① Acciaio
② Comprende le guarnizioni

128.00

75

OM 447.970 (Euro 2)	6cyl.	11967cc	157kW (214PS)	Diesel	Turbo Intercooled	TD10978
OM 447.971 (Euro 2)	6cyl.	11967cc	184kW (250PS)	Diesel	Turbo Intercooled	TD10979
OM 447.972 (Euro 2)	6cyl.	11967cc	220kW (299PS)	Diesel	Turbo Intercooled	TD10980
OM 447.973 (Euro 2)	6cyl.	11967cc	157kW (214PS)	Diesel	Turbo Intercooled	TD10981
OM 447.974 (Euro 2)	6cyl.	11967cc	184kW (250PS)	Diesel	Turbo Intercooled	TD10982
OM 447.975 (Euro 1)	6cyl.	11967cc	220kW (299PS)	Diesel	Turbo Intercooled	TD11007
OM 447.976 (Euro 2)	6cyl.	11967cc	184kW (250PS)	Diesel	Turbo Intercooled	TD10983
OM 447.977 (Euro 2)	6cyl.	11967cc	220kW (299PS)	Diesel	Turbo Intercooled	TD11009
OM 447.978	6cyl.	11967cc	184kW (250PS)	Diesel	Turbo Intercooled	TD10984
OM 447.979 (Euro 2)	6cyl.	11967cc	220kW (299PS)	Diesel	Turbo Intercooled	TD10985
OM 447.988 (Euro 2)	6cyl.	11967cc	220kW (300PS)	Diesel	Turbo Intercooled	TD16990
OM 447.990 (Euro 2)	6cyl.	11967cc	184kW (250PS)	Diesel	Turbo Intercooled	TD10987
OM 447.991 (Euro 2)	6cyl.	11967cc	220kW (299PS)	Diesel	Turbo Intercooled	TD10988
OM 447.992 (Euro 2)	6cyl.	11967cc	184kW (250PS)	Diesel	Turbo Intercooled	TD10989
OM 447.993 (Euro 2)	6cyl.	11967cc	220kW (299PS)	Diesel	Turbo Intercooled	TD10990
OM 447.994 (Euro 2)	6cyl.	11967cc	220kW (299PS)	Diesel	Turbo Intercooled	TD16991
OM 447.996 (Euro 2)	6cyl.	11967cc	184kW (250PS)	Diesel	Turbo Intercooled	TD22810
OM 447.998 (Euro 2)	6cyl.	11967cc	220kW (299PS)	Diesel	Turbo Intercooled	TD11010
OM 447.999 (Euro 2)	6cyl.	11967cc	220kW (299PS)	Diesel	Turbo Intercooled	TD23187

0 405 12/84→ 0 408 01/91→12/98
0 407 03/87→11/01





87-179300-50 STD

A 89.93
B- 23.88
BØ 75.15
D 139.93
46x105



AK HA RT TP

08-179300-10 STD

3.00 MOL 1
3.00 CR P
4.00 CR P



15-456980-00 WH 2
14-456980-00 WH

B 144.50 C 270.00 D 153.80 E 9.92 F 1.00
B 144.50 C 270.00 D 153.80 E 9.92 F 1.00

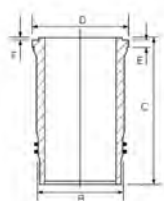

89-179300-50 2
87-179300-50 +
15-456980-00

1 Steel
2 Includes seals

1 Stahl
2 Schließt Dichtungen ein

1 Acier
2 Inclut des joints

1 Acero
2 Incluye los sellos

1 Acciaio
2 Comprende le guarnizioni

128.00

76

OM 457.910 (Euro 5)	6cyl.	11967cc	260-323kW (354-439PS)	Diesel	Turbo Intercooled	TD25467
OM 458.990	6cyl.	11967cc	220-260kW (299-354PS)	Diesel	Turbo Intercooled	TD28731
OM 458.991	6cyl.	11967cc	295-375kW (401-510PS)	Diesel	Turbo Intercooled	TD28732

AXOR 2	10/04 →	TOURO (0 500)	03/12 →
GRAN VIALE	01/07 →		

13-451070-00

15-451070-10 WH 1 2 B 144.50 C 266.30 D 155.50 E 10.12 F 1.10

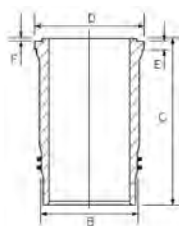

1 Includes Anti-Polish Ring (Fire Ring) 13-451070-00, also available separately

1 Enthält Feuerring 13-451070-00, auch einzeln erhältlich

1 Contient le segment racleur 13-451070-00 (disponible également)

1 Include anello Raschiaolio 13-451070-00, disponibili anche separatamente

2 Relief 6.50mm
3 Includes seals

2 Entlastung 6.50mm
3 Schließt Dichtungen ein

2 Le relief 6.50mm
3 Inclut des joints

2 Relevación 6.50mm
3 Incluye los sellos

2 Rilievo 6.50mm
3 Comprende le guarnizioni

128.00

77

OM 457.914 (Euro 3)	6cyl.	11967cc	250kW (340PS)	Diesel	Turbo Intercooled	TD20335
OM 457.915 (Euro 3)	6cyl.	11967cc	265kW (360PS)	Diesel	Turbo Intercooled	TD20303
OM 457.916 (Euro 3)	6cyl.	11967cc	265kW (360PS)	Diesel	Turbo Intercooled	TD20304
OM 457.917 (Euro 2/3)	6cyl.	11967cc	260-315kW (354-428PS)	Diesel	Turbo Intercooled	TD20324
OM 457.918 (Euro 3)	6cyl.	11967cc	260-315kW (354-428PS)	Diesel	Turbo Intercooled	TD20305
OM 457.919 (Euro 3)	6cyl.	11967cc	315kW (428PS)	Diesel	Turbo Intercooled	TD20306
OM 457.920 (Euro 3)	6cyl.	11967cc	280kW (381PS)	Diesel	Turbo Intercooled	TD20307
OM 457.922 (Euro 3)	6cyl.	11967cc	320-325kW (435-442PS)	Diesel	Turbo Intercooled	TD20308
OM 457.923 (Euro 3)	6cyl.	11967cc	280kW (381PS)	Diesel	Turbo Intercooled	TD20309
OM 457.924 (Euro 3)	6cyl.	11967cc	280kW (381PS)	Diesel	Turbo Intercooled	TD20310
OM 457.925 (Euro 3)	6cyl.	11967cc	265kW (360PS)	Diesel	Turbo Intercooled	TD20311
OM 457.926 (Euro 3)	6cyl.	11967cc	265kW (360PS)	Diesel	Turbo Intercooled	TD20312
OM 457.927 (Euro 3)	6cyl.	11967cc	295kW (401PS)	Diesel	Turbo Intercooled	TD20336
OM 457.928 (Euro 3)	6cyl.	11967cc	280kW (381PS)	Diesel	Turbo Intercooled	TD20313
OM 457.931 (Euro 3)	6cyl.	11967cc	280kW (381PS)	Diesel	Turbo Intercooled	TD20315
OM 457.932 (Euro 3)	6cyl.	11967cc	265kW (360PS)	Diesel	Turbo Intercooled	TD20316
OM 458.960 (Euro 3)	6cyl.	11967cc	260kW (354PS)	Diesel	Turbo Intercooled	TD17668
OM 458.970 (Euro 3)	6cyl.	11967cc	295kW (401PS)	Diesel	Turbo Intercooled	TD17669
OM 458.980 (Euro 3)	6cyl.	11967cc	335kW (456PS)	Diesel	Turbo Intercooled	TD17670





AGL (RoundNose)	08/98→12/05	HPN (LongNose)	10/98→12/05
ATRON	01/12→	O 400	01/02→12/06
AXOR 2	10/04→	TOURO (O 500)	01/01→
HEAVY-DUTY	05/15→10/19		

87-141800-00 STD

- A 90.05
- B- 16.00
- BØ 93.15
- D 140.05
- 52x103



AK KK RT TP

08-141800-00 STD

- 3.00 CK ¹
- 3.00 CR
- 4.00 CK

15-450380-00 WH ²

14-450380-00 WH ³

14-450480-00 WH ³ ⁴

B 144.50 C 266.30 D 155.60 E 10.12 F 1.10

B 144.50 C 266.30 D 155.60 E 10.12 F 1.10

B 144.50 C 266.30 D 155.60 E 10.12 F 1.10

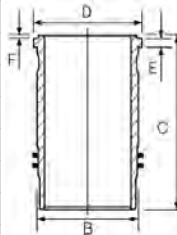

88-141800-00

87-141800-00 +

14-450380-00

- ¹ Steel
- ² Includes seals
- ³ Use 2 O-rings and 1 Tombak ring, set HL5077
- ⁴ Chrome plated outside diameter

- ¹ Stahl
- ² Schließt Dichtungen ein
- ³ Mitverwenden: 2 O-rings + 1 Tombak-Ring, HL5077
- ⁴ Außen verchromt

- ¹ Acier
- ² Inclut des joints
- ³ A utiliser aussi: 2 O-Rings + 1 Tombak ring, HL5077
- ⁴ Diamètre extérieur chromé

- ¹ Acero
- ² Incluye los sellos
- ³ Utilizar también: 2 O-rings + 1 Tombak ring, HL5077
- ⁴ Diámetro exterior cromado

- ¹ Acciaio
- ² Comprende le guarnizioni
- ³ Usare anche 2 O-rings + 1 Tombak ring, HL5077
- ⁴ Trattamento di cromatura sul

128.00

78

OM 457.929 (Euro 3)	6cyl.	11967cc	265kW (360PS)	Diesel	Turbo Intercooled	TD20314
OM 457.947 (Euro 2)	6cyl.	11967cc	260-315kW (354-428PS)	Diesel	Turbo Intercooled	TD20320
OM 457.955 (Euro 3)	6cyl.	11967cc	260-315kW (354-428PS)	Diesel	Turbo Intercooled	TD20323
OM 457.958 (Euro 2/3)	6cyl.	11967cc	230-315kW (313-428PS)	Diesel	Turbo Intercooled	TD20340
OM 457.960 (Euro 2)	6cyl.	11967cc	260-315kW (354-428PS)	Diesel	Turbo Intercooled	TD20322
OM 457.962 (Euro 3)	6cyl.	11967cc	260-315kW (354-428PS)	Diesel	Turbo Intercooled	TD23253
OM 460.900 (Euro 3)	6cyl.	12816cc	324kW (441PS)	Diesel	Turbo Intercooled	TD23255
OM 460.901 (Euro 3)	6cyl.	12816cc	261kW (355PS)	Diesel	Turbo Intercooled	TD23256
OM 460.902 (Euro 3)	6cyl.	12816cc	276kW (375PS)	Diesel	Turbo Intercooled	TD23257
OM 460.903 (Euro 3)	6cyl.	12816cc	276kW (375PS)	Diesel	Turbo Intercooled	TD23258
OM 460.904 (Euro 3)	6cyl.	12816cc	306kW (416PS)	Diesel	Turbo Intercooled	TD23259
OM 460.905 (Euro 3)	6cyl.	12816cc	306kW (416PS)	Diesel	Turbo Intercooled	TD23260
OM 460.906 (Euro 3)	6cyl.	12816cc	261-276kW (355-375PS)	Diesel	Turbo Intercooled	TD23261
OM 460.907 (Euro 3)	6cyl.	12816cc	336kW (457PS)	Diesel	Turbo Intercooled	TD23262
OM 460.908 (Euro 3)	6cyl.	12816cc	261-336kW (355-457PS)	Diesel	Turbo Intercooled	TD23263
OM 460.909 (Euro 3)	6cyl.	12816cc	261-276kW (355-375PS)	Diesel	Turbo Intercooled	TD23264
OM 460.910 (Euro 3)	6cyl.	12816cc	261-276kW (355-375PS)	Diesel	Turbo Intercooled	TD23265
OM 460.911 (Euro 3)	6cyl.	12816cc	306-336kW (416-457PS)	Diesel	Turbo Intercooled	TD23266
OM 460.912 (Euro 3)	6cyl.	12816cc	261-276kW (355-375PS)	Diesel	Turbo Intercooled	TD23267
OM 460.913 (Euro 3)	6cyl.	12816cc	306-336kW (416-457PS)	Diesel	Turbo Intercooled	TD23268
OM 460.914 (Euro 3)	6cyl.	12816cc	306-336kW (416-457PS)	Diesel	Turbo Intercooled	TD23269
OM 460.915 (Euro 3)	6cyl.	12816cc	261-276kW (355-375PS)	Diesel	Turbo Intercooled	TD23270
OM 460.916 (Euro 3)	6cyl.	12816cc	261-276kW (355-375PS)	Diesel	Turbo Intercooled	TD23271
OM 460.917 (Euro 3)	6cyl.	12816cc	306-336kW (416-457PS)	Diesel	Turbo Intercooled	TD23272
OM 460.918 (Euro 3)	6cyl.	12816cc	261-276kW (355-375PS)	Diesel	Turbo Intercooled	TD23273
OM 460.919 (Euro 3)	6cyl.	12816cc	306-336kW (416-457PS)	Diesel	Turbo Intercooled	TD23274
OM 460.920 (Euro 3)	6cyl.	12816cc	306-336kW (416-457PS)	Diesel	Turbo Intercooled	TD23275
OM 460.921 (Euro 3)	6cyl.	12816cc	306-336kW (416-457PS)	Diesel	Turbo Intercooled	TD23276
OM 460.922 (Euro 3)	6cyl.	12816cc	261-276kW (355-375PS)	Diesel	Turbo Intercooled	TD23277
OM 460.923 (Euro 3)	6cyl.	12816cc	306-336kW (416-457PS)	Diesel	Turbo Intercooled	TD23278
OM 460.925 (Euro 3)	6cyl.	12816cc	306-336kW (416-457PS)	Diesel	Turbo Intercooled	TD23279
OM 460.929 (Euro 3)	6cyl.	12816cc	306-336kW (416-457PS)	Diesel	Turbo Intercooled	TD23280





OM 460.931 (Euro 3)	6cyl.	12816cc	306-336kW (416-457PS)	Diesel	Turbo Intercooled	TD23281
ACTROS MP4 / MP5			01/12→	O 400		01/02→12/06
AXOR 2			10/04→	TOURO (0 500)		01/10→

14-450480-00 WH ① ② B 144.50 C 266.30 D 155.60 E 10.12 F 1.10
15-450380-00 WH ③ B 144.50 C 266.30 D 155.60 E 10.12 F 1.10
14-450380-00 WH ② B 144.50 C 266.30 D 155.60 E 10.12 F 1.10

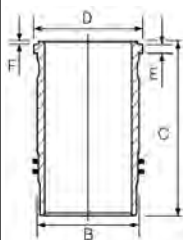

- ① Chrome plated outside diameter
- ② Use 2 O-rings and 1 Tombak ring, set HL5077
- ③ Includes seals

- ① Außen verchromt
- ② Mitverwenden: 2 O-rings + 1 Tombak-Ring, HL5077
- ③ Schließt Dichtungen ein

- ① Diamètre extérieur chromé
- ② A utiliser aussi: 2 O-Rings + 1 Tombak ring, HL5077
- ③ Inclut des joints

- ① Diámetro exterior cromado
- ② Utilizar también: 2 O-rings + 1 Tombak ring, HL5077
- ③ Incluye los sellos

- ① Trattamento di cromatura sul
- ② Usare anche 2 O-rings + 1 Tombak ring, HL5077
- ③ Comprende le guarnizioni

128.00 **79**

OM 457.933 (Euro 2/3)	6cyl.	11967cc	260kW (354PS)	Diesel	Turbo Intercooled	TD17662
OM 457.934 (Euro 2/3)	6cyl.	11967cc	220kW (299PS)	Diesel	Turbo Intercooled	TD17473
OM 457.935 (Euro 2/3)	6cyl.	11967cc	185kW (252PS)	Diesel	Turbo Intercooled	TD17502
OM 457.936 (Euro 2)	6cyl.	11967cc	300kW (408PS)	Diesel	Turbo Intercooled	TD17653
OM 457.937 (Euro 2/3)	6cyl.	11967cc	260-315kW (354-428PS)	Diesel	Turbo Intercooled	TD16489
OM 457.938 (Euro 2)	6cyl.	11967cc	300kW (408PS)	Diesel	Turbo Intercooled	TD17645
OM 457.939 (Euro 2)	6cyl.	11967cc	260kW (354PS)	Diesel	Turbo Intercooled	TD20317
OM 457.940 (Euro 2/3)	6cyl.	11967cc	260kW (354PS)	Diesel	Turbo Intercooled	TD17654
OM 457.941 (Euro 2/3)	6cyl.	11967cc	185-300kW (252-408PS)	Diesel	Turbo Intercooled	TD17641
OM 457.942 (Euro 2/3)	6cyl.	11967cc	185-260kW (252-354PS)	Diesel	Turbo Intercooled	TD17448
OM 457.943 (Euro 2/3)	6cyl.	11967cc	185-260kW (252-354PS)	Diesel	Turbo Intercooled	TD17666
OM 457.944 (Euro 2/3)	6cyl.	11967cc	260-315kW (354-428PS)	Diesel	Turbo Intercooled	TD17644
OM 457.945 (Euro 2)	6cyl.	11967cc	260kW (354PS)	Diesel	Turbo Intercooled	TD20318
OM 457.946 (Euro 2)	6cyl.	11967cc	220kW (299PS)	Diesel	Turbo Intercooled	TD20319
OM 457.949 (Euro 2)	6cyl.	11967cc	220kW (299PS)	Diesel	Turbo Intercooled	TD20321

AXOR	01/02→10/04	Series 400	10/01→
AXOR 2	10/04→	SHD	12/15→
CITARO (0 530)	01/98→	TOURISMO (0 350)	01/03→
CONECTO (0 345)	11/01→	TOURO (0 500)	10/01→
HPN (LongNose)	09/92→	TRAVEGO (0 580)	10/99→
O 403	09/03→		

87-115800-00 STD

- A** 90.05
- B-** 18.00
- BØ** 89.50
- D** 138.00
-  52x96



AK KK RT TP

- ① Steel
- ② Includes seals
- ③ Use 2 O-rings and 1 Tombak ring, set HL5077
- ④ Chrome plated outside diameter

08-115800-00 STD

- 3.00  CK ①
- 3.00  CR P
- 4.00  CR P

- ① Stahl
- ② Schließt Dichtungen ein
- ③ Mitverwenden: 2 O-rings + 1 Tombak-Ring, HL5077
- ④ Außen verchromt

15-450380-00 WH ② B 144.50 C 266.30 D 155.60 E 10.12 F 1.10
14-450380-00 WH ③ B 144.50 C 266.30 D 155.60 E 10.12 F 1.10
14-450480-00 WH ③ ④ B 144.50 C 266.30 D 155.60 E 10.12 F 1.10

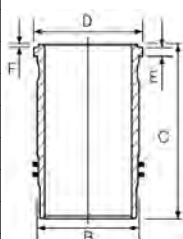

- ① Acier
- ② Inclut des joints
- ③ A utiliser aussi: 2 O-Rings + 1 Tombak ring, HL5077
- ④ Diamètre extérieur chromé

- ① Acero
- ② Incluye los sellos
- ③ Utilizar también: 2 O-rings + 1 Tombak ring, HL5077
- ④ Diámetro exterior cromado

88-115800-00
 87-115800-00 +
 14-450380-00

- ① Acciaio
- ② Comprende le guarnizioni
- ③ Usare anche 2 O-rings + 1 Tombak ring, HL5077
- ④ Trattamento di cromatura sul

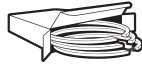

128.00 **80**

OM 457.948 (Euro 3)	6cyl.	11967cc	260-315kW (354-428PS)	Diesel	Turbo Intercooled	TD20227
OM 457.950 (Euro 4)	6cyl.	11967cc	220-260kW (299-354PS)	Diesel	Turbo Intercooled	TD20337
OM 457.951 (Euro 4)	6cyl.	11967cc	260kW (354PS)	Diesel	Turbo Intercooled	TD23250
OM 457.952 (Euro 4)	6cyl.	11967cc	220-300kW (299-408PS)	Diesel	Turbo Intercooled	TD20338
OM 457.953 (Euro 4)	6cyl.	11967cc	260-315kW (354-428PS)	Diesel	Turbo Intercooled	TD23251
OM 457.954 (Euro 4)	6cyl.	11967cc	220-260kW (299-354PS)	Diesel	Turbo Intercooled	TD20339
OM 457.956 (Euro 3)	6cyl.	11967cc	260-315kW (354-428PS)	Diesel	Turbo Intercooled	TD20282
OM 457.957 (Euro 3)	6cyl.	11967cc	260-315kW (354-428PS)	Diesel	Turbo Intercooled	TD20283
OM 457.959 (Euro 4)	6cyl.	11967cc	220-260kW (299-354PS)	Diesel	Turbo Intercooled	TD20341
OM 457.961 (Euro 3)	6cyl.	11967cc	260-355kW (354-483PS)	Diesel	Turbo Intercooled	TD23252
OM 457.964 (Euro 4)	6cyl.	11967cc	220-260kW (299-408PS)	Diesel	Turbo Intercooled	TD23247
OM 457.965 (Euro 4)	6cyl.	11967cc	220-300kW (299-408PS)	Diesel	Turbo Intercooled	TD23248
OM 457.966 (Euro 4)	6cyl.	11967cc	220-260kW (299-354PS)	Diesel	Turbo Intercooled	TD23249
OM 457.967 (Euro 4)	6cyl.	11967cc	220-260kW (299-354PS)	Diesel	Turbo Intercooled	TD28150
OM 457.968 (Euro 4)	6cyl.	11967cc	265-315kW (360-428PS)	Diesel	Turbo Intercooled	TD28726
OM 457.969 (Euro 4)	6cyl.	11967cc	265kW (360PS)	Diesel	Turbo Intercooled	TD28727
OM 457.973 (Euro 4)	6cyl.	11967cc	220-260kW (299-354PS)	Diesel	Turbo Intercooled	TD27003
OM 457.974 (Euro 4)	6cyl.	11967cc	220-300kW (299-408PS)	Diesel	Turbo Intercooled	TD28728
OM 457.976 (Euro 3)	6cyl.	11967cc	260-335kW (354-456PS)	Diesel	Turbo Intercooled	TD28729
OM 457.977 (Euro 4)	6cyl.	11967cc	220-260kW (299-354PS)	Diesel	Turbo Intercooled	TD28730
OM 457.980 (Euro 2)	6cyl.	11967cc	260-315kW (354-428PS)	Diesel	Turbo Intercooled	TD25446
OM 457.981 (Euro 3)	6cyl.	11967cc	260-315kW (354-428PS)	Diesel	Turbo Intercooled	TD25447
OM 457.984 (Euro 4)	6cyl.	11967cc	265kW (360PS)	Diesel	Turbo Intercooled	TD38430

AXOR	01/02→10/04	INTEGRO (0 550)	01/06→
AXOR 2	10/04→	INTOURO	01/05→
CAPACITY	04/07→	Series 400	10/01→
CITARO (0 530)	01/98→	TOURISMO (0 350)	01/03→
CONECTO (0 345)	11/01→	TRAVEGO (0 580)	10/99→

87-427000-00 STD

- A 85.00
- B- 17.70
- BØ 87.00
- D 135.00
- 52x103



KK NB RT TP

08-427000-00 STD

- 3.00 GDC 1
- 3.00 CR
- 4.00 GDC P



15-451070-10 WH 2 3 B 144.50 C 266.30 D 155.50 E 10.12 F 1.10 13-451070-00 4

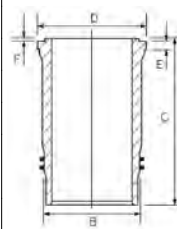

89-427000-00 2
87-427000-00 +
15-451070-10

- 1 Steel
- 2 Includes seals
- 3 Includes Anti-Polish Ring (Fire Ring) 13-451070-00, also available separately

- 1 Stahl
- 2 Schließt Dichtungen ein
- 3 Enthält Feuerring 13-451070-00, auch einzeln erhältlich

- 1 Acier
- 2 Inclut des joints
- 3 Contient le segment racleur 13-451070-00 (disponible également)

- 1 Acero
- 2 Incluye los sellos
- 3 Incluye el segmento rascador 13-451070-00, también disponible por separado

- 1 Acciaio
- 2 Comprende le guarnizioni
- 3 Include anello Raschiaolio 13-451070-00, disponibili anche separatamente

4 Relief 6.50mm

4 Entlastung 6.50mm

4 Le relief 6.50mm

4 Relevación 6.50mm

4 Rilievo 6.50mm

128.00 **81**

OM 460.926	6cyl.	12816cc	306-336kW (416-457PS)	Diesel	Turbo Intercooled	TD28735
OM 460.927	6cyl.	12816cc	306-336kW (416-457PS)	Diesel	Turbo Intercooled	TD28736
OM 460.932	6cyl.	12816cc	261-278kW (355-378PS)	Diesel	Turbo Intercooled	TD28737
OM 460.933	6cyl.	12816cc	306-336kW (416-457PS)	Diesel	Turbo Intercooled	TD28738
OM 460.934	6cyl.	12816cc	261-278kW (355-378PS)	Diesel	Turbo Intercooled	TD28739
OM 460.935	6cyl.	12816cc	306-336kW (416-457PS)	Diesel	Turbo Intercooled	TD28740
OM 460.936	6cyl.	12816cc	261-276kW (355-375PS)	Diesel	Turbo Intercooled	TD28741
OM 460.937	6cyl.	12816cc	261-276kW (355-375PS)	Diesel	Turbo Intercooled	TD28742
OM 460.938	6cyl.	12816cc	306-336kW (416-457PS)	Diesel	Turbo Intercooled	TD28743



OM 460.939	6cyl.	12816cc	261-276kW (355-375PS)	Diesel	Turbo Intercooled	TD28744
OM 460.940	6cyl.	12816cc	306-336kW (416-457PS)	Diesel	Turbo Intercooled	TD28745
OM 460.941	6cyl.	12816cc	261-276kW (355-375PS)	Diesel	Turbo Intercooled	TD28746
OM 460.942	6cyl.	12816cc	306-336kW (416-457PS)	Diesel	Turbo Intercooled	TD28747
OM 460.943	6cyl.	12816cc	261-276kW (355-375PS)	Diesel	Turbo Intercooled	TD28748
OM 460.944	6cyl.	12816cc	306-336kW (416-457PS)	Diesel	Turbo Intercooled	TD28749
OM 460.945	6cyl.	12816cc	261-276kW (355-375PS)	Diesel	Turbo Intercooled	TD28750
OM 460.946	6cyl.	12816cc	306-336kW (416-457PS)	Diesel	Turbo Intercooled	TD28751
OM 460.947	6cyl.	12816cc	261-276kW (355-375PS)	Diesel	Turbo Intercooled	TD28752
OM 460.948	6cyl.	12816cc	306-336kW (416-457PS)	Diesel	Turbo Intercooled	TD28753
OM 460.949	6cyl.	12816cc	261-276kW (355-375PS)	Diesel	Turbo Intercooled	TD28754
OM 460.961 (Euro 3)	6cyl.	12816cc	306-324kW (416-441PS)	Diesel	Turbo Intercooled	TD28755
OM 460.982 (Euro 3)	6cyl.	12816cc	324-336kW (441-457PS)	Diesel	Turbo Intercooled	TD28756
OM 460.983 (Euro 3)	6cyl.	12816cc	324-336kW (441-457PS)	Diesel	Turbo Intercooled	TD28757

15-451070-10 WH ① ② B 144.50 C 266.30 D 155.50 E 10.12 F 1.10
③

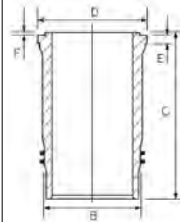

① Includes Anti-Polish Ring (Fire Ring) 13-451070-00, also available separately

① Enthält Feuerring 13-451070-00, auch einzeln erhältlich

① Contient le segment racleur 13-451070-00 (disponible également)

① Incluye el segmento rascador 13-451070-00, también disponible por separado

① Include anello Raschiaolio 13-451070-00, disponibili anche separatamente

② Relief 6.50mm

② Entlastung 6.50mm

② Le relief 6.50mm

② Relevación 6.50mm

② Rilievo 6.50mm

③ Includes seals

③ Schließt Dichtungen ein

③ Inclut des joints

③ Incluye los sellos

③ Comprende le guarnizioni

128.00

82

OM 440.940 (OM442 A)	V8cyl.	14618cc	250kW (340PS)	Diesel	Turbo	TD8194
OM 440.941 (OM442 A)	V8cyl.	14618cc	250kW (340PS)	Diesel	Turbo	TD5794
OM 440.942 (OM442 A)	V8cyl.	14618cc	250kW (340PS)	Diesel	Turbo	TD6130
OM 440.943 (OM442 A)	V8cyl.	14618cc	250kW (340PS)	Diesel	Turbo	TD17122

SK

07/87 → 09/96

87-179300-80 STD

A 81.35
B- 26.00
BØ 65.44
D 126.35
46x105



(12824H101)

AK HA NB RT

08-179300-10 STD

3.00 MOL ①
3.00 CR P
4.00 CR P



15-451160-00 WH ② B 144.50 C 253.00 D 153.80 E 10.07 F 1.00
14-451160-00 WH B 144.50 C 253.00 D 153.80 E 10.07 F 1.00
15-452030-00 WH ② B 144.50 C 253.00 D 153.80 E 9.92 F 1.00
14-452030-00 WH B 144.50 C 253.00 D 153.80 E 9.92 F 1.00

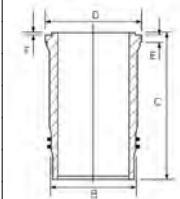

89-179300-80 ②

87-179300-80 +
15-451160-00

89-179300-81 ②

87-179300-80 +
15-452030-00

① Steel

② Includes seals

① Stahl

② Schließt Dichtungen ein

① Acier

② Inclut des joints

① Acero

② Incluye los sellos

① Acciaio

② Comprende le guarnizioni

128.00

83

OM 440.945 (Euro 1 OM442 A)	V8cyl.	14618cc	250kW (340PS)	Diesel	Turbo	TD16967
OM 442.977	V8cyl.	14618cc	250kW (340PS)	Diesel	Turbo	TD8219
OM 442.978	V8cyl.	14618cc	250kW (340PS)	Diesel	Turbo	TD8216





OM 442 A (Euro 1)	V8cyl.	14618cc	250kW (340PS)	Diesel	Turbo	MP7008
INDUSTRIAL				SK		07/87→09/96
OH				01/70→		

87-179300-60 STD

- A 81.30
- B- 23.10
- BØ 65.00
- D 126.29
- 46x105

AK HA RT TP



08-179300-10 STD

- 3.00 MOL ¹
- 3.00 CR P
- 4.00 CR P

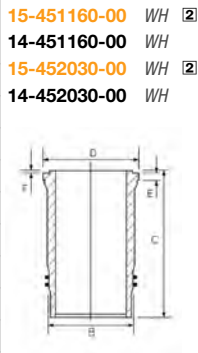

- 15-451160-00** WH ² B 144.50 C 253.00 D 153.80 E 10.07 F 1.00
- 14-451160-00** WH B 144.50 C 253.00 D 153.80 E 10.07 F 1.00
- 15-452030-00** WH ² B 144.50 C 253.00 D 153.80 E 9.92 F 1.00
- 14-452030-00** WH B 144.50 C 253.00 D 153.80 E 9.92 F 1.00

- ¹ Steel
- ² Includes seals

- ¹ Stahl
- ² Schließt Dichtungen ein

- ¹ Acier
- ² Inclut des joints

- ¹ Acero
- ² Incluye los sellos

- ¹ Acciaio
- ² Comprende le guarnizioni

128.00

84

OM 442.950	V8cyl.	14618cc	260-269kW (354-366PS)	Diesel	Turbo	TD5764
OM 442.952	V8cyl.	14618cc	260-269kW (354-366PS)	Diesel	Turbo	TD6135
OM 442.962	V8cyl.	14618cc	260-269kW (354-366PS)	Diesel	Turbo	TD8215
NG				08/73→09/96		SK
						07/87→09/96

87-179300-65 STD ¹
→02/91, →Eng.622823

- A 81.35
- B- 27.50
- BØ 66.60
- D 126.35
- 46x105

AK HA NB RT



08-179300-10 STD

- 3.00 MOL ²
- 3.00 CR P
- 4.00 CR P



- 15-451160-00** WH ³ B 144.50 C 253.00 D 153.80 E 10.07 F 1.00
- 14-451160-00** WH B 144.50 C 253.00 D 153.80 E 10.07 F 1.00
- 15-452030-00** WH ³ B 144.50 C 253.00 D 153.80 E 9.92 F 1.00
- 14-452030-00** WH B 144.50 C 253.00 D 153.80 E 9.92 F 1.00

89-179300-65 ³
87-179300-65 +
15-451160-00

89-179300-66 ³
87-179300-65 +
15-452030-00

- ¹ Version with domed crown bowl

- ¹ Version mit Erhebung in der Mulde

- ¹ Version avec dôme de chambre arrondi

- ¹ Versión con cabeza convexa

- ¹ Versione con camera di combustione convessa

- ² Steel
- ³ Includes seals

- ² Stahl
- ³ Schließt Dichtungen ein

- ² Acier
- ³ Inclut des joints

- ² Acero
- ³ Incluye los sellos

- ² Acciaio
- ³ Comprende le guarnizioni

130.00

85

OM 440.907 (Euro 1 OM442)	V8cyl.	15078cc	195kW (265PS)	Diesel	TD16966
OM 440.908 (Euro 1 OM442)	V8cyl.	15078cc	206kW (280PS)	Diesel	TD17118
OM 440.910 (Euro 1 OM442)	V8cyl.	15078cc	218kW (296PS)	Diesel	TD17119
OM 440.911 (Euro 1 OM442)	V8cyl.	15078cc	218kW (296PS)	Diesel	TD17120
OM 441	6cyl.	10964cc		Diesel	MP16702
OM 441 (Euro 1)	6cyl.	11309cc	151kW (205PS)	Diesel	MP17010
OM 441.922 (Euro 1)	V6cyl.	11309cc	151kW (205PS)	Diesel	TD7942
OM 441.933 (Euro 1)	V6cyl.	11309cc	151kW (205PS)	Diesel	TD8191
OM 442	V8cyl.	15080cc	191-218kW (260-296PS)	Diesel	MP7011
OM 442 (Euro 1)	V8cyl.	15080cc	195kW (265PS)	Diesel	MP17011
OM 442.931	V8cyl.	15078cc	195kW (265PS)	Diesel	TD7945
OM 443.900	V10cyl.	18848cc	331kW (450PS)	Diesel	TD28720

INDUSTRIAL

0 404

09/91→01/92



MK 12/88→08/94 OH 01/70→

15-456330-00 WH ① B 144.50 C 253.00 D 153.80 E 9.92
 14-456330-00 WH B 144.50 C 253.00 D 153.80 E 9.92 F 1.00

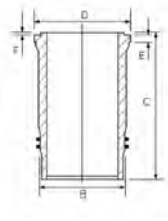

① Includes seals

① Schließt Dichtungen ein

① Includ des joints

① Incluye los sellos

① Comprende le guarnizioni

130.00						86
OM 440.909 (OM442)	V8cyl.	15078cc	195kW (265PS)	Diesel	TD8192	
OM 441.905	V6cyl.	11309cc	165kW (224PS)	Diesel	TD5731	
OM 441.906	V6cyl.	11309cc	150kW (204PS)	Diesel	TD8184	
OM 441.907	V6cyl.	11309cc	150kW (204PS)	Diesel	TD8185	
OM 441.908	V6cyl.	11309cc	160-165kW (218-224PS)	Diesel	TD5660	
OM 441.909	V6cyl.	11309cc	160-165kW (218-224PS)	Diesel	TD5998	
OM 441.911	V6cyl.	11309cc	160-165kW (218-224PS)	Diesel	TD6271	
OM 441.912	V6cyl.	11309cc	165kW (224PS)	Diesel	TD6142	
OM 441.913	V6cyl.	11309cc	165kW (224PS)	Diesel	TD6063	
OM 441.914	V6cyl.	11309cc	165kW (224PS)	Diesel	TD6101	
OM 441.915	V6cyl.	11309cc	165kW (224PS)	Diesel	TD8121	
OM 441.916	V6cyl.	11309cc	153kW (208PS)	Diesel	TD5768	
OM 441.917	V6cyl.	11309cc	160kW (218PS)	Diesel	TD8122	
OM 441.918	V6cyl.	11309cc	165kW (224PS)	Diesel	TD10968	
OM 441.919	V6cyl.	11309cc	150-165kW (204-224PS)	Diesel	TD16972	
OM 441.920	V6cyl.	11309cc	153kW (208PS)	Diesel	TD6100	
OM 441.923	V6cyl.	11309cc	160kW (218PS)	Diesel	TD5732	
OM 441.924	V6cyl.	11309cc	160kW (218PS)	Diesel	TD6143	
OM 441.925	V6cyl.	11309cc	160kW (218PS)	Diesel	TD6064	
OM 441.926	V6cyl.	11309cc	160kW (218PS)	Diesel	TD8119	
OM 441.927	V6cyl.	11309cc	153kW (208PS)	Diesel	TD8123	
OM 441.932	V6cyl.	11309cc	151kW (205PS)	Diesel	TD8190	
OM 442.905	V8cyl.	15078cc	191kW (260PS)	Diesel	TD8186	
OM 442.906	V8cyl.	15078cc	218kW (296PS)	Diesel	TD5769	
OM 442.907	V8cyl.	15078cc	213-218kW (290-296PS)	Diesel	TD5771	
OM 442.908	V8cyl.	15078cc	210kW (286PS)	Diesel	TD5790	
OM 442.909	V8cyl.	15078cc	210kW (286PS)	Diesel	TD5791	
OM 442.910	V8cyl.	15078cc	213-218kW (290-296PS)	Diesel	TD5662	
OM 442.911	V8cyl.	15078cc	218kW (296PS)	Diesel	TD10971	
OM 442.914	V8cyl.	15078cc	195kW (265PS)	Diesel	TD5734	
OM 442.915	V8cyl.	15078cc	218kW (296PS)	Diesel	TD5822	
OM 442.916	V8cyl.	15078cc	218kW (296PS)	Diesel	TD6174	
OM 442.917	V8cyl.	15078cc	218kW (296PS)	Diesel	TD6297	
OM 442.918	V8cyl.	15078cc	213-218kW (290-296PS)	Diesel	TD6000	
OM 442.919	V8cyl.	15078cc	213-218kW (290-296PS)	Diesel	TD6272	
OM 442.920	V8cyl.	15078cc	195kW (265PS)	Diesel	TD5735	
OM 442.921	V8cyl.	15078cc	195kW (265PS)	Diesel	TD6144	





OM 442.922	V8cyl.	15078cc	195kW (265PS)	Diesel	TD5770
OM 442.923	V8cyl.	15078cc	210kW (286PS)	Diesel	TD6127
OM 442.924	V8cyl.	15078cc	210kW (286PS)	Diesel	TD6128
OM 442.925	V8cyl.	15078cc	213kW (290PS)	Diesel	TD5815
OM 442.926	V8cyl.	15078cc	213kW (290PS)	Diesel	TD5792
OM 442.927	V8cyl.	15078cc	213kW (290PS)	Diesel	TD5823
OM 442.928	V8cyl.	15078cc	213kW (290PS)	Diesel	TD6175
OM 442.929	V8cyl.	15078cc	213kW (290PS)	Diesel	TD6129
OM 442.930	V8cyl.	15078cc	213kW (290PS)	Diesel	TD7944
OM 442.932	V8cyl.	15078cc	195kW (265PS)	Diesel	TD6066
OM 442.933	V8cyl.	15078cc	195kW (265PS)	Diesel	TD6067
OM 442.934	V8cyl.	15078cc	195kW (265PS)	Diesel	TD6324
OM 442.935	V8cyl.	15078cc	195kW (265PS)	Diesel	TD6102
OM 442.939	V8cyl.	15078cc	213-218kW (290-296PS)	Diesel	TD6319
OM 443.905	V10cyl.	18848cc	271kW (369PS)	Diesel	TD16981
OM 444	V12cyl.	22618cc		Diesel	MP6641

INDUSTRIAL			0 330	01/90→
MK	12/87→09/96		0 404	09/91→01/92
NG	08/73→09/96		SK	07/87→09/96
0 303	09/87→09/92		Transliner	12/88→

87-743200-00 STD

- A 81.35
- B- 27.20
- BØ 60.50
- D 126.35
- 46x99

(13039C)

AK HA RT



08-743200-00 STD

- 3.00 MOL P
- 3.00 CR P
- 4.00 CR P



15-456330-00 WH

B 144.50 C 253.00 D 153.80 E 9.92

14-456330-00 WH B 144.50 C 253.00 D 153.80 E 9.92 F 1.00

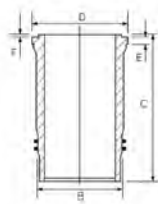

89-743200-00

87-743200-00 +
15-456330-00

Includes seals

Schließt Dichtungen ein

Inclut des joints

Incluye los sellos

Comprende le guarnizioni

130.00

87

OM 521.940 (Euro 2 OM501 LA)	V6cyl.	11946cc	315kW (428PS)	Diesel	Turbo Intercooled	TD16791
OM 521.950 (Euro 2 OM501 LA)	V6cyl.	11946cc	260kW (354PS)	Diesel	Turbo Intercooled	TD17671
OM 521.951 (Euro 2 OM501 LA)	V6cyl.	11946cc	335kW (456PS)	Diesel	Turbo Intercooled	TD28776
OM 522.940 (Euro 2 OM502 LA)	V8cyl.	15928cc	420kW (571PS)	Diesel	Turbo Intercooled	TD16800
OM 522.941 (Euro 2 OM502 LA)	V8cyl.	15928cc	413kW (562PS)	Diesel	Turbo Intercooled	TD17672
OM 522.942 (Euro 2 OM502 LA)	V8cyl.	15928cc	362kW (496PS)	Diesel	Turbo Intercooled	TD17673
OM 522.943 (Euro 2 OM502 LA)	V8cyl.	15928cc	362kW (496PS)	Diesel	Turbo Intercooled	TD17674
OM 522.950 (Euro 2 OM502 LA)	V8cyl.	15928cc	530kW (721PS)	Diesel	Turbo Intercooled	TD22822
OM 541.920 (Euro 2 OM501 LA)	V6cyl.	11946cc	230kW (313PS)	Diesel	Turbo Intercooled	TD7872
OM 541.921 (Euro 2 OM501 LA)	V6cyl.	11946cc	315kW (428PS)	Diesel	Turbo Intercooled	TD9673
OM 541.922 (Euro 2 OM501 LA)	V6cyl.	11946cc	260kW (354PS)	Diesel	Turbo Intercooled	TD7873
OM 541.923 (Euro 2 OM501 LA)	V6cyl.	11946cc	290-300kW (394-408PS)	Diesel	Turbo Intercooled	TD7874
OM 541.924 (Euro 2 OM501 LA)	V6cyl.	11946cc	290kW (394PS)	Diesel	Turbo Intercooled	TD7880
OM 541.925 (Euro 2 OM501 LA)	V6cyl.	11946cc	315kW (428PS)	Diesel	Turbo Intercooled	TD7875
OM 541.926 (Euro 2 OM501 LA)	V6cyl.	11946cc	230kW (313PS)	Diesel	Turbo Intercooled	TD7879
OM 541.927 (Euro 2 OM501 LA)	V6cyl.	11946cc	260kW (354PS)	Diesel	Turbo Intercooled	TD9679
OM 541.928 (Euro 2 OM501 LA)	V6cyl.	11946cc	315kW (428PS)	Diesel	Turbo Intercooled	TD17679
OM 541.940 (Euro 2/3 OM501 LA)	V6cyl.	11946cc	230-235kW (313-320PS)	Diesel	Turbo Intercooled	TD16897
OM 541.941 (Euro 2/3 OM501 LA)	V6cyl.	11946cc	230-235kW (313-320PS)	Diesel	Turbo Intercooled	TD16898





OM 541.951 (Euro 2/3 OM501 LA)	V6cyl.	11946cc	230-235kW (313-320PS)	Diesel	Turbo Intercooled	TD17684
OM 541.952 (Euro 2/3 OM501 LA)	V6cyl.	11946cc	230-260kW (313-354PS)	Diesel	Turbo Intercooled	TD17685
OM 541.960 (Euro 2 OM501 LA)	V6cyl.	11946cc	240kW (326PS)	Diesel	Turbo Intercooled	TD25520
OM 542.920 (OM502 LA)	V8cyl.	15928cc	390kW (530PS)	Diesel	Turbo Intercooled	TD7877
OM 542.921 (OM502 LA)	V8cyl.	15928cc	350kW (476PS)	Diesel	Turbo Intercooled	TD7876
OM 542.922 (OM502 LA)	V8cyl.	15928cc	420kW (571PS)	Diesel	Turbo Intercooled	TD7878
OM 542.923 (OM502 LA)	V8cyl.	15928cc	420kW (571PS)	Diesel	Turbo Intercooled	TD16905
OM 542.924 (OM502 LA)	V8cyl.	15928cc	420kW (571PS)	Diesel	Turbo Intercooled	TD17686
OM 542.925 (Euro 2 OM502 LA)	V8cyl.	15928cc	350kW (476PS)	Diesel	Turbo Intercooled	TD9683
OM 542.926 (OM502 LA)	V8cyl.	15928cc	390kW (530PS)	Diesel	Turbo Intercooled	TD17687
OM 542.947 (OM502 LA)	V8cyl.	15928cc	390-420kW (530-571PS)	Diesel	Turbo Intercooled	TD17690
OM 542.958 (Euro 3 OM502 LA)	V8cyl.	15928cc	450kW (612PS)	Diesel	Turbo Intercooled	TD24684
OM 941.910 (Euro 2 OM501 LA)	V6cyl.	11946cc	230kW (313PS)	Diesel	Turbo Intercooled	TD17693
OM 941.920 (Euro 2 OM501 LA)	V6cyl.	11946cc	260kW (354PS)	Diesel	Turbo Intercooled	TD17693
OM 941.921 (Euro 2 OM501 LA)	V6cyl.	11946cc	260kW (354PS)	Diesel	Turbo Intercooled	TD17694
OM 941.929 (Euro 2 OM501 LA)	V6cyl.	11946cc	290kW (394PS)	Diesel	Turbo Intercooled	TD16794
OM 941.930 (Euro 2 OM501 LA)	V6cyl.	11946cc	300kW (408PS)	Diesel	Turbo Intercooled	TD16795
OM 941.940 (Euro 2 OM501 LA)	V6cyl.	11946cc	315kW (428PS)	Diesel	Turbo Intercooled	TD16796
OM 941.960 (Euro 2 OM501 LA)	V6cyl.	11946cc	230kW (313PS)	Diesel	Turbo Intercooled	TD16797
OM 941.970 (Euro 2 OM501 LA)	V6cyl.	11946cc	260kW (354PS)	Diesel	Turbo Intercooled	TD16798
OM 941.980 (Euro 2 OM501 LA)	V6cyl.	11946cc	290kW (394PS)	Diesel	Turbo Intercooled	TD17695
OM 941.981 (Euro 2 OM501 LA)	V6cyl.	11946cc	290-315kW (394-428PS)	Diesel	Turbo Intercooled	TD17696
OM 941.990 (Euro 2 OM501 LA)	V6cyl.	11946cc	315kW (428PS)	Diesel	Turbo Intercooled	TD16799
OM 942.900 (Euro 2 OM502 LA)	V8cyl.	15928cc	350kW (476PS)	Diesel	Turbo Intercooled	TD17697
OM 942.910 (Euro 2 OM502 LA)	V8cyl.	15928cc	350kW (470PS)	Diesel	Turbo Intercooled	TD17698
OM 942.911 (Euro 2 OM502 LA)	V8cyl.	15928cc	350kW (476PS)	Diesel	Turbo Intercooled	TD16801
OM 942.912 (Euro 2 OM502 LA)	V8cyl.	15928cc	350kW (470PS)	Diesel	Turbo Intercooled	TD17699
OM 942.925 (Euro 2 OM502 LA)	V8cyl.	15928cc	400kW (544PS)	Diesel	Turbo Intercooled	TD17700
OM 942.930 (Euro 2 OM502 LA)	V8cyl.	15928cc	420kW (570PS)	Diesel	Turbo Intercooled	TD16802
OM 942.960 (Euro 2 OM502 LA)	V8cyl.	15928cc	350kW (470PS)	Diesel	Turbo Intercooled	TD17701
OM 942.967 (Euro 2 OM502 LA)	V8cyl.	15928cc	370-380kW (503-517PS)	Diesel	Turbo Intercooled	TD17702
OM 942.970 (Euro 2 OM502 LA)	V8cyl.	15928cc	390kW (570PS)	Diesel	Turbo Intercooled	TD17703
OM 942.980 (Euro 2 OM502 LA)	V8cyl.	15928cc	420kW (570PS)	Diesel	Turbo Intercooled	TD16803
OM 942.990 (Euro 2 OM502 LA)	V8cyl.	15928cc	330-448kW (570-609PS)	Diesel	Turbo Intercooled	TD17704

ACTROS	04/96→10/03	Skyliner	05/04→
ACTROS MP2 / MP3	10/02→	Starliner	09/96→
ACTROS MP4 / MP5	01/14→	TRAVEGO (0 580)	10/99→
Series 400	10/01→		

87-289600-00 STD

- A 78.55
- B- 18.10
- BØ 88.56
- D 119.55
- 52x103



(13049A)
AK KK RT TP

08-289600-00 STD

- 3.00 CK
- 3.00 CR P
- 4.00 CR P



14-450250-00 WH B 150.00 C 258.00 D 164.10 E 10.12 F 1.10

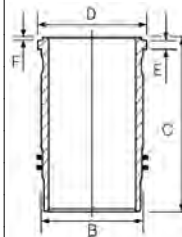

88-289600-30
87-289600-00 +
14-450250-00





15-458580-00 WH ⑤ ⑥ B 150.00 C 258.00 D 164.10 E 10.12 F 1.10
14-458580-00 WH ⑥ B 150.00 C 258.00 D 164.10 E 10.12 F 1.10

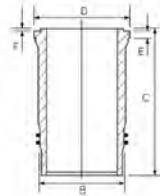

89-289600-00 ⑤
 87-289600-00 +
 15-458580-00

① OE 541 030 0024

② Steel

③ Has different upper register design compared to 14-458580-00

④ Round water channel 20mm below flange

⑤ Includes seals

⑥ Rectangular water channel immediately below flange

② Stahl

③ Hat unterschiedliche obere Flanschführung im Vergleich zu 14-458580-00

④ Runder Wasserkanal

⑤ Schließt Dichtungen ein

⑥ Rechteckiger Wasserkanal unter dem Buchsenbund

② Acier

③ Profil inférieur de la collerette différent de 14-45880-00

④ Canal d'eau rond

⑤ Inclut des joints

⑥ Canal d'eau rectangulaire sous la bride

② Acero

③ Tiene un registro superior diferente comparado al 14-458580-00

④ Canal de agua redondo

⑤ Incluye los sellos

⑥ Canal de agua rectangular bajo la pestaña

② Acciaio

③ Profilo inferiore del colletto diverso da 14-45880-00

④ Passaggio acqua circolare

⑤ Comprende le guarnizioni

⑥ Passaggio acqua rettangolare sotto flangia

130.00

88

OM 541.942 (Euro 3 OM501 LA)	V6cyl.	11946cc	260-265kW (354-360PS)	Diesel	Turbo Intercooled	TD16899
OM 541.943 (Euro 3 OM501 LA)	V6cyl.	11946cc	260-265kW (354-360PS)	Diesel	Turbo Intercooled	TD16900
OM 541.944 (Euro 3 OM501 LA)	V6cyl.	11946cc	290-300kW (394-408PS)	Diesel	Turbo Intercooled	TD16901
OM 541.945 (Euro 3 OM501 LA)	V6cyl.	11946cc	290-300kW (394-408PS)	Diesel	Turbo Intercooled	TD16902
OM 541.946 (Euro 3 OM501 LA)	V6cyl.	11946cc	315-320kW (428-435PS)	Diesel	Turbo Intercooled	TD16903
OM 541.947 (Euro 3 OM501 LA)	V6cyl.	11946cc	315-320kW (428-435PS)	Diesel	Turbo Intercooled	TD16904
OM 541.948 (Euro 3 OM501 LA)	V6cyl.	11946cc	335-355kW (456-483PS)	Diesel	Turbo Intercooled	TD16913
OM 541.949 (Euro 3 OM501 LA)	V6cyl.	11946cc	335-355kW (456-483PS)	Diesel	Turbo Intercooled	TD16914
OM 541.950 (Euro 3 OM501 LA)	V6cyl.	11946cc	260-300kW (354-408PS)	Diesel	Turbo Intercooled	TD17682
OM 541.995 (OM501 LA)	V6cyl.	11946cc	335kW (456PS)	Diesel	Turbo Intercooled	TD25696
OM 542.940 (Euro 3 OM502 LA)	V8cyl.	15928cc	350-375kW (476-510PS)	Diesel	Turbo Intercooled	TD16909
OM 542.941 (Euro 3 OM502 LA)	V8cyl.	15928cc	370kW (503PS)	Diesel	Turbo Intercooled	TD16911
OM 542.942 (Euro 3 OM502 LA)	V8cyl.	15928cc	390-395kW (530-537PS)	Diesel	Turbo Intercooled	TD16906
OM 542.943 (Euro 3 OM502 LA)	V8cyl.	15928cc	390-395kW (530-537PS)	Diesel	Turbo Intercooled	TD16907
OM 542.944 (Euro 3 OM502 LA)	V8cyl.	15928cc	420-425kW (571-578PS)	Diesel	Turbo Intercooled	TD16912
OM 542.945 (Euro 3 OM502 LA)	V8cyl.	15928cc	420-425kW (571-578PS)	Diesel	Turbo Intercooled	TD17689
OM 542.948 (Euro 3 OM502 LA)	V8cyl.	15928cc	320-370kW (435-503PS)	Diesel	Turbo Intercooled	TD17655
OM 542.956 (Euro 3 OM502 LA)	V8cyl.	15928cc	448kW (609PS)	Diesel	Turbo Intercooled	TD17691
OM 542.957 (Euro 3 OM502 LA)	V8cyl.	15928cc	448kW (609PS)	Diesel	Turbo Intercooled	TD17692

ACTROS

04/96→

Series 400

10/01→

ACTROS MP2 / MP3

10/02→

TOURISMO (O 350)

01/03→

ACTROS MP4 / MP5

01/14→

TRAVEGO (O 580)

10/99→

87-136000-00 STD

A 78.55

B- 16.50

BØ 92.80

D 119.55

 52x102

(13050E203)

AK KK NB RT TP



08-136000-00 STD ①

3.00



CK ②

3.00



CR P

4.00



CK P

LKZ-Ring

14-450250-00 WH ③ ④ B 150.00 C 258.00 D 164.10 E 10.12 F 1.10

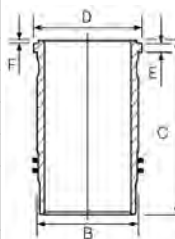





88-136000-20

87-136000-00 +

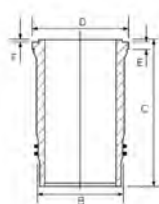
14-450250-00

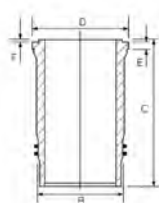

		<p>15-458580-00 WH ⑤ ⑥ B 150.00 C 258.00 D 164.10 E 10.12 F 1.10 14-458580-00 WH ⑥ B 150.00 C 258.00 D 164.10 E 10.12 F 1.10</p> 	<p>89-136000-00 ⑤ 87-136000-00 + 15-458580-00</p>
<p>87-136000-10 STD</p> <p>A 78.35 B- 16.50 BØ 92.80 D 119.35 52x102 (13050E) AK KK NB RT TP</p> 	<p>08-136000-00 STD ①</p> <p>3.00  CK ② 3.00  CR P 4.00  CK P</p> <p>LKZ-Ring</p>	<p>15-458580-00 WH ⑤ ⑥ B 150.00 C 258.00 D 164.10 E 10.12 F 1.10 14-458580-00 WH ⑥ B 150.00 C 258.00 D 164.10 E 10.12 F 1.10</p> 	<p>89-136000-10 87-136000-10 + 15-458580-00</p>

- ① OE 541 030 0424
- ② Steel
- ③ Has different upper register design compared to 14-458580-00
- ④ Round water channel 20mm below flange
- ⑤ Includes seals
- ⑥ Rectangular water channel immediately below flange
- ② Stahl
- ③ Hat unterschiedliche obere Flanschausführung im Vergleich zu 14-458580-00
- ④ Runder Wasserkanal
- ⑤ Schließt Dichtungen ein
- ⑥ Rechteckiger Wasserkanal unter dem Buchsenbund
- ② Acier
- ③ Profil inferior de la colerette different de 14-45880-00
- ④ Canal d'eau rond
- ⑤ Inclut des joints
- ⑥ Canal d'eau rectangulaire sous la bride
- ② Acero
- ③ Tiene un registro superior diferente comparado al 14-458580-00
- ④ Canal de agua redondo
- ⑤ Incluye los sellos
- ⑥ Canal de agua rectangular bajo la pestaña
- ② Acciaio
- ③ Profilo inferiore del colletto diverso da 14-45880-00
- ④ Passaggio acqua circolare
- ⑤ Comprende le guarnizioni
- ⑥ Passaggio acqua rettangolare sotto flangia













130.00							89
OM 541.953 (Euro 4/5 OM501 LA)	V6cyl.	11946cc	320kW (435PS)	Diesel	Turbo Intercooled	TD28777	
OM 541.959 (Euro 4/5 OM501 LA)	V6cyl.	11946cc	300kW (408PS)	Diesel	Turbo Intercooled	TD28778	
OM 541.970 (Euro 4 OM501 LA)	V6cyl.	11946cc	235kW (320PS)	Diesel	Turbo Intercooled	TD19250	
OM 541.971 (Euro 4/5 OM501 LA)	V6cyl.	11946cc	235kW (320PS)	Diesel	Turbo Intercooled	TD21001	
OM 541.972 (Euro 4 OM501 LA)	V6cyl.	11946cc	265kW (360PS)	Diesel	Turbo Intercooled	TD19251	
OM 541.973 (Euro 4 OM501 LA)	V6cyl.	11946cc	265kW (360PS)	Diesel	Turbo Intercooled	TD21022	
OM 541.974 (Euro 4 OM501 LA)	V6cyl.	11946cc	300kW (408PS)	Diesel	Turbo Intercooled	TD18997	
OM 541.975 (Euro 4 OM501 LA)	V6cyl.	11946cc	300kW (408PS)	Diesel	Turbo Intercooled	TD21023	
OM 541.976 (Euro 4 OM501 LA)	V6cyl.	11946cc	320kW (435PS)	Diesel	Turbo Intercooled	TD19000	
OM 541.977 (Euro 4 OM501 LA)	V6cyl.	11946cc	320kW (435PS)	Diesel	Turbo Intercooled	TD21024	
OM 541.978 (Euro 4 OM501 LA)	V6cyl.	11946cc	350kW (476PS)	Diesel	Turbo Intercooled	TD21007	
OM 541.979 (Euro 4/5 OM501 LA)	V6cyl.	11946cc	350kW (476PS)	Diesel	Turbo Intercooled	TD28783	
OM 541.980 (Euro 4 OM501 LA)	V6cyl.	11946cc	335kW (456PS)	Diesel	Turbo Intercooled	TD21000	
OM 541.981 (Euro 4 OM501 LA)	V6cyl.	11946cc	335kW (456PS)	Diesel	Turbo Intercooled	TD21003	
OM 541.990 (Euro 5 OM501 LA)	V6cyl.	11946cc	300kW (408PS)	Diesel	Turbo Intercooled	TD23767	
OM 541.992 (Euro 5 OM501 LA)	V6cyl.	11946cc	320kW (435PS)	Diesel	Turbo Intercooled	TD23768	
OM 541.994 (Euro 5 OM501 LA)	V6cyl.	11946cc	335kW (456PS)	Diesel	Turbo Intercooled	TD23769	
OM 541.996 (Euro 5 OM501 LA)	V6cyl.	11946cc	235kW (320PS)	Diesel	Turbo Intercooled	TD25486	
OM 541.997 (OM501 LA)	V6cyl.	11946cc	235kW (320PS)	Diesel	Turbo Intercooled	TD25697	
OM 541.998 (Euro 5 OM501 LA)	V6cyl.	11946cc	265kW (360PS)	Diesel	Turbo Intercooled	TD25487	
OM 541.999 (OM501 LA)	V6cyl.	11946cc	265kW (360PS)	Diesel	Turbo Intercooled	TD25698	
OM 542.960 (Euro 5)	V8cyl.	15928cc	375kW (510PS)	Diesel	Turbo Intercooled	TD19999	
OM 542.961 (Euro 5)	V8cyl.	15928cc	375kW (510PS)	Diesel	Turbo Intercooled	TD21026	
OM 542.962 (Euro 5 OM502 LA)	V8cyl.	15928cc	405kW (551PS)	Diesel	Turbo Intercooled	TD18840	





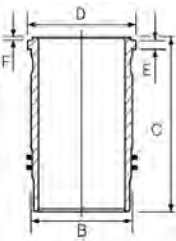















OM 542.963 (Euro 5 OM502 LA)	V8cyl.	15928cc	405kW (551PS)	Diesel	Turbo Intercooled	TD21025
OM 542.964 (Euro 5)	V8cyl.	15928cc	440kW (598PS)	Diesel	Turbo Intercooled	TD20000
OM 542.965	V8cyl.	15928cc	440kW (598PS)	Diesel	Turbo Intercooled	TD25688
OM 542.966 (Euro 5)	V8cyl.	15928cc	350-370kW (476-503PS)	Diesel	Turbo Intercooled	TD25103
OM 542.970 (Euro 5)	V8cyl.	15928cc	448kW (609PS)	Diesel	Turbo Intercooled	TD28779
OM 542.971 (Euro 5)	V8cyl.	15928cc	448kW (609PS)	Diesel	Turbo Intercooled	TD28780
OM 542.972 (Euro 5)	V8cyl.	15928cc	405-480kW (551-653PS)	Diesel	Turbo Intercooled	TD28781

ACTROS MP2 / MP3	04/03→	TOURISMO (0 350)	01/03→
Series 400	10/01→	TRAVEGO (0 580)	10/99→

87-420900-00 STD A 78.55 B- 17.60 BØ 87.00 D 119.55  52x102 (13065D203) AK KK NB RT TP	  GDC  LKZ-Ring	 3.00  GDC  3.00  CR P 4.00  GDC P	 15-450790-00 <i>WH</i>  14-450790-00 <i>WH</i> 15-451220-00 <i>WH</i>  14-451220-00 <i>WH</i>  13-451220-00	88-420900-00 87-420900-00 + 14-450790-00 89-420900-30 87-420900-00 + 15-451220-00

-  OE 541 030 0624
-  Steel
-  Includes seals
-  Includes Anti-Polish Ring (Fire Ring) 13-451220-00, also available separately
-  Stahl
-  Schließt Dichtungen ein
-  Enthält Feuerring 13-451220-00, auch einzeln erhältlich
-  Acier
-  Inclut des joints
-  Contient le segment racler 13-451220-00 (disponible également)
-  Acero
-  Incluye los sellos
-  Incluye el segmento rascador 13-451220-00, también disponible por separado
-  Acciaio
-  Comprende le guarnizioni
-  Include anello Raschiaolio 13-451220-00, disponibili anche separatamente

130.00						90
OM 541.991 (OM501 LA)	V6cyl.	11946cc	300kW (408PS)	Diesel	Turbo Intercooled	TD25686
OM 941.991 (OM501 LA)	V6cyl.	11946cc	260-315kW (354-428PS)	Diesel	Turbo Intercooled	TD28855
ACTROS MP2 / MP3			04/03→			





87-420900-50 STD ①

A 78.55
B- 14.97
BØ 110.00
D 119.55
52x102

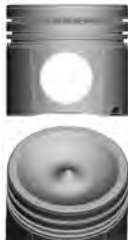

(13065D302)

AK KK NB RT TP

08-420900-00 STD ②

3.00 GDC ③
3.00 CR P
4.00 GDC P



15-451220-00 WH ⑤ ⑥ B 151.20 C 258.00 D 164.20 E 10.12 F 1.10
14-451220-00 WH ⑤ B 151.20 C 258.00 D 164.20 E 10.12 F 1.10
13-451220-00
15-450790-00 WH ⑥ B 151.20 C 258.00 D 164.10 E 10.12 F 1.10
14-450790-00 WH B 151.20 C 258.00 D 164.10 E 10.12 F 1.10

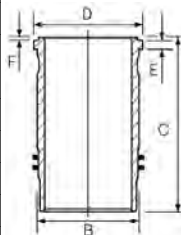

89-420900-50 ④
87-420900-50 +
15-451220-00

① OE 541 030 4417

② OE 541 030 0624

③ Steel

④ OE 541 030 4237

⑤ Includes Anti-Polish Ring (Fire Ring) 13-451220-00, also available separately

⑥ Includes seals

③ Stahl

⑤ Enthält Feuerring 13-451220-00, auch einzeln erhältlich

⑥ Schließt Dichtungen ein

③ Acier

⑤ Contient le segment racleur 13-451220-00 (disponible également)

⑥ Inclut des joints

③ Acero

⑤ Incluye el segmento rascador 13-451220-00, también disponible por separado

⑥ Incluye los sellos

③ Acciaio

⑤ Include anello Raschiaolio 13-451220-00, disponibili anche separatamente

⑥ Comprende le guarnizioni

130.00

91

OM 522 LA (Euro 2)

V8cyl.

15928cc

362-420kW (496-570PS)

Diesel

Turbo Intercooled

MP15588

INDUSTRIAL

14-450250-00 WH ① ② B 150.00 C 258.00 D 164.10 E 10.12 F 1.10

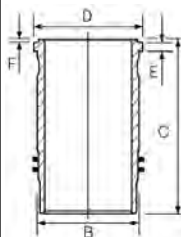

15-458580-00 WH ③ ④ B 150.00 C 258.00 D 164.10 E 10.12 F 1.10

14-458580-00 WH ③ B 150.00 C 258.00 D 164.10 E 10.12 F 1.10

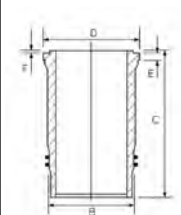

① Has different upper register design compared to 14-458580-00

① Hat unterschiedliche obere Flanschausführung im Vergleich zu 14-458580-00

① Profil inférieur de la colerette différent de 14-45880-00

① Tiene un registro superior diferente comparado al 14-458580-00

① Profilo inferiore del colletto diverso da 14-45880-00

② Round water channel 20mm below flange

② Runder Wasserkanal

② Canal d'eau rond

② Canal de agua redondo

② Passaggio acqua circolare

③ Rectangular water channel immediately below flange

③ Rechteckiger Wasserkanal unter dem Buchsenbund

③ Canal d'eau rectangulaire sous la bride

③ Canal de agua rectangular bajo la pestaña

③ Passaggio acqua rettangolare sotto flangia

④ Includes seals

④ Schließt Dichtungen ein

④ Inclut des joints

④ Incluye los sellos

④ Comprende le guarnizioni

132.00

92

OM 471.900 (Euro 6)

6cyl.

12809cc

310-375kW (422-510PS)

Diesel

Turbo Intercooled

TD25519

OM 471.902 (Euro 6)

6cyl.

12809cc

315-375kW (428-510PS)

Diesel

Turbo Intercooled

TD28759

OM 471.906 (Euro 6)

6cyl.

12809cc

310-375kW (422-510PS)

Diesel

Turbo Intercooled

TD29331

OM 471.909 (Euro 6)

6cyl.

12809cc

310-375kW (422-510PS)

Diesel

Turbo Intercooled

TD28082

OM 471.915 (Euro 6)

6cyl.

12809cc

310-375kW (422-510PS)

Diesel

Turbo Intercooled

TD29337





OM 471.919 (Euro 6)	6cyl.	12809cc	310-375kW (422-510PS)	Diesel	Turbo Intercooled	TD35010
OM 471.922 (Euro 6)	6cyl.	12809cc	310-390kW (422-530PS)	Diesel	Turbo Intercooled	TD35012
OM 471.926 (Euro 6)	6cyl.	12809cc	310-390kW (422-530PS)	Diesel	Turbo Intercooled	TD35013
OM 471.937 (Euro 6)	6cyl.	12809cc	306-375kW (416-510PS)	Diesel	Turbo Intercooled	TD35015
OM 471.944 (Euro 6)	6cyl.	12809cc	310-375kW (422-510PS)	Diesel	Turbo Intercooled	TD35020
OM 471.946 (Euro 6)	6cyl.	12809cc	310-375kW (422-510PS)	Diesel	Turbo Intercooled	TD35022
ACTROS MP4 / MP5			07/11→	Series 400		01/03→
ANTOS			07/12→12/18	Series 500		01/12→
AROCS			01/13→			

15-610060-00 WH ① ② ③ **B 141.97 C 256.00 D 159.00 E 7.00 F 1.00**

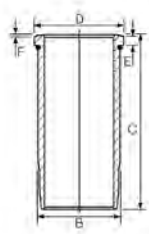

- ① Includes Anti-Polish Ring (Fire Ring)
- ② Includes seals
- ③ Relief 8.9mm

- ① Enthält Ölschlitzring
- ② Schließt Dichtungen ein
- ③ Entlastung 8.95mm

- ① Contient le segment racleur
- ② Inclut des joints
- ③ Le relief 8.95mm

- ① Incluye el segmento rascador
- ② Incluye los sellos
- ③ Relevación 8.95mm

- ① Include anello raschiaolio
- ② Comprende le guarnizioni
- ③ Rilievo 8.95mm

ENGINE INDEX

Motorverzeichnis • Index de moteur • Índice de Motor
 Indeks silnika • Модель Двигателя • دليل المحرك



CCM

x



9

14 K4F	Petrol	1396	4	75.00	4
16 K4F (K Series)	Petrol	1588	4	80.00	5
18G	Petrol	1798	4	80.25	8
18 K4F (K Series)	Petrol	1796	4	80.00	5
18 K4K (VVC)	Petrol	1796	4	80.00	6
20 T2N	Diesel	1994	4	84.45	10
25 K4F	Petrol	2497	V6	80.00	7
A+ SERIES	Petrol	1275	4	70.62	2
A SERIES	Petrol	1275	4	70.62	1
A SERIES (Overbored to 1380)	Petrol	1380	4	73.50	3
B SERIES	Petrol	1798	4	80.25	8
C SERIES	Petrol	2912	6	83.32	9



70.62

1

A SERIES 4cyl. **1275cc** **Petrol** **MP1176**



MK II 1300 01/68→12/72 MIDGET Mk II 01/67→12/73

87-521700-00 STD 
 87-521707-00 .020 
 87-521711-00 .040 
 87-521714-00 .060 

A 37.24
B- 5.74
D 57.24
 21x56



08-521700-00 STD
 08-521707-00 .020
 08-521711-00 .040
 08-521714-00 .060

1.48  P
 1.48  P
 4.00  P

14-010890-00 *D* **B 73.09 C 141.28**

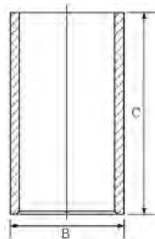





87-524100-00 STD 
 87-524107-00 .020 
 87-524111-00 .040 
 87-524114-00 .060 

A 38.74
B- 5.74
D 58.74
 21x56



08-524100-00 STD
 08-524107-00 .020
 08-524111-00 .040
 08-524114-00 .060

1.50  NT
 1.50  P
 3.00  P

 Pistons to be replaced in Engine Sets only  Kolben nur in Motorsätzen zu ersetzen  Piston à remplacer dans jeu moteur  Pistones de repuesto para juegos de motores solamente  Il pistone può essere rimpiazzato solamente completo

70.62

2

A+ SERIES 4cyl. **1275cc** **Petrol** **MP2934-2**



MG METRO 1300 01/82→12/87

87-524100-00 STD 
 87-524107-00 .020 
 87-524111-00 .040 
 87-524114-00 .060 

A 38.74
B- 5.74
D 58.74
 21x56



08-524100-00 STD
 08-524107-00 .020
 08-524111-00 .040
 08-524114-00 .060

1.50  NT
 1.50  P
 3.00  P

14-010890-00 *D* **B 73.09 C 141.28**

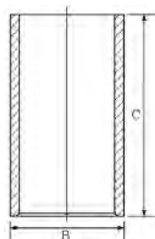

 Pistons to be replaced in Engine Sets only  Kolben nur in Motorsätzen zu ersetzen  Piston à remplacer dans jeu moteur  Pistones de repuesto para juegos de motores solamente  Il pistone può essere rimpiazzato solamente completo

73.50

3

A SERIES (Overbored to 1380) 4cyl. **1380cc** **Petrol** **MP1180-1**

MIDGET Mk III 01/67→12/73





87-526600-00 STD

A 37.78
B- 6.21
D 58.36
 21x64



08-526600-00 STD

1.50  CR P
 1.50  P
 4.00  CR P

75.00

4

14 K4F	4cyl.	1396cc	76kW (103PS)	Petrol	TD18866
EXPRESS 1.4			03/03→05/05	MG ZR 105	06/01→04/05

87-520500-00 STD
 01/95→

A 23.84
D 46.79
 18x48

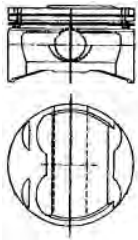

08-520500-00 STD

1.00 
 1.20 
 2.00  NT

14-710030-00 WH

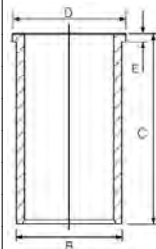

B 84.10 C 129.50 D 87.50 E 50.00

88-520500-00
 87-520500-00 +
 14-710030-00

Steel Stahl Acier Acero Acciaio

80.00

5

16 K4F (K Series)	4cyl.	1588cc	79-86kW (107-117PS)	Petrol	TD17597
18 K4F (K Series)	4cyl.	1796cc	86-100kW (117-136PS)	Petrol	TD18234
EXPRESS 1.8			03/03→05/05	MG ZR 120	06/01→04/05
MGF 1.6			02/00→03/02	MG ZS 1.6	11/01→10/05
MGF 1.8 i 16V			03/95→03/02	MG ZS 120	07/01→10/05
MG TF 115			03/02→12/09	MG ZT 1.8 16V	01/03→07/05
MG TF 120			03/02→12/09	MG ZT- 1.8 16V	01/03→07/05
MG TF 135			03/02→12/09		

87-522700-00 STD

A 22.70
B- 0.53
BØ 68.20
C 2.65
D 45.65
 18x53



08-522700-00 STD

1.00  CR
 1.20  P
 2.00  CR

14-710020-00 WH

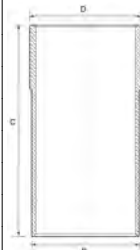

B 84.10 C 129.50 D 87.50 E 50.00

88-522700-00
 87-522700-00 +
 14-710020-00

Steel Stahl Acier Acero Acciaio

80.00

6

18 K4K (VVC)	4cyl.	1796cc	107-118kW (146-160PS)	Petrol	TD18235
EXPRESS 160			03/03→05/05	MG TF 160	03/02→12/09
MGF 1.8 i VVC			10/01→03/02	MG ZR 160	06/01→04/05
MGF 1.8 i VVC			03/95→03/02		





87-522700-10 STD

- A 22.70
- B- 0.53
- BØ 68.00
- C 1.00
- D 45.65
-  18x53
- TP



08-522700-00 STD

- 1.00  CR
- 1.20  P
- 2.00  CR

14-710020-00 WH

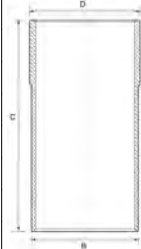

B 84.10 C 129.50 D 87.50 E 50.00

Steel

Stahl

Acier

Acero

Acciaio

 80.00

7

25 K4F	V6cyl.	2497cc	118-140kW (160-190PS)	Petrol	TD18236
MG750 2.5			09/11→12/16	MG ZT 180	02/02→10/05
MG ZS 180			07/01→10/05	MG ZT- 180	02/02→10/05
MG ZT 160			06/01→07/05	MG ZT 190	06/01→07/05
MG ZT- 160			10/01→07/05	MG ZT- 190	10/01→07/05

87-521600-00 STD

- A 27.35
- C 1.20
- D 50.30
-  18x53

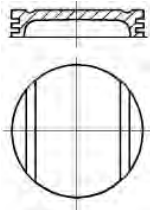

08-521600-00 STD

- 1.20  CR
- 1.50  CR
- 2.50  CR

14-710020-00 WH

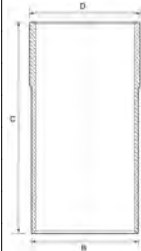

B 84.10 C 129.50 D 87.50 E 50.00

Steel

Stahl

Acier

Acero

Acciaio

 80.25

8

18G	4cyl.	1798cc	68-71kW (92-97PS)	Petrol	TD33225
B SERIES	4cyl.	1798cc		Petrol	MP1184
MGB 1.8			05/62→12/80	MGB GT 1.8	07/65→11/80
MGB GT			01/63→12/80		

87-521907-00 .020

87-521911-00 .040

- A 42.11
- B- 3.76
- D 61.06
-  21x57

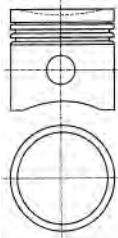

- 1.58 
- 1.58 
- 1.58 
- 3.96 





87-525900-00 STD ③
 87-525907-00 .020 ③
 87-525909-00 .030 ③
 87-525911-00 .040 ③
 87-525914-00 .060 ③

A 42.16
 B- 3.76
 BØ 64.50
 D 61.11
 21x57

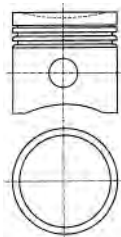

08-525907-00 .020
 08-525909-00 .030
 08-525911-00 .040
 08-525914-00 .060

1.59 P
 1.59 P
 4.00 P

- ① Short skirt design
- ② Pin retained by circlips
- ③ Piston pin press fit in conrod

- ① Kurzschaftausführung
- ② Bolzen mit Sicherungsclips gehalten
- ③ Kolbenbolzen in Pleuel eingepreßt

- ① A jupe courte
- ② Axe retenu par circlips
- ③ Axe serré sur bielle

- ① Diseño de falda corta
- ② Bulón retenido por anillos de retención
- ③ Bulón del pistón montado a presión en la biela

- ① A mantello corto
- ② Spinotto trattenuto da fermi
- ③ Spinotto inserto a spinta nella biella

83.32 **9**

C SERIES	6cyl.	2912cc	Petrol	MP1186-1
MGC 2.9		01/68→12/70	MGC GT	01/68→12/70

87-530100-00 STD ①
 87-530107-00 .020 ①
 87-530109-00 .030 ①

A 47.73
 D 87.31
 22x72

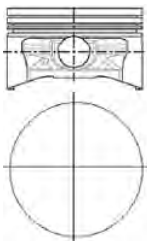

08-530100-00 STD
 08-530107-00 .020
 08-530109-00 .030

1.98 P
 1.98 P
 1.98 P
 4.74 P
 4.76 P

- ① Pistons to be replaced in Engine Sets only

- ① Kolben nur in Motorsätzen zu ersetzen

- ① Piston à remplacer dans jeu moteur

- ① Pistones de repuesto para juegos de motores solamente

- ① Il pistone può essere rimpiazzato solamente completo

84.45 **10**

20 T2N	4cyl.	1994cc	74-83kW (101-113PS)	Diesel	Turbo Intercooled	TD24113
EXPRESS 2.0 TD			03/03→05/05	MG ZS 2.0 TD		01/04→10/05
MG ZR 2.0 TD			06/01→04/05			

87-119800-00 STD
 87-119807-00 0.50mm

A 47.97
 B- 17.00
 BØ 38.00
 D 76.97
 30x70



08-119800-00 STD ①
 08-119807-00 0.50mm ①

3.00 PS
 2.00 P
 3.00 CR

- ① 15 degree Wedge Top Ring

- ① 15-Grad Keiloberring

- ① Segment trapézoïdal angle 15 de grés.

- ① Anillo superior en cuña de 15 grados

- ① Segmento trapezio con inclinazione fianchi = 15

Motorverzeichnis • Index de moteur • Índice de Motor
 Indeks silnika • Модель ДВИгателя • دليل المحرك

ENGINE INDEX



CCM

x



9

1ND (Euro 3/4)	Diesel	1364	4	73.00	2
1ND-TV (Euro 3/4)	Diesel	1364	4	73.00	2
9HZ (DV6TED4)	Diesel	1560	4	75.00	3
99 H (A SERIES)	Petrol	998	4	64.56	1
B37 C15 A	Diesel	1496	3	84.00	10
B47 C20 B (Euro 6)	Diesel	1995	4	84.00	11
N12 B14 A	Petrol	1397	4	77.00	4
N12 B16 A	Petrol	1598	4	77.00	5
N14 B16 A	Petrol	1598	4	77.00	6
N16 B16 A	Petrol	1598	4	77.00	5
N18 B16 A	Petrol	1598	4	77.00	7
N47 C20 A	Diesel	1995	4	84.00	12
W10 B16 A	Petrol	1598	4	77.00	8
W11 B16 A	Petrol	1598	4	77.00	9





64.56 **1**

99 H (A SERIES) 4cyl. **998cc** **29-33kW** (39-45PS) **Petrol** **TD26960**



MINI 1000 10/67→06/93

87-522400-00 STD ① ②

A 34.09
B- 4.93
D 65.77
 16x56



08-522400-00 STD
08-522407-00 .020

1.58  P
1.58  P
4.00  CR P

- ① Pistons to be replaced in Engine Sets only ① Kolben nur in Motorsätzen zu ersetzen ① Piston à remplacer dans jeu moteur ① Pistones de repuesto para juegos de motores solamente ① Il pistone può essere rimpiazzato solamente completo
- ② Pin retained by circlips ② Bolzen mit Sicherungsclips gehalten ② Axe retenu par circlips ② Bulón retenido por anillos de retención ② Spinotto trattenuto da fermi

73.00 **2**

1ND (Euro 3/4) 4cyl. **1364cc** **55-65kW** (75-88PS) **Diesel** **Turbo Intercooled** **TD18565**

1ND-TV (Euro 3/4) 4cyl. **1364cc** **55-65kW** (75-88PS) **Diesel** **Turbo Intercooled** **TD22098**

MINI One D 06/03→09/06



87-424100-00 STD
87-424107-00 0.50mm

A 41.94
B- 14.70
BØ 36.50
C 0.90
D 64.35
 27x59

KK RT



08-424100-00 STD
08-424107-00 0.50mm

1.50  NT ①
1.50  CR P
3.00  NT ①

- ① Steel ① Stahl ① Acier ① Acero ① Acciaio

75.00 **3**

9HZ (DV6TED4) 4cyl. **1560cc** **66-80kW** (90-109PS) **Diesel** **Turbo Intercooled** **TD20982**

MINI CLUBMAN Cooper D 10/07→02/10 MINI One D 06/09→07/10

MINI Cooper D 11/06→09/10



87-424000-00 STD
87-424008-00 0.60mm

A 41.70
B- 13.25
BØ 41.80
C 1.20
D 65.30
 26x61

AK KK RT TP



08-424000-00 STD
08-424007-00 0.50mm
08-424008-00 0.60mm

3.00  CK P
1.95  P
2.50  CR P



14-020900-00 D **B** 78.00 **C** 142.00 **D** 79.50 **F** 5.00

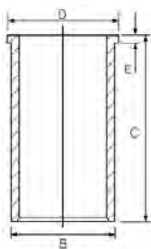

77.00 **4**

N12 B14 A 4cyl. **1397cc** **55-70kW** (75-95PS) **Petrol** **TD24547**

MINI CLUBMAN One 03/09→02/10 MINI One LPG 03/09→03/10

MINI One 11/06→03/10





87-444800-40 STD

- A 30.80
- B- 3.10
- B0 55.33
- B+ 3.20
- C 5.88
- C 3.54
- D 50.85
- 18.00x43.00

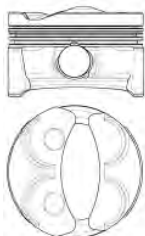

TP

08-444800-10 STD

08-444807-10 0.50mm

- 1.20 PVD P
- 1.50 P
- 2.00 NT

Steel

Stahl

Acier

Acero

Acciaio

77.00

5

N12 B16 A	4cyl.	1598cc	85-90kW (116-122PS)	Petrol	TD20893
N16 B16 A	4cyl.	1598cc	55-90kW (75-122PS)	Petrol	TD25563
MINI 1.6 Cooper			10/14→05/15	MINI Cooper	09/06→06/15
MINI CLUBMAN Cooper			10/07→06/14	MINI COUNTRYMAN Cooper	08/10→10/16
MINI CLUBMAN One			03/10→06/14	MINI COUNTRYMAN One	08/10→10/16
MINI CLUBVAN Cooper			12/12→06/14	MINI One	09/09→06/15
MINI CLUBVAN One			12/12→06/14	MINI PACEMAN Cooper	04/12→09/16

87-444800-10 STD

87-444807-10 0.50mm

- A 27.50
- B- 2.00
- B0 57.50
- C 3.97
- C 5.95
- D 47.50
- 18x43

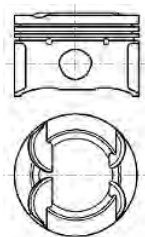

TP

08-444800-10 STD

08-444807-10 0.50mm

- 1.20 PVD P
- 1.50 P
- 2.00 NT

Steel

Stahl

Acier

Acero

Acciaio

77.00

6

N14 B16 A	4cyl.	1598cc	120-141kW (163-192PS)	Petrol Turbo Intercooled	TD24546
MINI CLUBMAN Cooper S			08/07→06/14	MINI Cooper S John Cooper Works	11/06→02/10
MINI Cooper S			10/06→06/15		

87-444800-30 STD

- A 28.50
- C 2.10
- D 50.12
- 20x48



TP

08-444800-10 STD

08-444807-10 0.50mm

- 1.20 PVD P
- 1.50 P
- 2.00 NT

Steel

Stahl

Acier

Acero

Acciaio

77.00

7

N18 B16 A	4cyl.	1598cc	90-160kW (122-218PS)	Petrol Turbo Intercooled	TD25564
MINI CLUBMAN Cooper S			10/07→06/14	MINI COUNTRYMAN Cooper	11/12→10/16
MINI Cooper S			10/07→06/15	MINI COUNTRYMAN Cooper S	08/10→10/16
MINI Cooper S JCW			12/10→04/15	MINI PACEMAN Cooper	11/12→09/16
MINI Cooper S John Cooper Works			01/12→11/13	MINI PACEMAN Cooper S	03/12→10/16





87-444800-50 STD
87-444807-50 STD

08-444800-10 STD
08-444807-10 0.50mm

A 28.50
B- 3.50
B+ 2.70
C 3.50
C 3.50
D 51.20
 20x48



1.20 PVD P
1.50 P
2.00 NT

HA RT TP

Steel Stahl Acier Acero Acciaio

77.00 **8**

W10 B16 A 4cyl. **1598cc** **66-85kW** (90-116PS) **Petrol** **TD18563**

MINI Cooper 06/01→07/08 MINI One 06/01→11/07

87-433500-00 STD
87-433505-00 0.25mm
87-433507-00 0.50mm

08-433500-00 STD
08-433505-00 0.25mm
08-433507-00 0.50mm

A 24.90
D 45.05
 19x54



1.20 NT
1.20 P
2.50 CR

TP

Steel Stahl Acier Acero Acciaio

77.00 **9**

W11 B16 A 4cyl. **1598cc** **120-160kW** (163-218PS) **Petrol Supercharged** **TD18564**

MINI Cooper S 03/02→11/07 MINI S Works 11/03→06/05
MINI John Cooper Works 07/04→11/07 MINI Works 11/03→09/06

87-423300-00 STD
87-423307-00 0.50mm
03/00→11/07

08-423300-00 STD
08-423307-00 0.50mm

A 26.50
B- 0.65
BØ 56.10
D 47.00
 21x50



1.20 P
1.20 CR
2.50 CR

AK TP

Steel Stahl Acier Acero Acciaio

84.00 **10**

B37 C15 A 3cyl. **1496cc** **70-85kW** (95-116PS) **Diesel Turbo** **TD28915**

MINI CLUBMAN One D 02/15→ MINI COUNTRYMAN One D 07/17→
MINI Cooper D 10/13→ MINI One D 02/14→





87-449700-30 STD 1
87-449707-30 STD

A 42.50
B- 14.15
BØ 47.50
D 65.50
26x60



AK KK RT TP

08-449700-10 STD

1.50 GDC 2
1.50 P
2.00 CR



1 BMW B47 UL TUE1 - OE 8580462.06
2 Steel

1 BMW B47 UL TUE1 - OE 8580462.06
2 Stahl

1 BMW B47 UL TUE1 - OE 8580462.06
2 Acier

1 BMW B47 UL TUE1 - OE 8580462.06
2 Acero

1 BMW B47 UL TUE1 - OE 8580462.06
2 Acciaio

84.00

11

B47 C20 B (Euro 6)	4cyl.	1995cc	100-140kW (136-190PS)	Diesel	Turbo	TD36058
MINI CLUBMAN Cooper D			12/14→	MINI COUNTRYMAN Cooper D		10/16→
MINI CLUBMAN Cooper SD			02/15→	MINI COUNTRYMAN Cooper SD		10/16→
MINI Cooper SD			05/15→			

87-449700-30 STD 1
87-449707-30 STD

A 42.50
B- 14.15
BØ 47.50
D 65.50
26x60



AK KK RT TP

08-449700-10 STD

1.50 GDC 2
1.50 P
2.00 CR



1 BMW B47 UL TUE1 - OE 8580462.06
2 Steel

1 BMW B47 UL TUE1 - OE 8580462.06
2 Stahl

1 BMW B47 UL TUE1 - OE 8580462.06
2 Acier

1 BMW B47 UL TUE1 - OE 8580462.06
2 Acero

1 BMW B47 UL TUE1 - OE 8580462.06
2 Acciaio

84.00

12

N47 C20 A	4cyl.	1995cc	82-105kW (112-143PS)	Diesel	Turbo Intercooled	TD25060
MINI CLUBMAN Cooper D			02/11→06/14	MINI COUNTRYMAN Cooper D		03/11→10/16
MINI CLUBMAN Cooper SD			02/11→06/14	MINI COUNTRYMAN Cooper SD		03/11→10/16
MINI CLUBVAN Cooper D			12/12→06/14	MINI PACEMAN Cooper D		03/12→09/16
MINI Cooper D			02/11→05/15	MINI PACEMAN Cooper SD		03/12→09/16
MINI Cooper SD			06/09→05/15			



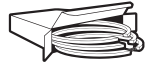

- 87-432200-00** STD
- 87-432205-00** 0.25mm
- 87-432207-00** 0.50mm

- 08-432200-00** STD 1
- 08-432205-00** 0.25mm
- 08-432207-00** 0.50mm

- A** 47.00
- B-** 14.50
- BØ** 47.50
- D** 73.00
- 32x63



- 1.75 GDC P
- 1.75 P
- 2.00 CR

(0840BB)
AK KK RT TP



1 OE 1125 781 2636

CCM
x

9

4D30	Diesel	3297	4	100.00	10
4D31	Diesel	3298	4	100.00	10
4D31T	Diesel	3298	4	100.00	10
4D55	Diesel	2347	4	91.10	5
4D55-T	Diesel	2347	4	91.10	6
4D56 (8V)	Diesel	2477	4	91.10	5
4D56 (12V) (Euro 3)	Diesel	2477	4	91.10	5
4D56-HP (Euro 4)	Diesel	2477	4	91.10	7
4D56-T	Diesel	2477	4	91.10	8
4D56-TD	Diesel	2477	4	91.10	5
4HK	Diesel	2179	4	85.00	4
4HN	Diesel	2179	4	85.00	4
4P10-T2 (Euro 5)	Diesel	2998	4	95.80	9
4P10-T6 (Euro 5)	Diesel	2998	4	95.80	9
BKD	Diesel	1968	4	81.00	2
HR16DE	Petrol	1598	4	78.00	1
OM457-T2 (Euro 3)	Diesel	11967	6	128.00	11
OM457-T3 (Euro 3)	Diesel	11967	6	128.00	11
OM457-T5 (Euro 5)	Diesel	11967	6	128.00	11
OM 639.939 (Euro 4)	Diesel	1493	3	83.00	3



78.00 1

HR16DE	4cyl.	1598cc	80kW (109PS)	Petrol	TD26598
DELICA D3 1.6		11/11→		LANCER VIII 1.6	01/07→

87-437700-00 STD ①
87-437707-00 0.50mm ①

08-437700-00 STD
08-437707-00 0.50mm

A 28.50
B- 4.70
BØ 65.00
B+ 2.20
C 1.80
D 49.20
① 19x55

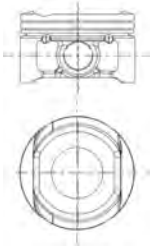

1.20 CR P ②
1.20 P
2.00 CR ②

RT

- | | | | | |
|----------------------------------|-------------------------------------|------------------------|--|--|
| ① Piston pin press fit in conrod | ① Kolbenbolzen in Pleuel eingepreßt | ① Axe serré sur bielle | ① Bulón del pistón montado a presión en la biela | ① Spinotto inserto a spinta nella biella |
| ② Steel | ② Stahl | ② Acier | ② Acero | ② Acciaio |

81.00 2

BKD	4cyl.	1968cc	103kW (140PS)	Diesel	Turbo Intercooled	TD22162
LANCER VIII 2.0 DI-D		01/08→				

87-139500-00 STD ①
87-139507-00 0.50mm ②

08-139500-00 STD
08-139507-00 0.50mm

A 45.83
B- 17.80
BØ 38.00
D 68.80
① 26x66
(07901J)



1.75 CK P
2.00 P
3.00 CR P

AK KK NB RT TP

- | | | | | |
|--------------------------------------|--|--|--|--|
| ① Bowl capacity 23.75cm ³ | ① Volumen der Kolbenmulde 23.75cm ³ | ① Volume de la cavité du piston 23.75cm ³ | ① Vol. cavidad pistón 23.75cm ³ | ① Volume camera pistone 23.75cm ³ |
| ② A = 45.550, D = 68.550 | | | | |

83.00 3

OM 639.939 (Euro 4)	3cyl.	1493cc	50-70kW (58-95PS)	Diesel	Turbo Intercooled	TD27273
COLT 1.5 DiD		08/04→06/12		COLT VI 1.5 DI-D	08/04→06/12	

87-427500-00 STD
87-427507-00 0.50mm

08-427500-00 STD
08-427507-00 0.50mm

A 45.65
B- 14.65
BØ 43.40
C 1.18
C 1.02
D 71.65
① 30x66
(8340A401)



2.00 CK
2.00 P
2.00 CR P



AK KK RT

85.00 4

4HK	4cyl.	2179cc	115kW (156PS)	Diesel	Turbo Intercooled	TD24800
4HN	4cyl.	2179cc	115kW (156PS)	Diesel	Turbo Intercooled	TD24440
OUTLANDER II 2.2 DI-D		08/07→11/12				





87-436700-10 STD 1
87-436708-10 0.60mm 1

A 48.70
B- 13.47
BØ 52.40
C 0.38
D 74.71



30x68

(0850HA127)

AK KK RT TP

08-436700-00 STD
08-436708-00 0.60mm

2.50 GDC P
 2.00 P
 2.00 CK



1 For pistons with a 24.3mm con rod gap measured at pin centre line

1 Für Kolben mit einem Pleuelaugenabstand von 24,3 MM, gemessen an der Kolbenboizen-Mitte

1 Pour pistons avec un écart de bielle de 24,3 mm mesuré au centre de l'axe bielle-piston

1 Para pistones con una distancia de paso de biela en el centro del bulón de 24,3mm

1 Per pistoni con passaggio biella di 24,3 mm misurato sull'asse foro spinotto

91.10

5

4D55	4cyl.	2347cc	48-62kW (65-84PS)	Diesel	TD5331
4D56 (8V)	4cyl.	2477cc	51-104kW (69-141PS)	Diesel Turbo	TD2293
4D56 (12V) (Euro 3)	4cyl.	2477cc	51-85kW (69-116PS)	Diesel	TD8288
4D56-TD	4cyl.	2477cc	66-73kW (90-99PS)	Diesel Turbo Intercooled	TD2294
Canter (FE3, FE4) V		09/92→09/96	L 300 / DELICA II 2.5		01/05→06/07
DELICA / SPACE GEAR 2.5		05/95→05/00	L 300 / DELICA II 2.5 D		11/86→04/94
L200 2.3 D		10/82→10/86	L 300 III 2.5 D		11/86→02/06
L200 2.5 D		10/86→12/07	L400 2.5 TD		05/95→05/00
L200 2.5 TD		06/96→12/07	PAJERO II 2.5 TD		12/90→04/00
L200 / TRITON 2.5 D		08/11→12/15	PAJERO II 2.5 TDiC		12/90→06/93
L 300 / DELICA II 2.3 D		04/83→10/86	PAJERO SPORT I 2.5 TDiC		01/08→12/12

14-015590-00 D **B 94.13 C 164.50**

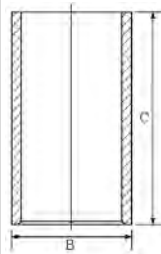

14-020600-00 DH **B 94.64 C 165.10 D 96.91 E 5.06**

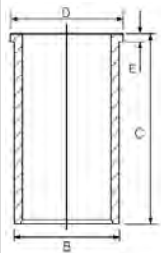





91.10

6

4D55-T	4cyl.	2347cc	62-70kW (84-95PS)	Diesel Turbo	TD2292
GALANT IV 2.3 Turbo-D		09/80→05/84	PAJERO I 2.3 TD		12/82→04/86
L200 2.3 D		09/82→12/85			





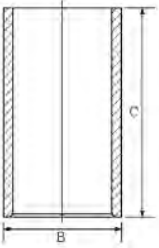
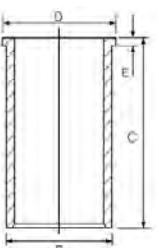









<p>87-287100-30 STD 87-287107-30 0.50mm</p> <p>A 48.70 B- 3.10 C 2.30 D 88.70  29x75 RT</p> 	<p>08-287100-00 STD ① 08-287107-00 0.50mm</p> <p>2.50  MO P 2.00  CR P 4.00  CR P</p>	<p>14-015590-00 D B 94.13 C 164.50</p> 	
		<p>14-020600-00 DH B 94.64 C 165.10 D 96.91 E 5.06</p> 	

① OE: MD103391

91.10						7
4D56-HP (Euro 4)	4cyl.	2477cc	94-133kW (128-181PS)	Diesel	Turbo Intercooled	TD24055
L200 / TRITON 2.5 DiD			11/05→12/15	PAJERO SPORT II 2.5 DI-D		07/08→
L200 / TRITON 2.5 DI-D			11/05→12/15	PAJERO SPORT III 2.5 DI-D		08/15→

<p>87-443500-00 STD ① 87-443507-00 0.50mm ①</p> <p>A 48.25 B- 18.90 BØ 44.00 C 2.00 C 2.50 D 78.25  32x75 AK KK RT TP</p> 	<p>08-443500-00 STD ② 08-443507-00 0.50mm</p> <p>2.55  NT ③ 2.05  CR 4.00  NT ③</p>		
<p>87-443500-10 STD ④ 87-443507-10 0.50mm ④</p> <p>A 48.25 B- 18.90 BØ 44.00 C 2.00 C 2.50 D 78.25  32x75 AK KK RT TP</p> 	<p>08-443500-00 STD ② 08-443507-00 0.50mm</p> <p>2.55  NT ③ 2.05  CR 4.00  NT ③</p>		

① To cylinder 1 & 2

① an Zylinder 1 & 2

① sur cylindre 1 & 2

① en el cilindro 1 & 2

① a cilindro 1 & 2

② OE: 1110A561

③ Stahl

③ Acier

③ Acero

③ Acciaio

④ To cylinder 3 & 4

④ an Zylinder 3 & 4

④ sur cylindre 3 & 4

④ en el cilindro 3 & 4

④ a cilindro 3 & 4

91.10						8
4D56-T	4cyl.	2477cc	62-110kW (84-150PS)	Diesel	Turbo Intercooled	TD4682





L200 2.5	08/92→10/96	PAJERO CLASSIC 2.5 TD	07/01→
L200 2.5 DI-D	01/04→12/07	PAJERO I 2.5 TD	05/86→12/91
L200 2.5 TD	06/90→12/07	PAJERO II 2.5 TDiC	03/91→08/99
L200 2.5 TDiC	08/01→09/05	PAJERO III 2.5 TDi	04/00→12/06
L 300 III 2.5 TD	02/87→05/04	PAJERO SPORT I 2.5 TD	11/97→
L400 2500 TD	05/95→06/05	PAJERO SPORT VAN I 2.5 TD	12/99→01/08

87-444200-00 STD ① ②
87-444207-00 0.50mm ① ②

A 48.70
B- 1.40
D 78.70
32x75

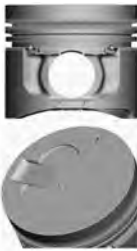

AK HA KK RT TP

08-444200-10 STD ③
08-444207-10 0.50mm

2.50 CR
2.00 CR P
4.00 NT④



14-015590-00 D B 94.13 C 164.50

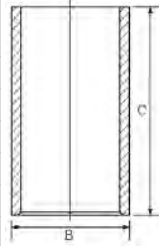

87-444200-10 STD ① ⑤
87-444207-10 0.50mm ① ⑤

A 48.70
B- 1.40
D 78.70
32x75

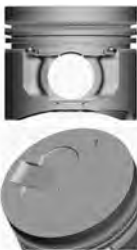

AK HA KK RT TP

08-444200-10 STD ③
08-444207-10 0.50mm

2.50 CR
2.00 CR P
4.00 NT④



14-020600-00 DH B 94.64 C 165.10 D 96.91 E 5.06

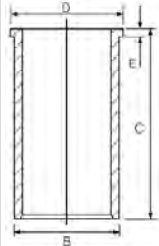

- | | | | | |
|--|---|--------------------------------------|---|--|
| ① Pistons to be replaced in Engine Sets only | ① Kolben nur in Motorsätzen zu ersetzen | ① Piston à remplacer dans jeu moteur | ① Pistones de repuesto para juegos de motores solamente | ① Il pistone può essere rimpiazzato solamente completo |
| ② To cylinder 1 & 2 | ② an Zylinder 1 & 2 | ② sur cylindre 1 & 2 | ② en el cilindro 1 & 2 | ② a cilindro 1 & 2 |
| ③ OE: MD168293 | ③ OE: MD168293 | ③ OE: MD168293 | ③ OE: MD168293 | ③ OE: MD168293 |
| ④ Steel | ④ Stahl | ④ Acier | ④ Acero | ④ Acciaio |
| ⑤ To cylinder 3 & 4 | ⑤ an Zylinder 3 & 4 | ⑤ sur cylindre 3 & 4 | ⑤ en el cilindro 3 & 4 | ⑤ a cilindro 3 & 4 |

95.80					9
4P10-T2 (Euro 5)	4cyl.	2998cc	96kW (131PS)	Diesel Turbo Intercooled	TD27035
4P10-T6 (Euro 5)	4cyl.	2998cc	129kW (175PS)	Diesel Turbo Intercooled	TD27057
CANTER		06/11→		Canter (FE5, FE6) VI	01/12→
Canter (FB7, FB8, FE7, FE8) VII		08/05→			

87-421600-00 STD

A 63.00
B- 16.00
BØ 50.50
D 93.50
36x80



AK KK RT TP

08-421600-00 STD
08-421606-00 0.40mm

2.50 CK P
2.00 P
2.50 CR P





100.00 10

4D30	4cyl.	3297cc	64kW (87PS)	Diesel	TD8268
4D31	4cyl.	3298cc	71kW (96PS)	Diesel	TD8293
4D31T	4cyl.	3298cc	86kW (117PS)	Diesel Turbo	TD8269
Canter		01/80→12/97		Canter (FE3, FE4) V	07/86→08/92
Canter (FE1, FE2) IV		07/79→12/85		Canter (FE5, FE6) VI	07/86→

14-010970-00 D B 104.00 C 196.50

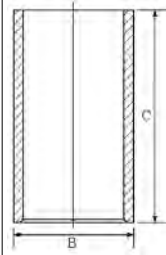

128.00 11

OM457-T2 (Euro 3)	6cyl.	11967cc	265kW (360PS)	Diesel Turbo Intercooled	TD27071
OM457-T3 (Euro 3)	6cyl.	11967cc	295kW (401PS)	Diesel Turbo Intercooled	TD27068
OM457-T5 (Euro 5)	6cyl.	11967cc	335kW (455PS)	Diesel Turbo Intercooled	TD27070
F-Series MK2		07/11→		Fuso	07/11→

87-427000-00 STD

A 85.00
B- 17.70
BØ 87.00
D 135.00
52x103



KK NB RT TP

08-427000-00 STD

3.00 GDC 1
3.00 CR
4.00 GDC P



15-451070-10 WH 2 3 B 144.50 C 266.30 D 155.50 E 10.12 F 1.10 4

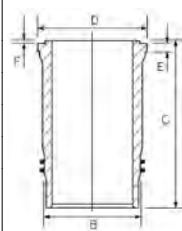

89-427000-00 2
87-427000-00 +
15-451070-10

- 1 Steel
- 2 Includes seals
- 3 Includes Anti-Polish Ring (Fire Ring) 13-451070-00, also available separately
- 4 Relief 6.50mm

- 1 Stahl
- 2 Schließt Dichtungen ein
- 3 Enthält Feuerring 13-451070-00, auch einzeln erhältlich
- 4 Entlastung 6.50mm

- 1 Acier
- 2 Inclut des joints
- 3 Contient le segment racleur 13-451070-00 (disponible également)
- 4 Le relief 6.50mm

- 1 Acero
- 2 Incluye los sellos
- 3 Incluye el segmento rascador 13-451070-00, también disponible por separado
- 4 Relevación 6.50mm

- 1 Acciaio
- 2 Comprende le guarnizioni
- 3 Include anello Raschiaolio 13-451070-00, disponibili anche separatamente
- 4 Rilievo 6.50mm

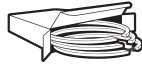

105.00 **1**

D 226-2	2cyl.	2080cc	27-30kW (37-41PS)	Diesel	TD18060
D 226-3	3cyl.	3120cc	33-44kW (45-60PS)	Diesel	TD18061
D 226-4	4cyl.	4160cc	44-64kW (60-87PS)	Diesel	TD6993
D 226-6	6cyl.	6234cc	66-114kW (90-155PS)	Diesel	TD18062

Farmer 01/72→ Favorit 01/70→

87-279600-10 *STD*

- A** 60.40
- B-** 20.00
- BØ** 62.00
- D** 113.40
- 35x82



08-279600-00 *STD*

- 3.00 CR P
- 2.00
- 2.00
- 4.00 CR P



ENGINE INDEX

Motorverzeichnis • Index de moteur • Índice de Motor
 Indeks silnika • Модель Двигателя • دليل المحرك



CCM

x



9

614.010	Diesel	1134	2	85.00	1
615.000	Diesel	2270	4	85.00	1
8025.01	Diesel	1559	2	95.00	2
8025.02	Diesel	1728	2	100.00	3
8035.01 / 8035.01.265	Diesel	2338	3	95.00	2
8035.02	Diesel	2592	3	100.00	3
8035.04	Diesel	2748	3	103.00	5
8035.05	Diesel	2930	3	104.00	7
8035.06	Diesel	2708	3	100.00	4
8045.01	Diesel	3119	4	95.00	2
8045.02	Diesel	3455	4	100.00	3
8045.04	Diesel	3666	4	103.00	5
8045.05	Diesel	3908	4	104.00	7
8045.06	Diesel	3613	4	100.00	4
8045.25	Diesel	3908	4	104.00	8
8055.04	Diesel	4583	5	103.00	5
8055.05	Diesel	4882	5	104.00	7
8061 L	Diesel	5499	6	103.00	6
8061.05	Diesel	5419	6	104.00	9
8065.02	Diesel	5184	6	100.00	3
8065.04	Diesel	5499	6	103.00	5
8065.05	Diesel	5861	6	104.00	7
8065.06	Diesel	5420	6	100.00	4
8065.24	Diesel	5499	6	103.00	6
8065.25	Diesel	5863	6	104.00	8
8210.02	Diesel	13798	6	137.00	19
8215.22	Diesel	13798	6	137.00	20
8460.21	Diesel	9500	6	120.00	18
8215.22.520	Diesel	13798	6	137.00	20
8365.05.500	Diesel	8102	6	115.00	16
8365.05.590	Diesel	8102	6	115.00	16
8365.25.500/502	Diesel	8102	6	115.00	17
8365.25.501/503/533	Diesel	8102	6	115.00	17
8365.25.590	Diesel	8102	6	115.00	16
8460.21.002	Diesel	9500	6	120.00	18
8460.21.042	Diesel	9500	6	120.00	18
8460.21.102	Diesel	9500	6	120.00	18
8460.21.106	Diesel	9500	6	120.00	18
8460.21.708	Diesel	9500	6	120.00	18
8460.21.710	Diesel	9500	6	120.00	18
C03	Diesel	4941	4	110.00	10
C03/20/21/41	Diesel	4562	4	110.00	11
CN3	Diesel	3706	3	110.00	10
CO3-130T	Diesel	5401	4	115.00	15
CP 3/100	Diesel	7412	6	110.00	10
GENESIS 5640	Diesel	4400	4	111.77	12
GENESIS 6640	Diesel	5000	4	111.77	13
GENESIS 7740	Diesel	5000	4	111.77	14
GENESIS 7840	Diesel	6600	6	111.77	12
GENESIS 8240, 8340	Diesel	7500	6	111.77	13



85.00				1
614.010	2cyl.	1134cc	Diesel	MP4129
615.000	4cyl.	2270cc	Diesel	MP4127
AGRICULTURAL				

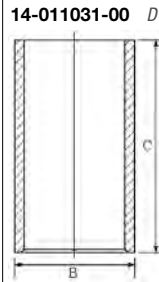

14-011031-00 D B 90.04 C 178.00

95.00				2
8025.01	2cyl.	1559cc	Diesel	MP569-1
8035.01 / 8035.01.265	3cyl.	2338cc	Diesel	MP4006
8045.01	4cyl.	3119cc	Diesel	MP571
AGRICULTURAL				

87-207200-00 STD
87-207208-00 0.60mm

A 59.60
B- 23.50
BØ 42.20
D 101.15
32x84



08-207200-00 STD
08-207208-00 0.60mm

2.50 CR P
2.50 P
5.50 CR P



14-010620-00 D B 99.00 C 187.00
14-011061-00 D B 99.10 C 187.00

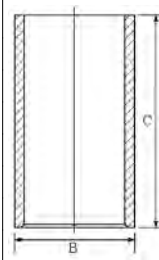

100.00				3
8025.02	2cyl.	1728cc	Diesel	MP573-1
8035.02	3cyl.	2592cc	33-40kW (45-54PS) Diesel	MP3475
8045.02	4cyl.	3455cc	44-50kW (60-68PS) Diesel	MP3476
8065.02	6cyl.	5184cc	Diesel	MP3477
AGRICULTURAL				

87-206800-00 STD
87-206808-00 0.60mm

A 59.60
B- 23.70
BØ 47.00
D 101.15
32x84



08-206800-00 STD
08-206808-00 0.60mm







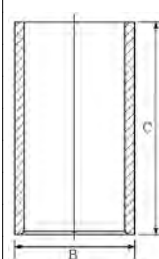

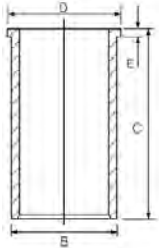

2.50 CR P
2.50 P
5.50 CR P



14-010170-00 D B 103.00 C 187.00
14-011021-00 D B 103.06 C 187.00
14-011022-00 D B 103.10 C 187.00









		<p>14-021540-00 <i>D</i> B 103.00 C 187.00 D 104.00 E 5.00</p> 	
<p>87-206800-10 <i>STD</i></p> <p>A 59.60 B- 23.70 BØ 45.40 D 101.15  32x84</p> 	<p>08-206800-00 <i>STD</i> 08-206808-00 0.60mm</p> <p>2.50  CR P 2.50  P 5.50  CR P</p>		
<p>87-781900-30 <i>STD</i> 87-781908-30 0.60mm</p> <p>A 59.60 B- 23.70 BØ 47.10 D 101.15  34x84</p> 	<p>08-781900-10 <i>STD</i> 08-781908-10 0.60mm</p> <p>2.50  CK P 2.50  P 4.00  CR P</p>		

⊠ Piston with central combustion chamber.
 ⊠ Kolben mit zentraler Verbrennungskammer.
 ⊠ Piston à chambre de combustion centrale.
 ⊠ Pistón con cámara de combustión central.
 ⊠ Pistone con camera di combustione centrale.

100.00					4
8035.06	3cyl.	2708cc	33-40kW (45-54PS)	Diesel	MP4008-1
8045.06	4cyl.	3613cc		Diesel	MP4013
8065.06	6cyl.	5420cc		Diesel	MP4017

AGRICULTURAL

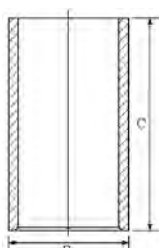
<p>87-781900-10 <i>STD</i> 87-781908-10 0.60mm</p> <p>A 65.15 B- 22.70 D 108.50  38x85</p> 	<p>08-781900-00 <i>STD</i> 08-781908-00 0.60mm</p> <p>2.50  MOL P 2.50  P 4.00  CR P</p>	<p>14-010780-00 <i>D</i> B 103.02 C 196.00 14-010781-00 <i>D</i> B 103.06 C 196.00 14-010782-00 <i>D</i> B 103.10 C 196.00</p> 	
---	---	---	--

103.00					5
8035.04	3cyl.	2748cc		Diesel	MP4007-1
8045.04	4cyl.	3666cc		Diesel	MP3483-1
8055.04	5cyl.	4583cc		Diesel	MP3484-1





8065.04 6cyl. **5499cc** Diesel **MP3486**

AGRICULTURAL

87-782000-00 STD
87-782008-00 0.60mm

A 59.60
B- 22.70
BØ 50.00
D 101.15
 34x90

08-782000-00 STD
08-782008-00 0.60mm

2.50 MOL P
 2.50 P
 4.00 CR P

14-010180-00 D **B** 107.00 **C** 187.00
14-010181-00 D **B** 107.06 **C** 187.00
14-010182-00 D **B** 107.10 **C** 187.00

14-023551-00 D **B** 107.06 **C** 187.00 **D** 110.00 **E** 5.00

103.00 **6**

8061 L 6cyl. **5499cc** Diesel **MP23487-1**

8065.24 6cyl. **5499cc** Diesel Turbo **MP3487**

AGRICULTURAL

87-783900-00 STD

A 59.61
B- 22.50
BØ 53.30
D 101.15
 34x90

RT

08-783900-00 STD

3.00 MOL P
 2.50 P
 4.00 CR

14-010180-00 D **B** 107.00 **C** 187.00
14-010181-00 D **B** 107.06 **C** 187.00
14-010182-00 D **B** 107.10 **C** 187.00

14-023551-00 D **B** 107.06 **C** 187.00 **D** 110.00 **E** 5.00

104.00 **7**

8035.05 3cyl. **2930cc** Diesel **MP4032**

8045.05 4cyl. **3908cc** Diesel **MP4012**





8055.05	5cyl.	4882cc	Diesel	MP4014
8065.05	6cyl.	5861cc	Diesel	MP4016

AGRICULTURAL

87-247800-00 STD

- A 65.15
- B- 22.50
- BØ 52.20
- D 108.50
- 38x85



TP

08-247800-00 STD

08-247808-00 0.60mm

- 2.50 MOL P
- 2.50 P
- 4.00 CR P

14-010940-00 D

B 107.00 C 198.00

14-010941-10 D

B 107.10 C 198.00

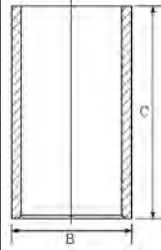

14-021361-00 D

B 107.02 C 198.00 D 110.87 E 5.00

14-021362-00 D

B 107.14 C 198.00 D 110.87 E 5.00

14-021363-00 D

B 107.44 C 198.00 D 110.87 E 5.00

14-021491-00 D

B 107.01 C 198.00 D 109.87 E 5.00

14-021492-00 D

B 107.05 C 198.00 D 109.87 E 5.00

14-021493-00 D

B 107.17 C 198.00 D 109.87 E 5.00

14-021494-00 D

B 107.47 C 198.00 D 109.87 E 5.00

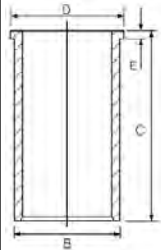

104.00

8

8045.25	4cyl.	3908cc	Diesel	Turbo	MP9242	
8065.25	6cyl.	5863cc	94-110kW (128-150PS)	Diesel	Turbo	MP4018

AGRICULTURAL

87-244500-40 STD

- A 65.15
- B- 22.50
- BØ 54.45
- D 108.50
- 38x89



AK RT

08-244500-00 STD

- 3.00 CR P
- 2.50 P
- 4.00 CR P

14-010940-00 D

B 107.00 C 198.00

14-010941-10 D

B 107.10 C 198.00

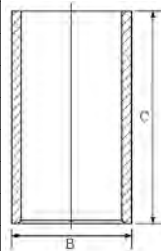



14-021361-00	D	B 107.02 C 198.00 D 110.87 E 5.00
14-021362-00	D	B 107.14 C 198.00 D 110.87 E 5.00
14-021363-00	D	B 107.44 C 198.00 D 110.87 E 5.00
14-021491-00	D	B 107.01 C 198.00 D 109.87 E 5.00
14-021492-00	D	B 107.05 C 198.00 D 109.87 E 5.00
14-021493-00	D	B 107.17 C 198.00 D 109.87 E 5.00
14-021494-00	D	B 107.47 C 198.00 D 109.87 E 5.00

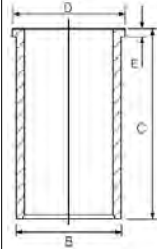

104.00

9

8061.05	6cyl.	5419cc	Diesel	MP13485
---------	-------	--------	--------	---------

AGRICULTURAL

87-247800-10 STD

A	65.15
B-	22.50
BØ	52.00
D	108.50
	38x85



RT TP

08-247800-00 STD
08-247808-00 0.60mm

2.50		MOL P
2.50		P
4.00		CR P

14-010940-00	D	B 107.00 C 198.00
14-010941-10	D	B 107.10 C 198.00

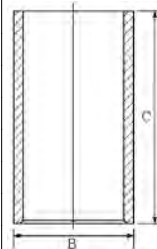

14-021361-00	D	B 107.02 C 198.00 D 110.87 E 5.00
14-021362-00	D	B 107.14 C 198.00 D 110.87 E 5.00
14-021363-00	D	B 107.44 C 198.00 D 110.87 E 5.00
14-021491-00	D	B 107.01 C 198.00 D 109.87 E 5.00
14-021492-00	D	B 107.05 C 198.00 D 109.87 E 5.00
14-021493-00	D	B 107.17 C 198.00 D 109.87 E 5.00
14-021494-00	D	B 107.47 C 198.00 D 109.87 E 5.00

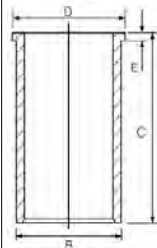

110.00

10

C03	4cyl.	4941cc	Diesel	MP14029
CN3	3cyl.	3706cc	Diesel	MP4028-1
CP 3/100	6cyl.	7412cc	Diesel	MP11310

AGRICULTURAL





87-207500-10 STD

- A 70.20
- B- 28.00
- BØ 55.00
- D 140.20
- 40x94



08-207500-00 STD

- 2.50 CR P
- 2.50 P
- 2.50 P
- 5.00 CR P

14-611250-00 WH

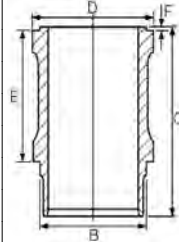

B 118.00 C 237.00 D 129.50 E 170.00 F 1.00

88-207500-10
87-207500-10 +
14-611250-00

87-207500-30 STD

- A 70.20
- B- 28.00
- BØ 55.00
- D 140.20
- 40x94



08-207500-00 STD

- 2.50 CR P
- 2.50 P
- 2.50 P
- 5.00 CR P

14-611250-00 WH

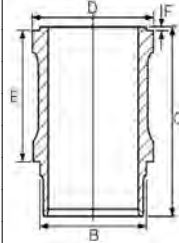

B 118.00 C 237.00 D 129.50 E 170.00 F 1.00

88-207500-30
87-207500-30 +
14-611250-00

110.00

11

C03/20/21/41

4cyl.

4562cc

Diesel

MP11307

AGRICULTURAL

87-207500-00 STD

- A 75.20
- B- 27.50
- BØ 51.00
- D 150.20
- 40x94



08-207500-00 STD

- 2.50 CR P
- 2.50 P
- 2.50 P
- 5.00 CR P

14-611250-00 WH

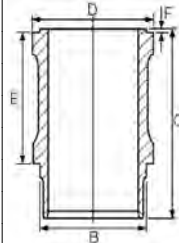

B 118.00 C 237.00 D 129.50 E 170.00 F 1.00

88-207500-00
87-207500-00 +
14-611250-00

111.77

12

GENESIS 5640

4cyl.

4400cc

Diesel

MP6763

GENESIS 7840

6cyl.

6600cc

Diesel

MP6764

AGRICULTURAL

87-521300-00 STD

87-521307-00 .020

- A 80.85
- B- 18.50
- BØ 61.85
- D 134.20
- 38x89



08-521300-00 STD

08-521307-00 .020

- 2.38 CR
- 2.38 CR
- 4.76 CR

14-010820-00 D

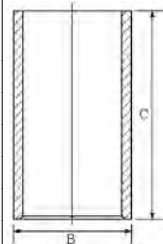

B 114.40 C 205.60

111.77

13

GENESIS 6640

4cyl.

5000cc

Diesel

MP6765

GENESIS 8240, 8340

6cyl.

7500cc

Diesel

MP6766

AGRICULTURAL





87-521300-10 STD

- A 73.25
- B- 21.67
- BØ 61.80
- D 126.60
- 38x89

RT TP



08-521300-00 STD
08-521307-00 .020

- 2.38 CR
- 2.38 CR
- 4.76 CR

14-010820-00 D

B 114.40 C 205.60

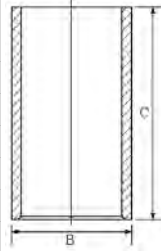

111.77

14

GENESIS 7740

4cyl.

5000cc

Diesel

Turbo

MP6767

AGRICULTURAL

87-521400-00 STD

87-521407-00 .020

- A 72.90
- B- 19.86
- BØ 61.80
- D 126.30
- 41x95

RT TP



08-521400-00 STD

08-521407-00 .020

- 3.00 CR
- 2.38 CR
- 4.76 CR

14-010820-00 D

B 114.40 C 205.60

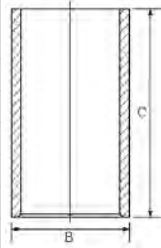

115.00

15

CO3-130T

4cyl.

5401cc

Diesel

MP4030-1

AGRICULTURAL

14-633860-00 WH

B 122.00 C 235.00 D 129.90 E 167.00

14-684840-00 WH

B 122.00 C 235.00 D 129.70 E 167.00

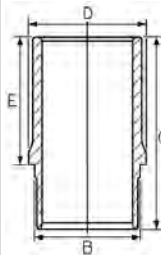

115.00

16

8365.05.500

6cyl.

8102cc

Diesel

MP3494

8365.05.590

6cyl.

8102cc

Diesel

MP13494

8365.25.590

6cyl.

8102cc

Diesel

Turbo

MP19107

AGRICULTURAL

87-523000-00 STD

- A 76.50
- B- 29.40
- BØ 54.00
- D 140.50
- 42x97

RT



08-523000-00 STD

- 2.50 CR P
- 2.50 P
- 4.00 CR P

14-684840-00 WH

B 122.00 C 235.00 D 129.70 E 167.00

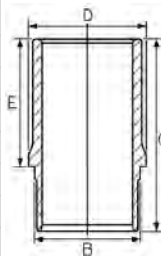

88-523000-00





87-523000-00 +
14-684840-00



115.00 17

8365.25.500/502	6cyl.	8102cc	Diesel	Turbo	MP9107
8365.25.501/503/533	6cyl.	8102cc	Diesel	Turbo	MP29107

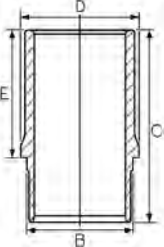
AGRICULTURAL

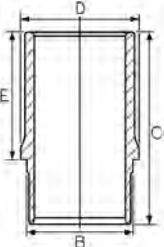
<p>87-245500-00 STD</p> <p>A 76.50 B- 29.00 BØ 59.30 D 140.50 42x97</p> <p>RT</p> 	<p>08-245500-00 STD</p> <p>3.00 CR P 2.50 P 4.00 CR P</p> 	<p>14-684840-00 WH</p> <p>B 122.00 C 235.00 D 129.70 E 167.00</p> 	<p>88-245500-00 87-245500-00 + 14-684840-00</p>
<p>87-245500-10 STD</p> <p>A 76.50 B- 27.70 BØ 59.00 D 140.50 42x97</p> <p>RT</p> 	<p>08-245500-00 STD</p> <p>3.00 CR P 2.50 P 4.00 CR P</p> 	<p>14-684840-00 WH</p> <p>B 122.00 C 235.00 D 129.70 E 167.00</p> 	<p>88-245500-10 87-245500-10 + 14-684840-00</p>

120.00 18

8460.21	6cyl.	9500cc	177kW (240PS)	Diesel	Turbo	MP4130-4
8460.21.002	6cyl.	9500cc	177kW (240PS)	Diesel	Turbo	MP4130-5
8460.21.042	6cyl.	9500cc	177kW (240PS)	Diesel	Turbo	MP4130-6
8460.21.102	6cyl.	9500cc	177kW (240PS)	Diesel	Turbo	MP4130-7
8460.21.106	6cyl.	9500cc	177kW (240PS)	Diesel	Turbo	MP4130-8
8460.21.708	6cyl.	9500cc	177kW (240PS)	Diesel	Turbo	MP4130-9
8460.21.710	6cyl.	9500cc	177kW (240PS)	Diesel	Turbo	MP4130-10

AGRICULTURAL

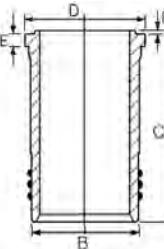
		<p>14-450880-00 WH ①</p> <p>B 134.00 C 250.00 D 144.80 E 10.02 F 1.00</p> 	
--	--	--	--

① Nitrided

① Nitriert

① Nituré

① Nitrado

① Nitrurato

137.00 19

8210.02	6cyl.	13798cc	Diesel	MP10601-1
---------	-------	---------	--------	-----------

AGRICULTURAL





87-207800-00 STD

- A 92.00
- B- 32.40
- BØ 67.00
- D 167.00
-  48x117

RT



08-207800-30 STD

- 4.00  CR P
- 3.00  P
- 3.00  P
- 5.50  CR P

- 14-021560-10 DH
- 14-021561-10 DH
- 14-021562-10 DH
- 14-021563-10 DH

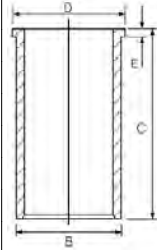

- B 143.00 C 282.00 D 147.00 E 6.06
- B 143.05 C 282.00 D 147.00 E 6.06
- B 143.25 C 282.00 D 147.00 E 6.06
- B 143.50 C 282.00 D 147.00 E 6.06

 137.00

20

8215.22	6cyl.	13798cc	Diesel	Turbo	MP9116-2
8215.22.520	6cyl.	13798cc	Diesel	Turbo	MP9116-3
AGRICULTURAL					

- 14-021560-10 DH
- 14-021561-10 DH
- 14-021562-10 DH
- 14-021563-10 DH

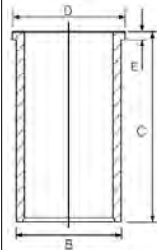

- B 143.00 C 282.00 D 147.00 E 6.06
- B 143.05 C 282.00 D 147.00 E 6.06
- B 143.25 C 282.00 D 147.00 E 6.06
- B 143.50 C 282.00 D 147.00 E 6.06

ENGINE INDEX

Motorverzeichnis • Index de moteur • Índice de Motor
 Indeks silnika • Модель Двигателя • دليل المحرك

CCM
x

9

B6-60TI-H	Diesel	5985	6	100.00	27
B6-60TI-L	Diesel	5985	6	100.00	27
D4F 712	Petrol	1149	4	69.00	1
D7F 764	Petrol	1149	4	69.00	2
F9Q 760	Diesel	1870	4	80.00	13
F9Q 762	Diesel	1870	4	80.00	13
F9Q 772	Diesel	1870	4	80.00	13
F9Q 774	Diesel	1870	4	80.00	13
G9T 722	Diesel	2188	4	87.00	20
G9T 750	Diesel	2188	4	87.00	20
G9U 632 (Euro 4)	Diesel	2464	4	89.00	21
G9U 650 (Euro 4)	Diesel	2464	4	89.00	21
G9U 720 (Euro 3)	Diesel	2464	4	89.00	22
G9U 730 (Euro 3)	Diesel	2464	4	89.00	22
H4B 408	Petrol	898	3	72.20	3
HR16DE	Petrol	1598	4	78.00	10
K4M	Petrol	1598	4	79.50	11
K4M 752	Petrol	1598	4	79.50	11
K7M 710	Petrol	1598	4	79.50	12
K9K	Diesel	1461	4	76.00	4
K9K 270	Diesel	1461	4	76.00	4
K9K 276	Diesel	1461	4	76.00	4
K9K 292	Diesel	1461	4	76.00	4
K9K 608 (Euro 5)	Diesel	1461	4	76.00	5
K9K 636 (Euro 5)	Diesel	1461	4	76.00	5
K9K 700	Diesel	1461	4	76.00	6
K9K 702	Diesel	1461	4	76.00	6
K9K 704 (Euro 3)	Diesel	1461	4	76.00	6
K9K 708	Diesel	1461	4	76.00	6
K9K 710	Diesel	1461	4	76.00	6
K9K 714	Diesel	1461	4	76.00	6
K9K 716	Diesel	1461	4	76.00	6
K9K 718	Diesel	1461	4	76.00	7
K9K 722 (Euro 3)	Diesel	1461	4	76.00	6
K9K 728	Diesel	1461	4	76.00	7
K9K 732	Diesel	1461	4	76.00	8
K9K 764	Diesel	1461	4	76.00	8
K9K 772	Diesel	1461	4	76.00	5
K9K 892 (Euro 4)	Diesel	1461	4	76.00	5
K9K 896 (Euro 5)	Diesel	1461	4	76.00	5
LD20	Diesel	1952	4	85.00	18
LD20iIL	Diesel	1952	4	85.00	18
M9R	Diesel	1995	4	84.00	16
M9R 630	Diesel	1995	4	84.00	17
M9R 760	Diesel	1995	4	84.00	16
M9R 780 (Euro 4)	Diesel	1995	4	84.00	16
M9R 782	Diesel	1995	4	84.00	16
M9T	Diesel	2299	4	85.00	19
M9T 670 (Euro 5)	Diesel	2299	4	85.00	19
M9T 672 (Euro 5)	Diesel	2299	4	85.00	19
M9T 676 (Euro 4)	Diesel	2299	4	85.00	19
M9T 678	Diesel	2299	4	85.00	19
M9T 680	Diesel	2299	4	85.00	19
M9T 686 (Euro 5)	Diesel	2299	4	85.00	19
M9T 690 (Euro 5)	Diesel	2299	4	85.00	19
M9T 692 (Euro 4)	Diesel	2299	4	85.00	19
M9T 694 (Euro 4)	Diesel	2299	4	85.00	19
M9T 696 (Euro 4)	Diesel	2299	4	85.00	19
M9T 698 (Euro 5)	Diesel	2299	4	85.00	19
M9T 702 (Euro 5)	Diesel	2299	4	85.00	19

CCM
x

9





M9T 870 (Euro 5)	Diesel	2299	4	85.00	19
M9T 880 (Euro 5)	Diesel	2299	4	85.00	19
R9M	Diesel	1598	4	80.00	14
R9M 413	Diesel	1598	4	80.00	14
R9M 452	Diesel	1598	4	80.00	14
RD28	Diesel	2826	6	85.00	18
SD20	Diesel	1991	4	83.00	15
SD22	Diesel	2164	4	83.00	15
SD23	Diesel	2289	4	89.00	23
SD25	Diesel	2488	4	89.00	23
SD33	Diesel	3246	6	83.00	15
SD33T	Diesel	3246	6	83.00	15
TD15 (TUD5)	Diesel	1527	4	77.00	9
TD25	Diesel	2494	4	92.90	25
TD27	Diesel	2663	4	96.00	26
TD27ETI	Diesel	2664	4	96.00	26
TD27T	Diesel	2664	4	96.00	26
TD27TI	Diesel	2664	4	96.00	26
TD42	Diesel	4169	6	96.00	26
TD42T	Diesel	4169	6	96.00	26
YD25DDTI	Diesel	2488	4	89.00	24



69.00 **1**

D4F 712 4cyl. **1149cc** **55kW (75PS)** **Petrol** **TD18984**





KUBISTAR 1.2 16V 04/06→

<p>87-450000-00 STD 87-450007-00 0.50mm</p> <p>A 26.70 B- 1.10 BØ 60.30 D 44.70  18x54</p> 	<p>08-450000-10 STD 08-450007-10 0.50mm</p> <p>1.20  NT <input type="checkbox"/> 1.50  P 2.50  CR <input type="checkbox"/></p> <p><input type="checkbox"/> Steel <input type="checkbox"/> Stahl <input type="checkbox"/> Acier <input type="checkbox"/> Acero <input type="checkbox"/> Acciaio</p>
--	---

69.00 **2**

D7F 764 4cyl. **1149cc** **44kW (60PS)** **Petrol** **TD22375**





KUBISTAR 1.2 08/03→

<p>87-104100-00 STD 87-104107-00 0.50mm</p> <p>A 27.00 D 50.50  18x52</p> 	<p>08-104100-00 STD 08-104107-00 0.50mm</p> <p>1.50  CR P 1.50  P 2.50  CR P</p>
--	---

72.20 **3**

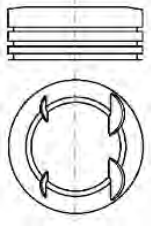
H4B 408 3cyl. **898cc** **66kW (90PS)** **Petrol Turbo Intercooled** **TD34137**

MICRA V 0.9 IG-T 12/16→

<p>87-450400-10 STD</p> <p>A 31.247mm B- 4.704mm BØ 61.54mm C 2.927mm C 0.457mm D 48.74  19.99x43.00</p> <p>TP</p> 	<p>08-450400-00 STD</p> <p>1.20  PVD NT <input type="checkbox"/> 1.50  P 2.00  NT <input type="checkbox"/></p> <p><input type="checkbox"/> Steel <input type="checkbox"/> Stahl <input type="checkbox"/> Acier <input type="checkbox"/> Acero <input type="checkbox"/> Acciaio</p>
--	--

76.00 **4**

K9K	4cyl.	1461cc	48-81kW (65-110PS)	Diesel	Turbo Intercooled	TD31672
K9K 270	4cyl.	1461cc	78-81kW (106-110PS)	Diesel	Turbo Intercooled	TD32710
K9K 276	4cyl.	1461cc	62-66kW (84-90PS)	Diesel	Turbo Intercooled	TD23877
K9K 292	4cyl.	1461cc	76-78kW (103-106PS)	Diesel	Turbo Intercooled	TD24675

CUBE 1.5 dCi	10/09→	PULSAR 1.5 dCi	10/14→
KICKS 1.5 D	01/19→05/20	QASHQAI / QASHQAI +2 I 1.5 dCi	11/06→04/14
KUBISTAR dCi 85	04/06→10/09	TERRANO 1.5 dCi	08/13→05/20
MICRA III 1.5 dCi	06/05→06/10	TIIDA 1.5 dCi	01/07→06/13
MICRA IV 1.5 D	01/11→	VERSA II 1.5 dCi	08/11→05/20
NOTE 1.5 dCi	03/06→09/12		





87-123400-40 STD
87-123407-40 0.50mm

A 41.70
B- 13.50
BØ 47.00
C 0.43
C 0.25
D 66.00
 26x60



(7657-701)
AK KK RT TP

08-123400-30 STD
08-123405-30 0.25mm
08-123407-30 0.50mm

2.00 CK P
 2.00 P
 2.50 CR P



14-020650-00 D

B 79.10 **C** 142.00 **D** 81.00 **E** 5.00

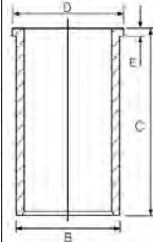

76.00

5

K9K 608 (Euro 5)	4cyl.	1461cc	63-66kW (86-90PS)	Diesel	Turbo Intercooled	TD29422
K9K 636 (Euro 5)	4cyl.	1461cc	81kW (110PS)	Diesel	Turbo Intercooled	TD29420
K9K 772	4cyl.	1461cc	63-76kW (86-103PS)	Diesel	Turbo Intercooled	TD28006
K9K 892 (Euro 4)	4cyl.	1461cc	66kW (90PS)	Diesel	Turbo Intercooled	TD31620
K9K 896 (Euro 5)	4cyl.	1461cc	81kW (110PS)	Diesel	Turbo Intercooled	TD31123
JUKE 1.5 dCi			06/10→	NV200 1.5 dCi 110		04/11→
JUKE dCi			06/10→	NV200 / EVALIA 1.5 dCi 85		07/10→
NOTE 1.5 dCi			06/13→	NV200 / EVALIA 1.5 dCi 90		04/11→
NV200 1.5 dCi 85			02/10→	NV200 / EVALIA 1.5 dCi 110		04/11→
NV200 1.5 dCi 90			04/11→	QASHQAI II 1.5 dCi		11/13→

14-020650-00 D

B 79.10 **C** 142.00 **D** 81.00 **E** 5.00

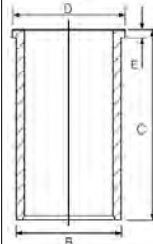

76.00

6

K9K 700	4cyl.	1461cc	47-50kW (64-68PS)	Diesel	Turbo Intercooled	TD21368
K9K 702	4cyl.	1461cc	60kW (82PS)	Diesel	Turbo Intercooled	TD23878
K9K 704 (Euro 3)	4cyl.	1461cc	47-48kW (64-65PS)	Diesel	Turbo Intercooled	TD17660
K9K 708	4cyl.	1461cc	48-50kW (65-68PS)	Diesel	Turbo Intercooled	TD26291
K9K 710	4cyl.	1461cc	42-45kW (57-61PS)	Diesel	Turbo Intercooled	TD26066
K9K 714	4cyl.	1461cc	42-45kW (57-61PS)	Diesel	Turbo Intercooled	TD26067
K9K 716	4cyl.	1461cc	50-51kW (68-69PS)	Diesel	Turbo Intercooled	TD29537
K9K 722 (Euro 3)	4cyl.	1461cc	60kW (82PS)	Diesel	Turbo Intercooled	TD20971
ALMERA II 1.5 dCi			01/03→09/06	MICRA III 1.5 dCi		01/03→06/10
KUBISTAR 1.5 dCi			08/03→	MICRA IV 1.5 D		11/10→05/20
KUBISTAR 1.5 dCi 70			09/05→10/09	NOTE 1.5 dCi		03/06→06/12





87-123400-00 STD
87-123407-00 0.50mm

A 41.69
B- 13.70
BØ 39.70
C 0.60
D 66.05
 25x60



RT TP

08-123400-00 STD
08-123407-00 0.50mm

2.00 CK P
2.00 P
2.50 NT

14-020650-00 D

B 79.10 **C** 142.00 **D** 81.00 **E** 5.00

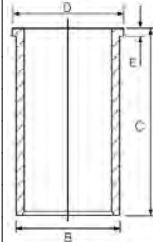

87-123400-10 STD
87-123407-10 0.50mm

A 41.82
B- 13.70
BØ 39.70
C 0.60
D 66.05
 26x60



(557.503)

RT TP

08-123400-00 STD
08-123407-00 0.50mm

2.00 CK P
2.00 P
2.50 NT

76.00

7

K9K 718 4cyl. **1461cc** **50-62kW** (68-84PS) **Diesel** **Turbo Intercooled** **TD35565**

K9K 728 4cyl. **1461cc** **74-78kW** (101-106PS) **Diesel** **Turbo Intercooled** **TD24669**

KUBISTAR dCi 85 04/06→10/09

87-123400-20 STD
87-123407-20 0.50mm

A 41.70
B- 14.00
BØ 39.70
C 0.43
C 0.25
D 66.00
 26x60



(07657-101)

AK KK RT TP

08-123400-00 STD
08-123407-00 0.50mm

2.00 CK P
2.00 P
2.50 NT

14-020650-00 D

B 79.10 **C** 142.00 **D** 81.00 **E** 5.00

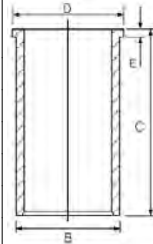

76.00

8

K9K 732 4cyl. **1461cc** **78kW** (106PS) **Diesel** **Turbo Intercooled** **TD29682**

K9K 764 4cyl. **1461cc** **78kW** (106PS) **Diesel** **Turbo Intercooled** **TD29684**

QASHQAI 1.5 DCI 02/07→





87-123400-30 STD
87-123407-30 0.50mm

A 41.70
B- 12.80
BØ 49.00
C 0.43
C 0.25
D 66.00
 26x60
 (07657-401)
AK KK RT TP



08-123400-30 STD
08-123405-30 0.25mm
08-123407-30 0.50mm

2.00  CK P
 2.00  P
 2.50  CR P



14-020650-00 D

B 79.10 **C** 142.00 **D** 81.00 **E** 5.00

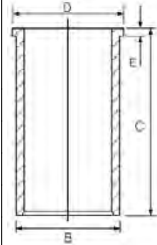

77.00

9

TD15 (TUD5)	4cyl.	1527cc	42kW (57PS)	Diesel	TD16316
MICRA II 1.5 D			02/98→02/03		

87-325800-00 STD
87-325806-00 0.40mm

A 40.37
B- 1.65
D 66.32
 23x60
AK RT





08-325800-00 STD
08-325806-00 0.40mm

2.00  CK P
 1.75  P
 3.00  CR P

78.00

10

HR16DE	4cyl.	1598cc	64-105kW (87-143PS)	Petrol	TD18677
AD 1.6			12/08→	NOTE 1.6	03/06→
ALMERA 1.6			04/14→	NOTE 1.6 NISMO S	06/13→
BLUEBIRD SYLPHY / SYLPHY III 1.6			08/12→	NP200 1.6	10/08→
CUBE 1.6 16V			08/09→	NV200 1.6 16V	02/10→
JUKE 1.6			06/10→	NV200 / EVALIA 1.6 16V	07/10→
JUKE 1.6 CVTC			08/14→	QASHQAI / QASHQAI +2 I 1.6	02/07→12/13
JUKE 1.6 LPG			01/12→	QASHQAI / QASHQAI +2 I 1.6 CVTC	03/13→04/14
JUKE CVTC			03/13→	QASHQAI / QASHQAI +2 I 1.6 LPG	11/10→12/13
KICKS 1.6			04/16→	SENTRA VII 1.6	05/13→
LIVINA / GRAND LIVINA 1.6			02/07→	TIIDA 1.6	08/05→
MICRA C+C III 1.6 160 SR			08/05→	TIIDA 1.6 CVTC	08/12→
MICRA III 160 SR			05/05→06/10	VERSA I 1.6	09/08→06/13
MICRA IV 1.6			09/11→	VERSA II 1.6	08/11→

87-437700-00 STD 
87-437707-00 0.50mm 

A 28.50
B- 4.70
BØ 65.00
B+ 2.20
C 1.80
D 49.20
 19x55
RT



08-437700-00 STD
08-437707-00 0.50mm

1.20  CR P 
 1.20  P
 2.00  CR 

 Piston pin press fit in conrod

 Kolbenbolzen in Pleuel eingepreßt

 Axe serré sur bielle

 Bulón del pistón montado a presión en la biela

 Spinotto inserto a spinta nella biella

 Steel

 Stahl

 Acier



 Acero

 Acciaio







79.50 **11**

K4M	4cyl.	1598cc	75-81kW (102-110PS)	Petrol	TD31398
K4M 752	4cyl.	1598cc	70kW (95PS)	Petrol	TD21398
APRIO 1.6			07/08→12/10	NP200 1.6	10/08→
BLUEBIRD SYLPHY II 1.6			12/12→	PLATINA 1.6	06/01→12/10
KUBISTAR 1.6 16V			08/03→10/09	TERRANO 1.6	10/13→05/20

<p>87-104200-30 STD</p> <p>A 31.70 B- 1.30 C 1.60 D 55.00 ① 20x62</p> 	<p>08-104200-00 STD 08-104207-00 0.50mm</p> <p>1.50 CR P 1.50 P 2.50 CR ①</p> 			
① Steel	① Stahl	① Acier	① Acero	① Acciaio

79.50 **12**

K7M 710	4cyl.	1598cc	64-76kW (87-103PS)	Petrol	TD41385
APRIO 1.6			10/09→	NP200 1.6	10/08→

<p>87-104200-00 STD ① 87-104207-00 0.50mm ①</p> <p>A 31.80 B+ 2.55 D 56.30 ① 19x63</p> 	<p>08-104200-00 STD 08-104207-00 0.50mm</p> <p>1.50 CR P 1.50 P 2.50 CR ②</p> 			
<p>87-104200-10 STD ③ 87-104207-10 0.50mm ③</p> <p>A 31.80 B+ 2.55 D 56.30 ③ 19x63</p> 	<p>08-104200-00 STD 08-104207-00 0.50mm</p> <p>1.50 CR P 1.50 P 2.50 CR ②</p> 			
① To cylinder 1 & 2 ② Steel ③ To cylinder 3 & 4	① an Zylinder 1 & 2 ② Stahl ③ an Zylinder 3 & 4	① sur cylindre 1 & 2 ② Acier ③ sur cylindre 3 & 4	① en el cilindro 1 & 2 ② Acero ③ en el cilindro 3 & 4	① a cilindro 1 & 2 ② Acciaio ③ a cilindro 3 & 4

80.00 **13**

F9Q 760	4cyl.	1870cc	74kW (101PS)	Diesel	Turbo Intercooled	TD20980
F9Q 762	4cyl.	1870cc	60kW (82PS)	Diesel	Turbo Intercooled	TD20991
F9Q 772	4cyl.	1870cc	60kW (82PS)	Diesel	Turbo Intercooled	TD19378
F9Q 774	4cyl.	1870cc	60kW (82PS)	Diesel	Turbo Intercooled	TD26548
INTERSTAR dCi 80			04/02→08/06	PRIMASTAR dCi 80		03/01→
PRIMASTAR 1.9 dCi 80			07/02→	PRIMASTAR dCi 100		03/01→
PRIMASTAR 1.9 dCi 100			07/02→			





87-101500-00 STD
87-101507-00 0.50mm

A 47.06
B- 17.80
BØ 38.00
C 0.75
D 77.00
 28x60



AK RT TP

08-101500-00 STD
08-101507-00 0.50mm

2.50  MO P
 2.00  P
 3.00  CR P

14-020280-00 D

B 83.00 **C** 155.00 **D** 85.00 **E** 5.00

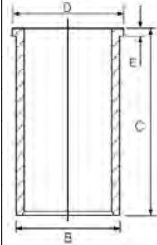

80.00

14

R9M	4cyl.	1598cc	70-107kW (95-146PS)	Diesel	Turbo Intercooled	TD28080
R9M 413	4cyl.	1598cc	70-89kW (95-121PS)	Diesel	Turbo Intercooled	TD34314
R9M 452	4cyl.	1598cc	92-118kW (125-160PS)	Diesel	Turbo Intercooled	TD34315
NV300 1.6 dCi 95			09/16→	NV300 1.6 dCi 145		09/16→
NV300 1.6 dCi 120			09/16→	QASHQAI II 1.6 dCi		11/13→
NV300 1.6 dCi 125			09/16→	QASHQAI / QASHQAI +2 I 1.6 dCi		10/11→04/14
NV300 1.6 dCi 125			09/16→	X-TRAIL dCi		04/14→
NV300 1.6 dCi 145			09/16→	X-TRAIL III 1.6 dCi		04/14→

87-424900-00 STD
87-424907-00 0.50mm

A 46.00
B- 12.35
BØ 46.50
C 0.30
D 70.50
 30x60



AK KK RT TP

08-424900-00 STD
08-424907-00 0.50mm

2.00  CK P
 1.75  P
 2.00  CR P

83.00

15

SD20	4cyl.	1991cc	44kW (60PS)	Diesel		TD29614
SD22	4cyl.	2164cc	46-47kW (63-64PS)	Diesel		TD2512
SD33	6cyl.	3246cc	70kW (95PS)	Diesel		TD2515
SD33T	6cyl.	3246cc	81-88kW (110-120PS)	Diesel	Turbo	TD2516
720 2.2 D			09/80→12/83	PATROL III/1 3.3 TD		01/84→12/87
HOMY 3.2 D			10/93→10/97	PATROL III/2 3.2 D		08/88→06/90
PATROL GR V 3.2 D			05/98→06/01	PICK UP 2.2 D		01/82→09/84
PATROL III/1 3.2 D			11/79→08/88	URVAN 2.2 D		11/80→07/83
PATROL III/1 3.2 TD			07/83→08/88	URVAN 3.2 D		02/92→04/97
PATROL III/1 3.3 D			06/80→12/87	URVAN 3.2 TD		02/92→04/97

14-021160-00 D

B 87.00 **C** 175.50 **D** 92.96 **E** 5.00

14-021170-00 DH

B 87.01 **C** 175.50 **D** 93.00 **E** 5.11

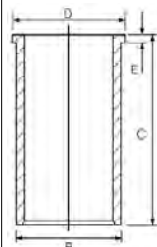



84.00						16
M9R	4cyl.	1995cc	110-130kW (150-177PS)	Diesel	Turbo Intercooled	TD22892
M9R 760	4cyl.	1995cc	127-130kW (173-177PS)	Diesel	Turbo Intercooled	TD20981
M9R 780 (Euro 4)	4cyl.	1995cc	66-84kW (90-114PS)	Diesel	Turbo Intercooled	TD20890
M9R 782	4cyl.	1995cc	66kW (90PS)	Diesel	Turbo Intercooled	TD24668
PRIMASTAR 2.0 dCi 90			09/06→	QASHQAI / QASHQAI +2 I 2.0 dCi		02/07→04/14
PRIMASTAR 2.0 dCi 115			09/06→	X-TRAIL dCi		01/11→02/14
PRIMASTAR dCi 90			09/06→	X-TRAIL II 2.0 dCi		06/07→11/13
PRIMASTAR dCi 120			09/06→	X-TRAIL III 2.0 dCi		10/16→

87-422000-00 STD
87-422007-00 0.50mm

08-422000-00 STD
08-422007-00 0.50mm

A 47.92
B- 14.90
BØ 49.07
C 0.40
C 0.40
D 76.00
32x65



AK KK RT TP

2.50 MOL P
2.00 MOL P
2.00 CR P



84.00						17
M9R 630	4cyl.	1995cc	66-84kW (90-114PS)	Diesel	Turbo Intercooled	TD26730
PRIMASTAR 2.0 dCi 90			09/06→	PRIMASTAR dCi 90		09/06→
PRIMASTAR 2.0 dCi 115			09/06→	PRIMASTAR dCi 120		09/06→

87-422000-10 STD
87-422007-10 0.50mm

08-422000-00 STD
08-422007-00 0.50mm

A 48.00
B- 14.00
BØ 50.00
D 76.00
32x65



KK RT TP

2.50 MOL P
2.00 MOL P
2.00 CR P



85.00						18
LD20	4cyl.	1952cc	43-51kW (58-69PS)	Diesel		TD2482
LD20IIL	4cyl.	1952cc	47-49kW (64-67PS)	Diesel		TD2488
RD28	6cyl.	2826cc	66-69kW (90-94PS)	Diesel		TD4711

BLUEBIRD 2.0 D			01/80→12/90	PATROL III/2 2.8 D		03/89→03/96
BOBBY 2.0 DLX			11/87→11/94	SERENA 2.0		07/92→09/94
BOBBY 2.0 DX			11/87→11/94	SERENA 2.0 D		06/91→09/01
CEDRIC 2.8 D			07/85→08/97	SKYLINE 2.0 D		08/81→07/84
CEDRIC 2.8 TD			06/91→10/95	TRADE 2.0 D		11/86→10/98
CREW 2.8 D			06/93→08/03	URVAN 2.0 D		02/92→09/94
GLORIA 2.8 TD			06/91→10/95	VANETTE 2.0 D		11/82→12/95
LAUREL 2.0 D			04/81→10/84	VANETTE CARGO 2.0 D		01/96→05/01
LAUREL 2.8 D			01/85→12/89			





14-020350-00 *D* B 88.60 C 150.00 D 90.50 E 4.50
 14-020351-00 *D* B 90.00 C 150.00 D 92.00 E 4.50

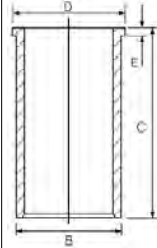

85.00

19

M9T	4cyl.	2299cc	74-125kW (100-170PS)	Diesel	Turbo Intercooled	TD31669
M9T 670 (Euro 5)	4cyl.	2299cc	74-92kW (101-125PS)	Diesel	Turbo Intercooled	TD26543
M9T 672 (Euro 5)	4cyl.	2299cc	74-92kW (101-125PS)	Diesel	Turbo Intercooled	TD26768
M9T 676 (Euro 4)	4cyl.	2299cc	74-92kW (101-125PS)	Diesel	Turbo Intercooled	TD26769
M9T 678	4cyl.	2299cc	107kW (146PS)	Diesel	Turbo Intercooled	TD26770
M9T 680	4cyl.	2299cc	92-107kW (125-145PS)	Diesel	Turbo Intercooled	TD26771
M9T 686 (Euro 5)	4cyl.	2299cc	92kW (125PS)	Diesel	Turbo Intercooled	TD26772
M9T 690 (Euro 5)	4cyl.	2299cc	74-92kW (101-125PS)	Diesel	Turbo Intercooled	TD26544
M9T 692 (Euro 4)	4cyl.	2299cc	66-92kW (90-125PS)	Diesel	Turbo Intercooled	TD26773
M9T 694 (Euro 4)	4cyl.	2299cc	107kW (146PS)	Diesel	Turbo Intercooled	TD26774
M9T 696 (Euro 4)	4cyl.	2299cc	92-107kW (125-146PS)	Diesel	Turbo Intercooled	TD26775
M9T 698 (Euro 5)	4cyl.	2299cc	92-107kW (125-146PS)	Diesel	Turbo Intercooled	TD26776
M9T 702 (Euro 5)	4cyl.	2299cc	100-120kW (136-163PS)	Diesel	Turbo Intercooled	TD32745
M9T 870 (Euro 5)	4cyl.	2299cc	74-92kW (100-125PS)	Diesel	Turbo Intercooled	TD31670
M9T 880 (Euro 5)	4cyl.	2299cc	110kW (150PS)	Diesel	Turbo Intercooled	TD30783
NV400 dCi 100			11/11→09/16	NV400 dCi 145		11/11→
NV400 dCi 110			06/14→	NV400 dCi 145 RWD		11/11→
NV400 dCi 125			11/11→09/16	NV400 dCi 150		02/14→
NV400 dCi 125 RWD			11/11→09/16	NV400 dCi 150 RWD		02/14→09/16
NV400 dCi 135			06/14→	NV400 dCi 160		06/14→09/16
NV400 dCi 135 RWD			06/14→06/16	NV400 dCi 165		06/14→09/16

87-435200-00 *STD*
 87-435207-00 *0.50mm*

A 48.00
 B- 16.20
 BØ 50.00
 C 0.45
 D 76.00
 32x65



AK KK RT TP

08-435200-00 *STD*
 08-435207-00 *0.50mm*

2.50 GDC P
 2.00 MO P
 2.00 CR P



87.00

20

G9T 722	4cyl.	2188cc	66kW (90PS)	Diesel	Turbo Intercooled	TD19379
G9T 750	4cyl.	2188cc	66kW (90PS)	Diesel	Turbo Intercooled	TD23886
INTERSTAR dCi 90			07/02→			





87-127400-00 STD
87-127407-00 0.50mm

A 54.53
B- 17.50
BØ 40.40
C 2.00
D 84.20
 **E** 31x65



AK RT TP

08-127400-00 STD
08-127407-00 0.50mm

3.00  PS P
1.75  P
2.50  P

89.00

21

G9U 632 (Euro 4)	4cyl.	2464cc	88-107kW (120-146PS)	Diesel	Turbo Intercooled	TD24665
G9U 650 (Euro 4)	4cyl.	2464cc	74-88kW (101-120PS)	Diesel	Turbo Intercooled	TD23875
INTERSTAR dCi 100			04/06→03/11	PRIMASTAR 2.5 dCi 150		09/06→
INTERSTAR dCi 120			08/06→	PRIMASTAR dCi 150		09/06→
INTERSTAR dCi 150			08/06→			

87-137500-30 STD
87-137507-30 0.50mm

A 53.07
B- 16.10
B- 4.90
BØ 48.00
C 2.00
C 1.60
D 83.09
 **E** 31x65



AK RT TP

08-137500-00 STD
08-137507-00 0.50mm

3.00  MO P
1.75  P
2.50  P

89.00

22

G9U 720 (Euro 3)	4cyl.	2464cc	73-84kW (99-114PS)	Diesel	Turbo Intercooled	TD21010
G9U 730 (Euro 3)	4cyl.	2464cc	99kW (135PS)	Diesel	Turbo Intercooled	TD18702
INTERSTAR dCi 100			11/03→	PRIMASTAR 2.5 dCi 140		07/02→
INTERSTAR dCi 115			04/02→	PRIMASTAR dCi 140		07/03→

87-137500-10 STD
87-137507-10 0.50mm

A 53.03
B- 17.85
BØ 43.20
C 1.65
C 1.90
D 83.09
 **E** 31x65



AK RT TP

08-137500-10 STD
08-137507-10 0.50mm

2.50  MO P
1.75  P
2.50  CR P

89.00

23

SD23	4cyl.	2289cc	50-56kW (68-76PS)	Diesel	TD2513
SD25	4cyl.	2488cc	45-57kW (61-77PS)	Diesel	TD2514
720 2.5 D			09/83→12/86	NAVARA 2.5 D	09/85→02/88
CABKING			06/97→03/07	PICK UP 2.3 D	04/83→08/88
CABSTAR 2.3 TD			01/82→06/92	PICK UP 2.5 D	04/83→02/98





CABSTAR 2.5 D	02/83→12/90	URVAN 2.3 D	11/82→11/88
CEDRIC 2.3 D	05/84→08/87		

14-021150-00 D

B 92.08 C 172.00 D 97.99 E 5.12

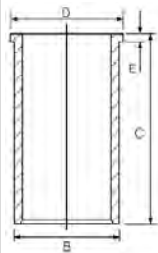

89.00

24

YD25DDTI	4cyl.	2488cc	76-140kW (103-190PS)	Diesel	Turbo Intercooled	TD17650
BASSARA 2.5 DCi			11/99→08/03	NP300 NAVARA 2.5 dCi		07/05→
CABSTAR 28.11 DCi, 32.11 DCi, 35.11 DCi 2.5			09/06→12/13	NP300 NAVARA 2.5 DCi		09/20→
CABSTAR 28.12 DCi, 32.12 DCi, 34.12 DCi, 35.12 DCi 2.5			09/06→12/13	NP300 PICKUP 2.5 dCi		04/08→
CABSTAR 34.110 DCi 2.5			01/07→04/12	NV350 2.5 dCi		06/12→
CABSTAR 35.13 DCi, 45.13 DCi 2.5			09/06→12/12	NV350 / CARAVAN 2.5 dCi		05/12→
CABSTAR 35.14 DCi, 45.14 DCi 2.5			09/06→12/13	PATHFINDER III 2.5 dCi		01/05→
MURANO II 2.5 dCi			01/10→09/14	PICK UP 2.5 dCi		03/02→
NAVARA 2.5 D			11/01→	PICK UP 2.5 Di		03/02→12/10
NAVARA 2.5 dCi			11/17→	PRESAGE 2.5 D		03/98→12/03
NAVARA 2.5 DDTi			01/15→	SANI 2.5 dCi		01/05→
NAVARA 2.5 Di			02/02→	SERENA 2.5 DCi SGX		06/99→09/05
NP300 NAVARA 2.5 D			09/08→			



87-452600-00 STD ①
 87-452607-00 0.50mm ①
 01/03→01/08

A 48.85
 B- 18.10
 BØ 43.00
 C 0.75
 C 1.20
 D 80.10
 28x61



AK KK RT TP

08-452600-00 STD
 08-452607-00 0.50mm

2.06  CK P
 2.00  CR P
 3.00  NT ②

87-436100-00 STD ③
 87-436107-00 0.50mm ③
 01/05→01/10

A 48.80
 B- 19.20
 BØ 44.30
 D 73.80
 28x71



AK KK RT TP

08-436100-00 STD
 08-436107-00 0.50mm

2.00  NT ②
 2.00  P
 3.00  NT ②





87-436100-30 STD ④
87-436107-30 0.50mm ④

A 48.85
B- 17.40
BØ 47.40
C 1.12
C 0.75
D 73.80
⌀ 28x71



AK KK RT TP

08-436100-00 STD
08-436107-00 0.50mm

2.00 ② NT②
2.00 P
3.00 ② NT②



① A2010-VK515 150hp
② Steel
③ A2010-EB31A 170hp
④ A2010-EC00B

② Stahl

② Acier

② Acero

② Acciaio

92.90

25

TD25	4cyl.	2494cc	55-71kW (75-97PS)	Diesel	Turbo Intercooled	TD4714
ATLAS II 2.5 D			10/93→10/97	NAVARA 2.5 D		01/86→03/08
CABSTAR 2.5 D			07/92→12/00	NAVARA 2.5 TD		02/98→10/01
CABSTAR 2.5 TD			10/82→09/93	PICK UP 2.5 D		08/87→04/05
HOMY 2.5 TD			05/92→10/95	URVAN 2.5 D		12/88→05/97

14-020120-00 D B 96.01 C 159.89 D 101.85 E 5.00

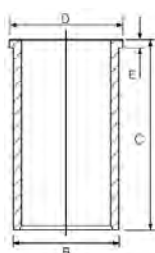

96.00

26

TD27	4cyl.	2663cc	58-73kW (79-99PS)	Diesel		TD2532
TD27ETI	4cyl.	2664cc	92-96kW (125-131PS)	Diesel	Turbo Intercooled	TD9896
TD27T	4cyl.	2664cc	61-74kW (83-101PS)	Diesel	Turbo	TD2533
TD27TI	4cyl.	2664cc	91-92kW (124-125PS)	Diesel	Turbo Intercooled	TD9478
TD42	6cyl.	4169cc	85-99kW (116-135PS)	Diesel		TD2535
TD42T	6cyl.	4169cc	85-118kW (116-160PS)	Diesel	Turbo Intercooled	TD10368
ATLAS II 2.7 TDiC			07/96→10/04	PATROL GR V 4.2 TDi		06/06→
CABSTAR 2.7 TD			02/83→12/92	PATROL III/1 4.2 D		01/88→09/00
CABSTAR E 90.32, 90.28, 95.32, 95.28			10/98→10/06	PATROL III/2 4.2 D		01/88→12/97
CABSTAR E 95.32			04/02→06/04	PICK UP 2.7 D		08/87→04/05
HOMY 2.7 TD			10/93→10/95	PICK UP 2.7 TD		09/87→10/01
NAVARA 2.7 D			09/87→12/01	SANI 2.7 TD		01/96→12/99
NAVARA 2.7 TD			01/97→10/01	TERRANO I 2.7 TD		02/89→02/96
PATHFINDER I 2.7 D			05/92→10/95	TERRANO II 2.7 TD		02/93→01/02
PATHFINDER II 2.7 TD			09/97→12/04	TERRANO II 2.7 TDi		05/96→09/07
PATROL GR IV 4.2 D			11/88→06/97	TRADE 2.7 TD		11/98→09/04
PATROL GR V 2.7 TD			05/98→06/01	UD Series MK1		01/03→12/09
PATROL GR V 4.2			05/13→	URVAN 2.7 D		03/87→09/93
PATROL GR V 4.2 D			05/98→09/07	URVAN 2.7 TD		10/94→08/00
PATROL GR V 4.2 TD			06/97→			





14-020110-00 *D*

B 99.08 C 160.00 D 105.03 E 5.09

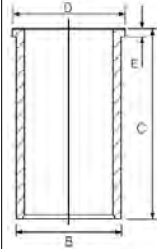

100.00

27

B6-60TI-H	6cyl.	5985cc	151kW (205PS)	Diesel	Turbo	TD28282
B6-60TI-L	6cyl.	5985cc	117kW (159PS)	Diesel	Turbo	TD8329

ATLEON

09/03→

87-325600-10 *STD*

- A** 70.05
- B-** 20.14
- BØ** 52.00
- D** 108.00
-  38x83



RT TP

08-325600-00 *STD*

- 3.50  **MO P**
- 2.50  **P**
- 4.00  **CR P**

14-025380-10 *DH*

B 104.23 C 226.44 D 107.44 E 3.86

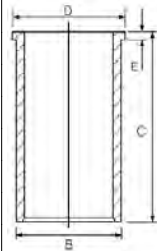

88-325600-10
87-325600-10 +
14-025380-10

87-325600-30 *STD* 

- A** 70.02
- B-** 19.48
- B-** 10.28
- BØ** 55.80
- D** 108.60
-  38x83



RT TP

08-325600-00 *STD*

- 3.50  **MO P**
- 2.50  **P**
- 4.00  **CR P**

 Original bowl design

 Original Schüssel Design

 Conception de bol Original

 Diseño Cuenco de Original

 Disegno ciotola Original

ENGINE INDEX

Motorverzeichnis • Index de moteur • Índice de Motor
 Indeks silnika • Модель Двигателя • دليل المحرك



CCM



9

13 S	Petrol	1297	4	75.00	13
13 SB	Petrol	1297	4	75.00	13
14 NV	Petrol	1389	4	77.60	15
16 D	Diesel	1598	4	80.00	28
16 DA	Diesel	1598	4	80.00	28
16 SV	Petrol	1598	4	79.00	17
17 D (4EE1)	Diesel	1686	4	79.00	25
18 SE	Petrol	1796	4	84.80	45
18 SEH	Petrol	1796	4	84.80	45
18 SV	Petrol	1796	4	84.80	45
20 NE	Petrol	1998	4	86.00	47
20 XE	Petrol	1998	4	86.00	48
21 D	Diesel	2068	4	88.00	51
23 D	Diesel	2260	4	92.00	55
23 DTR	Diesel	2260	4	92.00	55
23 TD	Diesel	2260	4	92.00	55
23 YD	Diesel	2260	4	92.00	55
23 YDT	Diesel	2260	4	92.00	55
25 TDS (VM41B)	Diesel	2499	4	92.00	56
8140.23.2585/3700 (Sofim)	Diesel	2800	4	94.40	58
8140.43.2585/3700/3900 (Sofim)	Diesel	2800	4	94.40	58
A 12 XEL	Petrol	1229	4	73.40	8
A 12 XER	Petrol	1229	4	73.40	8
A 13 DTE	Diesel	1248	4	69.60	1
A 13 DTR (Euro 5)	Diesel	1248	4	69.60	1
A 13 FD (Euro 5)	Diesel	1248	4	69.60	2
A 14 NEL (Euro 5 ecoFlex)	Petrol	1364	4	72.50	6
A 14 NET (Euro 5)	Petrol	1364	4	72.50	6
A 14 XER	Petrol	1398	4	73.40	9
A 16 LET (Euro 5)	Petrol	1598	4	79.00	18
A 16 XER (Euro 5)	Petrol	1598	4	79.00	19
A 20 DT (Euro 5)	Diesel	1956	4	83.00	37
A 20 DTC (Euro 5)	Diesel	1956	4	83.00	37
A 20 DTH (Euro 5)	Diesel	1956	4	83.00	37
A 20 DTJ (Euro 5)	Diesel	1956	4	83.00	37
A 20 DTL (Euro 5)	Diesel	1956	4	83.00	37
B 10 XFL (Euro 6)	Petrol	999	3	74.00	12
B 10 XFT (Euro 6)	Petrol	999	3	74.00	12
B 14 NEJ (Euro 6)	Petrol	1364	4	72.50	6
B 14 NEL (Euro 6)	Petrol	1364	4	72.50	6
B 14 NET (Euro 6)	Petrol	1364	4	72.50	6
B 14 XEL	Petrol	1398	4	73.40	10
B 16 DT (DV6DTE)	Diesel	1560	4	75.00	14
B 16 DT (DV6FD)	Diesel	1560	4	75.00	14
B 16 DTH	Diesel	1598	4	79.70	27
B 16 DTH (DV6FC)	Diesel	1560	4	75.00	14
C 13 N	Petrol	1297	4	75.00	13
C 14 NZ	Petrol	1389	4	77.60	15
C 16 NZ	Petrol	1598	4	79.00	20
C 16 SE	Petrol	1598	4	79.00	17
C 16 XE (Ecotec)	Petrol	1598	4	79.00	21
C 18 XE (Ecotec)	Petrol	1799	4	81.60	33
C 18 XEL (Ecotec)	Petrol	1799	4	81.60	33
C 20 NE	Petrol	1998	4	86.00	47
C 20 XE	Petrol	1998	4	86.00	48
C 25 XE (Ecotec)	Petrol	2498	V6	81.60	34
C 223	Diesel	2238	4	88.00	52
D 10 XFL (Euro 6)	Petrol	999	3	74.00	12
D 14 NET (Euro 6)	Petrol	1364	4	72.50	6
D 16 DTH	Diesel	1598	4	79.70	27

CCM
x

9

D 16 DTN	Diesel	1598	4	79.70	27
E 16 NZ	Petrol	1598	4	79.00	20
E 16 SE	Petrol	1598	4	79.00	17
F8Q 600	Diesel	1870	4	80.00	29
F8Q 606	Diesel	1870	4	80.00	29
F9Q 760	Diesel	1870	4	80.00	30
F9Q 762	Diesel	1870	4	80.00	30
F9Q 770	Diesel	1870	4	80.00	30
F9Q 772	Diesel	1870	4	80.00	30
F9Q 774	Diesel	1870	4	80.00	30
F 10 XFL (Euro 6)	Petrol	999	3	74.00	12
G9T 720	Diesel	2188	4	87.00	50
G9T 722	Diesel	2188	4	87.00	50
G9T 750	Diesel	2188	4	87.00	50
G9U 632 (Euro 4)	Diesel	2464	4	89.00	53
G9U 650 (Euro 4)	Diesel	2464	4	89.00	53
G9U 720 (Euro 3)	Diesel	2464	4	89.00	54
G9U 724 (Euro 3)	Diesel	2464	4	89.00	54
G9U 730 (Euro 3)	Diesel	2464	4	89.00	54
G9U 750	Diesel	2464	4	89.00	54
G9U 754 (Euro 3)	Diesel	2464	4	89.00	54
M9R 630	Diesel	1995	4	84.00	39
M9R 692 (Euro 5)	Diesel	1995	4	84.00	39
M9R 780 (Euro 4)	Diesel	1995	4	84.00	40
M9R 782	Diesel	1995	4	84.00	40
M9R 784	Diesel	1995	4	84.00	40
M9R 786 (Euro 4)	Diesel	1995	4	84.00	40
M9R 788	Diesel	1995	4	84.00	40
M9T 670 (Euro 5)	Diesel	2298	4	85.00	46
M9T 672 (Euro 5)	Diesel	2298	4	85.00	46
M9T 676 (Euro 4)	Diesel	2298	4	85.00	46
M9T 678	Diesel	2298	4	85.00	46
M9T 680	Diesel	2298	4	85.00	46
M9T 686 (Euro 5)	Diesel	2298	4	85.00	46
M9T 690 (Euro 5)	Diesel	2298	4	85.00	46
M9T 692 (Euro 4)	Diesel	2298	4	85.00	46
M9T 694 (Euro 4)	Diesel	2298	4	85.00	46
M9T 696 (Euro 4)	Diesel	2298	4	85.00	46
M9T 698 (Euro 5)	Diesel	2298	4	85.00	46
M9T 702	Diesel	2298	4	85.00	46
M9T 870	Diesel	2298	4	85.00	46
M9T 876	Diesel	2298	4	85.00	46
M9T 880	Diesel	2298	4	85.00	46
M9T 896	Diesel	2298	4	85.00	46
M9T 898	Diesel	2298	4	85.00	46
R9M 408	Diesel	1598	4	80.00	31
R9M 413	Diesel	1598	4	80.00	31
R9M 450	Diesel	1598	4	80.00	31
R9M 452	Diesel	1598	4	80.00	31
S8U 758	Diesel	2500	4	93.00	57
S8U 780	Diesel	2500	4	93.00	57
S8U 782	Diesel	2500	4	93.00	57
S9W 700	Diesel	2800	4	94.40	58
S9W 702	Diesel	2800	4	94.40	58
X 10 XE (Ecotec)	Petrol	973	3	72.50	5
X 12 XE (Ecotec)	Petrol	1199	4	72.50	7
X 14 NZ	Petrol	1389	4	77.60	15
X 14 SZ	Petrol	1389	4	77.60	15
X 16 SZ	Petrol	1598	4	79.00	20
X 16 SZR	Petrol	1598	4	79.00	22

ENGINE INDEX

Motorverzeichnis • Index de moteur • Índice de Motor
 Indeks silnika • Модель Двигателя • دليل المحرك

CCM
x

9

X 16 XE (Ecotec)	Petrol	1598	4	79.00	21
X 16 XEL (Ecotec)	Petrol	1598	4	79.00	21
X 17 D (4EE1)	Diesel	1686	4	79.00	25
X 18 XE (Ecotec)	Petrol	1799	4	81.60	33
X 18 XE1 (Ecotec)	Petrol	1796	4	80.50	32
X 20 DTH	Diesel	1995	4	84.00	41
X 20 DTL	Diesel	1995	4	84.00	42
X 22 DTH	Diesel	2171	4	84.00	43
X 25 XE (Ecotec)	Petrol	2498	V6	81.60	34
Y 13 DT (Euro 3/4)	Diesel	1248	4	69.60	3
Y 16 XE (Ecotec)	Petrol	1598	4	79.00	23
Y 17 DT	Diesel	1686	4	79.00	26
Y 17 DTL	Diesel	1686	4	79.00	26
Y 20 DTH	Diesel	1995	4	84.00	44
Y 20 DTJ	Diesel	1956	4	83.00	37
Y 20 DTL	Diesel	1995	4	84.00	42
Y 22 DTH	Diesel	2172	4	84.00	43
Y 22 DTR	Diesel	2172	4	84.00	43
Z 10 XE (Ecotec)	Petrol	973	3	72.50	5
Z 12 XE (Ecotec)	Petrol	1199	4	72.50	7
Z 12 XEP	Petrol	1229	4	73.40	11
Z 13 DT (Euro 4)	Diesel	1248	4	69.60	3
Z 13 DTE (Euro 4)	Diesel	1248	4	69.60	2
Z 13 DTH (Euro 4)	Diesel	1248	4	69.60	4
Z 14 XE (Ecotec)	Petrol	1389	4	77.60	16
Z 14 XEP (Ecotec)	Petrol	1364	4	73.40	10
Z 16 LET	Petrol	1598	4	79.00	18
Z 16 SE	Petrol	1598	4	79.00	23
Z 16 XE (Ecotec)	Petrol	1598	4	79.00	23
Z 16 XEP	Petrol	1598	4	79.00	24
Z 16 XER	Petrol	1598	4	79.00	19
Z 18 XE (Ecotec)	Petrol	1796	4	80.50	32
Z 18 XEL (Ecotec)	Petrol	1796	4	80.50	32
Z 19 DT	Diesel	1910	4	82.00	35
Z 19 DTH (Euro 4)	Diesel	1910	4	82.00	36
Z 19 DTJ	Diesel	1910	4	82.00	36
Z 19 DTL (Euro 4)	Diesel	1910	4	82.00	35
Z 20 DM	Diesel	1991	4	83.00	38
Z 20 DMH	Diesel	1991	4	83.00	38
Z 20 DTJ	Diesel	1956	4	83.00	37
Z 20 S	Diesel	1991	4	83.00	38
Z 22 SE (Ecotec)	Petrol	2198	4	86.00	49



69.60 **1**

A 13 DTE	4cyl.	1248cc	70kW (95PS)	Diesel	Turbo Intercooled	TD23881
A 13 DTR (Euro 5)	4cyl.	1248cc	70kW (95PS)	Diesel	Turbo Intercooled	TD24378
ASTRA J 1.3 CDTI			12/09→10/15	MERIVA B MPV 1.3 CDTI		06/10→11/14
ASTRA J 1.3 CDTI			10/12→10/15	MERIVA B VAN 1.3 CDTI		01/13→11/14
CORSA D 1.3 CDTI			06/09→08/14			

87-435700-10 STD
 87-435706-10 0.40mm

08-435700-00 STD
 08-435706-00 0.40mm

- A 40.43
- B- 12.70
- BØ 37.00
- C 1.15
- C 0.90
- D 62.43
- 23x57



- 1.50 GDC P
- 1.50 P
- 2.00 CR P



AK KK RT

Without Stop/Start Technology Für Fahrzeuge ohne StartStop Funktion Pour véhicules non équipé du start & stop Para vehículos sin función start-stop Per veicoli senza la funzione Start-Stop

69.60 **2**

A 13 FD (Euro 5)	4cyl.	1248cc	55-70kW (75-95PS)	Diesel	Turbo Intercooled	TD26182
Z 13 DTE (Euro 4)	4cyl.	1248cc	70kW (95PS)	Diesel	Turbo Intercooled	TD24376
COMBO Body/MPV 1.3 CDTI			02/12→	CORSA D 1.3 CDTI		06/09→08/14
COMBO Tour 1.3 CDTI			02/12→			

87-435700-00 STD
 87-435706-00 0.40mm

08-435700-00 STD
 08-435706-00 0.40mm

- A 40.43
- B- 12.70
- BØ 37.00
- C 1.15
- C 0.90
- D 62.43
- 23x57



- 1.50 GDC P
- 1.50 P
- 2.00 CR P



AK KK RT

With Stop/Start Technology Für Fahrzeuge mit StartStop Funktion Pour véhicules équipé du start & stop Para vehículos con función start-stop Per veicoli con la funzione Start-Stop

69.60 **3**

Y 13 DT (Euro 3/4)	4cyl.	1248cc	51kW (70PS)	Diesel	Turbo Intercooled	TD20084
Z 13 DT (Euro 4)	4cyl.	1248cc	51-59kW (70-80PS)	Diesel	Turbo Intercooled	TD17477
AGILA 1.3 CDTI			08/03→12/07	CORSA C 1.3 CDTI 16V		07/05→06/06
COMBO Body/MPV 1.3 CDTI 16V			08/05→	MERIVA A MPV 1.3 CDTI		04/05→05/10
COMBO Tour 1.3 CDTI 16V			06/04→01/11	TIGRA 1.3 CDTI		06/04→12/10
CORSA C 1.3 CDTI			06/03→12/09			

87-137600-00 STD
 87-137606-00 0.40mm

08-137600-00 STD
 08-137606-00 0.40mm

- A 40.43
- B- 12.40
- BØ 37.00
- C 1.00
- C 1.20
- D 63.43
- 23x57



- 2.00 CK P
- 1.50 P
- 2.00 P

AK RT TP



69.60 **4**

Z 13 DTH (Euro 4) 4cyl. **1248cc** **66-74kW** (90-101PS) **Diesel** **Turbo Intercooled** **TD18653**

ASTRA H 1.3 CDTI	08/05→	ASTRA H GTC 1.3 CDTI	04/05→10/10
ASTRA H 1.3 CDTI	02/07→10/10	CORSA D 1.3 CDTI	07/06→06/11

87-425600-00 STD
87-425606-00 0.40mm
87-425608-00 0.60mm

A 40.43
B- 12.41
BØ 38.00
C 0.91
C 0.91
D 62.43
 23x55
 (06933)
AK KK RT TP

08-425600-00 STD
08-425606-00 0.40mm
08-425608-00 0.60mm

2.00 CK P
 1.50 NT
 2.00 CR P

72.50 **5**

X 10 XE (Ecotec) 3cyl. **973cc** **40kW** (54PS) **Petrol** **TD5512**

Z 10 XE (Ecotec) 3cyl. **973cc** **43kW** (58PS) **Petrol** **TD14008**

AGILA 1.0 12V	09/00→12/07	CORSA C 1.0	09/00→06/03
CORSA B 1.0 i 12V	11/96→09/00		

87-102700-00 STD
87-102707-00 0.50mm

A 24.00
B- 1.20
BØ 56.00
C 1.25
D 45.00
 18x51

08-102700-00 STD
08-102707-00 0.50mm

1.20 NT
 1.50 P
 2.00 CR

Steel
 Stahl
 Acier
 Acero
 Acciaio

72.50 **6**

A 14 NEL (Euro 5 ecoFlex)	4cyl.	1364cc	88kW (120PS)	Petrol	Turbo Intercooled	TD24264
A 14 NET (Euro 5)	4cyl.	1364cc	103kW (140PS)	Petrol	Turbo Intercooled	TD23882
B 14 NEJ (Euro 6)	4cyl.	1364cc	74kW (101PS)	Petrol	Turbo Intercooled	TD29737
B 14 NEL (Euro 6)	4cyl.	1364cc	88kW (120PS)	Petrol	Turbo Intercooled	TD28264
B 14 NET (Euro 6)	4cyl.	1364cc	103-110kW (140-150PS)	Petrol	Turbo Intercooled	TD28263
D 14 NET (Euro 6)	4cyl.	1364cc	103kW (140PS)	Petrol	Turbo Intercooled	TD35620

ASTRA J 1.4 LPG	12/11→	INSIGNIA A 1.4 LPG	07/12→03/17
ASTRA J 1.4 Turbo	12/09→	MERIVA B MPV 1.4	06/10→03/17
ASTRA J GTC 1.4	10/11→	MERIVA B MPV 1.4 LPG	06/11→03/17
CASCADA 1.4	04/13→04/18	MOKKA / MOKKA X 1.4	06/12→
CASCADA 1.4 Turbo	03/13→04/18	MOKKA / MOKKA X 1.4 LPG	04/13→
CORSA D 1.4	07/12→08/14	ZAFIRA TOURER C 1.4	10/11→
CORSA E 1.4 Turbo	09/14→06/19	ZAFIRA TOURER C 1.4 LPG	10/11→
INSIGNIA A 1.4	04/11→03/17		











87-437400-10 STD
87-437407-10 0.50mm

A 25.87
B- 2.90
BØ 54.78
C 2.10
C 1.87
D 44.18
 18x48



HA RT TP

08-437400-00 STD 
08-437407-00 0.50mm 

1.20  DLC NT 
 1.20  P
 2.00  NT 

 CarboGlide®

 Steel

 Stahl

 Acier

 Acero

 Acciaio

72.50

7

X 12 XE (Ecotec)	4cyl.	1199cc	48kW (65PS)	Petrol	TD9508
Z 12 XE (Ecotec)	4cyl.	1199cc	55kW (75PS)	Petrol	TD14009
AGILA 1.2 16V			09/00→12/07	CORSA B 1.2 i 16V	03/98→09/00
ASTRA G 1.2			09/98→08/00	CORSA C 1.2	09/00→12/09
ASTRA G 1.2 16V			02/98→01/05	CORSA C 1.2 16V	09/00→07/03

87-102700-10 STD
87-102707-10 0.50mm

A 24.00
C 1.25
D 45.00
 18x51



 Steel

 Stahl

 Acier

 Acero

 Acciaio

08-102700-00 STD
08-102707-00 0.50mm

1.20  NT 
 1.50  P
 2.00  CR 

73.40

8

A 12 XEL	4cyl.	1229cc	51kW (69PS)	Petrol	TD24371
A 12 XER	4cyl.	1229cc	61-63kW (83-86PS)	Petrol	TD24372
ADAM 1.2			10/12→02/19	CORSA D 1.2 LPG	06/11→08/14
CORSA D 1.2			12/09→08/14		

87-429500-40 STD
87-429507-40 0.50mm

A 26.90
BØ 54.60
B+ 0.65
C 1.35
C 3.95
D 48.55
 18x53



 Steel

 Stahl

 Acier

 Acero

 Acciaio

08-429500-00 STD
08-429507-00 0.50mm

1.20  NT 
 1.20  P
 2.00  CR 

73.40

9

A 14 XER	4cyl.	1398cc	74kW (101PS)	Petrol	Turbo Intercooled	TD23855
ADAM 1.4			10/12→02/19	CORSA D 1.4		12/09→08/14
ASTRA J 1.4			12/09→10/15	MERIVA B MPV 1.4		06/10→03/17
ASTRA J GTC 1.4			10/11→10/15	MERIVA B VAN 1.4 ECOTEC		01/13→03/17



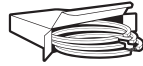

87-429500-30 STD
87-429507-30 0.50mm

A 25.80
 B- 1.60
 C 1.90
 C 3.83
 D 46.80
 TP 18x53



1 Stahl

08-429500-00 STD
08-429507-00 0.50mm

1.20 NT 1
 1.20 P
 2.00 CR 1



1 Acier

1 Acero

1 Acciaio

73.40

10

B 14 XEL	4cyl.	1398cc	64-66kW (87-90PS)	Petrol	TD29663
Z 14 XEP (Ecotec)	4cyl.	1364cc	66kW (90PS)	Petrol	TD17476
ADAM 1.4			10/12→02/19	CORSA 1.4	07/00→12/03
ADAM 1.4 LPG			07/13→11/18	CORSA C 1.4	06/03→06/12
ASTRA G 1.4			09/07→12/09	CORSA D 1.4	07/06→08/14
ASTRA G CLASSIC Caravan 1.4			10/07→07/09	CORSA D 1.4 LPG	08/06→12/11
ASTRA H 1.4			03/04→	CORSA E 1.4	09/14→
ASTRA H 1.4 EcoTec			12/04→12/12	CORSA E 1.4 LPG	03/15→
ASTRA H 1.4 LPG			08/09→10/10	MERIVA A MPV 1.4 16V	07/04→05/10
ASTRA H GTC 1.4			03/05→10/10	MERIVA A MPV 1.4 16V LPG	07/04→05/10
COMBO Body/MPV 1.4 16V			08/05→	TIGRA 1.4	06/04→12/10
COMBO Tour 1.4			10/04→12/11		

87-429500-00 STD 1
87-429507-00 0.50mm 1

A 23.00
 B- 1.25
 BØ 53.50
 C 1.33
 C 1.35
 D 44.00
 TP 18x49



2 Stahl

08-429500-00 STD
08-429507-00 0.50mm

1.20 NT 2
 1.20 P
 2.00 CR 2



2 Acier

2 Acero

2 Acciaio

73.40

11

Z 12 XEP	4cyl.	1229cc	55-59kW (75-80PS)	Petrol	TD18012
AGILA 1.2 16V			07/04→12/07	CORSA D 1.2	07/06→08/14
ASTRA H 1.2			08/05→10/10	CORSA D 1.2 LPG	08/06→08/14
CORSA C 1.2			07/04→12/09		

87-429500-10 STD 1
87-429507-10 0.50mm 1

A 24.00
 B+ 0.53
 C 1.46
 C 1.49
 D 45.33
 TP 19x50



2 Stahl

08-429500-00 STD
08-429507-00 0.50mm

1.20 NT 2
 1.20 P
 2.00 CR 2



2 Acier

2 Acero

2 Acciaio

1 Elastoval®
 2 Steel



74.00

12

B 10 XFL (Euro 6)	3cyl.	999cc	66-77kW (90-105PS)	Petrol	Turbo Intercooled	TD29585
B 10 XFT (Euro 6)	3cyl.	999cc	85kW (115PS)	Petrol	Turbo Intercooled	TD29586
D 10 XFL (Euro 6)	3cyl.	999cc	66-77kW (90-105PS)	Petrol	Turbo Intercooled	TD35612
F 10 XFL (Euro 6)	3cyl.	999cc	66kW (90PS)	Petrol	Turbo Intercooled	TD35613

ADAM 1.0	07/14→11/18	ASTRA K 1.0 Turbo	06/15→
ASTRA K 1.0	05/18→	CORSA E 1.0	09/14→

87-453200-00 STD

87-453207-00 0.50mm

07/14→

08-453200-00 STD

08-453207-00 STD

- A** 27.50
- B-** 2.50
- C** 1.68
- C** 2.81
- D** 46.00

19x47

HA TP



- 1.20 PVD
- 1.20 P
- 2.00 NT

Steel

Stahl

Acier

Acero

Acciaio

75.00

13

13 S	4cyl.	1297cc	42-55kW (57-75PS)	Petrol	TD4725
13 SB	4cyl.	1297cc	51kW (70PS)	Petrol	TD4726
C 13 N	4cyl.	1297cc	44kW (60PS)	Petrol	TD4781

ASCONA B 1.3 S	08/79→08/81	KADETT D 1.3 S	08/79→08/84
ASCONA C 1.3 S	09/81→08/88	KADETT E 1.3	01/85→12/87
CORSA A 1.3	02/86→04/89	KADETT E 1.3 i Cat	09/85→08/91
CORSA A 1.3 i	09/86→09/90	KADETT E 1.3 S	09/84→02/93
CORSA A 1.3 S	09/82→10/89	KADETT E Combo 1.3 S	01/86→12/89
CORSA A TR 1.3	09/85→10/87	MANTA B 1.3 S	08/81→08/86
CORSA A TR 1.3 S	09/82→10/87	MANTA B CC 1.3 S	08/79→08/86
KADETT D 1.3 N	08/79→08/84		

87-306307-00 0.50mm

87-306311-00 1.00mm

- A** 35.80
- B-** 3.60
- C** 5.30
- C** 5.30
- D** 62.40

20x65



08-306300-00 STD

08-306307-00 0.50mm

08-306311-00 1.00mm

- 1.50 CR P
- 1.50 P
- 4.00 CR P

Pistons to be replaced in Engine Sets only Kolben nur in Motorsätzen zu ersetzen Piston à remplacer dans jeu moteur

Pistones de repuesto para juegos de motores solamente

Il pistone può essere rimpiazzato solamente completo

75.00

14

B 16 DT (DV6DTED)	4cyl.	1560cc	68kW (92PS)	Diesel	Turbo Intercooled	TD38726
B 16 DT (DV6FD)	4cyl.	1560cc	73kW (99PS)	Diesel	Turbo Intercooled	TD34740
B 16 DTH (DV6FC)	4cyl.	1560cc	85-88kW (116-120PS)	Diesel	Turbo Intercooled	TD34742

COMBO Body/MPV 1.6 D	06/18→	GRANDLAND / GRANDLAND X 1.6 Turbo D	06/17→
CROSSLAND X / CROSSLAND 1.6 Turbo D	03/17→		



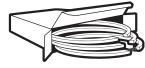

87-453100-00 STD
87-453107-00 0.50mm

A 41.70
B- 13.15
BØ 45.50
D 63.70

AK KK RT TP

08-453100-00 STD
08-453107-00 0.50mm

2.00
 1.95
 2.00

CK
 P
 CR

77.60 **15**

14 NV	4cyl.	1389cc	53-55kW (72-75PS)	Petrol	TD4728
C 14 NZ	4cyl.	1389cc	40-44kW (54-60PS)	Petrol	TD4782
X 14 NZ	4cyl.	1389cc	44kW (60PS)	Petrol	TD14828
X 14 SZ	4cyl.	1389cc	40-44kW (54-60PS)	Petrol	TD8405
ASTRA F 1.4			09/91→09/93	CORSA A TR 1.4 S	09/89→03/93
ASTRA F 1.4 i			09/91→01/05	CORSA B 1.4 i	03/93→09/00
COMBO Body/MPV 1.4			07/94→10/01	KADETT E 1.4 i	01/90→08/91
CORSA 1.4			08/94→07/02	KADETT E 1.4 S	01/90→02/93
CORSA A 1.4 i			01/85→03/93	KADETT E Combo 1.4 i	08/91→07/94
CORSA A 1.4 S			01/90→03/93	KADETT E Combo 1.4 S	07/89→08/91
CORSA A TR 1.4 i			10/89→03/93	VECTRA A 1.4 S	04/88→06/92

87-307100-20 STD
87-307107-20 0.50mm

A 32.10
B- 3.40
D 52.50
 18x55

08-307100-00 STD
08-307107-00 0.50mm

1.50
 1.50
 3.00

CR P
 P
 CR 1

Steel Stahl Acier Acero Acciaio

77.60 **16**

Z 14 XE (Ecotec)	4cyl.	1389cc	66kW (90PS)	Petrol	TD14920
ASTRA G 1.4			09/98→04/05	ASTRA G CLASSIC Caravan 1.4 16V	07/04→09/07
ASTRA G 1.4 16V			02/98→07/09	CORSA 1.4	07/00→12/10
ASTRA G 1.4 LPG			02/98→01/05	CORSA C 1.4	09/00→12/09
ASTRA G CLASSIC 1.4 16V			05/04→07/09		

87-144200-00 STD
87-144207-00 0.50mm

A 31.30
B+ 2.45
D 55.75
 18x55

08-144200-00 STD
08-144207-00 0.50mm

1.20
 1.50
 2.00

NT 1
 P
 CR 1

Steel Stahl Acier Acero Acciaio

79.00 **17**

16 SV	4cyl.	1598cc	60kW (82PS)	Petrol	TD4740
--------------	-------	---------------	--------------------	---------------	---------------





C 16 SE	4cyl.	1598cc	74kW (101PS)	Petrol	TD4787
E 16 SE	4cyl.	1598cc	74-75kW (100-102PS)	Petrol	TD4811
ASCONA C 1.6			09/86→08/88	KADETT E 1.6 i	07/89→02/93
ASTRA F 1.6 i			03/92→12/94	KADETT E 1.6 S	09/86→08/91
ASTRA F 1.6 Si			03/92→12/94	KADETT E Combo 1.6	09/86→12/91
CORSA A 1.6 GSI			05/88→03/92	VECTRA A 1.6	09/88→05/93
CORSA A 1.6 GSI Cat			02/92→03/93	VECTRA A 1.6 S	09/88→05/93
KADETT E 1.6			09/86→08/91	VECTRA B 1.6 GL	09/95→08/96

87-306900-10 STD
87-306907-10 0.50mm

08-306900-00 STD
08-306907-00 0.50mm

A 28.00
B- 1.60
BØ 59.00
B+ 0.40
D 48.40
 18x55



1.20  CR
 1.50  P
 3.00  CR

Steel Stahl Acier Acero Acciaio

79.00 **18**

A 16 LET (Euro 5)	4cyl.	1598cc	132kW (180PS)	Petrol Turbo Intercooled	TD22589
Z 16 LET	4cyl.	1598cc	132kW (180PS)	Petrol Turbo Intercooled	TD19313
ASTRA H 1.6 Turbo			02/07→10/10	CORSA D 1.6 T	02/07→08/14
ASTRA H GTC 1.6 Turbo			02/07→10/10	INSIGNIA A 1.6 Turbo	07/08→03/17
ASTRA J 1.6 Turbo			12/09→	MERIVA A MPV 1.6 Turbo	09/05→05/10
ASTRA J GTC 1.6			10/11→		

87-435500-00 STD
87-435507-00 0.50mm

08-435500-00 STD
08-435507-00 0.50mm

A 27.50
B+ 0.60
D 45.10
 19x53



1.20  NT
 1.20  P
 2.00  NT

HA TP

Steel Stahl Acier Acero Acciaio

79.00 **19**

A 16 XER (Euro 5)	4cyl.	1598cc	84-85kW (114-116PS)	Petrol	TD22587
Z 16 XER	4cyl.	1598cc	85kW (116PS)	Petrol	TD20060
ASTRA H 1.6			12/06→	INSIGNIA A 1.6	07/08→03/17
ASTRA H 1.6 EcoTec			10/06→12/10	MOKKA / MOKKA X 1.6	06/12→
ASTRA H 1.6 LPG			08/09→10/10	ZAFIRA / ZAFIRA FAMILY B 1.6	01/08→04/15
ASTRA H GTC 1.6			12/06→10/10	ZAFIRA / ZAFIRA FAMILY B 1.6Fuel	08/08→12/12
ASTRA J 1.6			12/09→		







87-435300-00 STD
87-435307-00 0.50mm

A 26.70
BØ 52.96
B+ 1.20
C 1.90
C 2.70
D 49.90
 19x46



08-435300-00 STD
08-435307-00 0.50mm

1.20  NT
 1.20  P
 2.00  NT

Steel Stahl Acier Acero Acciaio



 79.00				20	
C 16 NZ	4cyl.	1598cc	55-60kW (75-82PS)	Petrol	TD4785
E 16 NZ	4cyl.	1598cc	55-65kW (75-88PS)	Petrol	TD4810
X 16 SZ	4cyl.	1598cc	52kW (71PS)	Petrol	TD2734
ASCONA C 1.6 i			09/87→08/88	KADETT E 1.6 i Cat	09/86→02/93
ASCONA C 1.6 i Cat			09/86→08/88	KADETT E Combo 1.6 i	08/91→07/94
ASTRA F 1.6 i			09/91→09/98	VECTRA A 1.6	08/88→06/94
CORSA A 1.6 GSI			08/88→09/92	VECTRA A 1.6 i	09/88→11/95
KADETT E 1.6 i			09/86→09/93	VECTRA A 1.6 i Cat	09/88→11/95

87-306900-00 STD
87-306907-00 0.50mm

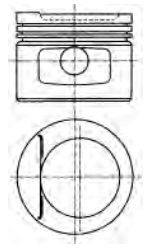
A 28.00
B- 2.70
BØ 63.00
B+ 0.40
D 48.40
 18x55



08-306900-00 STD
08-306907-00 0.50mm

1.20  CR
 1.50  P
 3.00  CR

Steel Stahl Acier Acero Acciaio



 79.00				21	
C 16 XE (Ecotec)	4cyl.	1598cc	80kW (109PS)	Petrol	TD4789
X 16 XE (Ecotec)	4cyl.	1598cc	78kW (106PS)	Petrol	TD2735
X 16 XEL (Ecotec)	4cyl.	1598cc	74kW (101PS)	Petrol	TD4820
ASTRA F 1.6 i 16V			08/94→01/05	TIGRA 1.6 16V	07/94→08/98
ASTRA G 1.6 16V			02/98→01/05	VECTRA B 1.6 i 16V	10/95→07/02
ASTRA G 1.6 LPG			03/98→01/05	ZAFIRA A MPV 1.6 16V	04/99→06/05
CORSA B 1.6 GSI 16V			03/93→09/00	ZAFIRA A MPV 1.6 LPG	04/99→06/05
CORSA B 1.6 i 16V			09/94→09/00		

87-307800-10 STD
87-307807-10 0.50mm

A 28.00
B- 0.80
BØ 60.20
C 1.90
C 2.15
D 48.00
 18x55



08-307800-00 STD
08-307807-00 0.50mm
08-307811-00 1.00mm

1.20  CR
 1.50  P
 2.50  CR

Steel Stahl Acier Acero Acciaio



79.00

22

X 16 SZR	4cyl.	1598cc	55kW (75PS)	Petrol	TD4819
ASTRA F 1.6 i			09/91→01/05	KADETT 1.6	03/95→05/00
ASTRA G 1.6			02/98→09/00	VECTRA B 1.6 i	10/95→07/03
ASTRA G 1.6 LPG			03/98→01/05		

87-306907-20 0.50mm

- A** 28.45
- B-** 2.75
- BØ** 63.00
- D** 48.45
-  18x55



08-306900-00 STD
08-306907-00 0.50mm

- 1.20  CR
- 1.50  P
- 3.00  CR

Steel Stahl Acier Acero Acciaio

79.00

23

Y 16 XE (Ecotec)	4cyl.	1598cc	74kW (101PS)	Petrol	TD13688
Z 16 SE	4cyl.	1598cc	62-69kW (84-94PS)	Petrol	TD15089
Z 16 XE (Ecotec)	4cyl.	1598cc	74-76kW (101-103PS)	Petrol	TD14923
ASTRA G 1.6			09/98→04/05	MERIVA A MPV 1.6	05/03→05/10
ASTRA G 1.6 16V			02/98→01/08	MERIVA A MPV 1.6 16V	05/03→01/06
ASTRA G 1.6 LPG			03/98→04/05	VECTRA B 1.6 i 16V	10/95→07/02
ASTRA G CLASSIC 1.6 16V			05/04→02/06	VECTRA C 1.6 16V	04/02→10/05
ASTRA G CLASSIC Caravan 1.6			06/04→02/06	VECTRA C GTS 1.6	08/05→08/08
COMBO Body/MPV 1.6			10/01→	ZAFIRA A MPV 1.6	10/03→06/05
COMBO Tour 1.6			10/01→09/06	ZAFIRA A MPV 1.6 16V	04/99→06/05
CORSA C 1.6			09/00→12/09	ZAFIRA A MPV 1.6 LPG	04/99→06/05

87-125600-00 STD
87-125607-00 0.50mm

- A** 27.20
- D** 50.20
-  18x55



08-125600-00 STD
08-125607-00 0.50mm

- 1.20  NT
- 1.50  P
- 2.50  CR

Steel Stahl Acier Acero Acciaio

79.00

24

Z 16 XEP	4cyl.	1598cc	74-77kW (101-105PS)	Petrol	TD17892
ASTRA G 1.6			11/02→12/09	ASTRA H GTC 1.6	03/05→10/10
ASTRA G 1.6 16V			03/00→05/05	MERIVA A MPV 1.6	01/06→05/10
ASTRA G 1.6 LPG			06/02→06/07	VECTRA C 1.6	08/05→08/08
ASTRA G CLASSIC 1.6			03/06→06/08	VECTRA C GTS 1.6	01/06→08/08
ASTRA G CLASSIC Caravan 1.6			02/06→07/09	ZAFIRA A MPV 1.6 LPG	10/03→06/05
ASTRA H 1.6			03/04→10/10	ZAFIRA / ZAFIRA FAMILY B 1.6	07/05→09/12
ASTRA H 1.6 EcoTec			02/04→11/04		



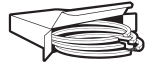





87-427800-00 STD ①
87-427807-00 0.50mm ①

A 26.73
D 48.73
 18x52

TP



08-427800-00 STD
08-427807-00 0.50mm

1.20  NT ②
 1.20  P
 2.00  CR ②

① Elastoval ©
 ② Steel

② Stahl

② Acier

② Acero

② Acciaio

79.00					25
17 D (4EE1)	4cyl.	1686cc	44kW (60PS)	Diesel	TD5284
X 17 D (4EE1)	4cyl.	1686cc	42-44kW (57-60PS)	Diesel	TD5298
COMBO Body/MPV 1.7 D			07/94→10/01	CORSA B 1.7 D	02/96→09/00
CORSA 1.7 D			01/03→12/06		



87-307600-10 STD
 →02/96, →Eng.179157

A 39.75
B- 1.30
C 0.25
D 69.80
 27x64

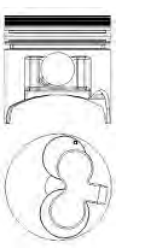
AK RT



08-307600-00 STD
08-307607-00 0.50mm

2.00  CR P
 1.50  CR P
 3.00  CR P

79.00					26
Y 17 DT	4cyl.	1686cc	55kW (75PS)	Diesel Turbo Intercooled	TD13689
Y 17 DTL	4cyl.	1686cc	48kW (65PS)	Diesel Turbo Intercooled	TD14921
ASTRA G 1.7 DTi 16V			02/00→04/05	CORSA 1.7 DTi	08/01→12/10
COMBO Body/MPV 1.7 DI 16V			10/01→	CORSA C 1.7 DI	09/00→12/09
COMBO Body/MPV 1.7 DTi 16V			10/01→	CORSA C 1.7 DI 16V	09/00→07/03
COMBO Tour 1.7 DI 16V			10/01→06/04	CORSA C 1.7 DTi	09/00→12/09
COMBO Tour 1.7 DTi 16V			10/01→06/04	CORSA C 1.7 DTi 16V	09/00→07/03
CORSA 1.7 Di			11/01→06/04	MERIVA A MPV 1.7 DTi	09/03→05/10



87-307600-40 STD
87-307607-40 0.50mm

A 39.75
B- 14.00
BØ 38.70
C 1.10
D 84.00
 27x64

RT



08-307600-00 STD
08-307607-00 0.50mm

2.00  CR P
 1.50  CR P
 3.00  CR P

79.70					27
B 16 DTH	4cyl.	1598cc	81-100kW (110-136PS)	Diesel Turbo Intercooled	TD27815
D 16 DTH	4cyl.	1598cc	99-100kW (135-136PS)	Diesel Turbo Intercooled	TD34985
D 16 DTN	4cyl.	1598cc	81kW (110PS)	Diesel Turbo Intercooled	TD34988
ASTRA J 1.6 CDTi			11/13→	INSIGNIA B CDTi ECOTEC	03/17→





ASTRA J GTC 1.6 CDTi	07/14→	INSIGNIA B Grand 1.6 CDTi	03/17→
ASTRA K 1.6 CDTi	06/15→	MERIVA B MPV 1.6 CDTi	08/13→01/17
ASTRA K 1.6 CDTi	04/18→	MOKKA X VAN 1.6 CDTi	03/18→
INSIGNIA A 1.6 CDTi	07/15→03/17	MOKKA / MOKKA X 1.6 CDTi	01/15→
INSIGNIA B 1.6 CDTi	03/17→	ZAFIRA TOURER C 1.6 CDTi	02/13→

87-430300-00 STD
87-430307-00 STD

- A 45.80
- B- 13.50
- BØ 45.00
- C 1.10
- C 1.00
- D 70.80
- 29x63



AK KK RT TP

08-430300-00 STD
08-430307-00 0.50mm

- 1.50 CK
- 1.50 P
- 2.00 CR



80.00

28

16 D	4cyl.	1598cc	40kW (54PS)	Diesel	TD4734
16 DA	4cyl.	1598cc	40kW (54PS)	Diesel	TD4735
ASCONA C 1.6 D			03/82→08/88	KADETT E 1.6 D	08/84→01/89
KADETT D 1.6 D			03/82→08/84	KADETT E Combo 1.6 D	01/86→12/89

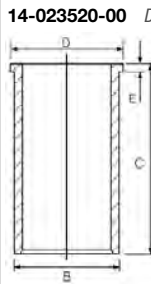

B 83.00 C 143.50 D 84.90 E 4.50

80.00

29

F8Q 600	4cyl.	1870cc	44kW (60PS)	Diesel	TD21361
F8Q 606	4cyl.	1870cc	44kW (60PS)	Diesel	TD21359
ARENA 1.9 D			03/98→08/01		

87-336500-00 STD
87-336507-00 0.50mm

- A 42.35
- B- 0.70
- D 70.50
- 24x63



RT

08-336500-00 STD
08-336505-00 0.25mm
08-336507-00 0.50mm

- 2.00 MO P
- 2.00 P
- 3.00 CR P



80.00

30

F9Q 760	4cyl.	1870cc	74kW (101PS)	Diesel	Turbo Intercooled	TD18872
F9Q 762	4cyl.	1870cc	59-60kW (80-82PS)	Diesel	Turbo Intercooled	TD18494
F9Q 770	4cyl.	1870cc	59kW (80PS)	Diesel	Turbo Intercooled	TD19374
F9Q 772	4cyl.	1870cc	60kW (82PS)	Diesel	Turbo Intercooled	TD23125
F9Q 774	4cyl.	1870cc	60kW (82PS)	Diesel	Turbo Intercooled	TD18252





MOVANO A 1.9 DTI	09/00→	VIVARO A 1.9 DI	08/01→07/06
VIVARO A 1.9 Di	08/01→07/14	VIVARO A 1.9 DTI	02/01→07/14

87-101500-00 STD
87-101507-00 0.50mm

A 47.06
B- 17.80
BØ 38.00
C 0.75
D 77.00
 28x60

AK RT TP



08-101500-00 STD
08-101507-00 0.50mm

2.50
 2.00
 3.00



MO P
 P
 CR P

14-020280-00 D

B 83.00 **C** 155.00 **D** 85.00 **E** 5.00

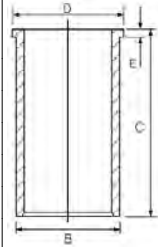

80.00 **31**

R9M 408	4cyl.	1598cc	66-85kW (90-116PS)	Diesel	Turbo Intercooled	TD31564
R9M 413	4cyl.	1598cc	70-89kW (95-121PS)	Diesel	Turbo Intercooled	TD33677
R9M 450	4cyl.	1598cc	85-107kW (116-145PS)	Diesel	Turbo Intercooled	TD31565
R9M 452	4cyl.	1598cc	92-107kW (125-146PS)	Diesel	Turbo Intercooled	TD33678

VIVARO B 1.6 CDTI	06/14→12/19
-------------------	-------------

87-424900-00 STD
87-424907-00 0.50mm

A 46.00
B- 12.35
BØ 46.50
C 0.30
D 70.50
 30x60

AK KK RT TP



08-424900-00 STD
08-424907-00 0.50mm

2.00
 1.75
 2.00



CK P
 P
 CR P

80.50 **32**

X 18 XE1 (Ecotec)	4cyl.	1796cc	85kW (115PS)	Petrol	TD9509
Z 18 XE (Ecotec)	4cyl.	1796cc	90-92kW (122-125PS)	Petrol	TD14922
Z 18 XEL (Ecotec)	4cyl.	1796cc	79-85kW (107-116PS)	Petrol	TD17894

ASTRA G 1.8	02/03→01/04	SIGNUM 1.8	05/03→07/05
ASTRA G 1.8 16V	02/98→10/05	TIGRA 1.8	06/04→12/10
ASTRA H 1.8	01/04→10/10	VECTRA B 1.8 i 16V	10/95→07/03
ASTRA H GTC 1.8	03/05→10/10	VECTRA C 1.8	04/02→07/08
CORSA 1.8	01/02→12/10	VECTRA C 1.8 16V	04/02→09/08
CORSA C 1.8	09/00→12/09	VECTRA C GTS 1.8 16V	08/02→09/08
MERIVA A MPV 1.8	05/03→05/10	ZAFIRA A MPV 1.8 16V	04/99→06/05

87-141200-00 STD
87-141207-00 0.50mm

A 24.10
D 44.70
 18x55



TP







08-141200-00 STD
08-141207-00 0.50mm

1.20
 1.20
 2.00



NT 
 P
 CR 

 Steel  Stahl  Acier  Acero  Acciaio





81.60 **33**

C 18 XE (Ecotec)	4cyl.	1799cc	92kW (125PS)	Petrol	TD4795
C 18 XEL (Ecotec)	4cyl.	1799cc	85kW (116PS)	Petrol	TD4796
X 18 XE (Ecotec)	4cyl.	1799cc	85kW (116PS)	Petrol	TD4823



ASTRA F 1.8 i 16V	06/93→03/01	VECTRA B 1.8 i 16V	10/95→09/00
VECTRA B 1.8Fuel	01/99→09/00		

87-307700-10 STD
87-307707-10 0.50mm

A 30.40
B- 1.80
BØ 50.80
D 50.40
 21x56



08-307700-00 STD
08-307707-00 0.50mm
08-307711-00 1.00mm

1.50  MO P
 1.50  P
 3.00  CR

Steel Stahl Acier Acero Acciaio

81.60 **34**

C 25 XE (Ecotec)	V6cyl.	2498cc	125kW (170PS)	Petrol	TD4804
X 25 XE (Ecotec)	V6cyl.	2498cc	125-144kW (170-196PS)	Petrol	TD2738



CALIBRA A 2.5 i V6	04/93→07/97	VECTRA B 2.5	10/99→06/00
OMEGA B 2.5 V6	03/94→09/00	VECTRA B 2.5 i V6	10/95→09/00
VECTRA A 2.5 CD	08/92→08/95	VECTRA B i 500 2.5	05/98→09/00
VECTRA A 2.5 V6	02/93→11/95		

87-307700-00 STD
87-307707-00 0.50mm

A 30.45
B+ 0.36
C 2.40
D 51.03
 21x56



08-307700-00 STD
08-307707-00 0.50mm
08-307711-00 1.00mm

1.50  MO P
 1.50  P
 3.00  CR

Steel Stahl Acier Acero Acciaio

82.00 **35**

Z 19 DT	4cyl.	1910cc	74-88kW (101-120PS)	Diesel	Turbo Intercooled	TD18046
Z 19 DTL (Euro 4)	4cyl.	1910cc	74kW (101PS)	Diesel	Turbo Intercooled	TD18671

ASTRA H 1.9 CDTI	06/04→12/12	VECTRA C GTS 1.9 CDTI	04/04→01/09
ASTRA H GTC 1.9 CDTI	09/05→10/10	ZAFIRA B Body/MPV 1.9 CDTI VAN	07/05→04/15
SIGNUM 1.9 CDTI	04/04→02/08	ZAFIRA / ZAFIRA FAMILY B 1.9 CDTI	07/05→04/15
VECTRA C 1.9 CDTI	04/04→01/09		



87-124000-30 STD
87-124008-30 0.60mm

A 46.50
B- 17.45
BØ 37.55
C 0.65
D 72.50
 26x61

NB RT



08-124000-00 STD
08-124008-00 0.60mm

2.00  CK P
 2.00  P
 2.00  CR P





82.00 **36**

Z 19 DTH (Euro 4)	4cyl.	1910cc	110kW (150PS)	Diesel	Turbo Intercooled	TD18014
Z 19 DTJ	4cyl.	1910cc	88kW (120PS)	Diesel	Turbo Intercooled	TD18011



ASTRA H 1.9 CDTi	09/05→10/10	SIGNUM 1.9 CDTi	04/04→02/08
ASTRA H 1.9 CDTi	09/04→10/10	VECTRA C 1.9 CDTi	04/04→08/08
ASTRA H 1.9 CDTi 16V	04/04→10/10	VECTRA C GTS 1.9 CDTi	04/04→08/08
ASTRA H GTC 1.9 CDTi	03/05→10/10	ZAFIRA B Body/MPV 1.9 CDTi VAN	07/05→04/15
ASTRA H GTC 1.9 CDTi 16V	03/05→10/10	ZAFIRA / ZAFIRA FAMILY B 1.9 CDTi	07/05→04/15

87-146100-00 STD
87-146108-00 0.60mm

A 46.50
B- 15.40
BØ 41.50
C 1.03
D 72.50
 26x61
 (08256-102)
AK KK NB RT TP



08-146100-00 STD
08-146106-00 0.40mm
08-146108-00 0.60mm



2.00  CK P
 2.00  P
 2.00  CK P

87-146100-10 STD
87-146106-10 0.40mm

A 46.50
B- 15.40
BØ 41.50
C 1.07
C 1.02
D 72.50
 30x67
 (08269-503)
AK KK RT TP



08-146100-00 STD
08-146106-00 0.40mm
08-146108-00 0.60mm

2.00  CK P
 2.00  P
 2.00  CK P

83.00 **37**

A 20 DT (Euro 5)	4cyl.	1956cc	96kW (131PS)	Diesel	Turbo Intercooled	TD25782
A 20 DTC (Euro 5)	4cyl.	1956cc	81kW (110PS)	Diesel	Turbo Intercooled	TD22597
A 20 DTH (Euro 5)	4cyl.	1956cc	96-121kW (131-165PS)	Diesel	Turbo Intercooled	TD22601
A 20 DTJ (Euro 5)	4cyl.	1956cc	96kW (131PS)	Diesel	Turbo Intercooled	TD22599
A 20 DTL (Euro 5)	4cyl.	1956cc	81kW (110PS)	Diesel	Turbo Intercooled	TD25724
Y 20 DTJ	4cyl.	1956cc	96kW (131PS)	Diesel	Turbo Intercooled	TD26542
Z 20 DTJ	4cyl.	1956cc	96kW (131PS)	Diesel	Turbo Intercooled	TD26541



ASTRA J 2.0 CDTi	09/09→10/15	INSIGNIA A 2.0 CDTi	07/08→03/17
ASTRA J 2.0 CDTi	10/12→10/15	INSIGNIA A 2.0 CDTi	07/08→03/17
ASTRA J GTC 2.0 CDTi	10/11→10/15	ZAFIRA TOURER C 2.0 CDTi	10/11→
CASCADA 2.0 CDTi	04/13→06/15	ZAFIRA TOURER C VAN 2.0 CDTi	01/12→



87-436500-00 STD
87-436506-00 0.40mm

A 46.63
B- 15.80
BØ 43.50
D 72.63
 30x66
 (08344A406)
AK KK RT TP



08-436500-00 STD
08-436506-00 0.40mm

1.50  GDC P
 1.50  P
 2.00  CR P



83.00

38

Z 20 DM	4cyl.	1991cc	93kW (126PS)	Diesel	Turbo Intercooled	TD21017
Z 20 DMH	4cyl.	1991cc	110kW (150PS)	Diesel	Turbo Intercooled	TD19203
Z 20 S	4cyl.	1991cc	93-110kW (126-150PS)	Diesel	Turbo Intercooled	TD20856

ANTARA A 2.0 CDTI 07/06→12/11

87-879200-00 STD
87-879207-00 0.50mm

08-879200-00 STD
08-879207-00 0.50mm

- A 46.35
- B- 13.95
- BØ 46.70
- D 72.35
- 28x67



- 2.00 CR P
- 2.00 P
- 3.00 NT

AK KK RT TP

Steel Stahl Acier Acero Acciaio

84.00

39

M9R 630	4cyl.	1995cc	66-84kW (90-114PS)	Diesel	Turbo Intercooled	TD25646
M9R 692 (Euro 5)	4cyl.	1995cc	66-84kW (90-114PS)	Diesel	Turbo Intercooled	TD28089

VIVARO A 2.0 CDTI 01/06→07/14

87-422000-10 STD
87-422007-10 0.50mm

08-422000-00 STD
08-422007-00 0.50mm

- A 48.00
- B- 14.00
- BØ 50.00
- D 76.00
- 32x65



- 2.50 MOL P
- 2.00 MOL P
- 2.00 CR P

KK RT TP

84.00

40

M9R 780 (Euro 4)	4cyl.	1995cc	66-84kW (90-114PS)	Diesel	Turbo Intercooled	TD20888
M9R 782	4cyl.	1995cc	66-84kW (90-114PS)	Diesel	Turbo Intercooled	TD24726
M9R 784	4cyl.	1995cc	84kW (114PS)	Diesel	Turbo Intercooled	TD25140
M9R 786 (Euro 4)	4cyl.	1995cc	66-84kW (90-114PS)	Diesel	Turbo Intercooled	TD25139
M9R 788	4cyl.	1995cc	84kW (114PS)	Diesel	Turbo Intercooled	TD25143

VIVARO A 2.0 CDTI 01/06→07/14

87-422000-00 STD
87-422007-00 0.50mm

08-422000-00 STD
08-422007-00 0.50mm

- A 47.92
- B- 14.90
- BØ 49.07
- C 0.40
- C 0.40
- D 76.00
- 32x65



- 2.50 MOL P
- 2.00 MOL P
- 2.00 CR P

AK KK RT TP

84.00

41

X 20 DTH	4cyl.	1995cc	74kW (101PS)	Diesel	Turbo Intercooled	TD9729
-----------------	-------	---------------	---------------------	---------------	--------------------------	---------------

OMEGA B 2.0 DTI 16V 09/97→09/00 VECTRA B 2.0 DTI 16V 06/97→07/03





87-102900-10 STD

- A 45.80
- B- 14.61
- BØ 41.00
- D 70.80
- 29x68



AK RT TP

08-102900-00 STD

08-102907-00 0.50mm

- 2.50 CK P
- 1.75 P
- 3.00 CR P

84.00 **42**

X 20 DTL	4cyl.	1995cc	60-63kW (82-86PS)	Diesel	Turbo Intercooled	TD4824
Y 20 DTL	4cyl.	1995cc	60-63kW (82-86PS)	Diesel	Turbo Intercooled	TD15848
ASTRA G 2.0 DI		02/98→04/05		ZAFIRA A MPV 2.0 DI 16V		07/99→06/05
VECTRA B 2.0 DI 16V		11/96→04/02				

87-102800-10 STD

87-102807-10 0.50mm

- A 45.80
- B- 14.84
- BØ 41.00
- C 1.00
- D 70.80
- 29x68



AK RT TP

08-102800-00 STD

08-102807-00 0.50mm

- 2.00 CK P
- 1.75 P
- 3.00 CR P

14-102800-00 D

B 87.00 C 160.00 D 90.00 E 4.50

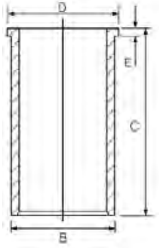

84.00 **43**

X 22 DTH	4cyl.	2171cc	85kW (116PS)	Diesel	Turbo Intercooled	TD9510
Y 22 DTH	4cyl.	2172cc	81-88kW (110-120PS)	Diesel	Turbo Intercooled	TD15091
Y 22 DTR	4cyl.	2172cc	86-92kW (117-125PS)	Diesel	Turbo Intercooled	TD14924
ASTRA G 2.2 DTI		09/02→10/05		VECTRA B 2.2 DTI 16V		09/00→07/03
FRONTERA B 2.2 DTI		09/98→07/04		VECTRA C 2.2 DTI		10/03→12/05
OMEGA B 2.2 DTI 16V		09/00→07/03		VECTRA C 2.2 DTI 16V		04/02→12/04
SIGNUM 2.2 DTI		05/03→04/04		VECTRA C GTS 2.2 DTI 16V		08/02→06/08
SINTRA 2.2 DTI		07/97→04/99		ZAFIRA A MPV 2.2 DTI 16V		01/02→06/05

87-126000-10 STD

87-126007-10 0.50mm

- A 45.80
- B- 14.67
- BØ 43.00
- C 1.05
- D 70.80
- 29x68



AK KK RT TP

08-126000-00 STD

08-126007-00 0.50mm

- 1.75 CK P
- 1.75 P
- 3.00 CR P

84.00 **44**

Y 20 DTH	4cyl.	1995cc	74kW (101PS)	Diesel	Turbo Intercooled	TD13752
ASTRA G 2.0 DTI		09/00→04/05		VECTRA C 2.0 DTI		10/03→08/05
ASTRA G 2.0 DTI 16V		08/99→01/05		VECTRA C 2.0 DTI 16V		04/02→08/06
SIGNUM 2.0 DTI		05/03→04/04		VECTRA C GTS 2.0 DTI 16V		08/02→08/05
VECTRA B 2.0 DTI 16V		06/97→07/03		ZAFIRA A MPV 2.0 DTI 16V		09/00→06/05





87-126000-00 STD
87-126007-00 0.50mm

A 45.85
B- 14.68
BØ 41.00
C 1.05
D 70.80
 29x68



AK KK RT TP

08-126000-00 STD
08-126007-00 0.50mm

1.75  CK P
 1.75  P
 3.00  CR P

84.80

45

18 SE	4cyl.	1796cc	82-85kW (112-116PS)	Petrol	TD4753
18 SEH	4cyl.	1796cc	85kW (115PS)	Petrol	TD4754
18 SV	4cyl.	1796cc	63-66kW (86-90PS)	Petrol	TD4755
ASTRA F 1.8			11/91→07/93	OMEGA A 1.8 N	11/86→09/88
ASTRA F 1.8 i 16V			09/95→09/96	OMEGA A 1.8 S	09/86→03/94
KADETT E 1.8			08/85→08/91	VECTRA A 1.8 i	09/88→10/90
KADETT E 1.8 i			09/84→05/92	VECTRA A 1.8 S	09/88→10/90
OMEGA A 1.8			09/86→03/94		

87-307200-00 STD

A 33.65
B- 4.00
BØ 43.00
D 53.65
 21x62



08-307200-00 STD
08-307207-00 0.50mm

1.50  CR P
 1.50  P
 3.00  CR 

 Steel

 Stahl

 Acier

 Acero

 Acciaio

85.00

46

M9T 670 (Euro 5)	4cyl.	2298cc	74-92kW (101-125PS)	Diesel	Turbo Intercooled	TD25055
M9T 672 (Euro 5)	4cyl.	2298cc	74-92kW (101-125PS)	Diesel	Turbo Intercooled	TD25226
M9T 676 (Euro 4)	4cyl.	2298cc	74-92kW (101-125PS)	Diesel	Turbo Intercooled	TD25056
M9T 678	4cyl.	2298cc	107kW (146PS)	Diesel	Turbo Intercooled	TD25157
M9T 680	4cyl.	2298cc	92-107kW (125-146PS)	Diesel	Turbo Intercooled	TD25137
M9T 686 (Euro 5)	4cyl.	2298cc	92kW (125PS)	Diesel	Turbo Intercooled	TD25231
M9T 690 (Euro 5)	4cyl.	2298cc	74-92kW (101-125PS)	Diesel	Turbo Intercooled	TD25230
M9T 692 (Euro 4)	4cyl.	2298cc	74-92kW (101-125PS)	Diesel	Turbo Intercooled	TD25224
M9T 694 (Euro 4)	4cyl.	2298cc	107-110kW (146-150PS)	Diesel	Turbo Intercooled	TD25058
M9T 696 (Euro 4)	4cyl.	2298cc	92-110kW (125-150PS)	Diesel	Turbo Intercooled	TD25225
M9T 698 (Euro 5)	4cyl.	2298cc	92-110kW (125-150PS)	Diesel	Turbo Intercooled	TD25057
M9T 702	4cyl.	2298cc	100-120kW (136-163PS)	Diesel	Bi-Turbo/Intercooler	TD29658
M9T 870	4cyl.	2298cc	74-92kW (101-125PS)	Diesel	Turbo Intercooled	TD29657
M9T 876	4cyl.	2298cc	74-92kW (101-125PS)	Diesel	Turbo Intercooled	TD31130
M9T 880	4cyl.	2298cc	92-110kW (125-150PS)	Diesel	Turbo Intercooled	TD28582
M9T 896	4cyl.	2298cc	92-110kW (125-150PS)	Diesel	Turbo Intercooled	TD28580
M9T 898	4cyl.	2298cc	92-110kW (125-150PS)	Diesel	Turbo Intercooled	TD28581

MOVANO B 2.3 CDTI

05/10→

MOVANO B 2.3 CDTI RWD

05/10→



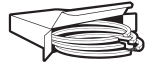

87-435200-00 STD
87-435207-00 0.50mm

- A** 48.00
- B-** 16.20
- BØ** 50.00
- C** 0.45
- D** 76.00
- 32x65



AK KK RT TP

08-435200-00 STD
08-435207-00 0.50mm

- 2.50 GDC P
- 2.00 MO P
- 2.00 CR P



86.00 **47**

20 NE	4cyl.	1998cc	85-95kW (115-129PS)	Petrol	TD4759
C 20 NE	4cyl.	1998cc	85kW (116PS)	Petrol	TD4799
ASCONA C 2.0 i			09/86→08/88	KADETT E 2.0 i	10/86→02/93
ASCONA C 2.0 i Cat			09/86→08/88	KADETT E 2.0 i Cat	10/86→02/93
ASTRA F 2.0 i			09/91→09/98	OMEGA A 2.0	09/87→04/94
CALIBRA A 2.0 i			08/89→07/97	OMEGA A 2.0 i	09/86→04/94
FRONTERA A 2.0 i			03/92→10/98	REKORD E 2.0	12/83→12/91
KADETT 2.0 i			09/94→05/00	VECTRA A 2.0 i	09/88→10/90
KADETT E 2.0			01/86→12/93	VECTRA A 2.0 i Cat	09/88→11/95
KADETT E 2.0 GSI			09/86→08/91	VECTRA B 2.0 i	09/95→04/02
KADETT E 2.0 GSI Cat			09/86→08/91		

87-306800-30 STD

- A** 30.40
- B-** 5.00
- BØ** 57.00
- D** 50.40
- 21x62



TP

08-306800-00 STD
08-306807-00 0.50mm
08-306811-00 1.00mm

- 1.50 CR P
- 1.50 P
- 3.00 CR

Steel Stahl Acier Acero Acciaio

86.00 **48**

20 XE	4cyl.	1998cc	115kW (156PS)	Petrol	TD4765
C 20 XE	4cyl.	1998cc	110kW (150PS)	Petrol	TD4801
ASTRA F 2.0 GSI 16V			09/91→01/98	KADETT E 2.0 GSI 16V	12/87→08/91
ASTRA F 2.0 i 16V			03/93→01/98	KADETT E 2.0 GSI 16V Cat	03/88→08/91
CALIBRA A 2.0 i 16V			06/90→02/94	VECTRA A 2.0	08/89→08/95
KADETT E 2.0			09/90→05/92	VECTRA A 2.0 i 16V Cat	02/90→11/95
KADETT E 2.0 GSi			09/90→05/92	VECTRA A 2000/GT 16V Cat	02/90→11/95

87-306800-10 STD
87-306807-10 0.50mm

- A** 30.43
- B-** 0.85
- BØ** 70.00
- C** 2.20
- D** 55.43
- 21x62



08-306800-00 STD
08-306807-00 0.50mm
08-306811-00 1.00mm

- 1.50 CR P
- 1.50 P
- 3.00 CR

Steel Stahl Acier Acero Acciaio



86.00 **49**

Z 22 SE (Ecotec)	4cyl.	2198cc	108kW (147PS)	Petrol	TD14668
ASTRA G 2.2 16V			06/00→10/05	VECTRA C 2.2 16V	04/02→12/08
SPEEDSTER 2.2			06/00→08/05	VECTRA C GTS 2.2 16V	08/02→08/08
VECTRA B 2.2 i 16V			09/00→07/03	ZAFIRA A MPV 2.2 16V	09/00→06/05

14-020450-00 D **B 89.02 C 137.25 D 95.45 E 4.63**

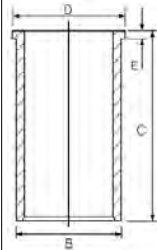

87.00 **50**

G9T 720	4cyl.	2188cc	66kW (90PS)	Diesel	Turbo Intercooled	TD18875
G9T 722	4cyl.	2188cc	66kW (90PS)	Diesel	Turbo Intercooled	TD21397
G9T 750	4cyl.	2188cc	66kW (90PS)	Diesel	Turbo Intercooled	TD23885
MOVANO A 2.2 DTI			09/00→			

87-127400-00 STD
87-127407-00 0.50mm

08-127400-00 STD
08-127407-00 0.50mm

- A** 54.53
- B-** 17.50
- BØ** 40.40
- C** 2.00
- D** 84.20
- 31x65



- 3.00 PS P
- 1.75 P
- 2.50 P

AK RT TP

88.00 **51**

21 D	4cyl.	2068cc	44kW (60PS)	Diesel	TD2658
REKORD D 2.1 D			09/72→08/77	REKORD E 2.1 D	09/77→07/78

14-024160-00 D **B 92.00 C 172.00 D 93.90 E 4.55**

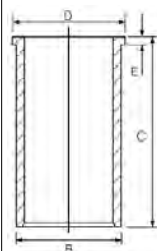

88.00 **52**

C 223	4cyl.	2238cc	39-54kW (53-73PS)	Diesel	TD22878
CAMPO 2.2 D			08/87→08/90		



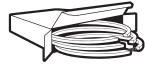

14-021190-00 D

B 92.13 C 163.50 D 95.00 E 4.00

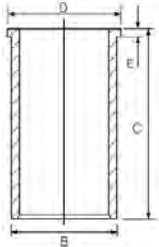

89.00							53
G9U 632 (Euro 4)	4cyl.	2464cc	88-107kW (120-146PS)	Diesel	Turbo Intercooled	TD21014	
G9U 650 (Euro 4)	4cyl.	2464cc	74-107kW (101-146PS)	Diesel	Turbo Intercooled	TD21012	
MOVANO A 2.5 CDTI	10/03→						

87-137500-30 STD
87-137507-30 0.50mm

A 53.07
B- 16.10
B- 4.90
BØ 48.00
C 2.00
C 1.60
D 83.09
31x65

AK RT TP

08-137500-00 STD
08-137507-00 0.50mm

3.00 M0 P
1.75 P
2.50 P

89.00							54
G9U 720 (Euro 3)	4cyl.	2464cc	84-85kW (114-116PS)	Diesel	Turbo Intercooled	TD18874	
G9U 724 (Euro 3)	4cyl.	2464cc	84kW (115PS)	Diesel	Turbo Intercooled	TD19367	
G9U 730 (Euro 3)	4cyl.	2464cc	99kW (135PS)	Diesel	Turbo Intercooled	TD18497	
G9U 750	4cyl.	2464cc	84kW (115PS)	Diesel	Turbo Intercooled	TD23887	
G9U 754 (Euro 3)	4cyl.	2464cc	73-84kW (99-115PS)	Diesel	Turbo Intercooled	TD19817	
MOVANO A 2.5 DTI	10/01→		VIVARO A 2.5 DTi		04/03→03/10		
MOVANO A 2.5 DTI	10/03→		VIVARO A 2.5 DTI		04/03→03/10		

87-137500-10 STD
87-137507-10 0.50mm

A 53.03
B- 17.85
BØ 43.20
C 1.65
C 1.90
D 83.09
31x65

AK RT TP

08-137500-10 STD
08-137507-10 0.50mm

2.50 M0 P
1.75 P
2.50 CR P

92.00							55
23 D	4cyl.	2260cc	46-63kW (63-86PS)	Diesel		TD2663	
23 DTR	4cyl.	2260cc	74kW (100PS)	Diesel	Turbo Intercooled	TD4767	
23 TD	4cyl.	2260cc	63kW (86PS)	Diesel	Turbo	TD2665	
23 YD	4cyl.	2260cc	54kW (73PS)	Diesel		TD4768	





23 YDT	4cyl.	2260cc	66kW (90PS)	Diesel	Turbo	TD4769
FRONTERA A 2.3 TD			03/92→10/98	REKORD E 2.2 TD		06/84→08/86
OMEGA A 2.3 D			09/86→03/94	REKORD E 2.3 D		11/82→08/86
OMEGA A 2.3 TD			09/86→03/94	SENATOR A 2.2 TD		11/84→08/87
REKORD E 2.2 D			08/78→08/86			

14-024100-00 D B 95.00 C 172.00 D 97.00 E 4.70

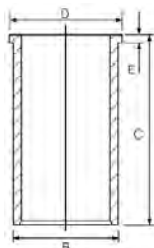

92.00 **56**

25 TDS (VM41B)	4cyl.	2499cc	85kW (115PS)	Diesel	Turbo Intercooled	TD2673
FRONTERA A 2.5 TDS			09/96→10/98			

15-676420-00 WH ① B 101.50 C 166.80 D 110.00 E 8.90 F 1.20
 14-676420-00 WH B 101.50 C 166.80 D 110.00 E 8.90 F 1.20

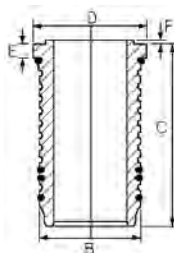

① Includes seals ① Schließt Dichtungen ein ① Inclut des joints ① Incluye los sellos ① Comprende le guarnizioni

93.00 **57**

S8U 758	4cyl.	2500cc	55-58kW (75-79PS)	Diesel		TD22880
S8U 780	4cyl.	2500cc	55kW (75PS)	Diesel		TD22882
S8U 782	4cyl.	2500cc	55kW (75PS)	Diesel		TD24143
ARENA 2.5 D			03/98→08/01			

14-022560-00 D B 96.00 C 167.30 D 98.90 E 5.00
 14-028930-00 D B 97.50 C 167.00 D 100.90 E 5.00
 14-028931-00 D B 97.58 C 167.00 D 100.90 E 5.00
 14-028932-00 D B 97.70 C 167.00 D 100.90 E 5.00

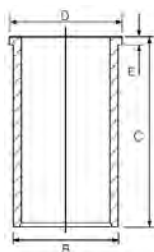

94.40 **58**

8140.23.2585/3700 (Sofim)	4cyl.	2800cc	84kW (114PS)	Diesel	Turbo Intercooled	MP9256
8140.43.2585/3700/3900 (Sofim)	4cyl.	2800cc	84kW (114PS)	Diesel	Turbo Intercooled	MP9256-1
S9W 700	4cyl.	2800cc	84kW (114PS)	Diesel	Turbo Intercooled	TD21149
S9W 702	4cyl.	2800cc	84kW (114PS)	Diesel	Turbo Intercooled	TD19360





MOVANO 2.8D	01/99 →	MOVANO A 2.8 DTI	07/98 →10/01
--------------------	---------	-------------------------	--------------

87-854700-00 *STD*
87-854708-00 *0.60mm*
 →Eng.2572279

A 58.75
B- 19.40
BØ 39.40
D 96.65
 32x78

AK KK RT

08-854700-00 *STD*
08-854708-00 *0.60mm*

3.00 CR
 2.00 P
 3.00 CR

14-021321-00 *D* **B** 97.54 **C** 167.00 **D** 100.90 **E** 5.00
14-028930-00 *D* **B** 97.50 **C** 167.00 **D** 100.90 **E** 5.00
14-028931-00 *D* **B** 97.58 **C** 167.00 **D** 100.90 **E** 5.00
14-028932-00 *D* **B** 97.70 **C** 167.00 **D** 100.90 **E** 5.00

87-122200-10 *STD*
87-122208-10 *0.60mm*
 Eng.2572280 →

A 58.75
B- 19.40
BØ 39.25
D 87.60
 32x72

AK KK RT TP

08-122200-00 *STD*
08-122208-00 *0.60mm*

2.50 CK P
 2.00 P
 2.50 CR P



CCM



9

3.152	Diesel	2490	3	91.44	4
4.107	Diesel	1760	4	79.38	1
4.108	Diesel	1760	4	79.38	2
4.165	Diesel	2710	4	92.00	7
4.192	Diesel	3150	4	88.90	3
4.203	Diesel	3335	4	91.44	5
4.212	Diesel	3475	4	98.43	8
4.236	Diesel	3864	4	98.43	8
4.248 / A4.248	Diesel	4065	4	100.96	17
6.288	Diesel	4730	6	88.90	3
6.305	Diesel	5000	6	91.44	6
6.354	Diesel	5794	6	98.43	10
6.354 V	Diesel	5794	6	98.43	8
6.372	Diesel	6100	6	100.96	18
1004-40	Diesel	3990	4	100.00	12
1004-42 (Euro 1)	Diesel	4230	4	103.00	19
1006-60	Diesel	5984	6	100.00	12
1103A-33	Diesel	3299	3	105.00	20
1103A-33T	Diesel	3299	3	105.00	21
1103B-33 (Euro 2)	Diesel	3299	3	105.00	20
1103B-33T	Diesel	3299	3	105.00	21
1103C-33 (Euro 2)	Diesel	3299	3	105.00	20
1103C-33T	Diesel	3299	3	105.00	21
1103C-33TA	Diesel	3299	3	105.00	21
1103D-33	Diesel	3299	3	105.00	20
1104A-44	Diesel	4399	4	105.00	20
1104A-44T	Diesel	4399	4	105.00	21
1104A-44TA	Diesel	4399	4	105.00	21
1104C-44 (Euro 2)	Diesel	4399	4	105.00	20
1104C-44T	Diesel	4399	4	105.00	21
1104C-E44	Diesel	4399	4	105.00	20
1104C-E44T	Diesel	4399	4	105.00	21
1104C-E44TA	Diesel	4399	4	105.00	21
6.354.1	Diesel	5800	6	98.43	10
6.354.2	Diesel	5794	6	98.43	8
6.354.4	Diesel	5794	6	98.43	10
AD3.152	Diesel	2499	3	91.44	5
AT4.236	Diesel	3866	4	98.43	9
C4.40 (1004-4TW)	Diesel	3990	4	100.00	13
D3.152	Diesel	2500	3	91.44	5
PHASER 90 (1004-4)	Diesel	3990	4	100.00	14
PHASER 110 T (1004-4T)	Diesel	3990	4	100.00	13
PHASER 125 (1006-6)	Diesel	5985	6	100.00	14
PHASER 160/180T	Diesel	5985	6	100.00	15
PHASER 160T (1006-6T)	Diesel	5985	6	100.00	13
PHASER 180TI (1006-6TW)	Diesel	5985	6	100.00	13
PHASER 180TI (Euro 2 CC6.60)	Diesel	5985	6	100.00	13
PHASER 200TI (Euro 1)	Diesel	5985	6	100.00	16
PHASER 1004-42 (Euro 1)	Diesel	3990	4	103.00	19
T4.236	Diesel	3864	4	98.43	9
T6.3544	Diesel	5794	6	98.43	11
T6.60	Diesel	5985	6	100.00	16
T6.354.1	Diesel	5800	6	98.43	8
T6.354.3	Diesel	5800	6	98.43	8
T6.354.3 CC	Diesel	5800	6	98.43	8

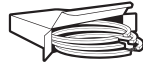

79.38 **1**

4.107 4cyl. 1760cc 30kW (41PS) Diesel TD6333

15-370040-00 WH ① B 85.67 C 163.53 D 93.70 E 6.40

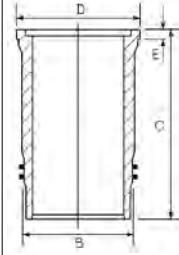

① Includes seals ① Schließt Dichtungen ein ① Inclut des joints ① Incluye los sellos ① Comprende le guarnizioni

79.38 **2**

4.108 4cyl. 1760cc 36-42kW (49-57PS) Diesel TD6334

F-Serie 04/74→12/85

14-010900-00 D B 82.63 C 165.10

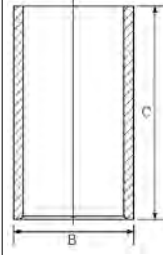

88.90 **3**

4.192 4cyl. 3150cc 29-37kW (39-50PS) Diesel TD6396

6.288 6cyl. 4730cc 45kW (61PS) Diesel TD6498

14-021240-00 D B 93.71 C 216.03 D 94.41 E 4.76

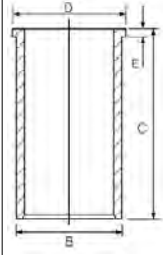

91.44 **4**

3.152 3cyl. 2490cc 22-33kW (30-45PS) Diesel TD6788

87-314600-00 STD ①

A 57.20
D 107.70
32x75



08-314600-00 STD ②

2.38 CR P
2.38 P
3.16 P
6.33 P
6.33 P



14-021220-00 D ④ B 93.71 C 216.00 D 96.72 E 3.81
14-021221-00 D B 93.96 C 216.00 D 96.72 E 3.81
14-024680-00 D B 93.73 C 216.00 D 96.72 E 3.76
14-025833-00 D B 95.31 C 216.00 D 98.16 E 5.00
14-025871-00 D B 93.76 C 216.14 D 96.85 E 5.00
14-025873-00 D B 93.88 C 216.14 D 96.97 E 5.00
14-480320-00 DH ④ B 93.66 C 216.03 D 96.72 E 3.81

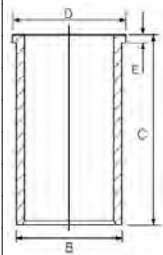



87-525100-10 STD ③

A 56.95
D 107.70
32x75



08-525100-00 STD

2.38 P
2.38 P
3.16 P
6.35
6.35



① Topping allowance piston which requires machining to conform to engine manufacturers recommendations

② Not for chromed cylinders

③ Pre-topped piston which may require machining

④ Press fit cast iron liner to replace original steel liner

① Nicht vorgeschliffener Kolben, der etwas Bearbeitung benötigt, um den Empfehlungen des Herstellers zu entsprechen

② Nicht für verchromte Zylinder

③ Vorgeschliffener Kolben, der möglicherweise gemäß den Empfehlungen des Herstellers bearbeitet werden muss

④ Anpressbare Laubbuchse aus Gusseisen als Ersatz der original Stahlbüchse

① Piston à tête avec surépaisseur nécessitant un usinage pourmise en conformité avec les recommandations du constructeur.

② Non appropriés pour cylindres chromés

③ Piston à tête semie finie pour ant nécessiter un usinage pou aux recommandations du constructeur.

④ Chemise fonte à emmancher à la presse pour remplacer la che mise d'origine en acier

① Pistón con margen para corona que requiere fresado para ajustarse a las recomendaciones del fabricante del motor

② No se usan para cilindros cromados

③ Pistón coronado que puede necesitar fresado para ajustarse a del fabricante.

④ Ajuste a presión la camisa de hierro fundido para reemplazar la camisa original de acero

① La superficie superiore della testa può essere lavorata peradattare l'altezza del pistone al pms.Fare riferimento allanorme di montaggio

② Non per cilindri cromati

③ Il pistone a testa ribassata puo' richiedere una lavorazione adattaralle prescrizioni del costruttore. fare riferiment alle istruzioni contenute nella confezione.

④ Canna in ghisa per sostituire canne originali in acciaio

91.44

5

4.203	4cyl.	3335cc	44kW (60PS)	Diesel	TD7381
AD3.152	3cyl.	2499cc		Diesel	MP11352-1
D3.152	3cyl.	2500cc		Diesel	MP1352

INDUSTRIAL

87-314600-10 STD

A 62.00
B- 18.55
D 109.60
32x75



08-314600-00 STD ①

2.38 CR P
2.38 P
3.16 P
6.33 P
6.33 P



14-021220-00 D ③ **B** 93.71 **C** 216.00 **D** 96.72 **E** 3.81
14-021221-00 D **B** 93.96 **C** 216.00 **D** 96.72 **E** 3.81
14-024680-00 D **B** 93.73 **C** 216.00 **D** 96.72 **E** 3.76
14-025833-00 D **B** 95.31 **C** 216.00 **D** 98.16 **E** 5.00
14-025871-00 D **B** 93.76 **C** 216.14 **D** 96.85 **E** 5.00
14-025873-00 D **B** 93.88 **C** 216.14 **D** 96.97 **E** 5.00
14-480320-00 DH ③ **B** 93.66 **C** 216.03 **D** 96.72 **E** 3.81

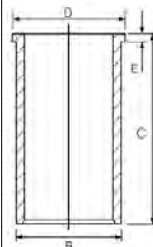

87-322000-00 STD ②

A 61.62
B- 18.70
BØ 55.00
D 109.24
32x75



08-322000-00 STD ①

2.38 CR P
2.38 P
2.38 P
4.74 CR P





87-525100-00 STD

- A** 61.90
- B-** 18.57
- BØ** 55.20
- D** 109.50
- 32x75



08-525100-00 STD

- 2.38 P
- 2.38 P
- 3.16 P
- 6.35
- 6.35

- 1 Not for chromed cylinders
- 2 Pre-topped piston which may require machining
- 3 Press fit cast iron liner to replace original steel liner

- 1 Nicht für verchromte Zylinder
- 2 Vorgeschliffener Kolben, der möglicherweise gemäß den Empfehlungen des Herstellers bearbeitet werden muss
- 3 Anpressbare Laufbuchse aus Gusseisen als Ersatz der original Stahlbüchse

- 1 Non appropriés pour cylindres chromés
- 2 Piston à tête semie finie pour nécessiter un usinage pour aux recommandations du constructeur.
- 3 Chemise fonte à emmancher à la presse pour remplacer la che mise d'origine en acier

- 1 No se usan para cilindros cromados
- 2 Pistón coronado que puede necesitar fresado para ajustarse a del fabricante.
- 3 Ajuste a presión la camisa de hierro fundido para reemplazar la camisa original de acero

- 1 Non per cilindri cromati
- 2 Il pistone a testa ribassata puo' richiedere una lavorazione adattarlo alle prescrizioni del costruttore. fare riferiment alle istruzioni contenute nella confezione.
- 3 Canna in ghisa per sostituire canne originali in acciaio

91.44

6

6.305 6cyl. **5000cc** **73kW (100PS)** **Diesel** **TD6399**

- 14-021220-00** *D* 1 **B 93.71 C 216.00 D 96.72 E 3.81**
- 14-021221-00** *D* **B 93.96 C 216.00 D 96.72 E 3.81**
- 14-024680-00** *D* **B 93.73 C 216.00 D 96.72 E 3.76**
- 14-025833-00** *D* **B 95.31 C 216.00 D 98.16 E 5.00**
- 14-025871-00** *D* **B 93.76 C 216.14 D 96.85 E 5.00**
- 14-025873-00** *D* **B 93.88 C 216.14 D 96.97 E 5.00**
- 14-480320-00** *DH* 1 **B 93.66 C 216.03 D 96.72 E 3.81**

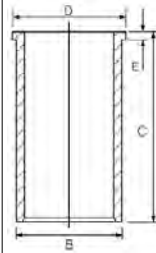

- 1 Press fit cast iron liner to replace original steel liner
- 1 Anpressbare Laufbuchse aus Gusseisen als Ersatz der original Stahlbüchse
- 1 Chemise fonte à emmancher à la presse pour remplacer la che mise d'origine en acier
- 1 Ajuste a presión la camisa de hierro fundido para reemplazar la camisa original de acero
- 1 Canna in ghisa per sostituire canne originali in acciaio

92.00

7

4.165 4cyl. **2710cc** **47-51kW (65-70PS)** **Diesel** **TD6734**

F-Serie 04/76→12/85 L-Serie 05/82→12/85

- 14-043450-00** *D* **B 96.91 C 191.19 D 101.00 E 3.91 F 0.70**

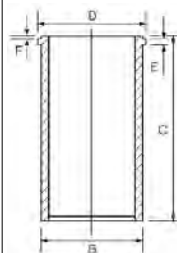

98.43

8

4.212	4cyl.	3475cc	44-47kW (60-64PS)	Diesel	TD29147
4.236	4cyl.	3864cc	55-65kW (75-88PS)	Diesel	TD6398
6.354.2	6cyl.	5794cc	84-87kW (114-118PS)	Diesel	TD6548
6.354 V	6cyl.	5794cc	71-87kW (97-118PS)	Diesel	TD7158





T6.354.1	6cyl.	5800cc		Diesel	Turbo	MP1363
T6.354.3	6cyl.	5800cc		Diesel	Turbo	MP1366
T6.354.3 CC	6cyl.	5800cc	110-111kW (148-151PS)	Diesel	Turbo	TD6747
DELIVERY	01/82→10/86		L-Serie		05/82→12/85	
INDUSTRIAL						

14-040200-00 DH ① **B 103.19 C 227.28 D 106.45 E 3.86 F 0.88**
14-045820-00 D **B 103.33 C 227.28 D 106.42 E 3.80 F 0.90**
14-045821-00 D **B 103.83 C 227.28 D 106.42 E 3.80 F 0.90**

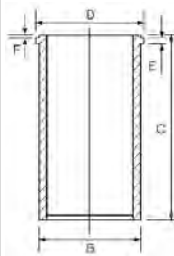

① Press fit cast iron liner to replace original steel liner
 ① Anpressbare Laufbuchse aus Gusseisen als Ersatz der original Stahlbüchse
 ① Chemise fonte à emmancher à la presse pour remplacer la che mise d'origine en acier
 ① Ajuste a presión la camisa de hierro fundido para reemplazar la camisa original de acero
 ① Canna in ghisa per sostituire canne originali in acciaio

98.43						9
AT4.236	4cyl.	3866cc		Diesel	Turbo	MP13911
T4.236	4cyl.	3864cc	66-76kW (90-103PS)	Diesel	Turbo	TD6746
DELIVERY	01/82→12/86		INDUSTRIAL			

87-319000-10 STD

A 70.25
B- 19.95
BØ 60.90
D 108.25
 **38x83**



RT TP



08-319000-30 STD
08-319000-30 STD

3.16 CK P
 2.38 P
 4.74 CR P



14-040200-00 DH ① **B 103.19 C 227.28 D 106.45 E 3.86 F 0.88**
14-045820-00 D **B 103.33 C 227.28 D 106.42 E 3.80 F 0.90**
14-045821-00 D **B 103.83 C 227.28 D 106.42 E 3.80 F 0.90**

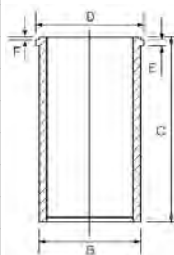

① Press fit cast iron liner to replace original steel liner
 ① Anpressbare Laufbuchse aus Gusseisen als Ersatz der original Stahlbüchse
 ① Chemise fonte à emmancher à la presse pour remplacer la che mise d'origine en acier
 ① Ajuste a presión la camisa de hierro fundido para reemplazar la camisa original de acero
 ① Canna in ghisa per sostituire canne originali in acciaio

98.43						10
6.354	6cyl.	5794cc	71-82kW (97-112PS)	Diesel		TD6713
6.354.1	6cyl.	5800cc		Diesel		MP5218
6.354.4	6cyl.	5794cc	94kW (128PS)	Diesel		TD6546
INDUSTRIAL						





87-525200-00 STD ① ② ③

A 69.91
B- 25.61
BØ 53.90
D 120.71
 35x84



08-525200-00 STD

2.38 CR P
 2.38 P
 2.38 P
 6.35 P
 6.35 P

14-040200-00 DH ④
14-045820-00 D
14-045821-00 D

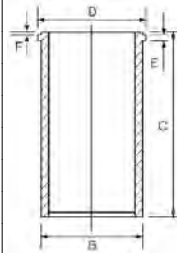

B 103.19 **C** 227.28 **D** 106.45 **E** 3.86 **F** 0.88
B 103.33 **C** 227.28 **D** 106.42 **E** 3.80 **F** 0.90
B 103.83 **C** 227.28 **D** 106.42 **E** 3.80 **F** 0.90

- ① Pre-topped piston which may require machining
- ② For Cast Iron Bores only
- ③ Recommended maximum oversize is .040in/1.016mm
- ④ Press fit cast iron liner to replace original steel liner

- ① Vorgeschliffener Kolben, der möglicherweise gemäß den Empfehlungen des Herstellers bearbeitet werden muss
- ② Nur für Gußeisenbohrungen
- ③ Empfohlenes Übermaß max .040in/1.016mm
- ④ Anpressbare Laufbuchse aus Gusseisen als Ersatz der original Stahlbüchse

- ① Piston à tête semie finie pour ant nécessiter un usinage pou aux recommandations du constructeur.
- ② Pour intérieur cylindre seulement
- ③ Cote maxi recommandée de .040in/1.016mm
- ④ Chemise fonte à emmancher à la presse pour remplacer la che mise d'origine en acier

- ① Pistón coronado que puede necesitar fresado para ajustarse a del fabricante.
- ② Para diámetro internos de hierro fundido solamente
- ③ La sobremedida máxima recomendada es de .040in/1.016mm
- ④ Ajuste a presión la camisa de hierro fundido para reemplazar la camisa original de acero

- ① Il pistone a testa ribassata puo' richiedere una lavorazione adattaralle prescrizioni del costruttore, fare riferiment alle istruzioni contenute nella confezione.
- ② Solo per cilindri in ghisa
- ③ Maggiorazione massima raccomandata .040in/1.016mm
- ④ Canna in ghisa per sostituire canne originali in acciaio

98.43					11
T6.3544	6cyl.	5794cc	110-119kW (150-162PS)	Diesel Turbo	TD8703

87-319000-00 STD

A 69.75
B- 18.67
BØ 66.20
D 107.85
 38x83



RT TP

08-319000-30 STD
08-319000-30 STD

3.16 CK P
 2.38 P
 4.74 CR P

14-040200-00 DH ①
14-045820-00 D
14-045821-00 D

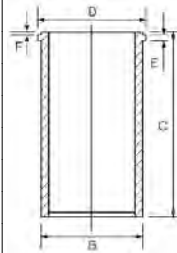

B 103.19 **C** 227.28 **D** 106.45 **E** 3.86 **F** 0.88
B 103.33 **C** 227.28 **D** 106.42 **E** 3.80 **F** 0.90
B 103.83 **C** 227.28 **D** 106.42 **E** 3.80 **F** 0.90

- ① Press fit cast iron liner to replace original steel liner

- ① Anpressbare Laufbuchse aus Gusseisen als Ersatz der original Stahlbüchse

- ① Chemise fonte à emmancher à la presse pour remplacer la che mise d'origine en acier

- ① Ajuste a presión la camisa de hierro fundido para reemplazar la camisa original de acero

- ① Canna in ghisa per sostituire canne originali in acciaio

100.00					12
1004-40	4cyl.	3990cc	48-52kW (65-71PS)	Diesel	TD20891
1006-60	6cyl.	5984cc	79kW (107PS)	Diesel	TD29136

87-422100-00 STD

A 70.30
B- 21.75
BØ 52.80
D 108.23
 40x78



RT TP

08-422100-00 STD

3.50 CK P
 2.50 P
 3.50 CR P

14-049300-00 D
14-049310-00 DH

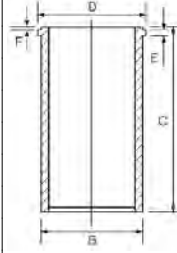

B 104.28 **C** 227.56 **D** 107.44 **E** 3.86 **F** 0.94
B 104.22 **C** 227.58 **D** 107.40 **E** 3.84





100.00					13
C4.40 (1004-4TW)	4cyl.	3990cc	88kW (120PS)	Diesel Turbo Intercooled	MP5069
PHASER 110 T (1004-4T)	4cyl.	3990cc	82kW (111PS)	Diesel Turbo	TD8659
PHASER 160T (1006-6T)	6cyl.	5985cc	119kW (160PS)	Diesel Turbo	TD6547
PHASER 180TI (1006-6TW)	6cyl.	5985cc	134kW (180PS)	Diesel Turbo	TD6404









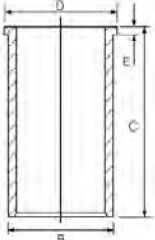

PHASER 180TI (Euro 2 CC6.60)	6cyl.	5985cc	131-134kW (177-182PS)	Diesel	Turbo Intercooled	TD8922
-------------------------------------	-------	---------------	------------------------------	---------------	--------------------------	---------------

ACCO	01/83→12/90	INDUSTRIAL
AUMAN	01/12→	

87-325600-10 STD A 70.05 B- 20.14 BØ 52.00 D 108.00  38x83 RT TP 	08-325600-00 STD 3.50  MO P 2.50  P 4.00  CR P	14-025380-10 DH 	B 104.23 C 226.44 D 107.44 E 3.86 88-325600-10 87-325600-10 + 14-025380-10
--	--	---	--

87-325600-30 STD  A 70.02 B- 19.48 B- 10.28 BØ 55.80 D 108.60  38x83 RT TP 	08-325600-00 STD 3.50  MO P 2.50  P 4.00  CR P		
---	--	--	--





 Original bowl design  Original Schüssel Design  Conception de bol Original  Diseño Cuenco de Original  Disegno ciotola Original





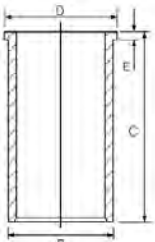

 100.00	14
---	-----------

PHASER 90 (1004-4)	4cyl.	3990cc	Diesel	MP5072
---------------------------	-------	---------------	---------------	---------------

PHASER 125 (1006-6)	6cyl.	5985cc	Diesel	MP5073
----------------------------	-------	---------------	---------------	---------------

INDUSTRIAL

87-101700-00 STD A 70.00 B- 20.14 BØ 51.88 D 108.00  35x84 RT 	08-101700-00 STD 2.50  MO 2.50  P 4.00  CR P	14-025380-10 DH 	B 104.23 C 226.44 D 107.44 E 3.86
---	--	---	---

87-101700-10 STD  A 70.00 B- 10.92 B- 20.14 BØ 55.30 D 108.00  35x84 AK RT 	08-101700-00 STD 2.50  MO 2.50  P 4.00  CR P		
---	--	--	--

 Original bowl design  Original Schüssel Design  Conception de bol Original  Diseño Cuenco de Original  Disegno ciotola Original

 100.00	15
---	-----------

PHASER 160/180T	6cyl.	5985cc	119kW (160PS)	Diesel	TD6412
------------------------	-------	---------------	----------------------	---------------	---------------





14-025380-10 *DH* **B 104.23 C 226.44 D 107.44 E 3.86**

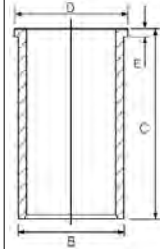

100.00						16
PHASER 200TI (Euro 1)	6cyl.	5985cc	148kW (201PS)	Diesel	Turbo	MP6366
T6.60	6cyl.	5985cc	154kW (210PS)	Diesel	Turbo	MP6365
INDUSTRIAL						

87-325600-00 *STD*

A 70.30
B- 21.75
BØ 52.80
D 108.23
 40x78



RT TP

08-325600-00 *STD*

3.50 **MO P**
 2.50 **P**
 4.00 **CR P**

14-025380-10 *DH* **B 104.23 C 226.44 D 107.44 E 3.86**

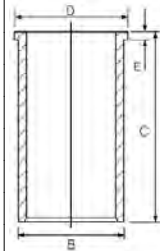

100.96						17
4.248 / A4.248	4cyl.	4065cc	53-61kW (72-83PS)	Diesel		MP26364
INDUSTRIAL						

87-318000-00 *STD*

A 69.92
B- 20.72
BØ 61.45
D 120.72
 35x84



08-318000-10 *STD*

2.38 **CR P**
 2.38 **P**
 2.38 **CR P**
 6.33 **CR P**

14-040120-00 *D* **B 104.25 C 227.28 D 107.44 E 3.86 F 0.76**
14-040190-00 *DH* **B 104.20 C 227.28 D 107.44 E 3.86 F 0.83**
14-041140-00 *D* **B 104.35 C 227.28 D 107.44 E 3.80 F 0.90**
14-041610-00 *D* **B 104.28 C 227.28 D 107.38 E 3.80 F 0.90**

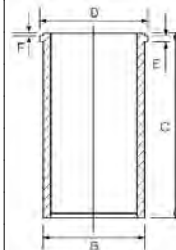

100.96						18
6.372	6cyl.	6100cc	87kW (118PS)	Diesel		TD20102

14-040120-00 *D* **B 104.25 C 227.28 D 107.44 E 3.86 F 0.76**
14-040190-00 *DH* **B 104.20 C 227.28 D 107.44 E 3.86 F 0.83**
14-041140-00 *D* **B 104.35 C 227.28 D 107.44 E 3.80 F 0.90**
14-041610-00 *D* **B 104.28 C 227.28 D 107.38 E 3.80 F 0.90**

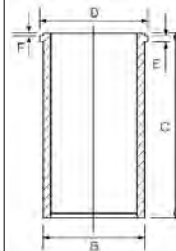



103.00 **19**

1004-42 (Euro 1)	4cyl.	4230cc	45-59kW (61-80PS)	Diesel	TD23905
PHASER 1004-42 (Euro 1)	4cyl.	3990cc		Diesel	MP16364
CLASSIC INDUSTRIAL			03/02→	VISION	04/02→

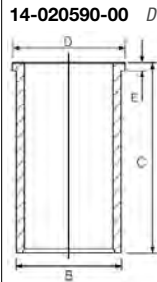

14-020590-00 D **B 107.05 C 228.00 D 110.05 E 4.00**

105.00 **20**

1103A-33	3cyl.	3299cc	28-35kW (38-48PS)	Diesel	MP16365
1103B-33 (Euro 2)	3cyl.	3299cc	43kW (58PS)	Diesel	TD23904
1103C-33 (Euro 2)	3cyl.	3299cc	41-43kW (56-58PS)	Diesel Turbo	TD17273
1103D-33	3cyl.	3299cc	37-41kW (50-56PS)	Diesel	TD19961
1104A-44	4cyl.	4399cc	50-64kW (68-87PS)	Diesel	TD29589
1104C-44 (Euro 2)	4cyl.	4399cc	50-64kW (68-87PS)	Diesel Turbo	TD17275
1104C-E44	4cyl.	4399cc	64kW (87PS)	Diesel Turbo	TD17276
200 Series			12/13→	INDUSTRIAL	
A Series			06/10→	Series 60	11/11→
B Series			01/14→	TECHNOFARM	01/09→
C Series			01/14→	VISION	08/04→

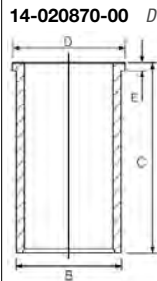

14-020870-00 D **B 108.00 C 227.00 D 109.50 E 5.00**

105.00 **21**

1103A-33T	3cyl.	3299cc		Diesel Turbo	MP26365
1103B-33T	3cyl.	3299cc	49kW (67PS)	Diesel Turbo	MP36365
1103C-33T	3cyl.	3299cc	55kW (75PS)	Diesel Turbo	TD17274
1103C-33TA	3cyl.	3299cc		Diesel Turbo Intercooled	MP46365
1104A-44T	4cyl.	4399cc	74-81kW (101-110PS)	Diesel Turbo	MP56365
1104A-44TA	4cyl.	4399cc		Diesel Turbo Intercooled	MP66365
1104C-44T	4cyl.	4399cc	68-74kW (92-101PS)	Diesel Turbo	TD17277
1104C-E44T	4cyl.	4399cc	74kW (101PS)	Diesel Turbo	TD17278
1104C-E44TA	4cyl.	4399cc	74-97kW (101-132PS)	Diesel Turbo	TD17281
INDUSTRIAL POWERMONDIAL			02/09→	VISION	08/04→





87-426200-00 STD

- A** 70.14
- B-** 22.00
- BØ** 55.10
- D** 108.00
-  40x78



RT TP

08-426200-00 STD

- 3.50  CK P
- 2.50  P
- 3.50  CR P

14-020870-00 D

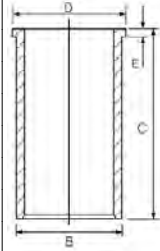

B 108.00 C 227.00 D 109.50 E 5.00



CCM



9

8140.43N (Euro 3 Sofim)	Diesel	2800	4	94.40	58
CRD93	Diesel	2500	4	93.00	53
CRD93L	Diesel	2500	4	93.00	53
DJ5 (T9A)	Diesel	2446	4	92.00	51
DJ5T (T8A/THZ)	Diesel	2446	4	92.00	52
DK5ATE (THY)	Diesel	2446	4	92.00	52
DT17TED4	Diesel	2721	V6	81.00	29
DT20C (Euro 5)	Diesel	2993	V6	84.00	35
DV4C (8HR)	Diesel	1398	4	73.70	6
DV4TD (8HT)	Diesel	1398	4	73.70	7
DV4TD (8HX) (Euro 3/4)	Diesel	1398	4	73.70	7
DV4TD (8HZ)	Diesel	1398	4	73.70	7
DV4TED (8HS) (Euro 4)	Diesel	1398	4	73.70	8
DV4TED4 (8HY)	Diesel	1399	4	73.70	8
DV6ATED4 (9HX) (Euro 4)	Diesel	1560	4	75.00	15
DV6BTED4 (9HT) (Euro 4)	Diesel	1560	4	75.00	16
DV6BTED4 (9HW) (Euro 4)	Diesel	1560	4	75.00	16
DV6C (9HC)	Diesel	1560	4	75.00	16
DV6C (9HD) (Euro 5)	Diesel	1560	4	75.00	16
DV6C (9HL) (Euro 5)	Diesel	1560	4	75.00	16
DV6C (9HR) (Euro 5)	Diesel	1560	4	75.00	16
DV6CTED (9HD)	Diesel	1560	4	75.00	16
DV6DTED (9HF) (Euro 4)	Diesel	1560	4	75.00	16
DV6DTED (9HP) (Euro 4)	Diesel	1560	4	75.00	16
DV6DTEDM (9HJ) (Euro 4)	Diesel	1560	4	75.00	16
DV6DUM (9HH)	Diesel	1560	4	75.00	16
DV6ETEDM (9HK) (Euro 4)	Diesel	1560	4	75.00	16
DV6FC (BHZ)	Diesel	1560	4	75.00	17
DV6FD (BHY)	Diesel	1560	4	75.00	17
DV6TED4 (9HY) (Euro 4)	Diesel	1560	4	75.00	15
DV6TED4 (9HZ) (Euro 4)	Diesel	1560	4	75.00	15
DV6UC (9HM)	Diesel	1560	4	75.00	16
DV6UTED4 (9HU)	Diesel	1560	4	75.00	15
DW8 (WJZ)	Diesel	1868	4	82.20	30
DW8B (WJY)	Diesel	1868	4	82.20	30
DW10ATED (RHS)	Diesel	1997	4	85.00	37
DW10ATED (RHZ)	Diesel	1997	4	85.00	37
DW10ATED4 (RHM)	Diesel	1997	4	85.00	38
DW10ATED4 (RHT)	Diesel	1997	4	85.00	38
DW10ATED4 (RHW)	Diesel	1997	4	85.00	38
DW10BTED (RHX)	Diesel	1997	4	85.00	37
DW10BTED (RHZ)	Diesel	1997	4	85.00	37
DW10BTED+ (RHZ)	Diesel	1997	4	85.00	37
DW10BTED4 (RHF)	Diesel	1997	4	85.00	39
DW10BTED4 (RHR)	Diesel	1997	4	85.00	39
DW10CB (RHD)	Diesel	1997	4	85.00	36
DW10 C HYBRID (RHC) (Euro 5)	Diesel	1997	4	85.00	36
DW10CTED (RHZ)	Diesel	1997	4	85.00	37
DW10CTED4 (RHA)	Diesel	1997	4	85.00	36
DW10CTED4 (RHD)	Diesel	1997	4	85.00	36
DW10CTED4 (RHE) (Euro 5)	Diesel	1997	4	85.00	36
DW10CTED4 (RHH) (Euro 5)	Diesel	1997	4	85.00	36
DW10FC (AHW)	Diesel	1997	4	85.00	40
DW10FD (AHV)	Diesel	1997	4	85.00	40
DW10FD (AHX) (Euro 5)	Diesel	1997	4	85.00	40
DW10TD (RHV)	Diesel	1997	4	85.00	37
DW10TD (RHY)	Diesel	1997	4	85.00	37
DW10UTD (RHV)	Diesel	1997	4	85.00	37
DW10UTED4 (RHK) (Euro 4)	Diesel	1997	4	85.00	39
DW12BTED4 (4HP)	Diesel	2179	4	85.00	41

ENGINE INDEX

Motorverzeichnis • Index de moteur • Índice de Motor
 Indeks silnika • Модель Двигателя • دليل المحرك

CCM
x

9

DW12BTED4 (4HR)	Diesel	2179	4	85.00	41
DW12BTED4 (4HS) (Euro 4)	Diesel	2179	4	85.00	41
DW12BTED4 (4HT) (Euro 4)	Diesel	2179	4	85.00	41
DW12C (4HL) (Euro 5)	Diesel	2179	4	85.00	42
DW12MTED4 (4HK)	Diesel	2179	4	85.00	41
DW12MTED4 (4HN)	Diesel	2179	4	85.00	41
DW12TED4 (4HX/4HW)	Diesel	2179	4	85.00	43
DW12TED4 (4HZ)	Diesel	2179	4	85.00	43
EB2M (HMY)	Petrol	1199	3	75.00	9
EC5 (NFP)	Petrol	1587	4	78.50	24
EC5F	Petrol	1587	4	78.50	24
EC5F (NFJ)	Petrol	1587	4	78.50	24
EN 55	Diesel	2498	4	94.00	55
EP3	Petrol	1397	4	77.00	18
EP3 (8FR)	Petrol	1397	4	77.00	18
EP3 (8FS)	Petrol	1397	4	77.00	18
EP3C	Petrol	1397	4	77.00	18
EP6 (5FW)	Petrol	1598	4	77.00	19
EP6 (Euro 4)	Petrol	1598	4	77.00	19
EP6C (5FH)	Petrol	1598	4	77.00	20
EP6C (5FS)	Petrol	1598	4	77.00	20
EP6CB (5FK)	Petrol	1598	4	77.00	20
EP6CDT (5FA)	Petrol	1598	4	77.00	21
EP6CDT (5FV)	Petrol	1598	4	77.00	21
EP6CDTX (5FU) (Euro 4)	Petrol	1598	4	77.00	19
EP6DT (5FR)	Petrol	1598	4	77.00	22
EP6DT (5FT)	Petrol	1598	4	77.00	21
EP6FDT (5GZ) (Euro 4)	Petrol	1598	4	77.00	21
EP6FDTM (5GY) (Euro 4)	Petrol	1598	4	77.00	21
ET70	Diesel	2496	4	94.00	56
F13DTE5 (FHZ) (Euro 5)	Diesel	1248	4	69.60	1
F28D (8140.63) (Euro 2 Sofim)	Diesel	2800	4	94.40	59
F28DTCR (8140.43S) (Euro 3 Sofim)	Diesel	2800	4	94.40	58
F30DT (F1CE0481D) (Euro 4)	Diesel	2999	4	95.80	60
F30DTE (F1CE0481D) (Euro 4)	Diesel	2999	4	95.80	60
F30DTE (F1CE3481E) (Euro 5)	Diesel	2999	4	95.80	61
F30DTE (F1CE3481N) (Euro 5)	Diesel	2999	4	95.80	61
FG30DT (F1CE0481D) (Euro 4)	Diesel	2999	4	95.80	60
P22DTE (4HG) (Euro 4)	Diesel	2198	4	86.00	44
P22DTE (4HH) (Euro 4)	Diesel	2198	4	86.00	44
P22DTE (4HJ) (Euro 4)	Diesel	2198	4	86.00	44
P22DTE (4HU) (Euro 4)	Diesel	2198	4	86.00	45
P22DTE (4HV) (Euro 4)	Diesel	2198	4	86.00	46
PSA (CRD93)	Diesel	2500	4	93.00	53
TU1 (H1A/H1B/H3A)	Petrol	1124	4	72.00	3
TU1A (HFX)	Petrol	1124	4	72.00	4
TU1JP (HFX)	Petrol	1124	4	72.00	4
TU1JP (HFZ)	Petrol	1124	4	72.00	4
TU1M (HDY)	Petrol	1124	4	72.00	3
TU1M (HDZ)	Petrol	1124	4	72.00	3
TU3 (K5A)	Petrol	1360	4	75.00	10
TU3A (K1D)	Petrol	1361	4	75.00	10
TU3A (K6D)	Petrol	1360	4	75.00	10
TU3A (K6E)	Petrol	1360	4	75.00	10
TU3A (K6F)	Petrol	1360	4	75.00	10
TU3A (KFT)	Petrol	1360	4	75.00	10
TU3A (KFV)	Petrol	1360	4	75.00	10
TU3A (KFW)	Petrol	1360	4	75.00	10
TU3CP (KAY)	Petrol	1361	4	75.00	10
TU3FJ2/Z (KFZ)	Petrol	1361	4	75.00	10



CCM



9

TU3JP (KFW)	Petrol	1360	4	75.00	11
TU3JP (KFX)	Petrol	1361	4	75.00	11
TU3JP-L4	Petrol	1360	4	75.00	12
TU3M (KDY)	Petrol	1361	4	75.00	10
TU3M (KDZ)	Petrol	1361	4	75.00	10
TU3MC (KDX)	Petrol	1361	4	75.00	10
TU3S (K2B)	Petrol	1360	4	75.00	10
TU5J4 (NFX)	Petrol	1587	4	78.50	25
TU5JP (NFT)	Petrol	1587	4	78.50	25
TU5JP (NFZ)	Petrol	1587	4	78.50	26
TU5JP4 (N6A)	Petrol	1587	4	78.50	26
TU5JP4 (NFU)	Petrol	1587	4	78.50	25
TU5JP4B (NFR)	Petrol	1587	4	78.50	25
TU9	Petrol	954	4	70.00	2
TU9M (CDY)	Petrol	954	4	70.00	2
TU9M (CDZ)	Petrol	954	4	70.00	2
TU32	Petrol	1361	4	75.00	10
TUD5 (VJX)	Diesel	1527	4	77.00	23
TUD5 (VJY)	Diesel	1527	4	77.00	23
U25/673 (CRD93LS)	Diesel	2500	4	93.00	54
XD2	Diesel	2304	4	94.00	56
XD2 (134)	Diesel	2304	4	94.00	57
XD2P / XD94	Diesel	2304	4	94.00	57
XD2S	Diesel	2304	4	94.00	56
XD2S (147)	Diesel	2304	4	94.00	56
XD3 (155)	Diesel	2498	4	94.00	55
XD3P	Diesel	2497	4	94.00	55
XD3T	Diesel	2497	4	94.00	56
XD3T (152A)	Diesel	2498	4	94.00	56
XD3TE	Diesel	2498	4	94.00	56
XD3TE (152B)	Diesel	2498	4	94.00	56
XD 4.88	Diesel	1948	4	88.00	49
XD88	Diesel	1948	4	88.00	49
XD90	Diesel	2112	4	90.00	50
XDP 4.88 (Indenor XDP)	Diesel	1946	4	88.00	49
XDP 4.90 (Indenor XDP)	Diesel	2112	4	90.00	50
XDP 6.90 (Indenor XDP)	Diesel	3168	6	90.00	50
XDP 88 (Indenor XDP)	Diesel	1946	4	88.00	49
XDP 90 (Indenor XDP)	Diesel	2112	4	90.00	50
XN1	Petrol	1971	4	88.00	47
XN1 (106)	Petrol	1971	4	88.00	47
XN1A (106E)	Petrol	1971	4	88.00	48
XN1P	Petrol	1971	4	88.00	47
XN1T	Petrol	1971	4	88.00	47
XN1T (170)	Petrol	1971	4	88.00	47
XN1T (170B)	Petrol	1971	4	88.00	47
XN1TA	Petrol	1971	4	88.00	47
XN1TA (170C)	Petrol	1971	4	88.00	48
XN2 (107)	Petrol	1971	4	88.00	47
XU5CP (BAZ)	Petrol	1580	4	83.00	32
XU5J (180)	Petrol	1580	4	83.00	32
XU5J (180A)	Petrol	1580	4	83.00	32
XU5J (B6B)	Petrol	1580	4	83.00	32
XU5JP (BFZ)	Petrol	1580	4	83.00	31
XU5M (BDZ)	Petrol	1580	4	83.00	32
XU5M2Z (BDY)	Petrol	1580	4	83.00	32
XU5M3Z (BDY)	Petrol	1580	4	83.00	32
XU5S (171)	Petrol	1580	4	83.00	31
XU7JB (LFX)	Petrol	1762	4	83.00	32
XU7JP (LFW)	Petrol	1762	4	83.00	32

ENGINE INDEX

Motorverzeichnis • Index de moteur • Índice de Motor
 Indeks silnika • Модель Двигателя • دليل المحرك

CCM
x

9

XU7JP (LFZ)	Petrol	1762	4	83.00	32
XU7JP4 (LFY)	Petrol	1762	4	83.00	32
XU9J1 (DFZ)	Petrol	1905	4	83.00	32
XU9J2 (D6A)	Petrol	1905	4	83.00	32
XU9J4 (D6C/DFW)	Petrol	1905	4	83.00	32
XU9J4 (DFW)	Petrol	1905	4	83.00	32
XU9JA (D6B)	Petrol	1905	4	83.00	32
XU9JAZ (DKZ)	Petrol	1905	4	83.00	32
XU9M (DDZ)	Petrol	1905	4	83.00	32
XU9S (D2B)	Petrol	1905	4	83.00	32
XU51C (B1A)	Petrol	1580	4	83.00	31
XU51C (B1D)	Petrol	1580	4	83.00	32
XU51C (B1E)	Petrol	1580	4	83.00	32
XU52C/K (B2A)	Petrol	1580	4	83.00	32
XU92C	Petrol	1905	4	83.00	32
XU92C (D2A)	Petrol	1905	4	83.00	32
XU92C (D2C)	Petrol	1905	4	83.00	32
XUD7 (161) (XUD7)	Diesel	1769	4	80.00	27
XUD7 (161A) (XUD7)	Diesel	1769	4	80.00	27
XUD7 (A9A) (XUD7)	Diesel	1769	4	80.00	27
XUD7T (XUD7)	Diesel	1769	4	80.00	28
XUD7TE (A8A) (XUD7)	Diesel	1769	4	80.00	28
XUD7TE (A8B) (XUD7)	Diesel	1769	4	80.00	28
XUD7TE (AJZ) (XUD7)	Diesel	1769	4	80.00	28
XUD9	Diesel	1905	4	83.00	33
XUD9 (162)	Diesel	1905	4	83.00	33
XUD9 (D9A)	Diesel	1905	4	83.00	33
XUD9 (DJZ)	Diesel	1905	4	83.00	33
XUD9A (D9B)	Diesel	1905	4	83.00	33
XUD9A (D9B) (XUD9)	Diesel	1905	4	83.00	33
XUD9A (D9B/DJY)	Diesel	1905	4	83.00	33
XUD9A (DJY)	Diesel	1905	4	83.00	33
XUD9BSD (DHV) (XUD9)	Diesel	1905	4	83.00	34
XUD9SD (DHW)	Diesel	1905	4	83.00	34
XUD9TE	Diesel	1905	4	83.00	34
XUD9TE (D8B)	Diesel	1905	4	83.00	34
XUD9TE (DHX)	Diesel	1905	4	83.00	34
XUD9TE (DHY)	Diesel	1905	4	83.00	34
XUD9UTF (D8C)	Diesel	1905	4	83.00	34
XW3 (109)	Petrol	1124	4	72.00	5
XW3S	Petrol	1124	4	72.00	5
XW3S (121)	Petrol	1124	4	72.00	5
XW7 (109F)	Petrol	1124	4	72.00	5
XW7 (109N)	Petrol	1124	4	72.00	5
XY8 (150B)	Petrol	1360	4	75.00	13
XZ5 (129)	Petrol	1219	4	75.00	14



69.60

1

F13DTE5 (FHZ) (Euro 5) 4cyl. **1248cc** **55kW (75PS)** **Diesel** **Turbo Intercooled** **TD33005**

BIPPER 1.3 HDi 75 10/10→ BIPPER TEEPEE 1.3 HDi 75 10/10→

87-435700-00 STD
87-435706-00 0.40mm

08-435700-00 STD
08-435706-00 0.40mm

A 40.43
B- 12.70
BØ 37.00
C 1.15
C 0.90
D 62.43
 23x57



1.50 GDC P
 1.50 P
 2.00 CR P



AK KK RT

With Stop/Start Technology Für Fahrzeuge mit StartStop Funktion Pour véhicules équipé du start & stop Para vehiculos con función start-stop Per veicoli con la funzione Start-Stop

70.00

2

TU9 4cyl. **954cc** **33kW (45PS)** **Petrol** **TD2783**

TU9M (CDY) 4cyl. **954cc** **32-33kW (44-45PS)** **Petrol** **TD4841**

TU9M (CDZ) 4cyl. **954cc** **37kW (50PS)** **Petrol** **TD9405**

106 I 1.0 08/91→04/96 205 1.0 08/90→04/95
 106 II 1.0 04/96→03/01 205 II 1.0 08/87→09/98
 106 II 1.0 i 04/96→03/01

87-154200-00 STD
87-154206-00 0.40mm
87-154208-00 0.60mm

08-154200-00 STD
08-154206-00 0.40mm
08-154208-00 0.60mm

A 33.90
B- 0.50
BØ 55.00
D 57.40
 18x53



1.50 CR P
 1.50 P
 3.00 CR

Steel Stahl Acier Acero Acciaio

72.00

3

TU1 (H1A/H1B/H3A) 4cyl. **1124cc** **40kW (54PS)** **Petrol** **TD2758**

TU1M (HDY) 4cyl. **1124cc** **40-44kW (54-60PS)** **Petrol** **TD9404**

TU1M (HDZ) 4cyl. **1124cc** **44kW (60PS)** **Petrol** **TD4834**

106 I 1.1 09/91→04/96 306 1.1 05/93→05/01
 205 1.1 08/87→05/97 309 1.1 09/89→10/93
 205 I 1.1 08/87→12/94 309 II 1.1 09/89→12/93
 205 I 1.1 CJ 10/89→12/94 PARTNER 1.1 06/96→09/05
 205 II 1.1 10/87→09/98

87-154300-00 STD

08-154300-00 STD
08-154307-00 0.50mm

14-636470-00 WH **B 79.50 C 122.00 D 89.20 E 85.00**

88-154300-00
 87-154300-00 +
 14-636470-00

A 40.05
B+ 2.97
D 64.05
 20x62



1.50 CR P
 2.00 P
 3.00 CR

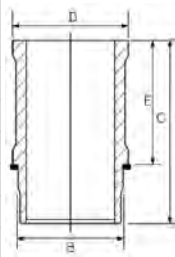

Steel Stahl Acier Acero Acciaio



72.00					4
TU1A (HFX)	4cyl.	1124cc	44kW (60PS)	Petrol	TD25640
TU1JP (HFX)	4cyl.	1124cc	44kW (60PS)	Petrol	TD14728
TU1JP (HFZ)	4cyl.	1124cc	44kW (60PS)	Petrol	TD9848
106 II 1.1 i			05/96→07/04	206 1.1	07/02→02/07
206+ 1.1			01/09→06/13	206 1.1 i	09/98→02/07
206+ 1.1 LPG			04/09→06/13	PARTNER 1.1	06/96→10/02

87-426300-00 STD

08-426300-00 STD

A 27.70
B+ 0.10
D 47.50
18x55



1.50 NT
1.50 P
2.50 P



72.00					5
XW3 (109)	4cyl.	1124cc	42kW (57PS)	Petrol	TD2895
XW3S	4cyl.	1124cc	48kW (66PS)	Petrol	TD12688
XW3S (121)	4cyl.	1124cc	49kW (67PS)	Petrol	TD2896
XW7 (109F)	4cyl.	1124cc	37kW (50PS)	Petrol	TD2899
XW7 (109N)	4cyl.	1124cc	36kW (50PS)	Petrol	TD2900
104 1.1			09/73→06/88	205 I 1.1	02/83→10/87
205 1.1			02/83→07/87	205 II 1.1	10/87→10/90

14-636470-00 WH B 79.50 C 122.00 D 89.20 E 85.00

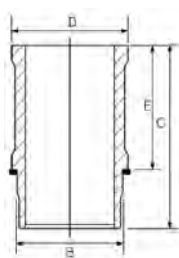

73.70					6
DV4C (8HR)	4cyl.	1398cc	50kW (68PS)	Diesel Turbo Intercooled	TD28125
206+ 1.4 HDi eco 70			01/09→06/13	208 I 1.4 HDi	03/12→
207 1.4 HDi			02/06→	2008 I 1.4 HDi	06/13→
208 1.4 HDi 68			10/12→		

14-020760-00 D B 76.95 C 136.00 D 78.45 E 5.25
14-020761-00 D B 76.95 C 136.00 D 78.45 E 5.25

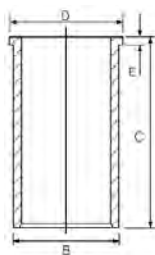

73.70					7
DV4TD (8HT)	4cyl.	1398cc	40kW (54PS)	Diesel Turbo Intercooled	TD24924
DV4TD (8HX) (Euro 3/4)	4cyl.	1398cc	50kW (68PS)	Diesel Turbo Intercooled	TD16368





DV4TD (8HZ)	4cyl.	1398cc	50-52kW (68-70PS)	Diesel	Turbo Intercooled	TD17509
107 1.4 HDi			06/05→05/14		207 1.4 HDi	02/06→
206+ 1.4 HDi eco 70			01/09→06/13		307 1.4 HDi	10/01→06/05
206 1.4 HDi			09/01→03/09		307 SW 1.4 HDi	04/02→06/05
206 1.4 HDi eco 70			09/01→		1007 1.4 HDi	04/05→

87-135300-00 STD
87-135307-00 0.50mm

08-135300-00 STD
08-135305-00 0.25mm
08-135307-00 0.50mm

14-020760-00 D
14-020761-00 D
B 76.95 C 136.00 D 78.45 E 5.25
B 76.95 C 136.00 D 78.45 E 5.25

A 42.94
B- 14.70
BØ 37.16
C 1.55
D 65.44
25x60



2.50 CK P
1.95 P
2.50 CR P

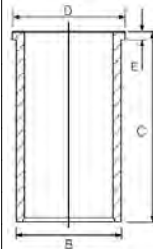

AK RT TP

73.70

8

DV4TED (8HS) (Euro 4)	4cyl.	1398cc	50kW (68PS)	Diesel	Turbo Intercooled	TD29164
DV4TED4 (8HY)	4cyl.	1399cc	66kW (89PS)	Diesel	Turbo Intercooled	MP19023
206 1.4TD			01/02→		BIPPER 1.4 HDi	02/08→
307 1.4TD			01/02→		BIPPER TEPEE 1.4 HDi	04/08→

87-135300-10 STD

08-135300-00 STD
08-135305-00 0.25mm
08-135307-00 0.50mm

A 42.94
B- 14.40
BØ 37.15
C 1.15
C 1.15
D 65.44
25x60



2.50 CK P
1.95 P
2.50 CR P

KK RT TP

75.00

9

EB2M (HMY)	3cyl.	1199cc	53kW (72PS)	Petrol	TD32325
301 1.2 VTi 72			11/12→		

87-442900-00 STD
87-442907-00 0.50mm

08-442900-00 STD
08-442907-00 0.50mm

A 28.85
B+ 2.70
C 2.65
C 1.55
D 46.85
17x51



1.00 NT
1.00 P
2.00 CR P

LKZ-Ring

HA

Steel

Stahl

Acier

Acero

Acciaio

75.00

10

TU3 (K5A)	4cyl.	1360cc	47-51kW (64-69PS)	Petrol	TD26412
TU3A (K1D)	4cyl.	1361cc	49-50kW (67-68PS)	Petrol	TD2766
TU3A (K6D)	4cyl.	1360cc	53kW (72PS)	Petrol	TD24928
TU3A (K6E)	4cyl.	1360cc	53kW (72PS)	Petrol	TD24930
TU3A (K6F)	4cyl.	1360cc	53kW (72PS)	Petrol	TD24929





TU3A (KFT)	4cyl.	1360cc	54kW (73PS)	Petrol	TD24931
TU3A (KFV)	4cyl.	1360cc	54-60kW (73-82PS)	Petrol	TD21111
TU3A (KFW)	4cyl.	1360cc	55-60kW (75-82PS)	Petrol	TD24927
TU3CP (KAY)	4cyl.	1361cc	44kW (60PS)	Petrol	TD2767
TU3FJ2/Z (KFZ)	4cyl.	1361cc	69kW (94PS)	Petrol	TD45567
TU3M (KDY)	4cyl.	1361cc	55-58kW (75-79PS)	Petrol	TD4836
TU3M (KDZ)	4cyl.	1361cc	55kW (75PS)	Petrol	TD2775
TU3MC (KDX)	4cyl.	1361cc	55-58kW (75-79PS)	Petrol	TD2777
TU3S (K2B)	4cyl.	1360cc	62kW (85PS)	Petrol	TD2779
TU32	4cyl.	1361cc	51-55kW (70-75PS)	Petrol	TD8507

106 I 1.4	08/91→04/96	207 SW 1.4 LPG	08/07→12/12
106 I 1.4 Le Mans	09/91→11/94	306 1.4	04/93→07/01
205 I 1.4	08/87→06/94	306 1.4 SL	06/94→05/01
205 I 1.4 CJ	03/89→12/94	309 1.4	09/89→10/93
205 I 1.4 CJ Cat	01/89→09/93	309 I 1.4	08/88→08/89
205 II 1.4	06/87→09/98	309 II 1.4	07/89→12/93
205 II 1.4 Cat	08/87→09/93	405 I 1.4	01/87→07/92
206+ 1.4 i	01/09→08/13	405 II 1.4	08/92→10/96
206 1.4	07/02→	1007 1.4	04/05→
206 1.4 CNG	05/06→09/07	BIPPER 1.4	02/08→
206 1.4 i	09/98→12/12	BIPPER TEPEE 1.4	04/08→
207 1.4	02/06→12/15	PARTNER 1.4	06/96→12/15
207 SW 1.4	06/07→12/12		

87-154400-00 STD

- A 40.50
- B- 1.10
- BØ 62.00
- D 64.50
- 20x62



08-154400-00 STD

08-154407-00 0.50mm

- 1.75 CR P
- 2.00 P
- 3.00 P

15-636600-00 WH

14-636600-00 WH

B 79.50 C 134.50 D 89.20 E 90.00

B 79.50 C 134.50 D 89.20 E 90.00

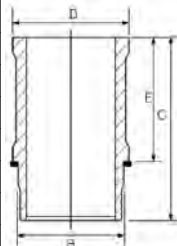

88-154400-00

87-154400-00 +
14-636600-00

Includes seals

Schließt Dichtungen ein

Inclut des joints

Incluye los sellos

Comprende le guarnizioni

75.00

11

TU3JP (KFW)	4cyl.	1360cc	47-60kW (64-82PS)	Petrol	TD14729
TU3JP (KFX)	4cyl.	1361cc	49-55kW (67-75PS)	Petrol	TD5396

106 II 1.4 i	05/96→07/04	207 SW 1.4	08/08→01/13
205 II 1.4	07/88→09/98	306 1.4	04/93→04/02
206 1.4	07/02→	306 1.4 SL	06/94→05/01
206 1.4 i	09/98→12/12	307 1.4	08/00→09/03
206 1.4 LPG	07/02→02/07	PARTNER 1.4	06/96→12/15
207 1.4	08/08→12/14	PARTNER ORIGIN 1.4	07/08→12/15

87-138900-10 STD

→01/04

- A 27.75
- B- 1.30
- BØ 65.00
- D 49.75
- 18x58



08-138900-00 STD

- 1.50 CK P
- 1.50 P
- 2.50 P

15-636600-00 WH

14-636600-00 WH

B 79.50 C 134.50 D 89.20 E 90.00

B 79.50 C 134.50 D 89.20 E 90.00

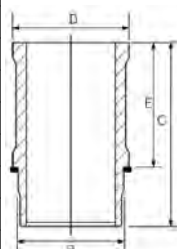

88-138900-10

87-138900-10 +
14-636600-00





87-138900-30 STD ②
01/04→

A 27.75
B+ 0.18
D 49.75
18x56



08-138900-00 STD

1.50 CK P
1.50 P
2.50 P



15-636600-00 WH ①
14-636600-00 WH

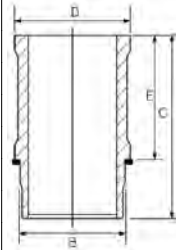

B 79.50 **C** 134.50 **D** 89.20 **E** 90.00
B 79.50 **C** 134.50 **D** 89.20 **E** 90.00

88-138900-30
87-138900-30 +
14-636600-00

① Includes seals
② Euro 4

① Schließt Dichtungen ein

① Inclut des joints

① Incluye los sellos

① Comprende le guarnizioni

75.00

12

TU3JP-L4 4cyl. **1360cc** **48-55kW (65-75PS)** **Petrol** **TD18518**

206 1.4 LPG 05/06→09/07 1007 1.4 04/05→

87-138900-30 STD

A 27.75
B+ 0.18
D 49.75
18x56



08-138900-00 STD

1.50 CK P
1.50 P
2.50 P



15-636600-00 WH ①
14-636600-00 WH

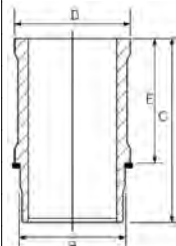

B 79.50 **C** 134.50 **D** 89.20 **E** 90.00
B 79.50 **C** 134.50 **D** 89.20 **E** 90.00

88-138900-30
87-138900-30 +
14-636600-00

① Includes seals

① Schließt Dichtungen ein

① Inclut des joints

① Incluye los sellos

① Comprende le guarnizioni

75.00

13

XY8 (150B) 4cyl. **1360cc** **58-59kW (79-80PS)** **Petrol** **TD2905**

205 I 1.4 02/83→10/87 205 II 1.4 07/88→05/89
205 I 1.4 CT 04/86→12/88

15-636600-00 WH ①
14-636600-00 WH

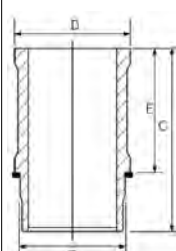

B 79.50 **C** 134.50 **D** 89.20 **E** 90.00
B 79.50 **C** 134.50 **D** 89.20 **E** 90.00

① Includes seals

① Schließt Dichtungen ein

① Inclut des joints

① Incluye los sellos

① Comprende le guarnizioni

75.00

14

XZ5 (129) 4cyl. **1219cc** **42kW (57PS)** **Petrol** **TD2906**

104 1.2 08/79→06/83





15-636700-00 WH **B 79.50 C 122.00 D 89.20 E 82.50**

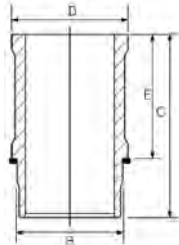

Includes seals

Schließt Dichtungen ein

Inclut des joints

Incluye los sellos

Comprende le guarnizioni

75.00

15

DV6ATED4 (9HX) (Euro 4)	4cyl.	1560cc	66-68kW (90-92PS)	Diesel	Turbo Intercooled	TD20147
DV6TED4 (9HY) (Euro 4)	4cyl.	1560cc	80kW (109PS)	Diesel	Turbo Intercooled	TD17506
DV6TED4 (9HZ) (Euro 4)	4cyl.	1560cc	80-84kW (109-114PS)	Diesel	Turbo Intercooled	TD18520
DV6UTED4 (9HU)	4cyl.	1560cc	66kW (90PS)	Diesel	Turbo Intercooled	TD24693

206 1.6 HDi 110	05/04→	407 SW 1.6 HDi	08/04→12/10
207 1.6 HDi	02/06→10/13	1007 1.6 HDi	06/07→
207 CC 1.6 HDi	02/07→01/15	3008 1.6 HDi	06/09→08/16
207 SW 1.6 HDi	06/07→12/12	3008 HDi 110	06/09→08/16
307 1.6 HDi	04/05→03/09	5008 1.6 HDi	09/09→03/17
307 1.6 HDi 90	04/05→04/08	EXPERT 1.6 HDi 90 16V	01/07→
307 1.6 HDi 110	02/04→03/09	EXPERT TEPEE 1.6 HDi 90 16V	01/07→03/16
307 1.6 HDi 110	11/03→12/07	PARTNER 1.6 HDi	04/08→
307 SW 1.6 HDi	04/06→10/08	PARTNER 1.6 HDi 16V	01/09→
308 CC 1.6 HDi	02/09→05/12	PARTNER 1.6 HDi 90	08/05→12/15
308 I 1.6 HDi	09/07→10/14	PARTNER ORIGIN 1.6 HDi 90	08/08→12/15
308 SW I 1.6 HDi	09/07→10/14	PARTNER TEPEE 1.6 HDi	04/08→
407 1.6 HDi 110	05/04→12/10		

87-424000-00 STD
87-424008-00 0.60mm

A 41.70
B- 13.25
BØ 41.80
C 1.20
D 65.30
 26x61



AK KK RT TP

08-424000-00 STD
08-424007-00 0.50mm
08-424008-00 0.60mm

3.00 CK P
1.95 P
2.50 CR P

LKZ-Ring

14-020900-00 D **B 78.00 C 142.00 D 79.50 F 5.00**

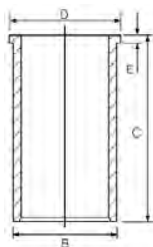

75.00

16

DV6BTED4 (9HT) (Euro 4)	4cyl.	1560cc	55kW (75PS)	Diesel	Turbo Intercooled	TD23537
DV6BTED4 (9HW) (Euro 4)	4cyl.	1560cc	55kW (75PS)	Diesel	Turbo Intercooled	TD24701
DV6C (9HC)	4cyl.	1560cc	82-85kW (112-116PS)	Diesel	Turbo Intercooled	TD32307
DV6C (9HD) (Euro 5)	4cyl.	1560cc	84kW (114PS)	Diesel	Turbo Intercooled	TD32320
DV6C (9HL) (Euro 5)	4cyl.	1560cc	82-85kW (112-116PS)	Diesel	Turbo Intercooled	TD26986
DV6C (9HR) (Euro 5)	4cyl.	1560cc	82-85kW (112-116PS)	Diesel	Turbo Intercooled	TD26421
DV6CTED (9HD)	4cyl.	1560cc	84kW (114PS)	Diesel	Turbo Intercooled	TD26896
DV6DTED (9HF) (Euro 4)	4cyl.	1560cc	66-69kW (90-94PS)	Diesel	Turbo Intercooled	TD26710
DV6DTED (9HP) (Euro 4)	4cyl.	1560cc	66-69kW (90-94PS)	Diesel	Turbo Intercooled	TD27064
DV6DTEDM (9HJ) (Euro 4)	4cyl.	1560cc	68kW (92PS)	Diesel	Turbo Intercooled	TD27967
DV6DUM (9HH)	4cyl.	1560cc	66kW (90PS)	Diesel	Turbo Intercooled	TD29700
DV6ETEDM (9HK) (Euro 4)	4cyl.	1560cc	55kW (75PS)	Diesel	Turbo Intercooled	TD27968
DV6UC (9HM)	4cyl.	1560cc	66kW (90PS)	Diesel	Turbo Intercooled	TD29699





207 1.6 HDi	11/09→03/13	2008 I 1.6 HDi	03/13→
207 1.6 HDi 110	08/09→12/12	3008 1.6 HDi	12/09→08/16
207 CC 1.6 HDi	08/09→10/13	3008 1.6 HDi 115	02/13→08/16
207 SW 1.6 HDi	08/09→12/13	4008 1.6 HDi	05/12→
208 1.6 HDi 92	03/14→	5008 1.6 HDi	08/10→03/17
208 I 1.6 e-HDi	07/15→	5008 I HDi	08/10→03/17
208 I 1.6 HDi	03/12→	5008 I HDi / e-HDi	03/13→03/17
208 II 1.6 HDi 90	10/19→	EXPERT 1.6 HDi 90 8V	01/07→
301 1.6 HDi 90	11/12→	EXPERT TEPEE 1.6 HDi 90 8V	01/07→03/16
308 1.6 e-HDi 115	03/15→06/21	PARTNER 1.6 HDi	04/08→
308 CC 1.6 HDi	06/09→12/14	PARTNER 1.6 HDi 75	08/05→07/08
308 I 1.6 HDi	11/09→10/14	PARTNER 1.6 HDi 90	04/10→
308 II 1.6 HDi	09/13→06/21	PARTNER 1.6 HDi 92	11/09→12/10
308 SW I 1.6 HDi	11/09→10/14	PARTNER 1.6 HDi 92	09/18→
308 SW II 1.6 HDi	03/14→06/21	PARTNER ORIGIN 1.6 HDi 75	08/08→12/15
308 SW II 1.6 HDi 92	03/14→06/21	PARTNER TEPEE 1.6 HDi	06/08→
408 1.6 HDi	11/10→	PARTNER TEPEE 1.6 HDi 75	06/08→
408 1.6 HDi	11/16→	PARTNER TEPEE 1.6 HDi 90	04/10→
508 I 1.6 HDi	11/10→12/18	RIFTER 1.6 HDi 90	09/18→
508 SW 1.6 HDi	03/13→12/18	RIFTER 1.6 HDi 92	09/18→
508 SW I 1.6 HDi	11/10→12/18		

87-433600-00 STD

87-433607-00 0.50mm

- A 41.75
- B- 13.85
- BØ 45.00
- D 65.20
- 26x61

AK KK RT TP



08-433600-00 STD

08-433607-00 0.50mm

- 2.50 CK P
- 1.95 P
- 2.00 CR P

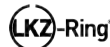

14-020900-00 D

B 78.00 C 142.00 D 79.50 F 5.00

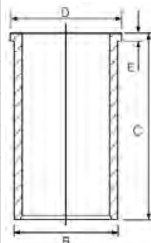

75.00

17

DV6FC (BHZ)	4cyl.	1560cc	85-88kW (116-120PS)	Diesel	Turbo Intercooled	TD28620
DV6FD (BHY)	4cyl.	1560cc	73-75kW (99-102PS)	Diesel	Turbo Intercooled	TD31070
208 1.6 Blue HDi 100			06/15→	2008 I 1.6 120		07/14→
208 I 1.6 100			01/15→	3008 1.6 100		11/16→
208 I 1.6 120			11/13→	3008 1.6 120		05/14→
301 1.6 100			04/14→	5008 1.6		11/14→03/17
308 II 1.6 120			11/13→06/21	5008 1.6 120		05/14→03/17
308 II 1.6 HDi			09/13→06/21	5008 II 1.6 100		12/16→
308 II 1.6 HDi 100			04/14→06/21	5008 II 1.6 120		12/16→
308 SW II 1.6			04/14→06/21	PARTNER 1.6 100		04/15→
308 SW II 1.6 100			04/14→06/21	PARTNER 1.6 120		04/15→
308 SW II 1.6 120			03/14→06/21	PARTNER 1.6 BlueHDI 100		09/18→
308 SW II 1.6 HDi			03/14→06/21	PARTNER TEPEE 1.6 100		12/14→
508 I 1.6 120			03/14→12/18	PARTNER TEPEE 1.6 120		12/14→
508 SW I 1.6 120			03/14→12/18	RIFTER 1.6 100		09/18→
2008 I 1.6 100			01/15→			

87-453100-00 STD

87-453107-00 0.50mm

- A 41.70
- B- 13.15
- BØ 45.50
- D 63.70

AK KK RT TP



08-453100-00 STD

08-453107-00 0.50mm

- 2.00 CK
- 1.95 P
- 2.00 CR



77.00					18
EP3	4cyl.	1397cc	70kW (95PS)	Petrol	TD24067
EP3 (8FR)	4cyl.	1397cc	72kW (98PS)	Petrol	TD32314
EP3 (8FS)	4cyl.	1397cc	70kW (95PS)	Petrol	TD24728
EP3C	4cyl.	1397cc	70kW (95PS)	Petrol	TD26999
207 1.4 16V			06/07→10/13	208 I 1.4 VTi	03/12→
207 SW 1.4 16V			06/07→10/13	308 I 1.4 16V	09/07→10/14
208 I 1.4 GPL			10/13→	308 SW I 1.4 16V	09/07→10/14

87-444800-40 STD

A 30.80
B- 3.10
BØ 55.33
B+ 3.20
C 5.88
C 3.54
D 50.85
18.00x43.00



08-444800-10 STD

08-444807-10 0.50mm

1.20 PVD P
1.50 P
2.00 NT



TP

Steel Stahl Acier Acero Acciaio

77.00					19
EP6 (5FW)	4cyl.	1598cc	88kW (120PS)	Petrol	TD31969
EP6 (Euro 4)	4cyl.	1598cc	81-88kW (110-120PS)	Petrol	TD20086
EP6CDTX (5FU) (Euro 4)	4cyl.	1598cc	147kW (200PS)	Petrol Turbo Intercooled	TD27999
207 1.6			09/09→10/13	308 CC 1.6 16V	06/09→12/14
207 1.6 16V VTi			02/07→12/12	308 I 1.6 16V	09/07→10/14
207 1.6 VTi			03/07→12/12	308 SW I 1.6 16V	09/07→10/14
207 CC 1.6 16V			02/07→10/13	3008 1.6 VTi	06/09→08/16
207 SW 1.6 16V			06/07→10/13	5008 1.6 16V	09/09→03/17
208 I 1.6 GTi			08/12→		

87-444800-50 STD

87-444807-50 STD

A 28.50
B- 3.50
B+ 2.70
C 3.50
C 3.50
D 51.20
20x48



08-444800-10 STD

08-444807-10 0.50mm

1.20 PVD P
1.50 P
2.00 NT



HA RT TP

Steel Stahl Acier Acero Acciaio

77.00					20
EP6C (5FH)	4cyl.	1598cc	85kW (116PS)	Petrol	TD32319
EP6C (5FS)	4cyl.	1598cc	88-89kW (120-121PS)	Petrol	TD25101
EP6CB (5FK)	4cyl.	1598cc	72kW (98PS)	Petrol	TD32308
207 1.6 16V VTi			02/07→12/12	508 I 1.6 VTi	11/10→12/18
207 CC 1.6 16V			02/07→10/13	508 SW I 1.6 VTi	11/10→12/18
207 SW 1.6 16V			06/07→10/13	2008 I 1.6 VTi	03/13→
208 I 1.6			03/12→	3008 1.6 VTi	06/09→08/16
308 I 1.6 16V			09/07→10/14	5008 1.6 16V	09/09→03/17
308 SW I 1.6 16V			09/07→10/14	PARTNER 1.6	04/10→
408 1.6 VTi			01/12→	PARTNER TEPEE 1.6 VTi	09/09→





87-444800-10 STD
87-444807-10 0.50mm

08-444800-10 STD
08-444807-10 0.50mm

A 27.50
B- 2.00
BØ 57.50
C 3.97
C 5.95
D 47.50
 18x43

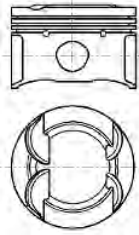

1.20  PVD P 
 1.50  P
 2.00  NT 

 Steel

 Stahl

 Acier

 Acero

 Acciaio

77.00

21

EP6CDT (5FA)	4cyl.	1598cc	92kW (125PS)	Petrol	Turbo Intercooled	TD34216
EP6CDT (5FV)	4cyl.	1598cc	115kW (156PS)	Petrol	Turbo Intercooled	TD34209
EP6DT (5FT)	4cyl.	1598cc	103kW (140PS)	Petrol	Turbo Intercooled	TD24695
EP6FDT (5GZ) (Euro 4)	4cyl.	1598cc	120-127kW (163-173PS)	Petrol	Turbo Intercooled	TD31847
EP6FDTM (5GY) (Euro 4)	4cyl.	1598cc	120-127kW (163-173PS)	Petrol	Turbo Intercooled	TD34217



207 CC 1.6 16V Turbo	10/09→12/13	508 I 1.6 THP	11/10→12/18
208 I 1.6	03/12→	508 II 1.6 THP 165	09/18→
208 I 1.6 THP 165	03/15→	508 SW I 1.6	02/12→12/18
308 CC 1.6 16V	06/09→12/14	508 SW I 1.6 THP	11/10→12/18
308 I 1.6	09/09→12/10	508 SW II 1.6 THP 165	09/18→
308 I 1.6 16V	09/07→10/14	2008 I 1.6 THP 165	02/16→
308 I 1.6 THP 16V	10/09→10/14	3008 1.6 THP	06/09→08/16
308 II 1.6 THP	09/13→06/21	3008 1.6 THP 165	05/16→
308 II 1.6 THP 125	09/13→06/21	3008 1.6 Turbo	05/14→08/16
308 SW I 1.6 16V	09/07→10/14	5008 1.6 16V	09/09→03/17
308 SW I 1.6 THP 16V	10/09→10/14	5008 1.6 THP 163	02/12→03/17
308 SW II 1.6 THP 125	03/14→06/21	5008 1.6 THP 165	02/12→03/17
308 SW II 1.6 THP 155	03/14→06/21	5008 II 1.6 THP 165	12/16→
408 1.6 THP 160	01/11→	RCZ 1.6 16V	03/10→12/15

87-453000-00 STD
87-453007-00 0.50mm

08-453000-00 STD
08-453007-00 0.50mm

A 30.18
B- 3.30
D 50.13
 20x48
 (88850)



1.20  PVD 
 1.20  P
 2.00  CR

 Steel

 Stahl

 Acier

 Acero

 Acciaio

77.00

22

EP6DT (5FR)	4cyl.	1598cc	115kW (156PS)	Petrol	Turbo Intercooled	TD24702
207 1.6 16V Turbo			10/09→12/12	207 CC 1.6 16V Turbo		10/09→12/13





87-444800-30 STD
09/06→

A 28.50
C 2.10
D 50.12
 20x48



08-444800-10 STD
08-444807-10 0.50mm

1.20 PVD P ①
1.50 P
2.00 NT ①

① Steel ① Stahl ① Acier ① Acero ① Acciaio

77.00				23	
TUD5 (VJX)	4cyl.	1527cc	42kW (57PS)	Diesel	TD16193
TUD5 (VJY)	4cyl.	1527cc	40-43kW (54-58PS)	Diesel	TD4842
106 I 1.5 D		06/94→04/96		106 II 1.5 D	05/96→07/04

87-325800-00 STD
87-325806-00 0.40mm

A 40.37
B- 1.65
D 66.32
 23x60



08-325800-00 STD
08-325806-00 0.40mm

2.00 CK P
1.75 P
3.00 CR P

AK RT

78.50				24	
EC5 (NFP)	4cyl.	1587cc	85-90kW (115-122PS)	Petrol	TD28574
EC5F	4cyl.	1587cc	85kW (116PS)	Petrol	TD36317
EC5F (NFJ)	4cyl.	1587cc	85kW (116PS)	Petrol	TD39707
208 I 1.6		06/13→		308 I 1.6	02/12→12/15
208 II 1.6 VTi 115		11/19→		308 II 1.6 VTi 115	05/15→06/21
301 1.6 LPG		07/14→		308 SW II 1.6 VTi	03/14→06/21
301 1.6 VTi 115		11/12→10/17		408 1.6	01/12→

87-452700-00 STD ①
87-452707-00 STD ①
07/11→

A 32.35
B+ 1.40
C 2.45
D 53.75
 20x57



08-452700-00 STD
08-452707-00 0.50mm

1.00 CK ②
1.20 P
2.00 CR P



① 85kW→ ② Steel ② Stahl ② Acier ② Acero ② Acciaio

78.50				25	
TU5J4 (NFX)	4cyl.	1587cc	87-88kW (118-120PS)	Petrol	TD4839
TU5JP (NFT)	4cyl.	1587cc	72kW (98PS)	Petrol	TD32683
TU5JP4 (NFU)	4cyl.	1587cc	78-90kW (106-122PS)	Petrol	TD15668
TU5JP4B (NFR)	4cyl.	1587cc	66kW (90PS)	Petrol	TD24700









106 II 1.6 S16	05/96→07/04	308 I 1.6 BioFlex	04/08→10/14
206 1.6	07/00→04/09	308 SW I 1.6	03/09→10/14
206 1.6 16V	07/00→	405 II 1.6	08/92→05/97
206 1.6 LPG	07/02→02/07	1007 1.6 16V	04/05→
207 1.6 16V	02/06→12/13	PARTNER 1.6	09/00→
207 SW 1.6	08/08→12/12	PARTNER 1.6 16V	07/01→03/08
306 1.6	10/00→04/02	PARTNER ORIGIN 1.6	09/11→12/15
307 1.6	07/06→12/12	PARTNER ORIGIN 1.6 16V	09/11→12/13
307 1.6 16V	08/00→04/09	PARTNER TEPEE 1.6 VTi	04/08→
307 1.6 BioFlex	09/07→04/09		

87-139400-00 STD
87-139407-00 0.50mm

A 32.35
B+ 1.30
D 51.30
 20x57



08-139400-00 STD
08-139406-00 0.40mm
08-139407-00 0.50mm

1.20  CK P
 1.50  P
 2.50  P

78.50 **26**



TU5JP (NFZ)	4cyl.	1587cc	65-66kW (88-90PS)	Petrol	TD4840
TU5JP4 (N6A)	4cyl.	1587cc	78-83kW (106-113PS)	Petrol	TD21503
106 I 1.6			06/93→04/96	207 SW 1.6	08/08→12/13
106 II 1.6 i			05/96→10/99	306 1.6	05/93→05/01
206 1.6 8V			05/99→10/03	306 1.6 SR	06/94→10/00
206 1.6 i			09/98→12/00	307 1.6	07/06→12/12
207 1.6			01/08→12/13		

87-103800-00 STD
87-103806-00 0.40mm

A 32.25
B- 1.50
BØ 68.50
D 57.50
 20x62



08-103800-00 STD
08-103806-00 0.40mm

1.50  CK P
 1.50  P
 3.00  CR P

80.00 **27**

XUD7 (161) (XUD7)	4cyl.	1769cc	43-44kW (58-60PS)	Diesel	TD21268
XUD7 (161A) (XUD7)	4cyl.	1769cc	44kW (60PS)	Diesel	TD2882
XUD7 (A9A) (XUD7)	4cyl.	1769cc	43-44kW (58-60PS)	Diesel	TD12351
205 1.7 Diesel			03/94→05/97	306 1.8 D	04/93→05/01
205 1.8 D			02/83→07/90	309 1.8 D	05/87→10/93
205 I 1.7 Diesel			08/83→10/87	309 II 1.8 D	10/91→10/93
205 II 1.7 Diesel			07/87→09/98	309 II 1.8 Diesel	07/89→12/93
205 II 1.8 Diesel			07/87→09/98	405 I 1.8 D	04/90→07/92
305 II 1.8 D			11/82→12/88	PARTNER 1.8 D	06/96→12/02





87-321500-10 STD
87-321507-10 0.50mm
87-321510-10 0.80mm

A 46.80
B- 2.00
D 84.50
 25x70



08-321500-00 STD
08-321507-00 0.50mm
08-321510-00 0.80mm

2.00 CR P
 2.00 P
 3.00 CR P

14-024740-00 D **B** 83.50 **C** 154.00 **D** 85.70 **E** 4.60
14-024830-00 D **B** 83.00 **C** 154.00 **D** 86.00 **E** 4.50

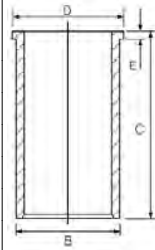

80.00

28

XUD7T (XUD7)	4cyl.	1769cc	58kW (79PS)	Diesel	Turbo Intercooled	TD18394
XUD7TE (A8A) (XUD7)	4cyl.	1769cc	66kW (90PS)	Diesel	Turbo Intercooled	TD2884
XUD7TE (A8B) (XUD7)	4cyl.	1769cc	57kW (78PS)	Diesel	Turbo	TD10789
XUD7TE (AJZ) (XUD7)	4cyl.	1769cc	66kW (90PS)	Diesel	Turbo Intercooled	TD2885
205 I 1.8 DT			08/90→12/94	405 I 1.8 D		10/87→07/92
205 II 1.8 TD			01/90→09/98	405 I 1.8 DT		05/90→07/92
205 II 1.8 XDT			08/90→05/97	405 I 1.8 TD		10/88→08/92
309 II 1.8 TD			08/89→12/93	405 I 1.8 Turbo Diesel		03/88→12/92

87-323607-00 0.50mm

A 46.80
B- 2.20
D 84.50
 28x68

AK RT



08-323600-00 STD
08-323607-00 0.50mm

3.00 MOL P
 2.00 P
 3.00 CR P

14-024740-00 D **B** 83.50 **C** 154.00 **D** 85.70 **E** 4.60
14-024830-00 D **B** 83.00 **C** 154.00 **D** 86.00 **E** 4.50

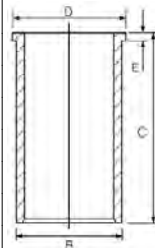

81.00

29

DT17TED4	V6cyl.	2721cc	150kW (204PS)	Diesel	Turbo Intercooled	TD18175
607 2.7 HDi			12/04→07/11			

87-432400-00 STD
87-432407-00 0.50mm

A 47.00
B- 14.05
BØ 44.00
C 0.50
D 71.00
 29x62

(8165E-108)

AK KK RT TP



08-432400-00 STD
08-432407-00 0.50mm

2.00 CK P
 2.00 P
 2.00 P

82.20

30

DW8 (WJZ)	4cyl.	1868cc	51-52kW (69-72PS)	Diesel		TD9868
DW8B (WJY)	4cyl.	1868cc	51kW (69PS)	Diesel		TD13788
206 1.9 D			09/98→05/07	EXPERT 1.9 D		06/98→12/06
207 1.9 D			10/08→12/12	EXPERT 1.9 D 70		12/98→12/06
207 1.9 XSD			12/07→12/12	PARTNER 1.9 D		06/96→12/15





306 1.9 D	09/98→08/03	PARTNER ORIGIN 1.9 D	08/08→12/15
87-104000-00 STD 87-104008-00 0.60mm	08-104000-00 STD 08-104008-00 0.60mm	14-020290-00 D B 85.00 C 154.00 D 87.00 E 5.00	88-104000-00 87-104000-00 + 14-020290-00
A 46.80 B- 1.30 D 78.00 25x65	 2.00 CK P 2.00 P 3.00 CR P		

83.00				31	
XU5JP (BFZ)	4cyl.	1580cc	65-68kW (88-92PS)	Petrol	TD2863
XU5S (171)	4cyl.	1580cc	66-71kW (90-97PS)	Petrol	TD2865
XU51C (B1A)	4cyl.	1580cc	55-59kW (75-80PS)	Petrol	TD2857
205 I 1.6		08/86→10/87		309 I 1.6	10/85→07/89
205 II 1.6		10/87→09/98		405 II 1.6	08/92→05/97
305 1.6		11/82→12/88		406 1.6	11/95→05/04
305 II 1.6		10/82→12/88			

08-151200-00 STD	15-634910-00 WH ③ 14-634910-00 WH ④	B 88.00 C 141.00 D 97.00 E 95.13 B 88.00 C 141.00 D 97.00 E 95.13	89-151200-00 ③ 15-634910-00
A 37.55 B- 2.10 D 67.50 22x66	 1.75 CR P 1.75 P 4.00 CR ②		

- ① Piston available in Kit Set only ① Kolben nur im Assembly erhältlich ① Piston disponible en kit seulement ① Pistón disponible en conjuntos solamente. ① I pistoni sono disponibili solo in kit motore
- ② Steel ② Stahl ② Acier ② Acero ② Acciaio
- ③ Includes seals ③ Schließt Dichtungen ein ③ Inclut des joints ③ Incluye los sellos ③ Comprende le guarnizioni
- ④ Use also 1 NB O-Ring HR566 ④ Mitverwenden: 1 NB O-Ring HR566 ④ A utiliser aussi: 1 joint toriques HR566 ④ Utilizar también: 1 NB junta toricas HR566 ④ Usare anche: 1 NB O-Ring HR566

83.00				32	
XU5CP (BAZ)	4cyl.	1580cc	54-55kW (74-75PS)	Petrol	TD2859
XU5J (180)	4cyl.	1580cc	76kW (103PS)	Petrol	TD2862
XU5J (180A)	4cyl.	1580cc	76-77kW (104-105PS)	Petrol	TD2861
XU5J (B6B)	4cyl.	1580cc	76kW (103PS)	Petrol	TD2858
XU5M (BDZ)	4cyl.	1580cc	65-69kW (88-94PS)	Petrol	TD2839
XU5M2Z (BDY)	4cyl.	1580cc	65-71kW (88-97PS)	Petrol	TD4846
XU5M3Z (BDY)	4cyl.	1580cc	65-66kW (88-90PS)	Petrol	TD2864
XU7JB (LFX)	4cyl.	1762cc	66kW (90PS)	Petrol	TD12708
XU7JP (LFW)	4cyl.	1762cc	73kW (99PS)	Petrol	TD2867
XU7JP (LFZ)	4cyl.	1762cc	74-77kW (101-105PS)	Petrol	TD2866
XU7JP4 (LFY)	4cyl.	1762cc	76-86kW (103-117PS)	Petrol	TD4849
XU9J1 (DFZ)	4cyl.	1905cc	72-77kW (98-105PS)	Petrol	TD2870
XU9J2 (D6A)	4cyl.	1905cc	80-93kW (109-126PS)	Petrol	TD22159
XU9J4 (D6C/DFW)	4cyl.	1905cc	108-118kW (158-160PS)	Petrol	TD2873
XU9J4 (DFW)	4cyl.	1905cc	108kW (147PS)	Petrol	TD2875
XU9JA (D6B)	4cyl.	1905cc	94-96kW (128-131PS)	Petrol	TD2872
XU9JAZ (DKZ)	4cyl.	1905cc	88-93kW (120-126PS)	Petrol	TD2877
XU9M (DDZ)	4cyl.	1905cc	80kW (109PS)	Petrol	TD2878





XU9S (D2B)	4cyl.	1905cc	75kW (102PS)	Petrol	TD2772
XU51C (B1D)	4cyl.	1580cc	55-59kW (75-80PS)	Petrol	TD2762
XU51C (B1E)	4cyl.	1580cc	53-59kW (72-80PS)	Petrol	TD2856
XU52C/K (B2A)	4cyl.	1580cc	66-68kW (90-92PS)	Petrol	TD12430
XU92C	4cyl.	1905cc	75kW (102PS)	Petrol	TD2879
XU92C (D2A)	4cyl.	1905cc	75kW (102PS)	Petrol	TD2869
XU92C (D2C)	4cyl.	1905cc	70kW (95PS)	Petrol	TD2871

205 I 1.6	08/86→10/87	309 I 1.6 Cat	09/86→12/89
205 I 1.6 CJ	08/92→12/94	309 I 1.9	10/85→07/89
205 I 1.6 CTI	03/86→10/90	309 I 1.9 GTI	10/85→08/89
205 I 1.6 GTI	12/84→10/87	309 II 1.6	07/89→12/93
205 I 1.9	05/86→07/87	309 II 1.9	08/89→12/93
205 I 1.9 CTi	08/87→07/92	309 II 1.9 GTI	07/89→12/93
205 I 1.9 CTI	10/87→12/94	309 II 1.9 GTI 16V	08/89→12/93
205 I 1.9 GTI	10/86→10/87	405 I 1.6	01/87→12/92
205 II 1.6	10/87→09/98	405 I 1.6 SRi	04/88→07/92
205 II 1.6 GTI	10/87→12/89	405 I 1.9	06/87→12/93
205 II 1.9	08/90→05/97	405 I 1.9 MI-16	06/87→11/92
205 II 1.9 GTI	10/87→09/98	405 I 1.9 Sport MI-16	06/87→07/92
205 II 1.9 GTI Cat	10/87→07/94	405 II 1.6	08/92→05/97
305 II 1.6	11/86→12/88	405 II 1.8	08/92→11/99
305 II 1.9	10/82→12/88	405 II 1.9	01/92→11/97
306 1.8	01/93→12/02	406 1.8	10/96→10/04
306 1.8 8V	01/94→08/99	406 1.8 16V	11/95→10/00
306 1.8 16V	03/97→10/03	806 1.8	07/95→08/02
306 1.8 ST	06/94→05/01	EXPERT 1.8	10/96→09/00
309 I 1.6	10/85→07/89	PARTNER 1.8	03/97→12/02

15-634910-00 WH ① B 88.00 C 141.00 D 97.00 E 95.13
14-634910-00 WH ② B 88.00 C 141.00 D 97.00 E 95.13

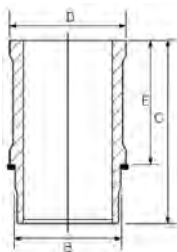

① Includes seals
 ② Use also 1 NB O-Ring HR566

① Schließt Dichtungen ein
 ② Mitverwenden: 1 NB O-Ring HR566

① Inclut des joints
 ② A utiliser aussi: 1 joint toriques HR566

① Incluye los sellos
 ② Utilizar también: 1 NB junta toricas HR566

① Comprende le guarnizioni
 ② Usare anche: 1 NB O-Ring HR566

83.00					33
XUD9	4cyl.	1905cc	47-52kW (64-71PS)	Diesel	TD8478
XUD9 (162)	4cyl.	1905cc	47-48kW (64-65PS)	Diesel	TD2886
XUD9 (D9A)	4cyl.	1905cc	47kW (64PS)	Diesel	TD2754
XUD9 (DJZ)	4cyl.	1905cc	47kW (64PS)	Diesel	TD2891
XUD9A (D9B)	4cyl.	1905cc	51-52kW (69-71PS)	Diesel	TD2834
XUD9A (D9B) (XUD9)	4cyl.	1905cc	51kW (70PS)	Diesel	TD2880
XUD9A (D9B/DJY)	4cyl.	1905cc	51kW (69PS)	Diesel	TD10827
XUD9A (DJY)	4cyl.	1905cc	47-52kW (64-71PS)	Diesel	TD2887

205 1.9 D	08/90→07/92	309 I 1.9 D	06/86→07/89
205 II 1.9 Diesel	08/87→09/98	309 II 1.9 Diesel	07/89→12/93
305 1.9 D	11/82→12/88	405 I 1.9 D	10/88→08/92
305 II 1.9 D	10/82→07/88	405 I 1.9 Diesel	03/88→12/92
305 II 1.9 Diesel	10/82→12/88	405 II 1.9 D	08/92→11/99
306 1.9 D	04/93→04/02	BOXER 1.9 D	03/94→04/02
306 1.9 SLD	06/94→05/01	EXPERT 1.9 D	02/96→12/98





306 1.9 STD	02/94→05/99	J5 1.9 D	09/87→03/94
306 1.9 Td	07/95→08/00	PARTNER 1.9 D	05/96→12/02
309 1.9 D	10/85→10/93		

87-152000-10 STD
87-152007-10 0.50mm
87-152010-10 0.80mm

A 46.80
B- 2.20
D 84.30
 25x72



08-152000-00 STD
08-152003-00 0.125mm
08-152007-00 0.50mm
08-152010-00 0.80mm

2.00  CR P
 2.00  P
 3.00  CR P

14-020530-00 D **B** 85.60 **C** 153.50 **D** 88.50 **E** 3.90

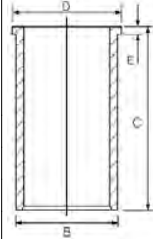

83.00 **34**

XUD9BSD (DHV) (XUD9)	4cyl.	1905cc	55kW (75PS)	Diesel	Turbo	TD9867
XUD9SD (DHW)	4cyl.	1905cc	55kW (75PS)	Diesel	Turbo Intercooled	TD9365
XUD9TE	4cyl.	1905cc	66-69kW (90-94PS)	Diesel	Turbo Intercooled	TD18953
XUD9TE (D8B)	4cyl.	1905cc	68-69kW (92-94PS)	Diesel	Turbo Intercooled	TD2751
XUD9TE (DHX)	4cyl.	1905cc	66-68kW (90-92PS)	Diesel	Turbo Intercooled	TD2889
XUD9TE (DHY)	4cyl.	1905cc	66-69kW (90-93PS)	Diesel	Turbo Intercooled	TD2888
XUD9UTF (D8C)	4cyl.	1905cc	68kW (92PS)	Diesel	Turbo	TD2890

306 1.9 D	02/94→04/02	406 1.9 TD	10/95→10/04
306 1.9 DT	05/93→05/01	806 1.9 TD	07/95→08/02
306 1.9 SRDT	06/94→05/01	806 TD	07/95→08/02
306 1.9 TD	02/97→04/02	BOXER 1.9 DT	03/96→09/98
405 II 1.9 TD	08/92→05/97	BOXER 1.9 TD	03/94→04/02
406 1.9 D	10/96→10/04	EXPERT 1.9 TD	02/96→09/00

87-105500-00 STD
87-105507-00 0.50mm

A 46.75
B- 3.50
D 75.00
 28x68
AK HA RT TP



08-105500-00 STD
08-105507-00 0.50mm

3.00  CK
 2.00  NT
 3.00  CR P

14-020530-00 D **B** 85.60 **C** 153.50 **D** 88.50 **E** 3.90

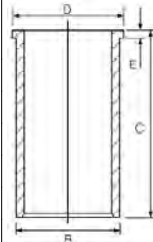

84.00 **35**

DT20C (Euro 5)	V6cyl.	2993cc	177kW (241PS)	Diesel	Bi-Turbo Intercooled	TD23527
407 3.0 HDi			06/09→			





87-439100-10 STD ① ②
87-439107-10 0.50mm ① ②

A 46.00
B- 15.35
BØ 47.62
D 70.00
 30x63
 (0849D-408A)
AK KK RT TP



08-439100-10 STD ③
08-439107-10 0.50mm ③

1.75  GDC P
 1.75  P
 2.00  CR P



ECOTOUGH

① Gen 2 piston can be retrofitted in Gen 1 engines

① Kolben der 2. Generation können in Motoren der 1. Generation nachgerüstet werden

① Les pistons de 2ème génération peuvent être montés sur des moteurs de 1ème génération

① El pistón de la segunda generación se puede montar en los motores de primera generación

① il pistone di seconda generazione può essere montato nei motori di prima generazione

② Euro 6

③ For Gen 2 engines

③ Für Motoren der 2. Generation

③ Pour moteurs de 2ème génération

③ Para motores de segunda generación

③ Per i motori di seconda generazione

85.00						36
DW10CB (RHD)	4cyl.	1997cc	100kW (136PS)	Diesel	Turbo Intercooled	TD34980
DW10 C HYBRID (RHC) (Euro 5)	4cyl.	1997cc	120-147kW (163-200PS)	Diesel	Turbo Intercooled	TD28710
DW10CTED4 (RHA)	4cyl.	1997cc	103kW (140PS)	Diesel	Turbo Intercooled	TD35531
DW10CTED4 (RHD)	4cyl.	1997cc	100kW (136PS)	Diesel	Turbo Intercooled	TD31482
DW10CTED4 (RHE) (Euro 5)	4cyl.	1997cc	100-110kW (136-150PS)	Diesel	Turbo Intercooled	TD25633
DW10CTED4 (RHH) (Euro 5)	4cyl.	1997cc	120kW (163PS)	Diesel	Turbo Intercooled	TD23536
308 CC 2.0 HDi			06/09→12/14	3008 HDi		06/09→08/16
308 I 2.0 HDi			10/11→10/14	3008 HDi 150		06/09→08/16
308 SW I 2.0 HDi			06/09→10/14	5008 2.0 HDi		09/09→03/17
407 2.0 HDi			06/09→	5008 2.0 HDi 136 / 136		02/12→03/17
407 SW 2.0 HDi			06/09→12/10	5008 2.0 HDi 150		06/09→03/17
508 I 2.0 HDi			11/10→12/18	5008 I HDi 136		02/12→03/17
508 SW 2.0 HDi			03/13→12/18	5008 I HDi 150		06/09→03/17
508 SW I 2.0 HDi			11/10→12/18	5008 I HDi 165		06/09→03/17
508 SW I 2.0 HDi RXH			11/10→12/18	EXPERT 2.0 HDi 165		09/09→
807 2.0 HDi			06/09→	EXPERT TEPEE 2.0 HDi 165		09/09→
3008 2.0 HDi			06/09→08/16	RCZ 2.0 HDi		03/10→12/15
3008 2.0 HDi 150			06/09→08/16			

87-443100-00 STD ①
87-443108-00 0.60mm ①

A 46.70
B- 13.71
BØ 50.40
C 0.45
D 74.71
 30x68
 (0850H-228)
AK KK RT TP



08-443100-00 STD
08-443108-00 0.60mm

2.00  GDC P
 2.00  P
 2.00  CR P



① Bowl capacity 26.32cm³

① Volumen der Kolbenmulde 26.32cm³

① Volume de la cavité du piston 26.32cm³

① Vol. cavidad pistón 26.32cm³

① Volume camera pistone 26.32cm³

85.00						37
DW10ATED (RHS)	4cyl.	1997cc	79kW (107PS)	Diesel	Turbo Intercooled	TD20417
DW10ATED (RHZ)	4cyl.	1997cc	79-80kW (107-109PS)	Diesel	Turbo Intercooled	TD10727
DW10BTED (RHX)	4cyl.	1997cc	69kW (94PS)	Diesel	Turbo Intercooled	TD17515
DW10BTED (RHZ)	4cyl.	1997cc	80kW (109PS)	Diesel	Turbo Intercooled	TD29311
DW10BTED+ (RHZ)	4cyl.	1997cc	80kW (109PS)	Diesel	Turbo Intercooled	TD33721
DW10CTED (RHZ)	4cyl.	1997cc	80kW (109PS)	Diesel	Turbo Intercooled	TD30833





DW10TD (RHV)	4cyl.	1997cc	62kW (84PS)	Diesel	Turbo Intercooled	TD24911
DW10TD (RHY)	4cyl.	1997cc	66kW (90PS)	Diesel	Turbo Intercooled	TD12569
DW10UTD (RHV)	4cyl.	1997cc	62kW (84PS)	Diesel	Turbo Intercooled	TD17512
206 2.0 HDi			07/02→02/07	406 2.0 HDi 110		06/98→04/04
206 2.0 HDi 90			12/99→09/09	406 2.0 HDi 110		08/01→10/04
207 2.0 HDi			12/07→12/12	607 2.0 HDi		05/00→09/05
207 SW 2.0 HDi			10/08→12/12	607 2.0 HDi		03/01→09/04
306 2.0 HDi			08/98→06/00	806 2.0 HDi		08/99→08/02
306 2.0 HDi 90			06/99→12/02	806 HDi		06/99→02/03
307 2.0 HDi			09/06→03/12	BOXER 2.0 HDi		12/01→06/06
307 2.0 HDi 90			03/02→04/08	BOXER 2.0 HDi		08/01→04/02
307 2.0 HDi 90			08/00→03/07	EXPERT 2.0 HDi		07/00→12/06
307 2.0 HDi 110			03/02→12/09	EXPERT 2.0 HDi		10/00→10/06
307 2.0 HDi 110			08/00→03/07	PARTNER 2.0 HDi		04/00→07/08
307 SW 2.0 HDi			01/03→12/09	PARTNER 2.0 HDi		02/00→07/08
406 2.0 HDi 90			02/99→10/04			

87-114700-00 STD

87-114708-00 0.60mm

A 46.75
B- 18.30
BØ 38.00
C 1.00
D 80.75
28x70



AK RT TP

08-114700-00 STD

08-114708-00 0.60mm

3.50 CK P
2.00 P
3.00 CR P



85.00

38

DW10ATED4 (RHM)	4cyl.	1997cc	79kW (107PS)	Diesel	Turbo Intercooled	TD20790
DW10ATED4 (RHT)	4cyl.	1997cc	79-80kW (107-109PS)	Diesel	Turbo Intercooled	TD20789
DW10ATED4 (RHV)	4cyl.	1997cc	79-80kW (107-109PS)	Diesel	Turbo Intercooled	TD17510
806 2.0 HDi 16V			08/99→08/02	EXPERT 2.0 HDi		10/00→10/06
807 2.0 HDi			06/02→	EXPERT 2.0 HDi 16V		07/00→12/06
EXPERT 2.0 HDi			07/00→12/06			

87-114700-10 STD

87-114708-10 0.60mm

A 46.73
B- 18.80
BØ 39.80
C 1.67
D 72.70
28x68



(08517-103)

AK KK RT TP

08-114700-00 STD

08-114708-00 0.60mm

3.50 CK P
2.00 P
3.00 CR P



85.00

39

DW10BTED4 (RHF)	4cyl.	1997cc	103kW (140PS)	Diesel	Turbo Intercooled	TD26794
DW10BTED4 (RHR)	4cyl.	1997cc	100-103kW (136-140PS)	Diesel	Turbo Intercooled	TD17507
DW10UTED4 (RHK) (Euro 4)	4cyl.	1997cc	79-88kW (107-120PS)	Diesel	Turbo Intercooled	TD19814
307 2.0 HDi 135			10/03→04/09	508 SW 2.0 HDi		03/13→12/18
307 SW 2.0 HDi			04/04→11/07	508 SW I 2.0 HDi		11/10→12/18
308 CC 2.0 HDi			04/09→12/14	607 2.0 HDi		09/05→07/11
308 I 2.0 HDi			09/07→10/14	807 2.0 HDi		06/06→
308 SW I 2.0 HDi			09/07→10/14	807 2.0 HDi		02/06→





407 2.0 HDi	10/05→	EXPERT 2.0 HDi 120	01/07→
407 2.0 HDi 135	05/04→12/10	EXPERT 2.0 HDi 140	01/07→
407 SW 2.0 HDi	06/09→12/10	EXPERT TEPEE 2.0 HDi 120	01/07→03/16
508 I 2.0 HDi	11/10→12/18	EXPERT TEPEE 2.0 HDi 140	01/07→

87-114700-40 STD
87-114708-40 0.60mm

08-114700-00 STD
08-114708-00 0.60mm

A 46.70
B- 15.40
BØ 44.80
C 0.57
D 72.71
 28x70





3.50  CK P
2.00  P
3.00  CR P

(08570-109)
AK KK RT TP

85.00 **40**

DW10FC (AHW)	4cyl.	1997cc	132-133kW (179-181PS)	Diesel	Turbo Intercooled	TD30806
DW10FD (AHV)	4cyl.	1997cc	100kW (136PS)	Diesel	Turbo Intercooled	TD31484
DW10FD (AHX) (Euro 5)	4cyl.	1997cc	100-110kW (136-150PS)	Diesel	Turbo Intercooled	TD28614

308 II 2.0	11/13→06/21	3008 2.0 136	11/16→
308 II 2.0 GT	06/14→06/21	3008 2.0 HDi 150	06/09→08/16
308 SW II 2.0 GT	06/17→06/21	5008 2.0 HDi 136 / 136	02/12→03/17
308 SW II 2.0 GT HDi 180 /	06/14→06/21	5008 2.0 HDi 150	06/09→03/17
508 I 2.0	04/14→12/18	5008 II 2.0	12/16→
508 I 2.0 HDi	11/10→12/18	5008 II 2.0 136	12/16→
508 SW I 2.0	04/14→12/18	EXPERT 2.0	04/16→
508 SW I 2.0 HDi	11/10→12/18	TRAVELLER 2.0	04/16→
3008 2.0	05/16→		

87-443100-10 STD 
87-443108-10 0.60mm 

08-443100-00 STD
08-443108-00 0.60mm

A 46.60
B- 12.71
B- 4.90
BØ 51.30
D 72.00
 30x72



2.00  GDC P
2.00  P
2.00  CR P



AK KK RT TP

 Bowl capacity 23.18cm³

 Volumen der Kolbenmulde 23.18cm³

 Volume de la cavité du piston 23.18cm³

 Vol. cavidad pistón 23.18cm³

 Volume camera pistone 23.18cm³

85.00 **41**

DW12BTED4 (4HP)	4cyl.	2179cc	120kW (163PS)	Diesel	Turbo Intercooled	TD24729
DW12BTED4 (4HR)	4cyl.	2179cc	120kW (163PS)	Diesel	Turbo Intercooled	TD24914
DW12BTED4 (4HS) (Euro 4)	4cyl.	2179cc	125kW (170PS)	Diesel	Turbo Intercooled	TD24915
DW12BTED4 (4HT) (Euro 4)	4cyl.	2179cc	125kW (170PS)	Diesel	Turbo Intercooled	TD20028
DW12MTED4 (4HK)	4cyl.	2179cc	115kW (156PS)	Diesel	Turbo Intercooled	TD24916
DW12MTED4 (4HN)	4cyl.	2179cc	115kW (156PS)	Diesel	Turbo Intercooled	TD24727

407 2.2 HDi	03/06→12/10	807 2.2 HDi	06/06→
407 2.2 HDi 170	03/06→12/10	4007 2.2 HDi	02/07→03/13
607 2.2 HDi	05/06→06/10	4007 HDi 155	02/07→03/13





87-436700-10 STD
87-436708-10 0.60mm

A 48.70
B- 13.47
BØ 52.40
C 0.38
D 74.71
 30x68
 (0850HA127)
AK KK RT TP



08-436700-00 STD
08-436708-00 0.60mm

2.50 GDC P
 2.00 P
 2.00 CK



For pistons with a 24.3mm rod gap measured at pin centre line

Für Kolben mit einem Pleuelaugenabstand von 24,3 MM, gemessen an der Kolbenbolzen-Mitte

Pour pistons avec un écart de bielle de 24,3 mm mesuré au centre de l'axe bielle-piston

Para pistones con una distancia de paso de biela en el centro del bulón de 24,3mm

Per pistoni con passaggio biella di 24,3 mm misurato sull'asse foro spinotto

85.00

42

DW12C (4HL) (Euro 5)	4cyl.	2179cc	147-150kW (200-204PS)	Diesel	Turbo Intercooled	TD24921
508 I 2.2 HDi			11/10→12/18	508 SW I 2.2 HDi		11/10→12/18
508 SW 2.2 HDi			11/11→			

87-436700-00 STD
87-436708-00 0.60mm

A 48.60
B- 15.12
BØ 50.40
C 0.38
D 74.61
 30x68
 (0850HA324)
AK KK RT TP



08-436700-00 STD
08-436708-00 0.60mm

2.50 GDC P
 2.00 P
 2.00 CK



For pistons with a 24.3mm rod gap measured at pin centre line

Für Kolben mit einem Pleuelaugenabstand von 24,3 MM, gemessen an der Kolbenbolzen-Mitte

Pour pistons avec un écart de bielle de 24,3 mm mesuré au centre de l'axe bielle-piston

Para pistones con una distancia de paso de biela en el centro del bulón de 24,3mm

Per pistoni con passaggio biella di 24,3 mm misurato sull'asse foro spinotto

85.00

43

DW12TED4 (4HX/4HW)	4cyl.	2179cc	98kW (133PS)	Diesel	Turbo Intercooled	TD16128
DW12TED4 (4HZ)	4cyl.	2179cc	100kW (136PS)	Diesel	Turbo Intercooled	TD24912
406 2.2 HDi			03/00→10/04	607 2.2 HDi		02/00→02/06
406 2.2 HDi			03/00→12/04			

87-114700-30 STD

A 48.70
B- 18.00
BØ 40.80
C 0.40
C 0.40
D 77.70
 30x68
AK KK RT



08-114700-00 STD
08-114708-00 0.60mm

3.50 CK P
 2.00 P
 3.00 CR P

86.00

44

P22DTE (4HG) (Euro 4)	4cyl.	2198cc	81kW (110PS)	Diesel	Turbo Intercooled	TD32317
P22DTE (4HH) (Euro 4)	4cyl.	2198cc	96kW (130PS)	Diesel	Turbo Intercooled	TD32520
P22DTE (4HJ) (Euro 4)	4cyl.	2198cc	110kW (150PS)	Diesel	Turbo Intercooled	TD32316
BOXER 2.2 HDi 110			03/11→	BOXER 2.2 HDi 150		03/11→
BOXER 2.2 HDi 130			03/11→			





87-427700-50 STD ①
87-427707-50 0.50mm ①

A 48.42
B- 16.17
BØ 49.04
D 74.82
 30x67
 (08683-607)
AK KK RT TP



08-427700-00 STD
08-427705-00 0.25mm
08-427707-00 0.50mm

2.00  CK P
 2.00  P
 2.00  NT ②

① *** CAUTION - CHECK BOWL DIAMETER *** ① *** ACHTUNG - MULDENDURCHMESSER ÜBERPRÜFEN *** ① ** Attention & veuillez vérifier le diamètre du bol** ① ** Precaución - verifica el diámetro del bulón ** ① ** attenzione & controllate diametro camera di combustione **
 ② Steel ② Stahl ② Acier ② Acero ② Acciaio

86.00 **45**

P22DTE (4HU) (Euro 4)	4cyl.	2198cc	88kW (120PS)	Diesel	Turbo Intercooled	TD24470
BOXER 2.2 HDi 120		04/06→				

87-427700-10 STD
87-427707-10 0.50mm

A 43.42
B- 15.85
BØ 46.90
D 69.82
 30x67
 (8648B105)
KK RT TP



08-427700-00 STD
08-427705-00 0.25mm
08-427707-00 0.50mm

2.00  CK P
 2.00  P
 2.00  NT ①

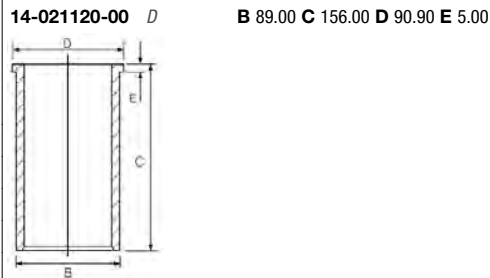

① Steel ① Stahl ① Acier ① Acero ① Acciaio

86.00 **46**

P22DTE (4HV) (Euro 4)	4cyl.	2198cc	74kW (101PS)	Diesel	Turbo Intercooled	TD24469
BOXER 2.2 HDi 100		04/06→				

87-427700-30 STD
87-427707-30 0.50mm

A 43.42
B- 15.85
BØ 46.90
D 69.82
 30x67
 (08650A105)
RT TP



08-427700-00 STD
08-427705-00 0.25mm
08-427707-00 0.50mm

2.00  CK P
 2.00  P
 2.00  NT ①

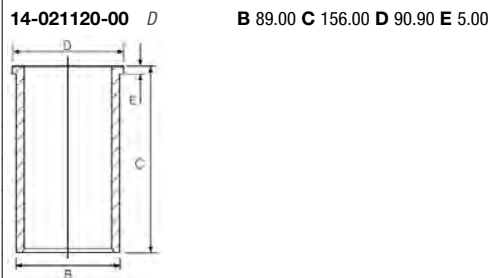

① Steel ① Stahl ① Acier ① Acero ① Acciaio

88.00 **47**







XN1	4cyl.	1971cc	64-79kW (87-107PS)	Petrol	TD2833
XN1 (106)	4cyl.	1971cc	68-71kW (93-97PS)	Petrol	TD2830
XN1P	4cyl.	1971cc	57kW (78PS)	Petrol	TD8502
XN1T	4cyl.	1971cc	55-63kW (75-86PS)	Petrol	TD22486
XN1T (170)	4cyl.	1971cc	58kW (79PS)	Petrol	TD2837
XN1T (170B)	4cyl.	1971cc	55kW (75PS)	Petrol	TD2836
XN1TA	4cyl.	1971cc	62-72kW (84-98PS)	Petrol	TD8490
XN2 (107)	4cyl.	1971cc	75-78kW (102-106PS)	Petrol	TD2831









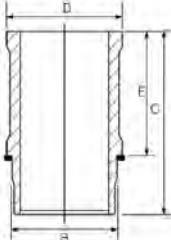



504 2.0 03/71→05/95 J5 2.0 09/81→01/94





504 2.0 TI	01/71→06/83	J5 2.0 Super	09/81→08/90
505 2.0	05/79→12/85	J9 2.0	03/80→06/87

A 38.25 B+ 0.65 D 71.85  23x74		08-316900-00 STD 08-316907-00 0.50mm	14-636500-00 WH	B 93.00 C 135.70 D 101.90 E 89.98	89-316900-00  14-636500-00
		1.50  CR P 2.00  P 4.00  CR 			

- | | | | | |
|--|---|--|---|---|
|  Piston available in Kit Set only |  Kolben nur im Assembly erhältlich |  Piston disponible en kit seulement |  Pistón disponible en conjuntos solamente. |  I pistoni sono disponibili solo in kit motore |
|  Steel |  Stahl |  Acier |  Acero |  Acciaio |
|  Includes seals |  Schließt Dichtungen ein |  Inclut des joints |  Incluye los sellos |  Comprende le guarnizioni |

 88.00	48
--	-----------

XN1A (106E)	4cyl.	1971cc	72kW (98PS)	Petrol	TD4845
XN1TA (170C)	4cyl.	1971cc	62kW (85PS)	Petrol	TD6804

505 2.0	09/85→09/95		
---------	-------------	--	--

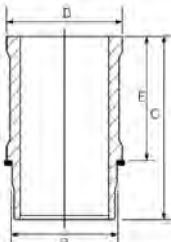



		14-636500-00 WH	B 93.00 C 135.70 D 101.90 E 89.98	
				

 88.00	49
--	-----------

XD 4.88	4cyl.	1948cc	40-41kW (54-56PS)	Diesel	TD2807
XD88	4cyl.	1948cc	44kW (60PS)	Diesel	TD23802
XDP 4.88 (Indenor XDP)	4cyl.	1946cc	36-46kW (49-63PS)	Diesel	TD22477
XDP 88 (Indenor XDP)	4cyl.	1946cc	40kW (55PS)	Diesel	TD8499

504 1.9 D	03/73→12/89	J7 1.9 D	08/68→07/78
-----------	-------------	----------	-------------

		14-600420-00 WH 	B 96.00 C 173.00 D 106.30 E 129.00	
				

- | | | | | |
|--|---|---|---|---|
|  Use also HT022 |  Mitverwenden: HT022 |  A utiliser aussi: HT022 |  Utilizar también: HT022 |  Usare anche HT022 |
|--|---|---|---|---|

 90.00	50
--	-----------

XD90	4cyl.	2112cc	48-49kW (65-67PS)	Diesel	TD2808
XDP 4.90 (Indenor XDP)	4cyl.	2112cc	43-55kW (58-75PS)	Diesel	TD21440
XDP 6.90 (Indenor XDP)	6cyl.	3168cc	78kW (106PS)	Diesel	TD22478
XDP 90 (Indenor XDP)	4cyl.	2112cc	42kW (57PS)	Diesel	TD8500

504 2.1 D	02/71→07/86	J7 2.1 D	08/68→07/77
-----------	-------------	----------	-------------





14-604060-00 WH B 96.00 C 173.00 D 106.30 E 129.00

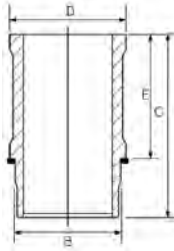

92.00 **51**

DJ5 (T9A)	4cyl.	2446cc	63kW (86PS)	Diesel	TD4830
BOXER 2.5 D		03/94→04/02			

87-112400-00 STD
87-112407-00 0.50mm

08-112400-00 STD
08-112407-00 0.50mm

A 49.90
 B- 3.00
 D 80.00
 34x58



2.25  CK P
 2.00  P
 2.00  CR P

AK TP



92.00 **52**

DJ5T (T8A/THZ)	4cyl.	2446cc	76kW (103PS)	Diesel	Turbo Intercooled	TD4831
DK5ATE (THY)	4cyl.	2446cc	95kW (129PS)	Diesel	Turbo Intercooled	TD2748
605 2.5 Turbo Diesel		07/94→09/99		BOXER 2.5 TD		03/94→04/02

87-326300-00 STD
87-326307-00 0.50mm 

08-326300-00 STD
08-326307-00 0.50mm

A 49.84
 B- 2.30
 D 82.00
 34x68



3.00  PS P
 1.75  CR P
 3.50  CR P

AK HA KK RT TP



 A = 49.470, B = 81.600

93.00 **53**

CRD93	4cyl.	2500cc	54kW (73PS)	Diesel		TD21168
CRD93L	4cyl.	2500cc	70kW (95PS)	Diesel	Turbo	TD18876
PSA (CRD93)	4cyl.	2500cc	54kW (73PS)	Diesel		TD2747
J5 2.5 D		09/81→03/94		J5 2.5 DT		09/81→01/94





87-152700-00 STD
87-152707-00 0.50mm

A 52.75
B- 7.30
D 87.75
 30x78



08-152700-00 STD
08-152707-00 0.50mm

2.50 MOL P
 2.00 P
 4.00 CR P



14-013481-00 D

B 96.10 **C** 163.00

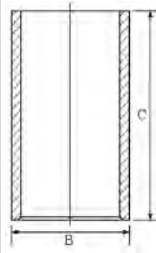

93.00

54

U25/673 (CRD93LS)	4cyl.	2500cc	70kW (95PS)	Diesel	Turbo	TD4829
J5 2.5 DT			09/81→08/90	J5 2.5 TD		10/90→03/94

14-013481-00 D

B 96.10 **C** 163.00

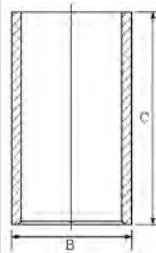

94.00

55

EN 55	4cyl.	2498cc	53-56kW (72-76PS)	Diesel	TD6685
XD3 (155)	4cyl.	2498cc	51-55kW (70-75PS)	Diesel	TD2803
XD3P	4cyl.	2497cc	53-55kW (72-75PS)	Diesel	TD8505
504 2.5 D			08/90→10/99	J9 2.5 D	
505 2.5 Diesel			06/81→12/93		07/82→06/87

87-318700-10 STD
87-318706-10 0.40mm
 →12/93

A 54.00
B- 1.80
D 96.42
 30x79



08-318700-10 STD
08-318706-10 0.40mm
08-318708-10 0.60mm
08-318711-10 1.00mm

2.00 CR P
 2.00 P
 4.00 CR P



14-020660-00 D

B 97.00 **C** 170.60 **D** 99.50 **E** 4.00

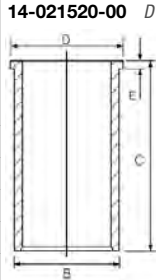

14-021520-00 D

B 98.00 **C** 170.60 **D** 100.00 **E** 6.00

87-318700-30 STD
87-318710-30 0.80mm
 01/94→

A 54.00
B- 1.75
D 91.42
 30x79



08-318700-10 STD
08-318706-10 0.40mm
08-318708-10 0.60mm
08-318711-10 1.00mm

2.00 CR P
 2.00 P
 4.00 CR P





94.00						56
ET70	4cyl.	2496cc	71kW (96PS)	Diesel	Turbo	TD6686
XD2	4cyl.	2304cc	51kW (69PS)	Diesel		TD22473
XD2S	4cyl.	2304cc	59kW (80PS)	Diesel	Turbo	TD22474
XD2S (147)	4cyl.	2304cc	59kW (80PS)	Diesel	Turbo	TD2802
XD3T	4cyl.	2497cc	70kW (95PS)	Diesel	Turbo Intercooled	TD22475
XD3T (152A)	4cyl.	2498cc	66kW (90PS)	Diesel	Turbo	TD2805
XD3TE	4cyl.	2498cc	81kW (110PS)	Diesel	Turbo Intercooled	TD22476
XD3TE (152B)	4cyl.	2498cc	77kW (105PS)	Diesel	Turbo Intercooled	TD2806
505 2.3 D			05/79→09/84	505 2.5 Turbo Diesel		10/83→12/93
505 2.3 Diesel			04/82→06/86	604 2.3 TD		09/79→05/83
505 2.3 Turbo Diesel			09/80→06/86	604 2.5 TD		08/83→12/86
505 2.5 D			10/85→08/91			

14-020660-00 D B 97.00 C 170.60 D 99.50 E 4.00
 14-021520-00 D B 98.00 C 170.60 D 100.00 E 6.00

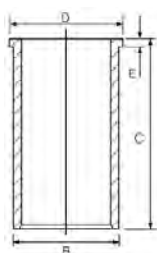



94.00						57
XD2 (134)	4cyl.	2304cc	51kW (69PS)	Diesel		TD2800
XD2P / XD94	4cyl.	2304cc	49kW (67PS)	Diesel		TD8504
504 2.3 D			07/75→12/89	J9 2.3 D		03/80→07/82

87-318700-00 STD
 87-318706-00 0.40mm
 87-318708-00 0.60mm
 87-318711-00 1.00mm

08-318700-10 STD
 08-318706-10 0.40mm
 08-318708-10 0.60mm
 08-318711-10 1.00mm

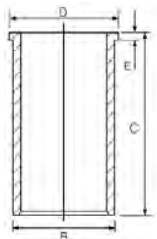
14-020660-00 D B 97.00 C 170.60 D 99.50 E 4.00
 14-021520-00 D B 98.00 C 170.60 D 100.00 E 6.00



A 57.42
 B- 2.00
 D 99.90
 30x79



2.00  CR P
 2.00  P
 4.00  CR P

Pistons to be replaced in Engine Sets only Kolben nur in Motorsätzen zu ersetzen Piston à remplacer dans jeu moteur Pistones de repuesto para juegos de motores solamente Il pistone può essere rimpiazzato solamente completo

94.40						58
8140.43N (Euro 3 Sofim)	4cyl.	2800cc	107kW (146PS)	Diesel	Turbo Intercooled	TD24923
F28DTCR (8140.43S) (Euro 3 Sofim)	4cyl.	2800cc	92-94kW (125-128PS)	Diesel	Turbo Intercooled	TD17514
BOXER 2.8 HDi			10/00→09/09	BOXER 2.8 HDi		11/00→04/02





87-122200-00 STD
87-122208-00 0.60mm

A 58.70
B- 21.30
BØ 39.40
D 87.60
 32x72



AK KK RT TP

08-122200-00 STD
08-122208-00 0.60mm

2.50 CK P
 2.00 P
 2.50 CR P

14-021321-00 D
14-028930-00 D
14-028931-00 D
14-028932-00 D

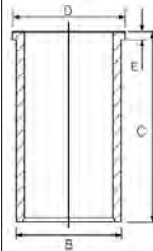

B 97.54 **C** 167.00 **D** 100.90 **E** 5.00
B 97.50 **C** 167.00 **D** 100.90 **E** 5.00
B 97.58 **C** 167.00 **D** 100.90 **E** 5.00
B 97.70 **C** 167.00 **D** 100.90 **E** 5.00

94.40

59

F28D (8140.63) (Euro 2 Sofim)	4cyl.	2800cc	64kW (87PS)	Diesel	TD24917
BOXER 2.8 D		01/99→02/02			

87-108200-00 STD
87-108208-00 0.60mm

A 55.00
B- 2.80
D 90.00
 32x68



AK HA RT TP

08-108200-00 STD
08-108208-00 0.60mm

3.00 CR P
 2.00 P
 2.50 CR P

14-021321-00 D
14-028930-00 D
14-028931-00 D
14-028932-00 D

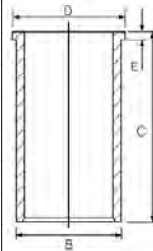

B 97.54 **C** 167.00 **D** 100.90 **E** 5.00
B 97.50 **C** 167.00 **D** 100.90 **E** 5.00
B 97.58 **C** 167.00 **D** 100.90 **E** 5.00
B 97.70 **C** 167.00 **D** 100.90 **E** 5.00

95.80

60

F30DT (F1CE0481D) (Euro 4)	4cyl.	2999cc	115-130kW (156-177PS)	Diesel	Turbo Intercooled	TD29257
F30DTE (F1CE0481D) (Euro 4)	4cyl.	2999cc	115-130kW (156-177PS)	Diesel	Turbo Intercooled	TD33863
FG30DT (F1CE0481D) (Euro 4)	4cyl.	2999cc	116kW (158PS)	Diesel	Turbo Intercooled	TD24697
BOXER 3.0 HDi		04/06→		BOXER 3.0 HDi 160		04/06→

87-421600-00 STD

A 63.00
B- 16.00
BØ 50.50
D 93.50
 36x80



AK KK RT TP

08-421600-00 STD
08-421606-00 0.40mm

2.50 CK P
 2.00 P
 2.50 CR P

95.80

61

F30DTE (F1CE3481E) (Euro 5)	4cyl.	2999cc	130kW (177PS)	Diesel	Turbo Intercooled	TD33860
F30DTE (F1CE3481N) (Euro 5)	4cyl.	2999cc	107kW (146PS)	Diesel	Turbo Intercooled	TD33862
BOXER 3.0 HDi 145		04/10→		BOXER 3.0 HDi 175		03/11→







87-421600-10 STD

- A 63.00
- B- 16.00
- BØ 53.20
- D 93.40
-  36x80



AK KK RT TP

08-421600-10 STD

- 2.50  GDC P
- 2.00  P
- 2.50  CK P





CCM



9

129	Petrol	1218	4	75.00	8
670.800	Petrol	845	4	58.00	1
688 02	Petrol	1108	4	70.00	4
688 03	Petrol	1108	4	70.00	4
688 10	Petrol	1108	4	70.00	4
688 711	Petrol	1108	4	70.00	4
688 712	Petrol	1108	4	70.00	4
688 713	Petrol	1108	4	70.00	4
688.11	Petrol	1108	4	70.00	4
712-01-03	Diesel	3320	4	98.00	45
712-01-04	Diesel	3320	4	98.00	45
714	Diesel	3320	4	98.00	45
720-12	Diesel	3590	4	102.00	46
797-20	Diesel	5491	6	102.00	49
797-21	Diesel	5491	6	102.00	49
797-26	Diesel	5491	6	102.00	49
798-10	Diesel	5491	6	102.00	50
798-20	Diesel	5491	6	102.00	50
800 01	Petrol	845	4	58.00	1
800 05	Petrol	845	4	58.00	1
800 705	Petrol	845	4	58.00	1
800 710	Petrol	845	4	58.00	1
800.02	Petrol	845	4	58.00	1
847 700	Petrol	1397	4	76.00	10
847 701	Petrol	1397	4	76.00	10
847 712	Petrol	1397	4	76.00	10
847 720	Petrol	1397	4	76.00	10
8140-07 (Sofim)	Diesel	2500	4	93.00	36
8140-27 IDS	Diesel	2500	4	93.00	36
8140-47	Diesel	2500	4	93.00	39
8140.27 (Sofim)	Diesel	2500	4	93.00	38
8140.43N.3585 (Euro 3 Sofim)	Diesel	2800	4	94.40	43
8140.07.2530	Diesel	2500	4	93.00	36
8140.07.2585 (Euro 1)	Diesel	2500	4	93.00	36
8140.07.2700	Diesel	2500	4	93.00	36
8140.07.2701 (Sofim)	Diesel	2500	4	93.00	36
8140.07.2710 (Sofim)	Diesel	2500	4	93.00	36
8140.07.3700 (Euro 1)	Diesel	2500	4	93.00	36
8140.21.235 (SOFIM 2.4TD)	Diesel	2445	4	93.00	37
8140.23.2585 (Euro 2 Sofim)	Diesel	2800	4	94.40	41
8140.27.2560	Diesel	2500	4	93.00	39
8140.27.2565 (Sofim)	Diesel	2500	4	93.00	36
8140.27.2582	Diesel	2500	4	93.00	38
8140.27.2585	Diesel	2500	4	93.00	36
8140.27.2700	Diesel	2500	4	93.00	38
8140.43.2585 (Euro 2 Sofim)	Diesel	2800	4	94.40	41
8140.43.3700 (Euro 2 Sofim)	Diesel	2800	4	94.40	41
8140.43.C.2586 (Euro 2 Sofim)	Diesel	2800	4	94.40	41
8140.43.C.3586 (Euro 3 Sofim)	Diesel	2800	4	94.40	42
8140.43.C.3588 (Euro 3 Sofim)	Diesel	2800	4	94.40	42
8140.43.S.2585 (Euro 3 Sofim)	Diesel	2800	4	94.40	43
8140.43.S.3585 (Euro 3 Sofim)	Diesel	2800	4	94.40	43
8140.47.2530 IDR (Sofim)	Diesel	2500	4	93.00	39
8140.47.2535	Diesel	2500	4	93.00	39
8140.47.2585 (Euro 1)	Diesel	2500	4	93.00	39
8140.47.2590 (Euro 1)	Diesel	2500	4	93.00	39
8140.47.2700 (Euro 1)	Diesel	2500	4	93.00	39
8140.47.2721 (Euro 1)	Diesel	2500	4	93.00	39
8140.47.2785 (Euro 1)	Diesel	2500	4	93.00	39
8140.61.2300	Diesel	2445	4	93.00	40

ENGINE INDEX

Motorverzeichnis • Index de moteur • Índice de Motor
 Indeks silnika • Модель Двигателя • دليل المحرك

CCM

9

8140.61.235	Diesel	2445	4	93.00	40
8140.61.240 (Sofim)	Diesel	2445	4	93.00	40
8140.63.2585 (Euro 2 Sofim)	Diesel	2800	4	94.40	44
8140.67.2500	Diesel	2500	4	93.00	40
8140.67.2550	Diesel	2500	4	93.00	40
8140.67.2580 (Euro 2)	Diesel	2500	4	93.00	36
8140.67.2585 (Euro 2)	Diesel	2500	4	93.00	36
B1B 707	Petrol	845	4	58.00	1
C1E (688.01)	Petrol	1108	4	70.00	4
C1E 700	Petrol	1108	4	70.00	4
C1E 715	Petrol	1108	4	70.00	4
C1E 750	Petrol	1108	4	70.00	4
C1E 752	Petrol	1108	4	70.00	4
C1E 754	Petrol	1108	4	70.00	4
C1E 756	Petrol	1108	4	70.00	4
C1E 760	Petrol	1108	4	70.00	4
C1E 762	Petrol	1108	4	70.00	4
C1E 764	Petrol	1108	4	70.00	4
C1E 792	Petrol	1108	4	70.00	4
C1J 700	Petrol	1397	4	76.00	10
C1J 715	Petrol	1397	4	76.00	10
C1J 742	Petrol	1397	4	76.00	10
C1J 768	Petrol	1397	4	76.00	10
C1J 780	Petrol	1397	4	76.00	10
C2J 700	Petrol	1397	4	76.00	10
C2J 713	Petrol	1397	4	76.00	10
C2J 717	Petrol	1397	4	76.00	10
C2J 718	Petrol	1397	4	76.00	10
C2J 757	Petrol	1397	4	76.00	10
C2J 772	Petrol	1397	4	76.00	10
C2J 782	Petrol	1397	4	76.00	10
C2J 784	Petrol	1397	4	76.00	10
C3G 700	Petrol	1239	4	74.00	7
C3G 702	Petrol	1239	4	74.00	7
C3G 710	Petrol	1239	4	74.00	7
C3G 712	Petrol	1239	4	74.00	7
C3G 720	Petrol	1239	4	74.00	7
C3G 750	Petrol	1239	4	74.00	7
C3J 700	Petrol	1397	4	76.00	10
C3J 702	Petrol	1397	4	76.00	10
C3J 710	Petrol	1397	4	76.00	10
C3J 760	Petrol	1397	4	76.00	10
C3J 762	Petrol	1397	4	76.00	10
D4F 702	Petrol	1149	4	69.00	2
D4F 704	Petrol	1149	4	69.00	2
D4F 706	Petrol	1149	4	69.00	2
D4F 708 (Euro 3)	Petrol	1149	4	69.00	2
D4F 712	Petrol	1149	4	69.00	2
D4F 714	Petrol	1149	4	69.00	2
D4F 716	Petrol	1149	4	69.00	2
D4F 722	Petrol	1149	4	69.00	2
D4F 728	Petrol	1149	4	69.00	2
D4F 730	Petrol	1149	4	69.00	2
D4F 732	Petrol	1149	4	69.00	2
D4F 740	Petrol	1149	4	69.00	2
D4F 742	Petrol	1149	4	69.00	2
D4F 764	Petrol	1149	4	69.00	2
D4F 772	Petrol	1149	4	69.00	2
D4F 790	Petrol	1149	4	69.00	2
D7F 700	Petrol	1149	4	69.00	3



CCM

x



9

D7F 701	Petrol	1149	4	69.00	3
D7F 702	Petrol	1149	4	69.00	3
D7F 703	Petrol	1149	4	69.00	3
D7F 704	Petrol	1149	4	69.00	3
D7F 706	Petrol	1149	4	69.00	3
D7F 710	Petrol	1149	4	69.00	3
D7F 720	Petrol	1149	4	69.00	3
D7F 722	Petrol	1149	4	69.00	3
D7F 726	Petrol	1149	4	69.00	3
D7F 730	Petrol	1149	4	69.00	3
D7F 746	Petrol	1149	4	69.00	3
D7F 764	Petrol	1149	4	69.00	3
D7F 766 (Euro 4)	Petrol	1149	4	69.00	3
DCI 4-B (Euro 3)	Diesel	4120	4	102.00	47
DCI 4-C (Euro 3)	Diesel	4120	4	102.00	47
DCI 6 A (Euro 3)	Diesel	6177	6	102.00	47
DCI 6 W (Euro 3)	Diesel	6177	6	102.00	47
DCI 11C (Euro 3)	Diesel	11100	6	123.00	62
DCI 11E (Euro 3)	Diesel	11100	6	123.00	63
DXI 5	Diesel	4800	4	108.00	54
DXI 7	Diesel	7200	6	108.00	54
DXI 11 (Euro 3/4)	Diesel	10800	6	123.00	64
DXI 12 (Euro 3)	Diesel	12130	6	131.00	68
DXI 13 (Euro 4/5)	Diesel	12800	6	131.00	69
E6J 700	Petrol	1390	4	75.80	9
E6J 701	Petrol	1390	4	75.80	9
E6J 734	Petrol	1390	4	75.80	9
E6J 738	Petrol	1390	4	75.80	9
E7J 624	Petrol	1390	4	75.80	9
E7J 626	Petrol	1390	4	75.80	9
E7J 634	Petrol	1390	4	75.80	9
E7J 635	Petrol	1390	4	75.80	9
E7J 718	Petrol	1390	4	75.80	9
E7J 719	Petrol	1390	4	75.80	9
E7J 720	Petrol	1390	4	75.80	9
E7J 724	Petrol	1390	4	75.80	9
E7J 726	Petrol	1390	4	75.80	9
E7J 728	Petrol	1390	4	75.80	9
E7J 742	Petrol	1390	4	75.80	9
E7J 754	Petrol	1390	4	75.80	9
E7J 764	Petrol	1390	4	75.80	9
E7J 773	Petrol	1390	4	75.80	9
E7J 780	Petrol	1390	4	75.80	9
F8M 700	Diesel	1596	4	78.00	18
F8M 720	Diesel	1596	4	78.00	18
F8M 730	Diesel	1596	4	78.00	18
F8M 736	Diesel	1596	4	78.00	18
F8M 760	Diesel	1596	4	78.00	18
F8Q 606	Diesel	1870	4	80.00	23
F8Q 620	Diesel	1870	4	80.00	23
F8Q 630	Diesel	1870	4	80.00	24
F8Q 632	Diesel	1870	4	80.00	24
F8Q 640	Diesel	1870	4	80.00	23
F8Q 644	Diesel	1870	4	80.00	23
F8Q 646	Diesel	1870	4	80.00	23
F8Q 662	Diesel	1870	4	80.00	24
F8Q 676	Diesel	1870	4	80.00	23
F8Q 678	Diesel	1870	4	80.00	23
F8Q 682	Diesel	1870	4	80.00	23
F8Q 696	Diesel	1870	4	80.00	23

ENGINE INDEX

Motorverzeichnis • Index de moteur • Índice de Motor
 Indeks silnika • Модель Двигателя • دليل المحرك

CCM

9

F8Q 706	Diesel	1870	4	80.00	23
F8Q 710	Diesel	1870	4	80.00	23
F8Q 714	Diesel	1870	4	80.00	23
F8Q 722	Diesel	1870	4	80.00	23
F8Q 724	Diesel	1870	4	80.00	23
F8Q 730	Diesel	1870	4	80.00	23
F8Q 732	Diesel	1870	4	80.00	23
F8Q 742	Diesel	1870	4	80.00	23
F8Q 774	Diesel	1870	4	80.00	23
F8Q 776	Diesel	1870	4	80.00	23
F9Q 650	Diesel	1870	4	80.00	25
F9Q 664	Diesel	1870	4	80.00	25
F9Q 670	Diesel	1870	4	80.00	25
F9Q 674	Diesel	1870	4	80.00	25
F9Q 710	Diesel	1870	4	80.00	26
F9Q 717	Diesel	1870	4	80.00	26
F9Q 718	Diesel	1870	4	80.00	26
F9Q 730	Diesel	1870	4	80.00	26
F9Q 731	Diesel	1870	4	80.00	26
F9Q 732	Diesel	1870	4	80.00	26
F9Q 733	Diesel	1870	4	80.00	26
F9Q 734	Diesel	1870	4	80.00	26
F9Q 736	Diesel	1870	4	80.00	26
F9Q 738	Diesel	1870	4	80.00	26
F9Q 740	Diesel	1870	4	80.00	26
F9Q 744	Diesel	1870	4	80.00	26
F9Q 748	Diesel	1870	4	80.00	26
F9Q 750	Diesel	1870	4	80.00	25
F9Q 752	Diesel	1870	4	80.00	26
F9Q 754	Diesel	1870	4	80.00	26
F9Q 756	Diesel	1870	4	80.00	25
F9Q 758	Diesel	1870	4	80.00	25
F9Q 759	Diesel	1870	4	80.00	25
F9Q 760	Diesel	1870	4	80.00	26
F9Q 762	Diesel	1870	4	80.00	26
F9Q 770	Diesel	1870	4	80.00	26
F9Q 772	Diesel	1870	4	80.00	26
F9Q 774	Diesel	1870	4	80.00	26
F9Q 780	Diesel	1870	4	80.00	26
F9Q 782	Diesel	1870	4	80.00	26
F9Q 790	Diesel	1870	4	80.00	26
F9Q 796	Diesel	1870	4	80.00	26
F9Q 800	Diesel	1870	4	80.00	25
F9Q 808	Diesel	1870	4	80.00	25
F9Q 812	Diesel	1870	4	80.00	25
F9Q 816	Diesel	1870	4	80.00	25
F9Q 818	Diesel	1870	4	80.00	25
F9Q 820	Diesel	1870	4	80.00	25
F9Q 826	Diesel	1870	4	80.00	25
F9Q 870	Diesel	1870	4	80.00	27
F9Q 872	Diesel	1870	4	80.00	27
G9T 605 (Euro 4)	Diesel	2188	4	87.00	32
G9T 606 (Euro 4)	Diesel	2188	4	87.00	32
G9T 607	Diesel	2188	4	87.00	33
G9T 642	Diesel	2188	4	87.00	32
G9T 645 (Euro 4)	Diesel	2188	4	87.00	32
G9T 700	Diesel	2188	4	87.00	32
G9T 702 (Euro 3)	Diesel	2188	4	87.00	32
G9T 703	Diesel	2188	4	87.00	32
G9T 704	Diesel	2188	4	87.00	32



CCM

x



9

G9T 706	Diesel	2188	4	87.00	32
G9T 707	Diesel	2188	4	87.00	32
G9T 710	Diesel	2188	4	87.00	33
G9T 720	Diesel	2188	4	87.00	33
G9T 722	Diesel	2188	4	87.00	33
G9T 742 (Euro 3)	Diesel	2188	4	87.00	32
G9T 743 (Euro 3)	Diesel	2188	4	87.00	32
G9T 750	Diesel	2188	4	87.00	33
G9U 632 (Euro 4)	Diesel	2464	4	89.00	34
G9U 650 (Euro 4)	Diesel	2464	4	89.00	34
G9U 720 (Euro 3)	Diesel	2464	4	89.00	35
G9U 724 (Euro 3)	Diesel	2464	4	89.00	35
G9U 730 (Euro 3)	Diesel	2464	4	89.00	35
G9U 750 (Euro 3)	Diesel	2464	4	89.00	35
G9U 754 (Euro 3)	Diesel	2464	4	89.00	35
H4B 400	Petrol	898	3	72.20	5
H4B 401	Petrol	898	3	72.20	5
H4B 408	Petrol	898	3	72.20	5
H4B 453	Petrol	898	3	72.20	5
H5F 400 (Euro 5/6)	Petrol	1197	4	72.20	6
H5F 402 (Euro 5/6)	Petrol	1198	4	72.20	6
H5F 403 (Euro 5/6)	Petrol	1197	4	72.20	6
H5F 404 (Euro 5/6)	Petrol	1198	4	72.20	6
H5F 408 (Euro 5/6)	Petrol	1197	4	72.20	6
H5F 412 (Euro 5/6)	Petrol	1197	4	72.20	6
K4M 616	Petrol	1598	4	79.50	19
K4M 690	Petrol	1598	4	79.50	19
K4M 697	Petrol	1598	4	79.50	19
K4M 698	Petrol	1598	4	79.50	19
K4M 700	Petrol	1598	4	79.50	19
K4M 701	Petrol	1598	4	79.50	19
K4M 704	Petrol	1598	4	79.50	19
K4M 706	Petrol	1598	4	79.50	19
K4M 707	Petrol	1598	4	79.50	19
K4M 708	Petrol	1598	4	79.50	19
K4M 709	Petrol	1598	4	79.50	19
K4M 710	Petrol	1598	4	79.50	19
K4M 711	Petrol	1598	4	79.50	19
K4M 712	Petrol	1598	4	79.50	19
K4M 714	Petrol	1598	4	79.50	19
K4M 716	Petrol	1598	4	79.50	19
K4M 720	Petrol	1598	4	79.50	19
K4M 724	Petrol	1598	4	79.50	19
K4M 730	Petrol	1598	4	79.50	19
K4M 732	Petrol	1598	4	79.50	19
K4M 734	Petrol	1598	4	79.50	19
K4M 736	Petrol	1598	4	79.50	19
K4M 740	Petrol	1598	4	79.50	19
K4M 742	Petrol	1598	4	79.50	19
K4M 743	Petrol	1598	4	79.50	19
K4M 744 (Euro 4)	Petrol	1598	4	79.50	19
K4M 745 (Euro 4)	Petrol	1598	4	79.50	19
K4M 748	Petrol	1598	4	79.50	19
K4M 750	Petrol	1598	4	79.50	19
K4M 752	Petrol	1598	4	79.50	19
K4M 753	Petrol	1598	4	79.50	19
K4M 754	Petrol	1598	4	79.50	19
K4M 760	Petrol	1598	4	79.50	19
K4M 762	Petrol	1598	4	79.50	19
K4M 764	Petrol	1598	4	79.50	19

ENGINE INDEX

Motorverzeichnis • Index de moteur • Índice de Motor
 Indeks silnika • Модель Двигателя • دليل المحرك

CCM
x

9

K4M 768	Petrol	1598	4	79.50	19
K4M 776	Petrol	1598	4	79.50	19
K4M 788	Petrol	1598	4	79.50	19
K4M 790	Petrol	1598	4	79.50	19
K4M 830 (Euro 4)	Petrol	1598	4	79.50	19
K4M 831 (Euro 4)	Petrol	1598	4	79.50	19
K4M 834 (Euro 4)	Petrol	1598	4	79.50	19
K4M 856 (Euro 4)	Petrol	1598	4	79.50	19
K7J 710	Petrol	1390	4	79.50	20
K7J 714	Petrol	1390	4	79.50	20
K7M 702	Petrol	1598	4	79.50	21
K7M 703	Petrol	1598	4	79.50	21
K7M 710	Petrol	1598	4	79.50	21
K7M 720	Petrol	1598	4	79.50	21
K7M 732 (Euro 4)	Petrol	1598	4	79.50	22
K7M 744	Petrol	1598	4	79.50	21
K7M 745	Petrol	1598	4	79.50	21
K7M 746	Petrol	1598	4	79.50	21
K7M 790	Petrol	1598	4	79.50	21
K9K 276	Diesel	1461	4	76.00	11
K9K 608	Diesel	1461	4	76.00	11
K9K 612	Diesel	1461	4	76.00	12
K9K 636 (Euro 5)	Diesel	1461	4	76.00	11
K9K 700 (Euro 3)	Diesel	1461	4	76.00	13
K9K 702 (Euro 3)	Diesel	1461	4	76.00	13
K9K 704 (Euro 3)	Diesel	1461	4	76.00	13
K9K 706	Diesel	1461	4	76.00	13
K9K 708	Diesel	1461	4	76.00	13
K9K 710 (Euro 3)	Diesel	1461	4	76.00	13
K9K 712 (Euro 3)	Diesel	1461	4	76.00	14
K9K 714 (Euro 4)	Diesel	1461	4	76.00	13
K9K 716	Diesel	1461	4	76.00	13
K9K 718 (Euro 4)	Diesel	1461	4	76.00	14
K9K 722 (Euro 3)	Diesel	1461	4	76.00	13
K9K 724 (Euro 4)	Diesel	1461	4	76.00	14
K9K 728 (Euro 3)	Diesel	1461	4	76.00	14
K9K 729 (Euro 3)	Diesel	1461	4	76.00	14
K9K 732 (Euro 4)	Diesel	1461	4	76.00	15
K9K 734	Diesel	1461	4	76.00	14
K9K 740 (Euro 4)	Diesel	1461	4	76.00	13
K9K 742 (Euro 5)	Diesel	1461	4	76.00	16
K9K 750 (Euro 3)	Diesel	1461	4	76.00	13
K9K 752 (Euro 3)	Diesel	1461	4	76.00	13
K9K 760 (Euro 4)	Diesel	1461	4	76.00	14
K9K 762 (Euro 4)	Diesel	1461	4	76.00	13
K9K 764 (Euro 4)	Diesel	1461	4	76.00	15
K9K 766 (Euro 4)	Diesel	1461	4	76.00	14
K9K 768 (Euro 4)	Diesel	1461	4	76.00	13
K9K 770 (Euro 5)	Diesel	1461	4	76.00	12
K9K 772	Diesel	1461	4	76.00	11
K9K 780 (Euro 4)	Diesel	1461	4	76.00	15
K9K 782 (Euro 5)	Diesel	1461	4	76.00	12
K9K 790	Diesel	1461	4	76.00	13
K9K 792	Diesel	1461	4	76.00	13
K9K 794	Diesel	1461	4	76.00	13
K9K 796	Diesel	1461	4	76.00	13
K9K 800	Diesel	1461	4	76.00	11
K9K 802 (Euro 4)	Diesel	1461	4	76.00	14
K9K 804 (Euro 4)	Diesel	1461	4	76.00	15
K9K 806 (Euro 4)	Diesel	1461	4	76.00	15



CCM

x



9

K9K 808 (Euro 5)	Diesel	1461	4	76.00	12
K9K 812	Diesel	1461	4	76.00	11
K9K 814 (Euro 5)	Diesel	1461	4	76.00	16
K9K 816 (Euro 5)	Diesel	1461	4	76.00	12
K9K 820	Diesel	1461	4	76.00	12
K9K 830	Diesel	1461	4	76.00	11
K9K 832 (Euro 4)	Diesel	1461	4	76.00	15
K9K 834	Diesel	1461	4	76.00	12
K9K 836 (Euro 5)	Diesel	1461	4	76.00	12
K9K 837 (Euro 5)	Diesel	1461	4	76.00	16
K9K 840	Diesel	1461	4	76.00	11
K9K 846 (Euro 5)	Diesel	1461	4	76.00	17
K9K 884 (Euro 5)	Diesel	1461	4	76.00	11
K9K 896	Diesel	1461	4	76.00	11
K9K F 830	Diesel	1461	4	76.00	11
K9K G 724	Diesel	1461	4	76.00	14
K9K P 732	Diesel	1461	4	76.00	15
M9R 610	Diesel	1995	4	84.00	29
M9R 615	Diesel	1995	4	84.00	29
M9R 630	Diesel	1995	4	84.00	29
M9R 692 (Euro 5)	Diesel	1995	4	84.00	29
M9R 700	Diesel	1995	4	84.00	30
M9R 721	Diesel	1995	4	84.00	30
M9R 722	Diesel	1995	4	84.00	30
M9R 724	Diesel	1995	4	84.00	30
M9R 740	Diesel	1995	4	84.00	30
M9R 742	Diesel	1995	4	84.00	30
M9R 744	Diesel	1995	4	84.00	30
M9R 746	Diesel	1995	4	84.00	30
M9R 748	Diesel	1995	4	84.00	30
M9R 750	Diesel	1995	4	84.00	30
M9R 760	Diesel	1995	4	84.00	30
M9R 761	Diesel	1995	4	84.00	30
M9R 762	Diesel	1995	4	84.00	30
M9R 763	Diesel	1995	4	84.00	30
M9R 780 (Euro 4)	Diesel	1995	4	84.00	30
M9R 782	Diesel	1995	4	84.00	30
M9R 784	Diesel	1995	4	84.00	30
M9R 786 (Euro 4)	Diesel	1995	4	84.00	30
M9R 788	Diesel	1995	4	84.00	30
M9R 800	Diesel	1995	4	84.00	30
M9R 802	Diesel	1995	4	84.00	30
M9R 804	Diesel	1995	4	84.00	30
M9R 805 (Euro 4)	Diesel	1995	4	84.00	30
M9R 809	Diesel	1995	4	84.00	30
M9R 815	Diesel	1995	4	84.00	30
M9R 816	Diesel	1995	4	84.00	30
M9R 817	Diesel	1995	4	84.00	30
M9R 820	Diesel	1995	4	84.00	30
M9R 824	Diesel	1995	4	84.00	30
M9R 828	Diesel	1995	4	84.00	29
M9R 830	Diesel	1995	4	84.00	30
M9R 832	Diesel	1995	4	84.00	30
M9R 844	Diesel	1995	4	84.00	29
M9R 846	Diesel	1995	4	84.00	29
M9R 854	Diesel	1995	4	84.00	29
M9R 856	Diesel	1995	4	84.00	29
M9R 857	Diesel	1995	4	84.00	29
M9R 858	Diesel	1995	4	84.00	29
M9R 859	Diesel	1995	4	84.00	29

ENGINE INDEX

Motorverzeichnis • Index de moteur • Índice de Motor
 Indeks silnika • Модель Двигателя • دليل المحرك

CCM

9

M9R 862	Diesel	1995	4	84.00	29
M9R 864	Diesel	1995	4	84.00	29
M9R 865	Diesel	1995	4	84.00	29
M9R 866	Diesel	1995	4	84.00	29
M9T 670 (Euro 5)	Diesel	2298	4	85.00	31
M9T 672 (Euro 5)	Diesel	2298	4	85.00	31
M9T 676 (Euro 4)	Diesel	2298	4	85.00	31
M9T 678	Diesel	2298	4	85.00	31
M9T 680	Diesel	2298	4	85.00	31
M9T 686 (Euro 5)	Diesel	2298	4	85.00	31
M9T 690 (Euro 5)	Diesel	2298	4	85.00	31
M9T 692 (Euro 4)	Diesel	2298	4	85.00	31
M9T 694 (Euro 4)	Diesel	2298	4	85.00	31
M9T 696 (Euro 4)	Diesel	2298	4	85.00	31
M9T 698 (Euro 5)	Diesel	2298	4	85.00	31
M9T 702 (Euro 5)	Diesel	2298	4	85.00	31
M9T 870 (Euro 4/5)	Diesel	2299	4	85.00	31
M9T 872 (Euro 4/5)	Diesel	2298	4	85.00	31
M9T 880 (Euro 5)	Diesel	2298	4	85.00	31
M9T 882 (Euro 4)	Diesel	2298	4	85.00	31
M9T 890 (Euro 5)	Diesel	2298	4	85.00	31
M9T 896 (Euro 4)	Diesel	2298	4	85.00	31
M9T 898 (Euro 5)	Diesel	2298	4	85.00	31
MACK E.TECH A/46 (Euro 2)	Diesel	12000	6	124.00	66
MACK E.TECH B/46 (Euro 2)	Diesel	12000	6	124.00	66
MACK E.TECH C/46 (Euro 2)	Diesel	12000	6	124.00	66
MDS 06.35.40	Diesel	12024	6	135.00	70
MIDR 04.02.26 A/4 (Euro 2)	Diesel	4118	4	102.00	48
MIDR 04.02.26 B/4 (Euro 2)	Diesel	4118	4	102.00	48
MIDR 06.02.12	Diesel	5491	6	102.00	51
MIDR 06.02.12 B	Diesel	5491	6	102.00	51
MIDR 06.02.12 C	Diesel	5491	6	102.00	51
MIDR 06.02.12 D	Diesel	5491	6	102.00	51
MIDR 06.02.26	Diesel	6177	6	102.00	52
MIDR 06.02.26 D	Diesel	6177	6	102.00	53
MIDR 06.02.26 H	Diesel	6177	6	102.00	53
MIDR 06.02.26 V (Euro 1)	Diesel	6177	6	102.00	53
MIDR 06.02.26 V/4 (Euro 2)	Diesel	6177	6	102.00	52
MIDR 06.02.26 V/41 (Euro 2)	Diesel	6177	6	102.00	52
MIDR 06.02.26 X (Euro 1)	Diesel	6177	6	102.00	53
MIDR 06.02.26 Q	Diesel	6177	6	102.00	53
MIDR 06.02.26 U (Euro 1)	Diesel	6177	6	102.00	53
MIDR 06.02.26 U/4 (Euro 2)	Diesel	6177	6	102.00	52
MIDR 06.02.26 W (Euro 1)	Diesel	6177	6	102.00	53
MIDR 06.02.26 W/4 (Euro 2)	Diesel	6177	6	102.00	48
MIDR 06.02.26 Y/41 (Euro 2)	Diesel	6177	6	102.00	52
MIDR 06.20.45	Diesel	9771	6	120.00	55
MIDR 06.20.45 A	Diesel	9839	6	120.00	56
MIDR 06.20.45 A2	Diesel	9839	6	120.00	57
MIDR 06.20.45 B3 (Euro 1)	Diesel	9839	6	120.00	58
MIDR 06.20.45 C	Diesel	9839	6	120.00	56
MIDR 06.20.45 C/4 (Euro 2)	Diesel	9839	6	120.00	57
MIDR 06.20.45 D	Diesel	9839	6	120.00	59
MIDR 06.20.45 D3 (Euro 1)	Diesel	9839	6	120.00	58
MIDR 06.20.45 D/41 (Euro 2)	Diesel	9839	6	120.00	57
MIDR 06.20.45 DD (Euro 1)	Diesel	9839	6	120.00	60
MIDR 06.20.45 E	Diesel	9839	6	120.00	58
MIDR 06.20.45 E2 (Euro 1)	Diesel	9839	6	120.00	58
MIDR 06.20.45 E3 (Euro 1)	Diesel	9839	6	120.00	59
MIDR 06.20.45 E/41 (Euro 2)	Diesel	9839	6	120.00	58

CCM

x



9

MIDR 06.20.45 H	Diesel	9839	6	120.00	58
MIDR 06.20.45 I41 (Euro 2)	Diesel	9839	6	120.00	55
MIDR 06.20.45 M41 (Euro 2)	Diesel	9839	6	120.00	57
MIDR 06.23.56 A/3 (Euro 2)	Diesel	11122	6	123.00	65
MIDR 06.23.56 A/41 (Euro 2)	Diesel	11122	6	123.00	65
MIDR 06.23.56 B/41 (Euro 2)	Diesel	11122	6	123.00	65
MIDR 06.24.65	Diesel	11955	6	124.00	67
MIDR 06.24.65 A/42 (Euro 2)	Diesel	11955	6	124.00	67
MIDR 06.24.65 B/42 (Euro 2)	Diesel	11955	6	124.00	67
MIDR 06.24.65 C/42 (Euro 2)	Diesel	11955	6	124.00	67
MIDR 06.35.40	Diesel	12024	6	135.00	70
MIDR 06.35.40 C	Diesel	12024	6	135.00	70
MIDR 06.35.40 G	Diesel	12024	6	135.00	71
MIDR 06.35.40 H	Diesel	12024	6	135.00	71
MIDR 06.35.40 J1 (Euro 1)	Diesel	12024	6	135.00	73
MIDR 06.35.40 J/3 (Euro 1)	Diesel	12024	6	135.00	72
MIDR 06.35.40 L1	Diesel	12024	6	135.00	73
MIDR 06.35.40 M3 (Euro 1)	Diesel	12024	6	135.00	72
MIDR 06.35.40 N/3 (Euro 1)	Diesel	12024	6	135.00	72
MIDR 06.35.40 P/41 (Euro 2)	Diesel	12024	6	135.00	73
MIDS 06.02.12	Diesel	5491	6	102.00	51
MIDS 06.02.12 B	Diesel	5453	6	102.00	51
MIDS 06.02.12 C	Diesel	5491	6	102.00	51
MIDS 06.02.12 D/3	Diesel	5491	6	102.00	51
MIDS 06.20.30	Diesel	8822	6	120.00	55
MIDS 06.20.30 N	Diesel	8822	6	120.00	55
MIDS 06.20.30 N1	Diesel	8822	6	120.00	55
MIDS 06.20.45 B	Diesel	9839	6	120.00	58
MIDS 06.35.40	Diesel	12024	6	135.00	74
MIDS 06.35.40 B	Diesel	12024	6	135.00	74
MIDS 06.35.40 D	Diesel	12024	6	135.00	75
MIHR 06.20.45 A41 (Euro 2)	Diesel	9839	6	120.00	57
MIPR 06.20.45 A3	Diesel	9840	6	120.00	56
MIPR 06.20.45 C3	Diesel	9840	6	120.00	56
MIPS 06.20.30	Diesel	8820	6	120.00	55
MIPS 06.20.45	Diesel	9840	6	120.00	61
MIPS 06.20.45 A	Diesel	9840	6	120.00	61
MIPS 06.20.45 B	Diesel	9840	6	120.00	61
MIPS 06.20.45 C	Diesel	9840	6	120.00	61
R9M 402	Diesel	1598	4	80.00	28
R9M 404	Diesel	1598	4	80.00	28
R9M 408	Diesel	1598	4	80.00	28
R9M 409	Diesel	1598	4	80.00	28
R9M 413	Diesel	1598	4	80.00	28
R9M 414	Diesel	1598	4	80.00	28
R9M 450	Diesel	1598	4	80.00	28
R9M 452	Diesel	1598	4	80.00	28
R9M 453	Diesel	1598	4	80.00	28
S8U 720 (SOFIM 2.4D)	Diesel	2445	4	93.00	40
S8U 722 (SOFIM 2.4D)	Diesel	2445	4	93.00	40
S8U 730 (SOFIM 2.4D)	Diesel	2445	4	93.00	40
S8U 731	Diesel	2445	4	93.00	40
S8U 742	Diesel	2500	4	93.00	40
S8U 748	Diesel	2445	4	93.00	40
S8U 750	Diesel	2500	4	93.00	40
S8U 752	Diesel	2500	4	93.00	40
S8U 758	Diesel	2500	4	93.00	40
S8U 780	Diesel	2500	4	93.00	40
S8U 782	Diesel	2500	4	93.00	40
S9U 702	Diesel	2500	4	93.00	39

ENGINE INDEX

Motorverzeichnis • Index de moteur • Índice de Motor
 Indeks silnika • Модель Двигателя • دليل المحرك

CCM
x

9

S9U 714	Diesel	2500	4	93.00	39
S9U 740	Diesel	2500	4	93.00	39
S9W 700	Diesel	2800	4	94.40	41
S9W 702	Diesel	2800	4	94.40	41



58.00

1

670.800	4cyl.	845cc	19-26kW (26-35PS)	Petrol	TD22489
800 01	4cyl.	845cc	25kW (34PS)	Petrol	TD3024
800.02	4cyl.	845cc	21-26kW (29-35PS)	Petrol	TD21383
800 05	4cyl.	845cc	22-25kW (30-34PS)	Petrol	TD3025
800 705	4cyl.	845cc	19-26kW (26-35PS)	Petrol	TD4852
800 710	4cyl.	845cc	26-27kW (36-37PS)	Petrol	TD3028
B1B 707	4cyl.	845cc	21kW (29PS)	Petrol	TD4855
4 0.8			10/62→12/88	DAUPHINE 0.8	03/60→03/62
4 Body/MPV 0.8			09/66→07/89	RODEO 4 0.8	08/71→11/81
5 0.8			10/72→12/84	RODEO 6 0.8	05/70→08/73
6 0.8			10/69→04/80		

87-333300-00 STD

A 30.00
D 64.00
16x50



08-333300-00 STD

1.75 CR P
2.00 P
3.50 P



69.00

2

D4F 702	4cyl.	1149cc	55kW (75PS)	Petrol	TD16272
D4F 704	4cyl.	1149cc	55kW (75PS)	Petrol	TD16273
D4F 706	4cyl.	1149cc	55kW (75PS)	Petrol	TD21205
D4F 708 (Euro 3)	4cyl.	1149cc	44kW (60PS)	Petrol	TD19014
D4F 712	4cyl.	1149cc	50-55kW (68-75PS)	Petrol	TD16186
D4F 714	4cyl.	1149cc	55kW (75PS)	Petrol	TD16187
D4F 716	4cyl.	1149cc	55kW (75PS)	Petrol	TD17270
D4F 722	4cyl.	1149cc	55kW (75PS)	Petrol	TD19671
D4F 728	4cyl.	1149cc	54-55kW (73-75PS)	Petrol	TD21206
D4F 730	4cyl.	1149cc	55kW (75PS)	Petrol	TD21207
D4F 732	4cyl.	1149cc	53-55kW (72-75PS)	Petrol	TD23528
D4F 740	4cyl.	1149cc	48-55kW (65-75PS)	Petrol	TD18421
D4F 742	4cyl.	1149cc	55-58kW (75-79PS)	Petrol	TD24895
D4F 764	4cyl.	1149cc	43-58kW (58-79PS)	Petrol	TD18530
D4F 772	4cyl.	1149cc	55-56kW (75-76PS)	Petrol	TD20444
D4F 790	4cyl.	1149cc	55kW (75PS)	Petrol	TD29123
CLIO II 1.2 16V			06/01→08/16	MODUS / GRAND MODUS 1.2	12/04→
CLIO III 1.2			10/05→12/14	MODUS / GRAND MODUS 1.2 16V	10/08→
CLIO III 1.2 16V			06/05→12/14	SANDERO/STEPWAY II 1.2 16V	12/13→
CLIO IV 1.2 16V			11/12→	THALIA I 1.2 16V	04/02→
CLIO IV 1.2 LPG 16V			11/12→06/15	THALIA II 1.2 16V	09/08→06/14
KANGOO 1.2 16V			06/01→	THALIA II 1.2 LPG	01/10→12/13
KANGOO Express 1.2 16V			10/01→	THALIA III 1.2 16V	12/13→
LOGAN II 1.2 16V			12/13→	THALIA III 1.2 LPG	03/14→
LOGAN II 1.2 16V LPG			12/13→	TWINGO I 1.2	01/01→06/12
LOGAN/STEPWAY II 1.2			11/13→	TWINGO I 1.2 16V	01/01→06/07
LOGAN/STEPWAY II 1.2 16V LPG			11/13→	TWINGO II 1.2 16V	03/07→



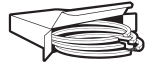

87-450000-00 STD
87-450007-00 0.50mm



A 26.70
B- 1.10
BØ 60.30
D 44.70
 18x54









08-450000-10 STD
08-450007-10 0.50mm

1.20
1.50
2.50





NT 
P
CR 

 Steel  Stahl  Acier  Acero  Acciaio

 69.00					3
D7F 700	4cyl.	1149cc	40-44kW (54-60PS)	Petrol	TD5520
D7F 701	4cyl.	1149cc	40-44kW (54-60PS)	Petrol	TD5521
D7F 702	4cyl.	1149cc	43-44kW (58-60PS)	Petrol	TD16274
D7F 703	4cyl.	1149cc	43-44kW (58-60PS)	Petrol	TD16275
D7F 704	4cyl.	1149cc	43-44kW (58-60PS)	Petrol	TD16276
D7F 706	4cyl.	1149cc	43-44kW (58-60PS)	Petrol	TD18178
D7F 710	4cyl.	1149cc	43-44kW (58-60PS)	Petrol	TD9624
D7F 720	4cyl.	1149cc	43kW (58PS)	Petrol	TD14328
D7F 722	4cyl.	1149cc	43-44kW (58-60PS)	Petrol	TD16326
D7F 726	4cyl.	1149cc	43kW (58PS)	Petrol	TD14329
D7F 730	4cyl.	1149cc	40-43kW (54-58PS)	Petrol	TD5522
D7F 746	4cyl.	1149cc	43kW (58PS)	Petrol	TD17267
D7F 764	4cyl.	1149cc	43kW (58PS)	Petrol	TD20903
D7F 766 (Euro 4)	4cyl.	1149cc	43kW (58PS)	Petrol	TD19670
CLIO I 1.2		01/96→09/98	KANGOO Express 1.2		08/97→
CLIO II 1.2		09/98→	THALIA I 1.2		02/98→10/03
CLIO II 1.2 LPG		09/98→06/09	TWINGO I 1.2		05/96→06/07
KANGOO 1.2		08/97→	TWINGO I 1.2 LPG		10/03→06/07

87-104100-00 STD
87-104107-00 0.50mm

A 27.00
D 50.50
 18x52



08-104100-00 STD
08-104107-00 0.50mm

1.50
1.50
2.50



CR P
P
CR P

 70.00					4
688 02	4cyl.	1108cc	41kW (56PS)	Petrol	TD3012
688 03	4cyl.	1108cc	25-39kW (34-53PS)	Petrol	TD22492
688 10	4cyl.	1108cc	25-39kW (34-53PS)	Petrol	TD21382
688.11	4cyl.	1108cc	25-39kW (34-53PS)	Petrol	TD28180
688 711	4cyl.	1108cc	25kW (34PS)	Petrol	TD3014
688 712	4cyl.	1108cc	25-35kW (34-48PS)	Petrol	TD3015
688 713	4cyl.	1108cc	33kW (45PS)	Petrol	TD3013
C1E (688.01)	4cyl.	1108cc	25-39kW (34-53PS)	Petrol	TD22490
C1E 700	4cyl.	1108cc	35-36kW (48-49PS)	Petrol	TD3100
C1E 715	4cyl.	1108cc	35kW (48PS)	Petrol	TD3102





C1E 750	4cyl.	1108cc	33-35kW (45-48PS)	Petrol	TD3106
C1E 752	4cyl.	1108cc	33-34kW (45-46PS)	Petrol	TD3107
C1E 754	4cyl.	1108cc	33-34kW (45-46PS)	Petrol	TD3108
C1E 756	4cyl.	1108cc	33kW (45PS)	Petrol	TD3109
C1E 760	4cyl.	1108cc	33kW (45PS)	Petrol	TD3110
C1E 762	4cyl.	1108cc	33-36kW (45-49PS)	Petrol	TD3111
C1E 764	4cyl.	1108cc	36kW (49PS)	Petrol	TD3112
C1E 792	4cyl.	1108cc	33kW (45PS)	Petrol	TD3113

4 1.1	02/78→06/90	11 1.1	03/83→06/86
4 Body/MPV 1.1	10/76→07/89	CLIO I 1.1	01/91→09/98
5 1.1	09/80→12/85	ESTAFETTE 1.1	02/62→12/81
6 1.1	08/70→04/87	RAPID Body/MPV 1.1	07/85→04/95
8 1.1	11/62→10/72	RODEO 5 1.1	11/81→12/87
9 1.1	09/81→05/87	RODEO 6 1.1	08/73→11/81
10 1.1	05/66→10/72	SUPER 5 1.1	10/84→12/96

<p>1</p> <p>A 40.00 D 68.00 18x62</p>	<p>08-334600-00 STD</p> <p>1.75 CR P 2.00 P 3.50 CR 2</p>	<p>WH 4 B 75.50 C 135.00 D 85.70 E 94.80</p>	<p>89-334600-00 3</p>
--	---	---	------------------------------

- | | | | | |
|--|--|---|--|---|
| <p>1 Piston available in Kit Set only
2 Steel
3 Includes seals
4 Liner available in Kit Set only</p> | <p>1 Kolben nur im Assembly erhältlich
2 Stahl
3 Schließt Dichtungen ein
4 Zylinderlaufbuche nur in Assemblies verfügbar</p> | <p>1 Piston disponible en kit seulement
2 Acier
3 Inclut des joints
4 Chemise disponible en kit seulement</p> | <p>1 Pistón disponible en conjuntos solamente.
2 Acero
3 Incluye los sellos
4 Camisas disponible en conjuntos solamente.</p> | <p>1 I pistoni sono disponibili solo in kit motore
2 Acciaio
3 Comprende le guarnizioni
4 Cilindro disponibile solo in kit motore</p> |
|--|--|---|--|---|

72.20	5					
H4B 400	3cyl.	898cc	66kW (90PS)	Petrol	Turbo Intercooled	TD32304
H4B 401	3cyl.	898cc	66-80kW (90-109PS)	Petrol	Turbo Intercooled	TD32306
H4B 408	3cyl.	898cc	56-66kW (76-90PS)	Petrol	Turbo Intercooled	TD34138
H4B 453	3cyl.	898cc	68kW (92PS)	Petrol	Turbo	TD37650
CAPTUR I 0.9 TCe 90	06/13→	THALIA III 0.9 TCe	06/14→			
CLIO IV 0.9 TCe 75	05/18→	TWINGO III 0.9 TCe 90	09/14→			
CLIO IV 0.9 TCe 90	11/12→	TWINGO III 0.9 TCe 95	03/19→			
LOGAN II TCe 90	02/17→12/20	TWINGO III 0.9 TCe 110	11/16→			
SANDERO/STEPWAY II TCe 90	09/15→					

<p>87-450400-10 STD</p> <p>A 31.247mm B- 4.704mm BØ 61.54mm C 2.927mm C 0.457mm D 48.74 19.99x43.00</p> <p>TP</p>	<p>08-450400-00 STD</p> <p>1.20 PVD NT 1 1.50 P 2.00 NT 1</p>	<p>1 Steel 1 Stahl 1 Acier 1 Acero 1 Acciaio</p>
---	--	---

72.20	6					
H5F 400 (Euro 5/6)	4cyl.	1197cc	84-85kW (114-116PS)	Petrol	Turbo Intercooled	TD26688
H5F 402 (Euro 5/6)	4cyl.	1198cc	85kW (116PS)	Petrol	Turbo Intercooled	TD27173
H5F 403 (Euro 5/6)	4cyl.	1197cc	83-88kW (113-120PS)	Petrol	Turbo Intercooled	TD32138





H5F 404 (Euro 5/6)	4cyl.	1198cc	97kW (132PS)	Petrol	Turbo Intercooled	TD27989
H5F 408 (Euro 5/6)	4cyl.	1197cc	74-97kW (101-132PS)	Petrol	Turbo Intercooled	TD32415
H5F 412 (Euro 5/6)	4cyl.	1197cc	84-97kW (115-132PS)	Petrol	Turbo Intercooled	TD33419
CAPTUR I 1.2 T			06/13→	KANGOO / GRAND KANGOO II 1.2 TCe 115		07/13→
CAPTUR I 1.2 TCe			02/18→	MEGANE CC 1.2 TCe		09/12→
CAPTUR I 1.2 TCe 120			06/13→	MEGANE III 1.2 TCe		03/12→
CLIO IV 1.2 TCe 120			03/13→	MEGANE IV 1.2 TCe 100		11/15→
GRAND SCÉNIC III 1.2 TCe			04/12→	MEGANE IV 1.2 TCe 130		11/15→
GRAND SCÉNIC IV 1.2 TCe 115			09/16→	MEGANE IV 1.2 TCe 130		10/16→
GRAND SCÉNIC IV 1.2 TCe 130			09/16→	SCÉNIC III 1.2 TCe		04/12→
KADJAR 1.2 TCe 130			06/15→	SCÉNIC IV 1.2 TCe 115		09/16→
KANGOO Express 1.2 TCe 115			07/13→	SCÉNIC IV 1.2 TCe 130		09/16→

87-450400-00 STD 1
03/12→

- A** 31.25
- B-** 5.00
- BØ** 57.00
- C** 2.50
- C** 1.18
- D** 49.00
- 20x47



08-450400-00 STD

- 1.20 PVD NT 2
- 1.50 P
- 2.00 NT 2

1 92kW→
2 Steel

2 Stahl

2 Acier

2 Acero

2 Acciaio

74.00

7

C3G 700	4cyl.	1239cc	40kW (55PS)	Petrol	TD3172	
C3G 702	4cyl.	1239cc	40kW (55PS)	Petrol	TD5515	
C3G 710	4cyl.	1239cc	40kW (55PS)	Petrol	TD3173	
C3G 712	4cyl.	1239cc	40kW (55PS)	Petrol	TD16545	
C3G 720	4cyl.	1239cc	40kW (54PS)	Petrol	TD14314	
C3G 750	4cyl.	1239cc	40kW (54PS)	Petrol	TD22356	
CLIO I 1.2			06/94→02/98	RAPID Body/MPV 1.2		09/91→03/98
EXPRESS 1.2			07/95→10/99	TWINGO I 1.2		03/93→10/96

14-630120-00 WH **B 78.60 C 135.00 D 88.20 E 94.90**

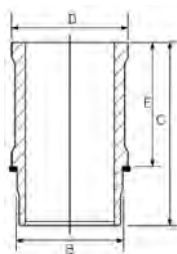

75.00

8

129	4cyl.	1218cc	42-43kW (57-58PS)	Petrol	TD3007
14 1.2			05/76→12/83		





15-636700-00 WH ① B 79.50 C 122.00 D 89.20 E 82.50

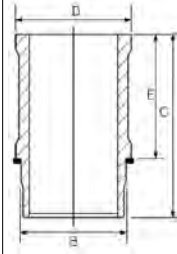

① Includes seals

① Schließt Dichtungen ein

① Inclut des joints

① Incluye los sellos

① Comprende le guarnizioni

75.80

9

E6J 700	4cyl.	1390cc	57-59kW (78-80PS)	Petrol	TD3183
E6J 701	4cyl.	1390cc	57-59kW (78-80PS)	Petrol	TD3184
E6J 734	4cyl.	1390cc	43-44kW (60-60PS)	Petrol	TD3189
E6J 738	4cyl.	1390cc	43kW (60PS)	Petrol	TD3190
E7J 624	4cyl.	1390cc	52kW (71PS)	Petrol	TD5526
E7J 626	4cyl.	1390cc	55kW (75PS)	Petrol	TD16362
E7J 634	4cyl.	1390cc	55kW (75PS)	Petrol	TD17271
E7J 635	4cyl.	1390cc	55kW (75PS)	Petrol	TD17272
E7J 718	4cyl.	1390cc	58kW (79PS)	Petrol	TD3205
E7J 719	4cyl.	1390cc	58kW (79PS)	Petrol	TD3206
E7J 720	4cyl.	1390cc	43-59kW (58-80PS)	Petrol	TD3207
E7J 724	4cyl.	1390cc	54-59kW (73-80PS)	Petrol	TD3208
E7J 726	4cyl.	1390cc	55-59kW (75-80PS)	Petrol	TD5508
E7J 728	4cyl.	1390cc	58-59kW (79-80PS)	Petrol	TD3209
E7J 742	4cyl.	1390cc	55kW (75PS)	Petrol	TD3212
E7J 754	4cyl.	1390cc	55-59kW (75-80PS)	Petrol	TD3211
E7J 764	4cyl.	1390cc	55kW (75PS)	Petrol	TD4858
E7J 773	4cyl.	1390cc	55-59kW (75-80PS)	Petrol	TD3213
E7J 780	4cyl.	1390cc	55kW (75PS)	Petrol	TD9623

19 I 1.4	01/88→12/92	MEGANE I 1.4	09/96→08/03
19 II 1.4	01/92→12/98	MEGANE I 1.4 e	01/96→08/03
CLIO I 1.4	01/91→09/98	MEGANE I 1.4 Eco	01/96→03/99
CLIO II 1.4	09/98→05/05	MEGANE Scenic 1.4 i	01/97→09/99
KANGOO 1.4	08/97→	RAPID Body/MPV 1.4	09/91→03/98
KANGOO Express 1.4	08/97→06/08	RAPID Body/MPV 1.4 RN	09/91→08/93

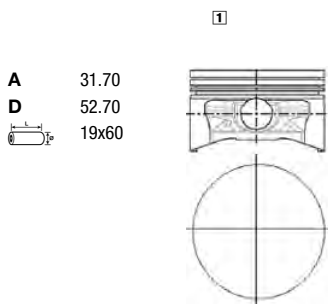

A 31.70
D 52.70
19x60

08-336400-00 STD
08-336407-00 0.50mm

1.50 CR P
1.75 P
3.00 P

WH ② ③ B 80.60 C 130.00 D 90.20 E 91.50

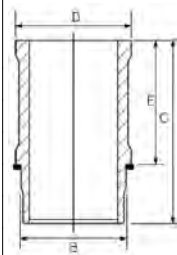

89-336400-10 ②

① Piston available in Kit Set only

② Includes seals

③ Liner available in Kit Set only

① Kolben nur im Assembly erhältlich

② Schließt Dichtungen ein

③ Zylinderaufbuchse nur in Assemblies verfügbar

① Piston disponible en kit seulement

② Inclut des joints

③ Chemise disponible en kit seulement

① Pistón disponible en conjuntos solamente.

② Incluye los sellos

③ Camisas disponible en conjuntos solamente.

① I pistoni sono disponibili solo in kit motore

② Comprende le guarnizioni

③ Cilindro disponibile solo in kit motore

76.00

10

847 700	4cyl.	1397cc	35kW (48PS)	Petrol	TD3067
847 701	4cyl.	1397cc	35kW (48PS)	Petrol	TD3072



847 712	4cyl.	1397cc	42-43kW (58-59PS)	Petrol	TD3068
847 720	4cyl.	1397cc	47kW (64PS)	Petrol	TD5054
C1J 700	4cyl.	1397cc	35-36kW (48-50PS)	Petrol	TD3122
C1J 715	4cyl.	1397cc	44kW (60PS)	Petrol	TD3123
C1J 742	4cyl.	1397cc	43-44kW (58-60PS)	Petrol	TD3125
C1J 768	4cyl.	1397cc	39-44kW (53-60PS)	Petrol	TD3128
C1J 780	4cyl.	1397cc	43kW (58PS)	Petrol	TD3130
C2J 700	4cyl.	1397cc	52-53kW (71-72PS)	Petrol	TD3137
C2J 713	4cyl.	1397cc	46kW (63PS)	Petrol	TD3138
C2J 717	4cyl.	1397cc	53kW (72PS)	Petrol	TD3141
C2J 718	4cyl.	1397cc	49-50kW (67-68PS)	Petrol	TD3143
C2J 757	4cyl.	1397cc	49-50kW (67-68PS)	Petrol	TD3147
C2J 772	4cyl.	1397cc	43-44kW (58-60PS)	Petrol	TD3154
C2J 782	4cyl.	1397cc	49kW (67PS)	Petrol	TD3158
C2J 784	4cyl.	1397cc	44kW (60PS)	Petrol	TD3161
C3J 700	4cyl.	1397cc	43-44kW (58-60PS)	Petrol	TD4856
C3J 702	4cyl.	1397cc	43-44kW (58-60PS)	Petrol	TD3175
C3J 710	4cyl.	1397cc	43-44kW (58-60PS)	Petrol	TD3176
C3J 760	4cyl.	1397cc	43-44kW (58-60PS)	Petrol	TD3179
C3J 762	4cyl.	1397cc	43-44kW (58-60PS)	Petrol	TD3180

5 1.4	01/82→12/85	FUEGO 1.4 TL/GTL	02/80→10/85
9 1.4	09/81→12/88	RAPID Body/MPV 1.4	07/85→08/91
11 1.4	03/83→12/88	RAPID Body/MPV 1.4 Cat	08/88→03/98
18 1.4	04/78→07/86	SUPER 5 1.4	10/84→08/90
19 I 1.4	07/88→05/93	SUPER 5 1.4 Cat	10/85→12/96
19 I 1.4 Cat	01/89→04/92	TRAFIC 1.4	03/80→06/91
19 II 1.4	04/92→12/95		

87-333500-00 STD

A 37.50
D 64.00
20x67



08-333500-00 STD

08-333507-00 0.50mm

1.75 CR P
2.00 P
4.00 CR



Steel Stahl Acier Acero Acciaio

76.00 11

K9K 276	4cyl.	1461cc	62kW (84PS)	Diesel	Turbo Intercooled	TD23876
K9K 608	4cyl.	1461cc	55-66kW (75-90PS)	Diesel	Turbo Intercooled	TD27682
K9K 636 (Euro 5)	4cyl.	1461cc	81kW (110PS)	Diesel	Turbo Intercooled	TD28220
K9K 772	4cyl.	1461cc	63-76kW (86-103PS)	Diesel	Turbo Intercooled	TD23549
K9K 800	4cyl.	1461cc	50-63kW (75-86PS)	Diesel	Turbo Intercooled	TD22193
K9K 812	4cyl.	1461cc	60-66kW (82-90PS)	Diesel	Turbo Intercooled	TD24967
K9K 830	4cyl.	1461cc	60-66kW (82-90PS)	Diesel	Turbo Intercooled	TD25693
K9K 840	4cyl.	1461cc	50kW (68PS)	Diesel	Turbo Intercooled	TD22194
K9K 884 (Euro 5)	4cyl.	1461cc	66kW (90PS)	Diesel	Turbo Intercooled	TD27697
K9K 896	4cyl.	1461cc	81kW (110PS)	Diesel	Turbo Intercooled	TD33638
K9K F 830	4cyl.	1461cc	63kW (86PS)	Diesel	Turbo Intercooled	TD23566

CAPTUR I 1.5 dCi	06/13→	KANGOO Express 1.5 dCi 110	09/13→
CAPTUR I 1.5 dCi 90	06/13→	KANGOO / GRAND KANGOO II 1.5 dCi 70	02/08→





CLIO III 1.5 dCi	06/05→12/12	KANGOO / GRAND KANGOO II 1.5 dCi 75	11/12→
CLIO IV 1.5 dCi	11/12→	KANGOO / GRAND KANGOO II 1.5 dCi 85	02/08→
CLIO IV 1.5 dCi 90	11/12→	KANGOO / GRAND KANGOO II 1.5 dCi 90	06/08→
DUSTER 1.5 dCi	06/11→	KANGOO / GRAND KANGOO II 1.5 dCi 110	03/13→
FLUENCE 1.5 dCi	02/10→	LOGGY 1.5 dCi	01/15→
GRAND SCÉNIC III 1.5 dCi	04/09→	MEGANE III 1.5 dCi	11/08→
KANGOO Express 1.5 dCi 70	02/08→	MODUS / GRAND MODUS 1.5 dCi	12/04→
KANGOO Express 1.5 dCi 75	09/10→	SANDERO/STEPWAY II 1.5 dCi	12/13→
KANGOO Express 1.5 dCi 85	02/08→	SCÉNIC III 1.5 dCi	04/09→
KANGOO Express 1.5 dCi 90	06/09→	THALIA III 1.5 dCi	12/13→

14-020650-00 D B 79.10 C 142.00 D 81.00 E 5.00

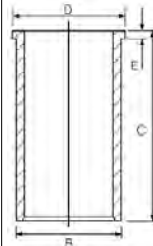

76.00

12

K9K 612	4cyl.	1461cc	55-66kW (75-90PS)	Diesel	Turbo Intercooled	TD27683
K9K 770 (Euro 5)	4cyl.	1461cc	55-65kW (75-88PS)	Diesel	Turbo Intercooled	TD25691
K9K 782 (Euro 5)	4cyl.	1461cc	81kW (110PS)	Diesel	Turbo Intercooled	TD27990
K9K 808 (Euro 5)	4cyl.	1461cc	55-66kW (75-90PS)	Diesel	Turbo Intercooled	TD26258
K9K 816 (Euro 5)	4cyl.	1461cc	80-81kW (109-110PS)	Diesel	Turbo Intercooled	TD35716
K9K 820	4cyl.	1461cc	55-63kW (75-86PS)	Diesel	Turbo Intercooled	TD25692
K9K 834	4cyl.	1461cc	66kW (90PS)	Diesel	Turbo Intercooled	TD23742
K9K 836 (Euro 5)	4cyl.	1461cc	78-81kW (106-110PS)	Diesel	Turbo Intercooled	TD23743

CLIO III 1.5 dCi	08/10→12/14	LOGAN II 1.5 dCi	12/13→
CLIO IV 1.5 dCi 75	11/12→	LOGAN/STEPWAY II 1.5 dCi	12/13→
DOKKER 1.5 dCi	12/13→	MEGANE CC 1.5 dCi	06/10→
FLUENCE 1.5 dCi	02/10→	MEGANE III 1.5 dCi	11/08→
GRAND SCÉNIC III 1.5 dCi	04/09→	MODUS / GRAND MODUS 1.5 dCi 75	10/10→
KANGOO BE BOP 1.5 dCi	06/09→12/12	MODUS / GRAND MODUS 1.5 dCi 90	10/10→
KANGOO Express 1.5 dCi 75	09/10→	SANDERO/STEPWAY II 1.5 dCi	01/17→
KANGOO Express 1.5 dCi 90	06/09→	SCÉNIC III 1.5 dCi	04/09→
KANGOO Express 1.5 dCi 110	09/10→	SCÉNIC III VAN 1.5 dCi	04/09→
KANGOO / GRAND KANGOO II 1.5 dCi 75	11/12→	THALIA II 1.5 dCi	01/09→
KANGOO / GRAND KANGOO II 1.5 dCi 90	06/08→	THALIA III 1.5 dCi	12/13→
KANGOO / GRAND KANGOO II 1.5 dCi 110	09/10→	TWINGO II 1.5 dCi	10/10→09/14
LAGUNA III 1.5 dCi	10/07→12/15	TWINGO II 1.5 dCi 75	10/10→
LATITUDE 1.5 dCi	07/10→	TWINGO II 1.5 dCi 90	10/10→
LOGAN I 1.5 dCi	06/11→		

87-123400-40 STD
87-123407-40 0.50mm

A 41.70
B- 13.50
BØ 47.00
C 0.43
C 0.25
D 66.00
26x60
(7657-701)
AK KK RT TP



08-123400-30 STD
08-123405-30 0.25mm
08-123407-30 0.50mm

2.00 CK P
2.00 P
2.50 CR P

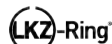

14-020650-00 D B 79.10 C 142.00 D 81.00 E 5.00

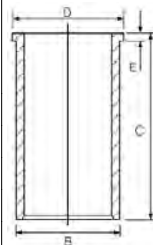



76.00							13
K9K 700 (Euro 3)	4cyl.	1461cc	45-50kW (61-68PS)	Diesel	Turbo Intercooled		TD16219
K9K 702 (Euro 3)	4cyl.	1461cc	45-60kW (61-82PS)	Diesel	Turbo Intercooled		TD16344
K9K 704 (Euro 3)	4cyl.	1461cc	42-48kW (57-65PS)	Diesel	Turbo Intercooled		TD16343
K9K 706	4cyl.	1461cc	48-60kW (65-82PS)	Diesel	Turbo Intercooled		TD20974
K9K 708	4cyl.	1461cc	48-50kW (65-68PS)	Diesel	Turbo Intercooled		TD26047
K9K 710 (Euro 3)	4cyl.	1461cc	60kW (82PS)	Diesel	Turbo Intercooled		TD17488
K9K 714 (Euro 4)	4cyl.	1461cc	47-50kW (64-68PS)	Diesel	Turbo Intercooled		TD21173
K9K 716	4cyl.	1461cc	45-60kW (61-82PS)	Diesel	Turbo Intercooled		TD22179
K9K 722 (Euro 3)	4cyl.	1461cc	60-63kW (82-86PS)	Diesel	Turbo Intercooled		TD16534
K9K 740 (Euro 4)	4cyl.	1461cc	47kW (64PS)	Diesel	Turbo Intercooled		TD20446
K9K 750 (Euro 3)	4cyl.	1461cc	57-65kW (78-88PS)	Diesel	Turbo Intercooled		TD21133
K9K 752 (Euro 3)	4cyl.	1461cc	47-50kW (64-68PS)	Diesel	Turbo Intercooled		TD21134
K9K 762 (Euro 4)	4cyl.	1461cc	50kW (68PS)	Diesel	Turbo Intercooled		TD20922
K9K 768 (Euro 4)	4cyl.	1461cc	48-50kW (65-68PS)	Diesel	Turbo Intercooled		TD18536
K9K 790	4cyl.	1461cc	48kW (65PS)	Diesel	Turbo Intercooled		TD21438
K9K 792	4cyl.	1461cc	50kW (68PS)	Diesel	Turbo Intercooled		TD21439
K9K 794	4cyl.	1461cc	48-50kW (65-68PS)	Diesel	Turbo Intercooled		TD23795
K9K 796	4cyl.	1461cc	63kW (86PS)	Diesel	Turbo Intercooled		TD26080

CLIO II 1.5 dCi	06/01→	MEGANE II 1.5 dCi	09/02→12/10
CLIO III 1.5 dCi	05/05→12/12	MODUS / GRAND MODUS 1.5 dCi	09/04→
DUSTER 1.5 dCi	02/12→	MODUS / GRAND MODUS 1.5 dCi 90	10/10→
KANGOO 1.5 dCi	12/01→	SCÉNIC II 1.5 dCi	06/03→05/06
KANGOO Express 1.5 dCi	12/01→	THALIA I 1.5 dCi	06/01→
LOGAN EXPRESS 1.5 dCi	04/07→	THALIA II 1.5 dCi	09/08→
LOGAN I 1.5 dCi	04/06→	TWINGO II 1.5 dCi	03/07→09/14

87-123400-00 STD
87-123407-00 0.50mm

A 41.69
B- 13.70
BØ 39.70
C 0.60
D 66.05
E 25x60



RT TP

08-123400-00 STD
08-123407-00 0.50mm

2.00 CK P
2.00 P
2.50 NT

14-020650-00 D B 79.10 C 142.00 D 81.00 E 5.00

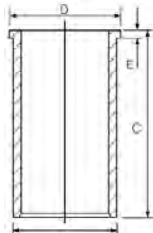

87-123400-10 STD
87-123407-10 0.50mm

A 41.82
B- 13.70
BØ 39.70
C 0.60
D 66.05
E 26x60



(557.503)

RT TP

08-123400-00 STD
08-123407-00 0.50mm

2.00 CK P
2.00 P
2.50 NT

76.00							14
K9K 712 (Euro 3)	4cyl.	1461cc	74kW (100PS)	Diesel	Turbo Intercooled		TD18419
K9K 718 (Euro 4)	4cyl.	1461cc	60-62kW (82-84PS)	Diesel	Turbo Intercooled		TD21171
K9K 724 (Euro 4)	4cyl.	1461cc	63kW (86PS)	Diesel	Turbo Intercooled		TD20988
K9K 728 (Euro 3)	4cyl.	1461cc	74-78kW (101-106PS)	Diesel	Turbo Intercooled		TD20706
K9K 729 (Euro 3)	4cyl.	1461cc	74kW (101PS)	Diesel	Turbo Intercooled		TD20707





K9K 734	4cyl.	1461cc	74-78kW (103-106PS)	Diesel	Turbo Intercooled	TD22192
K9K 760 (Euro 4)	4cyl.	1461cc	50-63kW (68-86PS)	Diesel	Turbo Intercooled	TD21135
K9K 766 (Euro 4)	4cyl.	1461cc	63-65kW (86-88PS)	Diesel	Turbo Intercooled	TD18537
K9K 802 (Euro 4)	4cyl.	1461cc	50-63kW (68-86PS)	Diesel	Turbo Intercooled	TD20830
K9K G 724	4cyl.	1461cc	63kW (86PS)	Diesel	Turbo Intercooled	TD19692

CLIO II 1.5 dCi	10/03→06/09	KANGOO / GRAND KANGOO II 1.5 dCi 85	02/08→
CLIO III 1.5 dCi	06/05→12/14	MEGANE II 1.5 dCi	08/03→12/10
GRAND SCÉNIC II 1.5 dCi	04/04→11/08	MODUS / GRAND MODUS 1.5 dCi	12/04→
KANGOO 1.5 dCi	06/05→	SCALA 1.5 dCi	09/12→10/17
KANGOO BE BOP 1.5 dCi 75	09/10→	SCÉNIC II 1.5 dCi	11/03→11/08
KANGOO Express 1.5 dCi	06/05→	THALIA I 1.5 dCi	06/01→02/09
KANGOO Express 1.5 dCi 85	02/08→	THALIA II 1.5 dCi	09/08→
KANGOO / GRAND KANGOO II 1.5 dCi 70	02/08→	TWINGO II 1.5 dCi	04/08→09/14

87-123400-20 STD
87-123407-20 0.50mm

A 41.70
B- 14.00
BØ 39.70
C 0.43
C 0.25
D 66.00
 26x60

(07657-101)
AK KK RT TP



08-123400-00 STD
08-123407-00 0.50mm

2.00  CK P
2.00  P
2.50  NT

14-020650-00 D **B 79.10 C 142.00 D 81.00 E 5.00**

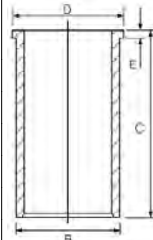

76.00

15

K9K 732 (Euro 4)	4cyl.	1461cc	78kW (106PS)	Diesel	Turbo Intercooled	TD20829
K9K 764 (Euro 4)	4cyl.	1461cc	78kW (106PS)	Diesel	Turbo Intercooled	TD18538
K9K 780 (Euro 4)	4cyl.	1461cc	76-81kW (103-110PS)	Diesel	Turbo Intercooled	TD20817
K9K 804 (Euro 4)	4cyl.	1461cc	76-81kW (103-110PS)	Diesel	Turbo Intercooled	TD20831
K9K 806 (Euro 4)	4cyl.	1461cc	76kW (103PS)	Diesel	Turbo Intercooled	TD20832
K9K 832 (Euro 4)	4cyl.	1461cc	78kW (106PS)	Diesel	Turbo Intercooled	TD23521
K9K P 732	4cyl.	1461cc	78kW (106PS)	Diesel	Turbo Intercooled	TD19693

CLIO III 1.5 dCi	06/05→12/14	KANGOO / GRAND KANGOO II 1.5 dCi 110	09/10→
FLUENCE 1.5 dCi	02/10→	LAGUNA III 1.5 dCi	10/07→12/15
GRAND SCÉNIC II 1.5 dCi	05/05→01/09	MEGANE CC 1.5 dCi	11/13→08/15
GRAND SCÉNIC III 1.5 dCi	02/09→	MEGANE II 1.5 dCi	08/03→12/10
KANGOO BE BOP 1.5 dCi	02/09→	MEGANE III 1.5 dCi	02/09→
KANGOO Express 1.5 dCi 105	02/08→	MODUS / GRAND MODUS 1.5 dCi	05/05→
KANGOO Express 1.5 dCi 110	09/10→	SCÉNIC II 1.5 dCi	05/05→11/08
KANGOO / GRAND KANGOO II 1.5 dCi	02/08→	SCÉNIC III 1.5 dCi	02/09→
KANGOO / GRAND KANGOO II 1.5 dCi 105	02/08→		

87-123400-30 STD
87-123407-30 0.50mm

A 41.70
B- 12.80
BØ 49.00
C 0.43
C 0.25
D 66.00
 26x60

(07657-401)
AK KK RT TP



08-123400-30 STD
08-123405-30 0.25mm
08-123407-30 0.50mm

2.00  CK P
2.00  P
2.50  CR P



14-020650-00 D **B 79.10 C 142.00 D 81.00 E 5.00**

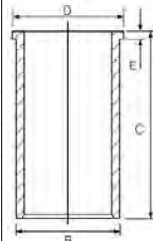



76.00 **16**

K9K 742 (Euro 5)	4cyl.	1461cc	50kW (68PS)	Diesel	Turbo Intercooled	TD33477
K9K 814 (Euro 5)	4cyl.	1461cc	50kW (68PS)	Diesel	Turbo Intercooled	TD33478
K9K 837 (Euro 5)	4cyl.	1461cc	81kW (110PS)	Diesel	Turbo Intercooled	TD26246
FLUENCE 1.5 dCi			02/10→	MEGANE III 1.5 dCi		01/09→
GRAND SCÉNIC III 1.5 dCi			04/09→	SCÉNIC III 1.5 dCi		04/09→
MEGANE CC 1.5 dCi			06/10→	SCÉNIC III VAN 1.5 dCi		04/09→

87-123400-50 STD
87-123407-50 0.50mm

A 41.74
B- 13.50
BØ 47.00
C 0.43
C 0.25
D 66.00
26x60
(7658-502)
AK RT TP

08-123400-30 STD
08-123405-30 0.25mm
08-123407-30 0.50mm

2.00 CK P
2.00 P
2.50 CR P

LKZ-Ring

14-020650-00 D **B 79.10 C 142.00 D 81.00 E 5.00**

76.00 **17**

K9K 846 (Euro 5)	4cyl.	1461cc	70-81kW (95-110PS)	Diesel	Turbo Intercooled	TD24579
GRAND SCÉNIC III 1.5 dCi			11/10→	MEGANE III 1.5 dCi		02/09→
LAGUNA 1.5 dCi			03/12→12/15	SCÉNIC III 1.5 dCi		11/10→
LAGUNA III 1.5 dCi			10/07→12/15	SCÉNIC III VAN 1.5 dCi		01/13→
LODGY 1.5 dCi			04/15→12/19	SCÉNIC IV 1.5 dCi 95		09/16→

87-123400-40 STD
87-123407-40 0.50mm

A 41.70
B- 13.50
BØ 47.00
C 0.43
C 0.25
D 66.00
26x60
(7657-701)
AK KK RT TP

08-123400-30 STD
08-123405-30 0.25mm
08-123407-30 0.50mm

2.00 CK P
2.00 P
2.50 CR P

LKZ-Ring

14-020650-00 D **B 79.10 C 142.00 D 81.00 E 5.00**

87-123400-50 STD
87-123407-50 0.50mm

A 41.74
B- 13.50
BØ 47.00
C 0.43
C 0.25
D 66.00
26x60
(7658-502)
AK RT TP

08-123400-30 STD
08-123405-30 0.25mm
08-123407-30 0.50mm

2.00 CK P
2.00 P
2.50 CR P

LKZ-Ring

78.00 **18**

F8M 700	4cyl.	1596cc	40kW (55PS)	Diesel		TD3282
F8M 720	4cyl.	1596cc	40kW (55PS)	Diesel		TD3283
F8M 730	4cyl.	1596cc	40kW (55PS)	Diesel		TD3284





F8M 736	4cyl.	1596cc	40kW (55PS)	Diesel	TD3285
F8M 760	4cyl.	1596cc	40kW (55PS)	Diesel	TD3286
9 1.6 D			10/82→12/88	RAPID Body/MPV 1.6 D	03/86→08/98
11 1.6 D			08/83→12/88	SUPER 5 1.6 D	10/84→12/96

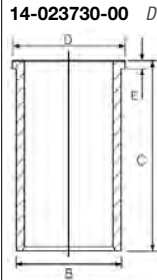

14-023730-00 D C 149.00 D 83.50 E 4.50

79.50 **19**

K4M 616	4cyl.	1598cc	75-77kW (102-105PS)	Petrol	TD27695
K4M 690	4cyl.	1598cc	75-85kW (102-116PS)	Petrol	TD22187
K4M 697	4cyl.	1598cc	76-82kW (103-112PS)	Petrol	TD23897
K4M 698	4cyl.	1598cc	77-82kW (105-112PS)	Petrol	TD23898
K4M 700	4cyl.	1598cc	79-85kW (107-116PS)	Petrol	TD13308
K4M 701	4cyl.	1598cc	79-85kW (107-116PS)	Petrol	TD13309
K4M 704	4cyl.	1598cc	79-80kW (107-109PS)	Petrol	TD16346
K4M 706	4cyl.	1598cc	69-82kW (94-112PS)	Petrol	TD21193
K4M 707	4cyl.	1598cc	79-81kW (107-110PS)	Petrol	TD26523
K4M 708	4cyl.	1598cc	75-85kW (102-116PS)	Petrol	TD16345
K4M 709	4cyl.	1598cc	75-79kW (102-107PS)	Petrol	TD21194
K4M 710	4cyl.	1598cc	76-79kW (103-107PS)	Petrol	TD16214
K4M 711	4cyl.	1598cc	79kW (107PS)	Petrol	TD16215
K4M 712	4cyl.	1598cc	75-80kW (107-109PS)	Petrol	TD21163
K4M 714	4cyl.	1598cc	79kW (107PS)	Petrol	TD21164
K4M 716	4cyl.	1598cc	82kW (112PS)	Petrol	TD21200
K4M 720	4cyl.	1598cc	79kW (107PS)	Petrol	TD16269
K4M 724	4cyl.	1598cc	79kW (107PS)	Petrol	TD16270
K4M 730	4cyl.	1598cc	70-81kW (95-110PS)	Petrol	TD21195
K4M 732	4cyl.	1598cc	66-82kW (90-110PS)	Petrol	TD20911
K4M 734	4cyl.	1598cc	58-66kW (79-90PS)	Petrol	TD20912
K4M 736	4cyl.	1598cc	79-86kW (107-117PS)	Petrol	TD21201
K4M 740	4cyl.	1598cc	79-81kW (107-110PS)	Petrol	TD18445
K4M 742	4cyl.	1598cc	66-86kW (90-117PS)	Petrol	TD20913
K4M 743	4cyl.	1598cc	66-86kW (90-117PS)	Petrol	TD20914
K4M 744 (Euro 4)	4cyl.	1598cc	55-85kW (75-107PS)	Petrol	TD19674
K4M 745 (Euro 4)	4cyl.	1598cc	79kW (107PS)	Petrol	TD19675
K4M 748	4cyl.	1598cc	79-86kW (107-117PS)	Petrol	TD11567
K4M 750	4cyl.	1598cc	70kW (95PS)	Petrol	TD17489
K4M 752	4cyl.	1598cc	70kW (95PS)	Petrol	TD16370
K4M 753	4cyl.	1598cc	70kW (95PS)	Petrol	TD17494
K4M 754	4cyl.	1598cc	98kW (133PS)	Petrol	TD21176
K4M 760	4cyl.	1598cc	81-83kW (110-113PS)	Petrol	TD16532
K4M 762	4cyl.	1598cc	77-81kW (105-110PS)	Petrol	TD21202
K4M 764	4cyl.	1598cc	82-85kW (112-116PS)	Petrol	TD20916
K4M 768	4cyl.	1598cc	75-85kW (102-116PS)	Petrol	TD21203





K4M 776	4cyl.	1598cc	79-85kW (107-116PS)	Petrol	TD26525
K4M 788	4cyl.	1598cc	77kW (105PS)	Petrol	TD21204
K4M 790	4cyl.	1598cc	82kW (112PS)	Petrol	TD18898
K4M 830 (Euro 4)	4cyl.	1598cc	70-85kW (95-116PS)	Petrol	TD23581
K4M 831 (Euro 4)	4cyl.	1598cc	78-79kW (105-107PS)	Petrol	TD26526
K4M 834 (Euro 4)	4cyl.	1598cc	78kW (106PS)	Petrol	TD26128
K4M 856 (Euro 4)	4cyl.	1598cc	77kW (105PS)	Petrol	TD26528

19 II 1.6	07/98→06/01	LOGAN 1.6 16V	01/10→08/13
CLIO II 1.6	05/00→02/10	LOGAN I 1.6	04/07→
CLIO II 1.6 16V	09/98→12/08	MEGANE I 1.6	03/99→09/00
DUSTER 1.6 16V	01/11→	MEGANE I 1.6 16V	01/99→08/08
GRAND SCÉNIC II 1.6	06/06→11/08	MEGANE I 1.6 LPG	10/00→08/02
KANGOO 1.6	09/06→	Megane I van 1.6	04/01→07/03
KANGOO 1.6 16V	06/01→	MEGANE II 1.6	08/03→
KANGOO BE BOP 1.6	02/09→12/12	MEGANE II 1.6 16V	11/02→
KANGOO Express 1.6	02/08→12/09	MEGANE II 1.6 LPG 16V	01/06→08/09
KANGOO Express 1.6 16V	10/01→	MEGANE Scenic 1.6 16V	04/98→10/99
KANGOO Express 1.6 16V FLEX	02/08→	MODUS / GRAND MODUS 1.6	12/04→
KANGOO Express 1.6 16V LPG	02/08→	SANDERO/STEPWAY I 1.6	12/07→
KANGOO Express 1.6 SCe	10/19→	SANDERO/STEPWAY II 1.6 16V	04/14→
KANGOO / GRAND KANGOO II 1.6 16V	02/08→	SCÉNIC I MPV 1.6	09/99→09/03
KANGOO / GRAND KANGOO II 1.6 16V FLEX	02/08→	SCÉNIC II 1.6	08/03→11/08
KANGOO / GRAND KANGOO II 1.6 16V LPG	12/08→	SCÉNIC II 1.6 16V	10/05→11/08
LAGUNA I 1.6 16V	11/97→03/01	THALIA I 1.6	01/04→12/08
LAGUNA II 1.6	03/01→12/07	THALIA I 1.6 16V	07/00→02/09
LAGUNA II 1.6 16V	03/01→12/07	THALIA I 1.6 Authentique	11/04→02/09
LAGUNA II 1.6 LPG	03/01→05/05	THALIA II 1.6 16V	09/08→

87-104200-30 STD

- A 31.70
- B- 1.30
- C 1.60
- D 55.00
-  20x62



08-104200-00 STD

08-104207-00 0.50mm

- 1.50  CR P
- 1.50  P
- 2.50  CR T

 Steel

 Stahl

 Acier

 Acero

 Acciaio

79.50

20

K7J 710	4cyl.	1390cc	55kW (75PS)	Petrol	TD18138
K7J 714	4cyl.	1390cc	53kW (72PS)	Petrol	TD23530
LOGAN I 1.4	09/04→	SANDERO/STEPWAY I 1.4	02/09→		
LOGAN I 1.4 LPG	02/08→10/13	SANDERO/STEPWAY I 1.4 LPG	02/09→		

87-104200-40 STD

87-104207-40 0.50mm

- A 35.83
- D 58.00
-  19x62



08-104200-00 STD

08-104207-00 0.50mm

- 1.50  CR P
- 1.50  P
- 2.50  CR T

 Steel

 Stahl

 Acier

 Acero

 Acciaio



79.50

21

K7M 702	4cyl.	1598cc	66kW (90PS)	Petrol	TD4876
K7M 703	4cyl.	1598cc	66kW (90PS)	Petrol	TD4877
K7M 710	4cyl.	1598cc	64-76kW (87-103PS)	Petrol	TD18139
K7M 720	4cyl.	1598cc	55kW (75PS)	Petrol	TD4878
K7M 744	4cyl.	1598cc	66kW (90PS)	Petrol	TD14332
K7M 745	4cyl.	1598cc	66kW (90PS)	Petrol	TD14333
K7M 746	4cyl.	1598cc	54-73kW (90-100PS)	Petrol	TD20918
K7M 790	4cyl.	1598cc	66kW (90PS)	Petrol	TD4879
19 II 1.6			10/96→06/01	MEGANE I 1.6 i	01/96→03/99
CLIO II 1.6			09/98→05/05	MEGANE I 1.6 LPG	08/95→03/99
KANGOO 1.6			09/99→06/01	MEGANE Scenic 1.6 e	10/96→10/99
KANGOO Express 1.6			09/99→06/01	MEGANE Scenic 1.6 i	01/97→09/99
LOGAN EXPRESS 1.6			04/07→	SANDERO/STEPWAY I 1.6	12/07→
LOGAN I 1.6			09/04→	SANDERO/STEPWAY II 1.6	05/15→
MEGANE I 1.6 e			01/96→08/03	THALIA I 1.6	03/98→

87-104200-00 STD ①
87-104207-00 0.50mm ①

A 31.80
B+ 2.55
D 56.30
 19x63



08-104200-00 STD
08-104207-00 0.50mm

1.50  CR P
 1.50  P
 2.50  CR ②

87-104200-10 STD ③
87-104207-10 0.50mm ③

A 31.80
B+ 2.55
D 56.30
 19x63



08-104200-00 STD
08-104207-00 0.50mm

1.50  CR P
 1.50  P
 2.50  CR ②

① To cylinder 1 & 2
 ② Steel
 ③ To cylinder 3 & 4

① an Zylinder 1 & 2
 ② Stahl
 ③ an Zylinder 3 & 4

① sur cylindre 1 & 2
 ② Acier
 ③ sur cylindre 3 & 4

① en el cilindro 1 & 2
 ② Acero
 ③ en el cilindro 3 & 4

① a cilindro 1 & 2
 ② Acciaio
 ③ a cilindro 3 & 4

79.50

22

K7M 732 (Euro 4)	4cyl.	1598cc	64kW (87PS)	Petrol	TD23532
LOGAN 1.6 i			07/04→		

87-443700-00 STD
87-443707-00 0.50mm

A 28.31
D 52.81
 19x62



08-443700-00 STD
08-443707-00 0.50mm

1.50  CK P
 1.50  P
 2.50  CR ①

① Steel

① Stahl

① Acier

① Acero

① Acciaio

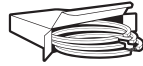

80.00					23
F8Q 606	4cyl.	1870cc	44kW (60PS)	Diesel	TD9690
F8Q 620	4cyl.	1870cc	47kW (64PS)	Diesel	TD4867
F8Q 640	4cyl.	1870cc	40kW (54PS)	Diesel	TD5510
F8Q 644	4cyl.	1870cc	40-66kW (54-90PS)	Diesel	TD21146
F8Q 646	4cyl.	1870cc	47-66kW (64-90PS)	Diesel	TD21252
F8Q 676	4cyl.	1870cc	48kW (65PS)	Diesel	TD23895
F8Q 678	4cyl.	1870cc	40-48kW (54-65PS)	Diesel	TD20390
F8Q 682	4cyl.	1870cc	40kW (54PS)	Diesel	TD16544
F8Q 696	4cyl.	1870cc	40-48kW (54-65PS)	Diesel	TD21255
F8Q 706	4cyl.	1870cc	47-48kW (64-65PS)	Diesel	TD3287
F8Q 710	4cyl.	1870cc	47kW (64PS)	Diesel	TD3288
F8Q 714	4cyl.	1870cc	47-48kW (64-65PS)	Diesel	TD3289
F8Q 722	4cyl.	1870cc	47-48kW (64-67PS)	Diesel	TD3290
F8Q 724	4cyl.	1870cc	47-48kW (64-67PS)	Diesel	TD3291
F8Q 730	4cyl.	1870cc	47-48kW (64-65PS)	Diesel	TD4868
F8Q 732	4cyl.	1870cc	47-48kW (64-65PS)	Diesel	TD4869
F8Q 742	4cyl.	1870cc	47-48kW (64-65PS)	Diesel	TD3295
F8Q 774	4cyl.	1870cc	47-48kW (64-67PS)	Diesel	TD3298
F8Q 776	4cyl.	1870cc	47-48kW (64-67PS)	Diesel	TD3299

19 I 1.9 D	01/88→12/92	MEGANE I 1.9	08/95→09/00
19 II 1.9 D	03/92→12/95	MEGANE I 1.9 D	09/96→08/03
21 1.9 D	03/86→08/94	MEGANE I 1.9 D Eco	01/96→08/03
CLIO I 1.9 D	01/91→09/98	RAPID 1.9 D	09/94→03/98
CLIO I 1.9 RND	04/96→02/98	RAPID Body/MPV 1.9 D	09/91→03/98
EXPRESS 1.9 D	07/95→10/99	TRAFIC 1.9 D	06/97→03/01

87-336500-00 STD
87-336507-00 0.50mm

A 42.35
B- 0.70
D 70.50
24x63

RT



08-336500-00 STD
08-336505-00 0.25mm
08-336507-00 0.50mm

2.00 MO P
2.00 P
3.00 CR P



80.00					24
F8Q 630	4cyl.	1870cc	47-48kW (64-65PS)	Diesel	TD9626
F8Q 632	4cyl.	1870cc	47-48kW (64-65PS)	Diesel	TD17431
F8Q 662	4cyl.	1870cc	40-48kW (54-65PS)	Diesel	TD9625

CLIO I 1.9 D	05/96→02/98	KANGOO Express 1.9 D	09/99→06/03
CLIO II 1.9 D	09/98→	KANGOO Express D 55 1.9	08/97→
KANGOO 1.9 RXED	09/99→06/01	KANGOO Express D 65 1.9	08/97→
KANGOO D 55 1.9	08/97→	THALIA I 1.9 D	02/98→05/01
KANGOO D 65 1.9	08/97→06/01		





87-336500-10 STD
87-336507-10 0.50mm
 Eng.971205→

A 42.25
B- 1.58
D 70.50
 24x63



08-336500-00 STD
08-336505-00 0.25mm
08-336507-00 0.50mm

2.00  MO P
 2.00  P
 3.00  CR P

80.00

25

F9Q 650	4cyl.	1870cc	77-88kW (105-120PS)	Diesel	Turbo Intercooled	TD21223
F9Q 664	4cyl.	1870cc	66-77kW (90-105PS)	Diesel	Turbo Intercooled	TD19677
F9Q 670	4cyl.	1870cc	77-88kW (105-120PS)	Diesel	Turbo Intercooled	TD21224
F9Q 674	4cyl.	1870cc	77-88kW (105-120PS)	Diesel	Turbo Intercooled	TD21225
F9Q 750	4cyl.	1870cc	77-92kW (105-125PS)	Diesel	Turbo Intercooled	TD17028
F9Q 756	4cyl.	1870cc	88kW (120PS)	Diesel	Turbo Intercooled	TD17064
F9Q 758	4cyl.	1870cc	77-96kW (105-130PS)	Diesel	Turbo Intercooled	TD19678
F9Q 759	4cyl.	1870cc	85-96kW (116-130PS)	Diesel	Turbo Intercooled	TD19679
F9Q 800	4cyl.	1870cc	85-88kW (116-120PS)	Diesel	Turbo Intercooled	TD16535
F9Q 808	4cyl.	1870cc	66-75kW (90-102PS)	Diesel	Turbo Intercooled	TD21147
F9Q 812	4cyl.	1870cc	85-88kW (116-120PS)	Diesel	Turbo Intercooled	TD20392
F9Q 816	4cyl.	1870cc	81-96kW (110-131PS)	Diesel	Turbo Intercooled	TD22184
F9Q 818	4cyl.	1870cc	81-96kW (110-131PS)	Diesel	Turbo Intercooled	TD22185
F9Q 820	4cyl.	1870cc	85-88kW (115-120PS)	Diesel	Turbo Intercooled	TD18287
F9Q 826	4cyl.	1870cc	88kW (120PS)	Diesel	Turbo Intercooled	TD18288

ESPACE IV 1.9 dCi	11/02→	MEGANE II 1.9 dCi	11/02→
GRAND SCÉNIC II 1.9 dCi	04/04→01/09	SCÉNIC II 1.9 D	06/06→11/08
LAGUNA II 1.9 dCi	03/01→12/07	SCÉNIC II 1.9 dCi	06/03→11/08

87-422300-00 STD
87-422307-00 0.50mm

A 47.04
B- 17.80
BØ 38.00
C 0.75
D 77.00
 28x60



AK KK RT TP

08-422300-00 STD
08-422307-00 0.50mm

2.50  MO P
 2.00  P
 3.00  CR P

80.00

26

F9Q 710	4cyl.	1870cc	72kW (98PS)	Diesel	Turbo Intercooled	TD16190
F9Q 717	4cyl.	1870cc	72-75kW (98-102PS)	Diesel	Turbo Intercooled	TD21136
F9Q 718	4cyl.	1870cc	79kW (107PS)	Diesel	Turbo Intercooled	TD16192
F9Q 730	4cyl.	1870cc	60-72kW (82-98PS)	Diesel	Turbo Intercooled	TD11427
F9Q 731	4cyl.	1870cc	72kW (98PS)	Diesel	Turbo Intercooled	TD16353
F9Q 732	4cyl.	1870cc	74-77kW (101-105PS)	Diesel	Turbo Intercooled	TD16347
F9Q 733	4cyl.	1870cc	75-77kW (102-105PS)	Diesel	Turbo Intercooled	TD16363
F9Q 734	4cyl.	1870cc	72kW (98PS)	Diesel	Turbo Intercooled	TD11428
F9Q 736	4cyl.	1870cc	72kW (98PS)	Diesel	Turbo Intercooled	TD16354





F9Q 738	4cyl.	1870cc	59-79kW (80-107PS)	Diesel	Turbo Intercooled	TD21137
F9Q 740	4cyl.	1870cc	75kW (102PS)	Diesel	Turbo Intercooled	TD16341
F9Q 744	4cyl.	1870cc	59kW (80PS)	Diesel	Turbo Intercooled	TD16361
F9Q 748	4cyl.	1870cc	74-79kW (101-107PS)	Diesel	Turbo Intercooled	TD21138
F9Q 752	4cyl.	1870cc	74-77kW (101-105PS)	Diesel	Turbo Intercooled	TD21139
F9Q 754	4cyl.	1870cc	74-79kW (101-107PS)	Diesel	Turbo Intercooled	TD20841
F9Q 760	4cyl.	1870cc	60-75kW (82-102PS)	Diesel	Turbo Intercooled	TD16529
F9Q 762	4cyl.	1870cc	60kW (82PS)	Diesel	Turbo Intercooled	TD18691
F9Q 770	4cyl.	1870cc	59kW (80PS)	Diesel	Turbo Intercooled	TD15688
F9Q 772	4cyl.	1870cc	60kW (82PS)	Diesel	Turbo Intercooled	TD16304
F9Q 774	4cyl.	1870cc	60kW (82PS)	Diesel	Turbo Intercooled	TD19370
F9Q 780	4cyl.	1870cc	59kW (80PS)	Diesel	Turbo Intercooled	TD16339
F9Q 782	4cyl.	1870cc	59-62kW (80-84PS)	Diesel	Turbo Intercooled	TD17498
F9Q 790	4cyl.	1870cc	59-62kW (80-84PS)	Diesel	Turbo Intercooled	TD16358
F9Q 796	4cyl.	1870cc	75kW (102PS)	Diesel	Turbo Intercooled	TD24972

CLIO II 1.9 dTi	12/99→05/05	MEGANE I 1.9 DTi	02/00→09/00
CLIO II 1.9 DTi	02/00→05/01	Megane I van 1.9 dCi	04/01→07/03
KANGOO 1.9 dCi	10/01→	Megane I van 1.9 DTi	04/01→07/03
KANGOO 1.9 dTi	02/00→	MEGANE Scenic 1.9 dTi	04/97→09/99
KANGOO Express 1.9 dCi	10/01→	MEGANE Scenic VAN 1.9 DTi	04/97→09/99
KANGOO Express 1.9 dTi	02/00→	SCÉNIC I MPV 1.9 dCi	09/99→08/03
LAGUNA I 1.9 dCi	09/99→03/01	SCÉNIC I MPV 1.9 dCi RX4	11/00→08/03
LAGUNA I 1.9 dTi	10/97→03/01	SCÉNIC I MPV 1.9 DTi	09/99→08/03
LAGUNA II 1.9 dCi	03/01→12/07	SCÉNIC I VAN 1.9 DTi	09/99→04/01
LAGUNA II 1.9 dCi	06/01→05/05	TRAFIC II 1.9 dCi	03/01→
MASTER II 1.9 dCi 80	11/01→	TRAFIC II 1.9 dCi 80	03/01→10/06
MASTER II 1.9 dTi	09/00→	TRAFIC II 1.9 dCi 80	03/01→10/06
MEGANE I 1.9 dCi	03/99→08/03	TRAFIC II 1.9 dCi 100	03/01→10/06
MEGANE I 1.9 DCi	03/99→08/03	TRAFIC II 1.9 dCi 100	03/01→10/06
MEGANE I 1.9 dTi	03/97→08/03		

87-101500-00 STD
87-101507-00 0.50mm

A 47.06
B- 17.80
BØ 38.00
C 0.75
D 77.00
 28x60



AK RT TP

08-101500-00 STD
08-101507-00 0.50mm

2.50  MO P
 2.00  P
 3.00  CR P

14-020280-00 D **B** 83.00 **C** 155.00 **D** 85.00 **E** 5.00

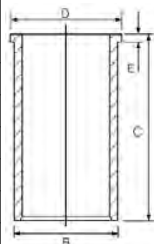

80.00

27

F9Q 870	4cyl.	1870cc	96kW (131PS)	Diesel	Turbo Intercooled	TD23617
F9Q 872	4cyl.	1870cc	96kW (131PS)	Diesel	Turbo Intercooled	TD23555
GRAND SCÉNIC III 1.9 dCi			02/09→	SCÉNIC III 1.9 dCi		02/09→
MEGANE CC 1.9 dCi			06/10→	SCÉNIC III VAN 1.9 dCi		01/13→
MEGANE III 1.9 dCi			11/08→			





87-422300-10 STD
87-422307-10 0.50mm

08-422300-00 STD
08-422307-00 0.50mm

A 47.00
B- 13.25
BØ 48.00
C 0.35
D 70.00
 28x64



2.50 MO P
 2.00 P
 3.00 CR P

AK KK RT TP

80.00

28

R9M 402	4cyl.	1598cc	96kW (130PS)	Diesel	Turbo Intercooled	TD26297
R9M 404	4cyl.	1598cc	96kW (130PS)	Diesel	Turbo Intercooled	TD26298
R9M 408	4cyl.	1598cc	66-85kW (90-116PS)	Diesel	Turbo Intercooled	TD32296
R9M 409	4cyl.	1598cc	96kW (130PS)	Diesel	Turbo Intercooled	TD31368
R9M 413	4cyl.	1598cc	70-89kW (95-121PS)	Diesel	Turbo Intercooled	TD32995
R9M 414	4cyl.	1598cc	96kW (130PS)	Diesel	Turbo Intercooled	TD32298
R9M 450	4cyl.	1598cc	88-107kW (120-145PS)	Diesel	Turbo Intercooled	TD32297
R9M 452	4cyl.	1598cc	92-120kW (125-163PS)	Diesel	Turbo Intercooled	TD31369
R9M 453	4cyl.	1598cc	92-118kW (125-160PS)	Diesel	Turbo Intercooled	TD33141

ESPACE V 1.6 dCi 130	06/15→	SCÉNIC III VAN 1.6 dCi	01/13→
ESPACE V 1.6 dCi 160	06/15→	SCÉNIC IV 1.6 dCi 130	09/16→
FLUENCE 1.6 dCi	07/14→	SCÉNIC IV 1.6 dCi 160	09/16→
GRAND SCÉNIC III 1.6 dCi	04/11→	TALISMAN 1.6 dCi 130	11/15→
GRAND SCÉNIC IV 1.6 dCi 130	09/16→	TALISMAN 1.6 dCi 160	06/15→
GRAND SCÉNIC IV 1.6 dCi 160	09/16→	TRAFIC III 1.6 dCi 90	05/14→
KADJAR 1.6 dCi 130	06/15→	TRAFIC III 1.6 dCi 95	07/15→
KOLEOS II 1.6 dCi 130	04/16→	TRAFIC III 1.6 dCi 115	05/14→
MEGANE CC 1.6 dCi	04/11→	TRAFIC III 1.6 dCi 120	05/14→
MEGANE III 1.6 dCi	04/11→	TRAFIC III 1.6 dCi 125	07/15→
MEGANE IV 1.6 dCi 130	11/15→	TRAFIC III 1.6 dCi 140	05/14→
MEGANE IV 1.6 dCi 165	11/15→	TRAFIC III 1.6 dCi 145	07/15→
SCÉNIC III 1.6 dCi	04/11→		

87-424900-00 STD
87-424907-00 0.50mm

08-424900-00 STD
08-424907-00 0.50mm

A 46.00
B- 12.35
BØ 46.50
C 0.30
D 70.50
 30x60



2.00 CK P
 1.75 P
 2.00 CR P

AK KK RT TP

84.00

29

M9R 610	4cyl.	1995cc	118-120kW (160-163PS)	Diesel	Turbo Intercooled	TD23557
M9R 615	4cyl.	1995cc	110kW (150PS)	Diesel	Turbo Intercooled	TD23559
M9R 630	4cyl.	1995cc	66-84kW (90-114PS)	Diesel	Turbo Intercooled	TD26729
M9R 692 (Euro 5)	4cyl.	1995cc	84kW (114PS)	Diesel	Turbo Intercooled	TD26569
M9R 828	4cyl.	1995cc	131kW (178PS)	Diesel	Turbo Intercooled	TD31477
M9R 844	4cyl.	1995cc	127kW (173PS)	Diesel	Turbo Intercooled	TD26533
M9R 846	4cyl.	1995cc	110kW (150PS)	Diesel	Turbo Intercooled	TD26534
M9R 854	4cyl.	1995cc	96-127kW (131-173PS)	Diesel	Turbo Intercooled	TD31478





M9R 856	4cyl.	1995cc	110kW (150PS)	Diesel	Turbo Intercooled	TD26249
M9R 857	4cyl.	1995cc	127kW (173PS)	Diesel	Turbo Intercooled	TD31479
M9R 858	4cyl.	1995cc	96-127kW (131-173PS)	Diesel	Turbo Intercooled	TD31480
M9R 859	4cyl.	1995cc	127kW (173PS)	Diesel	Turbo Intercooled	TD31481
M9R 862	4cyl.	1995cc	110kW (150PS)	Diesel	Turbo Intercooled	TD26255
M9R 864	4cyl.	1995cc	127kW (173PS)	Diesel	Turbo Intercooled	TD26256
M9R 865	4cyl.	1995cc	110-127kW (150-173PS)	Diesel	Turbo Intercooled	TD26250
M9R 866	4cyl.	1995cc	110kW (150PS)	Diesel	Turbo Intercooled	TD26251

ESPACE IV 2.0 dCi	01/06→	LATITUDE 2.0 dCi 150	02/11→
GRAND SCÉNIC III 2.0 dCi	02/09→	LATITUDE 2.0 dCi 175	05/11→
KOLEOS I 2.0 dCi	09/08→	MEGANE CC 2.0 dCi	06/10→
LAGUNA 2.0 dCi	09/08→12/15	MEGANE III 2.0 dCi	04/09→
LAGUNA 2.0 dCi GT	09/08→12/15	SCÉNIC III 2.0 dCi	02/09→
LAGUNA III 2.0 dCi	10/07→12/15	TRAFIC II 2.0 dCi 90	08/06→
LAGUNA III 2.0 dCi GT	03/08→12/15	TRAFIC II 2.0 dCi 115	08/06→

87-422000-10 STD

87-422007-10 0.50mm

A 48.00
B- 14.00
BØ 50.00
D 76.00
 32x65



KK RT TP

08-422000-00 STD

08-422007-00 0.50mm

2.50  MOL P
 2.00  MOL P
 2.00  CR P

84.00

30

M9R 700	4cyl.	1995cc	110kW (150PS)	Diesel	Turbo Intercooled	TD20708
M9R 721	4cyl.	1995cc	110kW (150PS)	Diesel	Turbo Intercooled	TD23502
M9R 722	4cyl.	1995cc	110kW (150PS)	Diesel	Turbo Intercooled	TD23503
M9R 724	4cyl.	1995cc	127kW (173PS)	Diesel	Turbo Intercooled	TD22195
M9R 740	4cyl.	1995cc	96-110kW (131-150PS)	Diesel	Turbo Intercooled	TD19680
M9R 742	4cyl.	1995cc	96-110kW (131-150PS)	Diesel	Turbo Intercooled	TD23504
M9R 744	4cyl.	1995cc	96-110kW (131-150PS)	Diesel	Turbo Intercooled	TD23505
M9R 746	4cyl.	1995cc	110kW (150PS)	Diesel	Turbo Intercooled	TD23506
M9R 748	4cyl.	1995cc	110kW (150PS)	Diesel	Turbo Intercooled	TD23507
M9R 750	4cyl.	1995cc	96-110kW (131-150PS)	Diesel	Turbo Intercooled	TD23508
M9R 760	4cyl.	1995cc	96-127kW (131-173PS)	Diesel	Turbo Intercooled	TD19681
M9R 761	4cyl.	1995cc	96-127kW (131-173PS)	Diesel	Turbo Intercooled	TD23899
M9R 762	4cyl.	1995cc	96-127kW (131-173PS)	Diesel	Turbo Intercooled	TD23900
M9R 763	4cyl.	1995cc	96-127kW (131-173PS)	Diesel	Turbo Intercooled	TD23901
M9R 780 (Euro 4)	4cyl.	1995cc	66-84kW (90-114PS)	Diesel	Turbo Intercooled	TD19714
M9R 782	4cyl.	1995cc	66-84kW (90-114PS)	Diesel	Turbo Intercooled	TD23109
M9R 784	4cyl.	1995cc	84kW (114PS)	Diesel	Turbo Intercooled	TD25141
M9R 786 (Euro 4)	4cyl.	1995cc	66-84kW (90-114PS)	Diesel	Turbo Intercooled	TD24966
M9R 788	4cyl.	1995cc	84kW (114PS)	Diesel	Turbo Intercooled	TD25142
M9R 800	4cyl.	1995cc	127kW (173PS)	Diesel	Turbo Intercooled	TD22196
M9R 802	4cyl.	1995cc	96-110kW (131-150PS)	Diesel	Turbo Intercooled	TD22197
M9R 804	4cyl.	1995cc	127kW (173PS)	Diesel	Turbo Intercooled	TD26134
M9R 805 (Euro 4)	4cyl.	1995cc	110kW (150PS)	Diesel	Turbo Intercooled	TD26244
M9R 809	4cyl.	1995cc	127kW (173PS)	Diesel	Turbo Intercooled	TD22198
M9R 815	4cyl.	1995cc	110-127kW (150-173PS)	Diesel	Turbo Intercooled	TD26531





M9R 816	4cyl.	1995cc	127-132kW (173-180PS)	Diesel	Turbo Intercooled	TD22199
M9R 817	4cyl.	1995cc	127kW (173PS)	Diesel	Turbo Intercooled	TD26135
M9R 820	4cyl.	1995cc	131kW (178PS)	Diesel	Turbo Intercooled	TD26532
M9R 824	4cyl.	1995cc	110kW (150PS)	Diesel	Turbo Intercooled	TD26073
M9R 830	4cyl.	1995cc	127-130kW (173-177PS)	Diesel	Turbo Intercooled	TD22206
M9R 832	4cyl.	1995cc	110kW (150PS)	Diesel	Turbo Intercooled	TD22207

ESPACE IV 2.0 dCi	01/06→	LATITUDE 2.0 dCi 150	02/11→
GRAND SCÉNIC II 2.0 dCi	09/05→11/08	LATITUDE 2.0 dCi 175	05/11→
KOLEOS I 2.0 dCi	09/08→	MEGANE II 2.0 dCi	09/05→
LAGUNA 2.0 dCi	09/08→12/15	SCÉNIC II 2.0 dCi	09/05→11/08
LAGUNA 2.0 dCi GT	09/08→12/15	TRAFIC II 2.0 dCi 90	08/06→
LAGUNA II 2.0 dCi	08/05→12/07	TRAFIC II 2.0 dCi 115	08/06→
LAGUNA III 2.0 dCi	10/07→12/15	VEL SATIS 2.0 dCi	08/05→
LAGUNA III 2.0 dCi GT	03/08→12/15		

87-422000-00 STD
87-422007-00 0.50mm

A 47.92
B- 14.90
BØ 49.07
C 0.40
C 0.40
D 76.00
 32x65



AK KK RT TP

08-422000-00 STD
08-422007-00 0.50mm

2.50  MOL P
 2.00  MOL P
 2.00  CR P

85.00

31

M9T 670 (Euro 5)	4cyl.	2298cc	74-92kW (101-125PS)	Diesel	Turbo Intercooled	TD24269
M9T 672 (Euro 5)	4cyl.	2298cc	74-92kW (101-125PS)	Diesel	Turbo Intercooled	TD25154
M9T 676 (Euro 4)	4cyl.	2298cc	74-92kW (101-125PS)	Diesel	Turbo Intercooled	TD24268
M9T 678	4cyl.	2298cc	107kW (146PS)	Diesel	Turbo Intercooled	TD25158
M9T 680	4cyl.	2298cc	92-107kW (125-145PS)	Diesel	Turbo Intercooled	TD24295
M9T 686 (Euro 5)	4cyl.	2298cc	92kW (125PS)	Diesel	Turbo Intercooled	TD25151
M9T 690 (Euro 5)	4cyl.	2298cc	74-92kW (101-125PS)	Diesel	Turbo Intercooled	TD24270
M9T 692 (Euro 4)	4cyl.	2298cc	74-96kW (101-130PS)	Diesel	Turbo Intercooled	TD24271
M9T 694 (Euro 4)	4cyl.	2298cc	107-110kW (146-150PS)	Diesel	Turbo Intercooled	TD24272
M9T 696 (Euro 4)	4cyl.	2298cc	92-110kW (125-150PS)	Diesel	Turbo Intercooled	TD25150
M9T 698 (Euro 5)	4cyl.	2298cc	92-110kW (125-150PS)	Diesel	Turbo Intercooled	TD24273
M9T 702 (Euro 5)	4cyl.	2298cc	96-120kW (136-163PS)	Diesel	Turbo Intercooled	TD32303
M9T 870 (Euro 4/5)	4cyl.	2299cc	74-92kW (100-125PS)	Diesel	Turbo Intercooled	TD29755
M9T 872 (Euro 4/5)	4cyl.	2298cc	92kW (125PS)	Diesel	Turbo Intercooled	TD38300
M9T 880 (Euro 5)	4cyl.	2298cc	92-110kW (125-150PS)	Diesel	Turbo Intercooled	TD29756
M9T 882 (Euro 4)	4cyl.	2298cc	92-96kW (125-131PS)	Diesel	Turbo Intercooled	TD38372
M9T 890 (Euro 5)	4cyl.	2298cc	74-92kW (100-125PS)	Diesel	Turbo Intercooled	TD29758
M9T 896 (Euro 4)	4cyl.	2298cc	92-110kW (125-150PS)	Diesel	Turbo Intercooled	TD29759
M9T 898 (Euro 5)	4cyl.	2298cc	92-110kW (125-150PS)	Diesel	Turbo Intercooled	TD29757

MASTER III 2.3 dCi 100	02/10→	MASTER III 2.3 dCi 135	07/14→
MASTER III 2.3 dCi 100 RWD	02/10→	MASTER III 2.3 dCi 145	02/10→
MASTER III 2.3 dCi 110	09/14→	MASTER III 2.3 dCi 145 RWD	02/10→
MASTER III 2.3 dCi 125	02/10→	MASTER III 2.3 dCi 150	10/12→
MASTER III 2.3 dCi 125 RWD	02/10→	MASTER III 2.3 dCi 150 RWD	03/13→
MASTER III 2.3 dCi 130	03/12→	MASTER III 2.3 dCi 165	07/14→





87-435200-00 STD
87-435207-00 0.50mm

A 48.00
B- 16.20
BØ 50.00
C 0.45
D 76.00
 32x65



AK KK RT TP

08-435200-00 STD
08-435207-00 0.50mm

2.50  GDC P
 2.00  MO P
 2.00  CR P



87.00

32

G9T 605 (Euro 4)	4cyl.	2188cc	102kW (139PS)	Diesel	Turbo Intercooled	TD19682
G9T 606 (Euro 4)	4cyl.	2188cc	78-102kW (106-139PS)	Diesel	Turbo Intercooled	TD21209
G9T 642	4cyl.	2188cc	95-110kW (129-150PS)	Diesel	Turbo Intercooled	TD23177
G9T 645 (Euro 4)	4cyl.	2188cc	102kW (139PS)	Diesel	Turbo Intercooled	TD21198
G9T 700	4cyl.	2188cc	83-110kW (113-150PS)	Diesel	Turbo Intercooled	TD20978
G9T 702 (Euro 3)	4cyl.	2188cc	83-110kW (113-150PS)	Diesel	Turbo Intercooled	TD16288
G9T 703	4cyl.	2188cc	110kW (150PS)	Diesel	Turbo Intercooled	TD16377
G9T 704	4cyl.	2188cc	110kW (150PS)	Diesel	Turbo Intercooled	TD20975
G9T 706	4cyl.	2188cc	102-110kW (139-150PS)	Diesel	Turbo Intercooled	TD20976
G9T 707	4cyl.	2188cc	102-110kW (139-150PS)	Diesel	Turbo Intercooled	TD20977
G9T 742 (Euro 3)	4cyl.	2188cc	110kW (150PS)	Diesel	Turbo Intercooled	TD17062
G9T 743 (Euro 3)	4cyl.	2188cc	110kW (150PS)	Diesel	Turbo Intercooled	TD17063
ESPACE III 2.2 dCi			10/00→10/02	LAGUNA II 2.2 dCi		10/01→12/07
ESPACE IV 2.2 dCi			11/02→	VEL SATIS 2.2 dCi		06/02→

87-127400-10 STD
87-127407-10 0.50mm

A 54.53
B- 17.50
BØ 40.40
C 1.70
C 2.00
D 84.20
 31x65



AK KK RT TP

08-127400-00 STD
08-127407-00 0.50mm

3.00  PS P
 1.75  P
 2.50  P

87.00

33

G9T 607	4cyl.	2188cc	102-110kW (139-150PS)	Diesel	Turbo Intercooled	TD23896
G9T 710	4cyl.	2188cc	85-95kW (115-130PS)	Diesel	Turbo Intercooled	TD16310
G9T 720	4cyl.	2188cc	66kW (90PS)	Diesel	Turbo Intercooled	TD14928
G9T 722	4cyl.	2188cc	66kW (90PS)	Diesel	Turbo Intercooled	TD16302
G9T 750	4cyl.	2188cc	66kW (90PS)	Diesel	Turbo Intercooled	TD19088
ESPACE III 2.2 dCi			07/00→10/02	VEL SATIS 2.2 dCi		09/04→
MASTER II 2.2 dCi 90			09/00→			





87-127400-00 STD
87-127407-00 0.50mm

- A 54.53
 - B- 17.50
 - BØ 40.40
 - C 2.00
 - D 84.20
- 
- 31x65



AK RT TP

08-127400-00 STD
08-127407-00 0.50mm

- 3.00  PS P
- 1.75  P
- 2.50  P

89.00

34

G9U 632 (Euro 4)	4cyl.	2464cc	88-107kW (120-146PS)	Diesel	Turbo Intercooled	TD21013
G9U 650 (Euro 4)	4cyl.	2464cc	74-88kW (101-120PS)	Diesel	Turbo Intercooled	TD21011

MASTER II 2.5 dCi 08/06→

87-137500-30 STD
87-137507-30 0.50mm

- A 53.07
 - B- 16.10
 - B- 4.90
 - BØ 48.00
 - C 2.00
 - C 1.60
 - D 83.09
- 
- 31x65



AK RT TP

08-137500-00 STD
08-137507-00 0.50mm

- 3.00  MO P
- 1.75  P
- 2.50  P

89.00

35

G9U 720 (Euro 3)	4cyl.	2464cc	84kW (115PS)	Diesel	Turbo Intercooled	TD16303
G9U 724 (Euro 3)	4cyl.	2464cc	84-85kW (115-116PS)	Diesel	Turbo Intercooled	TD19366
G9U 730 (Euro 3)	4cyl.	2464cc	99kW (135PS)	Diesel	Turbo Intercooled	TD18275
G9U 750 (Euro 3)	4cyl.	2464cc	84kW (115PS)	Diesel	Turbo Intercooled	TD19359
G9U 754 (Euro 3)	4cyl.	2464cc	73-85kW (99-115PS)	Diesel	Turbo Intercooled	TD19085

MASTER II 2.5 dCi 10/04→02/12 MASTER II 2.5 dCi 120 10/01→
 MASTER II 2.5 dCi 100 10/03→ TRAFIC II 2.5 dCi 135 03/01→10/06

87-137500-10 STD
87-137507-10 0.50mm

- A 53.03
 - B- 17.85
 - BØ 43.20
 - C 1.65
 - C 1.90
 - D 83.09
- 
- 31x65



AK RT TP

08-137500-10 STD
08-137507-10 0.50mm

- 2.50  MO P
- 1.75  P
- 2.50  CR P

93.00

36

8140-07 (Sofim)	4cyl.	2500cc	55kW (75PS)	Diesel		TD8524
8140.07.2530	4cyl.	2500cc	56kW (76PS)	Diesel		TD3417
8140.07.2585 (Euro 1)	4cyl.	2500cc	55kW (75PS)	Diesel		TD12192
8140.07.2700	4cyl.	2500cc	55kW (75PS)	Diesel		TD22385







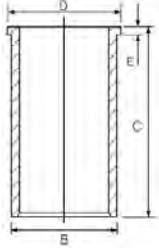

8140.07.2701 (Sofim)	4cyl.	2500cc	55kW (75PS)	Diesel	Turbo	MP9101
8140.07.2710 (Sofim)	4cyl.	2500cc	55kW (75PS)	Diesel	Turbo	MP9101-1
8140.07.3700 (Euro 1)	4cyl.	2500cc	55kW (75PS)	Diesel	Turbo Intercooled	TD22386
8140.27.2565 (Sofim)	4cyl.	2500cc	78kW (106PS)	Diesel	Turbo	TD12197
8140.27.2585	4cyl.	2500cc	78kW (106PS)	Diesel	Turbo	TD12195
8140-27 IDS	4cyl.	2500cc	78kW (106PS)	Diesel	Turbo	TD8530
8140.67.2580 (Euro 2)	4cyl.	2500cc	55kW (75PS)	Diesel		TD3433
8140.67.2585 (Euro 2)	4cyl.	2500cc	55kW (75PS)	Diesel	Turbo Intercooled	TD12193

MASTER 2.5D				TRAFIC 2.5 D		05/89→03/01
				14-021371-00 D	B 96.01 C 171.00 D 98.92 E 5.00	
				14-021372-00 D	B 96.05 C 171.00 D 98.92 E 5.00	
						

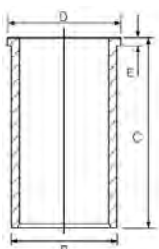



93.00 **37**

8140.21.235 (SOFIM 2.4TD)	4cyl.	2445cc	68-71kW (92-96PS)	Diesel	Turbo	TD3418
90 2.5 TD			04/86→09/90	B90 2.5 TD		08/90→01/92

87-245200-30 STD				14-021371-00 D	B 96.01 C 171.00 D 98.92 E 5.00	
				14-021372-00 D	B 96.05 C 171.00 D 98.92 E 5.00	
A 59.65		08-245200-00 STD				
B- 14.80		08-245208-00 0.60mm				
BØ 51.90		3.00 	CR P			
D 97.65		2.00 	P			
 32x75		3.00 	CR P			
RT						

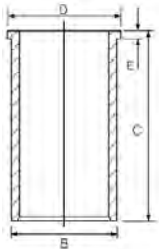
93.00 **38**

8140.27 (Sofim)	4cyl.	2500cc	78kW (106PS)	Diesel	Turbo	TD8529
8140.27.2582	4cyl.	2500cc	92kW (125PS)	Diesel	Turbo	TD3424
8140.27.2700	4cyl.	2500cc	68-76kW (92-103PS)	Diesel	Turbo	TD21392

B90 2.5 TD				MASTER 2.5 TD		
87-245200-40 STD				14-021371-00 D	B 96.01 C 171.00 D 98.92 E 5.00	
				14-021372-00 D	B 96.05 C 171.00 D 98.92 E 5.00	
A 58.75		08-245200-00 STD				
B- 17.90		08-245208-00 0.60mm				
BØ 38.00		3.00 	CR P			
D 96.75		2.00 	P			
 32x75		3.00 	CR P			
RT						

93.00 **39**

8140.27.2560	4cyl.	2500cc	69kW (94PS)	Diesel	Turbo	TD8623
--------------	-------	--------	-------------	--------	-------	--------





8140-47	4cyl.	2500cc	85kW (116PS)	Diesel	Turbo Intercooled	TD8533
8140.47.2530 IDR (Sofim)	4cyl.	2500cc	85kW (116PS)	Diesel	Turbo Intercooled	TD3425
8140.47.2535	4cyl.	2500cc	85kW (116PS)	Diesel	Turbo Intercooled	TD3426
8140.47.2585 (Euro 1)	4cyl.	2500cc	85kW (116PS)	Diesel	Turbo Intercooled	TD3428
8140.47.2590 (Euro 1)	4cyl.	2500cc	85kW (116PS)	Diesel	Turbo Intercooled	TD12199
8140.47.2700 (Euro 1)	4cyl.	2500cc	85kW (116PS)	Diesel	Turbo Intercooled	TD22395
8140.47.2721 (Euro 1)	4cyl.	2500cc	85kW (116PS)	Diesel	Turbo Intercooled	TD22396
8140.47.2785 (Euro 1)	4cyl.	2500cc	85kW (116PS)	Diesel	Turbo Intercooled	TD22397
S9U 702	4cyl.	2500cc	69-72kW (94-98PS)	Diesel	Turbo	TD12731
S9U 714	4cyl.	2500cc	69kW (94PS)	Diesel	Turbo	TD12732
S9U 740	4cyl.	2500cc	69kW (94PS)	Diesel	Turbo	TD12728

MASTER I 2.5 DT
MASTER I 28-35 2,5 TD

11/89→02/98
08/89→07/98

MASTER I 35 2,5 TD

08/89→07/98

87-520200-00 STD

A 58.75
B- 18.40
BØ 38.00
D 96.75
32x78



AK KK NB RT

08-520200-00 STD

3.00 CR
2.00 P
3.00 CR P



14-021371-00 D

14-021372-00 D

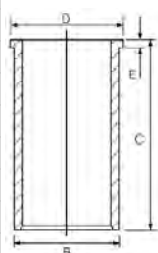

B 96.01 C 171.00 D 98.92 E 5.00

B 96.05 C 171.00 D 98.92 E 5.00

93.00

40

8140.61.235	4cyl.	2445cc	53kW (72PS)	Diesel		TD3430
8140.61.240 (Sofim)	4cyl.	2445cc	51kW (69PS)	Diesel	Turbo Intercooled	TD12871
8140.61.2300	4cyl.	2445cc	52kW (71PS)	Diesel		TD3429
8140.67.2500	4cyl.	2500cc	55kW (75PS)	Diesel		TD3431
8140.67.2550	4cyl.	2500cc	55kW (75PS)	Diesel		TD12872
S8U 720 (SOFIM 2.4D)	4cyl.	2445cc	51kW (69PS)	Diesel		TD3413
S8U 722 (SOFIM 2.4D)	4cyl.	2445cc	51kW (69PS)	Diesel		TD3414
S8U 730 (SOFIM 2.4D)	4cyl.	2445cc	52kW (71PS)	Diesel		TD12873
S8U 731	4cyl.	2445cc	50-53kW (68-72PS)	Diesel		TD12730
S8U 742	4cyl.	2500cc	55kW (75PS)	Diesel		TD5442
S8U 748	4cyl.	2445cc	55kW (75PS)	Diesel		TD12735
S8U 750	4cyl.	2500cc	55kW (75PS)	Diesel		TD5566
S8U 752	4cyl.	2500cc	55kW (75PS)	Diesel		TD5567
S8U 758	4cyl.	2500cc	55-58kW (75-79PS)	Diesel		TD9689
S8U 780	4cyl.	2500cc	55kW (75PS)	Diesel		TD16328
S8U 782	4cyl.	2500cc	55kW (75PS)	Diesel		TD16329

MASTER I 2.4 D

MASTER I 2.5 D

MASTER I 28-35 2,5 D

07/80→02/98

07/80→10/89

08/89→07/98

MASTER I 28-35 2.4 D

MASTER I 28-35 2.5 D

TRAFIC 2.5 D

08/80→08/89

09/80→07/98

03/80→03/01





14-022560-00 *D* **B 96.00 C 167.30 D 98.90 E 5.00**
14-028930-00 *D* **B 97.50 C 167.00 D 100.90 E 5.00**
14-028931-00 *D* **B 97.58 C 167.00 D 100.90 E 5.00**
14-028932-00 *D* **B 97.70 C 167.00 D 100.90 E 5.00**

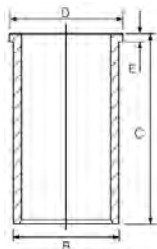

94.40						41
8140.23.2585 (Euro 2 Sofim)	4cyl.	2800cc	76kW (103PS)	Diesel	Turbo Intercooled	TD12194
8140.43.2585 (Euro 2 Sofim)	4cyl.	2800cc	90kW (122PS)	Diesel	Turbo Intercooled	TD12198
8140.43.3700 (Euro 2 Sofim)	4cyl.	2800cc	90kW (122PS)	Diesel	Turbo Intercooled	TD22394
8140.43.C.2586 (Euro 2 Sofim)	4cyl.	2800cc	78kW (106PS)	Diesel	Turbo Intercooled	TD14090
S9W 700	4cyl.	2800cc	84kW (114PS)	Diesel	Turbo Intercooled	TD19362
S9W 702	4cyl.	2800cc	84kW (114PS)	Diesel	Turbo	TD13408

MASTER II 2.8 dTI

07/98→10/01

87-122200-10 *STD*
87-122208-10 *0.60mm*
 01/98→

A 58.75
B- 19.40
BØ 39.25
D 87.60
 32x72



AK KK RT TP

08-122200-00 *STD*
08-122208-00 *0.60mm*

2.50  CK P
 2.00  P
 2.50  CR P

14-021321-00 *D* **B 97.54 C 167.00 D 100.90 E 5.00**
14-028930-00 *D* **B 97.50 C 167.00 D 100.90 E 5.00**
14-028931-00 *D* **B 97.58 C 167.00 D 100.90 E 5.00**
14-028932-00 *D* **B 97.70 C 167.00 D 100.90 E 5.00**

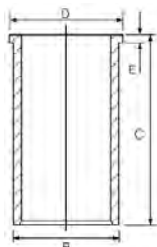

94.40						42
8140.43.C.3586 (Euro 3 Sofim)	4cyl.	2800cc	78kW (106PS)	Diesel	Turbo Intercooled	TD17194
8140.43.C.3588 (Euro 3 Sofim)	4cyl.	2800cc	78kW (106PS)	Diesel	Turbo Intercooled	TD17195

14-021321-00 *D* **B 97.54 C 167.00 D 100.90 E 5.00**
14-028930-00 *D* **B 97.50 C 167.00 D 100.90 E 5.00**
14-028931-00 *D* **B 97.58 C 167.00 D 100.90 E 5.00**
14-028932-00 *D* **B 97.70 C 167.00 D 100.90 E 5.00**

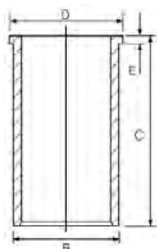

94.40						43
8140.43N.3585 (Euro 3 Sofim)	4cyl.	2800cc	107kW (146PS)	Diesel	Turbo Intercooled	TD17197
8140.43.S.2585 (Euro 3 Sofim)	4cyl.	2800cc	92-94kW (125-128PS)	Diesel	Turbo Intercooled	TD14091





8140.43.S.3585 (Euro 3 Sofim) 4cyl. 2800cc 92-94kW (125-128PS) Diesel Turbo Intercooled TD17196

87-122200-00 STD
87-122208-00 0.60mm

A 58.70
B- 21.30
BØ 39.40
D 87.60
 32x72

AK KK RT TP



08-122200-00 STD
08-122208-00 0.60mm

2.50  CK P
2.00  P
2.50  CR P

14-021321-00 D
14-028930-00 D
14-028931-00 D
14-028932-00 D

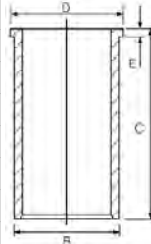

B 97.54 C 167.00 D 100.90 E 5.00
B 97.50 C 167.00 D 100.90 E 5.00
B 97.58 C 167.00 D 100.90 E 5.00
B 97.70 C 167.00 D 100.90 E 5.00

94.40

44

8140.63.2585 (Euro 2 Sofim) 4cyl. 2800cc 63-64kW (86-87PS) Diesel TD14089

87-108200-00 STD
87-108208-00 0.60mm

A 55.00
B- 2.80
D 90.00
 32x68

AK HA RT TP



08-108200-00 STD
08-108208-00 0.60mm

3.00  CR P
2.00  P
2.50  CR P

14-021321-00 D
14-028930-00 D
14-028931-00 D
14-028932-00 D

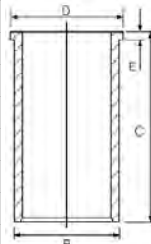

B 97.54 C 167.00 D 100.90 E 5.00
B 97.50 C 167.00 D 100.90 E 5.00
B 97.58 C 167.00 D 100.90 E 5.00
B 97.70 C 167.00 D 100.90 E 5.00

98.00

45

712-01-03	4cyl.	3320cc	53kW (72PS)	Diesel	TD3019
712-01-04	4cyl.	3320cc	54kW (73PS)	Diesel	TD3020
714	4cyl.	3320cc		Diesel	MP4359

INDUSTRIAL

14-261790-00 WH

B 114.00 C 220.70 D 120.90 E 8.00 F 0.70

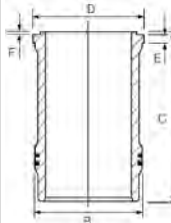

102.00

46

720-12	4cyl.	3590cc	67-72kW (90-98PS)	Diesel	TD8609
--------	-------	--------	-------------------	--------	--------

MIDLINER

05/84→12/94





14-265940-00 WH ① B 114.00 C 220.70 D 120.70 E 8.00 F 0.70

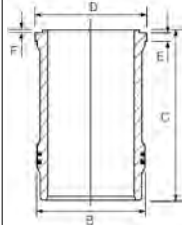

① Phosphated

① Phosphatiert

① Phosphaté

① Fosfatado

① Fosfatato

102.00

47

DCI 4-B (Euro 3)	4cyl.	4120cc	112kW (152PS)	Diesel	Turbo Intercooled	TD17333
DCI 4-C (Euro 3)	4cyl.	4120cc	128kW (174PS)	Diesel	Turbo Intercooled	TD17335
DCI 6 A (Euro 3)	6cyl.	6177cc	195kW (265PS)	Diesel	Turbo Intercooled	TD17339
DCI 6 W (Euro 3)	6cyl.	6177cc	158kW (215PS)	Diesel	Turbo Intercooled	TD17338

MIDLUM 01/00→ PREMIUM 04/96→

87-435000-00 STD

08-435000-00 STD

15-480090-00 WH ① B 114.00 C 218.00 D 122.50 E 8.00 F 0.80

89-435000-00

A 71.20
B- 21.90
BØ 60.00
C 0.80
D 108.30
42x84



3.50 CK
2.50 CR
4.00 CR

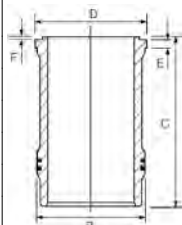

87-435000-00 +
15-480090-00

① Includes seals

① Schließt Dichtungen ein

① Inclut des joints

① Incluye los sellos

① Comprende le guarnizioni

102.00

48

MIDR 04.02.26 A/4 (Euro 2)	4cyl.	4118cc	100kW (136PS)	Diesel	Turbo Intercooled	TD14509
MIDR 04.02.26 B/4 (Euro 2)	4cyl.	4118cc	110kW (150PS)	Diesel	Turbo Intercooled	TD14510
MIDR 06.02.26 W/4 (Euro 2)	6cyl.	6177cc	154kW (209PS)	Diesel	Turbo Intercooled	TD14511

MIDLUM 01/00→ PREMIUM 04/96→

87-522900-00 STD

08-522900-00 STD

15-480090-00 WH ① B 114.00 C 218.00 D 122.50 E 8.00 F 0.80

89-522900-00 ①

A 71.23
B- 20.83
BØ 60.00
C 0.85
D 105.20
42x84



3.50 M0
2.50 CR
4.00 CR

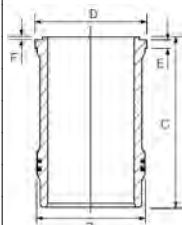

87-522900-00 +
15-480090-00

① Includes seals

① Schließt Dichtungen ein

① Inclut des joints

① Incluye los sellos

① Comprende le guarnizioni

② Phosphated

② Phosphatiert

② Phosphaté

② Fosfatado

② Fosfatato

102.00

49

797-20	6cyl.	5491cc	95-98kW (129-133PS)	Diesel	Turbo	TD8607
797-21	6cyl.	5491cc	76kW (103PS)	Diesel		TD8658
797-26	6cyl.	5491cc	98kW (133PS)	Diesel	Turbo	TD8593

MIDLINER 09/83→09/90





87-346500-00 STD

A 77.80
B- 38.40
D 131.70
 36x86



RT

08-346500-10 STD

3.00  CR P
 2.50  P
 5.00  CR P

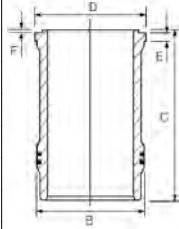

15-265960-00 WH ① ② **B** 114.00 **C** 234.00 **D** 122.50 **E** 8.00 **F** 0.80
14-265960-00 WH ② **B** 114.00 **C** 234.30 **D** 122.50 **E** 8.00 **F** 0.80
14-265950-00 WH ② **B** 114.00 **C** 235.30 **D** 121.00 **E** 8.00 **F** 0.80

89-346500-10 ①
 87-346500-00 +
 15-265960-00

① Includes seals
 ② Phosphated

① Schließt Dichtungen ein
 ② Phosphatiert

① Inclut des joints
 ② Phosphaté

① Incluye los sellos
 ② Fosfatado

① Comprende le guarnizioni
 ② Fosfatato

102.00

50

798-10	6cyl.	5491cc	113kW (154PS)	Diesel	Turbo	TD6210
798-20	6cyl.	5491cc	113kW (154PS)	Diesel	Turbo	TD8606

MIDLINER 05/83→07/86

14-265950-00 WH ① **B** 114.00 **C** 235.30 **D** 121.00 **E** 8.00 **F** 0.80
15-265960-00 WH ① ② **B** 114.00 **C** 234.00 **D** 122.50 **E** 8.00 **F** 0.80
14-265960-00 WH ① **B** 114.00 **C** 234.30 **D** 122.50 **E** 8.00 **F** 0.80

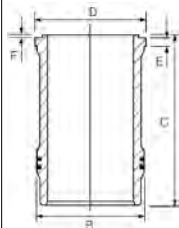

① Phosphated
 ② Includes seals

① Phosphatiert
 ② Schließt Dichtungen ein

① Phosphaté
 ② Inclut des joints

① Fosfatado
 ② Incluye los sellos

① Fosfatato
 ② Comprende le guarnizioni

102.00

51

MIDR 06.02.12	6cyl.	5491cc	128-134kW (173-182PS)	Diesel	Turbo Intercooled	TD8547
MIDR 06.02.12 B	6cyl.	5491cc	117kW (159PS)	Diesel	Turbo Intercooled	TD8644
MIDR 06.02.12 C	6cyl.	5491cc	121-133kW (170-181PS)	Diesel	Turbo Intercooled	TD5985
MIDR 06.02.12 D	6cyl.	5491cc	127-134kW (172-182PS)	Diesel	Turbo Intercooled	TD8583
MIDS 06.02.12	6cyl.	5491cc	107kW (145PS)	Diesel	Turbo	TD8545
MIDS 06.02.12 B	6cyl.	5453cc	113-117kW (154-159PS)	Diesel	Turbo	TD8608
MIDS 06.02.12 C	6cyl.	5491cc	97-103kW (132-140PS)	Diesel	Turbo	TD8615
MIDS 06.02.12 D/3	6cyl.	5491cc	110kW (150PS)	Diesel	Turbo	TD14068

G 05/83→02/90 MIDLINER 10/82→05/96

87-522900-40 STD

A 78.25
B- 20.17
BØ 56.00
C 1.40
D 123.25
 42x84

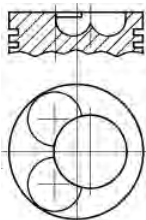

RT

08-522900-00 STD

3.50  MO
 2.50  CR
 4.00  CR

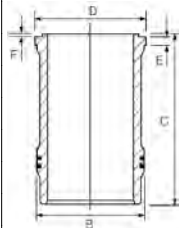

15-265960-00 WH ① ② **B** 114.00 **C** 234.00 **D** 122.50 **E** 8.00 **F** 0.80
14-265960-00 WH ② **B** 114.00 **C** 234.30 **D** 122.50 **E** 8.00 **F** 0.80
15-480090-00 WH ① **B** 114.00 **C** 218.00 **D** 122.50 **E** 8.00 **F** 0.80

89-522900-40 ①
 87-522900-40 +
 15-265960-00

89-522900-50 ①
 87-522900-40 +
 15-480090-00

① Includes seals
 ② Phosphated

① Schließt Dichtungen ein
 ② Phosphatiert

① Inclut des joints
 ② Phosphaté

① Incluye los sellos
 ② Fosfatado



① Comprende le guarnizioni
 ② Fosfatato



102.00 52

MIDR 06.02.26	6cyl.	6177cc	159kW (216PS)	Diesel	Turbo Intercooled	TD14049
MIDR 06.02.26 V/4 (Euro 2)	6cyl.	6177cc	132kW (180PS)	Diesel	Turbo Intercooled	TD14508
MIDR 06.02.26 V/41 (Euro 2)	6cyl.	6177cc	132kW (180PS)	Diesel	Turbo Intercooled	TD12248
MIDR 06.02.26 U/4 (Euro 2)	6cyl.	6177cc	110kW (150PS)	Diesel	Turbo Intercooled	TD12208
MIDR 06.02.26 Y/41 (Euro 2)	6cyl.	6177cc	184kW (250PS)	Diesel	Turbo Intercooled	TD8639

MIDLINER	09/87→01/00	PREMIUM	04/96→
MIDLUM	01/00→	Premium	02/96→12/01

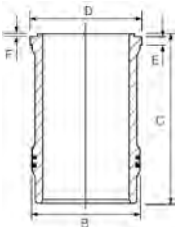

87-522900-10 STD ① A 71.23 B- 20.83 BØ 60.00 C 0.85 D 108.20  42x84 RT	08-522900-00 STD  3.50 MO 2.50 CR 4.00 CR	15-480090-00 WH ② B 114.00 C 218.00 D 122.50 E 8.00 F 0.80 15-265960-00 WH ② ③ B 114.00 C 234.00 D 122.50 E 8.00 F 0.80 14-265960-00 WH ③ B 114.00 C 234.30 D 122.50 E 8.00 F 0.80 	89-522900-10 ② 87-522900-10 + 15-480090-00
--	---	---	---

- | | | | | |
|--------------------------|------------------------------------|--|--------------------------------|----------------------------------|
| ① Bowl capacity 51.36cm3 | ① Volumen der Kolbenmulde 51.36cm3 | ① Volume de la cavité du piston 51.36cm3 | ① Vol. cavidad pistón 51.36cm3 | ① Volume camera pistone 51.36cm3 |
| ② Includes seals | ② Schließt Dichtungen ein | ② Inclut des joints | ② Incluye los sellos | ② Comprende le guarnizioni |
| ③ Phosphated | ③ Phosphatiert | ③ Phosphaté | ③ Fosfatado | ③ Fosfatato |

102.00 53

MIDR 06.02.26 D	6cyl.	6177cc	166kW (226PS)	Diesel	Turbo Intercooled	TD5862
MIDR 06.02.26 H	6cyl.	6177cc	133-144kW (181-196PS)	Diesel	Turbo Intercooled	TD5645
MIDR 06.02.26 V (Euro 1)	6cyl.	6177cc	129-132kW (175-180PS)	Diesel	Turbo Intercooled	TD8618
MIDR 06.02.26 X (Euro 1)	6cyl.	6177cc	166kW (226PS)	Diesel	Turbo Intercooled	TD8536
MIDR 06.02.26 Q	6cyl.	6177cc	137-140kW (186-190PS)	Diesel	Turbo Intercooled	TD8584
MIDR 06.02.26 U (Euro 1)	6cyl.	6177cc	110kW (150PS)	Diesel	Turbo Intercooled	TD8616
MIDR 06.02.26 W (Euro 1)	6cyl.	6177cc	151kW (205PS)	Diesel	Turbo Intercooled	TD8587

C	05/90→10/98	MAXTER	10/92→05/95
G	02/90→09/91	MIDLINER	09/87→01/00
MANAGER	09/91→10/96		

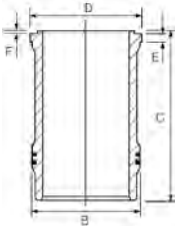
87-522900-30 STD A 71.18 B- 20.80 BØ 58.80 C 0.50 D 108.20  42x84 RT	08-522900-00 STD  3.50 MO 2.50 CR 4.00 CR	15-480090-00 WH ① B 114.00 C 218.00 D 122.50 E 8.00 F 0.80 15-265960-00 WH ① ② B 114.00 C 234.00 D 122.50 E 8.00 F 0.80 14-265960-00 WH ② B 114.00 C 234.30 D 122.50 E 8.00 F 0.80 	89-522900-30 ① 87-522900-30 + 15-480090-00
--	---	---	---

- | | | | | |
|------------------|---------------------------|---------------------|----------------------|----------------------------|
| ① Includes seals | ① Schließt Dichtungen ein | ① Inclut des joints | ① Incluye los sellos | ① Comprende le guarnizioni |
| ② Phosphated | ② Phosphatiert | ② Phosphaté | ② Fosfatado | ② Fosfatato |

108.00 54

DXI 5	4cyl.	4800cc	118-162kW (160-220PS)	Diesel	Turbo Intercooled	TD19015
DXI 7	6cyl.	7200cc	177-247kW (240-340PS)	Diesel	Turbo Intercooled	TD19016

MIDLUM	05/06→	PREMIUM 2	10/05→
--------	--------	-----------	--------





87-430000-00 STD

A 70.90
B- 19.60
BØ 64.50
D 107.80
45x86



KK RT TP

08-430000-00 STD

3.00 CK
2.00
3.50 CR



15-480450-00 WH ① B 120.00 C 228.00 D 131.70 E 8.06

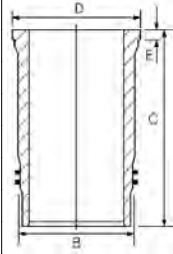

89-430000-00 ①
87-430000-00 +
15-480450-00

① Includes seals

① Schließt Dichtungen ein

① Inclut des joints

① Incluye los sellos

① Comprende le guarnizioni

120.00

55

MIDR 06.20.45	6cyl.	9771cc	214-222kW (291-302PS)	Diesel	Turbo Intercooled	TD8414
MIDR 06.20.45 I41 (Euro 2)	6cyl.	9839cc	188kW (256PS)	Diesel	Turbo Intercooled	TD12191
MIDS 06.20.30	6cyl.	8822cc	159-169kW (216-230PS)	Diesel	Turbo	TD8595
MIDS 06.20.30 N	6cyl.	8822cc	153kW (208PS)	Diesel	Turbo	TD8535
MIDS 06.20.30 N1	6cyl.	8822cc	162kW (220PS)	Diesel	Turbo	TD8586
MIPS 06.20.30	6cyl.	8820cc	166kW (225PS)	Diesel	Turbo	TD8626

AGORA	01/96→	MANAGER	09/91→03/93
C	12/83→05/91	TB	06/80→
G	11/83→02/90		

15-480050-00 WH ① B 135.00 C 261.00 D 147.30 E 9.28 F 0.90
15-480070-00 WH ① B 135.00 C 261.00 D 147.30 E 9.35 F 0.80
14-480070-00 WH B 135.00 C 261.00 D 147.30 E 9.35 F 0.80

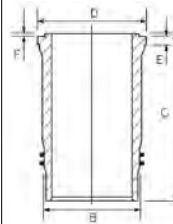

① Includes seals

① Schließt Dichtungen ein

① Inclut des joints

① Incluye los sellos

① Comprende le guarnizioni

120.00

56

MIDR 06.20.45 A	6cyl.	9839cc	192kW (260PS)	Diesel	Turbo Intercooled	TD8591
MIDR 06.20.45 C	6cyl.	9839cc	206-210kW (280-285PS)	Diesel	Turbo Intercooled	TD8580
MIPR 06.20.45 A3	6cyl.	9840cc	222kW (302PS)	Diesel	Turbo Intercooled	TD8635
MIPR 06.20.45 C3	6cyl.	9840cc	152kW (206PS)	Diesel	Turbo	TD8629

Midliner	01/85→12/90	PR	01/87→12/89
----------	-------------	----	-------------

87-131500-00 STD ①

A 83.80
B- 23.34
BØ 74.00
D 134.80
50x97



AK RT

08-131500-10 STD

3.25 CR P
3.00 CR P
4.00 CR P



15-480070-00 WH ② B 135.00 C 261.00 D 147.30 E 9.35 F 0.80
14-480070-00 WH B 135.00 C 261.00 D 147.30 E 9.35 F 0.80
15-480050-00 WH ② B 135.00 C 261.00 D 147.30 E 9.28 F 0.90

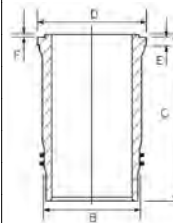

89-131400-40 ②
87-131500-00 +
15-480070-00

89-131500-30 ②
87-131500-00 +
15-480050-00

① < 290 CV

② Includes seals

② Schließt Dichtungen ein

② Inclut des joints

② Incluye los sellos

② Comprende le guarnizioni



120.00						57
MIDR 06.20.45 A2	6cyl.	9839cc	202kW (275PS)	Diesel	Turbo Intercooled	TD8579
MIDR 06.20.45 C/4 (Euro 2)	6cyl.	9839cc	188kW (256PS)	Diesel	Turbo Intercooled	TD17421
MIDR 06.20.45 D/41 (Euro 2)	6cyl.	9839cc	219-221kW (298-300PS)	Diesel	Turbo Intercooled	TD8641
MIDR 06.20.45 M41 (Euro 2)	6cyl.	9839cc	250kW (340PS)	Diesel	Turbo Intercooled	TD21231
MIHR 06.20.45 A41 (Euro 2)	6cyl.	9839cc	185kW (252PS)	Diesel	Turbo Intercooled	TD21269
ARES			04/98→12/03	MAXTER		02/96→06/97
FR1			01/83→	PREMIUM		04/96→
ILIADE			04/98→	Premium		02/96→12/01
KERAX			06/97→	TRACER		01/91→

15-450190-00 WH B 135.00 C 256.75 D 147.50 E 9.38 F 0.75

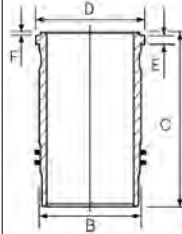

15-480070-00 WH B 135.00 C 261.00 D 147.30 E 9.35 F 0.80
 14-480070-00 WH B 135.00 C 261.00 D 147.30 E 9.35 F 0.80
 15-480080-00 WH B 135.00 C 261.00 D 147.30 E 9.38 F 0.70
 14-480080-00 WH B 135.00 C 261.00 D 147.30 E 9.38 F 0.70

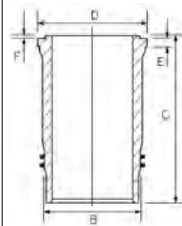









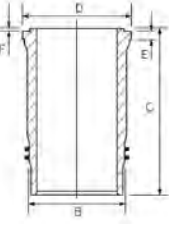
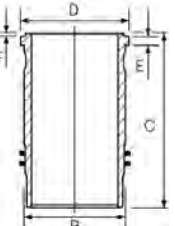
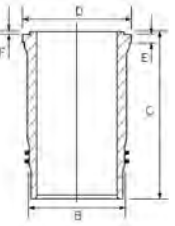

Includes seals Schließt Dichtungen ein Inclut des joints Incluye los sellos Comprende le guarnizioni

120.00						58
MIDR 06.20.45 B3 (Euro 1)	6cyl.	9839cc	195kW (265PS)	Diesel	Turbo Intercooled	TD8592
MIDR 06.20.45 D3 (Euro 1)	6cyl.	9839cc	222kW (302PS)	Diesel	Turbo Intercooled	TD8539
MIDR 06.20.45 E	6cyl.	9839cc	240-249kW (326-339PS)	Diesel	Turbo Intercooled	TD5860
MIDR 06.20.45 E2 (Euro 1)	6cyl.	9839cc	249kW (339PS)	Diesel	Turbo Intercooled	TD8540
MIDR 06.20.45 E/41 (Euro 2)	6cyl.	9839cc	249kW (338PS)	Diesel	Turbo Intercooled	TD8642
MIDR 06.20.45 H	6cyl.	9839cc	227-240kW (310-326PS)	Diesel	Turbo Intercooled	TD6209
MIDS 06.20.45 B	6cyl.	9839cc	192-202kW (260-275PS)	Diesel	Turbo	TD8537
C			10/82→10/98	Manager		01/94→12/97
FR1			01/83→	MAXTER		10/92→06/97
G			10/82→09/91	Maxter		01/94→12/97
KERAX			06/97→	PREMIUM		04/96→
MAJOR			05/91→10/96	R		05/88→05/91
MANAGER			09/91→10/96			



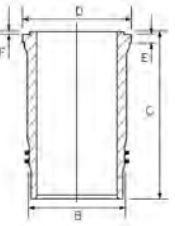

<p>87-337500-00 STD ¹</p> <p>A 83.80 B- 22.70 BØ 74.00 C 1.10 C 0.80 D 134.80  F 50x97</p> <p>AK RT</p> 	<p>08-337500-00 STD</p> <p>3.50  CK P 3.00  CR P 4.00  CR P</p>	<p>15-480080-00 WH ² B 135.00 C 261.00 D 147.30 E 9.38 F 0.70 14-480080-00 WH B 135.00 C 261.00 D 147.30 E 9.38 F 0.70</p> 	<p>89-337500-00 ² 87-337500-00 + 15-480080-00</p>
		<p>15-450190-00 WH ² B 135.00 C 256.75 D 147.50 E 9.38 F 0.75</p> 	<p>89-337500-40 ² 87-337500-00 + 15-450190-00</p>
		<p>15-480070-00 WH ² B 135.00 C 261.00 D 147.30 E 9.35 F 0.80 14-480070-00 WH B 135.00 C 261.00 D 147.30 E 9.35 F 0.80</p> 	
<p>87-337500-10 STD</p> <p>A 83.80 B- 23.35 BØ 70.00 C 1.10 D 134.80  F 50x97</p> <p>AK RT</p> 	<p>08-337500-00 STD</p> <p>3.50  CK P 3.00  CR P 4.00  CR P</p>	<p>15-480080-00 WH ² B 135.00 C 261.00 D 147.30 E 9.38 F 0.70 14-480080-00 WH B 135.00 C 261.00 D 147.30 E 9.38 F 0.70</p> 	<p>89-337500-10 ² 87-337500-10 + 15-480080-00</p>

¹ 290 CV >

² Includes seals

² Schließt Dichtungen ein

² Inclut des joints

² Incluye los sellos

² Comprende le guarnizioni

 120.00						59
MIDR 06.20.45 D	6cyl.	9839cc	210-222kW (286-302PS)	Diesel	Turbo Intercooled	TD8538
MIDR 06.20.45 E3 (Euro 1)	6cyl.	9839cc	249kW (339PS)	Diesel	Turbo Intercooled	TD8541
C			10/82→10/98	MANAGER		09/91→10/96
FR1			01/83→	Manager		01/94→12/97
G			11/85→08/91	MAXTER		10/92→06/97
MAJOR			05/91→10/96	Maxter		01/94→12/97





15-480080-00 WH **B 135.00 C 261.00 D 147.30 E 9.38 F 0.70**
14-480080-00 WH **B 135.00 C 261.00 D 147.30 E 9.38 F 0.70**

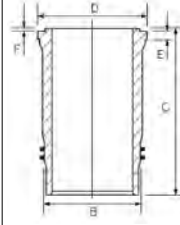

Includes seals Schließt Dichtungen ein Inclut des joints Incluye los sellos Comprende le guarnizioni

120.00							60
MIDR 06.20.45 DD (Euro 1)	6cyl.	9839cc	222kW (302PS)	Diesel	Turbo Intercooled		TD29107



87-337500-00 STD

A 83.80
B- 22.70
BØ 74.00
C 1.10
C 0.80
D 134.80
 50x97

AK RT



08-337500-00 STD

3.50  CK P
 3.00  CR P
 4.00  CR P



87-337500-10 STD

A 83.80
B- 23.35
BØ 70.00
C 1.10
D 134.80
 50x97

AK RT



08-337500-00 STD

3.50  CK P
 3.00  CR P
 4.00  CR P

290 CV >

120.00							61
MIPS 06.20.45	6cyl.	9840cc	137-186kW (186-253PS)	Diesel	Turbo Intercooled		TD8630
MIPS 06.20.45 A	6cyl.	9840cc	129kW (175PS)	Diesel	Turbo Intercooled		TD8631
MIPS 06.20.45 B	6cyl.	9840cc	176-186kW (240-253PS)	Diesel	Turbo Intercooled		TD8636
MIPS 06.20.45 C	6cyl.	9840cc	144kW (196PS)	Diesel	Turbo		TD8632

PR 01/87 → 12/90



87-337500-50 STD

A 83.80
B- 23.34
BØ 74.00
C 1.10
C 0.80
D 134.80
 50x97

AK RT



08-337500-00 STD

3.50  CK P
 3.00  CR P
 4.00  CR P

15-480070-00 WH **B 135.00 C 261.00 D 147.30 E 9.35 F 0.80**
14-480070-00 WH **B 135.00 C 261.00 D 147.30 E 9.35 F 0.80**

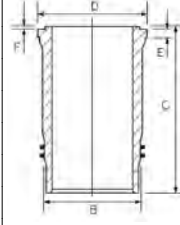

89-337500-50
 87-337500-50 +
 15-480070-00

Includes seals Schließt Dichtungen ein Inclut des joints Incluye los sellos Comprende le guarnizioni



123.00

62

DCI 11C (Euro 3) 6cyl. **11100cc** **303kW (412PS)** **Diesel Turbo Intercooled** **TD16880**

KERAX 01/01→ PREMIUM 08/00→

87-135500-10 STD

08-135500-10 STD

14-450920-00 WH

B 134.91 C 257.00 D 147.40 E 9.38 F 0.70

89-135500-10

- A** 78.48
- B-** 24.00
- BØ** 72.60
- C** 1.60
- D** 114.48
-  50x102





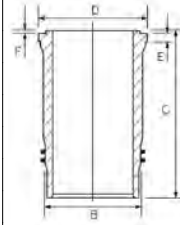

- 3.50  CK
- 3.00  CR
- 4.00  CR



87-135500-10 +
14-450920-00

TP

 Includes seals  Schließt Dichtungen ein  Inclut des joints  Incluye los sellos  Comprende le guarnizioni

123.00

63

DCI 11E (Euro 3) 6cyl. **11100cc** **266-268kW (362-364PS)** **Diesel Turbo Intercooled** **TD16879**

ILIADE 03/06→ PREMIUM 08/00→

KERAX 01/01→ Premium 01/02→12/07

14-450920-00 WH



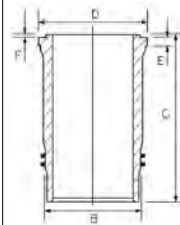

B 134.91 C 257.00 D 147.40 E 9.38 F 0.70

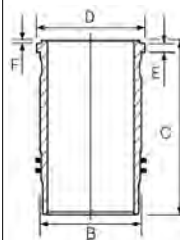

15-450220-00 WH

B 135.20 C 256.75 D 147.50 E 9.41 F 0.75



 Includes seals  Schließt Dichtungen ein  Inclut des joints  Incluye los sellos  Comprende le guarnizioni

123.00





64

DXI 11 (Euro 3/4) 6cyl. **10800cc** **243-339kW (330-460PS)** **Diesel Turbo** **TD19017**

KERAX 10/05→ PREMIUM 2 10/05→





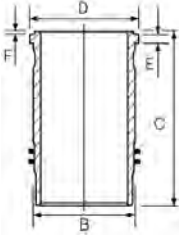



<p>87-438800-00 STD ①</p> <p>A 78.40 B- 17.00 BØ 83.60 C 1.00 C 1.00 D 111.70  54x73</p> <p>KK TP</p> 	<p>08-438800-00 STD ②</p> <p>3.50  PVD ③ 2.50  CR P 3.00  NT ③</p>	<p>15-480440-00 WH ④ 14-480440-00 WH</p> <p>B 139.00 C 249.55 D 149.00 E 11.20 F 0.85 B 139.00 C 249.55 D 149.00 E 11.20 F 0.85</p> 	<p>89-438800-00 ④ 87-438800-00 + 15-480440-00</p>
---	--	---	--

- ① MonoSteel ®
- ② Euro 4/5
- ③ Steel
- ④ Includes seals
- ③ Stahl
- ④ Schließt Dichtungen ein
- ③ Acier
- ④ Inclut des joints
- ③ Acero
- ④ Incluye los sellos
- ③ Acciaio
- ④ Comprende le guarnizioni

123.00						65
MIDR 06.23.56 A/3 (Euro 2)	6cyl.	11122cc	255kW (347PS)	Diesel	Turbo Intercooled	TD17528
MIDR 06.23.56 A/41 (Euro 2)	6cyl.	11122cc	280kW (381PS)	Diesel	Turbo Intercooled	TD8643
MIDR 06.23.56 B/41 (Euro 2)	6cyl.	11122cc	288kW (392PS)	Diesel	Turbo Intercooled	TD12207
ILIADE		01/97→		PREMIUM		04/96→
KERAX		06/97→		PREMIUM 2		10/05→08/07

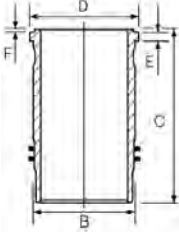
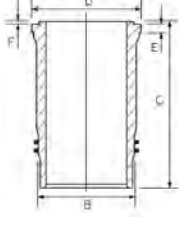

<p>87-135500-00 STD</p> <p>A 78.30 B- 24.00 BØ 75.00 C 1.20 D 120.30  50x97</p> <p>AK NB RT TP</p> 	<p>08-135500-10 STD</p> <p>3.50  CK 3.00  CR 4.00  CR</p>	<p>15-450220-00 WH ①</p> <p>B 135.20 C 256.75 D 147.50 E 9.41 F 0.75</p> 	<p>89-135500-30 ① 87-135500-00 + 15-450220-00</p>
		<p>14-450920-00 WH</p> <p>B 134.91 C 257.00 D 147.40 E 9.38 F 0.70</p> 	

- ① Includes seals
- ① Schließt Dichtungen ein
- ① Inclut des joints
- ① Incluye los sellos
- ① Comprende le guarnizioni



124.00						66
MACK E.TECH A/46 (Euro 2)	6cyl.	12000cc	295kW (401PS)	Diesel	Turbo Intercooled	TD14770
MACK E.TECH B/46 (Euro 2)	6cyl.	12000cc	324kW (441PS)	Diesel	Turbo Intercooled	TD14771
MACK E.TECH C/46 (Euro 2)	6cyl.	12000cc	347-353kW (472-480PS)	Diesel	Turbo Intercooled	TD14772
MAGNUM			05/00→			



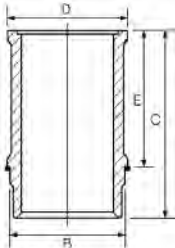

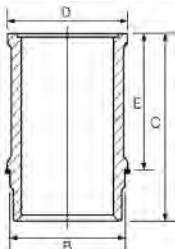

<p>87-429600-10 STD ①</p> <p>A 93.93 B- 26.20 BØ 76.65 C 2.41 D 144.93</p>  <p>AK TP</p>	<p>08-429600-10 STD</p> <p>3.17 2.38 4.72</p>  <p>CK P CR P CR P</p>	<p>14-740130-00 WH</p> <p>B 130.17 C 279.25 D 139.80 E 103.32</p> 	<p>88-429600-10 87-429600-10 + 14-740130-00</p>	
① Articulated piston	① Pendelschaftkolben	① Piston articulé	① Pistón articulado	① Pistone articolato

124.00					67
MIDR 06.24.65	6cyl.	11955cc	287-412kW (390-560PS)	Diesel Turbo Intercooled	TD29100
MIDR 06.24.65 A/42 (Euro 2)	6cyl.	11955cc	287kW (390PS)	Diesel Turbo Intercooled	TD12148
MIDR 06.24.65 B/42 (Euro 2)	6cyl.	11955cc	316kW (430PS)	Diesel Turbo Intercooled	TD12188
MIDR 06.24.65 C/42 (Euro 2)	6cyl.	11955cc	346kW (471PS)	Diesel Turbo Intercooled	TD12189
MAGNUM 09/96 →					



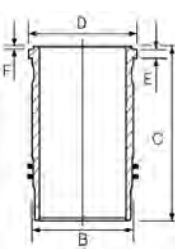
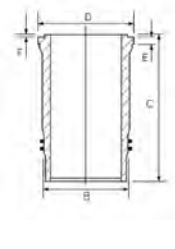

<p>87-429600-00 STD ①</p> <p>A 93.93 B- 26.30 BØ 82.12 C 2.41 C 2.41 D 142.30</p>  <p>AK</p>	<p>08-429600-10 STD</p> <p>3.17 2.38 4.72</p>  <p>CK P CR P CR P</p>	<p>14-740130-00 WH</p> <p>B 130.17 C 279.25 D 139.80 E 103.32</p> 	<p>88-429600-00 87-429600-00 + 14-740130-00</p>	
① Articulated piston	① Pendelschaftkolben	① Piston articulé	① Pistón articulado	① Pistone articolato

131.00					68
DXI 12 (Euro 3)	6cyl.	12130cc	324-353kW (441-480PS)	Diesel Turbo Intercooled	TD19083
MAGNUM 10/04 → 04/06					

<p>87-123200-00 STD</p> <p>A 87.22 B- 17.10 BØ 88.95 D 137.45</p>  <p>RT TP</p>	<p>08-123200-00 STD</p> <p>4.00 3.00 4.00</p>  <p>CK P P NT ①</p>	<p>15-450590-00 WH ② 14-450590-00 WH</p> <p>B 144.00 C 272.80 D 159.60 E 11.20 F 0.90 B 144.00 C 272.80 D 159.60 E 11.20 F 0.90</p> 	<p>89-123200-35 ② 87-123200-00 + 15-450590-00</p>
<p>15-451270-00 WH ② ④ B 144.00 C 272.80 D 159.60 E 11.20 F 0.90</p> 			



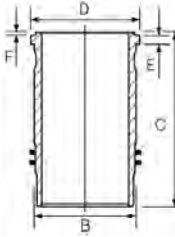



<p>87-123200-10 STD ③</p> <p>A 87.40 B- 17.21 BØ 89.00 D 125.70 55x107</p> <p>AK TP</p> 	<p>08-123200-00 STD</p> <p>4.00 3.00 4.00</p>  <p>CK P P NT ①</p>	<p>15-450590-00 WH ② 14-450590-00 WH</p> <p>B 144.00 C 272.80 D 159.60 E 11.20 F 0.90 B 144.00 C 272.80 D 159.60 E 11.20 F 0.90</p> 	<p>89-123200-10 ②</p> <p>87-123200-10 + 15-450590-00</p>
<p>87-123200-40 STD ③</p> <p>A 87.40 B- 19.72 BØ 86.00 D 129.40 55x107</p> <p>AK NB TP</p> 	<p>08-123200-00 STD</p> <p>4.00 3.00 4.00</p>  <p>CK P P NT ①</p>		

- ① Steel
- ② Includes seals
- ③ Articulated piston
- ④ G0E322 cavitation resistant material
- ① Stahl
- ② Schließt Dichtungen ein
- ③ Pendelschaftkolben
- ④ G0E322 kavitationsbeständiges Material
- ① Acier
- ② Inclut des joints
- ③ Piston articulé
- ④ Matériau G0E322 résistant à la cavitation
- ① Acero
- ② Incluye los sellos
- ③ Pistón articulado
- ④ Material resistente a la cavitación G0E322
- ① Acciaio
- ② Comprende le guarnizioni
- ③ Pistone articolato
- ④ G0E322, materiale resistente alla cavitazione

131.00							69
DXI 13 (Euro 4/5)	6cyl.	12800cc	323-382kW (440-520PS)	Diesel	Turbo Intercooled		TD19084
KERAX		05/06→	MAGNUM				05/06→

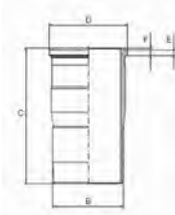
<p>87-434400-10 STD ①</p> <p>A 75.88 B- 18.10 BØ 89.00 D 112.90 58x76</p> <p>KK TP</p> 	<p>08-434400-00 STD</p> <p>3.50 2.50 3.00</p>  <p>PVD NT ② CR NT ②</p>	<p>15-451190-00 WH ③ 14-451190-00 WH</p> <p>B 144.00 C 261.80 D 159.60 E 11.20 F 0.90 B 144.00 C 261.80 D 159.60 E 11.20 F 0.90</p> 	
---	--	---	--

- ① MonoSteel ®
- ② Steel
- ③ Includes seals
- ① Stahl
- ② Schließt Dichtungen ein
- ③ Acier
- ② Inclut des joints
- ③ Acero
- ② Incluye los sellos
- ③ Acciaio
- ③ Comprende le guarnizioni

135.00							70
MDS 06.35.40	6cyl.	12024cc	177-208kW (241-283PS)	Diesel	Turbo Intercooled		TD8668
MIDR 06.35.40	6cyl.	12024cc	206-226kW (280-307PS)	Diesel	Turbo Intercooled		TD19965
MIDR 06.35.40 C	6cyl.	12024cc	224-228kW (305-310PS)	Diesel	Turbo Intercooled		TD8645
R		10/80→03/89	TBH				01/77→06/80





14-020330-00 *DH* **B 143.00 C 286.00 D 149.00 E 7.40**
 14-020510-00 *DH* **B 143.00 C 286.00 D 147.00 E 7.00**
 14-027200-00 *DH* **B 143.25 C 286.00 D 149.00 E 7.40**

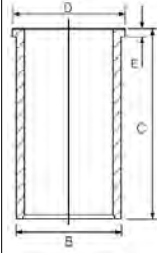

 135.00					71	
MIDR 06.35.40 G	6cyl.	12024cc	243-259kW (330-352PS)	Diesel	Turbo Intercooled	TD12202
MIDR 06.35.40 H	6cyl.	12024cc	264-279kW (359-380PS)	Diesel	Turbo Intercooled	TD8516
C		02/88→01/93		MAJOR		05/91→10/96
MAGNUM		09/90→06/92		R		03/86→05/91

87-335900-00 *STD*

A 90.30
B- 25.85
BØ 78.00
C 0.80
D 170.10
 55x112



AK RT

08-335900-00 *STD*

4.00  **MOL P**
 3.00  **P**
 4.00  **CR P**

14-020330-00 *DH* **B 143.00 C 286.00 D 149.00 E 7.40**

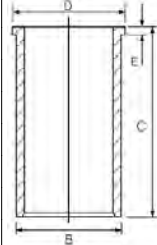

88-335900-00

87-335900-00 +
 14-020330-00

14-040040-00 *DH*

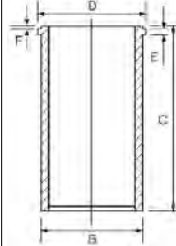

B 143.03 C 288.25 D 149.00 E 7.65 F 1.05

88-335900-10

87-335900-00 +
 14-040040-00

 135.00					72	
MIDR 06.35.40 J/3 (Euro 1)	6cyl.	12024cc	305kW (415PS)	Diesel	Turbo Intercooled	TD8519
MIDR 06.35.40 M/3 (Euro 1)	6cyl.	12024cc	236kW (321PS)	Diesel	Turbo Intercooled	TD8543
MIDR 06.35.40 N/3 (Euro 1)	6cyl.	12024cc	283kW (385PS)	Diesel	Turbo Intercooled	TD8518
C		10/92→10/98		MAJOR		05/91→10/96
MAGNUM		02/92→12/96				

87-335900-30 *STD*

A 90.40
B- 21.80
BØ 78.00
C 0.90
D 149.40
 55x108



NB RT

08-335900-00 *STD*

4.00  **MOL P**
 3.00  **P**
 4.00  **CR P**

14-040040-00 *DH*

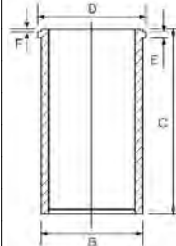

B 143.03 C 288.25 D 149.00 E 7.65 F 1.05

88-335900-30

87-335900-30 +
 14-040040-00



135.00 **73**

MIDR 06.35.40 J1 (Euro 1)	6cyl.	12024cc	314kW (427PS)	Diesel	Turbo Intercooled	TD8653
MIDR 06.35.40 L1	6cyl.	12024cc	283kW (385PS)	Diesel	Turbo Intercooled	TD8517
MIDR 06.35.40 P/41 (Euro 2)	6cyl.	12024cc	305kW (415PS)	Diesel	Turbo Intercooled	TD12187

MAGNUM 10/92→12/96 MAJOR 05/91→10/96

14-040040-00 DH B 143.03 C 288.25 D 149.00 E 7.65 F 1.05

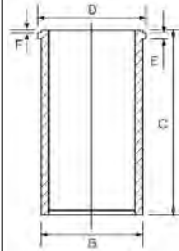

135.00 **74**

MIDS 06.35.40	6cyl.	12024cc	206kW (280PS)	Diesel	Turbo Intercooled	TD29112
MIDS 06.35.40 B	6cyl.	12024cc	225kW (306PS)	Diesel	Turbo Intercooled	TD29113

87-335300-00 STD

- A 90.30
- B- 29.10
- BØ 78.00
- C 0.80
- D 170.10
- 55x115



AK RT

08-335300-00 STD

- 3.50 CR P
- 3.00 P
- 6.00 CR P



135.00 **75**

MIDS 06.35.40 D	6cyl.	12024cc	208kW (283PS)	Diesel	Turbo	TD8542
-----------------	-------	---------	---------------	--------	-------	--------

C 04/86→10/92

87-335300-00 STD

- A 90.30
- B- 29.10
- BØ 78.00
- C 0.80
- D 170.10
- 55x115



AK RT

08-335300-00 STD

- 3.50 CR P
- 3.00 P
- 6.00 CR P



14-020330-00 DH B 143.00 C 286.00 D 149.00 E 7.40
 14-020510-00 DH B 143.00 C 286.00 D 147.00 E 7.00
 14-027200-00 DH B 143.25 C 286.00 D 149.00 E 7.40

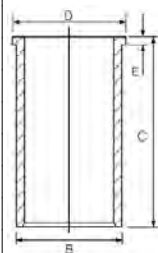

88-335300-00
 87-335300-00 +
 14-020330-00



CCM

x



9

3.5L CARBURETTOR	Petrol	3528	V8	88.86	13
11 D	Petrol	3528	V8	88.86	13
11 K2D	Petrol	1119	4	75.00	4
11 K4F	Petrol	1119	4	75.00	4
12 A2B	Petrol	1275	4	70.62	2
12 HE	Petrol	1275	4	70.62	2
12 HL	Petrol	1275	4	70.62	2
12 L (200TDi)	Diesel	2496	4	90.47	16
14 K2A	Petrol	1396	4	75.00	5
14 K2D	Petrol	1396	4	75.00	5
14 K2F	Petrol	1396	4	75.00	5
14 K4C	Petrol	1396	4	75.00	5
14 K4D	Petrol	1396	4	75.00	5
14 K4F	Petrol	1396	4	75.00	5
14 K4M	Petrol	1396	4	75.00	5
16 K4F (K Series)	Petrol	1588	4	80.00	7
18 K4F (K Series)	Petrol	1796	4	80.00	7
18 K4K (VVC)	Petrol	1796	4	80.00	8
19 L (300TDi)	Diesel	2496	4	90.47	17
20 T2N (L SERIES)	Diesel	1994	4	84.45	12
20 T2R (L SERIES)	Diesel	1994	4	84.45	12
21 L (300TDi)	Diesel	2495	4	90.47	17
22 D	Petrol	3531	V8	88.86	14
24 D	Petrol	3528	V8	88.86	14
25 D	Petrol	3528	V8	88.86	14
25 K4F	Petrol	2497	V6	80.00	9
30 A	Petrol	3528	V8	88.86	14
31 A	Petrol	3528	V8	88.86	14
31 D	Petrol	3528	V8	88.86	13
38 A	Petrol	3528	V8	88.86	13
39 A	Petrol	3528	V8	88.86	13
492 4 SHIRG	Diesel	2500	4	92.00	18
2286	Petrol	2286	4	90.47	15
A+ SERIES (12 A2D)	Petrol	1275	4	70.62	3
A+ SERIES (12 A2E)	Petrol	1275	4	70.62	3
A+ SERIES (12 H)	Petrol	1275	4	70.62	3
A SERIES (99 H)	Petrol	998	4	64.56	1
HR 492 HI	Diesel	2393	4	92.00	18
HR 492 HT	Diesel	2393	4	92.00	18
KV 6	Petrol	2497	V6	80.00	9
M 47 R	Diesel	1951	4	84.00	11
TUD5	Diesel	1527	4	77.00	6
VM-HR 492.4	Diesel	2393	4	92.00	18
XUD9	Diesel	1905	4	83.00	10



64.56 1

A SERIES (99 H)	4cyl.	998cc	26-34kW (35-46PS)	Petrol	TD27689
MINI 1000		08/90→06/93	MINI-MOKE 1.0		09/86→09/93

87-522400-00 STD ① ② A 34.09 B- 4.93 D 65.77 16x56 	08-522400-00 STD 08-522407-00 .020 1.58 P 1.58 P 4.00 CR P		
---	---	--	--

87-524307-10 .020 ① ③ 87-524311-10 .040 ① ③ 87-524314-10 .060 ① ③ A 33.86 D 53.79 16x51 	08-524300-10 STD 08-524307-10 .020 08-524311-10 .040 08-524314-10 .060 1.50 CK P 1.50 P 3.00 P		
--	---	--	--

- ① Pistons to be replaced in Engine Sets only ① Kolben nur in Motorsätzen zu ersetzen ① Piston à remplacer dans jeu moteur ① Pistones de repuesto para juegos de motores solamente ① Il pistone può essere rimpiazzato solamente completo
- ② Pin retained by circlips ② Bolzen mit Sicherungsclips gehalten ② Axe retenu par circlips ② Bulón retenido por anillos de retención ② Spinotto trattenuto da fermi
- ③ Piston pin press fit in conrod ③ Kolbenbolzen in Pleuel eingepreßt ③ Axe serré sur bielle ③ Bulón del pistón montado a presión en la biela ③ Spinotto inserito a spinta nella biella

70.62 2

12 A2B	4cyl.	1275cc	37kW (50PS)	Petrol	TD4880
12 HE	4cyl.	1275cc	49-51kW (67-69PS)	Petrol	TD26936
12 HL	4cyl.	1275cc	44-50kW (60-68PS)	Petrol	TD22905

100 / METRO 113	04/90→05/92	MINI 1300	04/92→11/00
MAESTRO 1.3	09/90→01/95	MONTEGO 1.3	10/84→10/88
METRO 1.3	04/90→05/92		

87-521700-00 STD ① 87-521707-00 .020 ① 87-521711-00 .040 ① 87-521714-00 .060 ① A 37.24 B- 5.74 D 57.24 21x56 	08-521700-00 STD 08-521707-00 .020 08-521711-00 .040 08-521714-00 .060 1.48 P 1.48 P 4.00 P	14-010890-00 D B 73.09 C 141.28 	
--	--	--	--

- ① Pistons to be replaced in Engine Sets only ① Kolben nur in Motorsätzen zu ersetzen ① Piston à remplacer dans jeu moteur ① Pistones de repuesto para juegos de motores solamente ① Il pistone può essere rimpiazzato solamente completo

70.62 3

A+ SERIES (12 A2D)	4cyl.	1275cc	39kW (53PS)	Petrol	TD3473
A+ SERIES (12 A2E)	4cyl.	1275cc	46kW (63PS)	Petrol	TD3487
A+ SERIES (12 H)	4cyl.	1275cc	47-48kW (64-65PS)	Petrol	TD22364

MINI 1.3 Cooper	01/92→10/96	MINI 1300	01/92→11/00
-----------------	-------------	-----------	-------------





- 87-524100-00 STD 1
- 87-524107-00 .020 1
- 87-524111-00 .040 1
- 87-524114-00 .060 1

A 38.74
B- 5.74
D 58.74
 21x56



- 08-524100-00 STD
- 08-524107-00 .020
- 08-524111-00 .040
- 08-524114-00 .060

1.50 NT
1.50 P
3.00 P

14-010890-00 D

B 73.09 C 141.28

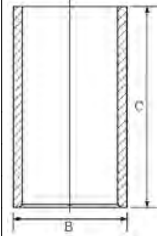

1 Pistons to be replaced in Engine Sets only 1 Kolben nur in Motorsätzen zu ersetzen 1 Piston à remplacer dans jeu moteur 1 Pistones de repuesto para juegos de motores solamente 1 Il pistone può essere rimpiazzato solamente completo

75.00					4
11 K2D	4cyl.	1119cc	44kW (60PS)	Petrol	TD4884
11 K4F	4cyl.	1119cc	55kW (75PS)	Petrol	TD18365
25 I 1.1		09/99→06/01		100 / METRO 111 C/L/S	03/90→12/98
25 I 1.1 16V		01/04→05/05		200 II 211	01/98→03/00
100 111		04/94→10/97			

14-710030-00 WH

B 84.10 C 129.50 D 87.50 E 50.00

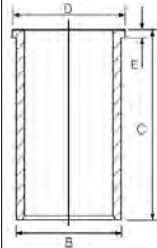

75.00					5
14 K2A	4cyl.	1396cc	55kW (75PS)	Petrol	TD3477
14 K2D	4cyl.	1396cc	55kW (75PS)	Petrol	TD3478
14 K2F	4cyl.	1396cc	55kW (75PS)	Petrol	TD9499
14 K4C	4cyl.	1396cc	66-70kW (90-95PS)	Petrol	TD3480
14 K4D	4cyl.	1396cc	66kW (90PS)	Petrol	TD3488
14 K4F	4cyl.	1396cc	76kW (103PS)	Petrol	TD3481
14 K4M	4cyl.	1396cc	62kW (84PS)	Petrol	TD18231
25 COMMERCE 1.4		01/03→12/05		200 II 214 1.4i 16V	01/93→11/99
25 I 1.4 16V		10/99→05/05		200 II 214 GSi/Si	01/90→10/95
45 I 1.4		02/00→05/05		200 II 214 i	11/95→03/00
100 114		04/94→10/98		200 II 214 Si	11/95→03/00
100 / METRO 114 GSi		10/94→10/95		200 II 214 Si/Gsi	10/89→10/95
100 / METRO 114 GTI 16V		03/90→12/98		400 II 414	01/93→12/99
100 / METRO 114 GTI/GT 16V Cat		03/90→12/98		400 II 414 GSi/Si	04/90→04/95
100 / METRO 114 S/L/GTA		03/90→12/98		400 II 414 GSi/Si Cat	10/92→04/95
200 II 1.4		01/96→12/97		400 II 414 Si	05/95→03/00
200 II 214		09/93→12/95		STREETWISE 1.4	08/03→05/05
200 II 214 1.4		04/90→11/99			



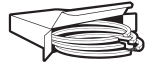

<p>87-520500-00 STD 01/95→</p> <p>A 23.84 D 46.79 18x48</p>	<p>08-520500-00 STD</p> <p>1.00 1 1.20 2.00 NT1</p>	<p>14-710030-00 WH B 84.10 C 129.50 D 87.50 E 50.00</p>	<p>88-520500-00 87-520500-00 + 14-710030-00</p>
1 Steel	1 Stahl	1 Acier	1 Acciaio

77.00 **6**

TUD5	4cyl.	1527cc	42kW (57PS)	Diesel	TD3490
100 / METRO 115 D		12/94→12/98			

<p>87-325800-00 STD 87-325806-00 0.40mm</p> <p>A 40.37 B- 1.65 D 66.32 23x60</p> <p>AK RT</p>	<p>08-325800-00 STD 08-325806-00 0.40mm</p> <p>2.00 CK P 1.75 P 3.00 CR P</p>		
--	--	--	--

80.00 **7**

16 K4F (K Series)	4cyl.	1588cc	80-86kW (109-117PS)	Petrol	TD9358
18 K4F (K Series)	4cyl.	1796cc	85-88kW (116-120PS)	Petrol	TD9483
18 K4F (K Series)	4cyl.	1796cc	88kW (120PS)	Petrol	TD11607

25 I 1.6 16V	10/99→05/05	200 II 216 1.6i 16V	01/96→11/99
25 I 1.8 16V	10/99→05/05	200 II 216 Si	11/95→06/99
45 I 1.6	02/00→05/05	200 II 218 Si	08/99→03/00
45 I 1.8	02/00→05/05	400 II 416 Si	05/95→03/00
75 1.8	02/99→05/05	COUPE 1.6 16 V	03/96→11/99
75 I 1.8	08/01→05/05	STREETWISE 1.6	01/04→05/05
200 216	01/96→12/97	STREETWISE 1.8	08/03→05/05

<p>87-522700-00 STD</p> <p>A 22.70 B- 0.53 BØ 68.20 C 2.65 D 45.65 18x53</p> <p>TP</p>	<p>08-522700-00 STD</p> <p>1.00 CR 1 1.20 P 2.00 CR 1</p>	<p>14-710020-00 WH B 84.10 C 129.50 D 87.50 E 50.00</p>	<p>88-522700-00 87-522700-00 + 14-710020-00</p>
1 Steel	1 Stahl	1 Acier	1 Acciaio

80.00 **8**

18 K4K (VVC)	4cyl.	1796cc	107-110kW (146-150PS)	Petrol	TD3500
---------------------	-------	---------------	------------------------------	---------------	---------------

25 I 1.8 16V	02/00→05/05	400 1.8 i	06/96→11/98
200 II 218 K Vi	11/95→03/00	COUPE 1.8 16 V	03/96→11/99





87-522700-10 *STD*

- A 22.70
- B- 0.53
- BØ 68.00
- C 1.00
- D 45.65
- 18x53



08-522700-00 *STD*

- 1.00 CR
- 1.20 P
- 2.00 CR

14-710020-00 *WH*

B 84.10 C 129.50 D 87.50 E 50.00

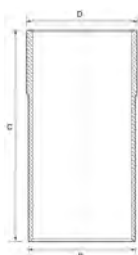

Steel

Stahl

Acier

Acero

Acciaio

80.00

9

25 K4F	V6cyl.	2497cc	129-130kW (175-177PS)	Petrol	TD9492
KV 6	V6cyl.	2497cc	129kW (175PS)	Petrol	TD11608
75 2.5 V6			02/99→05/05	800 2.5 Si	02/96→10/98
75 I 2.5 V6			08/01→05/05	800 825 Si	04/96→02/99
800 2.5			02/96→10/98	800 825 Si Lux	04/96→02/99

87-521600-00 *STD*

- A 27.35
- C 1.20
- D 50.30
- 18x53

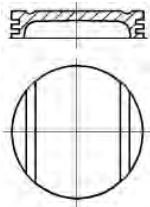

08-521600-00 *STD*

- 1.20 CR
- 1.50 CR
- 2.50 CR

14-710020-00 *WH*

B 84.10 C 129.50 D 87.50 E 50.00

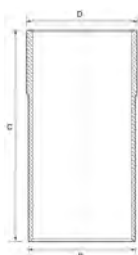

Steel

Stahl

Acier

Acero

Acciaio

83.00

10

XUD9	4cyl.	1905cc	47-52kW (64-71PS)	Diesel	TD32224
200 II 218 D			09/91→10/95	400 II 418 D	09/91→04/95

87-152000-10 *STD*

- 87-152007-10** 0.50mm
- 87-152010-10** 0.80mm

- A 46.80
- B- 2.20
- D 84.30
- 25x72



08-152000-00 *STD*

- 08-152003-00** 0.125mm
- 08-152007-00** 0.50mm
- 08-152010-00** 0.80mm

- 2.00 CR P
- 2.00 P
- 3.00 CR P

14-020530-00 *D*

B 85.60 C 153.50 D 88.50 E 3.90

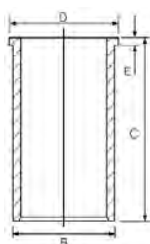

84.00

11

M 47 R	4cyl.	1951cc	85kW (116PS)	Diesel	Turbo Intercooled	TD11609
75 I 2.0 CDT			08/01→05/05			





87-114400-00 STD
87-114405-00 0.25mm

A 47.00
B- 15.05
BØ 41.70
C 1.30
D 71.00
 30x66

(08452-L160)
KK RT



08-114400-00 STD 
08-114405-00 0.25mm

3.00  CK P
 2.00  P
 3.00  CR P

 OE 1125 224 7383



 84.45						12
20 T2N (L SERIES)	4cyl.	1994cc	74-83kW (101-113PS)	Diesel	Turbo Intercooled	TD9496
20 T2R (L SERIES)	4cyl.	1994cc	63kW (86PS)	Diesel	Turbo Intercooled	TD9497
25 COMMERCE 2.0 iDT			01/03→12/05	400 II 420 D		11/95→03/00
25 I 2.0 iDT			10/99→05/05	400 II 420 Di		05/95→03/00
45 I 2.0 iDT			02/00→05/05	600 I 620 Sdi		05/94→06/99
200 II 220 D/SD			11/95→03/00	CDV 2.0 iDT		03/03→04/05
200 II 220 SDi			11/95→03/00	STREETWISE 2.0 TD		08/03→05/05

87-119800-00 STD
87-119807-00 0.50mm

A 47.97
B- 17.00
BØ 38.00
D 76.97
 30x70

AK RT TP



08-119800-00 STD 
08-119807-00 0.50mm 

3.00  PS
 2.00  P
 3.00  CR

 15 degree Wedge Top Ring

 15-Grad Keiloberring

 Segment trapézoïdal angle 15 de grés.

 Anillo superior en cuña de 15 grados

 Segmento trapezio con inclinazione fianchi = 15

 88.86						13
3.5L CARBURETTOR	V8cyl.	3528cc		Petrol		MP2683-1
11 D	V8cyl.	3528cc	93kW (126PS)	Petrol		TD3494
31 D	V8cyl.	3528cc	107kW (146PS)	Petrol		TD9484
38 A	V8cyl.	3528cc	115kW (156PS)	Petrol		TD9501
39 A	V8cyl.	3528cc	115kW (156PS)	Petrol		TD9500
2000-3500 3500			06/76→10/86	3500		01/77→12/86

87-520100-00 STD
87-520107-00 .020

A 47.37
B- 5.26
BØ 71.12
D 77.09
 22x73



08-520100-00 STD
08-520107-00 .020

1.58  CR P
 1.58  P
 4.73  P

 88.86						14
22 D	V8cyl.	3531cc	113kW (154PS)	Petrol		TD3498





24 D	V8cyl.	3528cc	120kW (163PS)	Petrol	TD3496
25 D	V8cyl.	3528cc	120kW (163PS)	Petrol	TD3495
30 A	V8cyl.	3528cc	142kW (193PS)	Petrol	TD3476
31 A	V8cyl.	3528cc	142kW (193PS)	Petrol	TD3475
2000-3500 3500 Vitesse			10/82→10/86		

87-520100-10 STD
87-520107-10 .020

A 47.17
B- 2.36
BØ 71.12
D 77.09
 22x73



08-520100-00 STD
08-520107-00 .020

1.58  CR P
1.58  P
4.73  P

90.47

15

2286	4cyl.	2286cc	Petrol	MP1533
80 Mk II			01/58→12/62 80 P4 01/58→12/62	

87-263107-00 .020

A 58.52
D 99.92
 25x76



08-263100-00 STD
08-263107-00 .020

1.79  CR P
1.79  P
4.74  P

14-010920-00 D B 94.50 C 191.36

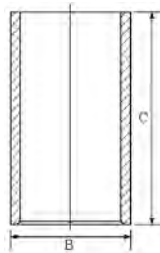

87-263100-10 STD
87-263107-10 .020

A 54.48
B- 0.91
D 89.23
 25x76



08-263100-00 STD
08-263107-00 .020

1.79  CR P
1.79  P
4.74  P

90.47

16

12 L (200TDI)	4cyl.	2496cc	83kW (113PS)	Diesel Turbo Intercooled	TD3461
2400 2.5 TDI			01/89→		

87-524400-00 STD

A 55.40
B- 18.85
BØ 39.50
D 91.90
 30x77

RT TP



08-524400-00 STD

2.50  CR P
2.00  P
3.00  CR P

14-010920-00 D B 94.50 C 191.36

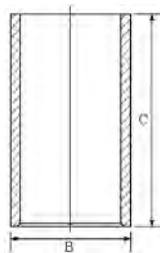



14-024710-00 *D* **B 94.52 C 191.36 D 99.70 E 4.76**

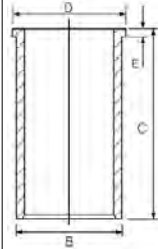

90.47

17

19 L (300TDi)	4cyl.	2496cc	83-90kW (113-122PS)	Diesel	Turbo Intercooled	TD9482
21 L (300TDi)	4cyl.	2495cc	83kW (113PS)	Diesel	Turbo Intercooled	TD15168
DISCOVERY I 2.5 TDI		06/94 → 10/96				

87-521800-20 *STD*
87-521807-20 *.020*
87-521811-20 *.040*

A 55.40
B- 18.45
BØ 39.00
D 91.90
 **30x77**



RT TP

08-521800-20 *STD*
08-521807-20 *.020*
08-521811-20 *.040*

3.00
 2.50
 3.00  **CR**

14-010920-00 *D* **B 94.50 C 191.36**

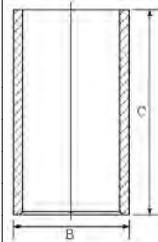

14-024710-00 *D* **B 94.52 C 191.36 D 99.70 E 4.76**

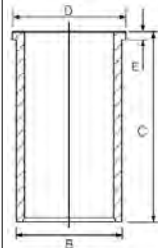

92.00

18

492 4 SHIRG	4cyl.	2500cc	87kW (118PS)	Diesel		TD3502
HR 492 HI	4cyl.	2393cc	81-84kW (110-114PS)	Diesel	Turbo Intercooled	TD22365
HR 492 HT	4cyl.	2393cc	67kW (91PS)	Diesel	Turbo Intercooled	TD22366
VM-HR 492.4	4cyl.	2393cc	89kW (121PS)	Diesel	Turbo Intercooled	TD3503
800 825 D/SD			01/90 → 02/99	2000-3500 2400 TD		05/82 → 10/86
800 825 SD			09/93 → 02/99			

15-676420-00 *WH*  **B 101.50 C 166.80 D 110.00 E 8.90 F 1.20**
14-676420-00 *WH* **B 101.50 C 166.80 D 110.00 E 8.90 F 1.20**

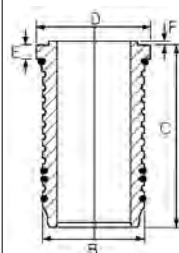

 Includes seals

 Schließt Dichtungen ein

 Inclut des joints

 Incluye los sellos

 Comprende le guarnizioni

Motorverzeichnis • Index de moteur • Índice de Motor
 Indeks silnika • Модель ДВИгателя • دليل المحرك

ENGINE INDEX



CCM

x



9

A16 LET (Euro 5)	Petrol	1598	4	79.00	1
A20 DTH (Euro 5)	Diesel	1956	4	83.00	6
B258I	Petrol	2498	V6	81.60	3
D223L	Diesel	2171	4	84.00	7
X22 DTH	Diesel	2171	4	84.00	7
Y22 DTH	Diesel	2171	4	84.00	7
Z18XE	Petrol	1796	4	80.50	2
Z19DT	Diesel	1910	4	82.00	5
Z19DTH	Diesel	1910	4	82.00	4
Z19 DTJ	Diesel	1910	4	82.00	4



79.00 **1**

A16 LET (Euro 5) 4cyl. **1598cc** **132kW** (180PS) **Petrol** **Turbo Intercooled** **TD24444**

9-5 1.6 Turbo 05/10→01/12

87-435500-00 STD
87-435507-00 0.50mm

A 27.50
B+ 0.60
D 45.10
 19x53



08-435500-00 STD
08-435507-00 0.50mm

1.20  NT
1.20  P
2.00  NT

HA TP

Steel Stahl Acier Acero Acciaio

80.50 **2**

Z18XE 4cyl. **1796cc** **90kW** (122PS) **Petrol** **TD18079**

9-3 1.8 i 01/04→02/15

87-141200-00 STD
87-141207-00 0.50mm

A 24.10
D 44.70
 18x55



08-141200-00 STD
08-141207-00 0.50mm

1.20  NT
1.20  P
2.00  CR

TP

Steel Stahl Acier Acero Acciaio

81.60 **3**

B258I V6cyl. **2498cc** **125-127kW** (170-173PS) **Petrol** **TD3526**

900 II 2.5 12/93→12/97 900 II 2.5 -24 V6 07/93→02/98

87-307700-00 STD
87-307707-00 0.50mm

A 30.45
B+ 0.36
C 2.40
D 51.03
 21x56



08-307700-00 STD
08-307707-00 0.50mm
08-307711-00 1.00mm

1.50  MO P
1.50  P
3.00  CR

Steel Stahl Acier Acero Acciaio

82.00 **4**

Z19DTH 4cyl. **1910cc** **110kW** (150PS) **Diesel** **Turbo Intercooled** **TD18084**

Z19 DTJ 4cyl. **1910cc** **88kW** (120PS) **Diesel** **Turbo Intercooled** **TD24819**

9-3 1.9 TiD 09/04→02/15 9-5 1.9 TiD 01/06→12/09





87-146100-00 STD
87-146108-00 0.60mm

A 46.50
B- 15.40
BØ 41.50
C 1.03
D 72.50

26x61
 (08256-102)
AK KK NB RT TP

08-146100-00 STD
08-146106-00 0.40mm
08-146108-00 0.60mm

2.00 CK P
 2.00 P
 2.00 CK P

87-146100-10 STD
87-146106-10 0.40mm

A 46.50
B- 15.40
BØ 41.50
C 1.07
C 1.02
D 72.50

30x67
 (08269-503)
AK KK RT TP

08-146100-00 STD
08-146106-00 0.40mm
08-146108-00 0.60mm

2.00 CK P
 2.00 P
 2.00 CK P

82.00

5

Z19DT	4cyl.	1910cc	88kW (120PS)	Diesel	Turbo Intercooled	TD18086
9-3 1.9 TiD		09/04→02/15				

87-124000-30 STD
87-124008-30 0.60mm

A 46.50
B- 17.45
BØ 37.55
C 0.65
D 72.50

26x61
NB RT

08-124000-00 STD
08-124008-00 0.60mm

2.00 CK P
 2.00 P
 2.00 CR P

83.00

6

A20 DTH (Euro 5)	4cyl.	1956cc	118kW (160PS)	Diesel	Turbo Intercooled	TD24003
9-5 2.0 TiD		05/10→01/12				

87-436500-00 STD
87-436506-00 0.40mm

A 46.63
B- 15.80
BØ 43.50
D 72.63

30x66
 (08344A406)
AK KK RT TP

08-436500-00 STD
08-436506-00 0.40mm

1.50 GDC P
 1.50 P
 2.00 CR P

GDC **LKZ-Ring**

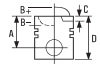

84.00 **7**

D223L	4cyl.	2171cc	85-92kW (115-125PS)	Diesel	Turbo Intercooled	TD18087
X22 DTH	4cyl.	2171cc	85kW (115PS)	Diesel	Turbo Intercooled	TD9750
Y22 DTH	4cyl.	2171cc	85-88kW (116-120PS)	Diesel	Turbo Intercooled	TD19130

9-3 2.2 TiD 02/98→02/15 9-5 2.2 TiD 03/02→12/09

87-126000-10 STD
87-126007-10 0.50mm

08-126000-00 STD
08-126007-00 0.50mm

- A** 45.80
- B-** 14.67
- BØ** 43.00
- C** 1.05
- D** 70.80
- 29x68



- 1.75 CK P
- 1.75 P
- 3.00 CR P

AK KK RT TP



CCM



9

D 11 R 23 (D 11)	Diesel	11020	6	127.00	8
DC 9.01 (Euro 3 DC 9)	Diesel	8974	6	115.00	1
DC 9.02 (Euro 3 DC 9)	Diesel	8974	6	115.00	1
DC 9.03 (Euro 3 DC 9)	Diesel	8974	6	115.00	1
DC 9.04 (Euro 3 DC 9)	Diesel	8974	6	115.00	1
DC 9.05 (Euro 3 DC 9)	Diesel	8974	6	115.00	1
DC 9.06 (DC 9)	Diesel	8974	6	115.00	1
DC 9.11 (Euro 3)	Diesel	8867	5	127.00	6
DC 9.12 (Euro 3)	Diesel	8867	5	127.00	6
DC 9.13 (Euro 3)	Diesel	8867	5	127.00	6
DC 9.16 (Euro 4)	Diesel	8867	5	127.00	7
DC 9.17 (Euro 4)	Diesel	8867	5	127.00	7
DC 9.18 (Euro 4)	Diesel	8867	5	127.00	7
DC 9.19 (Euro 3)	Diesel	8867	5	127.00	6
DC 9.20 (Euro 3 DC 9)	Diesel	8867	5	127.00	6
DC 9.21 (DC 9)	Diesel	8867	5	127.00	6
DC 11.01 (Euro 3 DC 11)	Diesel	10600	6	127.00	9
DC 11.02 (Euro 3 DC 11)	Diesel	10600	6	127.00	6
DC 11.03 (Euro 3 DC 11)	Diesel	10600	6	127.00	9
DC 11.04 (Euro 3 DC 11)	Diesel	10600	6	127.00	6
DC 11.07 (Euro 2 DC 11)	Diesel	10600	6	127.00	9
DC 11.08 (Euro 3 DC 11)	Diesel	10600	6	127.00	9
DC 11.09 (Euro 3 DC 11)	Diesel	10600	6	127.00	6
DC 12.01 (Euro 3 DC 12)	Diesel	11716	6	127.00	10
DC 12.02 (Euro 2 DC 12)	Diesel	11716	6	127.00	11
DC 12.03 (Euro 3 DC 12)	Diesel	11716	6	127.00	10
DC 12.06 (Euro 3 DC 12)	Diesel	11716	6	127.00	11
DC 12.09 (Euro 3 DC 12)	Diesel	11716	6	127.00	10
DC 12.10 (Euro 4 DC 12)	Diesel	11716	6	127.00	12
DC 12.13 (Euro 4 DC 12)	Diesel	11716	6	127.00	12
DC 12.14 (Euro 3 DC 12)	Diesel	11705	6	127.00	11
DC 12.15 (DC 12)	Diesel	11705	6	127.00	13
DC 12.17 (Euro 3 DC 12)	Diesel	11705	6	127.00	11
DC 12.18 (Euro 5 DC 12)	Diesel	11705	6	127.00	13
DC 12.22 (Euro 5 DC 12)	Diesel	11705	6	127.00	13
DC 12.23 (Euro 4 DC 12)	Diesel	11705	6	127.00	13
DC 12.24 (Euro 4 DC 12)	Diesel	11705	6	127.00	13
DC 12.26 (Euro 4 DC 12)	Diesel	11705	6	127.00	13
DC 13.05 (Euro 5 DC 13)	Diesel	12742	6	130.00	23
DC 13.06 (Euro 5 DC 13)	Diesel	12742	6	130.00	23
DC 13.07 (Euro 5 DC 13)	Diesel	12742	6	130.00	23
DC 13.10 (Euro 5 DC 13)	Diesel	12742	6	130.00	23
DC 16.01 (Euro 3 DC 16)	Diesel	15600	V8	127.00	11
DC 16.02 (Euro 3 DC 16)	Diesel	15600	V8	127.00	10
DC 16.03 (Euro 3 DC 16)	Diesel	15600	V8	127.00	11
DC 16.04 (Euro 3 DC 16)	Diesel	15600	V8	127.00	11
DC 16.05 (Euro 4 DC 16)	Diesel	15600	V8	127.00	17
DC 16.06 (Euro 4 DC 16)	Diesel	15600	V8	127.00	17
DC 16.08 (Euro 4 DC 16)	Diesel	15600	V8	127.00	17
DC 16.09 (Euro 5 DC 16)	Diesel	15600	V8	127.00	13
DC 16.17 (Euro 5 DC 16)	Diesel	15600	V8	127.00	17
DC 16.18 (Euro 5 DC 16)	Diesel	15600	V8	127.00	17
DC 16.19 (Euro 5 DC 16)	Diesel	15600	V8	127.00	17
DC 16.22 (DC 16)	Diesel	15600	V8	127.00	17
DN 8.01 (DN 8)	Diesel	7790	6	115.00	2
DN 8.05 L01 . L04	Diesel	7800	6	115.00	2
DN 9.01 (DN 9)	Diesel	8476	6	115.00	3
DN 11.01 (DN 11)	Diesel	11021	6	127.00	8
DN 11.01 B10 (DN 11)	Diesel	11020	6	127.00	8
DN 11.01 C 09 (DN 11)	Diesel	11021	6	127.00	8

ENGINE INDEX

Motorverzeichnis • Index de moteur • Índice de Motor
 Indeks silnika • Модель Двигателя • دليل المحرك



CCM



9

DN 11.04 B10 (DN 11)	Diesel	11020	6	127.00	8
DN 11.04 C 01 (DN 11)	Diesel	11020	6	127.00	8
DN 11.06 (DN 11)	Diesel	11021	6	127.00	8
DN 11.07 (DN 11)	Diesel	11020	6	127.00	8
DN 11.08 (DN 11)	Diesel	11020	6	127.00	8
DN 11.08 B01 (DN 11)	Diesel	11021	6	127.00	8
DS 8 LB09-LB14	Diesel	7800	6	115.00	2
DS 8.01 (DS 8)	Diesel	7790	6	115.00	2
DS 8.05 (DS 8)	Diesel	7790	6	115.00	2
DS 8.06 (DS 8)	Diesel	7790	6	115.00	2
DS 9.01 (DS 9)	Diesel	8476	6	115.00	4
DS 9.02 (DS 9)	Diesel	8476	6	115.00	4
DS 9.05 (Euro 1 DS 9)	Diesel	8476	6	115.00	3
DS 9.06 (DS 9)	Diesel	8476	6	115.00	3
DS 9.08 (DS 9)	Diesel	8476	6	115.00	3
DS 11 AGR/IND 1978>	Diesel	11020	6	127.00	14
DS 11 / D11 (D 11)	Diesel	11020	6	127.00	8
DS 11.01 (DS 11)	Diesel	11020	6	127.00	8
DS 11.01 B 06 (DS 11)	Diesel	11020	6	127.00	8
DS 11.02 (DS 11)	Diesel	11020	6	127.00	8
DS 11.14 (DS 11)	Diesel	11020	6	127.00	8
DS 11.15 (DS 11)	Diesel	11020	6	127.00	8
DS 11.15 B (DS 11)	Diesel	11020	6	127.00	8
DS 11.18 (DS 11)	Diesel	11020	6	127.00	8
DS 11.22 (DS 11)	Diesel	11020	6	127.00	15
DS 11.23 (DS 11)	Diesel	11020	6	127.00	15
DS 11.34 (DS 11)	Diesel	11021	6	127.00	8
DS 11.71 (DS 11)	Diesel	11021	6	127.00	8
DS 11.71 C (DS 11)	Diesel	11021	6	127.00	8
DS 11.72 (DS 11)	Diesel	11020	6	127.00	8
DS 11.73 (DS 11)	Diesel	11021	6	127.00	8
DS 11.74 (DS 11)	Diesel	11021	6	127.00	8
DS 11.75 (DS 11)	Diesel	11021	6	127.00	15
DS 14 (DS 14)	Diesel	14190	V8	127.00	18
DS 14 LB 05 (DS 14)	Diesel	14290	V8	127.00	18
DS 14 LB 08 (DS 14)	Diesel	14290	V8	127.00	18
DS 14.01 (DS 14)	Diesel	14188	V8	127.00	18
DS 14.01 L 01 (DS 14)	Diesel	14190	V8	127.00	18
DS 14.02 (DS 14)	Diesel	14188	V8	127.00	18
DS 14.06 (DS 14)	Diesel	14188	V8	127.00	18
DS 14.06 L01/L02/L03 (DS 14)	Diesel	14190	V8	127.00	18
DS 14.07 (DS 14)	Diesel	14188	V8	127.00	18
DS 14.07 L01	Diesel	14190	V8	127.00	18
DS 14.07 L02	Diesel	14190	V8	127.00	18
DS 14.46	Diesel	14181	V8	127.00	19
DS 801 LB14	Diesel	7800	6	115.00	2
DS 801 LB15	Diesel	7800	6	115.00	2
DS 801 LB16	Diesel	7800	6	115.00	2
DSC 9.01 (DSC 9)	Diesel	8476	6	115.00	4
DSC 9.02 (DSC 9)	Diesel	8476	6	115.00	4
DSC 9.07 (Euro 1 DSC 9)	Diesel	8476	6	115.00	3
DSC 9.08 (Euro 1 DSC 9)	Diesel	8476	6	115.00	3
DSC 9.09 (Euro 2 DSC 9)	Diesel	8476	6	115.00	3
DSC 9.10 (Euro 1 DSC 9)	Diesel	8476	6	115.00	3
DSC 9.11 (Euro 2 DSC 9)	Diesel	9000	6	115.00	5
DSC 9.12 (Euro 2 DSC 9)	Diesel	9000	6	115.00	5
DSC 9.13 (Euro 2 DSC 9)	Diesel	9000	6	115.00	5
DSC 9.15 (Euro 2 DSC 9)	Diesel	9000	6	115.00	5
DSC 11.01 (DSC 11)	Diesel	11021	6	127.00	8
DSC 11.02 (DSC 11)	Diesel	11020	6	127.00	8



CCM

x



9

DSC 11.04 (DSC 11)	Diesel	11021	6	127.00	8
DSC 11.08 (DSC 11)	Diesel	11021	6	127.00	16
DSC 11.10 (DSC 11)	Diesel	11021	6	127.00	16
DSC 11.12 (DSC 11)	Diesel	11021	6	127.00	8
DSC 11.13 (DSC 11)	Diesel	11021	6	127.00	8
DSC 11.16 (DSC 11)	Diesel	11021	6	127.00	8
DSC 11.17 (DSC 11)	Diesel	11021	6	127.00	8
DSC 11.18 (DSC 11)	Diesel	11021	6	127.00	8
DSC 11.21 (Euro 1 DSC 11)	Diesel	11021	6	127.00	15
DSC 11.22 (Euro 1 DSC 11)	Diesel	11021	6	127.00	15
DSC 11.23 (Euro 1 DSC 11)	Diesel	11021	6	127.00	15
DSC 11.35 (DSC 11)	Diesel	11021	6	127.00	15
DSC 11.36 (DSC 11)	Diesel	11021	6	127.00	15
DSC 11.39 (Euro 1 DSC 11)	Diesel	11021	6	127.00	15
DSC 11.70 (Euro 2 DSC 11)	Diesel	11021	6	127.00	15
DSC 11.70 N (Euro 2)	Diesel	11020	6	127.00	16
DSC 11.70 S (Euro 2)	Diesel	11020	6	127.00	16
DSC 11.71 (DSC 11)	Diesel	11021	6	127.00	15
DSC 11.74 (Euro 1 DSC 11)	Diesel	11021	6	127.00	15
DSC 11.75 (Euro 1 DSC 11)	Diesel	11021	6	127.00	15
DSC 11.79 (Euro 2 DSC 11)	Diesel	11000	6	127.00	15
DSC 11.81 (DSC 11)	Diesel	11021	6	127.00	15
DSC 12.01 (Euro 2 DSC 12)	Diesel	11716	6	127.00	10
DSC 12.02 (Euro 2 DSC 12)	Diesel	11716	6	127.00	10
DSC 12.03 (Euro 2 DSC 12)	Diesel	11716	6	127.00	10
DSC 12.05 (Euro 2 DSC 12)	Diesel	11716	6	127.00	11
DSC 14	Diesel	14190	V8	127.00	18
DSC 14.01 (DSC 14)	Diesel	14188	V8	127.00	18
DSC 14.02 (DSC 14)	Diesel	14188	V8	127.00	18
DSC 14.03 (DSC 14)	Diesel	14188	V8	127.00	20
DSC 14.04 (DSC 14)	Diesel	14188	V8	127.00	20
DSC 14.05 (DSC 14)	Diesel	14188	V8	127.00	19
DSC 14.06 (DSC 14)	Diesel	14188	V8	127.00	19
DSC 14.07 L 01 (DSC 14)	Diesel	14190	V8	127.00	18
DSC 14.08 (Euro 1 DSC 14)	Diesel	14188	V8	127.00	20
DSC 14.09 (Euro 1 DSC 14)	Diesel	14188	V8	127.00	21
DSC 14.10 (Euro 1 DSC 14)	Diesel	14188	V8	127.00	20
DSC 14.13 (Euro 2 DSC 14)	Diesel	14188	V8	127.00	22
DSC 14.15 (Euro 3 DS 14)	Diesel	14188	V8	127.00	22
DSC 14.16 (Euro 2 DSC 14)	Diesel	14188	V8	127.00	21
DSC 14.63	Diesel	14181	V8	127.00	19
DSI 8.01 (DSI 8)	Diesel	7790	6	115.00	2
DSI 8.01 L01	Diesel	7800	6	115.00	2
DSI 8.01 L04	Diesel	7800	6	115.00	2
DSI 11.01 (DSI 11)	Diesel	11021	6	127.00	8
DSI 14.47 (DSI 14)	Diesel	14190	V8	127.00	19
DSI 14.50 (DSI 14)	Diesel	14190	V8	127.00	19
DSI 14.60 (DSI 14)	Diesel	14190	V8	127.00	19
DSI 14.61 (DSI 14)	Diesel	14190	V8	127.00	19
DSI 14.63 (DSI14)	Diesel	14190	V8	127.00	19
DT 12.02 (Euro 3 DT 12)	Diesel	11705	6	127.00	10
DT 12.03 (Euro 4 DT 12)	Diesel	11705	6	127.00	12
DT 12.06 (Euro 4 DT 12)	Diesel	11705	6	127.00	13
DT 12.08 (DC 12)	Diesel	11705	6	127.00	11
DT 12.10 (Euro 4 DT 12)	Diesel	11705	6	127.00	13
DT 12.11 (Euro 4 DT 12)	Diesel	11705	6	127.00	12
DT 12.12 (Euro 4 DT 12)	Diesel	11705	6	127.00	12
DT 12.14 (DT 12)	Diesel	11705	6	127.00	7
DT 12.17 (Euro 4 DT 12)	Diesel	11705	6	127.00	12
DT 12.18 (Euro 3 DT 12)	Diesel	11705	6	127.00	7

ENGINE INDEX

Motorverzeichnis • Index de moteur • Índice de Motor
 Indeks silnika • Модель Двигателя • دليل المحرك



CCM

x



9

DTC 11.01 (Euro 1 DTC 11)	Diesel	11021	6	127.00	15
DTC 11.02 (Euro 2 DTC 11)	Diesel	11021	6	127.00	15



115.00							1
DC 9.01 (Euro 3 DC 9)	6cyl.	8974cc	169kW (230PS)	Diesel	Turbo Intercooled		TD15408
DC 9.02 (Euro 3 DC 9)	6cyl.	8974cc	191kW (260PS)	Diesel	Turbo Intercooled		TD15411
DC 9.03 (Euro 3 DC 9)	6cyl.	8974cc	221kW (300PS)	Diesel	Turbo Intercooled		TD15413
DC 9.04 (Euro 3 DC 9)	6cyl.	8974cc	169kW (230PS)	Diesel	Turbo Intercooled		TD15410
DC 9.05 (Euro 3 DC 9)	6cyl.	8974cc	191kW (260PS)	Diesel	Turbo Intercooled		TD15412
DC 9.06 (DC 9)	6cyl.	8974cc	221kW (300PS)	Diesel	Turbo Intercooled		TD15414
4 - series	01/96→04/08		4 - series bus		08/97→09/10		

15-600020-00 WH \square B 131.00 C 257.50 D 140.74 E 8.07 F 0.18

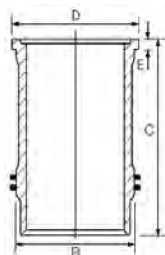

\square Includes seals

\square Schließt Dichtungen ein

\square Inclut des joints

\square Incluye los sellos

\square Comprende le guarnizioni

115.00							2
DN 8.01 (DN 8)	6cyl.	7790cc	123kW (167PS)	Diesel			TD8838
DN 8.05 L01 . L04	6cyl.	7800cc	120kW (163PS)	Diesel			MP5022
DS 8.01 (DS 8)	6cyl.	7790cc	154-170kW (209-231PS)	Diesel	Turbo		TD8842
DS 8.05 (DS 8)	6cyl.	7790cc	155kW (211PS)	Diesel	Turbo		TD8839
DS 8.06 (DS 8)	6cyl.	7790cc	140kW (190PS)	Diesel	Turbo		TD8840
DS 8 LB09-LB14	6cyl.	7800cc	140-148kW (190-202PS)	Diesel	Turbo		MP3818
DS 801 LB14	6cyl.	7800cc	120kW (163PS)	Diesel	Turbo		MP5017
DS 801 LB15	6cyl.	7800cc	120kW (163PS)	Diesel	Turbo		MP5017-1
DS 801 LB16	6cyl.	7800cc	120kW (163PS)	Diesel	Turbo		MP5017-2
DSI 8.01 (DSI 8)	6cyl.	7790cc	178kW (242PS)	Diesel	Turbo Intercooled		TD8841
DSI 8.01 L01	6cyl.	7800cc	170kW (231PS)	Diesel	Turbo Intercooled		MP5023
DSI 8.01 L04	6cyl.	7800cc	170kW (231PS)	Diesel	Turbo Intercooled		MP5023-1
2 - series	01/81→03/88		TRUCK & BUS				

14-374990-00 WH B 130.00 C 270.50 D 137.30 E 8.20 F 0.80

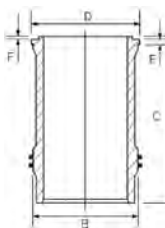

115.00							3
DN 9.01 (DN 9)	6cyl.	8476cc	128-150kW (174-204PS)	Diesel			TD8843
DS 9.05 (Euro 1 DS 9)	6cyl.	8476cc	155-185kW (211-252PS)	Diesel	Turbo		TD8846
DS 9.06 (DS 9)	6cyl.	8476cc	167kW (227PS)	Diesel	Turbo		TD8847
DS 9.08 (DS 9)	6cyl.	8476cc	155-185kW (211-252PS)	Diesel	Turbo		TD8850
DSC 9.07 (Euro 1 DSC 9)	6cyl.	8476cc	185kW (252PS)	Diesel	Turbo Intercooled		TD8851
DSC 9.08 (Euro 1 DSC 9)	6cyl.	8476cc	208kW (283PS)	Diesel	Turbo Intercooled		TD8810
DSC 9.09 (Euro 2 DSC 9)	6cyl.	8476cc	184kW (250PS)	Diesel	Turbo Intercooled		TD13068
DSC 9.10 (Euro 1 DSC 9)	6cyl.	8476cc	162kW (220PS)	Diesel	Turbo Intercooled		TD8852
3 - series	01/88→12/96		3 - series bus		01/91→12/96		



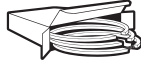

14-374990-00 WH B 130.00 C 270.50 D 137.30 E 8.20 F 0.80

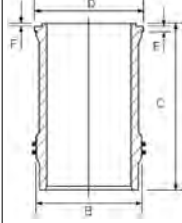

15-608890-00 WH ¹ B 127.90 C 265.60 D 140.82 E 10.26 F 0.83

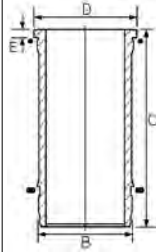

¹ Includes seals ¹ Schließt Dichtungen ein ¹ Inclut des joints ¹ Incluye los sellos ¹ Comprende le guarnizioni

115.00						4
DS 9.01 (DS 9)	6cyl.	8476cc	180-185kW (245-252PS)	Diesel	Turbo	TD8844
DS 9.02 (DS 9)	6cyl.	8476cc	167-185kW (227-252PS)	Diesel	Turbo	TD8845
DSC 9.01 (DSC 9)	6cyl.	8476cc	202kW (275PS)	Diesel	Turbo Intercooled	TD8848
DSC 9.02 (DSC 9)	6cyl.	8476cc	207kW (282PS)	Diesel	Turbo Intercooled	TD8849
2 - series			01/85→12/88	3 - series		03/88→12/96

15-608890-00 WH ¹ B 127.90 C 265.60 D 140.82 E 10.26 F 0.83

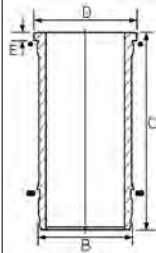

¹ Includes seals ¹ Schließt Dichtungen ein ¹ Inclut des joints ¹ Incluye los sellos ¹ Comprende le guarnizioni

115.00						5
DSC 9.11 (Euro 2 DSC 9)	6cyl.	9000cc	161-162kW (219-220PS)	Diesel	Turbo Intercooled	TD8854
DSC 9.12 (Euro 2 DSC 9)	6cyl.	9000cc	191kW (260PS)	Diesel	Turbo Intercooled	TD8855
DSC 9.13 (Euro 2 DSC 9)	6cyl.	9000cc	228kW (310PS)	Diesel	Turbo Intercooled	TD8853
DSC 9.15 (Euro 2 DSC 9)	6cyl.	9000cc	228kW (310PS)	Diesel	Turbo Intercooled	TD12608
3 - series			01/90→12/98	4 - series bus		08/97→08/07
4 - series			01/96→04/08			

87-109200-00 STD

- A 83.43
- B- 20.60
- BØ 71.50
- C 0.60
- D 130.95
-  50x92



AK RT TP

08-109200-00 STD

- 3.16  CK P
- 2.38  P
- 3.50  CR P

15-600020-00 WH ¹ B 131.00 C 257.50 D 140.74 E 8.07 F 0.18

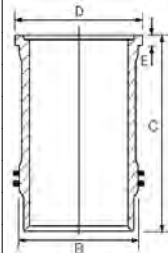

89-109200-30 ¹
87-109200-00 +
15-600020-00

¹ Includes seals ¹ Schließt Dichtungen ein ¹ Inclut des joints ¹ Incluye los sellos ¹ Comprende le guarnizioni



127.00						6
DC 9.11 (Euro 3)	5cyl.	8867cc	228kW (310PS)	Diesel	Turbo Intercooled	TD18048
DC 9.12 (Euro 3)	5cyl.	8867cc	198kW (270PS)	Diesel	Turbo Intercooled	TD18047
DC 9.13 (Euro 3)	5cyl.	8867cc	169kW (230PS)	Diesel	Turbo Intercooled	TD18045
DC 9.19 (Euro 3)	5cyl.	8867cc	169kW (230PS)	Diesel	Turbo Intercooled	TD30310
DC 9.20 (Euro 3 DC 9)	5cyl.	8867cc	198-199kW (269-271PS)	Diesel	Turbo Intercooled	TD21006
DC 9.21 (DC 9)	5cyl.	8867cc	198-228kW (269-310PS)	Diesel	Turbo Intercooled	TD30318
DC 11.02 (Euro 3 DC 11)	6cyl.	10600cc	279kW (379PS)	Diesel	Turbo Intercooled	TD12772
DC 11.04 (Euro 3 DC 11)	6cyl.	10600cc	279kW (379PS)	Diesel	Turbo Intercooled	TD15416
DC 11.09 (Euro 3 DC 11)	6cyl.	10600cc	279kW (380PS)	Diesel	Turbo Intercooled	TD17452
4 - series			01/96→04/08	K - series bus		10/06→
4 - series bus			08/97→08/07	N - series bus		10/13→
F - series			12/09→	P,G,R,T - series		03/04→

15-112800-00 WH ① ② B 138.50 C 271.12 D 150.00 E 194.27 F 0.85
 14-112800-00 WH ① B 138.50 C 271.12 D 150.00 E 194.27 F 0.85
 15-570050-00 WH ② B 138.50 C 271.12 D 150.00 E 194.27 F 0.80
 15-570060-00 WH ② B 139.50 C 270.50 D 151.00 E 194.27 F 0.97

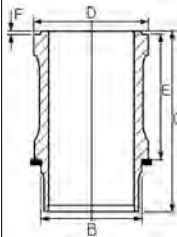

- ① Relief 8.25mm
- ② Includes seals
- ① Entlastung 8.25mm
- ② Schließt Dichtungen ein
- ① Le relief 8.25mm
- ② Inclut des joints
- ① Relevación 8.25mm
- ② Incluye los sellos
- ① Rilievo 8.25mm
- ② Comprende le guarnizioni

127.00						7
DC 9.16 (Euro 4)	5cyl.	8867cc	169kW (230PS)	Diesel	Turbo Intercooled	TD18641
DC 9.17 (Euro 4)	5cyl.	8867cc	198-199kW (270-271PS)	Diesel	Turbo Intercooled	TD18642
DC 9.18 (Euro 4)	5cyl.	8867cc	228kW (310PS)	Diesel	Turbo Intercooled	TD18643
DT 12.14 (DT 12)	6cyl.	11705cc	309kW (420PS)	Diesel	Turbo Intercooled	TD20876
DT 12.18 (Euro 3 DT 12)	6cyl.	11705cc	324kW (440PS)	Diesel	Turbo Intercooled	TD20877
K - series			03/06→	OMNICITY		07/08→
K - series bus			10/06→	OMNILINK		09/06→
N - series bus			02/07→	P,G,R,T - series		03/04→

15-570050-00 WH ① B 138.50 C 271.12 D 150.00 E 194.27 F 0.80
 15-570060-00 WH ① B 139.50 C 270.50 D 151.00 E 194.27 F 0.97

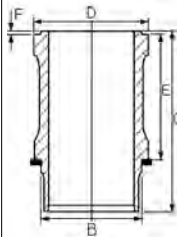

- ① Includes seals
- ① Schließt Dichtungen ein
- ① Inclut des joints
- ① Incluye los sellos
- ① Comprende le guarnizioni

127.00						8
D 11 R 23 (D 11)	6cyl.	11020cc	143kW (195PS)	Diesel		TD8805
DN 11.01 (DN 11)	6cyl.	11021cc	149-153kW (203-208PS)	Diesel		TD8806
DN 11.01 B10 (DN 11)	6cyl.	11020cc	155kW (211PS)	Diesel		TD5872
DN 11.01 C 09 (DN 11)	6cyl.	11021cc	158kW (215PS)	Diesel		TD8836
DN 11.04 B10 (DN 11)	6cyl.	11020cc	155kW (211PS)	Diesel		TD6220





DN 11.04 C 01 (DN 11)	6cyl.	11020cc	158kW (215PS)	Diesel	Turbo	TD8837
DN 11.06 (DN 11)	6cyl.	11021cc	134kW (182PS)	Diesel		TD8875
DN 11.07 (DN 11)	6cyl.	11020cc	139kW (189PS)	Diesel		TD8808
DN 11.08 (DN 11)	6cyl.	11020cc	150kW (204PS)	Diesel		TD8886
DN 11.08 B01 (DN 11)	6cyl.	11021cc	149kW (203PS)	Diesel		TD8889
DS 11.01 (DS 11)	6cyl.	11020cc	184-202kW (250-275PS)	Diesel	Turbo	TD5874
DS 11.01 B 06 (DS 11)	6cyl.	11020cc	202kW (275PS)	Diesel	Turbo	TD8799
DS 11.02 (DS 11)	6cyl.	11020cc	206-245kW (280-333PS)	Diesel	Turbo Intercooled	TD8864
DS 11.14 (DS 11)	6cyl.	11020cc	206-245kW (280-333PS)	Diesel	Turbo Intercooled	TD6222
DS 11.15 (DS 11)	6cyl.	11020cc	224-245kW (305-333PS)	Diesel	Turbo Intercooled	TD8803
DS 11.15 B (DS 11)	6cyl.	11020cc	224kW (305PS)	Diesel	Turbo Intercooled	TD8801
DS 11.18 (DS 11)	6cyl.	11020cc	254kW (345PS)	Diesel	Turbo Intercooled	TD8857
DS 11.34 (DS 11)	6cyl.	11021cc	228kW (310PS)	Diesel	Turbo Intercooled	TD8869
DS 11.71 (DS 11)	6cyl.	11021cc	189kW (257PS)	Diesel	Turbo	TD8873
DS 11.71 C (DS 11)	6cyl.	11021cc	189kW (257PS)	Diesel	Turbo	TD5878
DS 11.72 (DS 11)	6cyl.	11020cc	230kW (313PS)	Diesel	Turbo	TD8858
DS 11.73 (DS 11)	6cyl.	11021cc	228-230kW (310-313PS)	Diesel	Turbo	TD8859
DS 11.74 (DS 11)	6cyl.	11021cc	194kW (264PS)	Diesel	Turbo	TD8820
DS 11 / D11 (D 11)	6cyl.	11020cc	140-149kW (190-203PS)	Diesel		TD8794
DSC 11.01 (DSC 11)	6cyl.	11021cc	230kW (313PS)	Diesel	Turbo Intercooled	TD8811
DSC 11.02 (DSC 11)	6cyl.	11020cc	267kW (363PS)	Diesel	Turbo Intercooled	TD8860
DSC 11.04 (DSC 11)	6cyl.	11021cc	189-245kW (257-333PS)	Diesel	Turbo Intercooled	TD8868
DSC 11.12 (DSC 11)	6cyl.	11021cc	254kW (345PS)	Diesel	Turbo Intercooled	TD8861
DSC 11.13 (DSC 11)	6cyl.	11021cc	267kW (363PS)	Diesel	Turbo Intercooled	TD8878
DSC 11.16 (DSC 11)	6cyl.	11021cc	239kW (325PS)	Diesel	Turbo Intercooled	TD8879
DSC 11.17 (DSC 11)	6cyl.	11021cc	235-237kW (320-322PS)	Diesel	Turbo Intercooled	TD8880
DSC 11.18 (DSC 11)	6cyl.	11021cc	267kW (363PS)	Diesel	Turbo Intercooled	TD8826
DSI 11.01 (DSI 11)	6cyl.	11021cc	191kW (260PS)	Diesel	Turbo	TD8874

2 - series	01/81→08/91	Jetliner	09/90→09/93
3 - series	05/87→12/98	Skyliner	09/90→09/93
3 - series bus	01/88→	Spaceliner	09/90→
Cityliner	09/90→	Transliner	09/90→09/92

15-450850-00 WH B 140.00 C 291.00 D 153.80 E 8.20 F 0.80
 14-450850-00 WH B 140.00 C 291.00 D 153.80 E 8.20 F 0.80
 15-458190-00 WH B 139.93 C 291.00 D 153.80 E 7.94 F 0.80
 14-458190-00 WH B 139.93 C 291.00 D 153.80 E 7.94 F 0.80

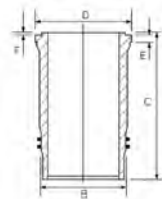

Includes seals Schließt Dichtungen ein Inclut des joints Incluye los sellos Comprende le guarnizioni

127.00 **9**

DC 11.01 (Euro 3 DC 11)	6cyl.	10600cc	250kW (340PS)	Diesel	Turbo Intercooled	TD12769
DC 11.03 (Euro 3 DC 11)	6cyl.	10600cc	250kW (340PS)	Diesel	Turbo Intercooled	TD15415
DC 11.07 (Euro 2 DC 11)	6cyl.	10600cc	242-243kW (329-330PS)	Diesel	Turbo Intercooled	TD21005
DC 11.08 (Euro 3 DC 11)	6cyl.	10600cc	250kW (340PS)	Diesel	Turbo Intercooled	TD17451

4 - series	01/96→04/08	K - series bus	03/10→
------------	-------------	----------------	--------





4 - series bus 08/97→08/07 P,G,R,T - series 03/04→

87-143600-50 STD

- A 92.04
- B- 21.15
- BØ 75.10
- D 136.04



AK RT TP

08-143600-10 STD

- 3.50 CK P
- 2.38 P
- 3.50 CR



- 15-112800-00 WH ① ② B 138.50 C 271.12 D 150.00 E 194.27 F 0.85
- 14-112800-00 WH ① B 138.50 C 271.12 D 150.00 E 194.27 F 0.85
- 15-570050-00 WH ② B 138.50 C 271.12 D 150.00 E 194.27 F 0.80
- 15-570060-00 WH ② B 139.50 C 270.50 D 151.00 E 194.27 F 0.97

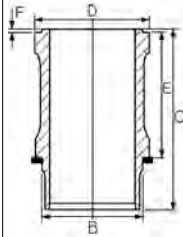

- ① Relief 8.25mm
- ② Includes seals

- ① Entlastung 8.25mm
- ② Schließt Dichtungen ein

- ① Le relief 8.25mm
- ② Inclut des joints

- ① Relevación 8.25mm
- ② Incluye los sellos

- ① Rilievo 8.25mm
- ② Comprende le guarnizioni

127.00 **10**

DC 12.01 (Euro 3 DC 12)	6cyl.	11716cc	309kW (420PS)	Diesel	Turbo Intercooled	TD15418
DC 12.03 (Euro 3 DC 12)	6cyl.	11716cc	308kW (420PS)	Diesel	Turbo Intercooled	TD16852
DC 12.09 (Euro 3 DC 12)	6cyl.	11716cc	309kW (420PS)	Diesel	Turbo Intercooled	TD22367
DC 16.02 (Euro 3 DC 16)	V8cyl.	15600cc	353kW (480PS)	Diesel	Turbo Intercooled	TD15428
DSC 12.01 (Euro 2 DSC 12)	6cyl.	11716cc	294kW (400PS)	Diesel	Turbo Intercooled	TD8892
DSC 12.02 (Euro 2 DSC 12)	6cyl.	11716cc	265kW (360PS)	Diesel	Turbo Intercooled	TD8893
DSC 12.03 (Euro 2 DSC 12)	6cyl.	11716cc	265-325kW (360-442PS)	Diesel	Turbo Intercooled	TD22371
DT 12.02 (Euro 3 DT 12)	6cyl.	11705cc	345-346kW (470-470PS)	Diesel	Turbo Intercooled	TD16495

4 - series 05/95→04/08 K - series bus 06/07→08/13
 4 - series bus 08/97→12/09 P,G,R,T - series 01/08→

87-143600-00 STD ①

- A 85.21
- B- 22.15
- BØ 78.00
- D 125.21
- 54x106



08-143600-10 STD

- 3.50 CK P
- 2.38 P
- 3.50 CR



- 15-112800-00 WH ② ③ B 138.50 C 271.12 D 150.00 E 194.27 F 0.85
- 14-112800-00 WH ③ B 138.50 C 271.12 D 150.00 E 194.27 F 0.85

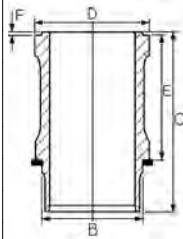

89-143600-00 ②
 87-143600-00 +
 15-112800-00

87-143600-30 STD ④

- A 85.04
- B- 22.15
- BØ 78.00
- D 129.04
- 54x106



08-143600-10 STD

- 3.50 CK P
- 2.38 P
- 3.50 CR



- 15-112800-00 WH ② ③ B 138.50 C 271.12 D 150.00 E 194.27 F 0.85
- 14-112800-00 WH ③ B 138.50 C 271.12 D 150.00 E 194.27 F 0.85

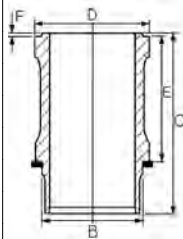

89-143600-30 ④
 87-143600-30 +
 15-112800-00

- ① Articulated piston
- ② Includes seals
- ③ Relief 8.25mm
- ④ Not to replace kitset with articulated piston

- ① Pendelschaftkolben
- ② Schließt Dichtungen ein
- ③ Entlastung 8.25mm
- ④ Nicht mit Pendelschaftkolben ersetzen

- ① Piston articulé
- ② Inclut des joints
- ③ Le relief 8.25mm
- ④ Ne pas remplacer le kit avec un piston articulé

- ① Pistón articulado
- ② Incluye los sellos
- ③ Relevación 8.25mm
- ④ No sustituir el kit por un pistón articulado

- ① Pistone articolato
- ② Comprende le guarnizioni
- ③ Rilievo 8.25mm
- ④ Non per sostituzione set con pistone articolato

127.00 **11**

DC 12.02 (Euro 2 DC 12)	6cyl.	11716cc	294kW (400PS)	Diesel	Turbo Intercooled	TD21080
-------------------------	-------	---------	---------------	--------	-------------------	---------





DC 12.06 (Euro 3 DC 12)	6cyl.	11716cc	309kW (420PS)	Diesel	Turbo Intercooled	TD20875
DC 12.14 (Euro 3 DC 12)	6cyl.	11705cc	309kW (420PS)	Diesel	Turbo Intercooled	TD17453
DC 12.17 (Euro 3 DC 12)	6cyl.	11705cc	279kW (379PS)	Diesel	Turbo Intercooled	TD20873
DC 16.01 (Euro 3 DC 16)	V8cyl.	15600cc	426-427kW (580-581PS)	Diesel	Turbo Intercooled	TD15429
DC 16.03 (Euro 3 DC 16)	V8cyl.	15600cc	426kW (580PS)	Diesel	Turbo Intercooled	TD17458
DC 16.04 (Euro 3 DC 16)	V8cyl.	15600cc	368kW (500PS)	Diesel	Turbo Intercooled	TD17457
DSC 12.05 (Euro 2 DSC 12)	6cyl.	11716cc	309kW (420PS)	Diesel	Turbo Intercooled	TD12870
DT 12.08 (DC 12)	6cyl.	11705cc	324-324kW (440-441PS)	Diesel	Turbo Intercooled	TD16716

4 - series	01/96→04/08	OMNIEXPRESS	11/07→
4 - series bus	08/97→12/09	P,G,R,T - series	03/04→
K - series bus	03/06→		

87-143600-00 STD ①

A 85.21
B- 22.15
BØ 78.00
D 125.21
 54x106



08-143600-10 STD

3.50
 2.38
 3.50
 CK P
 P
 CR

15-112800-00 WH ② ③ **B** 138.50 **C** 271.12 **D** 150.00 **E** 194.27 **F** 0.85
14-112800-00 WH ③ **B** 138.50 **C** 271.12 **D** 150.00 **E** 194.27 **F** 0.85
15-570050-00 WH ② **B** 138.50 **C** 271.12 **D** 150.00 **E** 194.27 **F** 0.80
15-570060-00 WH ② **B** 139.50 **C** 270.50 **D** 151.00 **E** 194.27 **F** 0.97

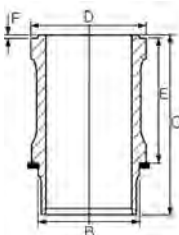

89-143600-00 ②
 87-143600-00 +
 15-112800-00

① Articulated piston
 ② Includes seals
 ③ Relief 8.25mm

① Pendelschaftkolben
 ② Schließt Dichtungen ein
 ③ Entlastung 8.25mm

① Piston articulé
 ② Inclut des joints
 ③ Le relief 8.25mm

① Pistón articulado
 ② Incluye los sellos
 ③ Relevación 8.25mm

① Pistone articolato
 ② Comprende le guarnizioni
 ③ Rilievo 8.25mm

127.00

12

DC 12.10 (Euro 4 DC 12)	6cyl.	11716cc	250kW (340PS)	Diesel	Turbo Intercooled	TD18644
DC 12.13 (Euro 4 DC 12)	6cyl.	11716cc	279-280kW (379-381PS)	Diesel	Turbo Intercooled	TD18645
DT 12.03 (Euro 4 DT 12)	6cyl.	11705cc	345-345kW (469-470PS)	Diesel	Turbo Intercooled	TD18648
DT 12.11 (Euro 4 DT 12)	6cyl.	11705cc	309kW (420PS)	Diesel	Turbo Intercooled	TD17454
DT 12.12 (Euro 4 DT 12)	6cyl.	11705cc	309kW (420PS)	Diesel	Turbo Intercooled	TD18646
DT 12.17 (Euro 4 DT 12)	6cyl.	11705cc	353kW (480PS)	Diesel	Turbo Intercooled	TD20878

IRIZAR CENTURY	09/06→	OMNIEXPRESS	11/07→
IRIZAR PB	09/06→	P,G,R,T - series	03/04→
K - series bus	03/06→		

87-437600-00 STD ①

A 85.20
B- 22.45
BØ 77.40
D 122.71
 54x106



08-437600-00 STD

3.50
 2.38
 3.50
 CK
 CR
 CK

15-570050-00 WH ② **B** 138.50 **C** 271.12 **D** 150.00 **E** 194.27 **F** 0.80
15-570060-00 WH ② **B** 139.50 **C** 270.50 **D** 151.00 **E** 194.27 **F** 0.97

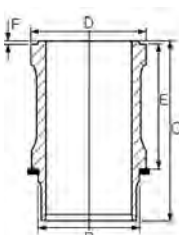

89-437600-00 ②
 87-437600-00 +
 15-570050-00

① Articulated piston
 ② Includes seals

① Pendelschaftkolben
 ② Schließt Dichtungen ein

① Piston articulé
 ② Inclut des joints

① Pistón articulado
 ② Incluye los sellos

① Pistone articolato
 ② Comprende le guarnizioni

127.00

13



DC 12.15 (DC 12)	6cyl.	11705cc	309kW (420PS)	Diesel	Turbo Intercooled	TD18647
DC 12.18 (Euro 5 DC 12)	6cyl.	11705cc	279kW (379PS)	Diesel	Turbo Intercooled	TD20874
DC 12.22 (Euro 5 DC 12)	6cyl.	11705cc	309kW (420PS)	Diesel	Turbo Intercooled	TD23694





DC 12.23 (Euro 4 DC 12)	6cyl.	11705cc	309kW (420PS)	Diesel	Turbo Intercooled	TD23698
DC 12.24 (Euro 4 DC 12)	6cyl.	11705cc	279-280kW (379-381PS)	Diesel	Turbo Intercooled	TD23699
DC 12.26 (Euro 4 DC 12)	6cyl.	11705cc	250kW (340PS)	Diesel	Turbo Intercooled	TD23700
DC 16.09 (Euro 5 DC 16)	V8cyl.	15600cc	368kW (500PS)	Diesel	Turbo Intercooled	TD18651
DT 12.06 (Euro 4 DT 12)	6cyl.	11705cc	345kW (470PS)	Diesel	Turbo Intercooled	TD17455
DT 12.10 (Euro 4 DT 12)	6cyl.	11705cc	324kW (441PS)	Diesel	Turbo Intercooled	TD29079

4 - series	01/01→04/08	OMNIEXPRESS	11/07→
K - series bus	03/06→	P,G,R,T - series	03/04→

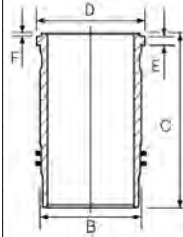
<p>87-143600-70 STD</p> <p>A 85.25 B- 23.00 BØ 75.00 D 122.75  54x106</p> <p>AK TP</p> 	<p>08-143600-10 STD</p> <p>3.50 2.38 3.50</p>  <p>CK P P CR</p>	<p>15-570030-00 WH 1 2 B 139.50 C 271.10 D 151.00 E 4.00 F 0.90</p> 	<p>89-143600-70 87-143600-70 + 15-570030-00</p>
<p>1 Includes seals 2 Relief 8.25mm</p>	<p>1 Schließt Dichtungen ein 2 Entlastung 8.25mm</p>	<p>1 Inclut des joints 2 Le relief 8.25mm</p>	<p>1 Incluye los sellos 2 Relevación 8.25mm</p>
			<p>1 Comprende le guarnizioni 2 Rilievo 8.25mm</p>

127.00 **14**

DS 11 AGR/IND 1978>	6cyl.	11020cc	184-202kW (250-275PS)	Diesel	Turbo	MP5198
-------------------------------	-------	----------------	------------------------------	---------------	--------------	---------------

TRUCK & BUS

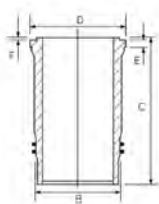
		<p>15-458190-00 WH 1 B 139.93 C 291.00 D 153.80 E 7.94 F 0.80 14-458190-00 WH B 139.93 C 291.00 D 153.80 E 7.94 F 0.80</p> 	
<p>1 Includes seals</p>	<p>1 Schließt Dichtungen ein</p>	<p>1 Inclut des joints</p>	<p>1 Incluye los sellos</p>
			<p>1 Comprende le guarnizioni</p>

127.00 **15**

DS 11.22 (DS 11)	6cyl.	11020cc	280kW (381PS)	Diesel	Turbo	TD7436
DS 11.23 (DS 11)	6cyl.	11020cc	266kW (362PS)	Diesel	Turbo	TD7180
DS 11.75 (DS 11)	6cyl.	11021cc	228-230kW (310-313PS)	Diesel	Turbo	TD8821
DSC 11.21 (Euro 1 DSC 11)	6cyl.	11021cc	235-266kW (320-362PS)	Diesel	Turbo Intercooled	TD8812
DSC 11.22 (Euro 1 DSC 11)	6cyl.	11021cc	280kW (381PS)	Diesel	Bi-Turbo Intercooled	TD8813
DSC 11.23 (Euro 1 DSC 11)	6cyl.	11021cc	266kW (362PS)	Diesel	Turbo Intercooled	TD8814
DSC 11.35 (DSC 11)	6cyl.	11021cc	235-266kW (320-362PS)	Diesel	Turbo Intercooled	TD8815
DSC 11.36 (DSC 11)	6cyl.	11021cc	235-267kW (320-363PS)	Diesel	Turbo Intercooled	TD8816
DSC 11.39 (Euro 1 DSC 11)	6cyl.	11021cc	258kW (351PS)	Diesel	Turbo Intercooled	TD8882
DSC 11.70 (Euro 2 DSC 11)	6cyl.	11021cc	280kW (381PS)	Diesel	Turbo Intercooled	TD8884
DSC 11.71 (DSC 11)	6cyl.	11021cc	235-266kW (320-362PS)	Diesel	Turbo Intercooled	TD8872
DSC 11.74 (Euro 1 DSC 11)	6cyl.	11021cc	235-266kW (320-362PS)	Diesel	Turbo Intercooled	TD22369
DSC 11.75 (Euro 1 DSC 11)	6cyl.	11021cc	235-266kW (320-362PS)	Diesel	Turbo Intercooled	TD22370
DSC 11.79 (Euro 2 DSC 11)	6cyl.	11000cc	250kW (340PS)	Diesel	Bi-Turbo Intercooled	TD12768
DSC 11.81 (DSC 11)	6cyl.	11021cc	250-305kW (340-415PS)	Diesel	Turbo Intercooled	TD17286
DTC 11.01 (Euro 1 DTC 11)	6cyl.	11021cc	295kW (401PS)	Diesel	Turbo Intercooled	TD8883
DTC 11.02 (Euro 2 DTC 11)	6cyl.	11021cc	295kW (401PS)	Diesel	Turbo Intercooled	TD8885





3 - series	05/87→12/98	Jetliner	09/90→09/93
3 - series bus	01/88→	Skyliner	09/92→
4 - series	01/96→04/08	Spaceliner	09/90→
Cityliner	09/90→	Transliner	09/92→

87-962000-30 STD

- A 98.76
- B- 16.52
- BØ 90.00
- C 2.96
- D 156.26
- 50x108



AK RT TP

08-962000-00 STD

- 3.50 CR P
- 2.38 P
- 4.74 CR P

14-450040-00 WH ①

- B** 140.00 **C** 291.00 **D** 154.00 **E** 7.94 **F** 0.90
- 15-450110-00 WH ② ③ **B** 140.00 **C** 291.00 **D** 153.68 **E** 7.92 **F** 0.80
- 14-450110-00 WH ② **B** 140.00 **C** 291.00 **D** 153.68 **E** 7.92 **F** 0.80
- 15-450850-00 WH ③ **B** 140.00 **C** 291.00 **D** 153.80 **E** 8.20 **F** 0.80
- 14-450850-00 WH **B** 140.00 **C** 291.00 **D** 153.80 **E** 8.20 **F** 0.80

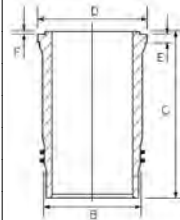

89-962000-30

87-962000-30 +
14-450040-00

- ① Relief 12.00mm
- ② Relief 13.00mm
- ③ Includes seals

- ① Entlastung 12.00mm
- ② Entlastung 13.00mm
- ③ Schließt Dichtungen ein

- ① Le relief 12.00mm
- ② Le relief 13.00mm
- ③ Includ des joints

- ① Relevación 12.00mm
- ② Relevación 13.00mm
- ③ Incluye los sellos

- ① Rilievo 12.00mm
- ② Rilievo 13.00mm
- ③ Comprende le guarnizioni

127.00

16

DSC 11.08 (DSC 11)	6cyl.	11021cc	228-280kW (310-381PS)	Diesel	Turbo Intercooled	TD8823
DSC 11.10 (DSC 11)	6cyl.	11021cc	250kW (340PS)	Diesel	Turbo Intercooled	TD8877
DSC 11.70 N (Euro 2)	6cyl.	11020cc	280kW (381PS)	Diesel	Turbo Intercooled	MP35084
DSC 11.70 S (Euro 2)	6cyl.	11020cc	280kW (381PS)	Diesel	Turbo Intercooled	MP35084-1

3 - series	01/88→12/96	TRUCK & BUS
3 - series bus	01/88→	

87-962000-80 STD

- A 98.76
- B- 22.65
- BØ 76.00
- C 2.96
- D 156.26
- 50x108



AK RT TP

08-962000-00 STD

- 3.50 CR P
- 2.38 P
- 4.74 CR P

15-458190-00 WH ①

- B** 139.93 **C** 291.00 **D** 153.80 **E** 7.94 **F** 0.80

- 14-458190-00 WH **B** 139.93 **C** 291.00 **D** 153.80 **E** 7.94 **F** 0.80

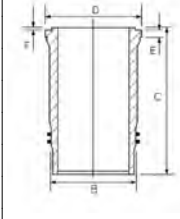

89-962000-80 ①

87-962000-80 +
15-458190-00

- ① Includes seals

- ① Schließt Dichtungen ein

- ① Includ des joints

- ① Incluye los sellos

- ① Comprende le guarnizioni

127.00

17

DC 16.05 (Euro 4 DC 16)	V8cyl.	15600cc	412kW (560PS)	Diesel	Turbo Intercooled	TD18649
DC 16.06 (Euro 4 DC 16)	V8cyl.	15600cc	368kW (500PS)	Diesel	Turbo Intercooled	TD18650
DC 16.08 (Euro 4 DC 16)	V8cyl.	15600cc	456kW (620PS)	Diesel	Turbo Intercooled	TD18652
DC 16.17 (Euro 5 DC 16)	V8cyl.	15600cc	456kW (620PS)	Diesel	Turbo Intercooled	TD20881
DC 16.18 (Euro 5 DC 16)	V8cyl.	15600cc	412kW (560PS)	Diesel	Turbo Intercooled	TD20880
DC 16.19 (Euro 5 DC 16)	V8cyl.	15600cc	368kW (500PS)	Diesel	Turbo Intercooled	TD20879
DC 16.22 (DC 16)	V8cyl.	15600cc	368kW (500PS)	Diesel	Turbo Intercooled	TD28138

P,G,R,T - series	03/04→	
------------------	--------	--





15-112800-00 WH ① ② B 138.50 C 271.12 D 150.00 E 194.27 F 0.85
14-112800-00 WH ① B 138.50 C 271.12 D 150.00 E 194.27 F 0.85

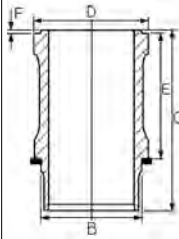

① Relief 8.25mm
 ② Includes seals

① Entlastung 8.25mm
 ② Schließt Dichtungen ein

① Le relief 8.25mm
 ② Includ des joints

① Relevación 8.25mm
 ② Incluye los sellos

① Rilievo 8.25mm
 ② Comprende le guarnizioni

127.00							18
DS 14 (DS 14)	V8cyl.	14190cc	257kW (350PS)	Diesel	Turbo		TD8835
DS 14.01 (DS 14)	V8cyl.	14188cc	283-293kW (385-398PS)	Diesel	Turbo		TD8902
DS 14.01 L 01 (DS 14)	V8cyl.	14190cc	276kW (375PS)	Diesel	Turbo		TD8903
DS 14.02 (DS 14)	V8cyl.	14188cc	309-320kW (420-435PS)	Diesel	Turbo		TD22368
DS 14.06 (DS 14)	V8cyl.	14188cc	285-291kW (388-396PS)	Diesel	Turbo		TD8896
DS 14.06 L01/L02/L03 (DS 14)	V8cyl.	14190cc	290kW (394PS)	Diesel	Turbo		TD8904
DS 14.07 (DS 14)	V8cyl.	14188cc	293kW (398PS)	Diesel	Turbo		TD8897
DS 14.07 L01	V8cyl.	14190cc	276kW (375PS)	Diesel	Turbo		MP5086
DS 14.07 L02	V8cyl.	14190cc		Diesel	Turbo		MP5086-1
DS 14 LB 05 (DS 14)	V8cyl.	14290cc	257kW (350PS)	Diesel	Turbo		TD8894
DS 14 LB 08 (DS 14)	V8cyl.	14290cc	276kW (375PS)	Diesel	Turbo		TD8895
DSC 14	V8cyl.	14190cc		Diesel	Turbo Intercooled		MP3866
DSC 14.01 (DSC 14)	V8cyl.	14188cc	301-309kW (409-420PS)	Diesel	Turbo Intercooled		TD8898
DSC 14.02 (DSC 14)	V8cyl.	14188cc	301-309kW (409-420PS)	Diesel	Turbo Intercooled		TD8899
DSC 14.07 L 01 (DSC 14)	V8cyl.	14190cc	298kW (405PS)	Diesel	Turbo Intercooled		TD8905

2 - series
 INDUSTRIAL

05/80→09/88

L - series
 TRUCK & BUS

08/75→12/81

14-670020-00 WH ① B 140.00 C 276.00 D 156.00 E 10.05 F 0.40
14-671680-00 WH ② B 140.00 C 276.00 D 156.00 E 10.10 F 0.40

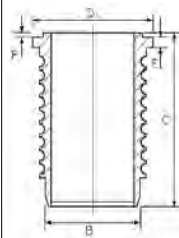

① Relief 7.00mm
 ② Relief 22.00mm
 ③ Relief 21.50mm

① Entlastung 7.00mm
 ② Entlastung 22.00mm
 ③ Entlastung 21.50mm

① Le relief 7.00mm
 ② Le relief 22.00mm
 ③ Le relief 21.50mm

① Relevación 7.00mm
 ② Relevación 22.00mm
 ③ Relevación 21.50mm

① Rilievo 7.00mm
 ② Rilievo 22.00mm
 ③ Rilievo 21.50mm

14-673080-00 WH ③ B 140.00 C 276.00 D 156.00 E 10.05 F 0.40

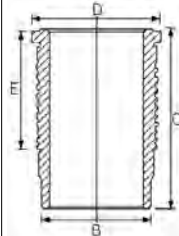



127.00							19
DS 14.46	V8cyl.	14181cc	300kW (408PS)	Diesel			MP18569
DSC 14.05 (DSC 14)	V8cyl.	14188cc	318kW (432PS)	Diesel	Turbo Intercooled		TD8900
DSC 14.06 (DSC 14)	V8cyl.	14188cc	297-309kW (404-420PS)	Diesel	Turbo Intercooled		TD8901
DSC 14.63	V8cyl.	14181cc	340kW (462PS)	Diesel	Turbo Intercooled		MP13866
DSI 14.47 (DSI 14)	V8cyl.	14190cc	341kW (464PS)	Diesel	Turbo Intercooled		TD19149
DSI 14.50 (DSI 14)	V8cyl.	14190cc	341kW (464PS)	Diesel	Turbo Intercooled		TD19150
DSI 14.60 (DSI 14)	V8cyl.	14190cc	341kW (464PS)	Diesel	Turbo Intercooled		TD19151
DSI 14.61 (DSI 14)	V8cyl.	14190cc	341kW (464PS)	Diesel	Turbo Intercooled		TD19152
DSI 14.63 (DSI14)	V8cyl.	14190cc	341kW (464PS)	Diesel	Turbo Intercooled		TD19153

3 - series 01/88→12/96 TRUCK & BUS

14-671680-00 WH 1 B 140.00 C 276.00 D 156.00 E 10.10 F 0.40

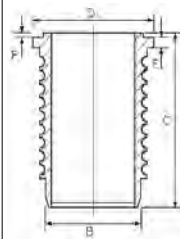

1 Relief 22.00mm 1 Entlastung 22.00mm 1 Le relief 22.00mm 1 Relevación 22.00mm 1 Rilievo 22.00mm

127.00							20
DSC 14.03 (DSC 14)	V8cyl.	14188cc	331kW (450PS)	Diesel	Turbo Intercooled		TD8906
DSC 14.04 (DSC 14)	V8cyl.	14188cc	346kW (470PS)	Diesel	Turbo Intercooled		TD8907
DSC 14.08 (Euro 1 DSC 14)	V8cyl.	14188cc	309-331kW (420-450PS)	Diesel	Turbo Intercooled		TD8908
DSC 14.10 (Euro 1 DSC 14)	V8cyl.	14188cc	333-346kW (453-471PS)	Diesel	Turbo Intercooled		TD8910

3 - series 01/88→12/96

87-962000-50 STD

A 94.67
B- 23.85
BØ 75.00
C 2.82
D 146.67
50x108



AK HA KK RT TP

08-962000-00 STD

3.50 CR P
2.38 P
4.74 CR P



15-679320-00 WH 1 2 B 139.92 C 275.25 D 155.79 E 10.09 F 0.46

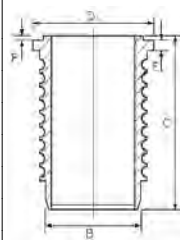

89-962000-50 1
87-962000-50 +
15-679320-00

1 Includes seals 1 Schließt Dichtungen ein 1 Inclut des joints 1 Incluye los sellos 1 Comprende le guarnizioni
2 Relief 12.00mm 2 Entlastung 12.00mm 2 Le relief 12.00mm 2 Relevación 12.00mm 2 Rilievo 12.00mm

127.00							21
DSC 14.09 (Euro 1 DSC 14)	V8cyl.	14188cc	368kW (500PS)	Diesel	Turbo Intercooled		TD8909
DSC 14.16 (Euro 2 DSC 14)	V8cyl.	14188cc	368kW (500PS)	Diesel	Turbo Intercooled		TD8912

3 - series 03/88→12/96

15-679320-00 WH 1 2 B 139.92 C 275.25 D 155.79 E 10.09 F 0.46

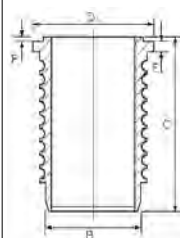

1 Relief 12.00mm 1 Entlastung 12.00mm 1 Le relief 12.00mm 1 Relevación 12.00mm 1 Rilievo 12.00mm
2 Includes seals 2 Schließt Dichtungen ein 2 Inclut des joints 2 Incluye los sellos 2 Comprende le guarnizioni



127.00

22

DSC 14.13 (Euro 2 DSC 14)	V8cyl.	14188cc	390kW (530PS)	Diesel	Turbo Intercooled	TD8911
DSC 14.15 (Euro 3 DS 14)	V8cyl.	14188cc	338kW (460PS)	Diesel	Turbo Intercooled	TD8914
4 - series		09/95→04/08				

87-143600-60 STD

A 94.67
B- 19.59
BØ 83.00
C 2.92
D 146.67
 50x102



AK HA NB RT TP

08-143600-10 STD

3.50  CK P
 2.38  P
 3.50  CR

15-670070-00 W ①

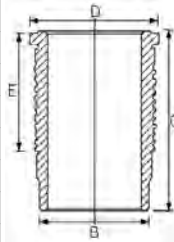

B 139.50 **C** 275.50 **D** 155.90 **E** 10.10 **F** 0.40

89-143600-60
 87-143600-60 +
 15-670070-00

① Includes seals

① Schließt Dichtungen ein

① Inclut des joints

① Incluye los sellos

① Comprende le guarnizioni

130.00

23

DC 13.05 (Euro 5 DC 13)	6cyl.	12742cc	294kW (400PS)	Diesel	Turbo Intercooled	TD20882
DC 13.06 (Euro 5 DC 13)	6cyl.	12742cc	265kW (360PS)	Diesel	Turbo Intercooled	TD20887
DC 13.07 (Euro 5 DC 13)	6cyl.	12742cc	353kW (480PS)	Diesel	Turbo Intercooled	TD20886
DC 13.10 (Euro 5 DC 13)	6cyl.	12742cc	324kW (441PS)	Diesel	Turbo Intercooled	TD20884
IRIZAR CENTURY		07/09→		OMNIEXPRESS		11/07→
IRIZAR PB		03/06→		P,G,R,T - series		04/04→
K - series bus		09/09→				

15-570090-00 W ① ②

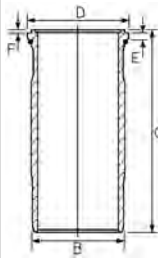

B 140.00 **C** 270.00 **D** 150.90 **E** 4.50 **F** 0.20

① Includes Anti-Polish Ring (Fire Ring)
 ② Includes seals

① Enthält Ölschlitzring
 ② Schließt Dichtungen ein

① Contient le segment racleur
 ② Inclut des joints

① Incluye el segmento rascador
 ② Incluye los sellos

① Include anello raschiaolio
 ② Comprende le guarnizioni

ENGINE INDEX

Motorverzeichnis • Index de moteur • Índice de Motor
 Indeks silnika • Модель Двигателя • دليل المحرك



CCM

x



9

1W	Diesel	1398	4	75.00	7
1Y	Diesel	1896	4	79.50	17
1Z	Diesel	1896	4	79.50	18
2E	Petrol	1984	4	82.50	38
8144.61	Diesel	2445	4	93.00	45
A112 A5.000;M020.AA.09	Petrol	903	4	65.00	1
AAU	Petrol	1043	4	75.00	7
AAV	Petrol	1272	4	75.00	7
AAZ	Diesel	1896	4	79.50	19
ABF	Petrol	1984	4	82.50	39
ABS	Petrol	1781	4	81.00	26
ACC	Petrol	1781	4	81.00	27
ADY	Petrol	1984	4	82.50	38
ADZ	Petrol	1781	4	81.00	26
AEE	Petrol	1598	4	76.50	9
AEF	Diesel	1896	4	79.50	17
AEH	Petrol	1595	4	81.00	28
AEX	Petrol	1390	4	76.50	10
AEY	Diesel	1896	4	79.50	18
AFH	Petrol	1390	4	76.50	11
AFK	Petrol	1390	4	76.50	11
AFN	Diesel	1896	4	79.50	18
AFT	Petrol	1595	4	81.00	28
AGG	Petrol	1984	4	82.50	38
AGN	Petrol	1781	4	81.00	29
AGP	Diesel	1896	4	79.50	20
AGR	Diesel	1896	4	79.50	18
AHB	Diesel	1716	4	79.50	21
AHF	Diesel	1896	4	79.50	18
AHU	Diesel	1896	4	79.50	18
AHW	Petrol	1390	4	76.50	11
AJH	Petrol	1781	4	81.00	30
AJQ	Petrol	1781	4	81.00	30
AKL	Petrol	1595	4	81.00	28
AKU	Diesel	1716	4	79.50	21
AKV	Petrol	1390	4	76.50	10
ALH	Diesel	1896	4	79.50	18
ALM	Petrol	1598	4	76.50	9
ALZ	Petrol	1595	4	81.00	31
AMF	Diesel	1422	3	79.50	15
ANU	Diesel	1896	4	79.50	22
ANX	Petrol	1390	4	76.50	10
APE	Petrol	1390	4	76.50	11
APF	Petrol	1595	4	81.00	28
APG	Petrol	1781	4	81.00	29
APP	Petrol	1781	4	81.00	30
APQ	Petrol	1390	4	76.50	10
AQM	Diesel	1896	4	79.50	20
AQQ	Petrol	1390	4	76.50	11
AQX	Petrol	1781	4	81.00	30
ARL	Diesel	1896	4	79.50	23
ARY	Petrol	1781	4	81.00	32
ASV	Diesel	1896	4	79.50	18
ASY	Diesel	1896	4	79.50	20
ASZ	Diesel	1896	4	79.50	23
ATD	Diesel	1896	4	79.50	22
AUA	Petrol	1390	4	76.50	11
AUB	Petrol	1390	4	76.50	11
AUQ	Petrol	1781	4	81.00	32
AUR	Petrol	1595	4	81.00	28



CCM

x



9

AUY	Diesel	1896	4	79.50	24
AVG	Diesel	1896	4	79.50	18
AWC	Petrol	1781	4	81.00	30
AXP	Petrol	1390	4	76.50	11
AXR	Diesel	1896	4	79.50	22
AYP	Petrol	1781	4	81.00	30
AYQ	Diesel	1896	4	79.50	20
AZQ	Petrol	1198	3	76.50	8
AZV	Diesel	1968	4	81.00	33
BBY	Petrol	1390	4	76.50	11
BBZ	Petrol	1390	4	76.50	11
BCA	Petrol	1390	4	76.50	11
BFQ	Petrol	1595	4	81.00	31
BGU (Euro 4)	Petrol	1595	4	81.00	31
BJB	Diesel	1896	4	79.50	22
BJX	Petrol	1781	4	81.00	32
BKC	Diesel	1896	4	79.50	22
BKD	Diesel	1968	4	81.00	33
BKY	Petrol	1390	4	76.50	12
BLR	Petrol	1984	4	82.50	40
BLS	Diesel	1896	4	79.50	22
BLT	Diesel	1896	4	79.50	23
BLY	Petrol	1984	4	82.50	40
BME	Petrol	1198	3	76.50	8
BMM	Diesel	1968	4	81.00	34
BMN	Diesel	1968	4	81.00	33
BMS	Diesel	1422	3	79.50	15
BMT	Diesel	1896	4	79.50	22
BNM	Diesel	1422	3	79.50	15
BNV	Diesel	1422	3	79.50	15
BPX	Diesel	1896	4	79.50	21
BRT	Diesel	1968	4	81.00	34
BSE (Euro 4/5)	Petrol	1595	4	81.00	31
BSF (Euro 2)	Petrol	1595	4	81.00	31
BTB	Diesel	1896	4	79.50	21
BUK	Diesel	1896	4	79.50	23
BVK	Diesel	1896	4	79.50	24
BVY	Petrol	1984	4	82.50	40
BVZ	Petrol	1984	4	82.50	40
BWA	Petrol	1984	4	82.50	41
BWE	Petrol	1984	4	82.50	41
BXE	Diesel	1896	4	79.50	22
BXF	Diesel	1896	4	79.50	22
BXJ	Diesel	1896	4	79.50	22
BXW	Petrol	1390	4	76.50	12
CAGA	Diesel	1968	4	81.00	35
CAGC	Diesel	1968	4	81.00	35
CAHA	Diesel	1968	4	81.00	35
CAVA	Petrol	1390	4	76.50	13
CAVE	Petrol	1390	4	76.50	13
CAVF	Petrol	1390	4	76.50	13
CAXA (Euro 5)	Petrol	1390	4	76.50	14
CAXC	Petrol	1390	4	76.50	14
CAYA	Diesel	1598	4	79.50	16
CAYB	Diesel	1598	4	79.50	16
CAYC	Diesel	1598	4	79.50	16
CBDB	Diesel	1968	4	81.00	35
CBZA	Petrol	1197	4	71.00	2
CBZB	Petrol	1197	4	71.00	2
CCZA	Petrol	1984	4	82.50	42

ENGINE INDEX

Motorverzeichnis • Index de moteur • Índice de Motor
 Indeks silnika • Модель Двигателя • دليل المحرك



CCM

x



9

CCZB	Petrol	1984	4	82.50	42
CDA A	Petrol	1798	4	82.50	43
CDHA	Petrol	1798	4	82.50	43
CDHB	Petrol	1798	4	82.50	43
CDND	Petrol	1984	4	82.50	42
CEGA	Diesel	1968	4	81.00	35
CFFA	Diesel	1968	4	81.00	36
CFFB	Diesel	1968	4	81.00	36
CFFE	Diesel	1968	4	81.00	36
CFGB	Diesel	1968	4	81.00	36
CFG C	Diesel	1968	4	81.00	36
CFHC	Diesel	1968	4	81.00	36
CFHD	Diesel	1968	4	81.00	36
CFJA	Diesel	1968	4	81.00	36
CFWA	Diesel	1199	3	79.50	16
CGGB (Euro 5)	Petrol	1390	4	76.50	12
CGLB	Diesel	1968	4	81.00	36
CHGA	Petrol	1595	4	81.00	31
CHYA (Euro 5/6)	Petrol	999	3	74.50	4
CHYB (Euro 5/6)	Petrol	999	3	74.50	4
CHYC (Euro 5/6)	Petrol	999	3	74.50	4
CJCA	Diesel	1968	4	81.00	36
CJCC	Diesel	1968	4	81.00	36
CJZA	Petrol	1197	4	71.00	3
CJZB (Euro 5)	Petrol	1197	4	71.00	3
CJZC	Petrol	1197	4	71.00	3
CJZD	Petrol	1197	4	71.00	3
CKFC (Euro 5)	Diesel	1968	4	81.00	37
CLCB	Diesel	1968	4	81.00	36
CLHA (Euro 5)	Diesel	1598	4	79.50	25
CLHB (Euro 5)	Diesel	1598	4	79.50	25
CLNA	Diesel	1598	4	79.50	16
CMBA (Euro 5)	Petrol	1395	4	74.50	5
CNUB	Petrol	1390	4	76.50	13
CNWB	Petrol	1390	4	76.50	13
CPGA	Petrol	999	3	74.50	4
CRBC (Euro 5)	Diesel	1968	4	81.00	37
CRKB (Euro 5/6)	Diesel	1598	4	79.50	25
CRLB (Euro 6)	Diesel	1968	4	81.00	37
CRMB (Euro 6)	Diesel	1968	4	81.00	37
CRVA (Euro 5)	Diesel	1968	4	81.00	37
CRVC (Euro 5)	Diesel	1968	4	81.00	37
CTHA	Petrol	1390	4	76.50	13
CTHE	Petrol	1390	4	76.50	13
CTHF	Petrol	1390	4	76.50	13
CTJB	Petrol	1390	4	76.50	13
CTJC	Petrol	1390	4	76.50	13
CUVC (Euro 6)	Diesel	1968	4	81.00	37
CXMA (Euro 6 EA 288)	Diesel	1598	4	79.50	25
CXSA (Euro 5)	Petrol	1395	4	74.50	5
CXXA (Euro 6)	Diesel	1598	4	79.50	25
CXXB (Euro 6)	Diesel	1598	4	79.50	25
CYVA (Euro 6)	Petrol	1197	4	71.00	3
CYVB	Petrol	1197	4	71.00	3
CZCA (Euro 6)	Petrol	1395	4	74.50	5
DADA (Euro 6)	Petrol	1495	4	74.50	6
DFLA (Euro 6)	Diesel	1968	4	81.00	37
DHFA (Euro 6)	Petrol	1498	4	74.50	6
DPCA (Euro 6)	Petrol	1495	4	74.50	6
MN	Diesel	1272	4	75.00	7

Motorverzeichnis • Index de moteur • Índice de Motor
 Indeks silnika • Модель ДВИгателя • دليل المحرك

ENGINE INDEX



CCM

x



9

OM 615.912 (OM 615 D 22)
 RP

Diesel	2197	4	87.00	44
Petrol	1781	4	81.00	27



65.00 **1**

A112 A5.000;M020.AA.09 4cyl. 903cc 29-33kW (40-45PS) Petrol TD20969

127 0.9 04/72→12/82

87-209800-00 STD
87-209806-00 0.40mm
87-209808-00 0.60mm

A 30.75
D 61.25
20x54



08-209800-00 STD
08-209806-00 0.40mm
08-209808-00 0.60mm

1.75 CR P
2.00 P
3.94 P



14-011001-00 D B 68.04 C 115.00

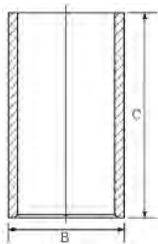

71.00 **2**

CBZA 4cyl. 1197cc 63kW (86PS) Petrol Turbo Intercooled TD23927

CBZB 4cyl. 1197cc 77kW (105PS) Petrol Turbo Intercooled TD23908

ALTEA 1.2 TSI 04/10→ LEON 1.2 TSI 02/10→12/12

ALTEA XL 1.2 TSI 04/10→ TOLEDO IV 1.2 TSI 07/12→06/15

IBIZA IV 1.2 TSI 09/10→05/15

87-443900-10 STD

A 28.90
D 45.00
19x42



HA

08-443900-00 STD

1.00 NT 1
1.20 P
2.00 NT 1



1 Steel 1 Stahl 1 Acier 1 Acero 1 Acciaio

71.00 **3**

CJZA 4cyl. 1197cc 77kW (105PS) Petrol Turbo Intercooled TD27252

CJZB (Euro 5) 4cyl. 1197cc 63kW (86PS) Petrol Turbo Intercooled TD27251

CJZC 4cyl. 1197cc 66kW (90PS) Petrol Turbo Intercooled TD31156

CJZD 4cyl. 1197cc 81kW (110PS) Petrol Turbo Intercooled TD31352

CYVA (Euro 6) 4cyl. 1197cc 63kW (86PS) Petrol Turbo Intercooled TD30802

CYVB 4cyl. 1197cc 81kW (110PS) Petrol Turbo Intercooled TD29200

IBIZA IV 1.2 TSI 05/15→06/17 LEON ST 1.2 TSI 01/13→08/18

LEON 1.2 TSI 12/12→08/20 TOLEDO IV 1.2 TSI 05/15→05/17

87-442300-10 STD 1 2

A 28.00
B+ 0.70
C 3.52
C 3.52
D 44.50
17x49



(07124A101)

AK HA TP

08-442300-10 STD 3

1.20 NT 4
1.20 CR P
2.00 NT 4



1 Earlier pistons to be replaced in Engine sets only 1 Frühere Kolben nur in Motorsätzen zu ersetzen 1 Premier piston à remplacer dans le jeu moteur 1 Pistones más antiguos para ser reemplados en juego de motore s solamente 1 Con i pistone di vecchia versione è necessario sostituire tu tta la serie

2 Elastoval 3 For Nüral OE piston 3 Für OE-Kolben von Nüral 3 Pour les pistones d'origine Nüral 3 Para pistones originales Nüral 3 Per pistoni Nüral OE

4 Steel 4 Stahl 4 Acier 4 Acero 4 Acciaio



74.50						4
CHYA (Euro 5/6)	3cyl.	999cc	44kW (60PS)	Petrol		TD26310
CHYB (Euro 5/6)	3cyl.	999cc	55kW (75PS)	Petrol		TD26311
CHYC (Euro 5/6)	3cyl.	999cc	48kW (65PS)	Petrol		TD34889
CPGA	3cyl.	999cc	50kW (68PS)	Petrol		TD27264
IBIZA IV 1.0			05/15→06/17	Mii 1.0		10/11→07/19
IBIZA V 1.0			01/17→			

87-443600-00 STD

- A 27.22
- B- 0.56
- BØ 58.07
- C 2.19
- D 42.22
-  17x39



08-443600-00 STD

- 1.00  NT
- 1.20  P
- 2.00  CR

TP

ECOTOUGH

- Steel
- Stahl
- Acier
- Acero
- Acciaio

74.50						5
CMBA (Euro 5)	4cyl.	1395cc	90kW (122PS)	Petrol	Turbo Intercooled	TD27253
CXSA (Euro 5)	4cyl.	1395cc	90kW (122PS)	Petrol	Turbo Intercooled	TD28124
CZCA (Euro 6)	4cyl.	1395cc	92kW (125PS)	Petrol	Turbo Intercooled	TD29306
LEON 1.4 TSI			09/12→08/20	TOLEDO IV 1.4 TSI		05/15→04/19

87-449500-00 STD

- A 31.00
- B- 1.25
- BØ 53.07
- C 2.90
- C 4.40
-  19x47



08-449500-00 STD

- 1.20  NT
- 1.20  CR P
- 2.00  NT

TP

- Steel
- Stahl
- Acier
- Acero
- Acciaio



74.50						6
DADA (Euro 6)	4cyl.	1495cc	110kW (150PS)	Petrol	Turbo Intercooled	TD34881
DHFA (Euro 6)	4cyl.	1498cc	96kW (131PS)	Petrol	Turbo Intercooled	TD36727
DPCA (Euro 6)	4cyl.	1495cc	110kW (150PS)	Petrol	Turbo Intercooled	TD37905
ARONA 1.5 TSI			07/17→	LEON 1.5 TGI CNG		08/20→
ATECA 1.5 TSI			07/18→	LEON 1.5 TSI		09/18→
IBIZA V 1.5 TSI			07/17→	TARRACO 1.5 TSI ACT		09/18→
LEON 1.5 TGI			10/18→			

87-453500-00 STD

- A 30.80mm
- B- 5.00mm
- BØ 61.70mm
- C 2.30mm
- C 3.50mm
- D 48.90mm
-  19.00x50.00



08-453500-00 STD

- 1.20  PVD
- 1.20mm  CR
- 2.00mm  NT

RT TP

- Steel
- Stahl
- Acier
- Acero
- Acciaio



75.00					7
AAU	4cyl.	1043cc	33kW (45PS)	Petrol	TD4892
AAV	4cyl.	1272cc	40kW (54PS)	Petrol	TD4893
1W	4cyl.	1398cc	35kW (48PS)	Diesel	TD9402
MN	4cyl.	1272cc	33kW (45PS)	Diesel	TD9401
CORDOBA 1.3		02/93→08/94	TERRA 1.3 D		03/90→12/94
IBIZA II 1.0		03/93→09/96	TERRA 1.4 D		10/90→12/95
IBIZA II 1.3 i		03/93→08/99			

14-025070-00 D B 78.00 C 133.00 D 81.00 E 4.50

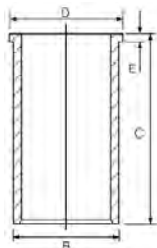

76.50					8
AZQ	3cyl.	1198cc	47kW (64PS)	Petrol	TD16459
BME	3cyl.	1198cc	47kW (64PS)	Petrol	TD20510
CORDOBA 1.2		10/02→06/06	IBIZA III 1.2		02/02→06/06

87-447800-00 STD
87-447807-00 0.50mm

08-447800-00 STD
08-447807-00 0.50mm

14-021571-00 D B 79.56 C 142.00 D 82.50 E 4.50
14-028360-00 D ② B 79.50 C 145.00 D 81.50 E 4.70

A 29.27
B- 4.00
BØ 62.00
C 2.16
C 1.27
D 50.27
E 17x46



1.20 NT ①
1.50 P
2.50 CR ①

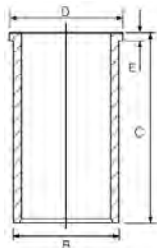

① Steel ① Stahl ① Acier ① Acero ① Acciaio
② With recesses on crankshaft side ② Mit kurbelwellenseitigen Aussparungen ② Avec évidements côté vilebrequin ② Con escotaduras en la cara del cigüeñal ② Con nicchie sul lato albero motore

76.50					9
AEE	4cyl.	1598cc	55kW (75-90PS)	Petrol	TD10867
ALM	4cyl.	1598cc	55kW (75PS)	Petrol	TD12949
CORDOBA 1.6 i		02/93→12/02	INCA 1.6		11/98→11/03
IBIZA II 1.6 i		03/93→02/02	INCA 1.6 i		06/97→09/00

14-021571-00 D B 79.56 C 142.00 D 82.50 E 4.50
14-028360-00 D ① B 79.50 C 145.00 D 81.50 E 4.70

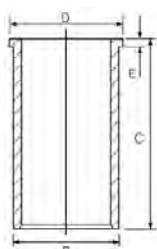

① With recesses on crankshaft side ① Mit kurbelwellenseitigen Aussparungen ① Avec évidements côté vilebrequin ① Con escotaduras en la cara del cigüeñal ① Con nicchie sul lato albero motore

76.50					10
AEX	4cyl.	1390cc	44kW (60PS)	Petrol	TD5532
AKV	4cyl.	1390cc	44kW (60PS)	Petrol	TD12513





ANX	4cyl.	1390cc	40kW (54PS)	Petrol	TD12514
APQ	4cyl.	1390cc	44kW (60PS)	Petrol	TD12515
AROSA 1.4			05/97→06/04	IBIZA II 1.4	12/97→04/99
CORDOBA 1.4			12/97→04/99	IBIZA II 1.4 i	09/93→02/02
CORDOBA 1.4 i			06/94→12/02	INCA 1.4 i	11/95→06/03

87-502800-00 STD
87-502807-00 0.50mm ①

A 28.35
C 5.95
D 50.35
 17x52



08-502800-00 STD
08-502807-00 0.50mm

1.20  NT ②
 1.50  P
 2.50  CR ②

14-021571-00 D **B** 79.56 **C** 142.00 **D** 82.50 **E** 4.50
14-028360-00 D ③ **B** 79.50 **C** 145.00 **D** 81.50 **E** 4.70

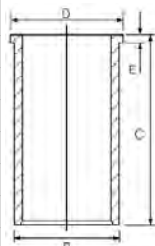

- ① A = 28.100, D = 50.100
- ② Steel
- ③ With recesses on crankshaft side
- ② Stahl
- ③ Mit kurbelwellenseitigen Aussparungen
- ② Acier
- ③ Avec évidements côté vilebrequin
- ② Acero
- ③ Con escotaduras en la cara del cigüeñal
- ② Acciaio
- ③ Con nicchie sul lato albero motore

76.50

11

AFH	4cyl.	1390cc	74kW (101PS)	Petrol	TD5534
AFK	4cyl.	1390cc	74kW (101PS)	Petrol	TD13893
AHW	4cyl.	1390cc	55kW (75PS)	Petrol	TD15529
APE	4cyl.	1390cc	55kW (75PS)	Petrol	TD13268
AQQ	4cyl.	1390cc	74kW (100PS)	Petrol	TD15528
AUA	4cyl.	1390cc	55kW (75PS)	Petrol	TD16197
AUB	4cyl.	1390cc	74kW (100PS)	Petrol	TD16140
AXP	4cyl.	1390cc	55kW (75PS)	Petrol	TD16134
BBY	4cyl.	1390cc	55kW (75PS)	Petrol	TD16460
BBZ	4cyl.	1390cc	74kW (100PS)	Petrol	TD16541
BCA	4cyl.	1390cc	55kW (75PS)	Petrol	TD16434
AROSA 1.4 16V			01/00→06/04	IBIZA II 1.4 i 16V	06/97→02/02
CORDOBA 1.4			02/00→07/00	IBIZA III 1.4 16V	02/02→11/09
CORDOBA 1.4 16V			06/99→11/09	INCA 1.4 16V	04/00→06/03
CORDOBA 1.4 i 16V			09/96→10/02	LEON 1.4 16V	11/99→06/06
IBIZA II 1.4 16V			05/00→02/02	TOLEDO II 1.4 16V	01/00→05/02

87-116100-00 STD
87-116107-00 0.50mm ①

A 28.92
B- 1.98
BØ 61.90
C 2.32
D 49.92
 17x54

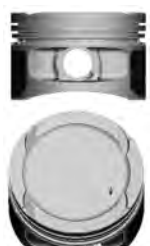

08-116100-00 STD
08-116107-00 0.50mm

1.20  NT ②
 1.50  P
 2.50  CR ②

- ① A = 28.670, D = 49.670
- ② Steel
- ② Stahl
- ② Acier
- ② Acero
- ② Acciaio

76.50

12

BKY	4cyl.	1390cc	55kW (75PS)	Petrol	TD18750
BXW	4cyl.	1390cc	63kW (86PS)	Petrol	TD19427
CGGB (Euro 5)	4cyl.	1390cc	63kW (85PS)	Petrol	TD23136
ALTEA 1.4 16V			05/06→	IBIZA IV 1.4	03/08→05/15
ALTEA XL 1.4 16V			10/06→	IBIZA IV 1.4 LPG	03/08→05/11





CORDOBA 1.4 16V	09/02→11/09	LEON 1.4 16V	06/06→12/12
IBIZA III 1.4 16V	02/02→11/09	TOLEDO III 1.4 16V	05/06→05/09

87-436900-00 STD ①
87-436907-00 0.50mm ①
 04/05→

A 28.92
B- 2.28
BØ 61.14
C 1.07
C 1.04
D 46.92
 17x45
 (07675-204)
TP

08-436900-00 STD
08-436907-00 0.50mm

1.20 NT ②
 1.20 P
 2.00 CR ②

ECOTOUGH

① Pistons to be replaced in Engine Sets only ① Kolben nur in Motorsätzen zu ersetzen ① Piston à remplacer dans jeu moteur ① Pistones de repuesto para juegos de motores solamente ① Il pistone può essere rimpiazzato solamente completo
 ② Steel ② Stahl ② Acier ② Acero ② Acciaio

76.50						13
CAVA	4cyl.	1390cc	110kW (150PS)	Petrol	Turbo & Supercharged	TD24449
CAVE	4cyl.	1390cc	132kW (180PS)	Petrol	Turbo & Supercharged	TD23095
CAVF	4cyl.	1390cc	110kW (150PS)	Petrol	Turbo & Supercharged	TD23096
CNUB	4cyl.	1390cc	110kW (150PS)	Petrol	Turbo & Supercharged	TD26338
CNWB	4cyl.	1390cc	110kW (150PS)	Petrol	Turbo & Supercharged	TD25702
CTHA	4cyl.	1390cc	110kW (150PS)	Petrol	Turbo & Supercharged	TD27527
CTHE	4cyl.	1390cc	132kW (180PS)	Petrol	Turbo & Supercharged	TD26916
CTHF	4cyl.	1390cc	110kW (150PS)	Petrol	Turbo & Supercharged	TD26920
CTJB	4cyl.	1390cc	110kW (150PS)	Petrol	Turbo & Supercharged	TD26919
CTJC	4cyl.	1390cc	132kW (180PS)	Petrol	Turbo & Supercharged	TD26918

ALHAMBRA 1.4 TSI	06/10→04/15	IBIZA IV 1.4 TSI Cupra	06/09→05/15
IBIZA IV 1.4 TSI	01/09→05/15		

87-433900-10 STD ① ②
87-433907-10 0.50mm ① ②

A 29.00
B- 6.40
B+ 1.85
C 1.00
C 3.80
D 48.00
 19x54
RT

08-433900-00 STD
08-433907-00 0.50mm

1.20 NT ③
 1.50 P
 2.00 NT ③

① Pistons to be replaced in Engine Sets only ① Kolben nur in Motorsätzen zu ersetzen ① Piston à remplacer dans jeu moteur ① Pistones de repuesto para juegos de motores solamente ① Il pistone può essere rimpiazzato solamente completo
 ② Elastoval ② ③ Steel ③ Stahl ③ Acier ③ Acero ③ Acciaio

76.50						14
CAXA (Euro 5)	4cyl.	1390cc	90kW (122PS)	Petrol	Turbo Intercooled	TD27223
CAXC	4cyl.	1390cc	92kW (125PS)	Petrol	Turbo Intercooled	TD20488

ALTEA 1.4 TSI	11/07→	TOLEDO III 1.4 TSI	11/07→05/09
ALTEA XL 1.4 TSI	11/07→	TOLEDO IV 1.4 TSI	07/12→06/15
LEON 1.4 TSI	11/07→12/12		





87-429900-00 STD ①
87-429907-00 0.50mm ①

A 29.20
B- 4.50
C 3.60
D 48.20
① 19x52



08-429900-00 STD
08-429907-00 0.50mm

1.20 NT②
1.20 P
2.00 NT②



① Elastoval ©
② Steel

② Stahl

② Acier

② Acero

② Acciaio

79.50

15

AMF	3cyl.	1422cc	55kW (75PS)	Diesel	Turbo Intercooled	TD13895
BMS	3cyl.	1422cc	59kW (80PS)	Diesel	Turbo Intercooled	TD18727
BNM	3cyl.	1422cc	51kW (70PS)	Diesel	Turbo Intercooled	TD18726
BNV	3cyl.	1422cc	59kW (80PS)	Diesel	Turbo Intercooled	TD18738
AROSA 1.4 TDI			01/00→06/04	IBIZA III 1.4 TDI		05/02→11/09
CORDOBA 1.4 TDI			10/02→11/09	IBIZA IV 1.4 TDI		07/08→06/10

87-114900-80 STD ① ②
87-114907-80 0.50mm ①

A 45.80
B- 17.65
BØ 38.00
C 1.10
D 69.80
① 26x63

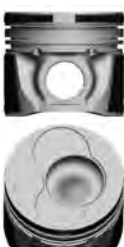

AK KK NB RT TP

08-114900-00 STD
08-114907-00 0.50mm
08-114911-00 1.00mm

1.75 CK P
2.00 P
3.00 CR P

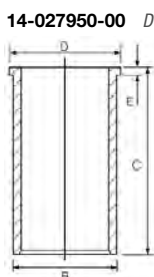

14-027950-00 D B 82.50 C 152.00 D 85.50 E 4.70

87-114900-85 STD ② ③
87-114907-85 0.50mm ③

A 45.80
B- 17.65
BØ 38.00
C 1.10
D 69.80
① 26x63



AK KK NB RT TP

08-114900-00 STD
08-114907-00 0.50mm
08-114911-00 1.00mm

1.75 CK P
2.00 P
3.00 CR P



① To cylinder 1 & 2
② Bowl capacity 23.75cm³
③ To cylinder 3

① an Zylinder 1 & 2
② Volumen der Kolbenmulde 23.75cm³
③ an Zylinder 3

① sur cylindre 1 & 2
② Volume de la cavité du piston 23.75cm³
③ sur cylindre 3

① en el cilindro 1 & 2
② Vol. cavidad pistón 23.75cm³
③ en el cilindro 3

① a cilindro 1 & 2
② Volume camera pistone 23.75cm³
③ a cilindro 3

79.50

16

CAYA	4cyl.	1598cc	55kW (75PS)	Diesel	Turbo Intercooled	TD25762
CAYB	4cyl.	1598cc	66kW (90PS)	Diesel	Turbo Intercooled	TD22670
CAYC	4cyl.	1598cc	77kW (105PS)	Diesel	Turbo Intercooled	TD22671
CFWA	3cyl.	1199cc	55kW (75PS)	Diesel	Turbo Intercooled	TD23935
CLNA	4cyl.	1598cc	77kW (105PS)	Diesel	Turbo Intercooled	TD23934
ALTEA 1.6 TDI			10/09→	IBIZA IV 1.6 TDI		05/09→05/15
ALTEA XL 1.6 TDI			10/09→	LEON 1.6 TDI		02/10→12/12
IBIZA IV 1.2 TDI			04/10→05/15	TOLEDO IV 1.6 TDI		07/12→06/15





87-432900-00 STD 1
87-432905-00 0.25mm
87-432907-00 0.50mm

A 45.30
B- 10.70
B- 4.70
BØ 49.00
D 67.80
 26x66
 (0790MA-104)
KK RT TP



08-432900-00 STD
08-432905-00 0.25mm
08-432907-00 0.50mm

1.75  GDC P
 2.00  P
 3.00  CR P



1 Bowl capacity 19.75cm³

1 Volumen der Kolbenmulde 19.75cm³

1 Volume de la cavité du piston 19.75cm³

1 Vol. cavidad pistón 19.75cm³

1 Volume camera pistone 19.75cm³

79.50 **17**

1Y	4cyl.	1896cc	47-50kW (64-68PS)	Diesel	TD4891
AEF	4cyl.	1896cc	47kW (64PS)	Diesel	TD9373
CORDOBA 1.9 D			02/93→08/96	INCA 1.9 D	11/95→06/03
IBIZA II 1.9 D			04/93→08/96	TOLEDO I 1.9 D	05/91→03/99

87-990100-40 STD
87-990105-40 0.25mm
87-990107-40 0.50mm 1
87-990111-40 1.00mm 1

A 39.65
B- 1.90
D 65.70
 24x64
 (07945)
AK RT



08-990100-00 STD
08-990105-00 0.25mm
08-990107-00 0.50mm
08-990111-00 1.00mm

1.75  CR P
 2.00  P
 3.00  CR P

14-027950-00 D **B 82.50 C 152.00 D 85.50 E 4.70**

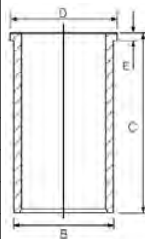

1 A = 39.400

79.50 **18**

1Z	4cyl.	1896cc	66kW (90PS)	Diesel	Turbo Intercooled	TD5527
AEY	4cyl.	1896cc	47kW (64PS)	Diesel		TD5535
AFN	4cyl.	1896cc	81kW (110PS)	Diesel	Turbo Intercooled	TD5531
AGR	4cyl.	1896cc	66kW (90PS)	Diesel	Turbo Intercooled	TD13278
AHF	4cyl.	1896cc	81kW (110PS)	Diesel	Turbo Intercooled	TD12512
AHU	4cyl.	1896cc	66kW (90PS)	Diesel	Turbo Intercooled	TD5528
ALH	4cyl.	1896cc	66kW (90PS)	Diesel	Turbo Intercooled	TD13272
ASV	4cyl.	1896cc	81kW (110PS)	Diesel	Turbo Intercooled	TD13273
AVG	4cyl.	1896cc	81kW (110PS)	Diesel	Turbo Intercooled	TD23884
ALHAMBRA 1.9 TDI			04/96→03/10	IBIZA II 1.9 TDI		08/96→02/02
ALHAMBRA TDI			03/96→03/10	INCA 1.9 SDI		11/95→06/03
CORDOBA 1.9 SDI			08/96→06/99	INCA 1.9 TDI		09/96→06/03
CORDOBA 1.9 TDI			08/96→12/02	LEON 1.9 TDI		11/99→06/06
CORDOBA VARIO 1.9 TDI			08/00→12/02	TOLEDO I 1.9 TDI		08/95→03/99
IBIZA II 1.9 SDI			08/96→08/99	TOLEDO II 1.9 TDI		10/98→07/04







87-114900-60 STD ① ②
87-114907-60 0.50mm ① ② ③

A 45.80
B- 17.65
BØ 38.00
C 1.10
D 68.80
 26x66
 (07987)
AK KK NB RT



08-114900-00 STD
08-114907-00 0.50mm
08-114911-00 1.00mm

1.75  CK P
 2.00  P
 3.00  CR P

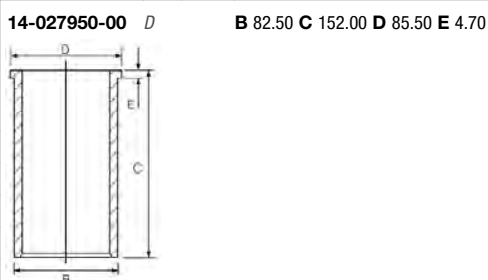



87-114900-70 STD ② ④
87-114907-70 0.50mm ② ③ ④

A 45.80
B- 17.65
BØ 38.00
C 1.10
D 68.80
 26x66
 (07987A)
AK KK NB RT



08-114900-00 STD
08-114907-00 0.50mm
08-114911-00 1.00mm



1.75  CK P
 2.00  P
 3.00  CR P

87-114900-90 STD ①
87-114907-90 0.50mm ① ⑤
87-114900-95 STD ④
87-114907-95 0.50mm ④ ⑤

A 45.80
B- 17.65
BØ 38.00
C 1.10
D 71.80
 26x66
AK NB RT



08-114900-00 STD
08-114907-00 0.50mm
08-114911-00 1.00mm

1.75  CK P
 2.00  P
 3.00  CR P

- ① To cylinder 1 & 2
- ② Bowl capacity 23.54cm³
- ③ A = 45.550, D = 68.550
- ④ To cylinder 3 & 4
- ⑤ A = 45.550, D = 71.550

- ① an Zylinder 1 & 2
- ② Volumen der Kolbenmulde 23.54cm³
- ④ an Zylinder 3 & 4

- ① sur cylindre 1 & 2
- ② Volume de la cavité du piston 23.54cm³
- ④ sur cylindre 3 & 4

- ① en el cilindro 1 & 2
- ② Vol. cavidad pistón 23.54cm³
- ④ en el cilindro 3 & 4

- ① a cilindro 1 & 2
- ② Volume camera pistone 23.54cm³
- ④ a cilindro 3 & 4

79.50

19



AAZ	4cyl.	1896cc	55kW (75PS)	Diesel	Turbo	TD4894
CORDOBA 1.9 TD			02/93→08/96		TOLEDO I 1.9 TD	05/91→03/99
IBIZA II 1.9 TD			03/93→08/96			

87-990100-10 STD
87-990107-10 0.50mm ①
87-990111-10 1.00mm ①

A 45.65
B- 1.90
D 71.70
 26x66
AK HA RT



08-990100-00 STD
08-990105-00 0.25mm
08-990107-00 0.50mm
08-990111-00 1.00mm

1.75  CR P
 2.00  P
 3.00  CR P

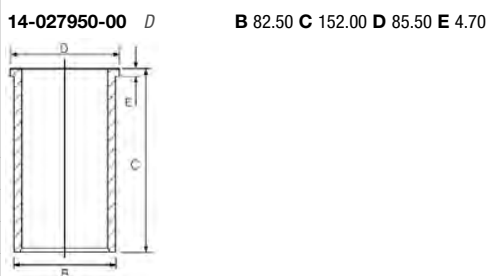





① A = 45.430





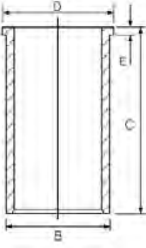

79.50 **20**

AGP	4cyl.	1896cc	50kW (68PS)	Diesel	TD14808
AQM	4cyl.	1896cc	50kW (68PS)	Diesel	TD13271
ASY	4cyl.	1896cc	47kW (64PS)	Diesel	TD16461
AYQ	4cyl.	1896cc	47kW (64PS)	Diesel	TD16198

CORDOBA 1.9 SDI	06/99→11/09	INCA 1.9 SDI	11/95→06/03
IBIZA II 1.9 SDI	08/99→02/02	LEON 1.9 SDI	11/99→06/06
IBIZA III 1.9 SDI	02/02→12/05		

<p>87-114900-20 STD ① ② 87-114907-20 0.50mm ① ③</p> <p>A 39.80 B- 17.75 BØ 38.00 C 1.00 D 60.80  24x58 (07959-109)</p> 	<p>08-114900-00 STD 08-114907-00 0.50mm 08-114911-00 1.00mm</p> <p>1.75  CK P 2.00  P 3.00  CR P</p>	<p>14-027950-00 D B 82.50 C 152.00 D 85.50 E 4.70</p> 
--	--	---

<p>87-114900-30 STD ② ④ 87-114907-30 0.50mm ③ ④</p> <p>A 39.80 B- 17.75 BØ 38.00 C 1.00 D 60.80  24x58 (07959A109)</p> 	<p>08-114900-00 STD 08-114907-00 0.50mm 08-114911-00 1.00mm</p> <p>1.75  CK P 2.00  P 3.00  CR P</p>	
---	--	--

- | | | | | |
|--------------------------------------|--|--|--|--|
| ① To cylinder 1 & 2 | ① an Zylinder 1 & 2 | ① sur cylindre 1 & 2 | ① en el cilindro 1 & 2 | ① a cilindro 1 & 2 |
| ② Bowl capacity 23.60cm ³ | ② Volumen der Kolbenmulde 23.60cm ³ | ② Volume de la cavité du piston 23.60cm ³ | ② Vol. cavidad pistón 23.60cm ³ | ② Volume camera pistone 23.60cm ³ |
| ③ A = 39.550, D = 60.550 | | | | |
| ④ To cylinder 3 & 4 | ④ an Zylinder 3 & 4 | ④ sur cylindre 3 & 4 | ④ en el cilindro 3 & 4 | ④ a cilindro 3 & 4 |

79.50 **21**

AHB	4cyl.	1716cc	42kW (57PS)	Diesel	TD9403
AKU	4cyl.	1716cc	44kW (60PS)	Diesel	TD13896
BPX	4cyl.	1896cc	118kW (160PS)	Diesel Turbo Intercooled	TD17640
BTB	4cyl.	1896cc	110kW (150PS)	Diesel Turbo Intercooled	TD20625

ALHAMBRA 1.9 TDI	05/05→05/07	IBIZA III 1.9 TDI Cupra R	03/04→02/08
AROSA 1.7 SDI	08/97→06/04	INCA 1.7 D	09/96→06/03

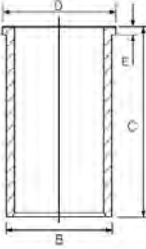
	<p>14-027950-00 D B 82.50 C 152.00 D 85.50 E 4.70</p> 
--	---

79.50 **22**

ANU	4cyl.	1896cc	66kW (90PS)	Diesel Turbo Intercooled	TD14911
ATD	4cyl.	1896cc	74kW (100PS)	Diesel Turbo Intercooled	TD16462
AXR	4cyl.	1896cc	74kW (100PS)	Diesel Turbo Intercooled	TD18739
BJB	4cyl.	1896cc	77kW (105PS)	Diesel Turbo Intercooled	TD17356





BKC	4cyl.	1896cc	77kW (105PS)	Diesel	Turbo Intercooled	TD17355
BLS	4cyl.	1896cc	77kW (105PS)	Diesel	Turbo Intercooled	TD18268
BMT	4cyl.	1896cc	74kW (101PS)	Diesel	Turbo Intercooled	TD20495
BXE	4cyl.	1896cc	77kW (105PS)	Diesel	Turbo Intercooled	TD19819
BXF	4cyl.	1896cc	66kW (90PS)	Diesel	Turbo Intercooled	TD20866
BXJ	4cyl.	1896cc	66kW (90PS)	Diesel	Turbo Intercooled	TD20840

ALHAMBRA 1.9 TDI	04/96→03/10	IBIZA III 1.9 TDI	02/02→11/09
ALHAMBRA TDI	03/96→03/10	IBIZA IV 1.9 TDI	03/08→06/10
ALTEA 1.9 TDI	04/04→	LEON 1.9 TDI	07/05→12/10
ALTEA XL 1.9 TDI	10/06→12/10	TOLEDO II 1.9 TDI	08/05→05/06
CORDOBA 1.9 TDI	09/02→11/09	TOLEDO III 1.9 TDI	10/04→05/09

87-114900-65 STD 1 2

87-114907-65 0.50mm 1 3

A 45.80
B- 17.20
BØ 38.00
C 1.10
D 68.80

26x66

(07901D-301)

AK KK NB RT TP



08-114900-00 STD

08-114907-00 0.50mm

08-114911-00 1.00mm

1.75 CK P
2.00 P
3.00 CR P



14-027950-00 D

B 82.50 C 152.00 D 85.50 E 4.70

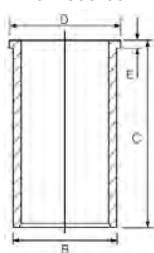

87-114900-66 STD 2 4

87-114907-66 0.50mm 3 4

A 45.80
B- 17.20
BØ 38.00
C 1.10
D 68.80

26x66

(07901D-302)

AK KK NB RT TP



08-114900-00 STD

08-114907-00 0.50mm

08-114911-00 1.00mm

1.75 CK P
2.00 P
3.00 CR P



1 To cylinder 1 & 2

2 Bowl capacity 22.85cm³

3 A = 45.550, D = 68.550

4 To cylinder 3 & 4

1 an Zylinder 1 & 2

2 Volumen der Kolbenmulde 22.85cm³

4 an Zylinder 3 & 4

1 sur cylindre 1 & 2

2 Volume de la cavité du piston 22.85cm³

4 sur cylindre 3 & 4

1 en el cilindro 1 & 2

2 Vol. cavidad pistón 22.85cm³

4 en el cilindro 3 & 4

1 a cilindro 1 & 2

2 Volume camera pistone 22.85cm³

4 a cilindro 3 & 4

79.50

23

ARL	4cyl.	1896cc	110kW (150PS)	Diesel	Turbo Intercooled	TD15768
ASZ	4cyl.	1896cc	96-112kW (130-152PS)	Diesel	Turbo Intercooled	TD16463
BLT	4cyl.	1896cc	96kW (131PS)	Diesel	Turbo Intercooled	TD20516
BUK	4cyl.	1896cc	118kW (160PS)	Diesel	Turbo Intercooled	TD22667

ALHAMBRA 1.9 TDI	11/02→11/08	IBIZA III 1.9 TDI Joya Racer	07/03→06/04
CORDOBA 1.9 TDI	10/02→11/09	LEON 1.9 TDI	09/00→06/06
IBIZA III 1.9 TDI	02/02→11/09	TOLEDO II 1.9 TDI	10/00→05/06
IBIZA III 1.9 TDI Cupra R	03/04→02/08		





87-114900-25 STD ① ②
87-114907-25 0.50mm ① ③
 →09/02

A 45.80
B- 17.90
BØ 38.00
C 1.10
D 68.80
 26x66



(07969K101)

AK KK NB RT TP

08-114900-00 STD
08-114907-00 0.50mm
08-114911-00 1.00mm

1.75  CK P
 2.00  P
 3.00  CR P

14-027950-00 D **B** 82.50 **C** 152.00 **D** 85.50 **E** 4.70

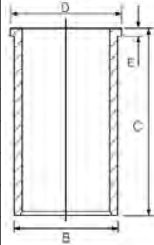

87-114900-35 STD ② ④
87-114907-35 0.50mm ③ ④
 →09/02

A 45.80
B- 17.90
BØ 38.00
C 1.10
D 68.80
 26x66



(07969K102)

AK KK NB RT TP

08-114900-00 STD
08-114907-00 0.50mm
08-114911-00 1.00mm

1.75  CK P
 2.00  P
 3.00  CR P

87-114900-45 STD ① ⑤
87-114907-45 0.50mm ① ③
 09/02→

A 45.80
B- 17.50
BØ 38.00
C 1.10
D 68.80
 26x66



(07901C105)

AK KK NB RT TP

08-114900-00 STD
08-114907-00 0.50mm
08-114911-00 1.00mm

1.75  CK P
 2.00  P
 3.00  CR P

87-114900-46 STD ④ ⑤
87-114907-46 0.50mm ③ ④
 09/02→

A 45.80
B- 17.50
BØ 38.00
C 1.10
D 68.80
 26x66



(07901C106)

AK KK NB RT TP

08-114900-00 STD
08-114907-00 0.50mm
08-114911-00 1.00mm

1.75  CK P
 2.00  P
 3.00  CR P

① To cylinder 1 & 2
 ② Bowl capacity 24.60cm³
 ③ A = 45.550, D = 68.550
 ④ To cylinder 3 & 4
 ⑤ Bowl capacity 24.05cm³

① an Zylinder 1 & 2
 ② Volumen der Kolbenmulde 24.60cm³
 ④ an Zylinder 3 & 4
 ⑤ Volumen der Kolbenmulde 24.05cm³

① sur cylindre 1 & 2
 ② Volume de la cavité du piston 24.60cm³
 ④ sur cylindre 3 & 4
 ⑤ Volume de la cavité du piston 24.05cm³

① en el cilindro 1 & 2
 ② Vol. cavidad pistón 24.60cm³
 ④ en el cilindro 3 & 4
 ⑤ Vol. cavidad pistón 24.05cm³

① a cilindro 1 & 2
 ② Volume camera pistone 24.60cm³
 ④ a cilindro 3 & 4
 ⑤ Volume camera pistone 24.05cm³



79.50

24

AUY	4cyl.	1896cc	85kW (115PS)	Diesel	Turbo Intercooled	TD14912
BVK	4cyl.	1896cc	85kW (115PS)	Diesel	Turbo Intercooled	TD20515
ALHAMBRA 1.9 TDI		06/00→03/10		ALHAMBRA TDI		06/00→03/10

87-114900-05 STD ① ②
87-114907-05 0.50mm ① ② ③
 →09/02

A 45.80
B- 17.80
BØ 38.00
C 1.30
D 68.80
 26x66
 (07969L-101)
AK KK NB RT TP

08-114900-00 STD
08-114907-00 0.50mm
08-114911-00 1.00mm

1.75 CK P
 2.00 P
 3.00 CR P

14-027950-00 D
B 82.50 **C** 152.00 **D** 85.50 **E** 4.70

87-114900-15 STD ① ④
87-114907-15 0.50mm ① ③ ④
 →09/02

A 45.80
B- 17.80
BØ 38.00
C 1.30
D 68.80
 26x66
 (07969L-102)
AK KK NB RT TP

08-114900-00 STD
08-114907-00 0.50mm
08-114911-00 1.00mm

1.75 CK P
 2.00 P
 3.00 CR P

87-114900-55 STD ② ⑤ ⑥
87-114907-55 0.50mm ② ③ ⑤
 09/02→

A 45.80
B- 17.60
BØ 38.00
C 1.10
D 68.80
 26x66
 (07901D101)
AK KK NB RT TP

08-114900-00 STD
08-114907-00 0.50mm
08-114911-00 1.00mm→

1.75 CK P
 2.00 P
 3.00 CR P





87-114900-56 STD ④ ⑤ ⑥
 87-114907-56 0.50mm ③ ④ ⑤
 09/02→

A 45.80
 B- 17.60
 BØ 38.00
 C 1.10
 D 68.60
 26x66



(07901D102)

AK KK NB RT TP

08-114900-00 STD
 08-114907-00 0.50mm
 08-114911-00 1.00mm

1.75  CK P
 2.00  P
 3.00  CR P

- | | | | | |
|--|---|--|--|--|
| ① For side angled injection nozzle | ① Nur für schräg angeordnete Einspritzdüsen | ① Pour buse d'injection latérale angulaire | ① Para la boquilla de inyección lateral angular | ① Per il lato angolato dell'ugello olio |
| ② To cylinder 1 & 2 | ② an Zylinder 1 & 2 | ② sur cylindre 1 & 2 | ② en el cilindro 1 & 2 | ② a cilindro 1 & 2 |
| ③ A = 45.550, D = 68.550 | | | | |
| ④ To cylinder 3 & 4 | ④ an Zylinder 3 & 4 | ④ sur cylindre 3 & 4 | ④ en el cilindro 3 & 4 | ④ a cilindro 3 & 4 |
| ⑤ For newer design straight injection nozzle | ⑤ Für neuere Ausführungen, direkt einspritzende Düsen | ⑤ Pour buse d'injection droite à conception plus récente | ⑤ Para el más reciente diseño de boquilla de inyección directa | ⑤ Per la più recente progettazione dell'ugello olio non angolato |
| ⑥ Bowl capacity 23.60cm ³ | ⑥ Volumen der Kolbenmulde 23.60cm ³ | ⑥ Volume de la cavité du piston 23.60cm ³ | ⑥ Vol. cavidad pistón 23.60cm ³ | ⑥ Volume camera pistone 23.60cm ³ |

79.50 **25**

CLHA (Euro 5)	4cyl.	1598cc	77kW (105PS)	Diesel	Turbo Intercooled	TD27258
CLHB (Euro 5)	4cyl.	1598cc	66kW (90PS)	Diesel	Turbo Intercooled	TD27263
CRKB (Euro 5/6)	4cyl.	1598cc	81kW (110PS)	Diesel	Turbo Intercooled	TD27958
CXMA (Euro 6 EA 288)	4cyl.	1598cc	85kW (115PS)	Diesel	Turbo Intercooled	TD31353
CXXA (Euro 6)	4cyl.	1598cc	66kW (90PS)	Diesel	Turbo Intercooled	TD35545
CXXB (Euro 6)	4cyl.	1598cc	81kW (110PS)	Diesel	Turbo Intercooled	TD31521

LEON 1.6 TDI	09/12→08/20	TOLEDO IV 1.6 TDI	05/15→04/19
LEON ST 1.6 TDI	09/13→08/20		

87-444100-00 STD
 87-444105-00 0.25mm
 87-444107-00 0.50mm

A 45.30
 B- 11.00
 BØ 49.00
 D 68.30
 26x66



AK KK RT TP

08-444100-00 STD
 08-444105-00 0.25mm
 08-444107-00 0.50mm

1.75  GDC P
 2.00  P
 2.00  CR P



81.00 **26**

ABS	4cyl.	1781cc	66kW (90PS)	Petrol	TD3576
ADZ	4cyl.	1781cc	66kW (90PS)	Petrol	TD9384

CORDOBA 1.8 i	02/93→09/02	TOLEDO I 1.8 i	11/93→12/96
IBIZA II 1.8 i	03/93→08/99		





87-109400-50 STD ①
87-109407-50 0.50mm ① ②

A 32.20
B- 4.40
BØ 55.70
B+ 1.30
D 62.50
 20x57
 (08130E-101)



08-109400-10 STD
08-109407-10 0.50mm

1.50  PS P
 1.75  P
 3.00  CR P

① Pistons to be replaced in Engine Sets only ① Kolben nur in Motorsätzen zu ersetzen ① Piston à remplacer dans jeu moteur ① Pistones de repuesto para juegos de motores solamente ① Il pistone può essere rimpiazzato solamente completo

② A = 31.900, D = 62.200

81.00 **27**

ACC	4cyl.	1781cc	66kW (90PS)	Petrol	TD18752
RP	4cyl.	1781cc	65kW (88PS)	Petrol	TD3596
CORDOBA 1.8 i			02/93→09/02	TOLEDO I 1.8 i	05/91→12/96
IBIZA II 1.8 i			03/93→08/99		

87-109700-10 STD
87-109705-10 0.25mm
87-109707-10 0.50mm

A 32.20
B- 8.10
BØ 56.80
B+ 1.10
D 62.30
 20x54
 (08131-122)



08-109700-00 STD
08-109705-00 0.25mm
08-109707-00 0.50mm

1.50  CR P
 1.75  P
 3.00  CR P

81.00 **28**

AEH	4cyl.	1595cc	74kW (101PS)	Petrol	TD12488
AFT	4cyl.	1595cc	74kW (101PS)	Petrol	TD5536
AKL	4cyl.	1595cc	74-76kW (101-103PS)	Petrol	TD12509
APF	4cyl.	1595cc	74kW (100PS)	Petrol	TD13269
AUR	4cyl.	1595cc	74kW (101PS)	Petrol	TD16200
CORDOBA 1.6 i			07/96→12/02	TOLEDO I 1.6 i	11/96→03/99
IBIZA II 1.6 i			04/96→02/02	TOLEDO II 1.6	10/98→07/04
LEON 1.6			11/99→06/06		

87-105900-00 STD
87-105907-00 0.50mm ①

A 32.00
B- 2.30
BØ 61.40
B+ 0.70
D 53.70
 20x57



08-105900-00 STD
08-105907-00 0.50mm

1.20  NT ②
 1.50  P
 2.00  CR ②

① A = 31.700, D = 53.400 ② Steel ② Stahl ② Acier ② Accro ② Acciaio

81.00 **29**

AGN	4cyl.	1781cc	92kW (125PS)	Petrol	TD12510
------------	-------	---------------	---------------------	---------------	----------------





APG	4cyl.	1781cc	92kW (125PS)	Petrol	TD15530
LEON 1.8 20V			11/99→06/06	TOLEDO II 1.8 20V	10/98→07/04

87-502900-00 STD ①
87-502907-00 0.50mm ① ②

08-502900-00 STD
08-502905-00 0.25mm
08-502907-00 0.50mm

A 32.55
C 3.60
D 56.55
20x59
(08192)
AK



1.50 CK P
1.75 P
2.00 CR P

① Conrod gap 27.50mm ① Pleuelaugenabstand 27.50mm ① Distance entre bielle 27.50mm ① Distancia del biela 27.50mm ① Distanza dalla bilie 27.50mm
② A = 32.250, D = 56.250

81.00 **30**

AJH	4cyl.	1781cc	110kW (150PS)	Petrol	Turbo Intercooled	TD17899
AJQ	4cyl.	1781cc	132kW (180PS)	Petrol	Turbo Intercooled	TD16199
APP	4cyl.	1781cc	132kW (180PS)	Petrol	Turbo Intercooled	TD13270
AQX	4cyl.	1781cc	115kW (156PS)	Petrol	Turbo Intercooled	TD13275
AWC	4cyl.	1781cc	110kW (150PS)	Petrol	Turbo Intercooled	TD14909
AYP	4cyl.	1781cc	115-132kW (156-179PS)	Petrol	Turbo Intercooled	TD16201

ALHAMBRA 1.8 T 20V	10/97→03/10	LEON 1.8 20V T	11/99→06/06
CORDOBA 1.8 T 20V Cupra	07/00→10/02	LEON 1.8 20V T 4	11/99→06/06
IBIZA II 1.8 T 20V Cupra	07/00→02/02	TOLEDO II 1.8 20VT	09/00→07/04
IBIZA II 1.8 T 20V Cupra R	07/00→02/02		

87-502900-10 STD
87-502905-10 0.25mm
87-502907-10 0.50mm

08-502900-00 STD
08-502905-00 0.25mm
08-502907-00 0.50mm

A 32.70
B- 2.05
BØ 70.00
D 53.70
20x59
AK



1.50 CK P
1.75 P
2.00 CR P

81.00 **31**

ALZ	4cyl.	1595cc	75kW (102PS)	Petrol	TD22242
BFQ	4cyl.	1595cc	75kW (102PS)	Petrol	TD20621
BGU (Euro 4)	4cyl.	1595cc	75kW (102PS)	Petrol	TD17352
BSE (Euro 4/5)	4cyl.	1595cc	75kW (102PS)	Petrol	TD18245
BSF (Euro 2)	4cyl.	1595cc	75kW (102PS)	Petrol	TD18246
CHGA	4cyl.	1595cc	75kW (102PS)	Petrol	TD22676

ALTEA 1.6	03/04→	EXEO 1.6	03/09→09/10
ALTEA 1.6 LPG	09/09→	LEON 1.6	07/05→08/13
ALTEA XL 1.6	10/06→	LEON 1.6 LPG	12/09→12/12
ALTEA XL 1.6 LPG	09/09→	TOLEDO III 1.6	10/04→05/09





87-148300-00 STD
87-148307-00 0.50mm

08-148300-00 STD
08-148307-00 0.50mm

A 29.08
B- 2.70
BØ 62.30
D 50.70
 19x42



1.00  NT¹
 1.20  P
 2.00  CR P

TP

¹ Steel ¹ Stahl ¹ Acier ¹ Acero ¹ Acciaio

81.00							32
ARY	4cyl.	1781cc	132kW (180PS)	Petrol	Turbo Intercooled		TD16136
AUQ	4cyl.	1781cc	132kW (180PS)	Petrol	Turbo Intercooled		TD16135
BJX	4cyl.	1781cc	110kW (150PS)	Petrol	Turbo Intercooled		TD17320
IBIZA III 1.8 T FR			12/03→05/08	LEON 1.8 20V T 4			11/99→06/06
LEON 1.8 20V T			11/99→06/06	TOLEDO II 1.8 20VT			09/00→07/04

87-502900-30 STD
87-502907-30 0.50mm

08-502900-00 STD
08-502905-00 0.25mm
08-502907-00 0.50mm

A 32.70
C 1.90
D 53.70
 19x49



1.50  CK P
 1.75  P
 2.00  CR P

TP

81.00							33
AZV	4cyl.	1968cc	100kW (136PS)	Diesel	Turbo Intercooled		TD18247
BKD	4cyl.	1968cc	103kW (140PS)	Diesel	Turbo Intercooled		TD17357
BMN	4cyl.	1968cc	125kW (170PS)	Diesel	Turbo Intercooled		TD18977
ALTEA 2.0 TDI			03/04→	LEON 2.0 TDI			07/05→12/12
ALTEA 2.0 TDI 16V			03/04→	LEON 2.0 TDI 16V			07/05→12/12
ALTEA XL 2.0 TDI			11/06→12/13	TOLEDO III 2.0 TDI			09/04→05/09
ALTEA XL 2.0 TDI 16V			10/06→	TOLEDO III 2.0 TDI 16V			04/04→05/09

87-139500-00 STD ¹
87-139507-00 0.50mm ²

08-139500-00 STD
08-139507-00 0.50mm

A 45.83
B- 17.80
BØ 38.00
D 68.80
 26x66



1.75  CK P
 2.00  P
 3.00  CR P

(07901J)
AK KK NB RT TP

¹ Bowl capacity 23.75cm³ ¹ Volumen der Kolbenmulde 23.75cm³ ¹ Volume de la cavité du piston 23.75cm³ ¹ Vol. cavidad pistón 23.75cm³ ¹ Volume camera pistone 23.75cm³
² A = 45.550, D = 68.550

81.00							34
BMM	4cyl.	1968cc	103kW (140PS)	Diesel	Turbo Intercooled		TD18269
BRT	4cyl.	1968cc	103kW (140PS)	Diesel	Turbo Intercooled		TD19388
ALHAMBRA 2.0 TDI			11/05→03/10	LEON 2.0 TDI			10/05→10/10







ALTEA 2.0 TDI	11/05 →	TOLEDO III 2.0 TDI	11/05 → 05/09
ALTEA XL 2.0 TDI	10/06 →		

87-139500-10 STD ① ②
87-139507-10 0.50mm ① ③

A 45.83
 B- 17.50
 BØ 38.00
 C 0.70
 D 68.80
 26x66
 (07901D833)
AK KK NB RT TP



08-139500-00 STD
08-139507-00 0.50mm



1.75  CK P
 2.00  P
 3.00  CR P

87-139500-20 STD ② ④
87-139507-20 0.50mm ③ ④

A 45.83
 B- 17.50
 BØ 38.00
 C 0.70
 D 68.80
 26x66
 (07901D834)
AK KK NB RT TP



08-139500-00 STD
08-139507-00 0.50mm

1.75  CK P
 2.00  P
 3.00  CR P

- ① To cylinder 1 & 2 ① an Zylinder 1 & 2 ① sur cylindre 1 & 2 ① en el cilindro 1 & 2 ① a cilindro 1 & 2
- ② Bowl capacity 23.30cm³ ② Volumen der Kolbenmulde 23.30cm³ ② Volume de la cavité du piston 23.30cm³ ② Vol. cavidad pistón 23.30cm³ ② Volume camera pistone 23.30cm³
- ③ A = 45.550
- ④ To cylinder 3 & 4 ④ an Zylinder 3 & 4 ④ sur cylindre 3 & 4 ④ en el cilindro 3 & 4 ④ a cilindro 3 & 4

81.00 **35**

CAGA	4cyl.	1968cc	105kW (143PS)	Diesel	Turbo Intercooled	TD22243
CAGC	4cyl.	1968cc	88kW (120PS)	Diesel	Turbo Intercooled	TD22669
CAHA	4cyl.	1968cc	125kW (170PS)	Diesel	Turbo Intercooled	TD22244
CBDB	4cyl.	1968cc	103kW (140PS)	Diesel	Turbo Intercooled	TD24327
CEGA	4cyl.	1968cc	125kW (170PS)	Diesel	Turbo Intercooled	TD22674



ALTEA 2.0 TDI	03/06 →	LEON 2.0 TDI	05/06 → 12/12
ALTEA XL 2.0 TDI	06/07 → 12/13	TOLEDO III 2.0 TDI	01/06 → 05/09
EXEO 2.0 TDI	12/08 → 05/13		



87-432300-00 STD ①
87-432307-00 0.50mm ①

A 45.80
 B- 12.70
 BØ 50.88
 D 68.80
 26x66
 (07901G202)
AK KK NB RT TP



08-432300-00 STD ②
08-432307-00 0.50mm

1.75  GDC P
 2.00  P
 3.00  CR P

- ① OE 03L 107 065G, Gen 1 engine only ① OE 03L 107 065G, nur für Motoren der Generation 1 ① N°OE 03L 107 065G, uniquement pour Moteur de génération 1 ① OE 03L 107 065G, Generación 1 solo motor ① Solo motore Generation 1
- ② 08-432300-00 OE: 03L198151A

81.00 **36**

CFFA	4cyl.	1968cc	100kW (136PS)	Diesel	Turbo Intercooled	TD25404
CFFB	4cyl.	1968cc	103kW (140PS)	Diesel	Turbo Intercooled	TD24450





CFFE	4cyl.	1968cc	85kW (116PS)	Diesel	Turbo Intercooled	TD25403
CFGB	4cyl.	1968cc	125kW (170PS)	Diesel	Turbo Intercooled	TD24451
CFGC	4cyl.	1968cc	130kW (177PS)	Diesel	Turbo Intercooled	TD27529
CFHC	4cyl.	1968cc	103kW (140PS)	Diesel	Turbo Intercooled	TD24326
CFHD	4cyl.	1968cc	105kW (143PS)	Diesel	Turbo Intercooled	TD23582
CFJA	4cyl.	1968cc	125kW (170PS)	Diesel	Turbo Intercooled	TD24333
CGLB	4cyl.	1968cc	125kW (170PS)	Diesel	Turbo Intercooled	TD26498
CJCA	4cyl.	1968cc	105kW (143PS)	Diesel	Turbo Intercooled	TD26497
CJCC	4cyl.	1968cc	88kW (120PS)	Diesel	Turbo Intercooled	TD27013
CLCB	4cyl.	1968cc	103kW (140PS)	Diesel	Turbo Intercooled	TD25102

ALHAMBRA 2.0 TDI	06/10→	EXEO 2.0 TDI	12/08→05/13
ALTEA 2.0 TDI 16V	03/04→	IBIZA IV 2.0 TDI	01/10→05/15
ALTEA XL 2.0 TDI	06/07→06/13	LEON 2.0 TDI	05/06→12/12
ALTEA XL 2.0 TDI 16V	10/06→	LEON 2.0 TDI 16V	07/05→12/12

87-432300-10 STD ① ②
87-432307-10 0.50mm ① ②

08-432300-10 STD ③ ④
08-432307-10 0.50mm ③ ④

A 45.80
B- 13.10
BØ 50.88
D 68.80
 26x66



1.75  GDC P
 2.00  MO P
 3.00  CR P



(07901G220)
AK KK NB RT TP

- ① OE 03L 107 065S, Gen 2 engine only
- ② A = 45.500
- ③ Only fit to pistons equivalent to OE 03L 107065 AG, 03L 1070 65 S
- ④ 08-432300-10 OE: 03L198151C
- ① OE 03L 107 065S, nur für Motoren der Generation 2
- ② Nur für OE Kolben 03L 107065 AG und 03L 107065 S
- ③ N°OE 03L 107 065S, uniquement pour Moteur de génération 2
- ④ Seulemment adapté aux pistons équivalents à OE 03L 107065 AGet 03L 107065 S
- ① OE 03L 107 065G, Generación 2 solo motor
- ② Cabido solamente a los pistones equivalentes a OE 03L 107065 AG y 03L 107065 S
- ③ Solo motore Generation 2
- ④ Adattato soltanto ai pistoni equivalenti OE a 03L 107065 AGe 03L 107065 S

81.00

37

CKFC (Euro 5)	4cyl.	1968cc	110kW (150PS)	Diesel	Turbo Intercooled	TD27260
CRBC (Euro 5)	4cyl.	1968cc	110kW (150PS)	Diesel	Turbo Intercooled	TD29194
CRLB (Euro 6)	4cyl.	1968cc	110kW (150PS)	Diesel	Turbo Intercooled	TD29192
CRMB (Euro 6)	4cyl.	1968cc	110kW (150PS)	Diesel	Turbo Intercooled	TD27261
CRVA (Euro 5)	4cyl.	1968cc	81kW (110PS)	Diesel	Turbo Intercooled	TD27960
CRVC (Euro 5)	4cyl.	1968cc	105kW (143PS)	Diesel	Turbo Intercooled	TD27959
CUVC (Euro 6)	4cyl.	1968cc	110kW (150PS)	Diesel	Turbo Intercooled	TD31428
DFLA (Euro 6)	4cyl.	1968cc	110kW (150PS)	Diesel	Turbo Intercooled	TD33097

ALHAMBRA 2.0 TDI	05/15→	LEON 2.0 TDI	10/12→08/20
ALHAMBRA TDI	05/15→	LEON ST 2.0 TDI	04/13→08/18
ATECA 2.0 TDI	10/16→		

87-447500-10 STD ①

08-447500-00 STD ② ③
08-447507-00 0.50mm ② ③

A 45.80
B- 12.90
BØ 50.88
D 68.80
 26x66



1.75  GDC P
 2.00  P
 2.00  CR NT



AK KK NB RT TP

- ① OE 04L 107 065A
- ② EA288 Engine family
- ③ 2014→
- ① OE 04L 107 065A
- ② EA288 Motorenfamilie
- ① OE 04L 107 065A
- ② Famille de moteurs EA288
- ① OE 04L 107 065A
- ② Familia de motores EA288
- ① OE 04L 107 065A
- ② Motori famiglia EA288



82.50					38
2E	4cyl.	1984cc	85kW (115PS)	Petrol	TD3570
ADY	4cyl.	1984cc	85kW (115PS)	Petrol	TD9386
AGG	4cyl.	1984cc	85kW (115PS)	Petrol	TD5537
ALHAMBRA 2.0			03/96→03/10	IBIZA II 2.0 i	03/93→08/99
ALHAMBRA 2.0 i			04/96→03/10	TOLEDO I 2.0 i	05/91→03/99
CORDOBA 2.0 i			02/93→06/99		

87-501800-20 STD
87-501807-20 0.50mm

- A** 30.90
- B-** 5.70
- BØ** 64.00
- B+** 0.90
- D** 51.80
- 21x55
- (08241B-103)



08-501800-00 STD
08-501807-00 0.50mm

- 1.20 PS
- 1.50 P
- 2.00 CR P

A = 30.600, D = 51.500

82.50					39
ABF	4cyl.	1984cc	110kW (150PS)	Petrol	TD4895
CORDOBA 2.0 i 16V			08/96→06/99	TOLEDO I 2.0 i 16V	11/93→03/99
IBIZA II 2.0 i 16V			08/96→08/99		

87-501800-40 STD

- A** 31.60
- C** 3.20
- D** 51.60
- 21x56
- (08238A)



08-501800-00 STD
08-501807-00 0.50mm

- 1.20 PS
- 1.50 P
- 2.00 CR P

82.50					40
BLR	4cyl.	1984cc	110kW (150PS)	Petrol	TD17353
BLY	4cyl.	1984cc	110kW (150PS)	Petrol	TD17354
BVY	4cyl.	1984cc	110kW (150PS)	Petrol	TD18266
BVZ	4cyl.	1984cc	110kW (150PS)	Petrol	TD18267
ALTEA 2.0 FSI			05/04→03/09	LEON 2.0 FSI	07/05→05/10
ALTEA XL 2.0 FSI			10/06→03/09	TOLEDO III 2.0 FSI	10/04→05/09

87-435100-00 STD

- A** 29.38
- B+** 12.46
- D** 59.85
- 19x44
- (08240B301)



08-435100-10 STD

- 1.20 PVD NT
- 1.50
- 2.00 CR

Elastoval®
 Steel

Stahl

Acier

Acero

Acciaio

82.50					41
BWA	4cyl.	1984cc	147kW (200PS)	Petrol Turbo Intercooled	TD19424
BWE	4cyl.	1984cc	147kW (200PS)	Petrol Turbo Intercooled	TD22246





ALTEA 2.0 TFSI	04/06→05/09	LEON 2.0 TFSI	05/05→03/09
ALTEA XL 2.0 TFSI	10/06→05/09	TOLEDO III 2.0 TFSI	11/05→05/09
EXEO 2.0 TFSI	03/09→05/13		

87-438500-00 STD
87-438507-00 0.50mm

08-438500-00 STD
08-438507-00 0.50mm

A 29.50
B- 6.10
BØ 49.52
C 1.36
C 1.36
D 50.50
F 20x59



1.20 PVD
1.50 P
2.00 CR P

AK RT TP

Steel Stahl Acier Acero Acciaio

82.50

42

CCZA	4cyl.	1984cc	147kW (200PS)	Petrol	Turbo Intercooled	TD24656
CCZB	4cyl.	1984cc	155kW (211PS)	Petrol	Turbo & Supercharged	TD22672
CDND	4cyl.	1984cc	155kW (211PS)	Petrol	Turbo Intercooled	TD24320

ALHAMBRA 2.0 TSI	11/10→05/12	EXEO 2.0 TFSI	05/10→05/13
ALTEA XL 2.0 TFSI	05/09→	LEON 2.0 TFSI	06/09→12/12

87-443800-10 STD

08-443800-00 STD
08-443807-00 0.50mm

A 29.60
B- 6.15
BØ 49.60
C 3.60
D 50.00
F 23x51



1.20 PVD NT
1.20 P
2.00 CR P

RT

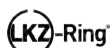

Steel Stahl Acier Acero Acciaio

82.50

43

CDA A	4cyl.	1798cc	118kW (160PS)	Petrol	Turbo Intercooled	TD21590
CDHA	4cyl.	1798cc	88kW (120PS)	Petrol	Turbo Intercooled	TD24317
CDHB	4cyl.	1798cc	118kW (160PS)	Petrol	Turbo Intercooled	TD24319

ALHAMBRA 1.8 TSI	11/12→04/15	EXEO 1.8 TSI	05/10→05/13
ALTEA 1.8 TFSI	01/07→	LEON 1.8 TSI	06/07→12/12
ALTEA XL 1.8 TFSI	01/07→	TOLEDO III 1.8 TFSI	01/07→05/09

87-443800-00 STD
87-443807-00 0.50mm

08-443800-00 STD
08-443807-00 0.50mm

A 29.85
B- 4.70
B- 5.65
B+ 5.65
C 2.00
D 56.00
F 23x54



1.20 PVD NT
1.20 P
2.00 CR P

RT TP



Steel Stahl Acier Acero Acciaio

87.00

44

OM 615.912 (OM 615 D 22)	4cyl.	2197cc	44kW (60PS)	Diesel		TD21374
--------------------------	-------	--------	-------------	--------	--	---------





132 2.2 D 05/79→12/82

14-022190-00 D B 90.00 C 158.40 D 92.00 E 4.70

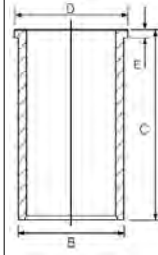

93.00 45

8144.61 4cyl. 2445cc 52-55kW (72-75PS) Diesel TD3597

131 2.4 Diesel 06/78→12/86

14-022560-00 D B 96.00 C 167.30 D 98.90 E 5.00

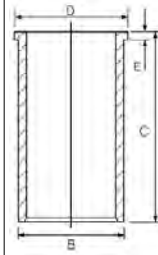

CCM

9

ADR	Petrol	1781	4	81.00	20
AEE	Petrol	1598	4	76.50	7
AEF	Diesel	1896	4	79.50	14
AEH	Petrol	1595	4	81.00	21
AEY	Diesel	1896	4	79.50	15
AGN	Petrol	1781	4	81.00	20
AGP	Diesel	1896	4	79.50	16
AGR	Diesel	1896	4	79.50	15
AGU	Petrol	1781	4	81.00	22
AHF	Diesel	1896	4	79.50	15
AKL	Petrol	1595	4	81.00	21
ALH	Diesel	1896	4	79.50	15
AMF	Diesel	1422	3	79.50	12
AQM	Diesel	1896	4	79.50	16
ARX	Petrol	1781	4	81.00	23
ARZ	Petrol	1781	4	81.00	22
ASV	Diesel	1896	4	79.50	15
ASY	Diesel	1896	4	79.50	16
ASZ	Diesel	1896	4	79.50	17
ATD	Diesel	1896	4	79.50	18
AUA	Petrol	1390	4	76.50	8
AUB	Petrol	1390	4	76.50	8
AUM	Petrol	1781	4	81.00	23
AUQ	Petrol	1781	4	81.00	23
AVB	Diesel	1896	4	79.50	18
AVF	Diesel	1896	4	79.50	17
AVU	Petrol	1595	4	81.00	24
AWT	Petrol	1781	4	81.00	23
AWX	Diesel	1896	4	79.50	17
AXP	Petrol	1390	4	76.50	8
AXR	Diesel	1896	4	79.50	18
AZQ	Petrol	1198	3	76.50	6
AZV	Diesel	1968	4	81.00	25
BBY	Petrol	1390	4	76.50	8
BBZ	Petrol	1390	4	76.50	8
BCA	Petrol	1390	4	76.50	8
BFQ	Petrol	1595	4	81.00	24
BGU (Euro 4)	Petrol	1595	4	81.00	24
BJB	Diesel	1896	4	79.50	18
BKC	Diesel	1896	4	79.50	18
BKD	Diesel	1968	4	81.00	25
BKY	Petrol	1390	4	76.50	9
BLR	Petrol	1984	4	82.50	30
BLS	Diesel	1896	4	79.50	18
BLT	Diesel	1896	4	79.50	17
BLX	Petrol	1984	4	82.50	30
BLY	Petrol	1984	4	82.50	30
BME	Petrol	1198	3	76.50	6
BMM	Diesel	1968	4	81.00	26
BMN	Diesel	1968	4	81.00	25
BMP	Diesel	1968	4	81.00	26
BMS	Diesel	1422	3	79.50	12
BNM	Diesel	1422	3	79.50	12
BNV	Diesel	1422	3	79.50	12
BSE (Euro 4/5)	Petrol	1595	4	81.00	24
BSF (Euro 2)	Petrol	1595	4	81.00	24
BSS	Diesel	1968	4	81.00	26
BSW	Diesel	1896	4	79.50	18
BUD	Petrol	1390	4	76.50	9
BVX	Petrol	1984	4	82.50	30

ENGINE INDEX

Motorverzeichnis • Index de moteur • Índice de Motor
 Indeks silnika • Модель Двигателя • دليل المحرك



CCM

x



9

BVY	Petrol	1984	4	82.50	30
BVZ	Petrol	1984	4	82.50	30
BWA	Petrol	1984	4	82.50	31
BXE	Diesel	1896	4	79.50	18
BXW	Petrol	1390	4	76.50	9
CAVE	Petrol	1390	4	76.50	10
CAXA (Euro 5)	Petrol	1390	4	76.50	11
CAXC	Petrol	1390	4	76.50	11
CAYA	Diesel	1598	4	79.50	13
CAYB	Diesel	1598	4	79.50	13
CAYC	Diesel	1598	4	79.50	13
CBBB	Diesel	1968	4	81.00	27
CBDB	Diesel	1968	4	81.00	27
CBZA	Petrol	1197	4	71.00	1
CBZB	Petrol	1197	4	71.00	1
CCZA	Petrol	1984	4	82.50	32
CDA A	Petrol	1798	4	82.50	33
CDAB	Petrol	1798	4	82.50	33
CDDA	Petrol	1390	4	76.50	9
CEGA	Diesel	1968	4	81.00	27
CFFB	Diesel	1968	4	81.00	28
CFGB	Diesel	1968	4	81.00	28
CFHA	Diesel	1968	4	81.00	28
CFHC	Diesel	1968	4	81.00	28
CFHF	Diesel	1968	4	81.00	28
CFJA	Diesel	1968	4	81.00	28
CFWA	Diesel	1199	3	79.50	13
CGGA	Petrol	1390	4	76.50	9
CGGB	Petrol	1390	4	76.50	9
CHGA	Petrol	1595	4	81.00	24
CHYA (Euro 5/6)	Petrol	999	3	74.50	3
CHYB (Euro 5/6)	Petrol	999	3	74.50	3
CJZA (Euro 6)	Petrol	1197	4	71.00	2
CJZB (Euro 5)	Petrol	1197	4	71.00	2
CJZC	Petrol	1197	4	71.00	2
CJZD	Petrol	1197	4	71.00	2
CKFC (Euro 5)	Diesel	1968	4	81.00	29
CLCA	Diesel	1968	4	81.00	28
CLCB	Diesel	1968	4	81.00	28
CLHA (Euro 5)	Diesel	1598	4	79.50	19
CLHB (Euro 5)	Diesel	1598	4	79.50	19
CLJA	Diesel	1968	4	81.00	28
CLNA	Diesel	1598	4	79.50	13
CLPA	Petrol	1390	4	76.50	9
CPGA	Petrol	999	3	74.50	3
CRKA (Euro 6)	Diesel	1598	4	79.50	19
CRKB (Euro 5/6)	Diesel	1598	4	79.50	19
CRLB (Euro 6)	Diesel	1968	4	81.00	29
CRMB (Euro 6)	Diesel	1968	4	81.00	29
CRVC	Diesel	1968	4	81.00	29
CTHE	Petrol	1390	4	76.50	10
CUUA	Diesel	1968	4	81.00	29
CUUB	Diesel	1968	4	81.00	29
CXMA	Diesel	1598	4	79.50	19
CXXA (Euro 6)	Diesel	1598	4	79.50	19
CXXB (Euro 6)	Diesel	1598	4	79.50	19
CYVA (Euro 6)	Petrol	1197	4	71.00	2
CYVB	Petrol	1197	4	71.00	2
CZCA (Euro 6)	Petrol	1395	4	74.50	4
DADA (Euro 6)	Petrol	1495	4	74.50	5

Motorverzeichnis • Index de moteur • Índice de Motor
 Indeks silnika • Модель Двигателя • دليل المحرك

ENGINE INDEX



CCM

x



9

DCXA	Diesel	1598	4	79.50	19
DCZA	Diesel	1598	4	79.50	19
DFSA	Diesel	1968	4	81.00	29
DFSB	Diesel	1968	4	81.00	29
DHFA (Euro 6)	Petrol	1498	4	74.50	5
DPCA (Euro 6)	Petrol	1495	4	74.50	5



71.00 1

CBZA	4cyl.	1197cc	63kW (86PS)	Petrol	Turbo Intercooled	TD23928
CBZB	4cyl.	1197cc	77kW (105PS)	Petrol	Turbo Intercooled	TD23583
FABIA II 1.2 TSI			03/10→12/14	RAPID 1.2 TSI		07/12→05/15
OCTAVIA II 1.2 TSI			02/10→06/13	ROOMSTER 1.2 TSI		03/10→05/15
RAPID 1.2 LPG			07/12→05/15	YETI 1.2 TSI		09/09→05/15

87-443900-10 STD

08-443900-00 STD

A 28.90
D 45.00
19x42



1.00 NT 1
1.20 P
2.00 NT 1

HA

1 Steel 1 Stahl 1 Acier 1 Acero 1 Acciaio

71.00 2

CJZA (Euro 6)	4cyl.	1197cc	77kW (105PS)	Petrol	Turbo Intercooled	TD27806
CJZB (Euro 5)	4cyl.	1197cc	63kW (86PS)	Petrol	Turbo Intercooled	TD27805
CJZC	4cyl.	1197cc	66kW (90PS)	Petrol	Turbo Intercooled	TD29846
CJZD	4cyl.	1197cc	81kW (110PS)	Petrol	Turbo Intercooled	TD29847
CYVA (Euro 6)	4cyl.	1197cc	63kW (86PS)	Petrol	Turbo Intercooled	TD34747
CYVB	4cyl.	1197cc	81kW (110PS)	Petrol	Turbo Intercooled	TD31355
FABIA III 1.2 TSI			08/14→	RAPID 1.2 TSI		05/15→12/19
OCTAVIA III 1.2 TSI			11/12→02/17	YETI 1.2 TSI		05/15→12/17

87-442300-10 STD 1 2

08-442300-10 STD 3

A 28.00
B+ 0.70
C 3.52
C 3.52
D 44.50
17x49
(07124A101)



1.20 NT 4
1.20 CR P
2.00 NT 4

AK HA TP

1 Earlier pistons to be replaced in Engine sets only 1 Frühere Kolben nur in Motorsätzen zu ersetzen 1 Premier piston à remplacer dans le jeu moteur 1 Pistones más antiguos para ser reemplados en juego de motore s solamente 1 Con i pistone di vecchia versione è necessario sostituire tu tta la serie
2 Elastoval ® 3 For Nüral OE piston 3 Für OE-Kolben von Nüral 3 Pour les pistones d'origine Nüral 3 Para pistones originales Nüral 3 Per pistoni Nüral OE
4 Steel 4 Stahl 4 Acier 4 Acero 4 Acciaio

74.50 3

CHYA (Euro 5/6)	3cyl.	999cc	44kW (60PS)	Petrol	TD26323
CHYB (Euro 5/6)	3cyl.	999cc	55kW (75PS)	Petrol	TD26325
CPGA	3cyl.	999cc	50kW (68PS)	Petrol	TD27817
CITIGO 1.0			10/11→08/19	FABIA III 1.0	08/14→
CITIGO 1.0 CNG			11/12→08/19		





87-443600-00 STD

- A 27.22
- B- 0.56
- BØ 58.07
- C 2.19
- D 42.22
- TP 17x39



08-443600-00 STD

- 1.00 NT
- 1.20 P
- 2.00 CR

TP

ECOTOUGH

Steel

Stahl

Acier

Acero

Acciaio

74.50

4

CZCA (Euro 6)	4cyl.	1395cc	92kW (125PS)	Petrol	Turbo Intercooled	TD31360
FABIA III 1.4 TSI R5			02/18→06/21	SUPERB III 1.4 TSI		03/15→
KODIAQ 1.4 TSI			10/16→	YETI 1.4 TSI		05/15→12/17
RAPID 1.4 TSI			05/15→			

87-449500-00 STD

- A 31.00
- B- 1.25
- BØ 53.07
- C 2.90
- C 4.40
- TP 19x47



08-449500-00 STD

- 1.20 NT
- 1.20 CR P
- 2.00 NT

TP

Steel

Stahl

Acier

Acero

Acciaio

74.50

5

DADA (Euro 6)	4cyl.	1495cc	110kW (150PS)	Petrol	Turbo Intercooled	TD34885
DHFA (Euro 6)	4cyl.	1498cc	96kW (131PS)	Petrol	Turbo Intercooled	TD37416
DPCA (Euro 6)	4cyl.	1495cc	110kW (150PS)	Petrol	Turbo Intercooled	TD37904
FABIA IV 1.5 TSI			11/21→	OCTAVIA IV 1.5 TSI		11/19→
KAMIQ 1.5 TSI			07/19→	OCTAVIA IV 1.5 TSI G-TEC		06/20→
KAROQ 1.5 TSI			07/17→	SCALA 1.5 TSI		02/19→
KODIAQ 1.5 TSI			07/18→	SUPERB III 1.5 TSI		02/17→
OCTAVIA III 1.5 TSI			02/17→10/20	SUPERB III 1.5 TSI		02/17→
OCTAVIA III 1.5 TSI G-TEC			01/19→10/20			

87-453500-00 STD

- A 30.80mm
- B- 5.00mm
- BØ 61.70mm
- C 2.30mm
- C 3.50mm
- D 48.90mm
- TP 19.00x50.00



08-453500-00 STD

- 1.20 PVD
- 1.20mm CR
- 2.00mm NT

RT TP

Steel

Stahl

Acier

Acero

Acciaio

76.50

6

AZQ	3cyl.	1198cc	47kW (64PS)	Petrol	TD17070
BME	3cyl.	1198cc	47kW (64PS)	Petrol	TD18836





FABIA I 1.2	01/03→03/08	ROOMSTER 1.2	05/06→01/07
-------------	-------------	--------------	-------------

87-447800-00 STD
87-447807-00 0.50mm

A 29.27
B- 4.00
BØ 62.00
C 2.16
C 1.27
D 50.27
E 17x46

08-447800-00 STD
08-447807-00 0.50mm

1.20 NT ①
1.50 P
2.50 CR ①

14-021571-00 D B 79.56 C 142.00 D 82.50 E 4.50
14-028360-00 D ② B 79.50 C 145.00 D 81.50 E 4.70

- ① Steel ② With recesses on crankshaft side
- ① Stahl ② Mit kurbelwellenseitigen Aussparungen
- ① Acier ② Avec évidements côté vilebrequin
- ① Acero ② Con escotaduras en la cara del cigüeñal
- ① Acciaio ② Con nicchie sul lato albero motore

76.50 **7**

AEE	4cyl.	1598cc	55kW (75PS)	Petrol	TD13394
FELICIA 1.6			06/98→12/01	FELICIA I 1.6 LX	08/95→03/98
FELICIA I 1.6			06/97→04/02	FELICIA II 1.6	01/98→06/01
FELICIA I 1.6 GLX			08/95→03/98	OCTAVIA I 1.6	09/96→09/04

14-021571-00 D B 79.56 C 142.00 D 82.50 E 4.50
14-028360-00 D ① B 79.50 C 145.00 D 81.50 E 4.70

- ① With recesses on crankshaft side
- ① Mit kurbelwellenseitigen Aussparungen
- ① Avec évidements côté vilebrequin
- ① Con escotaduras en la cara del cigüeñal
- ① Con nicchie sul lato albero motore

76.50 **8**

AUA	4cyl.	1390cc	55kW (75PS)	Petrol	TD15374
AUB	4cyl.	1390cc	74kW (100PS)	Petrol	TD15375
AXP	4cyl.	1390cc	55kW (75PS)	Petrol	TD16050
BBY	4cyl.	1390cc	55kW (75PS)	Petrol	TD17471
BBZ	4cyl.	1390cc	74kW (100PS)	Petrol	TD17472
BCA	4cyl.	1390cc	55kW (75PS)	Petrol	TD17495

FABIA I 1.4 16V	10/99→03/08	OCTAVIA II 1.4	05/04→05/06
OCTAVIA I 1.4 16V	08/00→12/10		

87-116100-00 STD
87-116107-00 0.50mm ①

A 28.92
B- 1.98
BØ 61.90
C 2.32
D 49.92
E 17x54

08-116100-00 STD
08-116107-00 0.50mm ①

1.20 NT ②
1.50 P
2.50 CR ②

- ① A = 28.670, D = 49.670
- ② Steel ② Stahl ② Acier ② Acero ② Acciaio

76.50 **9**

BKY	4cyl.	1390cc	55kW (75PS)	Petrol	TD18696
-----	-------	--------	-------------	--------	---------





BUD	4cyl.	1390cc	59kW (80PS)	Petrol	TD20190
BXW	4cyl.	1390cc	63kW (86PS)	Petrol	TD19089
CDDA	4cyl.	1390cc	63kW (86PS)	Petrol	TD26495
CGGA	4cyl.	1390cc	59kW (80PS)	Petrol	TD24838
CGGB	4cyl.	1390cc	63kW (85PS)	Petrol	TD24980
CLPA	4cyl.	1390cc	63kW (85PS)	Petrol	TD26496
FABIA I 1.4			05/04→12/07	OCTAVIA II 1.4	06/04→06/13
FABIA I 1.4 16V			10/99→03/08	ROOMSTER 1.4	09/06→05/15
FABIA II 1.4			01/07→12/14	ROOMSTER 1.4 LPG	03/10→05/15
FABIA II 1.4 LPG			01/07→11/14		

87-436900-00 STD ①
87-436907-00 0.50mm ①
 04/05→

- A** 28.92
- B-** 2.28
- BØ** 61.14
- C** 1.07
- C** 1.04
- D** 46.92
-  17x45

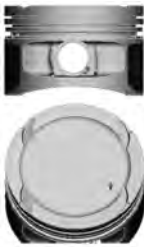

TP

08-436900-00 STD
08-436907-00 0.50mm

- 1.20  NT②
- 1.20  P
- 2.00  CR②

ECOTOUGH

① Pistons to be replaced in Engine Sets only ① Kolben nur in Motorsätzen zu ersetzen ① Piston à remplacer dans jeu moteur ① Pistones de repuesto para juegos de motores solamente ① Il pistone può essere rimpiazzato solamente completo
 ② Steel ② Stahl ② Acier ② Acero ② Acciaio

76.50

10

CAVE	4cyl.	1390cc	132kW (180PS)	Petrol	Turbo & Supercharged	TD24217
CTHE	4cyl.	1390cc	132kW (180PS)	Petrol	Turbo & Supercharged	TD27361
FABIA II 1.4 TSI RS			05/10→12/14			

87-433900-10 STD ① ②
87-433907-10 0.50mm ① ②

- A** 29.00
- B-** 6.40
- B+** 1.85
- C** 1.00
- C** 3.80
- D** 48.00
-  19x54



RT

08-433900-00 STD
08-433907-00 0.50mm

- 1.20  NT③
- 1.50  P
- 2.00  NT③

① Pistons to be replaced in Engine Sets only ① Kolben nur in Motorsätzen zu ersetzen ① Piston à remplacer dans jeu moteur ① Pistones de repuesto para juegos de motores solamente ① Il pistone può essere rimpiazzato solamente completo
 ② Elastoval® ③ Steel ③ Stahl ③ Acier ③ Acero ③ Acciaio

76.50

11

CAXA (Euro 5)	4cyl.	1390cc	90kW (122PS)	Petrol	Turbo Intercooled	TD21592
CAXC	4cyl.	1390cc	92kW (125PS)	Petrol	Turbo Intercooled	TD22677
OCTAVIA II 1.4 TSI			11/08→06/13	SUPERB II 1.4 TSI		07/08→05/15
RAPID 1.4 TSI			07/12→06/15	YETI 1.4 TSI		06/10→05/15





87-429900-00 STD ①
87-429907-00 0.50mm ①

A 29.20
B- 4.50
C 3.60
D 48.20
 19x52



HA

08-429900-00 STD
08-429907-00 0.50mm

1.20  NT②
 1.20  P
 2.00  NT②

① Elastoval Ⓞ
 ② Steel

② Stahl

② Acier

② Acero

② Acciaio

79.50

12

AMF	3cyl.	1422cc	55kW (75PS)	Diesel	Turbo Intercooled	TD17348
BMS	3cyl.	1422cc	59kW (80PS)	Diesel	Turbo Intercooled	TD19092
BNM	3cyl.	1422cc	51kW (70PS)	Diesel	Turbo Intercooled	TD18740
BNV	3cyl.	1422cc	59kW (80PS)	Diesel	Turbo Intercooled	TD18741
FABIA I 1.4 TDI		04/03→03/08		ROOMSTER 1.4 TDI		07/06→03/10
FABIA II 1.4 TDI		01/07→03/10				

87-114900-80 STD ① ②
87-114907-80 0.50mm ①

A 45.80
B- 17.65
BØ 38.00
C 1.10
D 69.80
 26x63

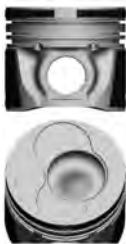

AK KK NB RT TP

08-114900-00 STD
08-114907-00 0.50mm
08-114911-00 1.00mm

1.75  CK P
 2.00  P
 3.00  CR P

14-027950-00 D **B 82.50 C 152.00 D 85.50 E 4.70**

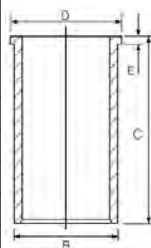

87-114900-85 STD ② ③
87-114907-85 0.50mm ③

A 45.80
B- 17.65
BØ 38.00
C 1.10
D 69.80
 26x63



AK KK NB RT TP

08-114900-00 STD
08-114907-00 0.50mm
08-114911-00 1.00mm

1.75  CK P
 2.00  P
 3.00  CR P

① To cylinder 1 & 2

② Bowl capacity 23.75cm³

③ To cylinder 3

① an Zylinder 1 & 2

② Volumen der Kolbenmulde 23.75cm³

③ an Zylinder 3

① sur cylindre 1 & 2

② Volume de la cavité du piston 23.75cm³

③ sur cylindre 3

① en el cilindro 1 & 2

② Vol. cavidad pistón 23.75cm³

③ en el cilindro 3

① a cilindro 1 & 2

② Volume camera pistone 23.75cm³

③ a cilindro 3

79.50

13

CAYA	4cyl.	1598cc	55kW (75PS)	Diesel	Turbo Intercooled	TD24216
CAYB	4cyl.	1598cc	66kW (90PS)	Diesel	Turbo Intercooled	TD23929
CAYC	4cyl.	1598cc	77kW (105PS)	Diesel	Turbo Intercooled	TD22678
CFWA	3cyl.	1199cc	55kW (75PS)	Diesel	Turbo Intercooled	TD24261
CLNA	4cyl.	1598cc	77kW (105PS)	Diesel	Turbo Intercooled	TD25764
FABIA II 1.2 TDI		05/10→12/14		ROOMSTER 1.2 TDI		03/10→05/15
FABIA II 1.6 TDI		03/10→12/14		ROOMSTER 1.6 TDI		03/10→05/15
OCTAVIA II 1.6 TDI		06/09→04/13		SUPERB II 1.6 TDI		09/10→05/15
RAPID 1.6 TDI		10/11→12/19		YETI 1.6 TDI		11/10→05/15





87-432900-00 STD ①
87-432905-00 0.25mm
87-432907-00 0.50mm

A 45.30
B- 10.70
B- 4.70
Bø 49.00
D 67.80
 26x66
 (0790MA-104)
KK RT TP



08-432900-00 STD
08-432905-00 0.25mm
08-432907-00 0.50mm

1.75  GDC P
 2.00  P
 3.00  CR P



① Bowl capacity 19.75cm³

① Volumen der Kolbenmulde 19.75cm³

① Volume de la cavité du piston 19.75cm³

① Vol. cavidad pistón 19.75cm³

① Volume camera pistone 19.75cm³

79.50

14

AEF	4cyl.	1896cc	47kW (64PS)	Diesel	TD13395
FELICIA 1.9 D			03/97→12/01	FELICIA II 1.9 D	01/98→06/01
FELICIA I 1.9 D			10/95→04/02		

87-990100-40 STD
87-990105-40 0.25mm
87-990107-40 0.50mm ①
87-990111-40 1.00mm ①

A 39.65
B- 1.90
D 65.70
 24x64
 (07945)
AK RT



08-990100-00 STD
08-990105-00 0.25mm
08-990107-00 0.50mm
08-990111-00 1.00mm

1.75  CR P
 2.00  P
 3.00  CR P

14-027950-00 D **B 82.50 C 152.00 D 85.50 E 4.70**

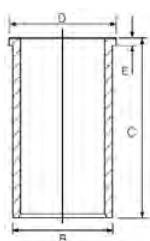

① A = 39.400

79.50

15

AEY	4cyl.	1896cc	47kW (64PS)	Diesel	TD18729
AGR	4cyl.	1896cc	66kW (90PS)	Diesel Turbo Intercooled	TD17905
AHF	4cyl.	1896cc	81kW (110PS)	Diesel Turbo Intercooled	TD17910
ALH	4cyl.	1896cc	66kW (90PS)	Diesel Turbo Intercooled	TD16090
ASV	4cyl.	1896cc	81kW (110PS)	Diesel Turbo Intercooled	TD16091
OCTAVIA I 1.9 TDI			09/96→03/10		

87-114900-60 STD ① ②
87-114907-60 0.50mm ① ② ③

A 45.80
B- 17.65
Bø 38.00
C 1.10
D 68.80
 26x66
 (07987)
AK KK NB RT



08-114900-00 STD
08-114907-00 0.50mm
08-114911-00 1.00mm

1.75  CK P
 2.00  P
 3.00  CR P

14-027950-00 D **B 82.50 C 152.00 D 85.50 E 4.70**

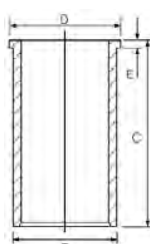



87-114900-70 STD ② ④
87-114907-70 0.50mm ② ③ ④

A 45.80
B- 17.65
BØ 38.00
C 1.10
D 68.80
 26x66



(07987A)
AK KK NB RT

08-114900-00 STD
08-114907-00 0.50mm
08-114911-00 1.00mm

1.75  CK P
 2.00  P
 3.00  CR P

87-114900-90 STD ①
87-114907-90 0.50mm ① ⑤
87-114900-95 STD ④
87-114907-95 0.50mm ④ ⑤

A 45.80
B- 17.65
BØ 38.00
C 1.10
D 71.80
 26x66



AK NB RT

08-114900-00 STD
08-114907-00 0.50mm
08-114911-00 1.00mm

1.75  CK P
 2.00  P
 3.00  CR P

- ① To cylinder 1 & 2
- ② Bowl capacity 23.54cm³
- ③ A = 45.550, D = 68.550
- ④ To cylinder 3 & 4
- ⑤ A = 45.550, D = 71.550

- ① an Zylinder 1 & 2
- ② Volumen der Kolbenmulde 23.54cm³
- ④ an Zylinder 3 & 4

- ① sur cylindre 1 & 2
- ② Volume de la cavité du piston 23.54cm³
- ④ sur cylindre 3 & 4

- ① en el cilindro 1 & 2
- ② Vol. cavidad pistón 23.54cm³
- ④ en el cilindro 3 & 4

- ① a cilindro 1 & 2
- ② Volume camera pistone 23.54cm³
- ④ a cilindro 3 & 4

79.50

16

AGP	4cyl.	1896cc	50kW (68PS)	Diesel	TD16424
AQM	4cyl.	1896cc	50kW (68PS)	Diesel	TD16089
ASY	4cyl.	1896cc	47kW (64PS)	Diesel	TD15376
FABIA I 1.9 SDI		11/99→03/08		OCTAVIA I 1.9 SDI	06/97→12/03
OCTAVIA I 1.9 D		08/00→12/03			

87-114900-20 STD ① ②
87-114907-20 0.50mm ① ③

A 39.80
B- 17.75
BØ 38.00
C 1.00
D 60.80
 24x58



(07959-109)

08-114900-00 STD
08-114907-00 0.50mm
08-114911-00 1.00mm

1.75  CK P
 2.00  P
 3.00  CR P

14-027950-00 D B 82.50 C 152.00 D 85.50 E 4.70

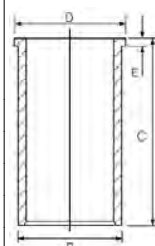



87-114900-30 STD ② ④
87-114907-30 0.50mm ③ ④

A 39.80
B- 17.75
BØ 38.00
C 1.00
D 60.80
 24x58



(07959A109)

08-114900-00 STD
08-114907-00 0.50mm
08-114911-00 1.00mm

1.75  CK P
 2.00  P
 3.00  CR P

① To cylinder 1 & 2
 ② Bowl capacity 23.60cm³
 ③ A = 39.550, D = 60.550
 ④ To cylinder 3 & 4

① an Zylinder 1 & 2
 ② Volumen der Kolbenmulde 23.60cm³
 ④ an Zylinder 3 & 4

① sur cylindre 1 & 2
 ② Volume de la cavité du piston 23.60cm³
 ④ sur cylindre 3 & 4

① en el cilindro 1 & 2
 ② Vol. cavidad pistón 23.60cm³
 ④ en el cilindro 3 & 4

① a cilindro 1 & 2
 ② Volume camera pistone 23.60cm³
 ④ a cilindro 3 & 4

79.50

17

ASZ	4cyl.	1896cc	96kW (130PS)	Diesel	Turbo Intercooled	TD17036
AVF	4cyl.	1896cc	96kW (130PS)	Diesel	Turbo Intercooled	TD18239
AWX	4cyl.	1896cc	96kW (130PS)	Diesel	Turbo Intercooled	TD16403
BLT	4cyl.	1896cc	96kW (130PS)	Diesel	Turbo Intercooled	TD20517
FABIA I 1.9 TDI RS			06/03→03/08	SUPERB I 1.9 TDI		12/01→03/08
OCTAVIA I 1.9 TDI			09/02→09/04			

87-114900-25 STD ① ②
87-114907-25 0.50mm ① ③
 →09/02

A 45.80
B- 17.90
BØ 38.00
C 1.10
D 68.80
 26x66



(07969K101)

AK KK NB RT TP

08-114900-00 STD
08-114907-00 0.50mm
08-114911-00 1.00mm

1.75  CK P
 2.00  P
 3.00  CR P

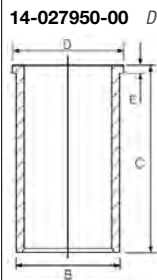

14-027950-00 D **B** 82.50 **C** 152.00 **D** 85.50 **E** 4.70

87-114900-35 STD ② ④
87-114907-35 0.50mm ③ ④
 →09/02

A 45.80
B- 17.90
BØ 38.00
C 1.10
D 68.80
 26x66

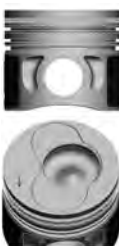

(07969K102)

AK KK NB RT TP

08-114900-00 STD
08-114907-00 0.50mm
08-114911-00 1.00mm

1.75  CK P
 2.00  P
 3.00  CR P





87-114900-45 STD ① ⑤
87-114907-45 0.50mm ① ③
 09/02→

A 45.80
B- 17.50
BØ 38.00
C 1.10
D 68.80
 26x66



(07901C105)

AK KK NB RT TP

08-114900-00 STD
08-114907-00 0.50mm
08-114911-00 1.00mm

1.75  CK P
 2.00  P
 3.00  CR P

87-114900-46 STD ④ ⑤
87-114907-46 0.50mm ③ ④
 09/02→

A 45.80
B- 17.50
BØ 38.00
C 1.10
D 68.80
 26x66



(07901C106)

AK KK NB RT TP

08-114900-00 STD
08-114907-00 0.50mm
08-114911-00 1.00mm

1.75  CK P
 2.00  P
 3.00  CR P

- ① To cylinder 1 & 2
- ② Bowl capacity 24.60cm³
- ③ A = 45.550, D = 68.550
- ④ To cylinder 3 & 4
- ⑤ Bowl capacity 24.05cm³

- ① an Zylinder 1 & 2
- ② Volumen der Kolbenmulde 24.60cm³
- ④ an Zylinder 3 & 4
- ⑤ Volumen der Kolbenmulde 24.05cm³

- ① sur cylindre 1 & 2
- ② Volume de la cavité du piston 24.60cm³
- ④ sur cylindre 3 & 4
- ⑤ Volume de la cavité du piston 24.05cm³

- ① en el cilindro 1 & 2
- ② Vol. cavidad pistón 24.60cm³
- ④ a cilindro 3 & 4
- ⑤ Volume camera pistone 24.05cm³

79.50

18

ATD	4cyl.	1896cc	74kW (100PS)	Diesel	Turbo Intercooled	TD15377
AVB	4cyl.	1896cc	74kW (101PS)	Diesel	Turbo Intercooled	TD17037
AXR	4cyl.	1896cc	74kW (100PS)	Diesel	Turbo Intercooled	TD20195
BJB	4cyl.	1896cc	77kW (105PS)	Diesel	Turbo Intercooled	TD17499
BKC	4cyl.	1896cc	77kW (105PS)	Diesel	Turbo Intercooled	TD17497
BLS	4cyl.	1896cc	77kW (105PS)	Diesel	Turbo Intercooled	TD19091
BSW	4cyl.	1896cc	77kW (105PS)	Diesel	Turbo Intercooled	TD20004
BXE	4cyl.	1896cc	77kW (105PS)	Diesel	Turbo Intercooled	TD20513

FABIA I 1.9 TDI	01/00→03/08	ROOMSTER 1.9 TDI	03/06→03/10
FABIA II 1.9 TDI	04/07→03/10	SUPERB I 1.9 TDI	08/02→10/05
OCTAVIA I 1.9 TDI	08/00→12/10	SUPERB II 1.9 TDI	03/08→11/10
OCTAVIA II 1.9 TDI	06/04→12/10		

87-114900-65 STD ① ②
87-114907-65 0.50mm ① ③

A 45.80
B- 17.20
BØ 38.00
C 1.10
D 68.80
 26x66



(07901D-301)

AK KK NB RT TP

08-114900-00 STD
08-114907-00 0.50mm
08-114911-00 1.00mm

1.75  CK P
 2.00  P
 3.00  CR P

14-027950-00 D **B 82.50 C 152.00 D 85.50 E 4.70**

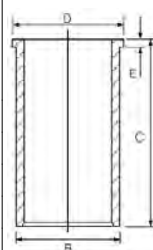



87-114900-66 STD ② ④
87-114907-66 0.50mm ③ ④

A 45.80
B- 17.20
BØ 38.00
C 1.10
D 68.80
 26x66



(07901D-302)
AK KK NB RT TP

08-114900-00 STD
08-114907-00 0.50mm
08-114911-00 1.00mm

1.75  CK P
 2.00  P
 3.00  CR P

① To cylinder 1 & 2
 ② Bowl capacity 22.85cm³
 ③ A = 45.550, D = 68.550
 ④ To cylinder 3 & 4

① an Zylinder 1 & 2
 ② Volumen der Kolbenmulde 22.85cm³
 ④ an Zylinder 3 & 4

① sur cylindre 1 & 2
 ② Volume de la cavité du piston 22.85cm³
 ④ sur cylindre 3 & 4

① en el cilindro 1 & 2
 ② Vol. cavidad pistón 22.85cm³
 ④ en el cilindro 3 & 4

① a cilindro 1 & 2
 ② Volume camera pistone 22.85cm³
 ④ a cilindro 3 & 4

79.50 **19**

CLHA (Euro 5)	4cyl.	1598cc	77kW (105PS)	Diesel	Turbo Intercooled	TD27810
CLHB (Euro 5)	4cyl.	1598cc	66kW (90PS)	Diesel	Turbo Intercooled	TD27972
CRKA (Euro 6)	4cyl.	1598cc	66kW (90PS)	Diesel	Turbo Intercooled	TD39461
CRKB (Euro 5/6)	4cyl.	1598cc	81kW (110PS)	Diesel	Turbo Intercooled	TD28543
CXMA	4cyl.	1598cc	85kW (115PS)	Diesel	Turbo Intercooled	TD31361
CXXA (Euro 6)	4cyl.	1598cc	66kW (90PS)	Diesel	Turbo Intercooled	TD35124
CXXB (Euro 6)	4cyl.	1598cc	81kW (110PS)	Diesel	Turbo Intercooled	TD31372
DCXA	4cyl.	1598cc	88kW (120PS)	Diesel	Turbo Intercooled	TD31652
DCZA	4cyl.	1598cc	88kW (120PS)	Diesel	Turbo Intercooled	TD31651

OCTAVIA III 1.6 TDI	11/12→10/20	SUPERB III 1.6 TDI	03/15→
RAPID 1.6 TDI	05/15→12/19		

87-444100-00 STD
87-444105-00 0.25mm
87-444107-00 0.50mm

A 45.30
B- 11.00
BØ 49.00
D 68.30
 26x66



AK KK RT TP

08-444100-00 STD
08-444105-00 0.25mm
08-444107-00 0.50mm

1.75  GDC P
 2.00  P
 2.00  CR P



81.00 **20**

ADR	4cyl.	1781cc	92kW (125PS)	Petrol	TD20805
AGN	4cyl.	1781cc	92kW (125PS)	Petrol	TD17903

OCTAVIA I 1.8	09/96→07/00	OCTAVIA I 1.8 20V	07/98→07/00
---------------	-------------	-------------------	-------------

87-502900-00 STD ①
87-502907-00 0.50mm ① ②

A 32.55
C 3.60
D 56.55
 20x59



(08192)
AK

08-502900-00 STD
08-502905-00 0.25mm
08-502907-00 0.50mm

1.50  CK P
 1.75  P
 2.00  CR P

① Conrod gap 27.50mm
 ② A = 32.250, D = 56.250

① Pleuelaugenabstand 27.50mm

① Distance entre bielle 27.50mm

① Distancia del biela 27.50mm

① Distanza dalla bille 27.50mm



81.00 **21**

AEH	4cyl.	1595cc	74kW (101PS)	Petrol	TD12950
AKL	4cyl.	1595cc	74kW (101PS)	Petrol	TD12951
OCTAVIA I 1.6		02/97→12/07			

87-105900-00 STD
87-105907-00 0.50mm

A 32.00
B- 2.30
BØ 61.40
B+ 0.70
D 53.70
 20x57

08-105900-00 STD
08-105907-00 0.50mm

1.20 NT
 1.50 P
 2.00 CR

A = 31.700, D = 53.400 Stahl Acier Acero Acciaio

81.00 **22**

AGU	4cyl.	1781cc	110kW (150PS)	Petrol	Turbo Intercooled	TD13396
ARZ	4cyl.	1781cc	110kW (150PS)	Petrol	Turbo Intercooled	TD16030
OCTAVIA I 1.8 T		08/97→12/10				

87-502900-10 STD
87-502905-10 0.25mm
87-502907-10 0.50mm

A 32.70
B- 2.05
BØ 70.00
D 53.70
 20x59

AK

08-502900-00 STD
08-502905-00 0.25mm
08-502907-00 0.50mm

1.50 CK P
 1.75 P
 2.00 CR P

81.00 **23**

ARX	4cyl.	1781cc	110kW (150PS)	Petrol	Turbo Intercooled	TD16069
AUM	4cyl.	1781cc	110kW (150PS)	Petrol	Turbo Intercooled	TD16070
AUQ	4cyl.	1781cc	132kW (180PS)	Petrol	Turbo Intercooled	TD16279
AWT	4cyl.	1781cc	110kW (150PS)	Petrol	Turbo Intercooled	TD16365
OCTAVIA I 1.8 T		08/97→12/10	SUPERB I 1.8 T		12/01→03/08	
OCTAVIA I RS 1.8 T		05/01→01/06				

87-502900-30 STD
87-502907-30 0.50mm

A 32.70
C 1.90
D 53.70
 19x49

TP

08-502900-00 STD
08-502905-00 0.25mm
08-502907-00 0.50mm

1.50 CK P
 1.75 P
 2.00 CR P

81.00 **24**

AVU	4cyl.	1595cc	75kW (102PS)	Petrol	TD16068
BFQ	4cyl.	1595cc	75kW (102PS)	Petrol	TD17912
BGU (Euro 4)	4cyl.	1595cc	75kW (102PS)	Petrol	TD17496





BSE (Euro 4/5)	4cyl.	1595cc	75kW (102PS)	Petrol	TD20898
BSF (Euro 2)	4cyl.	1595cc	75kW (102PS)	Petrol	TD20899
CHGA	4cyl.	1595cc	75kW (102PS)	Petrol	TD22691
OCTAVIA I 1.6			09/00→12/10	OCTAVIA II 1.6 LPG	08/09→11/12
OCTAVIA II 1.6			06/04→06/13		

87-148300-00 STD
87-148307-00 0.50mm

A 29.08
B- 2.70
BØ 62.30
D 50.70
 19x42



08-148300-00 STD
08-148307-00 0.50mm

1.00  NT 1
 1.20  P
 2.00  CR P

1 Steel

1 Stahl

1 Acier

1 Acero

1 Acciaio

81.00

25

AZV	4cyl.	1968cc	100kW (136PS)	Diesel	Turbo Intercooled	TD20909
BKD	4cyl.	1968cc	103kW (140PS)	Diesel	Turbo Intercooled	TD17500
BMN	4cyl.	1968cc	125kW (170PS)	Diesel	Turbo Intercooled	TD20735
OCTAVIA II 2.0 TDI			02/04→05/10	OCTAVIA II 2.0 TDI RS		04/06→02/13
OCTAVIA II 2.0 TDI 16V			02/04→05/13	SUPERB II 2.0 TDI 16V		01/09→05/15

87-139500-00 STD 1
87-139507-00 0.50mm 2

A 45.83
B- 17.80
BØ 38.00
D 68.80
 26x66
 (07901J)



08-139500-00 STD
08-139507-00 0.50mm

1.75  CK P
 2.00  P
 3.00  CR P

1 Bowl capacity 23.75cm³

1 Volumen der Kolbenmulde 23.75cm³

1 Volume de la cavité du piston 23.75cm³

1 Vol. cavidad pistón 23.75cm³

1 Volume camera pistone 23.75cm³

2 A = 45.550, D = 68.550

81.00

26

BMM	4cyl.	1968cc	103kW (140PS)	Diesel	Turbo Intercooled	TD19315
BMP	4cyl.	1968cc	103kW (140PS)	Diesel	Turbo Intercooled	TD20945
BSS	4cyl.	1968cc	103kW (140PS)	Diesel	Turbo Intercooled	TD19317
OCTAVIA II 2.0 TDI			11/05→05/10	SUPERB II 2.0 TDI		03/08→05/10
SUPERB I 2.0 TDI			10/05→03/08			

87-139500-10 STD 1 2
87-139507-10 0.50mm 1 3

A 45.83
B- 17.50
BØ 38.00
C 0.70
D 68.80
 26x66
 (07901D833)



08-139500-00 STD
08-139507-00 0.50mm

1.75  CK P
 2.00  P
 3.00  CR P

AK KK NB RT TP





87-139500-20 STD ② ④
87-139507-20 0.50mm ③ ④

A 45.83
B- 17.50
BØ 38.00
C 0.70
D 68.80
 26x66



(07901D834)
AK KK NB RT TP

08-139500-00 STD
08-139507-00 0.50mm

1.75  CK P
 2.00  P
 3.00  CR P

- ① To cylinder 1 & 2
- ② Bowl capacity 23.30cm³
- ③ A = 45.550
- ④ To cylinder 3 & 4

- ① an Zylinder 1 & 2
- ② Volumen der Kolbenmulde 23.30cm³
- ④ an Zylinder 3 & 4

- ① sur cylindre 1 & 2
- ② Volume de la cavité du piston 23.30cm³
- ④ sur cylindre 3 & 4

- ① en el cilindro 1 & 2
- ② Vol. cavidad pistón 23.30cm³
- ④ en el cilindro 3 & 4

- ① a cilindro 1 & 2
- ② Volume camera pistone 23.30cm³
- ④ a cilindro 3 & 4

	81.00					27
CBBB	4cyl.	1968cc	125kW (170PS)	Diesel	Turbo Intercooled	TD20944
CBDB	4cyl.	1968cc	103kW (140PS)	Diesel	Turbo Intercooled	TD23586
CEGA	4cyl.	1968cc	125kW (170PS)	Diesel	Turbo Intercooled	TD20905
OCTAVIA II 2.0 TDI RS		04/06→02/13		YETI 2.0 TDI		05/09→12/17
SUPERB II 2.0 TDI		07/08→05/15				

87-432300-00 STD ①
87-432307-00 0.50mm ①

A 45.80
B- 12.70
BØ 50.88
D 68.80
 26x66



(07901G202)
AK KK NB RT TP

08-432300-00 STD ②
08-432307-00 0.50mm

1.75  GDC P
 2.00  P
 3.00  CR P



- ① OE 03L 107 065G, Gen 1 engine only
- ② 08-432300-00 OE: 03L198151A

- ① OE 03L 107 065G, nur für Motoren der Generation 1

- ① N°OE 03L 107 065G, uniquement pour Moteur de génération 1

- ① OE 03L 107 065G, Generación 1 solo motor

- ① Solo motore Generation 1

	81.00					28
CFFB	4cyl.	1968cc	103kW (140PS)	Diesel	Turbo Intercooled	TD23589
CFGB	4cyl.	1968cc	125kW (170PS)	Diesel	Turbo Intercooled	TD23591
CFHA	4cyl.	1968cc	81kW (110PS)	Diesel	Turbo Intercooled	TD23584
CFHC	4cyl.	1968cc	103kW (140PS)	Diesel	Turbo Intercooled	TD23587
CFHF	4cyl.	1968cc	81kW (110PS)	Diesel	Turbo Intercooled	TD23585
CFJA	4cyl.	1968cc	125kW (170PS)	Diesel	Turbo Intercooled	TD23588
CLCA	4cyl.	1968cc	81kW (110PS)	Diesel	Turbo Intercooled	TD24839
CLCB	4cyl.	1968cc	103kW (140PS)	Diesel	Turbo Intercooled	TD24598
CLJA	4cyl.	1968cc	103kW (140PS)	Diesel	Turbo Intercooled	TD23590
OCTAVIA II 2.0 TDI		03/10→06/13		SUPERB II 2.0 TDI 16V		01/09→05/15
OCTAVIA II 2.0 TDI 16V		02/04→05/13		YETI 2.0 TDI		05/09→12/17
SUPERB II 2.0 TDI		07/08→05/15				





87-432300-10 STD ① ②
87-432307-10 0.50mm ① ②

A 45.80
B- 13.10
BØ 50.88
D 68.80
 26x66



(07901G220)
AK KK NB RT TP

08-432300-10 STD ③ ④
08-432307-10 0.50mm ③ ④

1.75  GDC P
 2.00  MO P
 3.00  CR P



- ① OE 03L 107 065S, Gen 2 engine only
- ② A = 45.500
- ③ Only fit to pistons equivalent to OE 03L 107065 AG, 03L 1070 65 S
- ④ 08-432300-10 OE: 03L198151C
- ① OE 03L 107 065S, nur für Motoren der Generation 2
- ③ Nur für OE Kolben 03L 107065 AG und 03L 107065 S
- ① N°OE 03L 107 065S, uniquement pour Moteur de génération 2
- ③ Seulement adapté aux pistons équivalents à OE 03L 107065 AGet 03L 107065 S
- ① OE 03L 107 065G, Generación 2 solo motor
- ③ Cabido solamente a los pistones equivalentes a OE 03L 107065 AG y 03L 107065 S
- ① Solo motore Generation 2
- ③ Adattato soltanto ai pistoni equivalenti OE a 03L 107065 AGe 03L 107065 S

81.00 **29**

CKFC (Euro 5)	4cyl.	1968cc	110kW (150PS)	Diesel	Turbo Intercooled	TD27811
CRLB (Euro 6)	4cyl.	1968cc	110kW (150PS)	Diesel	Turbo Intercooled	TD31653
CRMB (Euro 6)	4cyl.	1968cc	110kW (150PS)	Diesel	Turbo Intercooled	TD30582
CRVC	4cyl.	1968cc	105kW (143PS)	Diesel	Turbo Intercooled	TD27970
CUUA	4cyl.	1968cc	81kW (110PS)	Diesel	Turbo Intercooled	TD34096
CUUB	4cyl.	1968cc	110kW (150PS)	Diesel	Turbo Intercooled	TD31364
DFSA	4cyl.	1968cc	81kW (110PS)	Diesel	Turbo Intercooled	TD34066
DFSB	4cyl.	1968cc	110kW (150PS)	Diesel	Turbo Intercooled	TD34735

KAROQ 2.0 TDI	07/18→	SUPERB III 2.0 TDI	03/15→
OCTAVIA III 2.0 TDI	11/12→10/20	YETI 2.0 TDI	11/09→12/17
OCTAVIA IV 2.0 TDI	06/20→		

87-447500-10 STD ①

A 45.80
B- 12.90
BØ 50.88
D 68.80
 26x66



AK KK NB RT TP

08-447500-00 STD ② ③
08-447507-00 0.50mm ② ③

1.75  GDC P
 2.00  P
 2.00  CR NT



- ① OE 04L 107 065A
- ② EA288 Engine family
- ③ 2014->
- ① OE 04L 107 065A
- ② EA288 Motorenfamilie
- ① OE 04L 107 065A
- ② Famille de moteurs EA288
- ① OE 04L 107 065A
- ② Familia de motores EA288
- ① OE 04L 107 065A
- ② Motori famiglia EA288

82.50 **30**

BLR	4cyl.	1984cc	110kW (150PS)	Petrol	TD18102
BLX	4cyl.	1984cc	110kW (150PS)	Petrol	TD20393
BLY	4cyl.	1984cc	110kW (150PS)	Petrol	TD18101
BVX	4cyl.	1984cc	110kW (150PS)	Petrol	TD20394
BVY	4cyl.	1984cc	110kW (150PS)	Petrol	TD20518
BVZ	4cyl.	1984cc	110kW (150PS)	Petrol	TD20519

OCTAVIA II 2.0 FSI	11/04→04/09
--------------------	-------------





87-435100-00 STD 1

08-435100-10 STD

A 29.38
B+ 12.46
D 59.85
 19x44
 (08240B301)
TP



1.20  PVD NT 2
 1.50 
 2.00  CR

1 Elastoval®
2 Steel

2 Stahl

2 Acier

2 Acero

2 Acciaio

82.50

31

BWA 4cyl. **1984cc** **147kW** (200PS) **Petrol** **Turbo Intercooled** **TD20395**



OCTAVIA II 2.0 TFSI 10/05→02/13

87-438500-00 STD
87-438507-00 0.50mm

08-438500-00 STD
08-438507-00 0.50mm

A 29.50
B- 6.10
BØ 49.52
C 1.36
C 1.36
D 50.50
 20x59
AK RT TP



1.20  PVD 1
 1.50  P
 2.00  CR P

1 Steel

1 Stahl

1 Acier

1 Acero

1 Acciaio

82.50

32

CCZA 4cyl. **1984cc** **147kW** (200PS) **Petrol** **Turbo Intercooled** **TD22171**

OCTAVIA II 2.0 TFSI 10/05→02/13 SUPERB II 2.0 TFSI 05/10→05/15

87-443800-10 STD

08-443800-00 STD
08-443807-00 0.50mm

A 29.60
B- 6.15
BØ 49.60
C 3.60
D 50.00
 23x51
RT



1.20  PVD NT 1
 1.20  P
 2.00  CR P



1 Steel

1 Stahl

1 Acier

1 Acero

1 Acciaio

82.50

33

CDAA 4cyl. **1798cc** **118kW** (160PS) **Petrol** **Turbo Intercooled** **TD20943**

CDAB 4cyl. **1798cc** **112kW** (152PS) **Petrol** **Turbo Intercooled** **TD24597**

OCTAVIA II 1.8 TSI 06/07→06/13 YETI 1.8 TSI 05/09→12/17

SUPERB II 1.8 TSI 03/08→05/15





87-443800-00 STD
87-443807-00 0.50mm

08-443800-00 STD
08-443807-00 0.50mm

- A** 29.85
 - B-** 4.70
 - B-** 5.65
 - B+** 5.65
 - C** 2.00
 - D** 56.00
-  23x54



- 1.20  PVD NT 
- 1.20  P
- 2.00  CR P



RT TP

 Steel

 Stahl

 Acier

 Acero

 Acciaio

ENGINE INDEX

Motorverzeichnis • Index de moteur • Índice de Motor
 Indeks silnika • Модель Двигателя • دليل المحرك

CCM
x

9

M 160 E6AL B03	Petrol	599	3	63.50	1
M 160 E6AL B04	Petrol	599	3	63.50	1
M 160 E6AL B05	Petrol	599	3	63.50	1
M 160.910	Petrol	599	3	63.50	1
M 160.920	Petrol	698	3	66.50	3
M 160.921	Petrol	698	3	66.50	3
M 160.922	Petrol	698	3	66.50	3
M 160.923	Petrol	698	3	66.50	3
OM 639.939 (Euro 4)	Diesel	1493	3	83.00	4
OM 660.950	Diesel	799	3	65.50	2
OM 660.951	Diesel	799	3	65.50	2



63.50							1
M 160.910	3cyl.	599cc	33-55kW (45-75PS)	Petrol	Turbo Intercooled		TD26102
M 160 E6AL B03	3cyl.	599cc	40kW (55PS)	Petrol	Turbo Intercooled		TD22902
M 160 E6AL B04	3cyl.	599cc	33kW (45PS)	Petrol	Turbo Intercooled		TD22903
M 160 E6AL B05	3cyl.	599cc	45kW (61PS)	Petrol	Turbo Intercooled		TD22901
CABRIO 0.6			03/00→01/04	FORTWO 0.6			01/04→02/07
CITY-COUPE 0.6			07/98→01/04	FORTWO 0.6 Brabus			01/04→12/06
CROSSBLADE 0.6			06/02→12/03				

87-136700-00 STD
 87-136705-00 0.25mm
 87-136707-00 0.50mm

08-136700-00 STD
 08-136705-00 0.25mm
 08-136707-00 0.50mm

A 27.00
 B- 2.75
 BØ 50.00
 D 43.50
 16x48



1.20 CR
 1.50 P
 2.50 CR

Steel Stahl Acier Acero Acciaio

65.50							2
OM 660.950	3cyl.	799cc	33kW (45PS)	Diesel	Turbo Intercooled		TD20946
OM 660.951	3cyl.	799cc	40kW (54PS)	Diesel	Turbo Intercooled		TD24475
FORTWO 0.8 CDi			01/07→				

87-140600-00 STD

08-140600-00 STD

A 36.00
 B- 11.10
 BØ 38.70
 C 0.95
 C 0.95
 D 60.00
 23x53



1.50 CK P
 1.50 P
 2.50 CR P

RT

66.50							3
M 160.920	3cyl.	698cc	33-55kW (45-75PS)	Petrol	Turbo Intercooled		TD26103
M 160.921	3cyl.	698cc	45-60kW (61-82PS)	Petrol	Turbo Intercooled		TD22100
M 160.922	3cyl.	698cc	45-60kW (61-82PS)	Petrol	Turbo Intercooled		TD26301
M 160.923	3cyl.	698cc	74kW (101PS)	Petrol	Turbo Intercooled		TD26104
CABRIO 0.7			01/03→01/04	ROADSTER 0.7			04/03→11/05
CITY-COUPE 0.7			01/03→01/04	ROADSTER 0.7 Brabus			12/03→11/05
FORTWO 0.7			01/04→01/07				

87-427100-00 STD
 87-427105-00 0.25mm
 87-427107-00 0.50mm

08-427100-00 STD
 08-427105-00 0.25mm
 08-427107-00 0.50mm

A 25.20
 B- 3.30
 BØ 54.50
 D 41.70
 16x52



1.20 NT
 1.20 NT
 2.50 NT

TP

Steel Stahl Acier Acero Acciaio



83.00 **4**

OM 639.939 (Euro 4) 3cyl. **1493cc** **50-70kW** (58-95PS) **Diesel** **Turbo Intercooled** **TD23800**

FORFOUR 1.5 CDI 09/04→06/06

87-427500-00 STD
87-427507-00 0.50mm

- A** 45.65
- B-** 14.65
- BØ** 43.40
- C** 1.18
- C** 1.02
- D** 71.65
- 30x66



(8340A401)
AK KK RT

08-427500-00 STD
08-427507-00 0.50mm

- 2.00 CK
- 2.00 P
- 2.00 CR P





CCM

x



9

DC23	Diesel	2238	4	88.00	1
M 104.942	Petrol	2799	6	89.90	5
M 104.945	Petrol	2799	6	89.90	5
M 104.992	Petrol	3199	6	89.90	6
M 104.995	Petrol	3199	6	89.90	6
M 111.970	Petrol	2295	4	90.90	7
M 111.974	Petrol	2295	4	90.90	7
M 161.970	Petrol	2295	4	90.90	7
M 161.974	Petrol	2295	4	90.90	7
MB-OM 662 (OM 662 D 29)	Diesel	2874	5	89.00	3
OM 601.940	Diesel	2299	4	89.00	2
OM 602.940	Diesel	2874	5	89.00	2
OM 602.980	Diesel	2874	5	89.00	4
OM 661.940	Diesel	2299	4	89.00	2
OM 662.940 (OM 662 D 29)	Diesel	2874	5	89.00	2
OM 662.983 (OM 662 D 29 LA)	Diesel	2874	5	89.00	3
XD3P	Diesel	2497	4	94.00	9
XD3 T/TE	Diesel	2498	4	94.00	8



88.00					1
DC23	4cyl.	2238cc	50kW (68PS)	Diesel	TD3611
KORANDO 2.2 D		12/88→12/96			

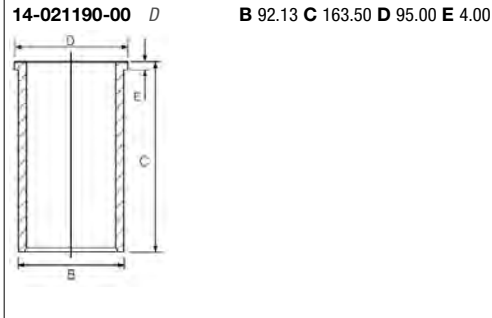

89.00					2
OM 601.940	4cyl.	2299cc	57-59kW (77-80PS)	Diesel	TD3612
OM 602.940	5cyl.	2874cc	70kW (95PS)	Diesel	TD3613
OM 661.940	4cyl.	2299cc	58kW (79PS)	Diesel	TD21373
OM 662.940 (OM 662 D 29)	5cyl.	2874cc	70kW (95PS)	Diesel Turbo Intercooled	TD21372
ISTANA 2.9 D		10/92→05/95		KORANDO 2.3 D	12/96→06/98
ISTANA 2.9 TD		10/92→05/95		MUSSO 2.3 D	03/93→04/99

87-743100-10 STD

87-743107-10 0.50mm

87-743120-10 0.70mm

08-743100-00 STD

08-743107-00 0.50mm

08-743120-00 0.70mm

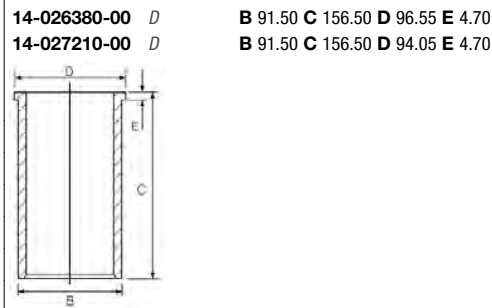

A 44.65

B- 8.25

C 1.25

C 1.50

D 74.65

26x62

(08953-209)

AK RT



2.50 CR P

2.00 P

3.00 CR P

Conrod guided in Piston

Kolbengeführtes Pleuel

Bielle guidée dans le piston

Biela montada en el pistòn

Billea montata sul pistone



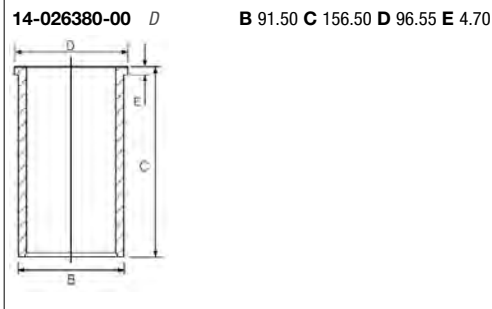





89.00					3
MB-OM 662 (OM 662 D 29)	5cyl.	2874cc	72-73kW (98-99PS)	Diesel	TD9355
OM 662.983 (OM 662 D 29 LA)	5cyl.	2874cc	88kW (120PS)	Diesel Turbo Intercooled	TD21371
KORANDO 2.9 D		12/96→10/00		MUSSO 2.9 D	03/96→11/98





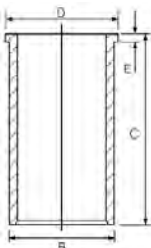

89.00					4
OM 602.980	5cyl.	2874cc	75-90kW (102-122PS)	Diesel Turbo Intercooled	TD19846
ISTANA 2.9 D		06/95→11/03			





<p>87-743100-00 STD 87-743107-00 0.50mm</p> <p>A 44.75 B- 16.73 BØ 42.00 C 0.60 C 0.30 D 71.25  28x70 (08980C) AK KK RT</p>	<p>08-743100-00 STD 08-743107-00 0.50mm 08-743120-00 0.70mm</p> <p>2.50  CR P 2.00  P 3.00  CR P</p>	<p>14-026380-00 D 14-027210-00 D</p> <p>B 91.50 C 156.50 D 96.55 E 4.70 B 91.50 C 156.50 D 94.05 E 4.70</p> 	
<p>87-743107-50 0.50mm</p> <p>A 44.55 B- 16.74 BØ 42.00 C 0.30 C 0.60 D 74.55  28x70 (08980C) KK RT</p>	<p>08-743100-00 STD 08-743107-00 0.50mm 08-743120-00 0.70mm</p> <p>2.50  CR P 2.00  P 3.00  CR P</p>		

89.90					5
M 104.942	6cyl.	2799cc	142-145kW (193-197PS)	Petrol	TD20447
M 104.945	6cyl.	2799cc	142kW (193PS)	Petrol	TD19845
CHAIRMAN 2.8		07/97→			

<p>87-287500-20 STD 87-287507-20 0.50mm ①</p> <p>A 32.38 B- 2.54 BØ 59.00 C 1.20 D 58.58  22x56 (09029)</p>	<p>08-287500-00 STD 08-287505-00 0.25mm 08-287507-00 0.50mm</p> <p>1.50  NT② 1.75  P 3.00  CR P</p>		
---	---	--	--

① A = 32.075, D = 58.075
② Steel

② Stahl

② Acier

② Acero

② Acciaio

89.90					6
M 104.992	6cyl.	3199cc	162kW (220PS)	Petrol	TD9357
M 104.995	6cyl.	3199cc	154-156kW (209-212PS)	Petrol	TD9374
CHAIRMAN 3.2		07/97→		MUSSO 3.2	06/96→09/04
KORANDO 3.2		12/96→11/06			





87-287500-30 STD ①
87-287505-30 0.25mm ①
87-287507-30 0.50mm ①

08-287500-00 STD
08-287505-00 0.25mm
08-287507-00 0.50mm

A 31.12
B- 1.20
BØ 74.00
C 1.60
D 2.50
D 56.10
 22x56
 (09024)



1.50  NT ②
 1.75  P
 3.00  CR P

① Elastoval®
 ② Steel

② Stahl

② Acier

② Acero

② Acciaio

90.90

7

M 111.970	4cyl.	2295cc	103-110kW (140-150PS)	Petrol	TD5544
M 111.974	4cyl.	2295cc	110kW (150PS)	Petrol	TD19459
M 161.970	4cyl.	2295cc	103-110kW (140-150PS)	Petrol	TD22101
M 161.974	4cyl.	2295cc	110kW (150PS)	Petrol	TD22102
CHAIRMAN 2.3			07/97→	KYRON 2.3	01/10→
KORANDO 2.3			05/97→06/06	MUSSO 2.3	10/96→11/02

87-109100-10 STD
87-109107-10 0.50mm

08-109100-00 STD
08-109107-00 0.50mm

A 30.00
B- 1.10
BØ 70.00
C 0.85
D 55.00
 22x56
 (09130)



1.50  NT ①
 1.75  NT ①
 3.00  NT ①

① Steel

① Stahl

① Acier

① Acero

① Acciaio

94.00

8

XD3 T/TE	4cyl.	2498cc	58kW (79PS)	Diesel Turbo	MP4386
KORANDO 2.5TD			01/97→		

14-020660-00 D **B 97.00 C 170.60 D 99.50 E 4.00**
14-021520-00 D **B 98.00 C 170.60 D 100.00 E 6.00**

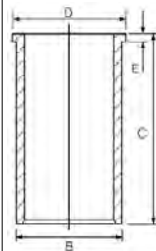

94.00

9

XD3P	4cyl.	2497cc	53-58kW (72-79PS)	Diesel	TD19458
KORANDO 2.5 D			06/93→05/97	KORANDO FAMILY 2.5 D	06/93→05/97





87-318700-10 STD
87-318706-10 0.40mm
 →12/93

A 54.00
B- 1.80
D 96.42
 30x79



08-318700-10 STD
08-318706-10 0.40mm
08-318708-10 0.60mm
08-318711-10 1.00mm

2.00 CR P
 2.00 P
 4.00 CR P



14-020660-00 D
14-021520-00 D

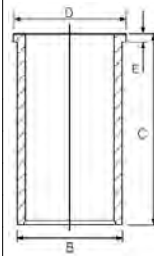

B 97.00 **C** 170.60 **D** 99.50 **E** 4.00
B 98.00 **C** 170.60 **D** 100.00 **E** 6.00

87-318700-30 STD
87-318710-30 0.80mm
 01/94→

A 54.00
B- 1.75
D 91.42
 30x79



08-318700-10 STD
08-318706-10 0.40mm
08-318708-10 0.60mm
08-318711-10 1.00mm

2.00 CR P
 2.00 P
 4.00 CR P



ENGINE INDEX

Motorverzeichnis • Index de moteur • Índice de Motor
 Indeks silnika • Модель Двигателя • دليل المحرك



CCM

x



9

Model	Fuel Type	CCM	x	Value	Value
WD 210.40	Diesel	1996	2	105.00	2
WD 311	Diesel	2590	3	100.00	1
WD 410.40	Diesel	3983	4	105.00	2
WD 411.41	Diesel	3456	4	100.00	1
WD 411.42	Diesel	3456	4	100.00	1
WD 411.43	Diesel	3456	4	100.00	1
WD 411.44	Diesel	3456	4	100.00	1
WD 411.45	Diesel	3456	4	100.00	1
WD 411.46	Diesel	3456	4	100.00	1
WD 411.85	Diesel	3456	4	100.00	1
WD 411.86	Diesel	3456	4	100.00	1
WD 411.87	Diesel	3456	4	100.00	1
WD 610.18	Diesel	5975	6	105.00	2
WD 610.19	Diesel	5975	6	105.00	2
WD 610.20	Diesel	5975	6	105.00	2
WD 610.40	Diesel	5975	6	105.00	2
WD 610.42	Diesel	5975	6	105.00	2
WD 610.44	Diesel	5975	6	105.00	2
WD 610.50	Diesel	5975	6	105.00	2
WD 611	Diesel	5184	6	100.00	1
WD 612.63	Diesel	6595	6	108.00	3
WD 612.65	Diesel	6595	6	108.00	3
WD 615.00	Diesel	9726	6	126.00	4
WD 615.20	Diesel	9726	6	126.00	4
WD 615.60	Diesel	9726	6	126.00	4
WD 615.61	Diesel	9726	6	126.00	4
WD 615.63	Diesel	9726	6	126.00	4
WD 615.64	Diesel	9726	6	126.00	4
WD 615.65	Diesel	9726	6	126.00	4
WD 615.67	Diesel	9726	6	126.00	4
WD 615.68	Diesel	9726	6	126.00	4
WD 615.69	Diesel	9726	6	126.00	4
WD 615.70	Diesel	9726	6	126.00	4
WD 615.71	Diesel	9726	6	126.00	4
WD 615.73	Diesel	9726	6	126.00	4
WD 615.74	Diesel	9726	6	126.00	4
WD 615.75	Diesel	9726	6	126.00	4
WD 615.77	Diesel	9726	6	126.00	4
WD 615.93	Diesel	9726	6	126.00	4



100.00

1

WD 311	3cyl.	2590cc		Diesel	MP6191
WD 411.41	4cyl.	3456cc	43kW (58PS)	Diesel	TD28866
WD 411.42	4cyl.	3456cc	43kW (58PS)	Diesel	TD28867
WD 411.43	4cyl.	3456cc	43-47kW (58-64PS)	Diesel	TD28868
WD 411.44	4cyl.	3456cc	43-47kW (58-64PS)	Diesel	TD28869
WD 411.45	4cyl.	3456cc	47kW (64PS)	Diesel	TD28870
WD 411.46	4cyl.	3456cc	47kW (64PS)	Diesel	TD28871
WD 411.85	4cyl.	3456cc	51kW (69PS)	Diesel	TD28872
WD 411.86	4cyl.	3456cc	51kW (69PS)	Diesel	TD28873
WD 411.87	4cyl.	3456cc	59kW (80PS)	Diesel	TD28874
WD 611	6cyl.	5184cc		Diesel	MP6193

AGRICULTURAL

14-451080-00 WH 1 B 109.40 C 197.00 D 118.00 E 9.00 F 1.10

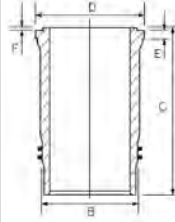

1 Water jacket chromed

1 Am Wassermantel verchromt

1 Chromé sur chambre d'eau

1 Camisa de agua cromada

1 Superficie cromata

105.00

2

WD 210.40	2cyl.	1996cc	24kW (33PS)	Diesel	MP8854
WD 410.40	4cyl.	3983cc	52kW (71PS)	Diesel	MP8855
WD 610.18	6cyl.	5975cc	81-97kW (110-132PS)	Diesel	TD19048
WD 610.19	6cyl.	5975cc	89-97kW (120-132PS)	Diesel	TD8986
WD 610.20	6cyl.	5975cc	97kW (132PS)	Diesel	TD8975
WD 610.40	6cyl.	5975cc	66-84kW (90-114PS)	Diesel	TD19049
WD 610.42	6cyl.	5975cc	66-84kW (90-114PS)	Diesel	TD19050
WD 610.44	6cyl.	5975cc	66-85kW (90-116PS)	Diesel	TD19051
WD 610.50	6cyl.	5975cc	66-85kW (90-116PS)	Diesel	TD19052

590-Serie

01/75→12/82

890-Serie

01/68→12/79

690-Serie

01/74→12/76

AGRICULTURAL

790-Serie

01/69→12/79

14-027790-00 D

B 110.00 C 222.00 D 112.00 E 4.70

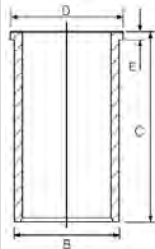

108.00

3

WD 612.63	6cyl.	6595cc	130-154kW (177-209PS)	Diesel	Turbo	TD5881
WD 612.65	6cyl.	6595cc	154kW (210PS)	Diesel	Turbo Intercooled	TD5882





87-896800-00 STD

- A 66.90
- B- 20.15
- BØ 63.00
- D 122.40
-  42x90



- 3.00  CK
- 2.50  P
- 4.00  CR P

126.00

4

WD 615.00	6cyl.	9726cc	148kW (201PS)	Diesel	Turbo	TD8990
WD 615.20	6cyl.	9726cc	148kW (201PS)	Diesel	Turbo	TD8991
WD 615.60	6cyl.	9726cc	191kW (260PS)	Diesel	Turbo	TD8993
WD 615.61	6cyl.	9726cc	191-198kW (260-269PS)	Diesel	Turbo	TD8994
WD 615.63	6cyl.	9726cc	204-206kW (278-280PS)	Diesel	Turbo Intercooled	TD8962
WD 615.64	6cyl.	9726cc	175-177kW (238-241PS)	Diesel	Turbo	TD8960
WD 615.65	6cyl.	9726cc	206kW (280PS)	Diesel	Turbo	TD8997
WD 615.67	6cyl.	9726cc	206kW (280PS)	Diesel	Turbo	TD5895
WD 615.68	6cyl.	9726cc	225-228kW (306-310PS)	Diesel	Turbo Intercooled	TD5883
WD 615.69	6cyl.	9726cc	206kW (280PS)	Diesel	Turbo	TD6242
WD 615.70	6cyl.	9726cc	191kW (260PS)	Diesel	Turbo	TD8995
WD 615.71	6cyl.	9726cc	191kW (260PS)	Diesel	Turbo	TD8996
WD 615.73	6cyl.	9726cc	204kW (278PS)	Diesel	Turbo	TD8963
WD 615.74	6cyl.	9726cc	175kW (238PS)	Diesel	Turbo	TD8961
WD 615.75	6cyl.	9726cc	206kW (280PS)	Diesel	Turbo	TD8998
WD 615.77	6cyl.	9726cc	206kW (280PS)	Diesel	Turbo	TD6311
WD 615.93	6cyl.	9726cc	206kW (280PS)	Diesel	Turbo	TD9005

991-Serie 01/78→12/86 1491-Serie 01/78→12/86
 1291-Serie 01/78→12/86

14-028240-00 DH

B 130.00 C 241.00 D 134.30 E 4.75

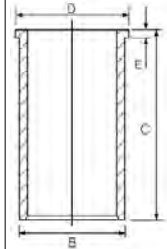



69.60 **1**

Z 13 DT 4cyl. **1248cc** **51kW (70PS)** **Diesel** **Turbo Intercooled** **TD21369**

JUSTY III 1.3 CDTi 12/03→08/07

87-137600-00 STD
87-137606-00 0.40mm

- A 40.43
- B- 12.40
- BØ 37.00
- C 1.00
- C 1.20
- D 63.43
- 23x57



08-137600-00 STD
08-137606-00 0.40mm

- 2.00 CK P
- 1.50 P
- 2.00 P



AK RT TP

73.00 **2**

1ND-TV (Euro 3/4) 4cyl. **1364cc** **55-66kW (75-90PS)** **Diesel** **Turbo Intercooled** **TD25016**

TREZIA 1.4 D 03/11→

87-424100-00 STD
87-424107-00 0.50mm

- A 41.94
- B- 14.70
- BØ 36.50
- C 0.90
- C 0.90
- D 64.35
- 27x59

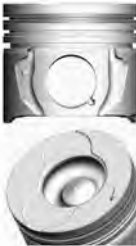

08-424100-00 STD
08-424107-00 0.50mm

- 1.50 NT
- 1.50 CR P
- 3.00 NT



KK RT

Steel

Stahl

Acier

Acero

Acciaio

86.00 **3**

Z 22 SE (Ecotec) 4cyl. **2198cc** **108kW (147PS)** **Petrol** **TD34094**

TRAVIQ 2.2 08/00→08/05

14-020450-00 D

B 89.02 C 137.25 D 95.45 E 4.63

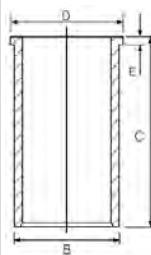

ENGINE INDEX

Motorverzeichnis • Index de moteur • Índice de Motor
 Indeks silnika • Модель Двигателя • دليل المحرك

CCM
x

9

8HY	Diesel	1398	4	73.70	3
9HX (Euro 4)	Diesel	1560	4	75.00	4
D19AA	Diesel	1910	4	82.00	6
DHV (XUD9BSD) (XUD9)	Diesel	1905	4	83.00	7
DHW (XUD9SD)	Diesel	1905	4	83.00	7
DW10ATED4 (RHW)	Diesel	1997	4	85.00	9
K9K 266	Diesel	1461	4	76.00	5
K9K 700	Diesel	1461	4	76.00	5
RHZ	Diesel	1997	4	85.00	10
XUD9	Diesel	1905	4	83.00	8
XUD9A	Diesel	1905	4	83.00	8
XUD9SD	Diesel	1905	4	83.00	7
Z 12 XEP	Petrol	1229	4	73.40	2
Z 13 DT	Diesel	1248	4	69.60	1



69.60 1

Z 13 DT 4cyl. **1248cc** **51kW (69PS)** **Diesel** **Turbo Intercooled** **TD18265**

IGNIS II 1.3 DDiS 09/03→ WAGON R+ 1.3 DDiS 09/03→
 SWIFT III 1.3 DDiS 08/05→

87-137600-00 *STD*
 87-137606-00 *0.40mm*

A 40.43
B- 12.40
BØ 37.00
C 1.00
C 1.20
D 63.43
 23x57



AK RT TP



08-137600-00 *STD*
 08-137606-00 *0.40mm*

2.00  CK P
 1.50  P
 2.00  P

73.40 2

Z 12 XEP 4cyl. **1229cc** **59kW (80PS)** **Petrol** **TD19903**

WAGON R+ 1.2 01/05→12/08 WAGON R 1.2 06/04→08/05

87-429500-10 *STD* 
 87-429507-10 *0.50mm* 

A 24.00
B+ 0.53
C 1.46
C 1.49
D 45.33
 19x50



TP

08-429500-00 *STD*
 08-429507-00 *0.50mm*

1.20  NT 
 1.20  P
 2.00  CR 

 Elastoval®

 Steel

 Stahl

 Acier

 Acero

 Acciaio

73.70 3

8HY 4cyl. **1398cc** **66kW (90PS)** **Diesel** **Turbo** **TD18220**

LIANA 1.4 DDiS 04/04→

87-135300-10 *STD*

A 42.94
B- 14.40
BØ 37.15
C 1.15
C 1.15
D 65.44
 25x60



KK RT TP

08-135300-00 *STD*
 08-135305-00 *0.25mm*
 08-135307-00 *0.50mm*

2.50  CK P
 1.95  P
 2.50  CR P

75.00 4

9HX (Euro 4) 4cyl. **1560cc** **66kW (90PS)** **Diesel** **Turbo Intercooled** **TD21659**

SX4 1.6 DDiS 04/07→





87-424000-00 STD
87-424008-00 0.60mm

A 41.70
B- 13.25
BØ 41.80
C 1.20
D 65.30
E 26x61



AK KK RT TP

08-424000-00 STD
08-424007-00 0.50mm
08-424008-00 0.60mm

3.00 CK P
1.95 P
2.50 CR P



14-020900-00 D B 78.00 C 142.00 D 79.50 F 5.00

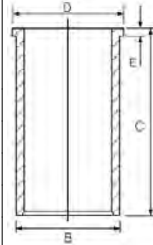

76.00

5

K9K 266	4cyl.	1461cc	63kW (86PS)	Diesel	Turbo Intercooled	TD24900
K9K 700	4cyl.	1461cc	48-50kW (65-68PS)	Diesel	Turbo Intercooled	TD21367
JIMNY 1.5 DDiS		12/03→				

87-123400-10 STD
87-123407-10 0.50mm

A 41.82
B- 13.70
BØ 39.70
C 0.60
D 66.05
E 26x60



(557.503)
RT TP

08-123400-00 STD
08-123407-00 0.50mm

2.00 CK P
2.00 P
2.50 NT

14-020650-00 D B 79.10 C 142.00 D 81.00 E 5.00

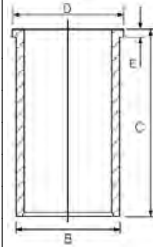

82.00

6

D19AA	4cyl.	1910cc	88kW (120PS)	Diesel	Turbo Intercooled	TD20931
SX4 1.9 DDiS		06/06→				

87-124000-30 STD
87-124008-30 0.60mm

A 46.50
B- 17.45
BØ 37.55
C 0.65
D 72.50
E 26x61



NB RT

08-124000-00 STD
08-124008-00 0.60mm

2.00 CK P
2.00 P
2.00 CR P

14-021051-00 D B 85.57 C 155.00 D 88.53 E 4.00
14-028960-00 D B 85.00 C 155.00 D 88.00 E 4.50



83.00

7

DHV (XUD9BSD) (XUD9)	4cyl.	1905cc	55kW (75PS)	Diesel	Turbo Intercooled	TD30748
DHW (XUD9SD)	4cyl.	1905cc	55kW (75PS)	Diesel	Turbo Intercooled	TD30747
XUD9SD	4cyl.	1905cc	55kW (75PS)	Diesel	Turbo Intercooled	TD22439
BALENO 1.9 TD	04/98→05/02		VITARA 1.9 D	08/96→03/99		





87-105500-00 STD
87-105507-00 0.50mm

A 46.75
B- 3.50
D 75.00
 28x68

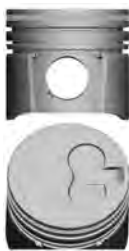

AK HA RT TP

08-105500-00 STD
08-105507-00 0.50mm

3.00  CK
 2.00  NT
 3.00  CR P

14-020530-00 D

B 85.60 **C** 153.50 **D** 88.50 **E** 3.90

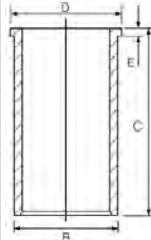

83.00

8

XUD9 4cyl. **1905cc** **46-50kW** (63-68PS) **Diesel** **Turbo Intercooled** **TD16375**

XUD9A 4cyl. **1905cc** **50kW** (68PS) **Diesel** **TD5443**

SAMURAI 1.9 TD 11/98→12/04 VITARA 1.9 D 01/95→03/98

87-152000-10 STD
87-152007-10 0.50mm
87-152010-10 0.80mm

A 46.80
B- 2.20
D 84.30
 25x72



08-152000-00 STD
08-152003-00 0.125mm
08-152007-00 0.50mm
08-152010-00 0.80mm

2.00  CR P
 2.00  P
 3.00  CR P

14-020530-00 D

B 85.60 **C** 153.50 **D** 88.50 **E** 3.90

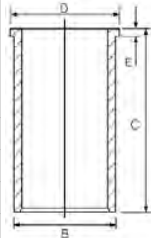

85.00

9

DW10ATED4 (RHW) 4cyl. **1997cc** **80kW** (109PS) **Diesel** **Turbo Intercooled** **TD18270**

GRAND VITARA I 2.0 HDI 110 16V 07/01→09/05

87-114700-10 STD
87-114708-10 0.60mm

A 46.73
B- 18.80
BØ 39.80
C 1.67
D 72.70
 28x68
 (08517-103)



AK KK RT TP

08-114700-00 STD
08-114708-00 0.60mm

3.50  CK P
 2.00  P
 3.00  CR P

85.00

10

RHZ 4cyl. **1997cc** **80kW** (109PS) **Diesel** **Turbo Intercooled** **TD19715**

GRAND VITARA I 2.0 HDI 110 02/01→12/03





87-114700-00 STD
87-114708-00 0.60mm

- A 46.75
- B- 18.30
- BØ 38.00
- C 1.00
- D 80.75
-  28x70



AK RT TP

08-114700-00 STD
08-114708-00 0.60mm

- 3.50  CK P
- 2.00  P
- 3.00  CR P

Motorverzeichnis • Index de moteur • Índice de Motor
 Indeks silnika • Модель ДВИгателя • دليل المحرك

ENGINE INDEX

CCM
x

9

CRD93 (U25/651)	Diesel	2500	4	93.00	5
M25/648	Diesel	2500	4	93.00	6
U25/673	Diesel	2500	4	93.00	6
XD2	Diesel	2304	4	94.00	7
XD2S (U8)	Diesel	2304	4	94.00	7
XN1TA	Petrol	1971	4	88.00	4
XUD9	Diesel	1905	4	83.00	3
XUD9A	Diesel	1905	4	83.00	3
XW7	Petrol	1124	4	72.00	1
XY8	Petrol	1361	4	75.00	2



72.00 **1**

XW7 4cyl. **1124cc** **37kW (50PS)** **Petrol** **TD4927**

SAMBA 1.1 01/81→06/86

14-636470-00 WH **B 79.50 C 122.00 D 89.20 E 85.00**

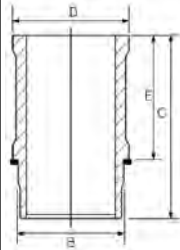

75.00 **2**

XY8 4cyl. **1361cc** **53-58kW (72-79PS)** **Petrol** **TD4929**

SAMBA 1.4 01/81→06/86 SAMBA 1.4 Rallye 01/83→10/86

15-636600-00 WH **B 79.50 C 134.50 D 89.20 E 90.00**

14-636600-00 WH **B 79.50 C 134.50 D 89.20 E 90.00**

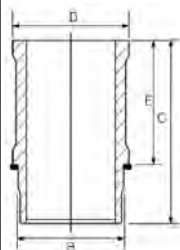

Includes seals Schließt Dichtungen ein Inclut des joints Incluye los sellos Comprende le guarnizioni

83.00 **3**

XUD9 4cyl. **1905cc** **47-48kW (64-65PS)** **Diesel** **TD4924**

XUD9A 4cyl. **1905cc** **51kW (69PS)** **Diesel** **TD9014**

EXPRESS 1000 -1500 1.9 D 07/87→10/90 HORIZON 1.9 Diesel 07/82→06/86

EXPRESS 1000 -1800 1.9 D 07/87→10/90

87-152000-10 STD
87-152007-10 0.50mm
87-152010-10 0.80mm

A 46.80
B- 2.20
D 84.30
 **25x72**



08-152000-00 STD
08-152003-00 0.125mm
08-152007-00 0.50mm
08-152010-00 0.80mm

2.00  CR P
 2.00  P
 3.00  CR P

14-020530-00 D **B 85.60 C 153.50 D 88.50 E 3.90**

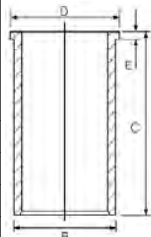

88.00 **4**

XN1TA 4cyl. **1971cc** **55-69kW (75-94PS)** **Petrol** **TD9015**

EXPRESS 1000 -1500 2.0 07/82→10/94 EXPRESS 1000 -1800 2.0 07/82→10/90





1 A 38.25 B+ 0.65 D 71.85 23x74	08-316900-00 STD 08-316907-00 0.50mm	14-636500-00 WH B 93.00 C 135.70 D 101.90 E 89.98	89-316900-00 3 14-636500-00
	1.50 CR P 2.00 P 4.00 CR 2	1 Piston available in Kit Set only 2 Steel 3 Includes seals	1 Piston disponible en kit seulement 2 Acier 3 Inclut des joints

93.00					5
CRD93 (U25/651)	4cyl.	2500cc	54-55kW (73-75PS)	Diesel	TD9017
EXPRESS 1000 -1500 2.5 D	07/82→10/94		EXPRESS 1000 -1800 2.5 D		07/82→10/94

87-152700-00 STD 87-152707-00 0.50mm A 52.75 B- 7.30 D 87.75 30x78	08-152700-00 STD 08-152707-00 0.50mm	14-013481-00 D B 96.10 C 163.00	
	2.50 MOL P 2.00 P 4.00 CR P	1 Piston nur im Assembly erhältlich 2 Stahl 3 Schließt Dichtungen ein	1 Piston disponible en kit seulement 2 Acier 3 Inclut des joints

93.00					6
M25/648	4cyl.	2500cc	70kW (95PS)	Diesel Turbo	MP4338
U25/673	4cyl.	2500cc	70kW (95PS)	Diesel Turbo	MP3909
EXPRESS 2.5D	01/87→		EXPRESS 1400		01/89→12/94

		14-013481-00 D B 96.10 C 163.00	
--	--	---	--

94.00					7
XD2	4cyl.	2304cc	44-53kW (60-72PS)	Diesel	TD21365
XD2S (U8)	4cyl.	2304cc	59kW (80PS)	Diesel Turbo	TD5288
TAGORA 2.3 Turbo Diesel	08/81→12/87				

		14-020660-00 D 14-021520-00 D B 97.00 C 170.60 D 99.50 E 4.00 B 98.00 C 170.60 D 100.00 E 6.00	
--	--	---	--

ENGINE INDEX

Motorverzeichnis • Index de moteur • Índice de Motor
 Indeks silnika • Модель Двигателя • دليل المحرك



CCM

x



9

1CD-FTV	Diesel	1995	4	82.20	4
1KD-FTV	Diesel	2982	4	96.00	10
1ND-TV (Euro 3/4)	Diesel	1364	4	73.00	1
2J	Diesel	2449	4	88.00	5
2L	Diesel	2446	4	92.00	6
2L-T	Diesel	2446	4	92.00	7
2L-TE	Diesel	2446	4	92.00	7
2L-TII	Diesel	2446	4	92.00	7
2WZ-TV	Diesel	1398	4	73.70	2
3ZZ-FE	Petrol	1598	4	79.00	3
11B	Diesel	2986	4	95.00	8
B	Diesel	2977	4	95.00	9
H	Diesel	3576	6	88.00	5



73.00

1

1ND-TV (Euro 3/4)	4cyl.	1364cc	50-66kW (68-90PS)	Diesel	Turbo Intercooled	TD16378
AURIS 1.4 D-4D			03/07→12/18	URBAN CRUISER 1.4 D-4D		01/09→04/14
AURIS VAN 1.4 D-4D			03/13→12/18	VERSO S 1.4 D4-D		11/10→10/16
COROLLA 1.4 D			07/04→02/07	YARIS 1.4 D		09/11→
COROLLA 1.4 D4-D			06/04→10/07	YARIS 1.4 D4d		07/14→
COROLLA 1.4 D-4D			03/04→12/18	YARIS 1.4 D-4D		10/01→12/12
ETIOS 1.4 D-4D			06/11→	YARIS VERSO 1.4 D-4D		09/00→09/05
IQ 1.4 D-4D			01/09→12/15	YARIS VERSO VAN 1.4 D4d		10/01→09/05
PROBOX / SUCCEED 1.4 D-4D			07/02→08/14			

87-424100-00 STD
87-424107-00 0.50mm

A 41.94
B- 14.70
BØ 36.50
C 0.90
C 0.90
D 64.35
27x59



KK RT

08-424100-00 STD
08-424107-00 0.50mm

1.50 NT
1.50 CR P
3.00 NT



Steel

Stahl

Acier

Acero

Acciaio

73.70

2

2WZ-TV	4cyl.	1398cc	40kW (54PS)	Diesel	Turbo Intercooled	TD24605
AYGO 1.4 HDi			07/05→08/10			

87-135300-00 STD
87-135307-00 0.50mm

A 42.94
B- 14.70
BØ 37.16
C 1.55
D 65.44
25x60



AK RT TP

08-135300-00 STD
08-135305-00 0.25mm
08-135307-00 0.50mm

2.50 CK P
1.95 P
2.50 CR P



14-020760-00 D
14-020761-00 D

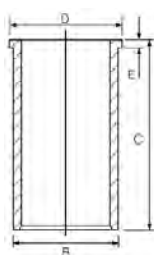

B 76.95 C 136.00 D 78.45 E 5.25
B 76.95 C 136.00 D 78.45 E 5.25

79.00

3

3ZZ-FE	4cyl.	1598cc	80-81kW (109-110PS)	Petrol	TD14229
AVENSIS 1.6			07/00→02/03	COROLLA 1.6 16V	10/99→12/01
AVENSIS 1.6 WT-i			10/00→11/08	COROLLA 1.6 WT-i	08/07→06/13
CONQUEST 1.6			01/96→12/99	COROLLA 1.6 WT-i	08/01→03/08
COROLLA 1.6			10/99→03/09		

87-426700-00 STD
87-426707-00 0.50mm

A 32.20
B- 3.80
D 52.20
20x50



08-426700-00 STD
08-426707-00 0.50mm

1.20 NT
1.20 P
3.00 NT



Steel

Stahl

Acier

Acero

Acciaio

82.20

4

1CD-FTV	4cyl.	1995cc	66-85kW (90-116PS)	Diesel	Turbo Intercooled	TD15191
---------	-------	--------	--------------------	--------	-------------------	---------





AVENSIS 2.0 D	09/02→02/03	COROLLA 2.0 D-4D	04/97→03/09
AVENSIS 2.0 D-4D	10/99→11/08	PREVIA II 2.0 D-4D	03/01→01/06
AVENSIS VERSO 2.0 D	08/01→08/05	RAV 4 II 2.0 D	05/01→11/05
COROLLA 2.0 D4d	09/00→10/01		

87-426600-00 STD

- A 47.90
- B- 17.50
- BØ 36.10
- C 0.96
- C 0.64
- D 74.90
- 31x67



AK KK RT TP

08-426600-00 STD

08-426607-00 0.50mm

- 2.00 CR
- 1.50 NT
- 3.00 NT

Steel Stahl Acier Acero Acciaio

88.00

5

2J	4cyl.	2449cc	39-55kW (53-75PS)	Diesel	TD3759
H	6cyl.	3576cc	66-77kW (90-105PS)	Diesel	TD15729
DYNA 2.4 D			08/77→08/87	LAND CRUISER 3.6 D	01/75→12/80
DYNA 3.6 D			08/77→11/84	TOYOACE 2.5 D	03/79→08/83
LAND CRUISER 3.6			01/75→10/80		

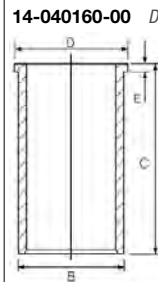

14-040160-00 D **B 93.05 C 183.67 D 97.79 E 2.50 F 1.25**

92.00

6

2L	4cyl.	2446cc	53-66kW (72-90PS)	Diesel	TD4938
4 RUNNER I 2.4 D			07/84→05/88	HILUX V 2.4 D	09/88→12/97
CHASER 2.4 D			08/84→08/96	HILUX VI 2.4 D	08/97→07/05
CRESTA III 2.4 D			09/88→09/92	MARK II 2.4 D	04/88→09/96
DYNA 2.4 D			08/77→05/95	KJANG 2.4 D	01/95→12/00
DYNA 100 2.4 D			05/95→07/01	LAND CRUISER 2.4 D	11/84→10/85
DYNA 150 2.4 D			08/85→04/95	QUALIS 2.4 D	01/99→10/04
HIACE III 2.4 D			12/82→11/89	QUICK DELIVERY 2.4 D	08/85→04/95
HIACE IV 2.4 D			08/87→12/04	STALLION 2.4 D	08/99→05/05
HILUX 2.4 D			01/84→08/88	TOWN ACE 2.4 D	04/85→12/91
HILUX IV 2.4 D			01/84→07/88	TOYOACE 2.4 D	08/82→03/85

87-373800-00 STD
→08/88

- A 49.20
- B- 1.60
- D 86.25
- 27x74



AK

08-373800-00 STD

08-373807-00 0.50mm

- 2.00 CR P
- 2.00 P
- 4.00 CR P

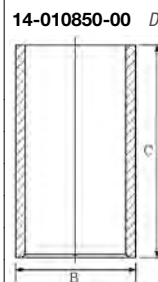

14-010850-00 D **B 96.07 C 179.00**





14-040130-00 *D* **B 96.00 C 160.00 D 100.80 E 3.50 F 1.00**

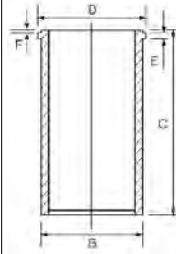

87-373800-10 *STD*
09/88→

A 44.30
B- 1.50
D 80.30
 27x70



AK TP

08-373800-00 *STD*
08-373807-00 0.50mm

2.00  CR P
2.00  P
4.00  CR P

92.00

7

2L-T	4cyl.	2446cc	63-94kW (85-128PS)	Diesel	Turbo Intercooled	TD3767
2L-TE	4cyl.	2446cc	66-71kW (90-97PS)	Diesel	Turbo Intercooled	TD24627
2L-TII	4cyl.	2446cc	60-71kW (82-97PS)	Diesel	Turbo Intercooled	TD21259
4 RUNNER II 2.4 D			08/89→11/95	HILUX II 2.4 TDi		08/90→07/93
BLIZZARD 2.4 TD			05/84→01/90	HILUX III 2.4 TD		08/97→07/01
CHASER 2.4 TD			08/84→07/99	HILUX V 2.4 D		09/88→08/97
CRESSIDA 2.4 TD			01/85→01/93	HILUX VI 2.4 TD		08/97→01/02
CRESTA III 2.4 TD			09/88→09/92	MARK II 2.4 TD		10/92→09/96
CRESTA IV 2.4 TD			10/92→09/96	MARK II IV 2.4 D		08/81→10/83
CRESTA V 2.4 TD			10/96→06/01	MARK II V 2.4 D		11/84→03/88
CROWN 2.4 D			08/94→07/02	MARK II V 2.4 TD		11/84→03/88
HIACE IV 2.4 TD			08/95→08/01	MARK II VI 2.4 TD		04/88→09/96
HILUX II 2.4 TD			08/88→11/98	LAND CRUISER 2.4 TD		10/85→05/96

14-010850-00 *D* **B 96.07 C 179.00**

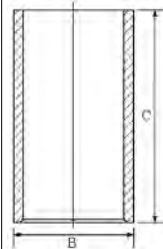

14-040130-00 *D* **B 96.00 C 160.00 D 100.80 E 3.50 F 1.00**

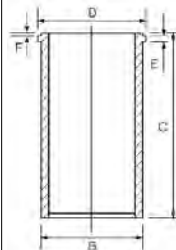

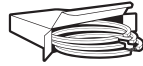

95.00				8
11B	4cyl.	2986cc	61-75kW (83-102PS)	Diesel
DYNA 3.0 D		09/84→05/95	DYNA 200 3.0 D	01/85→05/95

14-040150-00 D **B 102.00 C 190.22 D 107.75 E 2.55 F 1.20**

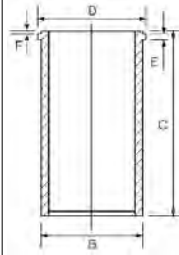

95.00				9
B	4cyl.	2977cc	59-63kW (80-86PS)	Diesel
DYNA 3.0 D		08/77→10/84	LAND CRUISER 3.0 D	03/69→10/84
DYNA 150 3.0 D		08/85→08/88	QUICK DELIVERY 3.0 D	08/85→07/95

87-526300-00 STD

08-526300-00 STD

14-040150-00 D **B 102.00 C 190.22 D 107.75 E 2.55 F 1.20**

A 52.20
B- 2.50
D 101.20
 29x79



2.50 CR
2.50 CR
4.50 CR

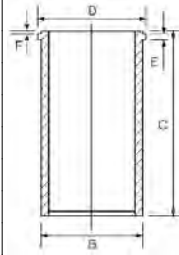

Pistons to be replaced in Engine Sets only Kolben nur in Motorsätzen zu ersetzen Piston à remplacer dans jeu moteur Pistones de repuesto para juegos de motores solamente Il pistone può essere rimpiazzato solamente completo

96.00				10
1KD-FTV	4cyl.	2982cc	75-150kW (102-204PS)	Diesel Turbo Intercooled
4 RUNNER IV 3.0 D		10/02→08/05	HILUX VII 3.0 D-4D	08/05→09/15
DYNA 3.0 D4d		09/06→	HILUX VII 3.0 Tdi	06/13→05/15
DYNA 3.0 D4d_, _Y2_, _U3_, _U4_, _U6_...		10/09→	HILUX VIII 3.0 D	08/15→
FORTUNER 3.0 D		06/04→05/15	LAND CRUISER 90 3.0 D-4D	02/00→08/02
FORTUNER 3.0 Tdi		05/15→	LAND CRUISER PRADO 3.0 D-4D	09/02→
HIACE / COMMUTER V 3.0 D		08/04→	LAND CRUISER PRADO 3.0 TDi	08/09→
HIACE V 3.0 D		01/05→	LAND CRUISER VAN 3.0 D4d	01/11→
HILUX 3.0 D		02/05→	REGIUS ACE 3.0 D-4D	08/04→
HILUX VII 3.0 D		03/05→05/15	TOYOACE 3.0 DiD	09/07→

87-422400-10 STD
87-422407-10 0.50mm

08-422400-00 STD
08-422407-00 0.50mm

A 49.60
B- 16.30
BØ 51.90
C 0.55
D 78.50
 34x73

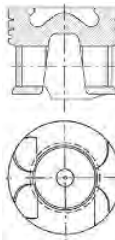

2.00 NT
1.50 NT
3.00 NT

AK KK RT TP

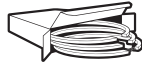

74.70

1

CF1 6cyl. **2498cc** **83-90kW** (113-122PS) **Petrol** **TD18385**

TR 6 I 2.5 01/72→12/76

- 87-525700-00 STD
- 87-525707-00 .020
- 87-525709-00 .030
- 87-525711-00 .040

- 08-525700-00 STD
- 08-525707-00 .020
- 08-525709-00 .030
- 08-525711-00 .040

- A** 29.03
- D** 61.98
- 21x62



- 1.58
 - 1.58
 - 4.00
- CR





70.99 **1**

TR6 2cyl. 649cc Petrol **MP11720**

BONNEVILLE Bonneville 650 T120 01/59→12/73

- 87-525400-00 *STD*
- 87-525411-00 *.040*
- 87-525414-00 *.060*

- A** 41.78
- D** 75.02
- 18x50

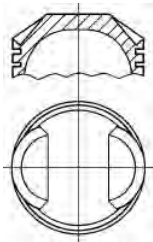

- 08-525400-00 *STD*
- 08-525407-00 *.020*
- 08-525411-00 *.040*
- 08-525414-00 *.060*

- 1.59 P
- 1.59 P
- 3.17 P



108.00

1

D113

4cyl.

Diesel

MP5581

AGRICULTURAL

14-260500-00 WH

B 125.00 C 258.00 D 132.00 E 10.10 F 1.30

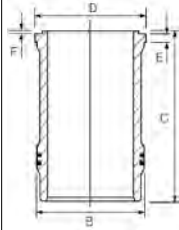

Phosphated

Phosphatiert

Phosphaté

Fosfatado

Fosfatato

ENGINE INDEX

Motorverzeichnis • Index de moteur • Índice de Motor
 Indeks silnika • Модель Двигателя • دليل المحرك

CCM

9

13 S	Petrol	1297	4	75.00	14
13 SB	Petrol	1297	4	75.00	14
14 NV	Petrol	1389	4	77.60	16
16 D	Diesel	1598	4	80.00	29
16 DA	Diesel	1598	4	80.00	29
16 SV	Petrol	1598	4	79.00	18
17 D (4EE1)	Diesel	1686	4	79.00	26
18 SE	Petrol	1796	4	84.80	46
18 SEH	Petrol	1796	4	84.80	46
18 SV	Petrol	1796	4	84.80	46
20 NE	Petrol	1998	4	86.00	48
20 XE	Petrol	1998	4	86.00	49
23 D	Diesel	2260	4	92.00	55
23 DTR	Diesel	2260	4	92.00	55
23 TD	Diesel	2260	4	92.00	55
23 YD	Diesel	2260	4	92.00	55
23 YDT	Diesel	2260	4	92.00	55
25TDS (VM41B)	Diesel	2499	4	92.00	56
843 A1.000	Petrol	1368	4	72.00	5
8140.23.2585/3700 (Sofim)	Diesel	2800	4	94.40	58
8140.43.2585/3700/3900 (Sofim)	Diesel	2800	4	94.40	58
A 12 XEL	Petrol	1229	4	73.40	9
A 12 XER	Petrol	1229	4	73.40	9
A 13 DTE	Diesel	1248	4	69.60	1
A 13 DTR (Euro 5)	Diesel	1248	4	69.60	1
A 13 FD (Euro 5)	Diesel	1248	4	69.60	2
A 14 NEL (Euro 5 ecoFlex)	Petrol	1364	4	72.50	7
A 14 NET (Euro 5)	Petrol	1364	4	72.50	7
A 14 XER	Petrol	1398	4	73.40	10
A 16 LET (Euro 5)	Petrol	1598	4	79.00	19
A 16 XER (Euro 5)	Petrol	1598	4	79.00	20
A 20 DT (Euro 5)	Diesel	1956	4	83.00	38
A 20 DTC (Euro 5)	Diesel	1956	4	83.00	38
A 20 DTH (Euro 5)	Diesel	1956	4	83.00	38
A 20 DTJ (Euro 5)	Diesel	1956	4	83.00	38
A 20 DTL (Euro 5)	Diesel	1956	4	83.00	38
B 10 XFL (Euro 6)	Petrol	999	3	74.00	13
B 10 XFT (Euro 6)	Petrol	998	3	74.00	13
B 14 NEJ (Euro 6)	Petrol	1364	4	72.50	7
B 14 NEL (Euro 6)	Petrol	1364	4	72.50	7
B 14 NET (Euro 6)	Petrol	1364	4	72.50	7
B 14 XEL	Petrol	1398	4	73.40	11
B 16 DT (DV6FD)	Diesel	1560	4	75.00	15
B 16 DTH	Diesel	1598	4	79.70	28
B 16 DTH (DV6FC)	Diesel	1560	4	75.00	15
C 13 N	Petrol	1297	4	75.00	14
C 14 NZ	Petrol	1389	4	77.60	16
C 16 NZ	Petrol	1598	4	79.00	21
C 16 SE	Petrol	1598	4	79.00	18
C 16 XE (Ecotec)	Petrol	1598	4	79.00	22
C 18 XE	Petrol	1799	4	81.60	34
C 18 XEL	Petrol	1799	4	81.60	34
C 20 NE	Petrol	1998	4	86.00	48
C 20 XE	Petrol	1998	4	86.00	49
C 25 XE	Petrol	2498	V6	81.60	35
C 223	Diesel	2238	4	88.00	52
D 10 XFL (Euro 6)	Petrol	999	3	74.00	13
D 14 NET (Euro 6)	Petrol	1364	4	72.50	7
D 16 DTH	Diesel	1598	4	79.70	28
D 16 DTN	Diesel	1598	4	79.70	28



CCM

x



9

E 16 NZ	Petrol	1598	4	79.00	21
E 16 SE	Petrol	1598	4	79.00	18
F8Q 606	Diesel	1870	4	80.00	30
F9Q 760	Diesel	1870	4	80.00	31
F9Q 762	Diesel	1870	4	80.00	31
F9Q 770	Diesel	1870	4	80.00	31
F9Q 772	Diesel	1870	4	80.00	31
F9Q 774	Diesel	1870	4	80.00	31
F 10 XFL (Euro 6)	Petrol	999	3	74.00	13
G9T 720	Diesel	2188	4	87.00	51
G9T 722	Diesel	2188	4	87.00	51
G9T 750	Diesel	2188	4	87.00	51
G9U 632 (Euro 4)	Diesel	2464	4	89.00	53
G9U 650 (Euro 4)	Diesel	2464	4	89.00	53
G9U 720 (Euro 3)	Diesel	2464	4	89.00	54
G9U 724 (Euro 3)	Diesel	2464	4	89.00	54
G9U 730 (Euro 3)	Diesel	2464	4	89.00	54
G9U 750 (Euro 3)	Diesel	2464	4	89.00	54
G9U 754 (Euro 3)	Diesel	2464	4	89.00	54
M9R 630	Diesel	1995	4	84.00	40
M9R 692 (Euro 5)	Diesel	1995	4	84.00	40
M9R 780 (Euro 4)	Diesel	1995	4	84.00	41
M9R 782	Diesel	1995	4	84.00	41
M9R 784	Diesel	1995	4	84.00	41
M9R 786 (Euro 4)	Diesel	1995	4	84.00	41
M9R 788	Diesel	1995	4	84.00	41
M9T 670 (Euro 5)	Diesel	2298	4	85.00	47
M9T 672 (Euro 5)	Diesel	2298	4	85.00	47
M9T 676 (Euro 4)	Diesel	2298	4	85.00	47
M9T 678	Diesel	2298	4	85.00	47
M9T 680	Diesel	2298	4	85.00	47
M9T 686 (Euro 5)	Diesel	2298	4	85.00	47
M9T 690 (Euro 5)	Diesel	2298	4	85.00	47
M9T 692 (Euro 4)	Diesel	2298	4	85.00	47
M9T 694 (Euro 4)	Diesel	2298	4	85.00	47
M9T 696 (Euro 4)	Diesel	2298	4	85.00	47
M9T 698 (Euro 5)	Diesel	2298	4	85.00	47
M9T 702	Diesel	2298	4	85.00	47
M9T 870	Diesel	2298	4	85.00	47
M9T 876	Diesel	2299	4	85.00	47
M9T 880	Diesel	2298	4	85.00	47
M9T 898	Diesel	2298	4	85.00	47
R9M 408	Diesel	1598	4	80.00	32
R9M 413	Diesel	1598	4	80.00	32
R9M 450	Diesel	1598	4	80.00	32
S8U 758	Diesel	2500	4	93.00	57
S8U 780	Diesel	2500	4	93.00	57
S8U 782	Diesel	2500	4	93.00	57
S9W 700	Diesel	2800	4	94.40	58
S9W 702	Diesel	2800	4	94.40	58
X 10 XE	Petrol	973	3	72.50	6
X 12 XE	Petrol	1199	4	72.50	8
X 14 NZ	Petrol	1389	4	77.60	16
X 14 SZ	Petrol	1389	4	77.60	16
X 16 SZ	Petrol	1598	4	79.00	21
X 16 SZR	Petrol	1598	4	79.00	23
X 16 XE (Ecotec)	Petrol	1598	4	79.00	22
X 16 XEL (Ecotec)	Petrol	1598	4	79.00	22
X 17 D (4EE1)	Diesel	1686	4	79.00	26
X 18 XE	Petrol	1799	4	81.60	34

ENGINE INDEX

Motorverzeichnis • Index de moteur • Índice de Motor
 Indeks silnika • Модель Двигателя • دليل المحرك

CCM
x

9

X 18 XE1 (Ecotec)	Petrol	1796	4	80.50	33
X 20 DTH	Diesel	1995	4	84.00	42
X 20 DTL	Diesel	1995	4	84.00	43
X 22 DTH	Diesel	2171	4	84.00	44
X 25 XE	Petrol	2498	V6	81.60	35
Y 13 DT	Diesel	1248	4	69.60	3
Y 16 XE (Ecotec)	Petrol	1598	4	79.00	24
Y 17 DT	Diesel	1686	4	79.00	27
Y 17 DTL	Diesel	1686	4	79.00	27
Y 20 DTH	Diesel	1995	4	84.00	45
Y 20 DTJ	Diesel	1956	4	83.00	38
Y 20 DTL	Diesel	1995	4	84.00	43
Y 22 DTH	Diesel	2171	4	84.00	44
Y 22 DTR	Diesel	2172	4	84.00	44
Z 10 XE	Petrol	973	3	72.50	6
Z 12 XE (Ecotec)	Petrol	1199	4	72.50	8
Z 12 XEP	Petrol	1229	4	73.40	12
Z 13 DT (Euro 4)	Diesel	1248	4	69.60	3
Z 13 DTE (Euro 4)	Diesel	1248	4	69.60	2
Z 13 DTH	Diesel	1248	4	69.60	4
Z 14 XE (Ecotec)	Petrol	1389	4	77.60	17
Z 14 XEP (Ecotec)	Petrol	1364	4	73.40	11
Z 16 LET	Petrol	1598	4	79.00	19
Z 16 SE	Petrol	1598	4	79.00	24
Z 16 XE (Ecotec)	Petrol	1598	4	79.00	24
Z 16 XEP	Petrol	1598	4	79.00	25
Z 16 XER	Petrol	1598	4	79.00	20
Z 18 XE (Ecotec)	Petrol	1796	4	80.50	33
Z 18 XEL (Ecotec)	Petrol	1796	4	80.50	33
Z 19 DT	Diesel	1910	4	82.00	36
Z 19 DTH (Euro 4)	Diesel	1910	4	82.00	37
Z 19 DTJ	Diesel	1910	4	82.00	37
Z 19 DTL (Euro 4)	Diesel	1910	4	82.00	36
Z 20 DM	Diesel	1991	4	83.00	39
Z 20 DMH	Diesel	1991	4	83.00	39
Z 20 DTJ	Diesel	1956	4	83.00	38
Z 22 SE (Ecotec)	Petrol	2198	4	86.00	50



69.60

1

A 13 DTE	4cyl.	1248cc	70kW (95PS)	Diesel	Turbo Intercooled	TD24232
A 13 DTR (Euro 5)	4cyl.	1248cc	70kW (95PS)	Diesel	Turbo Intercooled	TD28000
ASTRA Mk VI 1.3 CDTi			12/09→10/15	CORSAVAN Mk III 1.3 CDTi		07/06→
ASTRA Mk VI 1.3 CDTi			10/10→10/15	MERIVA Mk II 1.3 CDTi		06/10→
CORSA Mk III 1.3 CDTi			07/10→08/14			

87-435700-10 STD

87-435706-10 0.40mm

A 40.43
B- 12.70
BØ 37.00
C 1.15
C 0.90
D 62.43
 23x57



AK KK RT

08-435700-00 STD

08-435706-00 0.40mm

1.50 GDC P
1.50 P
2.00 CR P



Without Stop/Start Technology Für Fahrzeuge ohne StartStop Funktion Pour véhicules non équipé du start & stop Para vehículos sin función start-stop Per veicoli senza la funzione Start-Stop

69.60

2

A 13 FD (Euro 5)	4cyl.	1248cc	55-70kW (75-90PS)	Diesel	Turbo Intercooled	TD26203
Z 13 DTE (Euro 4)	4cyl.	1248cc	70kW (95PS)	Diesel	Turbo Intercooled	TD24377
COMBO Mk III Body/MPV 1.3 CDTi			11/11→	CORSAVAN Mk III 1.3 CDTi		07/06→
CORSA Mk III 1.3 CDTi			07/10→08/14			

87-435700-00 STD

87-435706-00 0.40mm

A 40.43
B- 12.70
BØ 37.00
C 1.15
C 0.90
D 62.43
 23x57



AK KK RT

08-435700-00 STD

08-435706-00 0.40mm

1.50 GDC P
1.50 P
2.00 CR P



With Stop/Start Technology Für Fahrzeuge mit StartStop Funktion Pour véhicules équipé du start & stop Para vehículos con función start-stop Per veicoli con la funzione Start-Stop

69.60

3

Y 13 DT	4cyl.	1248cc	51kW (69PS)	Diesel	Turbo Intercooled	TD23798
Z 13 DT (Euro 4)	4cyl.	1248cc	51-52kW (70-71PS)	Diesel	Turbo Intercooled	TD18361
COMBO Mk II Body/MPV 1.3 CDTi 16V			09/04→02/12	CORSAVAN Mk II 1.3 CDTi 16V		04/04→06/06
COMBO TOUR Mk II 1.3 CDTi 16V			09/04→09/06	MERIVA A 1.3 CDTi		04/05→06/10
CORSA Mk II 1.3 CDTi 16V			10/03→04/07	TIGRA 1.3 CDTi		06/04→08/09

87-137600-00 STD

87-137606-00 0.40mm

A 40.43
B- 12.40
BØ 37.00
C 1.00
C 1.20
D 63.43
 23x57



AK RT TP

08-137600-00 STD

08-137606-00 0.40mm

2.00 CK P
1.50 P
2.00 P



69.60 4

Z 13 DTH 4cyl. **1248cc** **66-74kW** (90-101PS) **Diesel** **Turbo Intercooled** **TD18654**

ASTRA Mk V 1.3 CDTi	08/04→11/10	CORSA Mk III 1.3 CDTi	08/06→08/14
ASTRA Mk V 1.3 CDTi	01/04→05/09	CORSAVAN Mk III 1.3 CDTi	07/06→
ASTRAVAN Mk V 1.3 CDTi	08/05→		

87-425600-00 STD

87-425606-00 0.40mm

87-425608-00 0.60mm

A 40.43

B- 12.41

BØ 38.00

C 0.91

C 0.91

D 62.43

23x55

(06933)

AK KK RT TP



08-425600-00 STD

08-425606-00 0.40mm

08-425608-00 0.60mm

2.00 CK P

1.50 NT

2.00 CR P

72.00 5

843 A1.000 4cyl. **1368cc** **70kW** (95PS) **Petrol** **TD26415**

COMBO 1.4 11/11→

87-433200-00 STD

87-433206-00 0.40mm

A 26.00

B- 7.80

BØ 57.60

C 1.40

C 2.20

D 46.00

18x49



08-433200-00 STD

08-433206-00 0.40mm

1.00 NT

1.20 P

2.00 P

66.00kW→

Steel

Stahl

Acier

Acero

Acciaio

72.50 6

X 10 XE 3cyl. **973cc** **40kW** (54PS) **Petrol** **TD17619**

Z 10 XE 3cyl. **973cc** **43kW** (58PS) **Petrol** **TD17630**

AGILA Mk I 1.0 12V 09/00→08/05 CORSA Mk II 1.0 12V 09/00→10/03

CORSA Mk I 1.0 i 12V 11/96→09/00

87-102700-00 STD

87-102707-00 0.50mm

A 24.00

B- 1.20

BØ 56.00

C 1.25

D 45.00

18x51



08-102700-00 STD

08-102707-00 0.50mm

1.20 NT

1.50 P

2.00 CR

Steel

Stahl

Acier

Acero

Acciaio

72.50 7

A 14 NEL (Euro 5 ecoFlex) 4cyl. **1364cc** **88kW** (120PS) **Petrol** **Turbo Intercooled** **TD24744**

A 14 NET (Euro 5) 4cyl. **1364cc** **103kW** (140PS) **Petrol** **Turbo Intercooled** **TD24731**

B 14 NEJ (Euro 6) 4cyl. **1364cc** **74kW** (101PS) **Petrol** **Turbo Intercooled** **TD33727**









B 14 NEL (Euro 6)	4cyl.	1364cc	74-88kW (101-120PS)	Petrol	Turbo Intercooled	TD29773
B 14 NET (Euro 6)	4cyl.	1364cc	103-110kW (140-150PS)	Petrol	Turbo Intercooled	TD30248
D 14 NET (Euro 6)	4cyl.	1364cc	103kW (140PS)	Petrol	Turbo Intercooled	TD35621
ASTRA Mk VI 1.4 Turbo			12/09→10/15	INSIGNIA Mk I 1.4 LPG		07/12→05/17
ASTRA Mk VI GTC 1.4			10/11→10/15	MERIVA Mk II 1.4		06/10→
CASCADA 1.4			02/13→	MERIVA Mk II 1.4 LPG		06/11→
CORSA Mk III 1.4			08/12→08/14	MOKKA / MOKKA X 1.4		06/12→
CORSA Mk IV 1.4			08/14→	ZAFIRA Mk III 1.4		10/11→08/18
INSIGNIA Mk I 1.4			04/11→05/17			

87-437400-10 STD
87-437407-10 0.50mm

08-437400-00 STD ①
08-437407-00 0.50mm ①

A 25.87
B- 2.90
BØ 54.78
C 2.10
C 1.87
D 44.18
 18x48



1.20  DLC NT ②
 1.20  P
 2.00  NT ②

HA RT TP

① CarboGlide®
 ② Steel

② Stahl

② Acier

② Acero

② Acciaio

72.50

8

X 12 XE	4cyl.	1199cc	48kW (65PS)	Petrol	TD17620
Z 12 XE (Ecotec)	4cyl.	1199cc	55kW (75PS)	Petrol	TD17935
AGILA Mk I 1.2 16V			09/00→03/08	CORSA Mk II 1.2 16V	09/00→10/06
CORSA Mk I 1.2 i 16V			03/98→09/00	CORSAVAN Mk II 1.2 16V	09/00→06/06

87-102700-10 STD
87-102707-10 0.50mm

08-102700-00 STD
08-102707-00 0.50mm

A 24.00
C 1.25
D 45.00
 18x51



1.20  NT ①
 1.50  P
 2.00  CR ①

① Steel

① Stahl

① Acier

① Acero

① Acciaio

73.40

9

A 12 XEL	4cyl.	1229cc	51kW (69PS)	Petrol	TD24747
A 12 XER	4cyl.	1229cc	61-63kW (83-86PS)	Petrol	TD24752
ADAM 1.2			10/12→04/19	CORSA Mk III 1.2 LPG	08/11→08/14
CORSA Mk III 1.2			06/10→08/14	CORSAVAN Mk III 1.2	01/10→
CORSA Mk III 1.2 i 16V			12/09→08/14		





87-429500-40 STD
87-429507-40 0.50mm

A 26.90
BØ 54.60
B+ 0.65
C 1.35
C 3.95
D 48.55
 18x53



08-429500-00 STD
08-429507-00 0.50mm

1.20 NT¹
1.20 P
2.00 CR¹

¹ Steel ¹ Stahl ¹ Acier ¹ Acero ¹ Acciaio

73.40 **10**

A 14 XER	4cyl.	1398cc	74kW (101PS)	Petrol	TD24542
ADAM 1.4			10/12→02/19	CORSA Mk III 1.4	01/10→08/14
ASTRA Mk VI 1.4			12/09→10/15	MERIVA Mk II 1.4	06/10→
ASTRA Mk VI GTC 1.4			10/11→10/15		

87-429500-30 STD
87-429507-30 0.50mm

A 25.80
B- 1.60
C 1.90
C 3.83
D 46.80
 18x53



08-429500-00 STD
08-429507-00 0.50mm

1.20 NT¹
1.20 P
2.00 CR¹

¹ Steel ¹ Stahl ¹ Acier ¹ Acero ¹ Acciaio

73.40 **11**

B 14 XEL	4cyl.	1398cc	64-66kW (87-90PS)	Petrol	TD29771
Z 14 XEP (Ecotec)	4cyl.	1364cc	66kW (90PS)	Petrol	TD18228
ADAM 1.4			10/12→02/19	CORSA Mk III 1.4	08/06→08/14
ASTRA Mk V 1.4			01/04→05/09	CORSA Mk III 1.4 LPG	07/06→08/14
ASTRA Mk V 1.4 i 16V			03/05→11/10	CORSA Mk IV 1.4	08/14→
ASTRAVAN Mk V 1.4 i			03/05→	CORSAVAN Mk II 1.4	11/03→06/06
COMBO Mk II Body/MPV 1.4 i 16V			01/04→11/11	MERIVA A 1.4 16V	01/03→06/10
COMBO TOUR Mk II 1.4			10/04→09/10	TIGRA 1.4	06/04→08/09
CORSA Mk II 1.4			06/03→10/06		

87-429500-00 STD ¹
87-429507-00 0.50mm ¹

A 23.00
B- 1.25
BØ 53.50
C 1.33
C 1.35
D 44.00
 18x49



08-429500-00 STD
08-429507-00 0.50mm

1.20 NT²
1.20 P
2.00 CR²

¹ Elastoal® ² Steel ² Stahl ² Acier ² Acero ² Acciaio

73.40 **12**

Z 12 XEP	4cyl.	1229cc	59kW (80PS)	Petrol	TD19350
-----------------	-------	---------------	--------------------	---------------	----------------





AGILA Mk I 1.2 16V	07/04→11/06	CORSA Mk III 1.2 LPG	09/09→08/14
CORSA Mk II 1.2	07/04→10/06	CORSAVAN Mk II 1.2 16V	07/04→11/06
CORSA Mk III 1.2	08/06→08/14	CORSAVAN Mk III 1.2	07/09→

87-429500-10 STD 1
 87-429507-10 0.50mm 1

08-429500-00 STD
 08-429507-00 0.50mm

A 24.00
 B+ 0.53
 C 1.46
 C 1.49
 D 45.33
 19x50
 TP



1.20 NT 2
 1.20 P
 2.00 CR 2



1 Elastoval ®
 2 Steel

2 Stahl

2 Acier

2 Acero

2 Acciaio

74.00

13

B 10 XFL (Euro 6)	3cyl.	999cc	66-77kW (90-105PS)	Petrol	Turbo Intercooled	TD29774
B 10 XFT (Euro 6)	3cyl.	998cc	85kW (116PS)	Petrol	Turbo Intercooled	TD29587
D 10 XFL (Euro 6)	3cyl.	999cc	66-77kW (90-105PS)	Petrol	Turbo Intercooled	TD35615
F 10 XFL (Euro 6)	3cyl.	999cc	66kW (90PS)	Petrol	Turbo Intercooled	TD35617

ADAM 1.0	07/14→11/18	CORSA Mk IV 1.0	08/14→
ASTRA Mk VII 1.0	07/15→		

87-453200-00 STD
 87-453207-00 0.50mm
 07/14→

08-453200-00 STD
 08-453207-00 STD

A 27.50
 B- 2.50
 C 1.68
 C 2.81
 D 46.00
 19x47
 HA TP



1.20 PVD 1
 1.20 P
 2.00 NT 1



1 Steel

1 Stahl

1 Acier

1 Acero

1 Acciaio

75.00

14

13 S	4cyl.	1297cc	42-55kW (57-75PS)	Petrol		TD17561
13 SB	4cyl.	1297cc	51kW (69PS)	Petrol		TD17600
C 13 N	4cyl.	1297cc	44kW (60PS)	Petrol		TD18673

ASTRA 1.3 S	09/79→08/84	CAVALIER Mk II 1.3 S	09/81→08/88
ASTRA Mk II 1.3	09/84→08/91	CHEVETTE 1300	09/74→12/85
ASTRAMAX 1.3 S	08/85→12/89	NOVA 1.3 S	09/82→10/89

87-306307-00 0.50mm 1
 87-306311-00 1.00mm

08-306300-00 STD
 08-306307-00 0.50mm
 08-306311-00 1.00mm

A 35.80
 B- 3.60
 C 5.30
 C 5.30
 D 62.40
 20x65



1.50 CR P
 1.50 P
 4.00 CR P



1 Pistons to be replaced in Engine Sets only

1 Kolben nur in Motorsätzen zu ersetzen

1 Piston à remplacer dans jeu moteur

1 Pistones de repuesto para juegos de motores solamente

1 Il pistone può essere rimpiazzato solamente completo



75.00 **15**

B 16 DT (DV6FD)	4cyl.	1560cc	73kW (99PS)	Diesel	Turbo Intercooled	TD34733
B 16 DTH (DV6FC)	4cyl.	1560cc	85-88kW (116-120PS)	Diesel	Turbo Intercooled	TD34734
COMBO Mk IV Body/MPV 1.6 D			06/18→	GRANDLAND X / GRANDLAND 1.6 Turbo D		06/17→
CROSSLAND X / CROSSLAND 1.6 Turbo D			03/17→			

87-453100-00 STD
87-453107-00 0.50mm

08-453100-00 STD
08-453107-00 0.50mm

A 41.70
B- 13.15
BØ 45.50
D 63.70



2.00 CK
1.95 P
2.00 CR



AK KK RT TP



77.60 **16**

14 NV	4cyl.	1389cc	53-55kW (72-75PS)	Petrol	TD17562
C 14 NZ	4cyl.	1389cc	44kW (60PS)	Petrol	TD17581
X 14 NZ	4cyl.	1389cc	44kW (60PS)	Petrol	TD39495
X 14 SZ	4cyl.	1389cc	40-44kW (54-60PS)	Petrol	TD17621

ASTRA Mk II 1.4 i	01/90→12/91	COMBO Mk I 1.4	07/94→10/01
ASTRA Mk II 1.4 S	01/89→09/93	CORSA Mk I 1.4 i	03/93→09/00
ASTRA Mk III 1.4 i	09/91→09/98	CORSAVAN Mk I 1.4 i	01/94→09/00
ASTRA Mk III 1.4 S	09/91→02/98	NOVA 1.4	10/90→08/92
ASTRAMAX 1.4 i	08/91→07/94	NOVA 1.4 i	01/90→03/93
ASTRAMAX 1.4 S	07/89→08/91	NOVA 1.4 S	01/90→03/93
ASTRAVAN Mk III 1.4 i	09/91→08/95	NOVAVAN 1.4	11/90→03/93
CAVALIER Mk III 1.4 S	09/88→11/95		

87-307100-20 STD
87-307107-20 0.50mm

08-307100-00 STD
08-307107-00 0.50mm

A 32.10
B- 3.40
D 52.50
18x55



1.50 CR P
1.50 P
3.00 CR



Steel Stahl Acier Acero Acciaio

77.60 **17**

Z 14 XE (Ecotec)	4cyl.	1389cc	66kW (90PS)	Petrol	TD17631
ASTRA Mk IV 1.4 16V			02/98→05/05	COMBO Mk II Body/MPV 1.4 16V	10/01→05/07
ASTRAVAN Mk IV 1.4 16V			09/00→05/05	CORSA Mk II 1.4 16V	09/00→10/06

87-144200-00 STD
87-144207-00 0.50mm

08-144200-00 STD
08-144207-00 0.50mm

A 31.30
B+ 2.45
D 55.75
18x55



1.20 NT
1.50 P
2.00 CR



Steel Stahl Acier Acero Acciaio



79.00

18

16 SV	4cyl.	1598cc	60kW (82PS)	Petrol	TD17565
C 16 SE	4cyl.	1598cc	74kW (101PS)	Petrol	TD17608
E 16 SE	4cyl.	1598cc	60-74kW (81-101PS)	Petrol	TD17586

ASTRA Mk II 1.6	09/84→08/91	ASTRAMAX 1.6	09/85→12/91
ASTRA Mk II 1.6 i	01/87→12/91	CAVALIER Mk III 1.6	09/88→05/93
ASTRA Mk II 1.6 S	01/89→12/91	NOVA 1.6 GSI	05/88→03/92
ASTRA Mk III 1.6 i	03/92→02/98	NOVA 1.6 GSI Cat	02/92→03/93
ASTRA Mk III 1.6 Si	03/91→12/94		

87-306900-10 STD
87-306907-10 0.50mm

A 28.00
B- 1.60
BØ 59.00
B+ 0.40
D 48.40
 18x55



08-306900-00 STD
08-306907-00 0.50mm

1.20 CR
1.50 P
3.00 CR

Steel

Stahl

Acier

Acero

Acciaio

79.00

19

A 16 LET (Euro 5)	4cyl.	1598cc	132kW (180PS)	Petrol	Turbo Intercooled	TD22590
Z 16 LET	4cyl.	1598cc	132kW (180PS)	Petrol	Turbo Intercooled	TD19347

ASTRA Mk V 1.6	08/04→11/10	ASTRA Mk VI GTC 1.6	10/11→10/15
ASTRA Mk V 1.6 Turbo	09/06→09/09	INSIGNIA Mk I 1.6 Turbo	01/09→05/17
ASTRA Mk VI 1.6 Turbo	12/09→10/15	MERIVA A 1.6 Turbo	05/06→06/10

87-435500-00 STD
87-435507-00 0.50mm

A 27.50
B+ 0.60
D 45.10
 19x53

HA TP



08-435500-00 STD
08-435507-00 0.50mm

1.20 NT
1.20 P
2.00 NT

Steel

Stahl

Acier

Acero

Acciaio

79.00

20

A 16 XER (Euro 5)	4cyl.	1598cc	85kW (116PS)	Petrol	TD22588
Z 16 XER	4cyl.	1598cc	85kW (116PS)	Petrol	TD21873

ASTRA Mk V 1.6	01/04→03/11	INSIGNIA Mk I 1.6	07/08→07/12
ASTRA Mk V 1.6 i 16V	10/06→08/11	MOKKA / MOKKA X 1.6	06/12→
ASTRA Mk VI 1.6	12/09→10/15	ZAFIRA Mk II 1.6	12/07→11/14

87-435300-00 STD
87-435307-00 0.50mm

A 26.70
BØ 52.96
B+ 1.20
C 1.90
C 2.70
D 49.90
 19x46



08-435300-00 STD
08-435307-00 0.50mm

1.20 NT
1.20 P
2.00 NT

Steel

Stahl

Acier

Acero

Acciaio



79.00					21
C 16 NZ	4cyl.	1598cc	55-61kW (75-83PS)	Petrol	TD17583
E 16 NZ	4cyl.	1598cc	55-61kW (75-83PS)	Petrol	TD17618
X 16 SZ	4cyl.	1598cc	52kW (71PS)	Petrol	TD17622
ASTRA Mk III 1.6 i			09/91→12/98	CAVALIER Mk II 1.6 i	08/86→08/88
ASTRAMAX 1.6			12/86→12/92	CAVALIER Mk II 1.6 i Cat	08/86→08/88
ASTRAMAX 1.6 i			08/91→10/94	CAVALIER Mk III 1.6 i	09/88→11/95
ASTRAVAN Mk III 1.6 i			10/91→08/98		

87-306900-00 STD
87-306907-00 0.50mm

A 28.00
B- 2.70
BØ 63.00
B+ 0.40
D 48.40
18x55

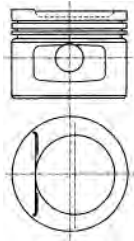

08-306900-00 STD
08-306907-00 0.50mm

1.20 CR 1
1.50 P
3.00 CR 1



Steel Stahl Acier Acero Acciaio

79.00					22
C 16 XE (Ecotec)	4cyl.	1598cc	78-80kW (106-109PS)	Petrol	TD17609
X 16 XE (Ecotec)	4cyl.	1598cc	78-80kW (106-109PS)	Petrol	TD17624
X 16 XEL (Ecotec)	4cyl.	1598cc	74kW (101PS)	Petrol	TD17590
ASTRA Mk III 1.6 i 16V			01/94→09/98	TIGRA Mk I 1.6 16V	07/94→12/00
ASTRA Mk IV 1.6			09/99→08/04	VECTRA 1.6 i 16V	08/95→10/01
ASTRA Mk IV 1.6 16V			02/98→05/05	ZAFIRA A 1.6	11/98→08/05
CORSA Mk I 1.6 GSI 16V			03/93→09/00	ZAFIRA A 1.6 16V	04/99→08/05
CORSA Mk I 1.6 i 16V			09/94→09/00		

87-307800-10 STD
87-307807-10 0.50mm

A 28.00
B- 0.80
BØ 60.20
C 1.90
C 2.15
D 48.00
18x55



08-307800-00 STD
08-307807-00 0.50mm
08-307811-00 1.00mm

1.20 CR 1
1.50 P
2.50 CR 1



Steel Stahl Acier Acero Acciaio

79.00					23
X 16 SZR	4cyl.	1598cc	55kW (75PS)	Petrol	TD17623
ASTRA Mk III 1.6 i			09/91→03/01	ASTRAVAN Mk IV 1.6 i	08/98→09/00
ASTRA Mk IV 1.6			02/98→04/04	VECTRA 1.6 i	08/95→10/01
ASTRAVAN Mk IV 1.6			02/98→12/00		

87-306907-20 0.50mm

A 28.45
B- 2.75
BØ 63.00
D 48.45
18x55



08-306900-00 STD
08-306907-00 0.50mm

1.20 CR 1
1.50 P
3.00 CR 1



Steel Stahl Acier Acero Acciaio



79.00

24

Y 16 XE (Ecotec)	4cyl.	1598cc	74kW (101PS)	Petrol	TD22874
Z 16 SE	4cyl.	1598cc	62-64kW (84-87PS)	Petrol	TD17632
Z 16 XE (Ecotec)	4cyl.	1598cc	63-74kW (85-101PS)	Petrol	TD17937

ASTRA Mk IV 1.6	03/98→05/05	COMBO TOUR Mk II 1.6	10/01→06/04
ASTRA Mk IV 1.6 16V	02/98→10/05	MERIVA A 1.6 i	01/03→06/10
ASTRAVAN Mk IV 1.6	07/00→08/05	MERIVA A 1.6 i 16V	01/03→09/05
ASTRAVAN Mk IV 1.6 i	09/00→08/06	VECTRA 1.6 i 16V	08/95→10/01
COMBO Mk II Body/MPV 1.6	09/01→11/11	ZAFIRA A 1.6 16V	04/99→08/05

87-125600-00 STD
87-125607-00 0.50mm

A 27.20
D 50.20
18x55



08-125600-00 STD
08-125607-00 0.50mm

1.20 NT 1
1.50 P
2.50 CR 1



1 Steel

1 Stahl

1 Acier

1 Acero

1 Acciaio

79.00

25

Z 16 XEP	4cyl.	1598cc	74-77kW (101-105PS)	Petrol	TD17939
ASTRA Mk IV 1.6	12/02→05/05	ASTRAVAN Mk V 1.6	03/05→		
ASTRA Mk IV 1.6 16V	03/00→10/05	MERIVA A 1.6 i 16V	05/03→06/10		
ASTRA Mk V 1.6	01/04→11/10	ZAFIRA Mk II 1.6	07/05→11/14		
ASTRAVAN Mk IV 1.6 16V	10/04→12/05				

87-427800-00 STD 1
87-427807-00 0.50mm 1

A 26.73
D 48.73
18x52



TP

08-427800-00 STD
08-427807-00 0.50mm

1.20 NT 2
1.20 P
2.00 CR 2



1 Elastoval®

2 Steel

2 Stahl

2 Acier

2 Acero

2 Acciaio

79.00

26

17 D (4EE1)	4cyl.	1686cc	44kW (60PS)	Diesel	TD22845
X 17 D (4EE1)	4cyl.	1686cc	44kW (60PS)	Diesel	TD22872
COMBO Mk I 1.7 D	07/94→10/01	CORSA Mk I 1.7 D	01/94→09/09		

87-307600-10 STD
→02/96, →Eng.179157

A 39.75
B- 1.30
C 0.25
D 69.80
27x64

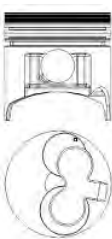

AK RT

08-307600-00 STD
08-307607-00 0.50mm

2.00 CR P
1.50 CR P
3.00 CR P





79.00						27
Y 17 DT	4cyl.	1686cc	55kW (75PS)	Diesel	Turbo Intercooled	TD18380
Y 17 DTL	4cyl.	1686cc	48kW (65PS)	Diesel	Turbo Intercooled	TD18381
ASTRA Mk IV 1.7 DTi 16V			02/00→05/05	CORSA Mk II 1.7 DI 16V		08/00→09/06
ASTRAVAN Mk IV 1.7 DTi 16V			04/01→08/06	CORSA Mk II 1.7 DTi 16V		08/00→09/06
COMBO Mk II Body/MPV 1.7 DI 16V			09/01→11/11	CORSAVAN Mk II 1.7 DI 16V		09/00→06/06
COMBO Mk II Body/MPV 1.7 DTi 16V			10/01→11/11	CORSAVAN Mk II 1.7 DTi 16V		09/00→06/06
COMBO TOUR Mk II 1.7 DI 16V			09/01→06/04	MERIVA A 1.7 DTi		06/03→06/10
COMBO TOUR Mk II 1.7 DTi 16V			10/01→02/12			

87-307600-40 STD
87-307607-40 0.50mm

A 39.75
B- 14.00
BØ 38.70
C 1.10
D 84.00
 27x64



RT

08-307600-00 STD
08-307607-00 0.50mm

2.00  CR P
 1.50  CR P
 3.00  CR P

79.70						28
B 16 DTH	4cyl.	1598cc	88-100kW (120-136PS)	Diesel	Turbo Intercooled	TD27816
D 16 DTH	4cyl.	1598cc	100kW (136PS)	Diesel	Turbo Intercooled	TD34984
D 16 DTN	4cyl.	1598cc	81kW (110PS)	Diesel	Turbo Intercooled	TD34989
ASTRA Mk VI 1.6 CDTi			11/13→10/15	INSIGNIA Mk II 1.6 D		03/17→
ASTRA Mk VI GTC 1.6 CDTi			07/14→10/15	MERIVA Mk II 1.6 CDTi		08/13→
ASTRA Mk VII 1.6 CDTi			07/15→	MOKKA / MOKKA X 1.6 CDTi		01/15→
INSIGNIA Mk I 1.6 CDTi			07/15→05/17	ZAFIRA Mk III 1.6 CDTi		03/13→08/18
INSIGNIA Mk I 1.6 CDTi			07/15→05/17			

87-430300-00 STD
87-430307-00 STD

A 45.80
B- 13.50
BØ 45.00
C 1.10
C 1.00
D 70.80
 29x63



AK KK RT TP

08-430300-00 STD
08-430307-00 0.50mm

1.50  CK
 1.50  P
 2.00  CR

80.00						29
16 D	4cyl.	1598cc	40kW (54PS)	Diesel		TD17563
16 DA	4cyl.	1598cc	40kW (54PS)	Diesel		TD17601
ASTRA 1.6 D			02/82→08/86	CAVALIER Mk II 1.6 D		03/82→08/88
ASTRA Mk II 1.6 D			09/84→08/91	CAVALIER Mk II 1600D		03/82→08/88
ASTRAMAX 1.6 D			05/86→06/90			

14-023520-00 D B 83.00 C 143.50 D 84.90 E 4.50

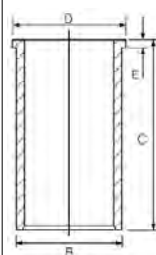



80.00

30

F8Q 606	4cyl.	1870cc	44kW (60PS)	Diesel	TD21358
----------------	-------	---------------	--------------------	---------------	----------------

ARENA 1.9 D 03/98→08/01

87-336500-00 STD
87-336507-00 0.50mm

08-336500-00 STD
08-336505-00 0.25mm
08-336507-00 0.50mm

A 42.35
B- 0.70
D 70.50
24x63



2.00 MO P
2.00 P
3.00 CR P

RT

80.00

31

F9Q 760	4cyl.	1870cc	74kW (101PS)	Diesel	Turbo Intercooled	TD19375
F9Q 762	4cyl.	1870cc	59-60kW (80-82PS)	Diesel	Turbo Intercooled	TD21148
F9Q 770	4cyl.	1870cc	59kW (80PS)	Diesel	Turbo Intercooled	TD19351
F9Q 772	4cyl.	1870cc	60kW (82PS)	Diesel	Turbo Intercooled	TD19363
F9Q 774	4cyl.	1870cc	60kW (82PS)	Diesel	Turbo Intercooled	TD19352

MOVANO Mk I 1.9 DTI 09/00→05/10
VIVARO A 1.9 DI 08/01→07/14

VIVARO A 1.9 DTI 08/01→12/06

87-101500-00 STD
87-101507-00 0.50mm

08-101500-00 STD
08-101507-00 0.50mm

14-020280-00 D B 83.00 C 155.00 D 85.00 E 5.00

A 47.06
B- 17.80
BØ 38.00
C 0.75
D 77.00
28x60



2.50 MO P
2.00 P
3.00 CR P

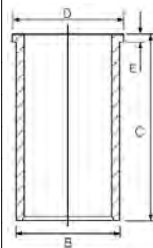

AK RT TP

80.00

32

R9M 408	4cyl.	1598cc	66-85kW (90-116PS)	Diesel	Turbo Intercooled	TD30950
R9M 413	4cyl.	1598cc	70-89kW (95-121PS)	Diesel	Turbo Intercooled	TD33688
R9M 450	4cyl.	1598cc	85-107kW (116-146PS)	Diesel	Turbo Intercooled	TD30951

VIVARO B 1.6 CDTi 05/14→

VIVARO B 1.6 CDTi

08/16→

87-424900-00 STD
87-424907-00 0.50mm

08-424900-00 STD
08-424907-00 0.50mm

A 46.00
B- 12.35
BØ 46.50
C 0.30
D 70.50
30x60



2.00 CK P
1.75 P
2.00 CR P

AK KK RT TP

80.50

33

X 18 XE1 (Ecotec)	4cyl.	1796cc	85kW (116PS)	Petrol	TD17626
Z 18 XE (Ecotec)	4cyl.	1796cc	87-92kW (118-125PS)	Petrol	TD17633
Z 18 XEL (Ecotec)	4cyl.	1796cc	81-85kW (110-116PS)	Petrol	TD17987

ASTRA Mk IV 1.8 16V 02/98→10/05

VECTRA 1.8

09/00→07/03



ASTRA Mk V 1.8	01/04→11/10	VECTRA 1.8 i 16V	10/95→07/03
CORSA Mk II 1.8 16V	08/00→09/06	VECTRA Mk II 1.8 16V	04/02→07/08
MERIVA A 1.8 i 16V	05/03→06/10	VECTRA Mk II GTS 1.8 16V	08/02→07/08
SIGNUM 1.8	06/03→07/05	ZAFIRA A 1.8	09/00→08/05
TIGRA 1.8	06/04→08/09	ZAFIRA A 1.8 16V	05/99→08/05

87-141200-00 STD
87-141207-00 0.50mm

A 24.10
D 44.70
18x55



08-141200-00 STD
08-141207-00 0.50mm

1.20 NT
1.20 P
2.00 CR



TP

Steel Stahl Acier Acero Acciaio

81.60				34	
C 18 XE	4cyl.	1799cc	92kW (125PS)	Petrol	TD17611
C 18 XEL	4cyl.	1799cc	85kW (116PS)	Petrol	TD17636
X 18 XE	4cyl.	1799cc	85kW (116PS)	Petrol	TD17625

ASTRA Mk III 1.8	09/94→08/96	ASTRA Mk III 1.8 i 16V	06/93→02/98
ASTRA Mk III 1.8 16V	11/94→03/01	VECTRA 1.8 i 16V	09/95→09/00

87-307700-10 STD
87-307707-10 0.50mm

A 30.40
B- 1.80
BØ 50.80
D 50.40
21x56



08-307700-00 STD
08-307707-00 0.50mm
08-307711-00 1.00mm

1.50 MO P
1.50 P
3.00 CR



Steel Stahl Acier Acero Acciaio

81.60				35	
C 25 XE	V6cyl.	2498cc	125kW (170PS)	Petrol	TD17635
X 25 XE	V6cyl.	2498cc	125-143kW (170-194PS)	Petrol	TD17634

CALIBRA 2.5 i V6	04/93→07/97	VECTRA 2.5 i GSi	03/98→07/00
CAVALIER Mk III 2.5 V6	08/88→06/94	VECTRA 2.5 i V6	09/95→08/00
OMEGA 2.5 V6	03/94→09/00		

87-307700-00 STD
87-307707-00 0.50mm

A 30.45
B+ 0.36
C 2.40
D 51.03
21x56



08-307700-00 STD
08-307707-00 0.50mm
08-307711-00 1.00mm

1.50 MO P
1.50 P
3.00 CR



Steel Stahl Acier Acero Acciaio

82.00				36	
Z 19 DT	4cyl.	1910cc	88kW (120PS)	Diesel Turbo Intercooled	TD18659





Z 19 DTL (Euro 4)	4cyl.	1910cc	74kW (100PS)	Diesel	Turbo Intercooled	TD20149
ASTRA Mk V 1.9 CDTi			08/04→11/10	VECTRA Mk II 1.9 CDTi		04/02→09/08
ASTRA Mk V 1.9 CDTi			01/04→05/09	VECTRA Mk II GTS 1.9 CDTi		08/02→07/08
ASTRAVAN Mk V 1.9 CDTi			03/05→11/11	ZAFIRA Mk II 1.9 CDTi		07/05→11/14
SIGNUM 1.9 CDTi			04/04→03/08			

87-124000-30 STD

87-124008-30 0.60mm

- A 46.50
- B- 17.45
- BØ 37.55
- C 0.65
- D 72.50
-  26x61

NB RT



08-124000-00 STD

08-124008-00 0.60mm

- 2.00  CK P
- 2.00  P
- 2.00  CR P

82.00

37

Z 19 DTH (Euro 4)	4cyl.	1910cc	110kW (150PS)	Diesel	Turbo Intercooled	TD18016
Z 19 DTJ	4cyl.	1910cc	88kW (120PS)	Diesel	Turbo Intercooled	TD18017
ASTRA Mk V 1.9 CDTi			08/04→11/10	SIGNUM 1.9 CDTi 16V		04/04→03/08
ASTRA Mk V 1.9 CDTi			01/04→05/09	VECTRA Mk II 1.9 CDTi 16V		04/04→05/09
ASTRA Mk V 1.9 CDTi 16V			01/04→05/09	VECTRA Mk II GTS 1.9 CDTi 16V		04/04→07/08
ASTRA Mk V 1.9 CDTi 16V			08/04→03/09	ZAFIRA Mk II 1.9 CDTi		07/05→11/14
ASTRAVAN Mk V 1.9 CDTi			03/05→11/11			

87-146100-00 STD

87-146108-00 0.60mm

- A 46.50
- B- 15.40
- BØ 41.50
- C 1.03
- D 72.50
-  26x61

(08256-102)

AK KK NB RT TP



08-146100-00 STD

08-146106-00 0.40mm

08-146108-00 0.60mm

- 2.00  CK P
- 2.00  P
- 2.00  CK P

87-146100-10 STD

87-146106-10 0.40mm

- A 46.50
- B- 15.40
- BØ 41.50
- C 1.07
- C 1.02
- D 72.50
-  30x67

(08269-503)

AK KK RT TP



08-146100-00 STD

08-146106-00 0.40mm

08-146108-00 0.60mm

- 2.00  CK P
- 2.00  P
- 2.00  CK P

83.00

38

A 20 DT (Euro 5)	4cyl.	1956cc	96kW (131PS)	Diesel	Turbo Intercooled	TD25781
A 20 DTC (Euro 5)	4cyl.	1956cc	81kW (110PS)	Diesel	Turbo Intercooled	TD22598
A 20 DTH (Euro 5)	4cyl.	1956cc	118-121kW (160-165PS)	Diesel	Turbo Intercooled	TD22603
A 20 DTJ (Euro 5)	4cyl.	1956cc	96kW (131PS)	Diesel	Turbo Intercooled	TD22600









A 20 DTL (Euro 5)	4cyl.	1956cc	81kW (110PS)	Diesel	Turbo Intercooled	TD25780
Y 20 DTJ	4cyl.	1956cc	96kW (131PS)	Diesel	Turbo Intercooled	TD27238
Z 20 DTJ	4cyl.	1956cc	96kW (131PS)	Diesel	Turbo Intercooled	TD25783
ASTRA Mk VI 2.0 CDTi			12/09→10/15	INSIGNIA Mk I 2.0 CDTi		07/08→05/17
ASTRA Mk VI GTC 2.0 CDTi			10/11→10/15	ZAFIRA Mk III 2.0 CDTi		10/11→08/18
CASCADA 2.0 CDTi			02/13→			

87-436500-00 STD
87-436506-00 0.40mm

A 46.63
B- 15.80
BØ 43.50
D 72.63
 30x66
 (08344A406)
AK KK RT TP



08-436500-00 STD
08-436506-00 0.40mm

1.50  GDC P
 1.50  P
 2.00  CR P
 

83.00

39

Z 20 DM	4cyl.	1991cc	93kW (126PS)	Diesel	Turbo Intercooled	TD24741
Z 20 DMH	4cyl.	1991cc	110kW (150PS)	Diesel	Turbo Intercooled	TD19219
ANTARA A 2.0 CDTi			08/06→04/15	ANTARA A 2.0 CDTi		08/06→04/15





87-879200-00 STD
87-879207-00 0.50mm

A 46.35
B- 13.95
BØ 46.70
D 72.35
 28x67
AK KK RT TP



08-879200-00 STD
08-879207-00 0.50mm

2.00  CR P
 2.00  P
 3.00  NT 

 Steel  Stahl  Acier  Acero  Acciaio

84.00

40

M9R 630	4cyl.	1995cc	66-84kW (90-114PS)	Diesel	Turbo Intercooled	TD25645
M9R 692 (Euro 5)	4cyl.	1995cc	66-84kW (90-114PS)	Diesel	Turbo Intercooled	TD32897
VIVARO A 2.0 CDTi			01/06→07/14			

87-422000-10 STD
87-422007-10 0.50mm

A 48.00
B- 14.00
BØ 50.00
D 76.00
 32x65
KK RT TP



08-422000-00 STD
08-422007-00 0.50mm

2.50  MOL P
 2.00  MOL P
 2.00  CR P





84.00

41





M9R 780 (Euro 4)	4cyl.	1995cc	66-84kW (90-114PS)	Diesel	Turbo Intercooled	TD20889
M9R 782	4cyl.	1995cc	66-84kW (90-114PS)	Diesel	Turbo Intercooled	TD21889
M9R 784	4cyl.	1995cc	84kW (114PS)	Diesel	Turbo Intercooled	TD21904
M9R 786 (Euro 4)	4cyl.	1995cc	66-84kW (90-114PS)	Diesel	Turbo Intercooled	TD25647









M9R 788	4cyl.	1995cc	84kW (114PS)	Diesel	Turbo Intercooled	TD25644
VIVARO A 2.0 CDTI		01/06→07/14				
87-422000-00 STD	08-422000-00 STD					
87-422007-00 0.50mm	08-422007-00 0.50mm					
<p>A 47.92</p> <p>B- 14.90</p> <p>BØ 49.07</p> <p>C 0.40</p> <p>C 0.40</p> <p>D 76.00</p>  32x65			<p>2.50</p>  MOL P	<p>2.00</p>  MOL P	<p>2.00</p>  CR P	
AK KK RT TP						

84.00 **42**

X 20 DTH	4cyl.	1995cc	74kW (101PS)	Diesel	Turbo Intercooled	TD17592
OMEGA 2.0 DTI 16V		01/98→09/00		VECTRA 2.0 DTI 16V		06/97→10/01
VECTRA 2.0 DTI 16V		08/95→10/01				
87-102900-10 STD	08-102900-00 STD					
	08-102907-00 0.50mm					
<p>A 45.80</p> <p>B- 14.61</p> <p>BØ 41.00</p> <p>D 70.80</p>  29x68			<p>2.50</p>  CK P	<p>1.75</p>  P	<p>3.00</p>  CR P	
AK RT TP						

84.00 **43**

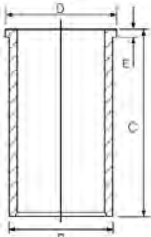
X 20 DTL	4cyl.	1995cc	60kW (82PS)	Diesel	Turbo Intercooled	TD17627
Y 20 DTL	4cyl.	1995cc	60kW (82PS)	Diesel	Turbo Intercooled	TD17926
ASTRA Mk IV 2.0 DI		02/98→05/05		VECTRA 2.0 DI 16V		08/95→10/01
ASTRAVAN Mk IV 2.0 DI		08/98→08/06		ZAFIRA A 2.0 DI 16V		10/99→08/05
VECTRA 2.0 Di 16V		08/95→10/01				
87-102800-10 STD	08-102800-00 STD					
87-102807-10 0.50mm	08-102807-00 0.50mm					
<p>A 45.80</p> <p>B- 14.84</p> <p>BØ 41.00</p> <p>C 1.00</p> <p>D 70.80</p>  29x68			<p>2.00</p>  CK P	<p>1.75</p>  P	<p>3.00</p>  CR P	<p>14-102800-00 D</p>  <p>B 87.00 C 160.00 D 90.00 E 4.50</p>
AK RT TP						

84.00 **44**

X 22 DTH	4cyl.	2171cc	85kW (116PS)	Diesel	Turbo Intercooled	TD17916
Y 22 DTH	4cyl.	2171cc	85-88kW (116-120PS)	Diesel	Turbo Intercooled	TD17928
Y 22 DTR	4cyl.	2172cc	92kW (125PS)	Diesel	Turbo Intercooled	TD17629
FRONTERA Mk II 2.2 DTI		10/98→10/04		VECTRA 2.2 DTI 16V		08/95→10/01
OMEGA 2.2 DTI 16V		08/00→07/03		VECTRA Mk II 2.2 DTI 16V		04/02→10/08
SIGNUM 2.2 DTI		05/03→05/08		VECTRA Mk II GTS 2.2 DTI 16V		08/02→07/08
SINTRA 2.2 DTI		07/97→04/99				





87-126000-10 STD
87-126007-10 0.50mm

A 45.80
B- 14.67
BØ 43.00
C 1.05
D 70.80
 29x68



AK KK RT TP

08-126000-00 STD
08-126007-00 0.50mm

1.75  CK P
1.75  P
3.00  CR P

84.00

45

Y 20 DTH	4cyl.	1995cc	74kW (101PS)	Diesel	Turbo Intercooled	TD17924
ASTRA Mk IV 2.0 DTI 16V			02/98→05/05	VECTRA 2.0 DTi 16V		06/97→10/01
ASTRAVAN Mk IV 2.0 DTI			04/04→08/06	VECTRA Mk II 2.0 DTI 16V		04/02→10/08
SIGNUM 2.0 DTI			05/03→04/04	VECTRA Mk II GTS 2.0 DTI 16V		08/02→07/08
VECTRA 2.0 DTI 16V			08/95→10/01	ZAFIRA A 2.0 DTI 16V		04/99→08/05

87-126000-00 STD
87-126007-00 0.50mm

A 45.85
B- 14.68
BØ 41.00
C 1.05
D 70.80
 29x68



AK KK RT TP

08-126000-00 STD
08-126007-00 0.50mm

1.75  CK P
1.75  P
3.00  CR P

84.80

46

18 SE	4cyl.	1796cc	82-85kW (112-116PS)	Petrol	TD17604
18 SEH	4cyl.	1796cc	85kW (115PS)	Petrol	TD17570
18 SV	4cyl.	1796cc	66kW (90PS)	Petrol	TD17571
ASTRA Mk II 1.8			01/86→12/90	CARLTON Mk III 1.8 S	09/86→03/94
ASTRA Mk II 1.8 GTE			09/84→08/91	CAVALIER Mk II 1.8 i	09/81→08/88
ASTRA Mk II 1.8 i			09/85→08/91	CAVALIER Mk II 1800i	03/85→10/88
ASTRA Mk III 1.8 i 16V			09/95→02/98	CAVALIER Mk III 1.8	09/88→08/95
CARLTON Mk III 1.8 i			09/86→03/94	CAVALIER Mk III 1.8 i Cat	03/90→11/95

87-307200-00 STD

A 33.65
B- 4.00
BØ 43.00
D 53.65
 21x62



08-307200-00 STD
08-307207-00 0.50mm

1.50  CR P
1.50  P
3.00  CR I

 Steel

 Stahl

 Acier

 Acero

 Acciaio

85.00

47

M9T 670 (Euro 5)	4cyl.	2298cc	74-92kW (101-125PS)	Diesel	Turbo Intercooled	TD24749
M9T 672 (Euro 5)	4cyl.	2298cc	74-92kW (101-125PS)	Diesel	Turbo Intercooled	TD25155
M9T 676 (Euro 4)	4cyl.	2298cc	74-92kW (101-125PS)	Diesel	Turbo Intercooled	TD24748
M9T 678	4cyl.	2298cc	107kW (146PS)	Diesel	Turbo Intercooled	TD25156
M9T 680	4cyl.	2298cc	92-107kW (125-146PS)	Diesel	Turbo Intercooled	TD25138





M9T 686 (Euro 5)	4cyl.	2298cc	92kW (125PS)	Diesel	Turbo Intercooled	TD25152
M9T 690 (Euro 5)	4cyl.	2298cc	74-92kW (101-125PS)	Diesel	Turbo Intercooled	TD25105
M9T 692 (Euro 4)	4cyl.	2298cc	74-92kW (101-125PS)	Diesel	Turbo Intercooled	TD25106
M9T 694 (Euro 4)	4cyl.	2298cc	107-110kW (146-150PS)	Diesel	Turbo Intercooled	TD24750
M9T 696 (Euro 4)	4cyl.	2298cc	92-107kW (125-146PS)	Diesel	Turbo Intercooled	TD25149
M9T 698 (Euro 5)	4cyl.	2298cc	92-107kW (125-146PS)	Diesel	Turbo Intercooled	TD24751
M9T 702	4cyl.	2298cc	100-120kW (136-163PS)	Diesel	Bi-Turbo Intercooled	TD29895
M9T 870	4cyl.	2298cc	74-81kW (100-110PS)	Diesel	Turbo Intercooled	TD29897
M9T 876	4cyl.	2299cc	92kW (125PS)	Diesel	Turbo Intercooled	TD31131
M9T 880	4cyl.	2298cc	107-110kW (145-150PS)	Diesel	Turbo Intercooled	TD31642
M9T 898	4cyl.	2298cc	92-110kW (125-150PS)	Diesel	Turbo Intercooled	TD34462

MOVANO Mk II 2.3 CDTI	05/10→	MOVANO Mk II VAN 2.3 CDTI	05/10→
MOVANO Mk II 2.3 CDTI RWD	05/10→	MOVANO Mk II VAN 2.3 CDTI RWD	05/10→

87-435200-00 STD
87-435207-00 0.50mm

A 48.00
B- 16.20
BØ 50.00
C 0.45
D 76.00
 32x65



AK KK RT TP

08-435200-00 STD
08-435207-00 0.50mm

2.50 GDC P
 2.00 MO P
 2.00 CR P



86.00

48

20 NE	4cyl.	1998cc	85kW (116PS)	Petrol	TD17637
C 20 NE	4cyl.	1998cc	85kW (115PS)	Petrol	TD17584

ASTRA Mk II 2.0	09/86→08/91	CAVALIER Mk II 2.0 i	09/86→08/88
ASTRA Mk II 2.0 i	01/87→12/91	CAVALIER Mk II 2.0 i Cat	09/86→08/88
ASTRA Mk II 2.0 i Cat	01/91→08/93	CAVALIER Mk III 2.0 i	09/88→10/92
ASTRA Mk III 2.0 i	09/91→09/98	CAVALIER Mk III 2.0 i Cat	09/88→11/95
CALIBRA 2.0 i	06/90→07/97	FRONTERA Mk I 2.0	04/95→08/98
CARLTON Mk III 2.0	09/86→03/94	FRONTERA Mk I 2.0 i	03/92→10/98

87-306800-30 STD

A 30.40
B- 5.00
BØ 57.00
D 50.40
 21x62



TP

08-306800-00 STD
08-306807-00 0.50mm
08-306811-00 1.00mm

1.50 CR P
 1.50 P
 3.00 CR T

Steel

Stahl

Acier

Acero

Acciaio

86.00

49

20 XE	4cyl.	1998cc	115kW (156PS)	Petrol	TD17605
C 20 XE	4cyl.	1998cc	110kW (150PS)	Petrol	TD17585

ASTRA Mk II 1.9	03/88→08/91	CALIBRA 2.0 i 16V	06/90→02/94
ASTRA Mk II 2.0 GTE 16V	05/88→08/91	CAVALIER Mk III 2.0 GSi	09/89→08/92
ASTRA Mk III 2.0 i 16V	09/91→02/98	CAVALIER Mk III 2.0 i 16V	09/88→11/95





87-306800-10 STD
87-306807-10 0.50mm

A 30.43
B- 0.85
BØ 70.00
C 2.20
D 55.43
 21x62



08-306800-00 STD
08-306807-00 0.50mm
08-306811-00 1.00mm

1.50 CR P
 1.50 P
 3.00 CR

Steel

Stahl

Acier

Acero

Acciaio

86.00

50

Z 22 SE (Ecotec) 4cyl. **2198cc** **106-108kW** (144-147PS) **Petrol** **TD17683**

ASTRA Mk IV 2.2 16V	03/00→10/05	VECTRA Mk II GTS 2.2 16V	08/02→07/08
VECTRA 2.2 i 16V	08/95→07/03	VX220 2.2 i	09/00→07/05
VECTRA Mk II 2.2 16V	01/02→10/08	ZAFIRA A 2.2 16V	11/98→08/04

14-020450-00 D **B** 89.02 **C** 137.25 **D** 95.45 **E** 4.63

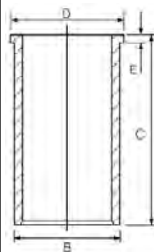

87.00

51

G9T 720 4cyl. **2188cc** **66kW** (90PS) **Diesel** **Turbo Intercooled** **TD19353**

G9T 722 4cyl. **2188cc** **66kW** (90PS) **Diesel** **Turbo Intercooled** **TD19356**

G9T 750 4cyl. **2188cc** **66kW** (90PS) **Diesel** **Turbo Intercooled** **TD19355**

MOVANO Mk I 2.2 DTI 09/00→05/10

87-127400-00 STD
87-127407-00 0.50mm

A 54.53
B- 17.50
BØ 40.40
C 2.00
D 84.20
 31x65



AK RT TP

08-127400-00 STD
08-127407-00 0.50mm

3.00 PS P
 1.75 P
 2.50 P

88.00

52

C 223 4cyl. **2238cc** **39-54kW** (53-73PS) **Diesel** **TD22879**

BRAVA 2.2 D 12/88→09/96





14-021190-00 D

B 92.13 C 163.50 D 95.00 E 4.00

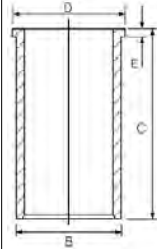

89.00

53

G9U 632 (Euro 4)	4cyl.	2464cc	88-107kW (120-146PS)	Diesel	Turbo Intercooled	TD24755
G9U 650 (Euro 4)	4cyl.	2464cc	74-107kW (101-146PS)	Diesel	Turbo Intercooled	TD24737
MOVANO Mk I 2.5 CDTI		10/01→12/10				

87-137500-30 STD
87-137507-30 0.50mm

08-137500-00 STD
08-137507-00 0.50mm

A 53.07
B- 16.10
B- 4.90
BØ 48.00
C 2.00
C 1.60
D 83.09
31x65



3.00 MO P
1.75 P
2.50 P



AK RT TP

89.00

54

G9U 720 (Euro 3)	4cyl.	2464cc	84-85kW (115-116PS)	Diesel	Turbo Intercooled	TD19358
G9U 724 (Euro 3)	4cyl.	2464cc	84kW (115PS)	Diesel	Turbo Intercooled	TD19368
G9U 730 (Euro 3)	4cyl.	2464cc	99kW (135PS)	Diesel	Turbo Intercooled	TD18701
G9U 750 (Euro 3)	4cyl.	2464cc	84kW (115PS)	Diesel	Turbo Intercooled	TD19365
G9U 754 (Euro 3)	4cyl.	2464cc	73-84kW (99-115PS)	Diesel	Turbo Intercooled	TD19369
MOVANO Mk I 2.5	11/03→12/06		VIVARO A 2.5 CDTI		04/03→07/06	
MOVANO Mk I 2.5 CDTI	11/03→12/06		VIVARO A 2.5 DTI		07/03→07/14	
MOVANO Mk I 2.5 DTI	01/01→05/10					

87-137500-10 STD
87-137507-10 0.50mm

08-137500-10 STD
08-137507-10 0.50mm

A 53.03
B- 17.85
BØ 43.20
C 1.65
C 1.90
D 83.09
31x65



2.50 MO P
1.75 P
2.50 CR P



AK RT TP

92.00

55

23 D	4cyl.	2260cc	48-52kW (65-71PS)	Diesel		TD17575
23 DTR	4cyl.	2260cc	74kW (100PS)	Diesel	Turbo Intercooled	TD17576
23 TD	4cyl.	2260cc	63kW (86PS)	Diesel	Turbo	TD17577
23 YD	4cyl.	2260cc	54kW (73PS)	Diesel		TD17914





23 YDT	4cyl.	2260cc	66kW (90PS)	Diesel	Turbo Intercooled	TD17579
CARLTON Mk II 2.3 D			09/80→08/86	CARLTON Mk III 2.3 TD		08/88→03/94
CARLTON Mk II 2.3 TD			09/83→08/86	FRONTERA Mk I 2.3 TD		09/91→06/98
CARLTON Mk III 2.3 D			09/86→03/94	SENATOR 2.2 TD		11/84→08/87

14-024100-00 D B 95.00 C 172.00 D 97.00 E 4.70

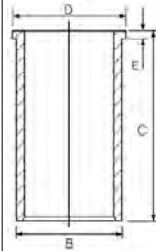

92.00 **56**

25TDS (VM41B)	4cyl.	2499cc	85kW (115PS)	Diesel	Turbo Intercooled	TD22850
FRONTERA Mk I 2.5 TDS			11/91→10/98			

15-676420-00 WH I B 101.50 C 166.80 D 110.00 E 8.90 F 1.20
14-676420-00 WH B 101.50 C 166.80 D 110.00 E 8.90 F 1.20

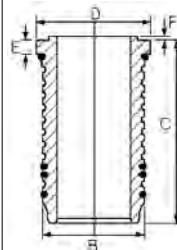

I Includes seals I Schließt Dichtungen ein I Inclut des joints I Incluye los sellos I Comprende le guarnizioni

93.00 **57**

S8U 758	4cyl.	2500cc	55-58kW (75-79PS)	Diesel		TD22883
S8U 780	4cyl.	2500cc	55kW (75PS)	Diesel		TD22884
S8U 782	4cyl.	2500cc	55kW (75PS)	Diesel		TD22885

ARENA 2.5 D			03/98→08/01			
-------------	--	--	-------------	--	--	--

14-022560-00 D B 96.00 C 167.30 D 98.90 E 5.00
14-028930-00 D B 97.50 C 167.00 D 100.90 E 5.00
14-028931-00 D B 97.58 C 167.00 D 100.90 E 5.00
14-028932-00 D B 97.70 C 167.00 D 100.90 E 5.00

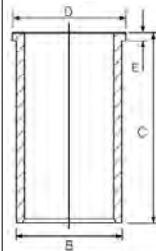

94.40 **58**

8140.23.2585/3700 (Sofim)	4cyl.	2800cc	84kW (114PS)	Diesel	Turbo Intercooled	MP9256-3
8140.43.2585/3700/3900 (Sofim)	4cyl.	2800cc	84kW (114PS)	Diesel	Turbo Intercooled	MP9256-2
S9W 700	4cyl.	2800cc	84kW (114PS)	Diesel	Turbo Intercooled	TD21150
S9W 702	4cyl.	2800cc	84kW (114PS)	Diesel	Turbo Intercooled	TD19361





MOVANO 2.8D	01/99→	MOVANO Mk I 2.8 TDI	10/98→10/01
MOVANO Mk I 2.8 DTI	10/98→10/01		

87-854700-00 STD
87-854708-00 0.60mm
 →Eng.2572279

A 58.75
B- 19.40
BØ 39.40
D 96.65
 32x78



AK KK RT

08-854700-00 STD
08-854708-00 0.60mm

3.00  CR
 2.00  P
 3.00  CR

14-021321-00 D **B** 97.54 **C** 167.00 **D** 100.90 **E** 5.00
14-028930-00 D **B** 97.50 **C** 167.00 **D** 100.90 **E** 5.00
14-028931-00 D **B** 97.58 **C** 167.00 **D** 100.90 **E** 5.00
14-028932-00 D **B** 97.70 **C** 167.00 **D** 100.90 **E** 5.00

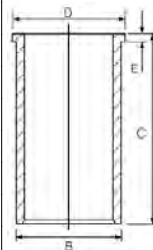

87-122200-10 STD
87-122208-10 0.60mm
 Eng.2572280→

A 58.75
B- 19.40
BØ 39.25
D 87.60
 32x72



AK KK RT TP

08-122200-00 STD
08-122208-00 0.60mm

2.50  CK P
 2.00  P
 2.50  CR P

ENGINE INDEX

Motorverzeichnis • Index de moteur • Índice de Motor
 Indeks silnika • Модель Двигателя • دليل المحرك



CCM

x



9

HR492HTI	Diesel	2500	4	92.00	2
R 425 DOHC	Diesel	2499	4	92.00	3
RA 630 DOHC (Euro 5)	Diesel	2987	V6	83.00	1
VM 392 HT	Diesel	1779	3	92.00	2
VM 492 HR	Diesel	2499	4	92.00	2
VM 492 HS	Diesel	2500	4	92.00	2
VM 492 HT	Diesel	2393	4	92.00	2



83.00 **1**

RA 630 DOHC (Euro 5) V6cyl. 2987cc 184kW (250PS) Diesel Turbo Intercooled TD20175

87-449900-00 STD

- A 46.63
- B- 15.80
- C 1.17
- C 1.22
- D 72.63

30.00x65.00

AK KK RT TP



08-449900-00 STD

- 2.00 GDC P
- 2.00 P
- 2.00 CK P



92.00 **2**

HR492HTI	4cyl.	2500cc	85kW (116PS)	Diesel	Turbo	MP4053
VM 392 HT	3cyl.	1779cc		Diesel	Turbo	MP4049
VM 492 HR	4cyl.	2499cc		Diesel	Turbo	MP9171-2
VM 492 HS	4cyl.	2500cc		Diesel	Turbo	MP9171-1
VM 492 HT	4cyl.	2393cc		Diesel	Turbo	MP4047

INDUSTRIAL

15-676420-00 WH B 101.50 C 166.80 D 110.00 E 8.90 F 1.20
 14-676420-00 WH B 101.50 C 166.80 D 110.00 E 8.90 F 1.20

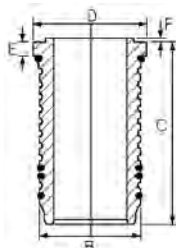

Includes seals

Schließt Dichtungen ein

Inclut des joints

Incluye los sellos

Comprende le guarnizioni

92.00 **3**

R 425 DOHC 4cyl. 2499cc 105-125kW (143-170PS) Diesel Turbo Intercooled TD18633

87-429200-00 STD

- A 55.00
- B- 18.00
- BØ 44.00
- D 83.00

32x68

AK KK RT TP



08-429200-00 STD

- 2.50 GDC P
- 1.50 P
- 2.00 NT



ENGINE INDEX

Motorverzeichnis • Index de moteur • Índice de Motor
 Indeks silnika • Модель Двигателя • دليل المحرك



CCM

x



9

B 10	Petrol	1108	4	70.00	1
B 10 E	Petrol	1108	4	70.00	1
B 14 OE	Petrol	1397	4	76.00	4
B 14.3 E	Petrol	1397	4	76.00	4
B 14.4 S	Petrol	1397	4	76.00	4
B 4164 T (Euro 5)	Petrol	1596	4	79.00	9
B 4164 T2 (Euro 5)	Petrol	1596	4	79.00	9
B 4164 T3 (Euro 5)	Petrol	1596	4	79.00	9
B 4164 T4 (Euro 5)	Petrol	1596	4	79.00	9
B 4204 S3	Petrol	1999	4	87.50	12
D6A180 (Euro 3)	Diesel	5480	6	98.43	14
D6A210 (Euro 3)	Diesel	5480	6	98.43	14
D6A230 (Euro 3)	Diesel	5480	6	98.43	14
D6A250 (Euro 3)	Diesel	5480	6	98.43	14
D6B (Euro 3)	Diesel	5480	6	98.43	14
D7C215 (Euro 2)	Diesel	7300	6	107.00	22
D7C250 (Euro 2)	Diesel	7300	6	107.00	22
D7C275 (Euro 2)	Diesel	7300	6	107.00	22
D7C290 (Euro 2)	Diesel	7300	6	107.00	22
D7C310 (Euro 2)	Diesel	7300	6	107.00	22
D7D EAE2 (Euro 2)	Diesel	7146	6	108.00	23
D7D ECE2 (Euro 2)	Diesel	7146	6	108.00	23
D7D EEE2 (Euro 2)	Diesel	7146	6	108.00	23
D7D LAE2 (Euro 2)	Diesel	7146	6	108.00	23
D7D LBE2 (Euro 2)	Diesel	7146	6	108.00	23
D7E240 (Euro 4)	Diesel	7146	6	108.00	24
D7E280 (Euro 4/5)	Diesel	7146	6	108.00	24
D7E290 (Euro 4)	Diesel	7146	6	108.00	24
D7E320 (Euro 4/5)	Diesel	7146	6	108.00	24
D7F240 (Euro 5)	Diesel	7146	6	108.00	24
D7F260 (Euro 5)	Diesel	7146	6	108.00	24
D7F290 (Euro 5)	Diesel	7100	6	108.00	24
D7F300 (Euro 5)	Diesel	7100	6	108.00	24
D7F340 (Euro 5)	Diesel	7100	6	108.00	24
D9A260 (Euro 3)	Diesel	9364	6	120.00	25
D9A300 (Euro 3)	Diesel	9364	6	120.00	25
D9A340 (Euro 3)	Diesel	9364	6	120.00	25
D9A380 (Euro 3)	Diesel	9364	6	120.00	25
D9B260 (Euro 4/5)	Diesel	9364	6	120.00	26
D9B300 (Euro 4)	Diesel	9364	6	120.00	26
D9B310 (Euro 4/5)	Diesel	9364	6	120.00	26
D9B340 (Euro 4)	Diesel	9364	6	120.00	26
D9B360 (Euro 4/5)	Diesel	9364	6	120.00	26
D9B380 (Euro 4)	Diesel	9364	6	120.00	26
D10A320	Diesel	9600	6	120.65	28
D10A360	Diesel	9600	6	120.65	28
D10B320 (Euro 2)	Diesel	9600	6	120.65	28
D10B360 (Euro 2)	Diesel	9600	6	120.65	28
D11A430 (Euro 3)	Diesel	10840	6	123.00	39
D11B430 (Euro 4/5)	Diesel	10840	6	123.00	39
D11C330 (Euro 5)	Diesel	10840	6	123.00	39
D11C370 (Euro 5)	Diesel	10840	6	123.00	39
D11C410 (Euro 5)	Diesel	10840	6	123.00	39
D12 (Euro 2)	Diesel	12100	6	131.00	44
D12A340 (Euro 2)	Diesel	12100	6	131.00	45
D12A380 (Euro 2)	Diesel	12100	6	131.00	46
D12A420 (Euro 2)	Diesel	12100	6	131.00	47
D12C340 (Euro 2)	Diesel	12100	6	131.00	48
D12C380	Diesel	12100	6	131.00	48
D12C420	Diesel	12100	6	131.00	49



CCM

x



9

D12C460	Diesel	12100	6	131.00	49
D12D340 (Euro 3)	Diesel	12100	6	131.00	48
D12D380 (Euro 3)	Diesel	12100	6	131.00	49
D12D420 (Euro 3)	Diesel	12100	6	131.00	49
D12D460 (Euro 3)	Diesel	12100	6	131.00	49
D12D500 (Euro 3)	Diesel	12100	6	131.00	49
D12F390 (Euro 4)	Diesel	12100	6	131.00	50
D12F430 (Euro 4)	Diesel	12100	6	131.00	50
D13A360 (Euro 5)	Diesel	12800	6	131.00	51
D13A400 (Euro 5)	Diesel	12800	6	131.00	51
D13A440 (Euro 5)	Diesel	12800	6	131.00	51
D13A480 (Euro 5)	Diesel	12800	6	131.00	51
D13A520 (Euro 5)	Diesel	12800	6	131.00	51
D13C380 (Euro 5)	Diesel	12800	6	131.00	52
D13C420 (Euro 5)	Diesel	12800	6	131.00	52
D13C460 (Euro 5)	Diesel	12800	6	131.00	52
D13C500 (Euro 5)	Diesel	12800	6	131.00	52
D13C540 (Euro 5)	Diesel	12800	6	131.00	52
D13H440 (Euro 5)	Diesel	12800	6	131.00	53
D 16	Diesel	1596	4	78.00	8
D16A	Diesel	16120	6	144.00	57
D16A470 (Euro 2)	Diesel	16120	6	144.00	57
D16A520	Diesel	16120	6	144.00	57
D16B520	Diesel	16120	6	144.00	57
D 20	Diesel	1986	5	76.50	5
D 24	Diesel	2383	6	76.50	6
D 24 T	Diesel	2383	6	76.50	7
D 24 TIC	Diesel	2383	6	76.50	7
D39 (4.236)	Diesel	3866	4	98.48	17
D60A	Diesel	5480	6	98.43	13
D70B	Diesel	6730	6	104.775	18
D100A	Diesel	9600	6	120.65	27
D100B	Diesel	9600	6	120.65	27
D100BHC	Diesel	9600	6	120.65	27
D100BRC	Diesel	9600	6	120.65	27
D 4162 T	Diesel	1560	4	75.00	2
D 4164 T	Diesel	1560	4	75.00	3
D 4192 T3	Diesel	1870	4	80.00	10
D 4192 T4	Diesel	1870	4	80.00	10
D 4204 T	Diesel	1997	4	85.00	11
DH10A (Euro 2)	Diesel	9600	6	120.65	28
DH10A245 (Euro 2)	Diesel	9600	6	120.65	28
DH10A285 (Euro 2)	Diesel	9600	6	120.65	28
DH10A360 (Euro 2)	Diesel	9600	6	120.65	28
DH12D340 (Euro 3)	Diesel	12100	6	131.00	48
DH12D380 (Euro 3)	Diesel	12100	6	131.00	54
DH12D420 (Euro 3)	Diesel	12100	6	131.00	55
DH12E340	Diesel	12100	6	131.00	56
DH12E380 (Euro 4)	Diesel	12100	6	131.00	56
DH12E420 (Euro 4/5)	Diesel	12100	6	131.00	56
DH12E460 (Euro 4)	Diesel	12100	6	131.00	56
HD100A	Diesel	9600	6	120.65	27
HD100D	Diesel	9600	6	120.65	27
MD70	Diesel	6730	6	104.775	18
MD100A	Diesel	9600	6	120.65	27
MD100B	Diesel	9600	6	120.65	27
TAD1630G	Diesel	16120	6	144.00	58
TAD1630GE	Diesel	16120	6	144.00	58
TAD1630P	Diesel	16120	6	144.00	58
TAD1631G	Diesel	16120	6	144.00	58

ENGINE INDEX

Motorverzeichnis • Index de moteur • Índice de Motor
 Indeks silnika • Модель Двигателя • دليل المحرك



CCM

x



9

TAMD60	Diesel	5480	6	98.43	13
TAMD70	Diesel	6730	6	104.775	18
TAMD120A	Diesel	11980	6	130.175	40
TAMD120B	Diesel	11980	6	130.175	40
TAMD121	Diesel	11980	6	130.175	40
TD60A	Diesel	5480	6	98.43	13
TD60B	Diesel	5480	6	98.43	15
TD60C	Diesel	5480	6	98.43	15
TD60D	Diesel	5480	6	98.43	15
TD60DG	Diesel	5480	6	98.43	15
TD61B	Diesel	5480	6	98.43	15
TD61F	Diesel	5480	6	98.43	15
TD61FB	Diesel	5480	6	98.43	15
TD61G	Diesel	5480	6	98.43	15
TD61GA	Diesel	5480	6	98.43	15
TD61GB	Diesel	5480	6	98.43	15
TD61GC	Diesel	5480	6	98.43	15
TD61GE	Diesel	5480	6	98.43	15
TD61GS	Diesel	5480	6	98.43	15
TD63E	Diesel	5480	6	98.43	16
TD63ES	Diesel	5480	6	98.43	16
TD70A	Diesel	6730	6	104.775	18
TD70B	Diesel	6730	6	104.775	18
TD70C	Diesel	6730	6	104.775	18
TD70E	Diesel	6730	6	104.775	18
TD70ES	Diesel	6730	6	104.775	18
TD70F	Diesel	6730	6	104.775	18
TD70FS	Diesel	6730	6	104.775	18
TD70G	Diesel	6730	6	104.775	18
TD70H	Diesel	6730	6	104.775	18
TD70HA	Diesel	6730	6	104.775	18
TD71A	Diesel	6730	6	104.775	19
TD71ACE	Diesel	6730	6	104.775	19
TD71AG	Diesel	6730	6	104.775	19
TD71AGP	Diesel	6730	6	104.775	19
TD71AP	Diesel	6730	6	104.775	19
TD71APB	Diesel	6730	6	104.775	19
TD71AW	Diesel	6730	6	104.775	19
TD71E	Diesel	6730	6	104.775	19
TD71F	Diesel	6730	6	104.775	19
TD71FA	Diesel	6730	6	104.775	20
TD71FC	Diesel	6730	6	104.775	20
TD71FD	Diesel	6730	6	104.775	19
TD71FQ	Diesel	6730	6	104.775	19
TD71FS	Diesel	6730	6	104.775	19
TD71FSQ	Diesel	6730	6	104.775	19
TD71G	Diesel	6730	6	104.775	19
TD73E (Euro 1)	Diesel	6730	6	104.775	21
TD73EA	Diesel	6730	6	104.775	21
TD73EB	Diesel	6730	6	104.775	21
TD73ES	Diesel	6730	6	104.775	21
TD100A	Diesel	9600	6	120.65	29
TD100AHC	Diesel	9600	6	120.65	29
TD100ARC	Diesel	9600	6	120.65	29
TD100B	Diesel	9600	6	120.65	30
TD100BG	Diesel	9600	6	120.65	30
TD100CHC	Diesel	9600	6	120.65	31
TD100F	Diesel	9600	6	120.65	31
TD100G	Diesel	9600	6	120.65	31
TD100GA	Diesel	9600	6	120.65	31



CCM

x



9

TD100GB	Diesel	9600	6	120.65	32
TD100GG	Diesel	9600	6	120.65	31
TD101	Diesel	9600	6	120.65	32
TD101F	Diesel	9600	6	120.65	31
TD101FA	Diesel	9600	6	120.65	31
TD101FC	Diesel	9600	6	120.65	31
TD101FD	Diesel	9600	6	120.65	31
TD101G	Diesel	9600	6	120.65	31
TD101GA	Diesel	9600	6	120.65	31
TD101GB	Diesel	9600	6	120.65	31
TD101GE	Diesel	9600	6	120.65	31
TD102F	Diesel	9600	6	120.65	33
TD102FAQ	Diesel	9600	6	120.65	28
TD102FBQ	Diesel	9600	6	120.65	34
TD102FCQ	Diesel	9600	6	120.65	28
TD102FD (Euro 1)	Diesel	9600	6	120.65	33
TD102FDQ	Diesel	9600	6	120.65	33
TD102FEQ	Diesel	9600	6	120.65	28
TD102FF	Diesel	9600	6	120.65	33
TD102FGQ	Diesel	9600	6	120.65	28
TD102FH	Diesel	9600	6	120.65	33
TD102FL (Euro 1)	Diesel	9600	6	120.65	28
TD102FM	Diesel	9600	6	120.65	28
TD102FQ	Diesel	9600	6	120.65	28
TD102FS	Diesel	9600	6	120.65	28
TD102FT	Diesel	9600	6	120.65	28
TD103D10 (Euro 2)	Diesel	9600	6	120.65	35
TD103E (Euro 1)	Diesel	9600	6	120.65	36
TD103EA (Euro 1)	Diesel	9600	6	120.65	36
TD103ES (Euro 1)	Diesel	9600	6	120.65	36
TD103KBE (Euro 1)	Diesel	9600	6	120.65	36
TD103KF (Euro 1)	Diesel	9600	6	120.65	36
TD120A	Diesel	11980	6	130.175	40
TD120C	Diesel	11980	6	130.175	40
TD120D	Diesel	11980	6	130.175	40
TD120E	Diesel	11980	6	130.175	40
TD120F	Diesel	11980	6	130.175	40
TD120FA	Diesel	11980	6	130.175	40
TD120FB	Diesel	11980	6	130.175	40
TD120FC	Diesel	11980	6	130.175	40
TD120FTQ	Diesel	11980	6	130.175	40
TD120G	Diesel	11980	6	130.175	40
TD120GA	Diesel	11980	6	130.175	40
TD120GG	Diesel	11980	6	130.175	40
TD121F	Diesel	11980	6	130.175	40
TD121FD	Diesel	11980	6	130.175	40
TD121FH	Diesel	11980	6	130.175	41
TD121FK	Diesel	11980	6	130.175	40
TD121G	Diesel	11980	6	130.175	40
TD121GD	Diesel	11980	6	130.175	40
TD122	Diesel	11980	6	130.175	42
TD122ED	Diesel	11980	6	130.175	40
TD122F	Diesel	11980	6	130.175	42
TD122FA	Diesel	11980	6	130.175	42
TD122FAQ	Diesel	11980	6	130.175	40
TD122FBQ	Diesel	11980	6	130.175	40
TD122FCQ	Diesel	11980	6	130.175	40
TD122FH (Euro 1)	Diesel	11980	6	130.175	40
TD122FK	Diesel	11980	6	130.175	42
TD122FL	Diesel	11980	6	130.175	40

ENGINE INDEX

Motorverzeichnis • Index de moteur • Índice de Motor
 Indeks silnika • Модель Двигателя • دليل المحرك



CCM

x



9

TD122FR	Diesel	11980	6	130.175	42
TD122FS	Diesel	11980	6	130.175	42
TD122KBE	Diesel	11980	6	130.175	40
TD122KE	Diesel	11980	6	130.175	42
TD163ES	Diesel	16120	6	144.00	59
THD100A	Diesel	9600	6	120.65	27
THD100B	Diesel	9600	6	120.65	29
THD100D	Diesel	9600	6	120.65	29
THD100DB	Diesel	9600	6	120.65	37
THD100DC	Diesel	9600	6	120.65	37
THD100DD	Diesel	9600	6	120.65	37
THD100E	Diesel	9600	6	120.65	37
THD100EA	Diesel	9600	6	120.65	37
THD100EB	Diesel	9600	6	120.65	37
THD100EC	Diesel	9600	6	120.65	37
THD100ED	Diesel	9600	6	120.65	37
THD100EE	Diesel	9600	6	120.65	37
THD100EK	Diesel	9600	6	120.65	37
THD101	Diesel	9600	6	120.65	32
THD101B	Diesel	9600	6	120.65	29
THD101G	Diesel	9600	6	120.65	37
THD101GB	Diesel	9600	6	120.65	37
THD101GC	Diesel	9600	6	120.65	37
THD101GD	Diesel	9600	6	120.65	37
THD101KB	Diesel	9600	6	120.65	37
THD101KC	Diesel	9600	6	120.65	37
THD101KE	Diesel	9600	6	120.65	37
THD101KF	Diesel	9600	6	120.65	32
THD102KA	Diesel	9600	6	120.65	38
THD102KB (Euro 1)	Diesel	9600	6	120.65	38
THD102KD	Diesel	9600	6	120.65	28
THD102KF	Diesel	9600	6	120.65	38
THD102KJ	Diesel	9600	6	120.65	38
THD103KB	Diesel	9600	6	120.65	36
THD103KD	Diesel	9600	6	120.65	36
TID100	Diesel	9600	6	120.65	32
TID120F	Diesel	11980	6	130.175	40
TID121B	Diesel	11980	6	130.175	43
TID121KG	Diesel	11980	6	130.175	43
TID121KP	Diesel	11980	6	130.175	43
TID121LG	Diesel	11980	6	130.175	43
TID121LP	Diesel	11980	6	130.175	43
TID121P	Diesel	11980	6	130.175	43
TMD70	Diesel	6730	6	104.775	18
TMD100A	Diesel	9600	6	120.65	29
TMD102	Diesel	9599	6	120.65	27
TMD102A (Marine)	Diesel	9599	6	120.65	38
TMD102C (Marine)	Diesel	9599	6	120.65	38
TMD120A	Diesel	11980	6	130.175	40
TWD121G	Diesel	11980	6	130.175	43
TWD1630G	Diesel	16120	6	144.00	58
TWD1630P	Diesel	16120	6	144.00	58



70.00

1

B 10	4cyl.	1108cc	33kW (45PS)	Petrol	TD3980
B 10 E	4cyl.	1108cc	33-35kW (45-48PS)	Petrol	TD21325
66 DL 1.1 08/75→11/79					

A 40.00
D 68.00
 18x62

08-334600-00 STD

1.75 CR P
2.00 P
3.50 CR ②

WH ④ **B 75.50 C 135.00 D 85.70 E 94.80**

89-334600-00 ③

- ① Piston available in Kit Set only
- ② Steel
- ③ Includes seals
- ④ Liner available in Kit Set only
- ① Kolben nur im Assembly erhältlich
- ② Stahl
- ③ Schließdichtungen ein
- ④ Zylinderlaufbuchse nur in Assemblies verfügbar
- ① Piston disponible en kit seulement
- ② Acier
- ③ Inclut des joints
- ④ Chemise disponible en kit seulement
- ① Pistón disponible en conjuntos solamente.
- ② Acero
- ③ Incluye los sellos
- ④ Camisas disponible en conjuntos solamente.
- ① I pistoncini sono disponibili solo in kit motore
- ② Acciaio
- ③ Comprende le guarnizioni
- ④ Cilindro disponibile solo in kit motore

75.00

2

D 4162 T	4cyl.	1560cc	84kW (114PS)	Diesel	Turbo Intercooled	TD23981
C30 D2			10/10→12/12	V40 1.6 D2/		09/13→12/15
S40 II D2			10/10→12/12	V40 D2		03/12→12/16
S60 II / D2			01/11→12/15	V50 D2		01/10→12/12
S80 II 1.6			06/11→01/14	V60 I 1.6		02/11→12/15
S80 II D2			01/14→12/16	V70 III 1.6 / D2		04/11→12/15

87-433600-00 STD
87-433607-00 0.50mm

A 41.75
B- 13.85
BØ 45.00
D 65.20
 26x61

AK KK RT TP

08-433600-00 STD
08-433607-00 0.50mm

2.50 CK P
1.95 P
2.00 CR P

14-020900-00 D **B 78.00 C 142.00 D 79.50 F 5.00**

75.00

3

D 4164 T	4cyl.	1560cc	80-81kW (109-110PS)	Diesel	Turbo Intercooled	TD20849
C30 1.6 D			10/06→12/12	V50 1.6 D		01/05→12/12
S40 II 1.6 D			01/05→12/12	V70 III 1.6 D		07/09→12/11
S80 II 1.6 D			01/10→12/11			

87-424000-00 STD
87-424008-00 0.60mm

A 41.70
B- 13.25
BØ 41.80
C 1.20
D 65.30
 26x61

AK KK RT TP

08-424000-00 STD
08-424007-00 0.50mm
08-424008-00 0.60mm

3.00 CK P
1.95 P
2.50 CR P

76.00

4

B 14.3 E	4cyl.	1397cc	46-53kW (63-72PS)	Petrol	TD3988
B 14.4 S	4cyl.	1397cc	50-53kW (68-72PS)	Petrol	TD5142
B 14 OE	4cyl.	1397cc	51kW (69PS)	Petrol	TD23445





340-360 1.4 08/75→12/88

87-333500-00 STD

A 37.50
D 64.00
20x67



08-333500-00 STD
08-333507-00 0.50mm

1.75 CR P
2.00 P
4.00 CR 1



1 Steel 1 Stahl 1 Acier 1 Acero 1 Acciaio

76.50 **5**

D 20 5cyl. **1986cc** **50kW** (68PS) **Diesel** **TD3983**

240 2.0 D 09/78→10/80

14-021571-00 D **B 79.56 C 142.00 D 82.50 E 4.50**
14-028360-00 D 1 **B 79.50 C 145.00 D 81.50 E 4.70**

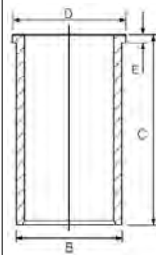

1 With recesses on crankshaft side 1 Mit kurbelwellenseitigen Ausparungen 1 Avec évidements côté vilebrequin 1 Con escotaduras en la cara del cigüeñal 1 Con nicchie sul lato albero motore

76.50 **6**

D 24 6cyl. **2383cc** **58-61kW** (79-83PS) **Diesel** **TD3984**

240 2.4 D	09/81→12/84	740 2.4 Diesel	08/84→07/92
240 2.4 Diesel	08/78→08/93	760 2.4 D	01/82→07/92
260 2.4 D	09/79→12/81	940 2.4 D	08/90→07/95

87-109500-00 STD 1
87-109505-00 0.25mm 1
87-109507-00 0.50mm 1 2
87-109511-00 1.00mm 1 2

A 41.70
B- 1.60
D 71.70
24x64
(07633)
RT



08-109500-00 STD
08-109505-00 0.25mm
08-109507-00 0.50mm
08-109511-00 1.00mm

1.75 CR P
2.00 P
3.00 CR P



14-021571-00 D **B 79.56 C 142.00 D 82.50 E 4.50**
14-028360-00 D 3 **B 79.50 C 145.00 D 81.50 E 4.70**

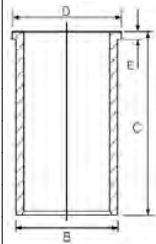

1 No oil-jet cut out 1 Ohne Ausparung für Kühliölspritzdüse 1 Sans encoche en bas de jupe pour le passage de la pissette d 'huile sous pression 1 Sin escotadura 1 Senza passaggio per spruzzatore olio

2 A = 41.450
3 With recesses on crankshaft side 3 Mit kurbelwellenseitigen Ausparungen 3 Avec évidements côté vilebrequin 3 Con escotaduras en la cara del cigüeñal 3 Con nicchie sul lato albero motore

76.50 **7**

D 24 T 6cyl. **2383cc** **79-83kW** (107-113PS) **Diesel Turbo** **TD3985**

D 24 TIC 6cyl. **2383cc** **85-95kW** (115-130PS) **Diesel Turbo Intercooled** **TD3986**

740 2.4 TD	08/84→12/90	940 2.4 TD	05/91→03/95
740 2.4 Turbo-Diesel	09/85→07/92	940 2.4 TD Intercooler	08/90→12/94
760 2.4 D	09/82→12/85	940 2.4 Turbo Diesel	08/90→12/94





760 2.4 TD	04/83→07/92	940 II 2.4 TD	08/94→10/98
760 2.4 TDiC	09/87→08/90	960 2.4 TD	09/91→07/94
760 2.4 Turbo Diesel	08/82→07/92	960 2.4 Tdi	09/90→08/93
780 2.4 D	04/86→07/90		

87-109800-10 STD
87-109807-10 0.50mm ①
87-109811-10 1.00mm ①

A 41.70
B- 1.60
D 71.70
 24x64

AK HA RT TP



08-109800-00 STD
08-109807-00 0.50mm
08-109811-00 1.00mm

1.75  CR P
 2.00  CR P
 3.00  CR P

14-021571-00 D **B** 79.56 **C** 142.00 **D** 82.50 **E** 4.50
14-028360-00 D ② **B** 79.50 **C** 145.00 **D** 81.50 **E** 4.70

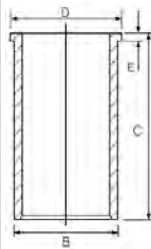

① A = 41.450
 ② With recesses on crankshaft side ② Mit kurbelwellenseitigen Aussparungen ② Avec évidements côté vilebrequin ② Con escotaduras en la cara del cigüeñal ② Con nicchie sul lato albero motore

78.00					8
D 16	4cyl.	1596cc	40kW (54PS)	Diesel	TD3981
340-360 1.6 Diesel		08/84→07/91			

14-023730-00 D **C** 149.00 **D** 83.50 **E** 4.50

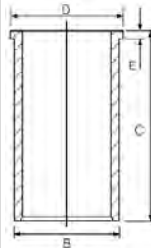

79.00					9
B 4164 T (Euro 5)	4cyl.	1596cc	132-147kW (180-200PS)	Petrol Turbo Intercooled	TD24673
B 4164 T2 (Euro 5)	4cyl.	1596cc	132kW (180PS)	Petrol Turbo Intercooled	TD26061
B 4164 T3 (Euro 5)	4cyl.	1596cc	110kW (150PS)	Petrol Turbo Intercooled	TD24674
B 4164 T4 (Euro 5)	4cyl.	1596cc	88kW (120PS)	Petrol Turbo Intercooled	TD27991

S60 II T3	04/10→12/15	V40 T4	04/14→12/15
S60 II T4	04/10→12/15	V40 T4 GTDi	03/12→12/16
S60 II T4F	04/11→12/15	V60 I T3	09/10→12/15
S80 II T4	10/10→04/14	V60 I T4	09/10→12/15
S80 II T4F	05/11→01/14	V60 I T4F	04/11→12/15
V40 T2 GTDi	04/13→12/16	V70 III T4	10/10→12/15
V40 T3 GTDi	03/12→12/16	V70 III T4F	01/11→12/15

87-452800-30 STD
87-452807-30 0.50mm

A 35.00
B- 11.50
BØ 53.70
C 3.43
D 2.67
D 54.00
 21x49

TP



08-452800-10 STD ①
08-452807-10 0.50mm ①

1.20  PVD P ②
 1.20  P
 2.00  NT ②

① Later engine, check ring thickness ① Späterer Motor, Ringdicke prüfen ① Moteur ultérieur, vérifier l'épaisseur du segment ① Motor posterior, comprobar espesor segmento ① Motore successivo, controllare spessore segmento
 ② Steel ② Stahl ② Acier ② Accro ② Acciaio



80.00 **10**

D 4192 T3	4cyl.	1870cc	85kW (116PS)	Diesel	Turbo	TD17997
D 4192 T4	4cyl.	1870cc	75kW (102PS)	Diesel	Turbo	TD17996
S40 I 1.9 DI			07/00→12/03	V40 1.9 DI		07/00→06/04

87-101500-00 STD
87-101507-00 0.50mm

A 47.06
B- 17.80
BØ 38.00
C 0.75
D 77.00
 28x60

AK RT TP

08-101500-00 STD
08-101507-00 0.50mm

2.50 MO P
2.00 P
3.00 CR P

14-020280-00 D
B 83.00 **C** 155.00 **D** 85.00 **E** 5.00

85.00 **11**

D 4204 T	4cyl.	1997cc	100kW (136PS)	Diesel	Turbo Intercooled	TD18993
C30 2.0 D			10/06→12/12	S80 II 2.0 TDi		02/08→03/11
C70 II 2.0 D			01/08→10/09	V50 2.0 D		04/04→12/10
S40 I 2.0 D			12/02→06/04	V70 III 2.0 D		10/07→12/15
S40 II 2.0 D			01/04→12/10			

87-114700-40 STD
87-114708-40 0.60mm

A 46.70
B- 15.40
BØ 44.80
C 0.57
D 72.71
 28x70
(08570-109)

AK KK RT TP

08-114700-00 STD
08-114708-00 0.60mm

3.50 CK P
2.00 P
3.00 CR P

87.50 **12**

B 4204 S3	4cyl.	1999cc	107kW (146PS)	Petrol		TD19659
C30 2.0			10/06→12/12	V50 2.0		10/06→12/12
S40 II 2.0			10/06→12/12	V70 III 2.0		10/07→12/11
S80 II 2.0			01/08→09/12			

87-423400-00 STD
87-423407-00 0.50mm

A 28.50
B- 0.35
BØ 76.50
D 51.00
 21x60

08-423400-00 STD
08-423407-00 0.50mm

1.20 CR P
1.20 P
2.50 CR

Steel Stahl Acier Acero Acciaio

98.43 **13**

D60A	6cyl.	5480cc	88kW (120PS)	Diesel		TD9146
TAMD60	6cyl.	5480cc	113kW (154PS)	Diesel	Turbo	MP23661
TD60A	6cyl.	5480cc	132kW (180PS)	Diesel	Turbo	TD9095
F6			03/75→02/86	TRUCK & BUS		





14-400510-00 WH

B 110.00 C 234.50 D 119.10 E 11.61 F 0.74

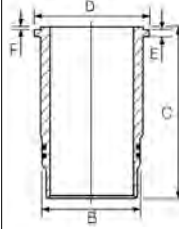

15-458900-00 WH

B 110.00 C 237.20 D 119.10 E 9.66 F 3.60

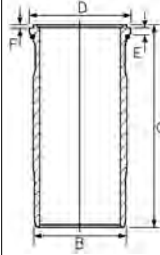

Includes seals

Schließt Dichtungen ein

Inclut des joints

Incluye los sellos

Comprende le guarnizioni

98.43						14
D6A180 (Euro 3)	6cyl.	5480cc	132kW (180PS)	Diesel	Turbo Intercooled	TD9219
D6A210 (Euro 3)	6cyl.	5480cc	154kW (210PS)	Diesel	Turbo Intercooled	TD9220
D6A230 (Euro 3)	6cyl.	5480cc	169kW (230PS)	Diesel	Turbo Intercooled	TD9227
D6A250 (Euro 3)	6cyl.	5480cc	184kW (250PS)	Diesel	Turbo Intercooled	TD9228
D6B (Euro 3)	6cyl.	5480cc	132-184kW (180-250PS)	Diesel	Turbo Intercooled	TD17367
B6			11/91→	FL6		09/85→08/00
FL			03/00→			

15-450130-00 WH

B 111.30 C 234.75 D 119.08 E 9.41 F 1.05

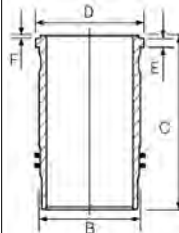

Includes seals

Schließt Dichtungen ein

Inclut des joints

Incluye los sellos

Comprende le guarnizioni







98.43						15
TD60B	6cyl.	5480cc	128-132kW (174-180PS)	Diesel	Turbo	TD9096
TD60C	6cyl.	5480cc	108-113kW (147-154PS)	Diesel	Turbo	TD9147
TD60D	6cyl.	5480cc	108-113kW (147-154PS)	Diesel	Turbo Intercooled	TD23336
TD60DG	6cyl.	5480cc	108-113kW (147-154PS)	Diesel	Turbo Intercooled	TD23337
TD61B	6cyl.	5480cc	132kW (180PS)	Diesel	Turbo	MP5040
TD61F	6cyl.	5480cc	150-152kW (204-207PS)	Diesel	Turbo Intercooled	TD9225
TD61FB	6cyl.	5480cc	153kW (206PS)	Diesel	Turbo Intercooled	TD9211
TD61G	6cyl.	5480cc	108-152kW (147-207PS)	Diesel	Turbo Intercooled	TD9221
TD61GA	6cyl.	5480cc	112kW (152PS)	Diesel	Turbo	TD9222
TD61GB	6cyl.	5480cc	131-132kW (179-180PS)	Diesel	Turbo	TD6249
TD61GC	6cyl.	5480cc	132kW (180PS)	Diesel	Turbo	TD9226
TD61GE	6cyl.	5480cc	130kW (175PS)	Diesel	Turbo	TD9210





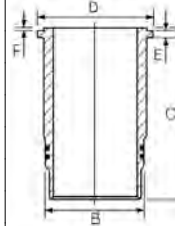

TD61GS	6cyl.	5480cc	131-132kW (179-180PS)	Diesel	Turbo	TD5902
---------------	-------	---------------	------------------------------	---------------	--------------	---------------

F6			09/75→10/86		TRUCK & BUS	
FL6			09/85→08/00			

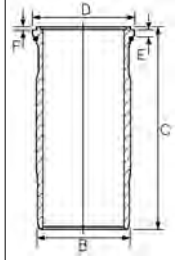
87-405500-10 STD A 79.40 B- 21.77 BØ 57.00 D 124.40  40x77 RT	08-405500-10 STD 2.38  CR P 3.16  P 4.74  CR P	14-400510-00 WH 	B 110.00 C 234.50 D 119.10 E 11.61 F 0.74	89-405500-10  87-405500-10 + 14-400510-00
---	---	---	--	---







		15-458900-00 WH  	B 110.00 C 237.20 D 119.10 E 9.66 F 3.60	89-405500-30  87-405500-10 + 15-458900-00
--	--	---	---	---

 Includes seals  Schließt Dichtungen ein  Inclut des joints  Incluye los sellos  Comprende le guarnizioni

98.43 **16**

TD63E	6cyl.	5480cc	132kW (180PS)	Diesel	Turbo Intercooled	TD9223
TD63ES	6cyl.	5480cc	154kW (210PS)	Diesel	Turbo Intercooled	TD9224

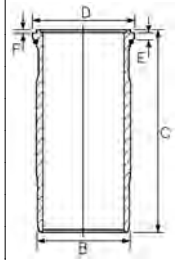
B6			11/91→		FL6	09/85→08/00
----	--	--	--------	--	-----	-------------





87-142500-00 STD A 79.40 B- 20.30 BØ 53.10 D 124.40  40x77 AK RT	08-142500-00 STD 3.50  MOL 2.50  CR 3.50  CR	15-459340-00 WH  	B 111.50 C 237.41 D 119.11 E 9.66 F 3.60	89-142500-30  87-142500-00 + 15-459340-00
--	---	---	---	---

 Includes seals  Schließt Dichtungen ein  Inclut des joints  Incluye los sellos  Comprende le guarnizioni

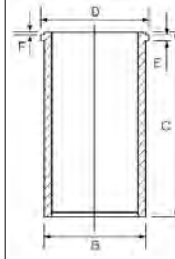
98.48 **17**

D39 (4.236)	4cyl.	3866cc		Diesel		MP1360
TRUCK & BUS						

		14-040200-00 DH  14-045820-00 D 14-045821-00 D	B 103.19 C 227.28 D 106.45 E 3.86 F 0.88 B 103.33 C 227.28 D 106.42 E 3.80 F 0.90 B 103.83 C 227.28 D 106.42 E 3.80 F 0.90	
				

 Press fit cast iron liner to replace original steel liner  Anpressbare Laufbuchse aus Gusseisen als Ersatz der original Stahlbüchse  Chemise fonte à emmancher à la presse pour remplacer la che mise d'origine en acier  Ajuste a presión la camisa de hierro fundido para reemplazar la camisa original de acero  Canna in ghisa per sostituire canne originali in acciaio



104.775

18

D70B	6cyl.	6730cc	110kW (150PS)	Diesel		TD9129
MD70	6cyl.	6730cc	102-106kW (139-145PS)	Diesel		MP6261
TAMD70	6cyl.	6730cc	206kW (280PS)	Diesel	Turbo	MP6263
TD70A	6cyl.	6730cc	136kW (185PS)	Diesel	Turbo	TD9131
TD70B	6cyl.	6730cc	152kW (207PS)	Diesel	Turbo	TD9132
TD70C	6cyl.	6730cc	149-152kW (202-207PS)	Diesel	Turbo	TD9208
TD70E	6cyl.	6730cc	154kW (210PS)	Diesel	Turbo	TD9133
TD70ES	6cyl.	6730cc	155-166kW (211-226PS)	Diesel	Turbo	TD9250
TD70F	6cyl.	6730cc	157-180kW (214-245PS)	Diesel	Turbo	TD9148
TD70FS	6cyl.	6730cc	157-180kW (214-245PS)	Diesel	Turbo	TD9150
TD70G	6cyl.	6730cc	147-180kW (200-245PS)	Diesel	Turbo	TD9151
TD70H	6cyl.	6730cc	157kW (213PS)	Diesel	Turbo	TD9097
TD70HA	6cyl.	6730cc	143kW (194PS)	Diesel	Turbo	TD9130
TMD70	6cyl.	6730cc	110-147kW (150-200PS)	Diesel	Turbo	MP6262

F7	08/78→12/85	MARINE	
F80	08/65→12/74	N7	01/73→09/80

14-573140-00 WH B 117.00 C 257.00 D 127.00 E 11.66 F 0.74

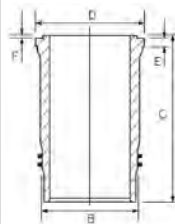

15-457590-00 WH [†] B 116.96 C 256.79 D 126.98 E 11.66 F 0.76

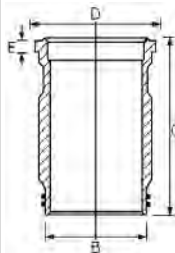

[†] Includes seals

[†] Schließt Dichtungen ein

[†] Inclut des joints

[†] Incluye los sellos

[†] Comprende le guarnizioni

104.775





19

TD71A	6cyl.	6730cc	169kW (220PS)	Diesel	Turbo Intercooled	TD23335
TD71ACE	6cyl.	6730cc	169kW (220PS)	Diesel	Turbo Intercooled	TD23334
TD71AG	6cyl.	6730cc	169kW (220PS)	Diesel	Turbo Intercooled	TD23333
TD71AGP	6cyl.	6730cc	169kW (220PS)	Diesel	Turbo Intercooled	TD23332
TD71AP	6cyl.	6730cc	169kW (220PS)	Diesel	Turbo Intercooled	TD23331
TD71APB	6cyl.	6730cc	169kW (220PS)	Diesel	Turbo Intercooled	TD23330
TD71AW	6cyl.	6730cc	169kW (220PS)	Diesel	Turbo Intercooled	TD23329
TD71E	6cyl.	6730cc	180kW (245PS)	Diesel	Turbo Intercooled	MP5113
TD71F	6cyl.	6730cc	169-180kW (220-245PS)	Diesel	Turbo Intercooled	TD5903
TD71FD	6cyl.	6730cc	180kW (245PS)	Diesel	Turbo Intercooled	TD9232
TD71FQ	6cyl.	6730cc	169-173kW (220-235PS)	Diesel	Turbo Intercooled	TD6250
TD71FS	6cyl.	6730cc	178-184kW (242-250PS)	Diesel	Turbo Intercooled	TD5904
TD71FSQ	6cyl.	6730cc	169-184kW (230-250PS)	Diesel	Turbo Intercooled	TD6251
TD71G	6cyl.	6730cc	178-184kW (242-250PS)	Diesel	Turbo Intercooled	TD26265

FL7	09/85→09/98	TRUCK & BUS	
-----	-------------	-------------	--



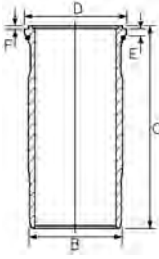

<p>87-501400-00 STD</p> <p>A 88.45 B- 20.95 BØ 65.00 C 1.08 D 141.05  45x86</p> <p>KK RT TP</p> 	<p>08-501400-00 STD</p> <p>2.38  MOL P 3.16  CR P 4.74  CR P</p>	<p>15-458910-00 WH ① ② B 116.94 C 259.45 D 127.01 E 9.66 F 3.60</p> 	<p>89-501400-00 ① 87-501400-00 + 15-458910-00</p>
---	--	---	--

① Includes seals ① Schließt Dichtungen ein ① Inclut des joints ① Incluye los sellos ① Comprende le guarnizioni
 ② Relief 18.25mm ② Entlastung 18.25mm ② Le relief 18.25mm ② Relevación 18.25mm ② Rilievo 18.25mm

104.775						20
TD71FA	6cyl.	6730cc	173kW (236PS)	Diesel	Turbo Intercooled	TD9212
TD71FC	6cyl.	6730cc	173kW (236PS)	Diesel	Turbo Intercooled	TD9213

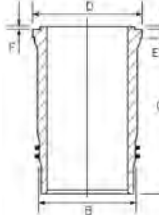
		<p>14-459050-00 WH ① B 116.96 C 259.45 D 127.00 E 9.66 F 3.59</p> 	
--	--	---	--

① Relief 18.25mm ① Entlastung 18.25mm ① Le relief 18.25mm ① Relevación 18.25mm ① Rilievo 18.25mm
 ② Includes seals ② Schließt Dichtungen ein ② Inclut des joints ② Incluye los sellos ② Comprende le guarnizioni

104.775						21
TD73E (Euro 1)	6cyl.	6730cc	169kW (230PS)	Diesel	Turbo Intercooled	TD9233
TD73EA	6cyl.	6730cc	160kW (215PS)	Diesel	Turbo Intercooled	TD9234
TD73EB	6cyl.	6730cc	184kW (250PS)	Diesel	Turbo Intercooled	TD9235
TD73ES	6cyl.	6730cc	191kW (260PS)	Diesel	Turbo Intercooled	TD9236

FL7 09/85→10/99





87-502700-00 STD

- A 88.45
- B- 20.10
- BØ 61.00
- C 2.05
- C 3.05
- D 132.45
-  45x82



RT TP

08-502700-00 STD

- 3.00  MOL P
- 2.50  P
- 4.00  CR P

14-459050-00 WH ¹

B 116.96 C 259.45 D 127.00 E 9.66 F 3.59

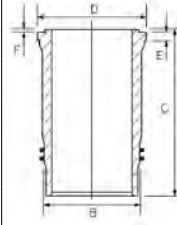

15-458910-00 WH ¹ ²

B 116.94 C 259.45 D 127.01 E 9.66 F 3.60

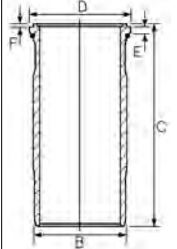

- ¹ Relief 18.25mm
- ² Includes seals

- ¹ Entlastung 18.25mm
- ² Schließt Dichtungen ein

- ¹ Le relief 18.25mm
- ² Inclut des joints

- ¹ Relevación 18.25mm
- ² Incluye los sellos

- ¹ Rilievo 18.25mm
- ² Comprende le guarnizioni

107.00

22

D7C215 (Euro 2)	6cyl.	7300cc	158kW (215PS)	Diesel	Turbo Intercooled	TD18725
D7C250 (Euro 2)	6cyl.	7300cc	184kW (250PS)	Diesel	Turbo Intercooled	TD11770
D7C275 (Euro 2)	6cyl.	7300cc	202kW (275PS)	Diesel	Turbo Intercooled	TD29197
D7C290 (Euro 2)	6cyl.	7300cc	213kW (290PS)	Diesel	Turbo Intercooled	TD11771
D7C310 (Euro 2)	6cyl.	7300cc	228kW (310PS)	Diesel	Turbo Intercooled	TD16726

7700

01/98→

FM7

08/98→12/01

87-141900-00 STD

- A 88.48
- B- 20.30
- BØ 61.00
- C 2.00
- C 1.35
- D 134.45
-  47x85



KK RT TP

08-141900-00 STD

- 3.50  CK P
- 2.50  P
- 3.50  CR P

15-450810-00 WH ¹

B 117.00 C 256.80 D 129.40 E 9.40 F 0.95

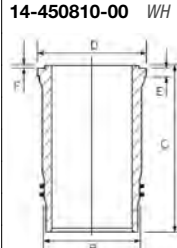

14-450810-00 WH

B 117.00 C 256.80 D 129.40 E 9.40 F 0.95

88-141900-00
87-141900-00 +
14-450810-00

89-141900-00 ¹
87-141900-00 +
15-450810-00

- ¹ Includes seals

- ¹ Schließt Dichtungen ein

- ¹ Inclut des joints

- ¹ Incluye los sellos

- ¹ Comprende le guarnizioni

108.00

23

D7D EAE2 (Euro 2)	6cyl.	7146cc	143-153kW (194-208PS)	Diesel	Turbo Intercooled	TD33148
D7D ECE2 (Euro 2)	6cyl.	7146cc	143-153kW (194-208PS)	Diesel	Turbo Intercooled	TD33151
D7D EEE2 (Euro 2)	6cyl.	7146cc	125-134kW (170-182PS)	Diesel	Turbo Intercooled	TD33152
D7D LAE2 (Euro 2)	6cyl.	7146cc	165kW (224PS)	Diesel	Turbo Intercooled	TD33153
D7D LBE2 (Euro 2)	6cyl.	7146cc	155kW (211PS)	Diesel	Turbo Intercooled	TD33154





87-136900-10 STD ①

A 71.15
B- 19.60
BØ 64.00
D 108.00
E 42x86



AK RT TP

08-136900-00 STD ②

3.00 CK P
2.00 P
3.50 CR P



15-480040-00 WH ③
14-480040-00 WH

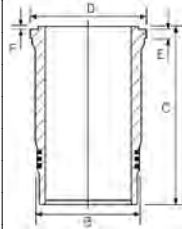

B 120.00 C 229.10 D 128.50 E 9.00 F 1.10
B 120.00 C 229.10 D 128.50 E 9.00 F 1.10

89-136900-10 ③
87-136900-10 +
15-480040-00

① Bowl capacity 54.00cm³
② Euro 2
③ Includes seals

① Volumen der Kolbenmulde 54.00cm³
③ Schließt Dichtungen ein

① Volume de la cavité du piston 54.00cm³
③ Inclut des joints

① Vol. cavidad pistón 54.00cm³
③ Incluye los sellos

① Volume camera pistone 54.00cm³
③ Comprende le guarnizioni

108.00 **24**

D7E240 (Euro 4)	6cyl.	7146cc	177kW (240PS)	Diesel	Turbo Intercooled	TD18965
D7E280 (Euro 4/5)	6cyl.	7146cc	206kW (280PS)	Diesel	Turbo Intercooled	TD18964
D7E290 (Euro 4)	6cyl.	7146cc	213kW (290PS)	Diesel	Turbo Intercooled	TD20460
D7E320 (Euro 4/5)	6cyl.	7146cc	235kW (320PS)	Diesel	Turbo Intercooled	TD18963
D7F240 (Euro 5)	6cyl.	7146cc	177kW (241PS)	Diesel	Turbo Intercooled	TD21581
D7F260 (Euro 5)	6cyl.	7146cc	191kW (260PS)	Diesel	Turbo Intercooled	TD21621
D7F290 (Euro 5)	6cyl.	7100cc	213kW (290PS)	Diesel	Turbo Intercooled	TD21623
D7F300 (Euro 5)	6cyl.	7100cc	221kW (301PS)	Diesel	Turbo Intercooled	TD21624
D7F340 (Euro 5)	6cyl.	7100cc	250kW (340PS)	Diesel	Turbo Intercooled	TD21626

7400	01/12→	ELITE 2	05/03→
8400	03/08→12/16	FE	05/06→
8700	01/99→	FE II	05/12→
8900	07/10→12/13	FL II	05/06→
9100	06/12→11/16	FL III	05/13→
9400	10/08→02/17	OLYMPUS	10/09→
B6	01/91→12/06	PHÖNIX 2	01/03→
B7	01/98→	VLE	01/09→12/14
CENTRO	01/98→		

87-430000-00 STD

A 70.90
B- 19.60
BØ 64.50
D 107.80
E 45x86



KK RT TP

08-430000-00 STD

3.00 CK
2.00
3.50 CR



15-480450-00 WH ①

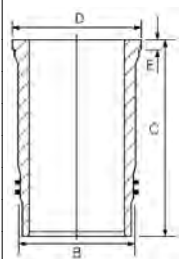

B 120.00 C 228.00 D 131.70 E 8.06

89-430000-00 ①
87-430000-00 +
15-480450-00

① Includes seals

① Schließt Dichtungen ein

① Inclut des joints

① Incluye los sellos

① Comprende le guarnizioni

120.00 **25**

D9A260 (Euro 3)	6cyl.	9364cc	191kW (260PS)	Diesel	Turbo Intercooled	TD16780
D9A300 (Euro 3)	6cyl.	9364cc	221-224kW (300-305PS)	Diesel	Turbo Intercooled	TD16781
D9A340 (Euro 3)	6cyl.	9364cc	250-251kW (340-341PS)	Diesel	Turbo Intercooled	TD16782
D9A380 (Euro 3)	6cyl.	9364cc	279kW (380PS)	Diesel	Turbo Intercooled	TD16783

8300	01/06→	A	01/05→12/12
9300	01/06→	FM	09/05→
9400	01/06→	FM9	12/01→09/05





87-142000-00 STD ①

A 85.45
B- 14.60
BØ 77.00
D 130.00
 54x96



AK KK RT TP

- ① Bowl capacity 57.00cm³
- ② Steel
- ③ Includes seals

08-142000-00 STD

4.00 CK P
 3.00 P
 3.00 NT②



- ① Volumen der Kolbenmulde 57.00cm³
- ② Stahl
- ③ Schließt Dichtungen ein

15-480230-00 WH ③

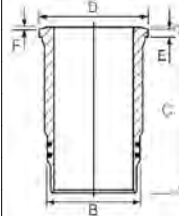

- ① Volume de la cavité du piston 57.00cm³
- ② Acier
- ③ Inclut des joints

B 139.00 **C** 249.55 **D** 149.00 **E** 12.05 **F** 0.85

- ① Vol. cavidad pistón 57.00cm³
- ② Acero
- ③ Incluye los sellos

88-142000-00
 87-142000-00 +
 14-480230-00

- ① Volume camera pistone 57.00cm³
- ② Acciaio
- ③ Comprende le guarnizioni

120.00

26

D9B260 (Euro 4/5)	6cyl.	9364cc	191-194kW (260-264PS)	Diesel	Turbo Intercooled	TD21048
D9B300 (Euro 4)	6cyl.	9364cc	221kW (300PS)	Diesel	Turbo Intercooled	TD18978
D9B310 (Euro 4/5)	6cyl.	9364cc	228kW (310PS)	Diesel	Turbo Intercooled	TD21049
D9B340 (Euro 4)	6cyl.	9364cc	250kW (340PS)	Diesel	Turbo Intercooled	TD18979
D9B360 (Euro 4/5)	6cyl.	9364cc	265kW (360PS)	Diesel	Turbo Intercooled	TD21050
D9B380 (Euro 4)	6cyl.	9364cc	280kW (380PS)	Diesel	Turbo Intercooled	TD18980
7700			06/06→			9500
8300			01/06→			B9
8500			01/99→			FM
8900			07/10→12/13			FM9
9300			01/06→			OLYMPUS
9400			01/06→			
						10/10→12/13
						09/05→
						09/05→
						12/01→09/05
						11/06→

87-438900-00 STD

A 85.45
B- 14.85
BØ 79.00
C 1.00
D 129.95
 54x96



AK KK RT

- ① Steel
- ② Includes seals

08-438900-00 STD

3.50 PVD ①
 2.50 P
 3.00 NT①



- ① Stahl
- ② Schließt Dichtungen ein

14-480460-00 WH

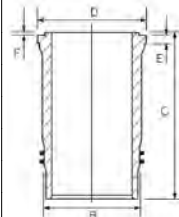

- ① Acier
- ② Inclut des joints

B 139.00 **C** 250.05 **D** 149.00 **E** 0.85 **F** 11.20

- ① Acero
- ② Incluye los sellos

89-438900-00 ②
 87-438900-00 +
 14-480460-00

- ① Acciaio
- ② Comprende le guarnizioni

120.65

27

D100A	6cyl.	9600cc	122-147kW (166-200PS)	Diesel		TD9204
D100B	6cyl.	9600cc	147kW (200PS)	Diesel		TD9205
D100BHC	6cyl.	9600cc		Diesel		MP5114
D100BRC	6cyl.	9600cc		Diesel		MP5115
HD100A	6cyl.	9600cc	129kW (175PS)	Diesel		TD9134
HD100D	6cyl.	9600cc	125-132kW (170-180PS)	Diesel		TD9135
MD100A	6cyl.	9600cc		Diesel		MP5116
MD100B	6cyl.	9600cc		Diesel		MP5117
THD100A	6cyl.	9600cc	139-191kW (200-260PS)	Diesel	Turbo	TD9136
TMD102	6cyl.	9599cc	158-200kW (215-272PS)	Diesel	Turbo Intercooled	MP8860

TRUCK & BUS





14-450520-00 WH B 134.00 C 294.00 D 147.00 E 11.77 F 0.78

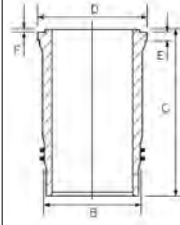

120.65

28

D10A320	6cyl.	9600cc	235kW (320PS)	Diesel	Turbo	TD9263
D10A360	6cyl.	9600cc	265kW (360PS)	Diesel	Turbo	TD12047
D10B320 (Euro 2)	6cyl.	9600cc	235kW (320PS)	Diesel	Turbo Intercooled	TD16235
D10B360 (Euro 2)	6cyl.	9600cc	265kW (360PS)	Diesel	Turbo Intercooled	TD16236
DH10A (Euro 2)	6cyl.	9600cc	180-265kW (245-360PS)	Diesel	Turbo Intercooled	MP45043
DH10A245 (Euro 2)	6cyl.	9600cc	180kW (245PS)	Diesel	Turbo Intercooled	TD29181
DH10A285 (Euro 2)	6cyl.	9600cc	210kW (285PS)	Diesel	Turbo Intercooled	TD29182
DH10A360 (Euro 2)	6cyl.	9600cc	265kW (360PS)	Diesel	Turbo Intercooled	TD29183
TD102FAQ	6cyl.	9600cc	221kW (301PS)	Diesel	Turbo Intercooled	TD9161
TD102FCQ	6cyl.	9600cc	220kW (299PS)	Diesel	Turbo Intercooled	TD9163
TD102FEQ	6cyl.	9600cc	191kW (260PS)	Diesel	Turbo Intercooled	TD9165
TD102FGQ	6cyl.	9600cc	205kW (279PS)	Diesel	Turbo Intercooled	TD9167
TD102FL (Euro 1)	6cyl.	9600cc	234kW (318PS)	Diesel	Turbo	TD9169
TD102FM	6cyl.	9600cc	230-252kW (313-343PS)	Diesel	Turbo Intercooled	TD9170
TD102FQ	6cyl.	9600cc	234kW (318PS)	Diesel	Turbo	MP5126
TD102FS	6cyl.	9600cc	250kW (340PS)	Diesel	Turbo Intercooled	TD9264
TD102FT	6cyl.	9600cc	228kW (310PS)	Diesel	Turbo Intercooled	TD9262
THD102KD	6cyl.	9600cc	252kW (343PS)	Diesel	Turbo Intercooled	TD9118
B10		01/85→08/11		FM10		04/99→09/03
F10		01/87→12/95		NL		01/89→
FL10		09/85→09/98		TRUCK & BUS		

15-459040-00 WH B 134.00 C 287.25 D 147.00 E 11.53 F 3.47
14-459040-00 WH B 134.00 C 287.25 D 147.00 E 11.53 F 3.47
15-459230-00 WH B 133.82 C 287.30 D 147.00 E 11.50 F 3.50

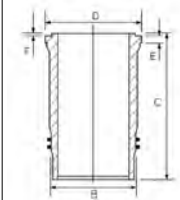

Includes seals

Schließt Dichtungen ein

Inclut des joints

Incluye los sellos

Comprende le guarnizioni

120.65

29

TD100A	6cyl.	9600cc	176-190kW (239-258PS)	Diesel	Turbo	TD9152
TD100AHC	6cyl.	9600cc		Diesel	Turbo	MP5118
TD100ARC	6cyl.	9600cc		Diesel	Turbo	MP5119
THD100B	6cyl.	9600cc		Diesel	Turbo	MP5166-1
THD100D	6cyl.	9600cc	155-177kW (211-241PS)	Diesel	Turbo	TD9119
THD101B	6cyl.	9600cc	169-191kW (230-260PS)	Diesel	Turbo	TD23324





TMD100A	6cyl.	9600cc	Diesel	Turbo	MP5048
BUS			F80		08/65→06/77
F10		01/76→12/83	TRUCK & BUS		

14-450520-00 WH B 134.00 C 294.00 D 147.00 E 11.77 F 0.78

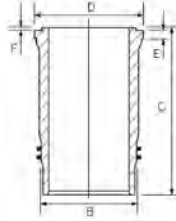

15-677620-00 WH ① B 133.82 C 296.49 D 147.02 E 11.52 F 3.50

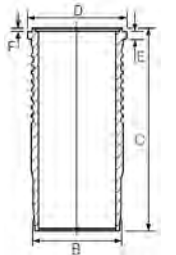

15-673200-00 WH ① ② B 134.00 C 296.50 D 147.00 E 11.52 F 3.48
14-673200-00 WH ② B 134.00 C 296.50 D 147.00 E 11.52 F 3.48

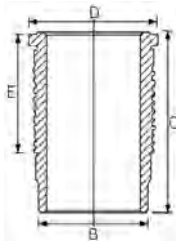

① Includes seals
 ② Water jacket chromed

① Schließt Dichtungen ein
 ② Am Wassermantel verchromt

① Includ des joints
 ② Chromé sur chambre d'eau

① Incluye los sellos
 ② Camisa de agua cromada

① Comprende le guarnizioni
 ② Superficie cromata

120.65 **30**

TD100B	6cyl.	9600cc	206-220kW (280-299PS)	Diesel	Turbo	TD9153
TD100BG	6cyl.	9600cc	207kW (282PS)	Diesel	Turbo	TD21337
F10		01/76→12/83	N10			01/73→12/98

14-458170-00 WH B 133.86 C 296.25 D 147.00 E 11.53 F 3.47

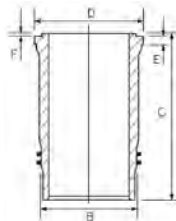



15-677620-00 WH ① **B 133.82 C 296.49 D 147.02 E 11.52 F 3.50**

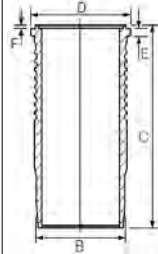

15-673200-00 WH ① ② **B 134.00 C 296.50 D 147.00 E 11.52 F 3.48**
14-673200-00 WH ② **B 134.00 C 296.50 D 147.00 E 11.52 F 3.48**

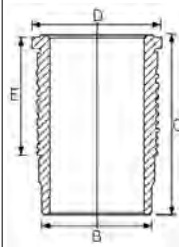

① Includes seals
 ② Water jacket chromed

① Schließt Dichtungen ein
 ② Am Wassermantel verchromt

① Includ des joints
 ② Chromé sur chambre d'eau

① Incluye los sellos
 ② Camisa de agua cromada

① Comprende le guarnizioni
 ② Superficie cromata

120.65 **31**

TD100CHC	6cyl.	9600cc	200kW (272PS)	Diesel	Turbo	TD21338
TD100F	6cyl.	9600cc	200kW (272PS)	Diesel	Turbo	TD21339
TD100G	6cyl.	9600cc	192-202kW (261-275PS)	Diesel	Turbo	TD9154
TD100GA	6cyl.	9600cc	200kW (272PS)	Diesel	Turbo	TD9155
TD100GG	6cyl.	9600cc		Diesel	Turbo	MP5047
TD101F	6cyl.	9600cc	215-220kW (292-299PS)	Diesel	Turbo Intercooled	TD9156
TD101FA	6cyl.	9600cc	220kW (299PS)	Diesel	Turbo Intercooled	TD9157
TD101FC	6cyl.	9600cc	221kW (301PS)	Diesel	Turbo Intercooled	TD9237
TD101FD	6cyl.	9600cc	220-222kW (299-302PS)	Diesel	Turbo Intercooled	TD9238
TD101G	6cyl.	9600cc	192-202kW (261-275PS)	Diesel	Turbo	TD9158
TD101GA	6cyl.	9600cc	200kW (272PS)	Diesel	Turbo Intercooled	TD9159
TD101GB	6cyl.	9600cc	185-200kW (252-272PS)	Diesel	Turbo Intercooled	TD9252
TD101GE	6cyl.	9600cc	200kW (272PS)	Diesel	Turbo Intercooled	TD21340

F10	01/76→12/87	NL	01/89→12/92
FL10	09/85→09/98	TRUCK & BUS	
N10	01/73→12/98		

87-407100-00 STD

- A** 109.40
- B-** 23.15
- BØ** 76.00
- C** 1.88
- D** 166.40
-  **E** 52x106



RT

08-407100-10 STD

- 2.38  CR P
- 3.16  CR P
- 4.74  CR P

15-459350-00 WH ① **B 133.82 C 297.00 D 147.02 E 11.52 F 3.50**

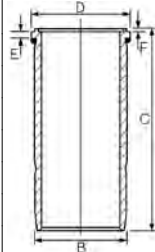

89-407100-00 ①
 87-407100-00 +
 15-459350-00





14-458170-00 WH B 133.86 C 296.25 D 147.00 E 11.53 F 3.47

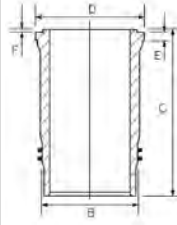

15-677620-00 WH ① B 133.82 C 296.49 D 147.02 E 11.52 F 3.50

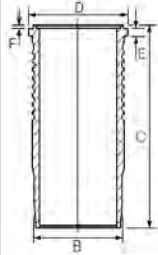

15-673200-00 WH ① ② B 134.00 C 296.50 D 147.00 E 11.52 F 3.48
14-673200-00 WH ② B 134.00 C 296.50 D 147.00 E 11.52 F 3.48

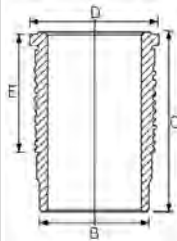

① Includes seals
 ② Water jacket chromed

① Schließt Dichtungen ein
 ② Am Wassermantel verchromt

① Inclut des joints
 ② Chromé sur chambre d'eau

① Incluye los sellos
 ② Camisa de agua cromada

① Comprende le guarnizioni
 ② Superficie cromata

120.65							32
TD100GB	6cyl.	9600cc	207-220kW (280-300PS)	Diesel	Turbo	MP3723	
TD101	6cyl.	9600cc	200kW (272PS)	Diesel	Turbo Intercooled	MP6227	
THD101	6cyl.	9600cc	203-228kW (276-310PS)	Diesel	Turbo Intercooled	MP6228	
THD101KF	6cyl.	9600cc	228kW (310PS)	Diesel	Turbo Intercooled	MP5161	
TID100	6cyl.	9600cc		Diesel	Turbo Intercooled	MP6265	
BUS	TRUCK & BUS						

14-458170-00 WH B 133.86 C 296.25 D 147.00 E 11.53 F 3.47

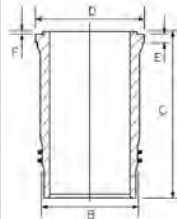



15-459350-00 WH ① B 133.82 C 297.00 D 147.02 E 11.52 F 3.50

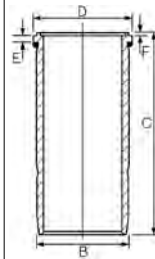

15-677620-00 WH ① B 133.82 C 296.49 D 147.02 E 11.52 F 3.50

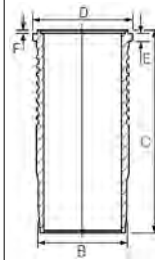

15-673200-00 WH ① ② B 134.00 C 296.50 D 147.00 E 11.52 F 3.48

14-673200-00 WH ② B 134.00 C 296.50 D 147.00 E 11.52 F 3.48

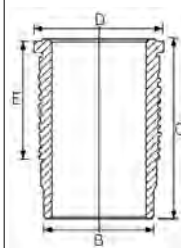

① Includes seals
② Water jacket chromed

① Schließt Dichtungen ein
② Am Wassermantel verchromt

① Inclut des joints
② Chromé sur chambre d'eau

① Incluye los sellos
② Camisa de agua cromada

① Comprende le guarnizioni
② Superficie cromata

120.65						33
TD102F	6cyl.	9600cc	230-234kW (313-318PS)	Diesel	Turbo Intercooled	TD9160
TD102FD (Euro 1)	6cyl.	9600cc	234kW (318PS)	Diesel	Turbo Intercooled	TD21341
TD102FDQ	6cyl.	9600cc	232-234kW (316-318PS)	Diesel	Turbo Intercooled	TD9164
TD102FF	6cyl.	9600cc	230-234kW (313-318PS)	Diesel	Turbo Intercooled	TD9166
TD102FH	6cyl.	9600cc	210-234kW (286-318PS)	Diesel	Turbo Intercooled	TD9168
F10			01/87→12/95	NL		01/90→
FL10			09/85→02/96			

87-431300-00 STD ①

A 92.55
B- 22.20
BØ 76.00
C 1.95
D 131.05
52x98



NB

08-431300-00 STD

3.00 CK P
3.16 CR P
4.74 CR P



① Pendelschaftkolben
② Schließt Dichtungen ein

15-459040-00 WH ② B 134.00 C 287.25 D 147.00 E 11.53 F 3.47

14-459040-00 WH B 134.00 C 287.25 D 147.00 E 11.53 F 3.47

15-459230-00 WH ② B 133.82 C 287.30 D 147.00 E 11.50 F 3.50

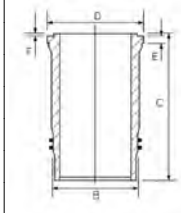

① Piston articulé
② Inclut des joints

① Pistón articulado
② Incluye los sellos

89-431300-00 ②

87-431300-00 +
15-459040-00

① Pistone articolato
② Comprende le guarnizioni

① Articulated piston
② Includes seals



120.65

34

TD102FBQ 6cyl. **9600cc** **228kW** (310PS) **Diesel** **Turbo Intercooled** **TD9162**

F10 10/87→12/94

87-431300-00 STD ①

- A 92.55
- B- 22.20
- BØ 76.00
- C 1.95
- D 131.05
-  52x98
- NB



08-431300-00 STD

- 3.00  CK P
- 3.16  CR P
- 4.74  CR P

- 15-459040-00** WH ②
- 14-459040-00** WH
- 15-459230-00** WH ②

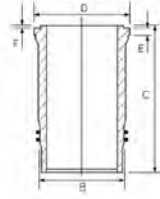

- B 134.00 C 287.25 D 147.00 E 11.53 F 3.47
- B 134.00 C 287.25 D 147.00 E 11.53 F 3.47
- B 133.82 C 287.30 D 147.00 E 11.50 F 3.50

① Articulated piston
② Includes seals

① Pendelschaftkolben
② Schließt Dichtungen ein

① Piston articulé
② Inclut des joints

① Pistón articulado
② Incluye los sellos

① Pistone articolato
② Comprende le guarnizioni

120.65

35

TD103D10 (Euro 2) 6cyl. **9600cc** **265kW** (360PS) **Diesel** **Turbo Intercooled** **MP35043**



TRUCK & BUS

①

- A 92.60
- B- 22.50
- BØ 64.00
- C 2.10
- D 137.60
-  52x98
- RT TP



08-136800-00 STD

- 4.00  MOL P
- 3.16  NT P
- 4.74  CR P

- 15-459230-00** WH ②
- 15-459040-00** WH ②
- 14-459040-00** WH

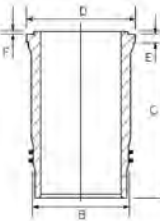

- B 133.82 C 287.30 D 147.00 E 11.50 F 3.50
- B 134.00 C 287.25 D 147.00 E 11.53 F 3.47
- B 134.00 C 287.25 D 147.00 E 11.53 F 3.47

89-136800-10 ②
15-459230-00

① Piston available in Kit Set only
② Includes seals

① Kolben nur im Assembly erhältlich
② Schließt Dichtungen ein

① Piston disponible en kit seulement
② Inclut des joints

① Pistón disponible en conjuntos solamente.
② Incluye los sellos

① I pistoni sono disponibili solo in kit motore
② Comprende le guarnizioni

120.65

36

TD103E (Euro 1)	6cyl.	9600cc	210-235kW (286-320PS)	Diesel	Turbo Intercooled	TD5900
TD103EA (Euro 1)	6cyl.	9600cc	235kW (320PS)	Diesel	Turbo Intercooled	TD21342
TD103ES (Euro 1)	6cyl.	9600cc	210-235kW (286-320PS)	Diesel	Turbo Intercooled	TD6247
TD103KBE (Euro 1)	6cyl.	9600cc	210-235kW (286-320PS)	Diesel	Turbo Intercooled	TD19062
TD103KF (Euro 1)	6cyl.	9600cc	210-235kW (286-320PS)	Diesel	Turbo Intercooled	TD19063
THD103KB	6cyl.	9600cc	210kW (286PS)	Diesel	Turbo	TD9098
THD103KD	6cyl.	9600cc	250kW (340PS)	Diesel	Turbo	TD9099

B10 01/88→12/03 FL10 09/85→09/98
F10 01/87→12/95 NL 01/90→

①

- A 92.50
- B- 21.80
- BØ 67.40
- C 2.00
- D 144.50
-  52x98
- AK RT



08-502600-00 STD

- 3.50  MOL P
- 3.16  CR P
- 4.74  CR P

- 15-459230-00** WH ②
- 15-459040-00** WH ②
- 14-459040-00** WH

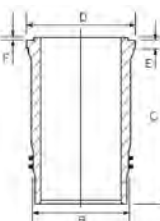

- B 133.82 C 287.30 D 147.00 E 11.50 F 3.50
- B 134.00 C 287.25 D 147.00 E 11.53 F 3.47
- B 134.00 C 287.25 D 147.00 E 11.53 F 3.47

89-502600-00 ②
15-459230-00

① Piston available in Kit Set only
② Includes seals

① Kolben nur im Assembly erhältlich
② Schließt Dichtungen ein

① Piston disponible en kit seulement
② Inclut des joints

① Pistón disponible en conjuntos solamente.
② Incluye los sellos

① I pistoni sono disponibili solo in kit motore
② Comprende le guarnizioni



120.65							37
THD100DB	6cyl.	9600cc	160-203kW (218-276PS)	Diesel	Turbo Intercooled	TD9120	
THD100DC	6cyl.	9600cc	160-203kW (218-276PS)	Diesel	Turbo Intercooled	TD9104	
THD100DD	6cyl.	9600cc	203kW (276PS)	Diesel	Turbo	TD9105	
THD100E	6cyl.	9600cc	160-203kW (218-276PS)	Diesel	Turbo Intercooled	TD9137	
THD100EA	6cyl.	9600cc	133-180kW (180-245PS)	Diesel	Turbo	TD9106	
THD100EB	6cyl.	9600cc	160-203kW (218-276PS)	Diesel	Turbo	TD9107	
THD100EC	6cyl.	9600cc	160-203kW (218-276PS)	Diesel	Turbo	TD9108	
THD100ED	6cyl.	9600cc	160-203kW (218-276PS)	Diesel	Turbo Intercooled	TD9109	
THD100EE	6cyl.	9600cc	212kW (288PS)	Diesel	Turbo	TD9110	
THD100EK	6cyl.	9600cc	179kW (243PS)	Diesel	Turbo	TD9111	
THD101G	6cyl.	9600cc	203kW (275PS)	Diesel	Turbo	MP5168	
THD101GB	6cyl.	9600cc	160kW (218PS)	Diesel	Turbo	TD9112	
THD101GC	6cyl.	9600cc	180kW (245PS)	Diesel	Turbo	TD9113	
THD101GD	6cyl.	9600cc	160-203kW (218-276PS)	Diesel	Turbo	TD9114	
THD101KB	6cyl.	9600cc	210kW (286PS)	Diesel	Turbo Intercooled	TD9115	
THD101KC	6cyl.	9600cc	228kW (310PS)	Diesel	Turbo Intercooled	TD9116	
THD101KE	6cyl.	9600cc	235kW (320PS)	Diesel	Bi-Turbo Intercooled	TD9117	

B10 01/78→ TRUCK & BUS
 BUS

14-458170-00 WH B 133.86 C 296.25 D 147.00 E 11.53 F 3.47 **89-407100-20** 1
 87-407100-10 +
 15-677620-00

15-459350-00 WH 2 B 133.82 C 297.00 D 147.02 E 11.52 F 3.50

15-673200-00 WH 2 3 B 134.00 C 296.50 D 147.00 E 11.52 F 3.48
14-673200-00 WH 3 B 134.00 C 296.50 D 147.00 E 11.52 F 3.48





15-677620-00 WH ② B 133.82 C 296.49 D 147.02 E 11.52 F 3.50

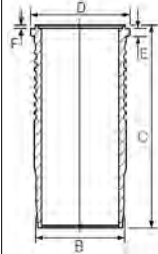

② Includes seals
③ Water jacket chromed

② Schließt Dichtungen ein
③ Am Wassermantel verchromt

② Inclut des joints
③ Chromé sur chambre d'eau

② Incluye los sellos
③ Camisa de agua cromada

② Comprende le guarnizioni
③ Superficie cromata

120.65 **38**

THD102KA	6cyl.	9600cc	210kW (286PS)	Diesel	Turbo Intercooled	TD23325
THD102KB (Euro 1)	6cyl.	9600cc	210kW (286PS)	Diesel	Turbo Intercooled	TD23326
THD102KF	6cyl.	9600cc	180-210kW (245-286PS)	Diesel	Turbo Intercooled	TD9121
THD102KJ	6cyl.	9600cc	158kW (215PS)	Diesel	Turbo Intercooled	TD9138
TMD102A (Marine)	6cyl.	9599cc	158-200kW (215-272PS)	Diesel	Turbo Intercooled	MP8859
TMD102C (Marine)	6cyl.	9599cc	158-200kW (215-272PS)	Diesel	Turbo Intercooled	MP8859-1

B10 01/78→12/03 OLYMPIAN 01/92→12/00
MARINE

14-458170-00 WH B 133.86 C 296.25 D 147.00 E 11.53 F 3.47

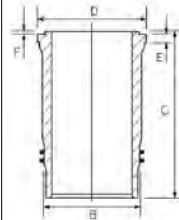

123.00 **39**

D11A430 (Euro 3)	6cyl.	10840cc	317kW (431PS)	Diesel	Turbo Intercooled	TD28572
D11B430 (Euro 4/5)	6cyl.	10840cc	316kW (430PS)	Diesel	Turbo Intercooled	TD23373
D11C330 (Euro 5)	6cyl.	10840cc	243kW (330PS)	Diesel	Turbo Intercooled	TD22373
D11C370 (Euro 5)	6cyl.	10840cc	272kW (370PS)	Diesel	Turbo Intercooled	TD22374
D11C410 (Euro 5)	6cyl.	10840cc	302kW (410PS)	Diesel	Turbo Intercooled	TD22376

9400 11/16→03/20 FMX 04/10→
B11 01/11→ FMX III 02/20→
FM 09/05→ VNM 08/16→

87-438800-00 STD ①

- A 78.40
- B- 17.00
- BØ 83.60
- C 1.00
- C 1.00
- D 111.70
- 54x73



KK TP

08-438800-00 STD ②

- 3.50 PVD ③
- 2.50 CR P
- 3.00 NT ③



15-480440-00 WH ④ B 139.00 C 249.55 D 149.00 E 11.20 F 0.85
14-480440-00 WH B 139.00 C 249.55 D 149.00 E 11.20 F 0.85

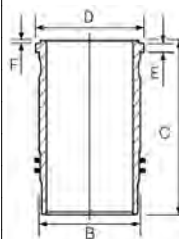

89-438800-00 ④
87-438800-00 +
15-480440-00

① MonoSteel®
② Euro 4/5
③ Steel

④ Stahl
④ Schließt Dichtungen ein

④ Acier
④ Inclut des joints

④ Acero
④ Incluye los sellos

④ Acciaio
④ Comprende le guarnizioni



130.175 **40**

TAMD120A	6cyl.	11980cc	225-243kW (306-330PS)	Diesel	Turbo	MP5133
TAMD120B	6cyl.	11980cc		Diesel	Turbo	MP5134
TAMD121	6cyl.	11980cc	217-310kW (295-420PS)	Diesel	Turbo	MP6266
TD120A	6cyl.	11980cc	243kW (330PS)	Diesel	Turbo	TD9206
TD120C	6cyl.	11980cc	260kW (354PS)	Diesel	Turbo	TD9171
TD120D	6cyl.	11980cc	273kW (371PS)	Diesel	Turbo	TD9172
TD120E	6cyl.	11980cc	225-273kW (306-371PS)	Diesel	Turbo	TD9173
TD120F	6cyl.	11980cc	265kW (360PS)	Diesel	Turbo Intercooled	TD9174
TD120FA	6cyl.	11980cc	213kW (290PS)	Diesel	Turbo Intercooled	TD9254
TD120FB	6cyl.	11980cc	226-265kW (307-360PS)	Diesel	Turbo Intercooled	TD9255
TD120FC	6cyl.	11980cc	265kW (360PS)	Diesel	Turbo Intercooled	TD9175
TD120FTQ	6cyl.	11980cc	220kW (299PS)	Diesel	Turbo Intercooled	TD9176
TD120G	6cyl.	11980cc	226-243kW (307-330PS)	Diesel	Turbo	TD9177
TD120GA	6cyl.	11980cc	227kW (308PS)	Diesel	Turbo	TD9178
TD120GG	6cyl.	11980cc		Diesel	Turbo	MP5138
TD121F	6cyl.	11980cc	272-283kW (370-385PS)	Diesel	Turbo Intercooled	TD9179
TD121FD	6cyl.	11980cc	283kW (385PS)	Diesel	Turbo Intercooled	TD9180
TD121FK	6cyl.	11980cc	280kW (381PS)	Diesel	Turbo Intercooled	TD9182
TD121G	6cyl.	11980cc	235-243kW (320-330PS)	Diesel	Turbo	TD9183
TD121GD	6cyl.	11980cc	243kW (330PS)	Diesel	Turbo	TD9143
TD122ED	6cyl.	11980cc	300-310kW (408-422PS)	Diesel	Turbo Intercooled	TD9185
TD122FAQ	6cyl.	11980cc	287kW (390PS)	Diesel	Turbo Intercooled	TD9188
TD122FBQ	6cyl.	11980cc	287kW (390PS)	Diesel	Turbo Intercooled	TD9189
TD122FCQ	6cyl.	11980cc	287kW (390PS)	Diesel	Turbo Intercooled	TD9190
TD122FH (Euro 1)	6cyl.	11980cc	262kW (356PS)	Diesel	Turbo Intercooled	TD9122
TD122FL	6cyl.	11980cc	291kW (396PS)	Diesel	Turbo Intercooled	TD9123
TD122KBE	6cyl.	11980cc	226-265kW (307-360PS)	Diesel	Turbo Intercooled	TD23340
TID120F	6cyl.	11980cc		Diesel	Turbo	MP5045
TMD120A	6cyl.	11980cc	225-243kW (306-330PS)	Diesel		MP5132

B12	01/92→	N12	01/81→09/91
F12	01/76→12/95	NL	01/89→12/92
F80	10/70→06/77	TRUCK & BUS	
MARINE			

- 14-450530-00 WH ① B 144.00 C 311.00 D 157.60 E 13.52 F 0.76
- 14-456000-00 WH B 144.00 C 311.00 D 157.60 E 10.52 F 0.76
- 15-457960-00 WH ② ③ B 143.89 C 311.00 D 157.62 E 10.55 F 0.86
- 15-458180-00 WH ③ B 143.88 C 313.00 D 157.62 E 10.52 F 3.28
- 14-458180-00 WH B 143.88 C 313.00 D 157.62 E 10.52 F 3.28
- 15-459030-00 WH ③ B 143.91 C 310.52 D 157.58 E 13.55 F 0.68

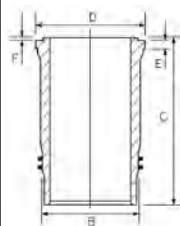



15-458840-00 WH ③ B 143.85 C 313.25 D 157.62 E 10.52 F 3.25

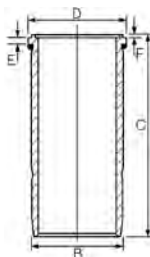

① Phosphated
② For cylinder block no.470130 only

① Phosphatiert
② Nur für Zylinderblock-Nr.470130

① Phosphaté
② Pour le bloc-cylindres n° 470130 uniquement

① Fosfatado
② Solo para bloque de cilindros n° 470130

① Fosfatato
② Solo per monoblocco cilindri n° 470130

③ Includes seals

③ Schließt Dichtungen ein

③ Inclut des joints

③ Incluye los sellos

③ Comprende le guarnizioni

130.175

41

TD121FH 6cyl. **11980cc** **232kW** (315PS) **Diesel Turbo Intercooled** **TD9181**

14-456000-00 WH B 144.00 C 311.00 D 157.60 E 10.52 F 0.76
15-457960-00 WH ① ② B 143.89 C 311.00 D 157.62 E 10.55 F 0.86
15-458180-00 WH ② B 143.88 C 313.00 D 157.62 E 10.52 F 3.28
14-458180-00 WH B 143.88 C 313.00 D 157.62 E 10.52 F 3.28

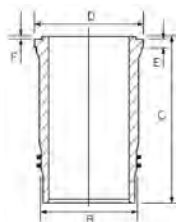

① For cylinder block no.470130 only

① Nur für Zylinderblock-Nr.470130

① Pour le bloc-cylindres n° 470130 uniquement

① Solo para bloque de cilindros n° 470130

① Solo per monoblocco cilindri n° 470130

② Includes seals

② Schließt Dichtungen ein

② Inclut des joints

② Incluye los sellos

② Comprende le guarnizioni

130.175

42

TD122	6cyl.	11980cc	309kW (420PS)	Diesel	Turbo Intercooled	TD9184
TD122F	6cyl.	11980cc	257-262kW (350-356PS)	Diesel	Turbo	TD9186
TD122FA	6cyl.	11980cc	272kW (370PS)	Diesel	Turbo	TD9187
TD122FK	6cyl.	11980cc	287-291kW (390-396PS)	Diesel	Turbo Intercooled	TD9191
TD122FR	6cyl.	11980cc	262-291kW (356-396PS)	Diesel	Turbo Intercooled	TD9193
TD122FS	6cyl.	11980cc	287-291kW (395-396PS)	Diesel	Turbo Intercooled	TD9194
TD122KE	6cyl.	11980cc	290kW (394PS)	Diesel	Turbo Intercooled	TD23339

F12

01/87→12/95

NL

01/89→





<p>1</p> <p>08-405600-10 STD</p> <p>A 114.20 B- 25.40 BØ 79.00 C 2.60 D 175.20 E 55x114 RT</p>	<p>2.38 CR P 3.16 CR P 4.74 CR P</p>	<p>15-458840-00 WH 2 B 143.85 C 313.25 D 157.62 E 10.52 F 3.25</p>	<p>89-405600-60 2 15-458840-00</p>
--	---	--	---

		<p>14-450530-00 WH 3 B 144.00 C 311.00 D 157.60 E 13.52 F 0.76 14-456000-00 WH B 144.00 C 311.00 D 157.60 E 10.52 F 0.76 14-457960-00 WH 2 4 B 143.89 C 311.00 D 157.62 E 10.55 F 0.86 15-458180-00 WH 2 B 143.88 C 313.00 D 157.62 E 10.52 F 3.28 14-458180-00 WH B 143.88 C 313.00 D 157.62 E 10.52 F 3.28 15-459030-00 WH 2 B 143.91 C 310.52 D 157.58 E 13.55 F 0.68</p>	
--	--	---	--

- 1** Piston available in Kit Set only
- 2** Includes seals
- 3** Phosphated
- 4** For cylinder block no.470130 only
- 1** Kolben nur im Assembly erhältlich
- 2** Schließt Dichtungen ein
- 3** Phosphatiert
- 4** Nur für Zylinderblock-Nr.470130
- 1** Piston disponible en kit seulement
- 2** Inclut des joints
- 3** Phosphaté
- 4** Pour le bloc-cylindres n° 470130 uniquement
- 1** Pistón disponible en conjuntos solamente.
- 2** Incluye los sellos
- 3** Fosfatado
- 4** Solo para bloque de cilindros n° 470130
- 1** I piston sono disponibili solo in kit motore
- 2** Comprende le guarnizioni
- 3** Fosfatato
- 4** Solo per monoblocco cilindri n° 470130

130.175							43
TID121B	6cyl.	11980cc	217-305kW (295-415PS)	Diesel	Turbo Intercooled	MP26267	
TID121KG	6cyl.	11980cc	217-305kW (295-415PS)	Diesel	Turbo Intercooled	MP36267	
TID121KP	6cyl.	11980cc	217-305kW (295-415PS)	Diesel	Turbo Intercooled	MP46267	
TID121LG	6cyl.	11980cc	217-305kW (295-415PS)	Diesel	Turbo Intercooled	MP6267	
TID121LP	6cyl.	11980cc	217-305kW (295-415PS)	Diesel	Turbo Intercooled	MP16267	
TID121P	6cyl.	11980cc	217-305kW (295-415PS)	Diesel	Turbo Intercooled	MP56267	
TWD121G	6cyl.	11980cc	217-305kW (295-415PS)	Diesel	Turbo Intercooled	MP66267	
TRUCK & BUS							

		<p>14-456000-00 WH B 144.00 C 311.00 D 157.60 E 10.52 F 0.76 15-457960-00 WH 1 2 B 143.89 C 311.00 D 157.62 E 10.55 F 0.86</p>	
--	--	---	--





15-458840-00 WH ② **B 143.85 C 313.25 D 157.62 E 10.52 F 3.25**

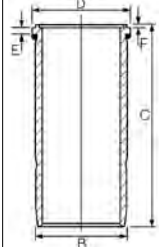

- ① For cylinder block no.470130 only ① Nur für Zylinderblock-Nr.470130 ① Pour le bloc-cylindres n° 470130 uniquement ① Solo para bloque de cilindros n° 470130 ① Solo per monoblocco cilindri n° 470130
- ② Includes seals ② Schließt Dichtungen ein ② Inclut des joints ② Incluye los sellos ② Comprende le guarnizioni

	131.00					44	
D12 (Euro 2)		6cyl.	12100cc	250-279kW (340-380PS)	Diesel	Turbo Intercooled	MP8973
TRUCK & BUS							

87-123200-00 STD

A 87.22
B- 17.10
BØ 88.95
D 137.45
 55x107

RT TP

08-123200-00 STD

4.00 CK P
3.00 P
4.00 NT ①

15-450160-00 WH ② **B 143.85 C 276.40 D 159.50 E 11.20 F 4.45**
14-450160-00 WH **B 143.85 C 276.40 D 159.50 E 11.20 F 4.45**

89-123200-30 ②
87-123200-00 +
15-450160-00

- ① Steel ① Stahl ① Acier ① Acero ① Acciaio
- ② Includes seals ② Schließt Dichtungen ein ② Inclut des joints ② Incluye los sellos ② Comprende le guarnizioni

	131.00					45	
D12A340 (Euro 2)		6cyl.	12100cc	250kW (340PS)	Diesel	Turbo Intercooled	TD11727
FH12			08/93→		FL12		09/95→09/98

87-123200-00 STD

A 87.22
B- 17.10
BØ 88.95
D 137.45
 55x107

RT TP

08-123200-00 STD

4.00 CK P
3.00 P
4.00 NT ①

87-123200-40 STD ③

A 87.40
B- 19.72
BØ 86.00
D 129.40
 55x107

AK NB TP

08-123200-00 STD

4.00 CK P
3.00 P
4.00 NT ①

15-450160-00 WH ② **B 143.85 C 276.40 D 159.50 E 11.20 F 4.45**
14-450160-00 WH **B 143.85 C 276.40 D 159.50 E 11.20 F 4.45**

89-123200-40 ②
87-123200-40 +
15-450160-00

- ① Steel ① Stahl ① Acier ① Acero ① Acciaio
- ② Includes seals ② Schließt Dichtungen ein ② Inclut des joints ② Incluye los sellos ② Comprende le guarnizioni
- ③ Articulated piston ③ Pendelschaftkolben ③ Piston articulé ③ Pistón articulado ③ Pistone articolato



131.00 **46**

D12A380 (Euro 2)	6cyl.	12100cc	279kW (380PS)	Diesel	Turbo Intercooled	TD9215
FH12			08/93→	NH12		01/98→09/03
FL12			09/95→09/98			

<p>87-123200-40 STD ①</p> <p>A 87.40 B- 19.72 BØ 86.00 D 129.40 55x107</p> <p>AK NB TP</p>	<p>08-123200-00 STD</p> <p>4.00 CK P 3.00 P 4.00 NT②</p>	<p>15-450160-00 WH ③ 14-450160-00 WH</p>	<p>B 143.85 C 276.40 D 159.50 E 11.20 F 4.45 B 143.85 C 276.40 D 159.50 E 11.20 F 4.45</p>	<p>89-123200-40 ③ 87-123200-40 + 15-450160-00</p>
<p>① Articulated piston ② Steel ③ Includes seals</p>	<p>① Pendelschaftkolben ② Stahl ③ Schließt Dichtungen ein</p>	<p>① Piston articulé ② Acier ③ Inclut des joints</p>	<p>① Pistón articulado ② Acero ③ Incluye los sellos</p>	<p>① Pistone articolato ② Acciaio ③ Comprende le guarnizioni</p>

131.00 **47**

D12A420 (Euro 2)	6cyl.	12100cc	309kW (420PS)	Diesel	Turbo Intercooled	TD9216
A			01/03→12/12	FL12		09/95→09/98
B12			01/92→	NH12		01/97→
FH12			08/93→			

<p>87-123200-00 STD</p> <p>A 87.22 B- 17.10 BØ 88.95 D 137.45 55x107</p> <p>RT TP</p>	<p>08-123200-00 STD</p> <p>4.00 CK P 3.00 P 4.00 NT①</p>	<p>15-450160-00 WH ③ 14-450160-00 WH</p>	<p>B 143.85 C 276.40 D 159.50 E 11.20 F 4.45 B 143.85 C 276.40 D 159.50 E 11.20 F 4.45</p>	<p>89-123200-40 ③ 87-123200-40 + 15-450160-00</p>
<p>① Steel ② Articulated piston ③ Includes seals</p>	<p>① Stahl ② Pendelschaftkolben ③ Schließt Dichtungen ein</p>	<p>① Acier ② Piston articulé ③ Inclut des joints</p>	<p>① Acero ② Pistón articulado ③ Incluye los sellos</p>	<p>① Acciaio ② Pistone articolato ③ Comprende le guarnizioni</p>

131.00 **48**

D12C340 (Euro 2)	6cyl.	12100cc	250kW (340PS)	Diesel	Turbo Intercooled	TD11731
D12C380	6cyl.	12100cc	279kW (380PS)	Diesel	Turbo Intercooled	TD11728
D12D340 (Euro 3)	6cyl.	12100cc	250kW (340PS)	Diesel	Turbo Intercooled	TD16784
DH12D340 (Euro 3)	6cyl.	12100cc	250kW (340PS)	Diesel	Turbo Intercooled	TD16511
8500			01/99→	FH12		08/93→
8700			01/99→	FM12		08/98→11/08
9700			04/01→	NH12		05/98→
B12			02/06→			





87-123200-10 STD ①

A 87.40
B- 17.21
BØ 89.00
D 125.70
 55x107



AK TP

08-123200-00 STD

4.00  CK P
 3.00  P
 4.00  NT②

15-450590-00 WH ③
14-450590-00 WH

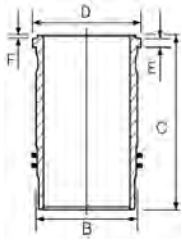

B 144.00 **C** 272.80 **D** 159.60 **E** 11.20 **F** 0.90
B 144.00 **C** 272.80 **D** 159.60 **E** 11.20 **F** 0.90

89-123200-10 ③
 87-123200-10 +
 15-450590-00

15-451270-00 WH ③ ④

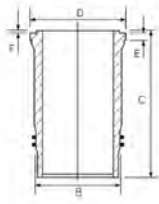

B 144.00 **C** 272.80 **D** 159.60 **E** 11.20 **F** 0.90

87-123200-40 STD ①

A 87.40
B- 19.72
BØ 86.00
D 129.40
 55x107



AK NB TP

08-123200-00 STD

4.00  CK P
 3.00  P
 4.00  NT②

- ① Articulated piston
- ② Steel
- ③ Includes seals
- ④ G0E322 cavitation resistant material
- ① Pendelschaftkolben
- ② Stahl
- ③ Schließt Dichtungen ein
- ④ G0E322 kavitationsbeständiges Material
- ① Piston articulé
- ② Acier
- ③ Inclut des joints
- ④ Matériau G0E322 résistant à la cavitation
- ① Pistón articulado
- ② Acero
- ③ Incluye los sellos
- ④ Material resistente a la cavitación G0E322
- ① Pistone articolato
- ② Acciaio
- ③ Comprende le guarnizioni
- ④ G0E322, materiale resistente alla cavitazione

131.00 **49**

D12C420	6cyl.	12100cc	309kW (420PS)	Diesel	Turbo Intercooled	TD11729
D12C460	6cyl.	12100cc	338kW (460PS)	Diesel	Turbo Intercooled	TD11730
D12D380 (Euro 3)	6cyl.	12100cc	279kW (379PS)	Diesel	Turbo Intercooled	TD16785
D12D420 (Euro 3)	6cyl.	12100cc	309kW (420PS)	Diesel	Turbo Intercooled	TD16786
D12D460 (Euro 3)	6cyl.	12100cc	338kW (460PS)	Diesel	Turbo Intercooled	TD16787
D12D500 (Euro 3)	6cyl.	12100cc	368kW (500PS)	Diesel	Turbo Intercooled	TD16508

A	01/03→12/12	FM12	08/98→11/08
B12	02/06→	NH12	01/97→
FH12	08/93→		

87-123200-00 STD

A 87.22
B- 17.10
BØ 88.95
D 137.45
 55x107



RT TP

08-123200-00 STD

4.00  CK P
 3.00  P
 4.00  NT①

15-450590-00 WH ②
14-450590-00 WH

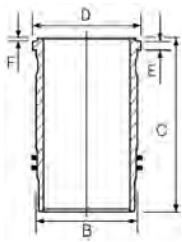

B 144.00 **C** 272.80 **D** 159.60 **E** 11.20 **F** 0.90
B 144.00 **C** 272.80 **D** 159.60 **E** 11.20 **F** 0.90

89-123200-35 ②
 87-123200-00 +
 15-450590-00





		<p>15-451270-00 WH ② ④ B 144.00 C 272.80 D 159.60 E 11.20 F 0.90</p>	
--	--	--	--

<p>87-123200-10 STD ③</p> <p>A 87.40 B- 17.21 BØ 89.00 D 125.70 55x107</p> <p>AK TP</p>	<p>08-123200-00 STD</p> <p>4.00 CK P 3.00 P 4.00 NT ①</p>	<p>15-450590-00 WH ② B 144.00 C 272.80 D 159.60 E 11.20 F 0.90 14-450590-00 WH B 144.00 C 272.80 D 159.60 E 11.20 F 0.90</p>	<p>89-123200-10 ② 87-123200-10 + 15-450590-00</p>
--	---	--	--

<p>87-123200-40 STD ③</p> <p>A 87.40 B- 19.72 BØ 86.00 D 129.40 55x107</p> <p>AK NB TP</p>	<p>08-123200-00 STD</p> <p>4.00 CK P 3.00 P 4.00 NT ①</p>		
---	---	--	--

- ① Steel
- ② Includes seals
- ③ Articulated piston
- ④ G0E322 cavitation resistant material
- ① Stahl
- ② Schließt Dichtungen ein
- ③ Pendelschaftkolben
- ④ G0E322 kavitationsbeständiges Material
- ① Acier
- ② Inclut des joints
- ③ Piston articulé
- ④ Matériau G0E322 résistant à la cavitation
- ① Accio
- ② Incluye los sellos
- ③ Pistón articulado
- ④ Material resistente a la cavitación G0E322
- ① Acciaio
- ② Comprende le guarnizioni
- ③ Pistone articolato
- ④ G0E322, materiale resistente alla cavitazione

131.00					50	
D12F390 (Euro 4)	6cyl.	12100cc	287kW (390PS)	Diesel	Turbo Intercooled	TD29191
D12F430 (Euro 4)	6cyl.	12100cc	316kW (430PS)	Diesel	Turbo Intercooled	TD29190
FH12		09/01 → 09/05				

<p>87-123200-50 STD ① ②</p> <p>A 87.40 B- 18.60 B- 6.10 BØ 89.00 D 129.40 55x107</p> <p>AK TP</p>	<p>08-123200-00 STD</p> <p>4.00 CK P 3.00 P 4.00 NT ③</p>	<p>15-450590-00 WH ④ B 144.00 C 272.80 D 159.60 E 11.20 F 0.90 14-450590-00 WH B 144.00 C 272.80 D 159.60 E 11.20 F 0.90</p>	
---	---	--	--





15-451270-00 WH 4 5 B 144.00 C 272.80 D 159.60 E 11.20 F 0.90

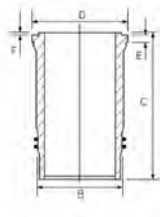

- 1 Articulated piston
- 2 Bowl capacity 96.300cm3
- 3 Steel
- 4 Includes seals
- 5 GOE322 cavitation resistant material

- 1 Pendelschaftkolben
- 2 Volumen der Kolbenmulde 96.300cm3
- 3 Stahl
- 4 Schließt Dichtungen ein
- 5 GOE322 kavitationsbeständiges Material

- 1 Piston articulé
- 2 Volume de la cavité du piston 96.300cm3
- 3 Acier
- 4 Inclut des joints
- 5 Matériau GOE322 résistant à la cavitation

- 1 Pistón articulado
- 2 Vol. cavidad pistón 96.300cm3
- 3 Acero
- 4 Incluye los sellos
- 5 Material resistente a la cavitación GOE322

- 1 Pistone articolato
- 2 Volume camera pistone 96.300cm3
- 3 Acciaio
- 4 Comprende le guarnizioni
- 5 GOE322, materiale resistente alla cavitazione

131.00						51
D13A360 (Euro 5)	6cyl.	12800cc	264kW (360PS)	Diesel	Turbo Intercooled	TD18826
D13A400 (Euro 5)	6cyl.	12800cc	294kW (400PS)	Diesel	Turbo Intercooled	TD18827
D13A440 (Euro 5)	6cyl.	12800cc	324kW (440PS)	Diesel	Turbo Intercooled	TD18828
D13A480 (Euro 5)	6cyl.	12800cc	353kW (480PS)	Diesel	Turbo Intercooled	TD18829
D13A520 (Euro 5)	6cyl.	12800cc	382kW (520PS)	Diesel	Turbo Intercooled	TD18830
FH			09/05→	FMX II		11/15→
FH II			09/12→	FMX III		02/20→
FM			09/05→	VNM		08/16→
FMX			04/10→			

87-434400-00 STD

- A** 84.15
- B-** 18.20
- BØ** 89.00
- D** 130.70
- 58x104



AK KK RT

08-434400-00 STD

- 3.50 PVD NT 1
- 2.50 CR
- 3.00 NT 1

15-451190-00 WH 2
14-451190-00 WH

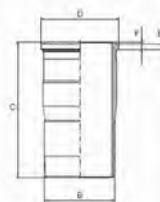

B 144.00 C 261.80 D 159.60 E 11.20 F 0.90
B 144.00 C 261.80 D 159.60 E 11.20 F 0.90

89-434400-00 2
87-434400-00 +
15-451190-00

- 1 Steel
- 2 Includes seals

- 1 Stahl
- 2 Schließt Dichtungen ein

- 1 Acier
- 2 Inclut des joints





- 1 Acero
- 2 Incluye los sellos

- 1 Acciaio
- 2 Comprende le guarnizioni

131.00						52
D13C380 (Euro 5)	6cyl.	12800cc	280-285kW (380-388PS)	Diesel	Turbo Intercooled	TD22378
D13C420 (Euro 5)	6cyl.	12800cc	309kW (420PS)	Diesel	Turbo Intercooled	TD22150
D13C460 (Euro 5)	6cyl.	12800cc	338-343kW (460-466PS)	Diesel	Turbo Intercooled	TD22151
D13C500 (Euro 5)	6cyl.	12800cc	368kW (500PS)	Diesel	Turbo Intercooled	TD22152
D13C540 (Euro 5)	6cyl.	12800cc	397kW (540PS)	Diesel	Turbo Intercooled	TD22153
9700			01/09→	FMX		04/10→
9900			01/09→	FMX II		09/13→
B13			01/09→	FMX III		02/20→
FH			09/05→	VA		08/16→
FH II			01/12→	VH		08/16→
FM			09/05→	VNL		08/16→
FM II			10/15→	VNM		08/16→





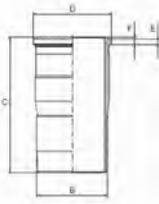



<p>87-434400-10 STD ①</p> <p>A 75.88 B- 18.10 BØ 89.00 D 112.90  58x76</p> <p>KK TP</p> 	<p>08-434400-00 STD</p> <p>3.50  PVD NT ② 2.50  CR 3.00  NT ②</p>	<p>15-451190-00 WH ③ 14-451190-00 WH</p> <p>B 144.00 C 261.80 D 159.60 E 11.20 F 0.90 B 144.00 C 261.80 D 159.60 E 11.20 F 0.90</p> 	<p>89-434400-10 ③ 87-434400-10 + 15-451190-00</p>
---	---	---	--





- ① MonoSteel®
- ② Steel
- ③ Includes seals
- ② Stahl
- ③ Schließt Dichtungen ein
- ② Acier
- ③ Inclut des joints
- ② Acero
- ③ Incluye los sellos
- ② Acciaio
- ③ Comprende le guarnizioni

131.00	53
D13H440 (Euro 5)	6cyl. 12800cc 324kW (440PS) Diesel Turbo Intercooled TD22154
FH	09/05→ FMX 04/10→

<p>87-434400-30 STD ①</p> <p>A 75.88 B- 19.60 BØ 92.00 C 1.00 D 112.90  58x76</p> <p>KK TP</p> 	<p>08-434400-00 STD</p> <p>3.50  PVD NT ② 2.50  CR 3.00  NT ②</p>		
---	---	--	--

- ① MonoSteel®
- ② Steel
- ② Stahl
- ② Acier
- ② Acero
- ② Acciaio

131.00	54
DH12D380 (Euro 3)	6cyl. 12100cc 280kW (380PS) Diesel Turbo Intercooled TD16512
8500	01/99→ 9700 04/01→
8700	01/99→

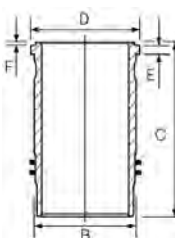
<p>87-123200-10 STD ①</p> <p>A 87.40 B- 17.21 BØ 89.00 D 125.70  55x107</p> <p>AK TP</p> 	<p>08-123200-00 STD</p> <p>4.00  CK P 3.00  P 4.00  NT ②</p>	<p>15-450590-00 WH ③ 14-450590-00 WH</p> <p>B 144.00 C 272.80 D 159.60 E 11.20 F 0.90 B 144.00 C 272.80 D 159.60 E 11.20 F 0.90</p> 	<p>89-123200-10 ③ 87-123200-10 + 15-450590-00</p>
--	--	---	--

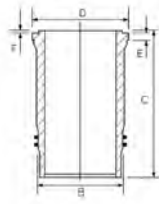
		<p>15-451270-00 WH ③ ④ B 144.00 C 272.80 D 159.60 E 11.20 F 0.90</p> 	
--	--	--	--

- ① Articulated piston
- ② Steel
- ③ Includes seals
- ④ G0E322 cavitation resistant material
- ① Pendelschaftkolben
- ② Stahl
- ③ Schließt Dichtungen ein
- ④ G0E322 kavitationsbeständiges Material
- ① Piston articulé
- ② Acier
- ③ Inclut des joints
- ④ Matériau G0E322 résistant à la cavitation
- ① Pistón articulado
- ② Acero
- ③ Incluye los sellos
- ④ Material resistente a la cavitación G0E322
- ① Pistone articolato
- ② Acciaio
- ③ Comprende le guarnizioni
- ④ G0E322, materiale resistente alla cavitazione



131.00 **55**



DH12D420 (Euro 3)	6cyl.	12100cc	309kW (420PS)	Diesel	Turbo Intercooled	TD16513
8500			01/97→	9700		04/01→
8700			01/97→	9900		10/01→

87-123200-10 STD ①

A 87.40
B- 17.21
BØ 89.00
D 125.70

 55x107

AK TP

08-123200-00 STD

4.00  CK P
 3.00  P
 4.00  NT②

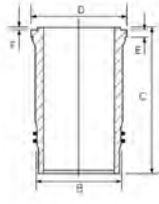
15-451270-00 WH ③ ④ **B** 144.00 **C** 272.80 **D** 159.60 **E** 11.20 **F** 0.90





89-123200-10 ③
 87-123200-10 +
 15-450590-00

87-123200-40 STD ①

A 87.40
B- 19.72
BØ 86.00
D 129.40

 55x107

AK NB TP

08-123200-00 STD

4.00  CK P
 3.00  P
 4.00  NT②

15-451270-00 WH ③ ④ **B** 144.00 **C** 272.80 **D** 159.60 **E** 11.20 **F** 0.90



89-123200-10 ③
 87-123200-10 +
 15-450590-00

- | | | | | |
|--|--|---|--|---|
| ① Articulated piston | ① Pendelschaftkolben | ① Piston articulé | ① Pistón articulado | ① Pistone articolato |
| ② Steel | ② Stahl | ② Acier | ② Acero | ② Acciaio |
| ③ Includes seals | ③ Schließt Dichtungen ein | ③ Inclut des joints | ③ Incluye los sellos | ③ Comprende le guarnizioni |
| ④ G0E322 cavitation resistant material | ④ G0E322 kavitationsbeständiges Material | ④ Matériau G0E322 résistant à la cavitation | ④ Material resistente a la cavitación G0E322 | ④ G0E322, materiale resistente alla cavitazione |

131.00 **56**

DH12E340	6cyl.	12100cc	250kW (340PS)	Diesel	Turbo Intercooled	TD22155
DH12E380 (Euro 4)	6cyl.	12100cc	280kW (380PS)	Diesel	Turbo Intercooled	TD22156
DH12E420 (Euro 4/5)	6cyl.	12100cc	309kW (420PS)	Diesel	Turbo Intercooled	TD22157
DH12E460 (Euro 4)	6cyl.	12100cc	338kW (460PS)	Diesel	Turbo Intercooled	TD22158



8700			01/99→	B12		02/06→
9700			04/01→	ELITE		01/09→
9900			10/01→			

87-123200-40 STD ①

A 87.40
B- 19.72
BØ 86.00
D 129.40

 55x107

AK NB TP

08-123200-00 STD

4.00  CK P
 3.00  P
 4.00  NT②

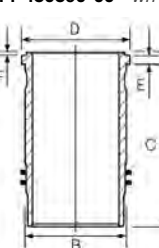
15-450590-00 WH ③ ④ **B** 144.00 **C** 272.80 **D** 159.60 **E** 11.20 **F** 0.90
14-450590-00 WH **B** 144.00 **C** 272.80 **D** 159.60 **E** 11.20 **F** 0.90



89-123200-10 ③
 87-123200-10 +
 15-450590-00





15-451270-00 WH ③ ④ B 144.00 C 272.80 D 159.60 E 11.20 F 0.90

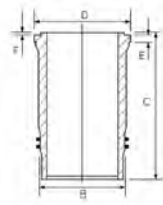

- ① Articulated piston
- ② Steel
- ③ Includes seals
- ④ G0E322 cavitation resistant material

- ① Pendelschaftkolben
- ② Stahl
- ③ Schließt Dichtungen ein
- ④ G0E322 kavitationsbeständiges Material

- ① Piston articulé
- ② Acier
- ③ Inclut des joints
- ④ Matériau G0E322 résistant à la cavitation

- ① Pistón articulado
- ② Acero
- ③ Incluye los sellos
- ④ Material resistente a la cavitación G0E322

- ① Pistone articolato
- ② Acciaio
- ③ Comprende le guarnizioni
- ④ G0E322, materiale resistente alla cavitazione

	144.00	57
D16A	6cyl. 16120cc 346-382kW (470-520PS)	Diesel Turbo Intercooled TD9217
D16A470 (Euro 2)	6cyl. 16120cc 346kW (470PS)	Diesel Turbo Intercooled TD17534
D16A520	6cyl. 16120cc 382kW (520PS)	Diesel Turbo Intercooled TD11767
D16B520	6cyl. 16120cc 382kW (520PS)	Diesel Turbo Intercooled TD11768

FH16	08/93→	VT	01/05→12/07
87-101100-10 STD	08-101100-00 STD	15-451030-00 WH ① 14-451030-00 WH	89-101100-10 ① 87-101100-10 + 15-451030-00
<p>A 110.50</p> <p>B- 28.70</p> <p>BØ 80.00</p> <p>C 1.65</p> <p>D 163.50</p> <p> 60x115</p> <p>HA KK NB RT TP</p>	<p>4.50</p> <p>3.50</p> <p>5.00</p> <p> MOL P</p> <p> P</p> <p> CR P</p>		
① Includes seals	① Schließt Dichtungen ein	① Inclut des joints	① Incluye los sellos
			① Comprende le guarnizioni

	144.00	58
TAD1630G	6cyl. 16120cc 360-440kW (490-598PS)	Diesel Turbo Intercooled MP56336
TAD1630GE	6cyl. 16120cc 360-440kW (490-598PS)	Diesel Turbo Intercooled MP56336-1
TAD1630P	6cyl. 16120cc 360-440kW (490-598PS)	Diesel Turbo Intercooled MP56336-2
TAD1631G	6cyl. 16120cc 430-585kW (537-730PS)	Diesel Turbo Intercooled MP46336
TWD1630G	6cyl. 16120cc 329-440kW (447-598PS)	Diesel Turbo Intercooled MP36336
TWD1630P	6cyl. 16120cc 329-440kW (447-598PS)	Diesel Turbo Intercooled MP36336-1

TRUCK & BUS			
87-101100-00 STD	08-101100-00 STD	15-451030-00 WH ① 14-451030-00 WH	89-101100-00 ① 87-101100-00 + 15-451030-00
<p>A 110.50</p> <p>B- 33.43</p> <p>BØ 88.00</p> <p>C 1.65</p> <p>D 163.50</p> <p> 60x115</p> <p>KK RT TP</p>	<p>4.50</p> <p>3.50</p> <p>5.00</p> <p> MOL P</p> <p> P</p> <p> CR P</p>		
① Includes seals	① Schließt Dichtungen ein	① Inclut des joints	① Incluye los sellos
			① Comprende le guarnizioni

	144.00	59
TD163ES	6cyl. 16120cc 368kW (500PS)	Diesel Turbo Intercooled TD9200





F16

01/87→12/95

15-451030-00 WH
14-451030-00 WH

B 158.95 **C** 315.00 **D** 171.95 **E** 13.09 **F** 2.00
B 158.95 **C** 315.00 **D** 171.95 **E** 13.09 **F** 2.00

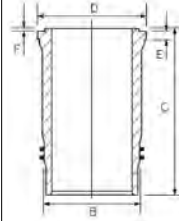

Includes seals

Schließt Dichtungen ein

Inclut des joints

Incluye los sellos

Comprende le guarnizioni

ENGINE INDEX

Motorverzeichnis • Index de moteur • Índice de Motor
 Indeks silnika • Модель Двигателя • دليل المحرك



CCM

x



9

1C	Diesel	1600	4	76.50	15
1G	Diesel	2383	6	76.50	15
1V	Diesel	1589	4	76.50	15
1X	Diesel	1896	4	79.50	20
1P	Petrol	1781	4	81.00	30
1S	Diesel	2383	6	76.50	16
1W	Diesel	1398	4	75.00	6
1Y	Diesel	1896	4	79.50	20
1Z	Diesel	1896	4	79.50	21
2E	Petrol	1984	4	82.50	50
2H	Petrol	1781	4	81.00	30
2L	Diesel	2446	4	92.00	57
3F	Petrol	1272	4	75.00	6
028.B	Diesel	1896	4	79.50	19
68A	Diesel	1588	4	76.50	15
68C	Diesel	1588	4	76.50	15
685	Diesel	1588	4	76.50	16
686	Diesel	1588	4	76.50	15
AAB	Diesel	2370	5	79.50	20
AAM	Petrol	1781	4	81.00	31
AAU	Petrol	1043	4	75.00	6
AAV	Petrol	1272	4	75.00	6
AAZ	Diesel	1896	4	79.50	22
ABF	Petrol	1984	4	82.50	51
ABL	Diesel	1896	4	79.50	22
ABS	Petrol	1781	4	81.00	30
ACC	Petrol	1781	4	81.00	31
ACL	Diesel	2383	6	76.50	15
ACT	Diesel	2383	6	76.50	16
ACV	Diesel	2461	5	81.00	45
ADD	Petrol	1781	4	81.00	31
ADE	Diesel	1896	4	79.50	22
ADF	Petrol	1781	4	81.00	31
ADG	Diesel	1896	4	79.50	20
ADK	Diesel	1588	4	76.50	16
ADP	Petrol	1595	4	81.00	32
ADR	Petrol	1781	4	81.00	33
ADY	Petrol	1984	4	82.50	50
ADZ	Petrol	1781	4	81.00	30
AEA	Petrol	1598	4	76.50	8
AEB	Petrol	1781	4	81.00	34
AEE	Petrol	1598	4	76.50	8
AEF	Diesel	1896	4	79.50	20
AEH	Petrol	1595	4	81.00	32
AEK	Petrol	1595	4	81.00	32
AEV	Petrol	1043	4	75.00	6
AEX	Petrol	1390	4	76.50	9
AEY	Diesel	1896	4	79.50	21
AFD	Diesel	1896	4	79.50	21
AFH	Petrol	1390	4	76.50	10
AFK	Petrol	1390	4	76.50	10
AFN	Diesel	1896	4	79.50	21
AFT	Petrol	1595	4	81.00	32
AFV	Petrol	1781	4	81.00	32
AGD	Diesel	1896	4	79.50	21
AGG	Petrol	1984	4	82.50	50
AGK	Diesel	2799	4	93.00	59
AGN	Petrol	1781	4	81.00	33
AGP	Diesel	1896	4	79.50	23
AGR	Diesel	1896	4	79.50	21



CCM

x



9

AGU	Petrol	1781	4	81.00	34
AGX	Diesel	2461	5	81.00	45
AHB	Diesel	1716	4	79.50	19
AHD	Diesel	2461	5	81.00	45
AHF	Diesel	1896	4	79.50	21
AHG	Diesel	1716	4	79.50	19
AHH	Diesel	1896	4	79.50	21
AHL	Petrol	1595	4	81.00	35
AHS	Petrol	1588	4	76.50	8
AHU	Diesel	1896	4	79.50	21
AHW	Petrol	1390	4	76.50	10
AHY	Diesel	2461	5	81.00	45
AJA	Diesel	2370	5	79.50	20
AJH	Petrol	1781	4	81.00	34
AJM	Diesel	1896	4	79.50	24
AJT	Diesel	2461	5	81.00	45
AKL	Petrol	1595	4	81.00	32
AKQ	Petrol	1390	4	76.50	10
AKR	Petrol	1984	4	82.50	50
AKS	Petrol	1595	4	81.00	32
AKU	Diesel	1716	4	79.50	19
AKV	Petrol	1390	4	76.50	9
AKW	Diesel	1716	4	79.50	19
ALE	Diesel	1896	4	79.50	21
ALH	Diesel	1896	4	79.50	21
ALM	Petrol	1598	4	76.50	8
ALZ	Petrol	1595	4	81.00	36
AMF	Diesel	1422	3	79.50	17
ANA	Petrol	1595	4	81.00	36
ANB	Petrol	1781	4	81.00	34
ANC	Diesel	1896	4	79.50	19
ANF	Diesel	2461	5	81.00	46
ANG	Diesel	2461	5	81.00	46
ANH	Diesel	2461	5	81.00	46
ANJ	Diesel	2461	5	81.00	45
ANN	Petrol	1781	4	81.00	31
ANU	Diesel	1896	4	79.50	25
ANX	Petrol	1390	4	76.50	9
APA	Diesel	2461	5	81.00	45
APE	Petrol	1390	4	76.50	10
APF	Petrol	1595	4	81.00	32
APH	Petrol	1781	4	81.00	34
APQ	Petrol	1390	4	76.50	9
APT	Petrol	1781	4	81.00	33
APU	Petrol	1781	4	81.00	34
AQA	Petrol	1781	4	81.00	34
AQM	Diesel	1896	4	79.50	23
AQQ	Petrol	1390	4	76.50	10
ARD	Diesel	1896	4	79.50	21
ARG	Petrol	1781	4	81.00	33
ARL	Diesel	1896	4	79.50	26
ARM	Petrol	1595	4	81.00	32
ARX	Petrol	1781	4	81.00	37
ARZ	Petrol	1781	4	81.00	34
ASV	Diesel	1896	4	79.50	21
ASX	Diesel	1896	4	79.50	23
ASY	Diesel	1896	4	79.50	23
ASZ	Diesel	1896	4	79.50	26
ATA	Diesel	2799	4	93.00	59
ATD	Diesel	1896	4	79.50	25

ENGINE INDEX

Motorverzeichnis • Index de moteur • Índice de Motor
 Indeks silnika • Модель Двигателя • دليل المحرك



CCM

x



9

ATJ	Diesel	1896	4	79.50	24
AUA	Petrol	1390	4	76.50	10
AUB	Petrol	1390	4	76.50	10
AUF	Diesel	2461	5	81.00	45
AUH	Diesel	2799	4	93.00	59
AUM	Petrol	1781	4	81.00	37
AUQ	Petrol	1781	4	81.00	37
AUR	Petrol	1595	4	81.00	32
AUY	Diesel	1896	4	79.50	24
AVB	Diesel	1896	4	79.50	25
AVC	Petrol	1781	4	81.00	34
AVF	Diesel	1896	4	79.50	26
AVG	Diesel	1896	4	79.50	21
AVM (Euro 3)	Diesel	1896	4	79.50	21
AVQ	Diesel	1896	4	79.50	25
AVR	Diesel	2461	5	81.00	47
AVU	Petrol	1595	4	81.00	36
AWC	Petrol	1781	4	81.00	34
AWD	Petrol	1781	4	81.00	34
AWH	Petrol	1595	4	81.00	32
AWM	Petrol	1781	4	81.00	37
AWP	Petrol	1781	4	81.00	37
AWT	Petrol	1781	4	81.00	37
AWU	Petrol	1781	4	81.00	37
AWV	Petrol	1781	4	81.00	37
AWX	Diesel	1896	4	79.50	26
AXB	Diesel	1896	4	79.50	27
AXC	Diesel	1896	4	79.50	27
AXD	Diesel	2461	5	81.00	48
AXE	Diesel	2461	5	81.00	48
AXG	Diesel	2461	5	81.00	45
AXL	Diesel	2461	5	81.00	45
AXP	Petrol	1390	4	76.50	10
AXR	Diesel	1896	4	79.50	25
AXW	Petrol	1984	4	82.50	52
AXX	Petrol	1984	4	82.50	53
AYC	Diesel	2461	5	81.00	45
AYD	Petrol	1595	4	81.00	36
AYQ	Diesel	1896	4	79.50	23
AYY	Diesel	2461	5	81.00	45
AZQ	Petrol	1198	3	76.50	7
AZV	Diesel	1968	4	81.00	38
BAC	Diesel	2461	5	81.00	48
BAY	Diesel	1422	3	79.50	17
BBE	Diesel	2461	5	81.00	45
BBF	Diesel	2461	5	81.00	45
BBR	Diesel	2461	5	81.00	47
BBY	Petrol	1390	4	76.50	10
BBZ	Petrol	1390	4	76.50	10
BCA	Petrol	1390	4	76.50	10
BCQ	Diesel	2799	4	93.00	59
BCT	Diesel	2461	5	81.00	46
BCU	Diesel	2461	5	81.00	46
BCV	Diesel	2461	5	81.00	46
BDJ	Diesel	1968	4	81.00	39
BDK	Diesel	1968	4	81.00	39
BEQ	Diesel	1896	4	79.50	21
BEU	Diesel	1896	4	79.50	21
BEW	Diesel	1896	4	79.50	25
BFQ	Petrol	1595	4	81.00	36



CCM

x



9

BFS	Petrol	1595	4	81.00	36
BGG	Diesel	1896	4	79.50	20
BGL	Diesel	1896	4	79.50	19
BGM (Euro 3)	Diesel	1896	4	79.50	19
BGU (Euro 4)	Petrol	1595	4	81.00	36
BGW	Diesel	1968	4	81.00	40
BHW	Diesel	1968	4	81.00	40
BJB	Diesel	1896	4	79.50	25
BJC	Diesel	1896	4	79.50	21
BJL	Diesel	2461	5	81.00	49
BJM	Diesel	2461	5	81.00	49
BJX	Petrol	1781	4	81.00	37
BKC	Diesel	1896	4	79.50	25
BKD	Diesel	1968	4	81.00	38
BKF	Petrol	1781	4	81.00	37
BKP	Diesel	1968	4	81.00	38
BKR	Petrol	1390	4	76.50	11
BKS	Diesel	2967	V6	83.00	56
BKY	Petrol	1390	4	76.50	11
BLG	Petrol	1390	4	76.50	12
BLJ	Diesel	2461	5	81.00	48
BLK	Diesel	2461	5	81.00	48
BLM	Petrol	1390	4	76.50	10
BLR	Petrol	1984	4	82.50	52
BLS	Diesel	1896	4	79.50	25
BLT	Diesel	1896	4	79.50	28
BLX	Petrol	1984	4	82.50	52
BLY	Petrol	1984	4	82.50	52
BMA	Diesel	1968	4	81.00	38
BME	Petrol	1198	3	76.50	7
BMK	Diesel	2967	V6	83.00	56
BMM	Diesel	1968	4	81.00	40
BMN	Diesel	1968	4	81.00	38
BMP	Diesel	1968	4	81.00	40
BMR	Diesel	1968	4	81.00	38
BMS	Diesel	1422	3	79.50	17
BMT	Diesel	1896	4	79.50	25
BMY	Petrol	1390	4	76.50	12
BNM	Diesel	1422	3	79.50	17
BNU	Petrol	1781	4	81.00	37
BNV	Diesel	1422	3	79.50	17
BPD	Diesel	2461	5	81.00	46
BPY	Petrol	1984	4	82.50	53
BRR	Diesel	1896	4	79.50	28
BRS	Diesel	1896	4	79.50	28
BRT	Diesel	1968	4	81.00	40
BRU	Diesel	1896	4	79.50	25
BSE (Euro 4/5)	Petrol	1595	4	81.00	36
BSF (Euro 2)	Petrol	1595	4	81.00	36
BST	Diesel	1968	4	81.00	39
BSU	Diesel	1896	4	79.50	25
BSW	Diesel	1896	4	79.50	25
BTW	Diesel	2461	5	81.00	46
BUD	Petrol	1390	4	76.50	11
BUK	Diesel	1896	4	79.50	26
BUN	Diesel	2967	V6	83.00	56
BUZ	Diesel	1968	4	81.00	38
BVD	Diesel	1968	4	81.00	38
BVE	Diesel	1968	4	81.00	38
BVH	Diesel	1968	4	81.00	40

ENGINE INDEX

Motorverzeichnis • Index de moteur • Índice de Motor
 Indeks silnika • Модель Двигателя • دليل المحرك



CCM

x



9

BVK	Diesel	1896	4	79.50	24
BVX	Petrol	1984	4	82.50	52
BVY	Petrol	1984	4	82.50	52
BVZ	Petrol	1984	4	82.50	52
BWA	Petrol	1984	4	82.50	53
BWB	Diesel	1422	3	79.50	17
BWK	Petrol	1390	4	76.50	12
BWV	Diesel	1968	4	81.00	38
BXE	Diesel	1896	4	79.50	25
BXF	Diesel	1896	4	79.50	25
BXJ	Diesel	1896	4	79.50	25
BXT	Diesel	1896	4	79.50	21
CAAA (Euro 5)	Diesel	1968	4	81.00	41
CAAB (Euro 5)	Diesel	1968	4	81.00	41
CAAC (Euro 5)	Diesel	1968	4	81.00	41
CAAD	Diesel	1968	4	81.00	41
CAAE	Diesel	1968	4	81.00	41
CAVA	Petrol	1390	4	76.50	12
CAVB	Petrol	1390	4	76.50	12
CAVC	Petrol	1390	4	76.50	12
CAVD	Petrol	1390	4	76.50	12
CAVE	Petrol	1390	4	76.50	12
CAWA	Petrol	1984	4	82.50	54
CAWB	Petrol	1984	4	82.50	54
CAXA (Euro 5)	Petrol	1390	4	76.50	13
CAYA	Diesel	1598	4	79.50	18
CAYB	Diesel	1598	4	79.50	18
CAYC	Diesel	1598	4	79.50	18
CAYD	Diesel	1598	4	79.50	18
CAYE	Diesel	1598	4	79.50	18
CBAA	Diesel	1968	4	81.00	41
CBAB	Diesel	1968	4	81.00	41
CBAC	Diesel	1968	4	81.00	41
CBBA	Diesel	1968	4	81.00	41
CBBB	Diesel	1968	4	81.00	41
CBDA	Diesel	1968	4	81.00	41
CBDB	Diesel	1968	4	81.00	41
CBDC	Diesel	1968	4	81.00	41
CBZA	Petrol	1197	4	71.00	1
CBZB	Petrol	1197	4	71.00	1
CCHA	Diesel	1968	4	81.00	41
CCHB	Diesel	1968	4	81.00	41
CCTA	Petrol	1984	4	82.50	54
CCZA	Petrol	1984	4	82.50	54
CCZB	Petrol	1984	4	82.50	54
CCZC	Petrol	1984	4	82.50	54
CCZD	Petrol	1984	4	82.50	54
CDA A	Petrol	1798	4	82.50	55
CDAB	Petrol	1798	4	82.50	55
CDBA	Diesel	1968	4	81.00	41
CDCA	Diesel	1968	4	81.00	41
CDDA	Petrol	1390	4	76.50	11
CDGA	Petrol	1390	4	76.50	12
CDXA	Diesel	1896	4	79.50	19
CDXB	Diesel	1896	4	79.50	19
CECA	Diesel	2461	5	81.00	49
CECB	Diesel	2461	5	81.00	49
CEGA	Diesel	1968	4	81.00	41
CFFA	Diesel	1968	4	81.00	42
CFFB	Diesel	1968	4	81.00	42



CCM

x



9

CFFD	Diesel	1968	4	81.00	42
CFFE	Diesel	1968	4	81.00	42
CFGB	Diesel	1968	4	81.00	42
CFGC	Diesel	1968	4	81.00	42
CFHB	Diesel	1968	4	81.00	42
CFHC	Diesel	1968	4	81.00	42
CFHE	Diesel	1968	4	81.00	42
CFHF	Diesel	1968	4	81.00	42
CFJA	Diesel	1968	4	81.00	42
CFJB	Diesel	1968	4	81.00	42
CFPA (Euro 4)	Petrol	1984	4	82.50	54
CFWA	Diesel	1199	3	79.50	18
CG	Diesel	2710	4	92.00	58
CGGA	Petrol	1390	4	76.50	11
CGGB	Petrol	1390	4	76.50	11
CHGA	Petrol	1595	4	81.00	36
CHYA (Euro 5/6)	Petrol	999	3	74.50	3
CHYB (Euro 5/6)	Petrol	999	3	74.50	3
CHYC (Euro 5/6)	Petrol	999	3	74.50	3
CJAA	Diesel	1968	4	81.00	41
CJKA	Petrol	1984	4	82.50	54
CJKB	Petrol	1984	4	82.50	54
CJZA	Petrol	1197	4	71.00	2
CJZB (Euro 5)	Petrol	1197	4	71.00	2
CJZC	Petrol	1197	4	71.00	2
CJZD	Petrol	1197	4	71.00	2
CK	Diesel	1471	4	76.50	14
CKFC (Euro 5)	Diesel	1968	4	81.00	43
CKTB	Diesel	1968	4	81.00	42
CKTC	Diesel	1968	4	81.00	42
CKUB	Diesel	1968	4	81.00	42
CKUC	Diesel	1968	4	81.00	42
CLCA	Diesel	1968	4	81.00	42
CLCB	Diesel	1968	4	81.00	42
CLHA (Euro 5)	Diesel	1598	4	79.50	29
CLHB (Euro 5)	Diesel	1598	4	79.50	29
CLJA	Diesel	1968	4	81.00	42
CLLA	Diesel	1968	4	81.00	42
CLNA	Diesel	1598	4	79.50	18
CLPA	Petrol	1390	4	76.50	11
CMBA (Euro 5)	Petrol	1395	4	74.50	4
CMSB (Euro 4)	Petrol	1390	4	76.50	13
CNEA	Diesel	1968	4	81.00	42
CNFA	Diesel	1968	4	81.00	42
CNFB	Diesel	1968	4	81.00	42
CNWA	Petrol	1390	4	76.50	12
CNWB	Petrol	1390	4	76.50	12
CP	Diesel	2383	6	76.50	16
CPGA	Petrol	999	3	74.50	3
CR	Diesel	1588	4	76.50	16
CRBC (Euro 5)	Diesel	1968	4	81.00	43
CRFD (Euro 5)	Diesel	1968	4	81.00	43
CRKA (Euro 6)	Diesel	1598	4	79.50	29
CRKB (Euro 5/6)	Diesel	1598	4	79.50	29
CRLB (Euro 6)	Diesel	1968	4	81.00	43
CRLD (Euro 6)	Diesel	1968	4	81.00	43
CRMB (Euro 6)	Diesel	1968	4	81.00	43
CRUA	Diesel	1968	4	81.00	43
CRVA (Euro 5)	Diesel	1968	4	81.00	43
CRVC (Euro 5)	Diesel	1968	4	81.00	43

ENGINE INDEX

Motorverzeichnis • Index de moteur • Índice de Motor
 Indeks silnika • Модель Двигателя • دليل المحرك



CCM

x



9

CS	Diesel	1588	4	76.50	16
CSHA	Diesel	1968	4	81.00	42
CSLA	Diesel	1968	4	81.00	42
CSLB	Diesel	1968	4	81.00	42
CSLC	Diesel	1968	4	81.00	42
CSNA	Diesel	1968	4	81.00	42
CTHA	Petrol	1390	4	76.50	12
CTHB	Petrol	1390	4	76.50	12
CTHC	Petrol	1390	4	76.50	12
CTHD	Petrol	1390	4	76.50	12
CTHE	Petrol	1390	4	76.50	12
CTKA	Petrol	1390	4	76.50	12
CUUA	Diesel	1968	4	81.00	43
CUUB	Diesel	1968	4	81.00	43
CUUD	Diesel	1968	4	81.00	43
CUUE	Diesel	1968	4	81.00	43
CUUF	Diesel	1968	4	81.00	43
CUVA (Euro 6)	Diesel	1968	4	81.00	43
CUVC (Euro 6)	Diesel	1968	4	81.00	43
CVCA	Diesel	1968	4	81.00	43
CWRA	Petrol	999	3	74.50	3
CXFA (Euro 6)	Diesel	1968	4	81.00	44
CXGA (Euro 6)	Diesel	1968	4	81.00	44
CXGB (Euro 6)	Diesel	1968	4	81.00	44
CXHA (Euro 6)	Diesel	1968	4	81.00	44
CXHB (Euro 6)	Diesel	1968	4	81.00	44
CXHC (Euro 6)	Diesel	1968	4	81.00	44
CXSA (Euro 5)	Petrol	1395	4	74.50	4
CXXA (Euro 6)	Diesel	1598	4	79.50	29
CXXB (Euro 6)	Diesel	1598	4	79.50	29
CY	Diesel	1588	4	76.50	15
CYVA (Euro 6)	Petrol	1197	4	71.00	2
CYVB	Petrol	1197	4	71.00	2
CYVC	Petrol	1197	4	71.00	2
CYVD	Petrol	1197	4	71.00	2
CZCA (Euro 6)	Petrol	1395	4	74.50	4
CZCB	Petrol	1395	4	74.50	4
DADA (Euro 6)	Petrol	1495	4	74.50	5
DASA	Diesel	1968	4	81.00	44
DASB	Diesel	1968	4	81.00	44
DASC (Euro 5)	Diesel	1968	4	81.00	44
DAUA	Diesel	1968	4	81.00	44
DAUB	Diesel	1968	4	81.00	44
DAVA	Diesel	1968	4	81.00	44
DAWA	Diesel	1968	4	81.00	44
DCXA	Diesel	1598	4	79.50	29
DCZA	Diesel	1598	4	79.50	29
DEJA (Euro 6)	Diesel	1968	4	81.00	43
DEJB (Euro 6)	Diesel	1968	4	81.00	43
DFLA (Euro 6)	Diesel	1968	4	81.00	43
DFSB	Diesel	1968	4	81.00	43
DFSC	Diesel	1968	4	81.00	43
DFSD	Diesel	1968	4	81.00	43
DFSE	Diesel	1968	4	81.00	43
DFSF	Diesel	1968	4	81.00	43
DHFA (Euro 6)	Petrol	1498	4	74.50	5
DPCA (Euro 6)	Petrol	1495	4	74.50	5
DS	Petrol	1781	4	81.00	30
DV	Diesel	2383	6	76.50	15
DW	Diesel	2383	6	76.50	16



CCM

x



9

DX	Petrol	1781	4	81.00	30
DZ	Petrol	1781	4	81.00	30
EV	Petrol	1781	4	81.00	30
EX	Petrol	1781	4	81.00	30
GK	Petrol	1272	4	75.00	6
GU	Petrol	1781	4	81.00	30
GX	Petrol	1781	4	81.00	30
GZ	Petrol	1781	4	81.00	30
HK	Petrol	1272	4	75.00	6
HT	Petrol	1781	4	81.00	30
HV	Petrol	1781	4	81.00	30
HZ	Petrol	1043	4	75.00	6
JH	Petrol	1781	4	81.00	30
JK	Diesel	1588	4	76.50	16
JN	Petrol	1781	4	81.00	31
JP	Diesel	1588	4	76.50	16
JR	Diesel	1588	4	76.50	15
JV	Petrol	1781	4	81.00	30
JX	Diesel	1589	4	76.50	15
KT	Petrol	1781	4	81.00	30
ME	Diesel	1588	4	76.50	16
MF	Diesel	1588	4	76.50	15
MN	Diesel	1272	4	75.00	6
NZ	Petrol	1272	4	75.00	6
PB	Petrol	1781	4	81.00	30
PF	Petrol	1781	4	81.00	30
RA	Diesel	1588	4	76.50	15
RH	Petrol	1781	4	81.00	30
RP	Petrol	1781	4	81.00	31
RV	Petrol	1781	4	81.00	30
SB	Diesel	1588	4	76.50	15
YJ	Petrol	1471	4	76.50	14
ZB	Petrol	1471	4	76.50	14
ZC	Petrol	1471	4	76.50	14



71.00 **1**

CBZA	4cyl.	1197cc	63kW (86PS)	Petrol	Turbo Intercooled	TD24312
CBZB	4cyl.	1197cc	77kW (105PS)	Petrol	Turbo Intercooled	TD23520
BEETLE 1.2 TSI			07/11→07/19	GOLF VAN VI 1.2 TSi		09/09→05/14
CADDY III Body/MPV 1.2 TSI			09/10→05/15	JETTA IV 1.2 TSI		10/10→12/17
CADDY III MPV 1.2 TSI			09/10→05/15	POLO 1.2 TSi BlueMotion		11/09→05/14
GOLF VI 1.2 TSI			11/08→05/16	POLO V 1.2 TSI		11/09→
GOLF VI 1.2 TSi			05/10→11/12	TOURAN 1.2 TSI		05/10→05/15
GOLF VI 1.2 TSi BlueMotion			05/09→11/12	TOURAN VAN 1.2 TSI		05/10→05/15
GOLF PLUS 1.2 TSi			11/09→08/14	VENTO 1.2 TSI		01/10→
GOLF PLUS V 1.2 TSI			11/09→12/13			

87-443900-10 STD

A 28.90
D 45.00
19x42

HA



08-443900-00 STD

1.00 NT
1.20 P
2.00 NT



Steel Stahl Acier Acero Acciaio

71.00 **2**

CJZA	4cyl.	1197cc	77kW (105PS)	Petrol	Turbo Intercooled	TD27189
CJZB (Euro 5)	4cyl.	1197cc	63kW (86PS)	Petrol	Turbo Intercooled	TD27190
CJZC	4cyl.	1197cc	66kW (90PS)	Petrol	Turbo Intercooled	TD29661
CJZD	4cyl.	1197cc	81kW (110PS)	Petrol	Turbo Intercooled	TD29571
CYVA (Euro 6)	4cyl.	1197cc	63kW (86PS)	Petrol	Turbo Intercooled	TD29246
CYVB	4cyl.	1197cc	81kW (110PS)	Petrol	Turbo Intercooled	TD29245
CYVC	4cyl.	1197cc	62kW (84PS)	Petrol	Turbo Intercooled	TD31237
CYVD	4cyl.	1197cc	77kW (105PS)	Petrol	Turbo Intercooled	TD31806

BEETLE 1.2 TSI 16V			12/14→07/19	GOLF VII 1.2 TSi BlueMotion		08/12→03/17
CADDY Body/MPV 1.2 TSI			06/15→	GOLF VAN VII 1.2 TSi BlueMotion		04/13→03/17
CADDY IV Body/MPV 1.2 TSI			06/15→09/20	JETTA IV 1.2 TSI 16V		08/14→12/17
CADDY IV MPV 1.2 TSI			06/15→09/20	POLO 1.2 TSI		01/14→
CADDY MPV 1.2 TSI			06/15→	POLO V 1.2 TSI		01/14→
GOLF VI 1.2 TSI 16V			11/13→05/16	POLO V 1.2 TSI 16V		02/14→10/17
GOLF VII 1.2 TSI			08/12→08/20	TOURAN 1.2 TSI		05/15→

87-442300-10 STD

A 28.00
B+ 0.70
C 3.52
C 3.52
D 44.50
17x49

(07124A101)
AK HA TP



08-442300-10 STD

1.20 NT
1.20 CR P
2.00 NT



Earlier pistons to be replaced in Engine sets only
Frühere Kolben nur in Motorsätzen zu ersetzen
Premier piston à remplacer dans le jeu moteur
Pistones más antiguos para ser reemplados en juego de motore solamente
Con i pistone di vecchia versione è necessario sostituire tu tta la serie

Elastoval
For Nüral OE piston
Steel

Für OE-Kolben von Nüral
Stahl

Pour les pistones d'origine Nüral
Acier

Para pistones originales Nüral
Acero

Per pistoni Nüral OE
Acciaio

74.50 **3**

CHYA (Euro 5/6)	3cyl.	999cc	44kW (60PS)	Petrol		TD26238
CHYB (Euro 5/6)	3cyl.	999cc	55kW (75PS)	Petrol		TD26239





CHYC (Euro 5/6)	3cyl.	999cc	48kW (65PS)	Petrol	TD34875
CPGA	3cyl.	999cc	50kW (68PS)	Petrol	TD27210
CWRA	3cyl.	999cc	55kW (75PS)	Petrol	TD31412
LOAD UP 1.0			12/14→08/20	POLO V 1.0	01/14→
LOAD UP 1.0 BlueMotion			05/16→11/19	POLO VI 1.0	06/17→08/21
POLO 1.0			01/14→	UP! 1.0	08/11→

87-443600-00 STD

- A 27.22
- B- 0.56
- BØ 58.07
- C 2.19
- D 42.22
-  17x39



08-443600-00 STD

- 1.00  NT
- 1.20  P
- 2.00  CR

TP

ECOTOUGH

- Steel
- Stahl
- Acier
- Acero
- Acciaio

74.50

4

CMBA (Euro 5)	4cyl.	1395cc	90kW (122PS)	Petrol	Turbo Intercooled	TD27191
CXSA (Euro 5)	4cyl.	1395cc	90kW (122PS)	Petrol	Turbo Intercooled	TD27193
CZCA (Euro 6)	4cyl.	1395cc	92kW (125PS)	Petrol	Turbo Intercooled	TD29248
CZCB	4cyl.	1395cc	92kW (125PS)	Petrol	Turbo Intercooled	TD31238
CADDY Body/MPV 1.4 TSI			05/15→	GOLF VAN VII 1.4 TSI BlueMotion		05/13→03/17
CADDY IV Body/MPV 1.4 TSI			05/15→09/20	JETTA IV 1.4 TSI		08/14→
CADDY IV MPV 1.4 TSI			05/15→09/20	PASSAT B8 1.4 TSI		11/14→
CADDY MPV 1.4 TSI			05/15→	POLO V 1.4 TSI		05/16→
GOLF VI 1.4 TSI			11/13→05/16	SCIROCCO III 1.4 TSI		11/13→11/17
GOLF VII 1.4 TSI			11/12→08/20	TIGUAN 1.4 TSI		01/16→
GOLF VII 1.4 TSI BlueMotion			05/13→03/17			

87-449500-00 STD

- A 31.00
- B- 1.25
- BØ 53.07
- C 2.90
- C 4.40
-  19x47



08-449500-00 STD

- 1.20  NT
- 1.20  CR P
- 2.00  NT

TP

- Steel
- Stahl
- Acier
- Acero
- Acciaio

74.50

5

DADA (Euro 6)	4cyl.	1495cc	110kW (150PS)	Petrol	Turbo Intercooled	TD34524
DHFA (Euro 6)	4cyl.	1498cc	96kW (131PS)	Petrol	Turbo Intercooled	TD37177
DPCA (Euro 6)	4cyl.	1495cc	110kW (150PS)	Petrol	Turbo Intercooled	TD38450
ARTEON 1.5 TSI			11/17→	PASSAT B8 1.5 TSI		08/18→
ARTEON SHOOTING BRAKE 1.5 TSI			08/20→	POLO VI 1.5 TSI		10/18→08/21
CADDY V Body/MPV 1.5 TGI CNG			06/22→	TAIGO 1.5 TSI		09/21→
CADDY V MPV 1.5 TGI CNG			06/22→	T-CROSS 1.5 TSI		01/20→
GOLF VII 1.5 TGI			11/18→08/20	TIGUAN 1.5 TSI		09/18→
GOLF VII 1.5 TSI			04/17→08/20	TOURAN 1.5 TSI		11/18→
GOLF VIII 1.5 TGI			09/20→	T-ROC 1.5 TSI		11/17→
GOLF VIII 1.5 TSI			07/19→			



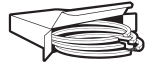



87-453500-00 STD





- A 30.80mm
- B- 5.00mm
- Bø 61.70mm
- C 2.30mm
- C 3.50mm
- D 48.90mm
-  19.00x50.00



08-453500-00 STD

- 1.20  PVD 
- 1.20mm  CR
- 2.00mm  NT 

RT TP

 Steel  Stahl  Acier  Acero  Acciaio

 **75.00** **6**

3F	4cyl.	1272cc	55-57kW (75-78PS)	Petrol	TD4968
AAU	4cyl.	1043cc	33kW (45PS)	Petrol	TD4971
AAV	4cyl.	1272cc	40kW (55PS)	Petrol	TD5159
AEV	4cyl.	1043cc	33kW (45PS)	Petrol	TD4021
GK	4cyl.	1272cc	55kW (75PS)	Petrol	TD4094
HK	4cyl.	1272cc	40kW (55PS)	Petrol	TD5011
HZ	4cyl.	1043cc	33-37kW (45-50PS)	Petrol	TD5012
NZ	4cyl.	1272cc	40kW (55PS)	Petrol	TD4136
1W	4cyl.	1398cc	35kW (48PS)	Diesel	TD4959
MN	4cyl.	1272cc	33kW (44PS)	Diesel	TD4132
DERBY 1.3			09/82→12/84	POLO CLASSIC 1.0	01/85→09/94
GOLF I 1.3			08/83→07/86	POLO CLASSIC 1.3	01/85→07/87
GOLF II 1.0			08/85→10/91	POLO CLASSIC 1.3 Cat	07/87→09/94
GOLF II 1.3			08/83→07/90	POLO CLASSIC 1.3 D	08/86→12/88
GOLF II 1.3 Cat			06/86→12/92	POLO CLASSIC 1.4 D	10/90→09/94
JETTA II 1.3			01/84→06/87	POLO II 1.0	08/85→01/92
JETTA II 1.3 Cat			06/87→12/91	POLO II 1.0 Cat	08/89→09/94
POLO 1.0			08/85→12/99	POLO II 1.3	09/82→08/94
POLO 1.0 Cat			08/89→09/94	POLO II 1.3 Cat	07/87→09/94
POLO 1.3			09/82→09/94	POLO II 1.3 D	08/86→07/90
POLO 1.3 Cat			07/87→09/94	POLO II 1.4 D	10/90→09/94
POLO 1.3 D			08/86→08/90	POLO III 45 1.0	10/94→09/96
POLO 1.4 D			08/90→09/94	SCIROCCO 1.3	08/83→07/84

14-025070-00 D **B 78.00 C 133.00 D 81.00 E 4.50**

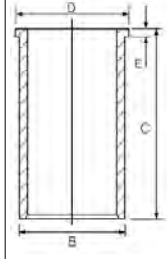

 **76.50** **7**

AZQ	3cyl.	1198cc	47kW (64PS)	Petrol	TD16333
BME	3cyl.	1198cc	47kW (64PS)	Petrol	TD18156
POLO 1.2 12V			10/01→07/07		





87-447800-00 STD
87-447807-00 0.50mm

A 29.27
B- 4.00
BØ 62.00
C 2.16
C 1.27
D 50.27
17x46



08-447800-00 STD
08-447807-00 0.50mm

1.20 NT 1
1.50 P
2.50 CR 1



14-021571-00 D B 79.56 C 142.00 D 82.50 E 4.50
14-028360-00 D 2 B 79.50 C 145.00 D 81.50 E 4.70

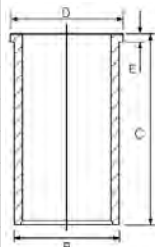

1 Steel
2 With recesses on crankshaft side

1 Stahl
2 Mit kurbelwellenseitigen Aussparungen

1 Acier
2 Avec évidements côté vilebrequin

1 Acero
2 Con escotaduras en la cara del cigüeñal
1 Acciaio
2 Con nicchie sul lato albero motore

76.50

8

AEA	4cyl.	1598cc	55kW (75PS)	Petrol	TD4019
AEE	4cyl.	1598cc	55kW (75PS)	Petrol	TD4981
AHS	4cyl.	1588cc	55kW (75PS)	Petrol	TD12948
ALM	4cyl.	1598cc	55kW (75PS)	Petrol	TD15610
CADDY II 1.6		06/96→12/00	POLO 1.6		05/97→09/01
CADDY II Body/MPV 75 1.6		11/95→09/00	POLO III 75 1.6		10/94→10/99
CADDY II MPV 1.6		06/97→09/00	POLO III CLASSIC 75 1.6		11/95→09/01
GOLF III 1.6		09/92→08/97	VENTO 1.6		09/92→09/98

14-021571-00 D B 79.56 C 142.00 D 82.50 E 4.50
14-028360-00 D 1 B 79.50 C 145.00 D 81.50 E 4.70

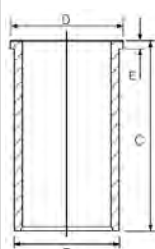

1 With recesses on crankshaft side

1 Mit kurbelwellenseitigen Aussparungen

1 Avec évidements côté vilebrequin

1 Con escotaduras en la cara del cigüeñal
1 Con nicchie sul lato albero motore

76.50

9

AEX	4cyl.	1390cc	40-44kW (54-60PS)	Petrol	TD4984
AKV	4cyl.	1390cc	44kW (60PS)	Petrol	TD9688
ANX	4cyl.	1390cc	40kW (54PS)	Petrol	TD15613
APQ	4cyl.	1390cc	44kW (60PS)	Petrol	TD15614
CADDY II Body/MPV 60 1.4		11/95→01/04	POLO III 60 1.4		07/95→10/99
CADDY II MPV 1.4		11/95→06/03	POLO III CLASSIC 54 1.4		01/98→08/99
GOLF III 1.4		08/91→04/99	POLO III CLASSIC 60 1.4		12/95→09/01
POLO 1.4		05/97→09/01	VENTO 1.4		11/91→09/98
POLO III 55 1.4		08/95→10/99			

87-502800-00 STD
87-502807-00 0.50mm 1

A 28.35
C 5.95
D 50.35
17x52



08-502800-00 STD
08-502807-00 0.50mm

1.20 NT 2
1.50 P
2.50 CR 2



14-021571-00 D B 79.56 C 142.00 D 82.50 E 4.50
14-028360-00 D 3 B 79.50 C 145.00 D 81.50 E 4.70

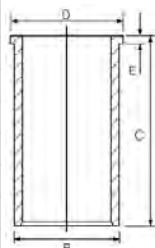

1 A = 28.100, D = 50.100
2 Steel
3 With recesses on crankshaft side

2 Stahl
3 Mit kurbelwellenseitigen Aussparungen

2 Acier
3 Avec évidements côté vilebrequin

2 Acero
3 Con escotaduras en la cara del cigüeñal
2 Acciaio
3 Con nicchie sul lato albero motore



76.50 **10**

AFH	4cyl.	1390cc	74kW (100PS)	Petrol	TD4986
AFK	4cyl.	1390cc	74kW (101PS)	Petrol	TD12028
AHW	4cyl.	1390cc	55kW (75PS)	Petrol	TD9453
AKQ	4cyl.	1390cc	55kW (75PS)	Petrol	TD9454
APE	4cyl.	1390cc	55kW (75PS)	Petrol	TD13468
AQQ	4cyl.	1390cc	74kW (101PS)	Petrol	TD13469
AUA	4cyl.	1390cc	55kW (75PS)	Petrol	TD13771
AUB	4cyl.	1390cc	74kW (101PS)	Petrol	TD13772
AXP	4cyl.	1390cc	55kW (75PS)	Petrol	TD15474
BBY	4cyl.	1390cc	55kW (75PS)	Petrol	TD16335
BBZ	4cyl.	1390cc	74kW (101PS)	Petrol	TD16540
BCA	4cyl.	1390cc	55kW (75PS)	Petrol	TD16386
BLM	4cyl.	1390cc	61kW (83PS)	Petrol	TD21076

BORA 1.4 16V	09/01→05/05	GOLF VAN IV 1.4	05/00→06/06
BORA I 1.4 16V	03/00→05/05	LUPO I 1.4 16V	09/98→07/05
CADDY II Body/MPV 1.4	08/00→01/04	NEW BEETLE 1.4	11/01→09/10
CADDY II MPV 1.4 16V	08/00→01/04	POLO 1.4	06/00→11/09
CADDY III Body/MPV 1.4	03/04→05/06	POLO 1.4 16V	10/99→05/08
CADDY III MPV 1.4	03/04→05/06	POLO III 100 1.4 16V	04/96→10/99
GOLF IV 1.4 16V	10/97→06/06	POLO III CLASSIC 75 1.4 16V	10/99→09/01
GOLF V 1.4 16V	10/03→05/06	POLO IV 1.4	11/02→04/12
GOLF PLUS V 1.4 16V	01/05→11/06		

87-116100-00 STD
87-116107-00 0.50mm

A 28.92
B- 1.98
BØ 61.90
C 2.32
D 49.92
 17x54

08-116100-00 STD
08-116107-00 0.50mm

1.20 NT
 1.50 P
 2.50 CR

A = 28.670, D = 49.670 Stahl Acier Acero Acciaio

76.50 **11**

BKR	4cyl.	1390cc	55kW (75PS)	Petrol	TD18271
BKY	4cyl.	1390cc	55kW (75PS)	Petrol	TD18154
BUD	4cyl.	1390cc	59-60kW (80-82PS)	Petrol	TD18909
CDDA	4cyl.	1390cc	63kW (86PS)	Petrol	TD25789
CGGA	4cyl.	1390cc	59kW (80PS)	Petrol	TD20791
CGGB	4cyl.	1390cc	63kW (85PS)	Petrol	TD23103
CLPA	4cyl.	1390cc	63kW (85PS)	Petrol	TD26336

CADDY III Body/MPV 1.4	05/06→08/10	POLO 1.4	05/06→05/14
CADDY III MPV 1.4	05/06→08/10	POLO 1.4 16V	10/01→11/09
FOX 1.4	04/05→12/09	POLO IV 1.4	11/02→04/12
GOLF V 1.4	06/07→07/09	POLO V 1.4	03/09→
GOLF V 1.4 16V	05/06→11/08	POLO VIVO 1.4	02/10→
GOLF VI 1.4	10/08→07/13	VENTO 1.4 16V	02/14→
GOLF PLUS V 1.4 16V	05/06→12/13		





87-436900-00 STD ①
87-436907-00 0.50mm ①
 04/05→

A 28.92
B- 2.28
BØ 61.14
C 1.07
C 1.04
D 46.92
 17x45

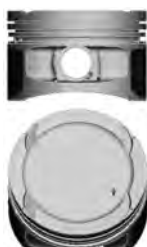

(07675-204)
TP

08-436900-00 STD
08-436907-00 0.50mm

1.20 NT ②
 1.20 P
 2.00 CR ②



ECOTOUGH

① Pistons to be replaced in Engine Sets only ① Kolben nur in Motorsätzen zu ersetzen ① Piston à remplacer dans jeu moteur ① Pistones de repuesto para juegos de motores solamente ① Il pistone può essere rimpiazzato solamente completo
 ② Steel ② Stahl ② Acier ② Acero ② Acciaio

76.50

12

BLG	4cyl.	1390cc	125kW (170PS)	Petrol	Turbo & Supercharged	TD18470
BMY	4cyl.	1390cc	103kW (140PS)	Petrol	Turbo & Supercharged	TD18910
BWK	4cyl.	1390cc	110kW (150PS)	Petrol	Turbo Intercooled	TD20734
CAVA	4cyl.	1390cc	110kW (150PS)	Petrol	Turbo & Supercharged	TD22452
CAVB	4cyl.	1390cc	125kW (170PS)	Petrol	Turbo Intercooled	TD22173
CAVC	4cyl.	1390cc	103kW (140PS)	Petrol	Turbo Intercooled	TD22174
CAVD	4cyl.	1390cc	118kW (160PS)	Petrol	Turbo & Supercharged	TD20792
CAVE	4cyl.	1390cc	132kW (180PS)	Petrol	Turbo & Supercharged	TD24000
CDGA	4cyl.	1390cc	110kW (150PS)	Petrol	Turbo & Supercharged	TD22222
CNWA	4cyl.	1390cc	118kW (160PS)	Petrol	Turbo & Supercharged	TD24834
CNWB	4cyl.	1390cc	110kW (150PS)	Petrol	Turbo & Supercharged	TD27017
CTHA	4cyl.	1390cc	110kW (150PS)	Petrol	Turbo & Supercharged	TD26573
CTHB	4cyl.	1390cc	125kW (170PS)	Petrol	Turbo Intercooled	TD26629
CTHC	4cyl.	1390cc	103kW (140PS)	Petrol	Turbo Intercooled	TD26643
CTHD	4cyl.	1390cc	118kW (160PS)	Petrol	Turbo & Supercharged	TD26574
CTHE	4cyl.	1390cc	132kW (180PS)	Petrol	Turbo & Supercharged	TD27355
CTKA	4cyl.	1390cc	118kW (160PS)	Petrol	Turbo & Supercharged	TD26695
BEETLE 1.4 TSI			10/11→07/16	PASSAT B7 1.4 TSI		08/10→12/14
CC B7 1.4 TSI			11/11→12/16	POLO 1.4 GTi		05/10→05/14
EOS 1.4 TSI			05/08→08/15	POLO V 1.4 GTi		05/10→
GOLF V 1.4 TSI			11/05→07/09	SCIROCCO 1.4 TSI		06/08→05/14
GOLF VI 1.4 TSI			10/08→05/16	SCIROCCO III 1.4 TSI		05/08→11/17
GOLF VI 1.4 TSI			10/08→11/12	SHARAN 1.4 TSI		05/10→
GOLF PLUS 1.4 TSI			01/09→09/12	SHARAN VAN 1.4 TSI		05/10→11/15
GOLF PLUS V 1.4 TSI			05/06→12/13	TIGUAN 1.4 TSI		09/07→07/18
GOLF VAN VI 1.4 TSI			07/09→10/12	TIGUAN VAN 1.4 TSI		05/08→07/18
JETTA III 1.4 TSI			07/06→10/10	TOURAN 1.4 TSI		02/06→05/15
JETTA IV 1.4 TSI			04/11→	TOURAN VAN 1.4 TSI		05/10→05/15
PASSAT B6 1.4 TSI			01/09→11/10	TOURAN VAN 1.4 TSI		05/10→05/15





87-433900-10 STD ① ②
87-433907-10 0.50mm ① ②

A 29.00
B- 6.40
B+ 1.85
C 1.00
C 3.80
D 48.00
 19x54



08-433900-00 STD
08-433907-00 0.50mm

1.20  NT③
 1.50  P
 2.00  NT③

RT

① Pistons to be replaced in Engine Sets only ① Kolben nur in Motorsätzen zu ersetzen ① Piston à remplacer dans jeu moteur ① Pistones de repuesto para juegos de motores solamente ① Il pistone può essere rimpiazzato solamente completo
 ② Elastoval ② ③ Stahl ③ Acier ③ Acero ③ Acciaio

76.50 **13**

CAXA (Euro 5)	4cyl.	1390cc	90kW (122PS)	Petrol	Turbo Intercooled	TD20606
CMSB (Euro 4)	4cyl.	1390cc	90kW (122PS)	Petrol	Turbo Intercooled	TD25468
EOS 1.4 TSi			11/07→08/15	JETTA IV 1.4 TSi		05/11→
GOLF V 1.4 TSi			05/07→07/09	PASSAT B6 1.4 TSi		05/07→11/10
GOLF VI 1.4 TSi			10/08→05/16	PASSAT B7 1.4 TSi		08/10→12/14
GOLF VI TSi			10/08→11/12	PASSAT B7 1.4 TSi BlueMotion		08/10→12/14
GOLF PLUS 1.4 TSi			01/09→08/14	SCIROCCO 1.4 TSi		08/08→05/14
GOLF PLUS V 1.4 TSi			06/07→12/13	SCIROCCO III 1.4 TSi		08/08→11/17
GOLF VAN VI 1.4 TSi			07/09→05/14	TIGUAN 1.4 TSi		08/10→07/18
JETTA III 1.4 TSi			05/07→10/10	TIGUAN VAN 1.4 TSi		08/10→05/11

87-429900-00 STD ①
87-429907-00 0.50mm ①

A 29.20
B- 4.50
C 3.60
D 48.20
 19x52



08-429900-00 STD
08-429907-00 0.50mm

1.20  NT②
 1.20  P
 2.00  NT②

HA

① Elastoval ② ③ Stahl ③ Acier ③ Acero ③ Acciaio

76.50 **14**

YJ	4cyl.	1471cc	55kW (75PS)	Petrol	TD5033
ZB	4cyl.	1471cc	55kW (75PS)	Petrol	TD5037
ZC	4cyl.	1471cc	57-63kW (85PS)	Petrol	TD5141
CK	4cyl.	1471cc	37kW (50PS)	Diesel	TD4046
GOLF I 1.5 D			08/76→07/80	PASSAT B1 1.5 D	02/77→12/82
JETTA I 1.5 D			08/78→07/80	SCIROCCO 1.5	02/74→08/75
PASSAT B1 1.5			05/73→12/75		





- 14-023470-00 D ① B 79.50 C 142.00 D 82.50 E 4.70
- 14-024670-00 D B 79.50 C 145.00 D 81.50 E 4.70
- 14-028360-00 D ② B 79.50 C 145.00 D 81.50 E 4.70

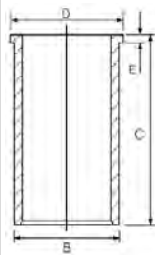

- ① Phosphated ① Phosphatiert ① Phosphaté ① Fosfatado ① Fosfatato
- ② With recesses on crankshaft side ② Mit kurbelwellenseitigen Aussparungen ② Avec évidements côté vilebrequin ② Con escotaduras en la cara del cigüeñal ② Con nicchie sul lato albero motore

76.50 **15**

1C	4cyl.	1600cc	51kW (69PS)	Diesel	Turbo	TD13489
1G	6cyl.	2383cc	68kW (93PS)	Diesel	Turbo	TD3993
1V	4cyl.	1589cc	44kW (60PS)	Diesel	Turbo	TD3996
68A	4cyl.	1588cc	45kW (61PS)	Diesel	Turbo	TD22615
68C	4cyl.	1588cc	50kW (68PS)	Diesel	Turbo	TD22616
686	4cyl.	1588cc	45kW (61PS)	Diesel		TD22614
ACL	6cyl.	2383cc	70kW (95PS)	Diesel	Turbo	TD4012
CY	4cyl.	1588cc	51kW (70PS)	Diesel	Turbo	TD4052
DV	6cyl.	2383cc	75-80kW (102-109PS)	Diesel	Turbo	TD4061
JR	4cyl.	1588cc	51kW (70PS)	Diesel	Turbo	TD4121
JX	4cyl.	1589cc	51kW (70PS)	Diesel	Turbo	TD5018
MF	4cyl.	1588cc	51kW (70PS)	Diesel	Turbo	TD4130
RA	4cyl.	1588cc	59kW (80PS)	Diesel	Turbo Intercooled	TD5024
SB	4cyl.	1588cc	59kW (80PS)	Diesel	Turbo Intercooled	TD5028

GOLF I 1.6 TD	03/82→07/85	LT 40-55 I 2.4 TD	08/78→06/96
GOLF II 1.6 TD	08/83→10/91	PASSAT B2 1.6 TD	04/82→03/88
ILTIS 1.6 TD	08/87→12/88	PASSAT B3/B4 1.6 TD	08/88→10/93
JETTA I 1.6 TD	03/82→02/84	SANTANA 1.6 TD	12/81→12/84
JETTA II 1.6 TD	01/84→10/91	SAVEIRO I 1.6 D	08/91→07/96
LT 28-35 I 2.4 TD	12/82→06/96	TRANSPORTER III 1.6 TD	08/84→07/92

- 87-109800-10 STD
- 87-109807-10 0.50mm ①
- 87-109811-10 1.00mm ①

- A 41.70
- B- 1.60
- D 71.70
- 24x64

AK HA RT TP



- 08-109800-00 STD
- 08-109807-00 0.50mm
- 08-109811-00 1.00mm

- 1.75 CR P
- 2.00 CR P
- 3.00 CR P

- 14-021571-00 D B 79.56 C 142.00 D 82.50 E 4.50
- 14-028360-00 D ② B 79.50 C 145.00 D 81.50 E 4.70

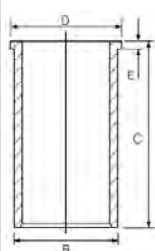

- ① A = 41.450 ① A = 41.450
- ② With recesses on crankshaft side ② Mit kurbelwellenseitigen Aussparungen ② Avec évidements côté vilebrequin ② Con escotaduras en la cara del cigüeñal ② Con nicchie sul lato albero motore

76.50 **16**

1S	6cyl.	2383cc	51kW (70PS)	Diesel		TD4958
685	4cyl.	1588cc	36kW (49PS)	Diesel		TD22613
ACT	6cyl.	2383cc	51kW (70PS)	Diesel		TD4014
ADK	4cyl.	1588cc	40kW (54PS)	Diesel		TD22619
CP	6cyl.	2383cc	55kW (75PS)	Diesel		TD4047



CR	4cyl.	1588cc	39-40kW (52-54PS)	Diesel	TD4992
CS	4cyl.	1588cc	37kW (50PS)	Diesel	TD4048
DW	6cyl.	2383cc	55-57kW (75-78PS)	Diesel	TD4062
JK	4cyl.	1588cc	39-40kW (52-54PS)	Diesel	TD5013
JP	4cyl.	1588cc	40kW (54PS)	Diesel	TD4120
ME	4cyl.	1588cc	37-40kW (50-55PS)	Diesel	TD4129
CADDY I 1.6 D			08/82→07/92	LT 40-55 I 2.4 D	12/78→06/96
GOLF I 1.6 D			08/80→07/83	PASSAT B1 1.6 D	02/79→07/81
GOLF II 1.6 D			08/83→10/91	PASSAT B2 1.6 D	08/80→03/88
JETTA I 1.6 D			08/80→02/84	SANTANA 1.6 D	08/81→12/84
JETTA II 1.6 D			01/84→10/91	TRANSPORTER III 1.6 D	01/81→07/87
LT 28-35 I 2.4 D			12/78→06/96		

- 87-109500-00 STD ①
- 87-109505-00 0.25mm ①
- 87-109507-00 0.50mm ① ②
- 87-109511-00 1.00mm ① ②

- 08-109500-00 STD
- 08-109505-00 0.25mm
- 08-109507-00 0.50mm
- 08-109511-00 1.00mm

- 14-021571-00 D B 79.56 C 142.00 D 82.50 E 4.50
- 14-028360-00 D ③ B 79.50 C 145.00 D 81.50 E 4.70

A 41.70
B- 1.60
D 71.70
② 24x64
(07633)
RT



- 1.75 CR P
- 2.00 P
- 3.00 CR P

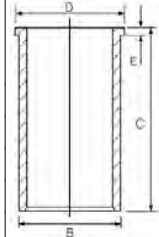

- ① No oil-jet cut out
- ① Ohne Aussparung für Kühllölspritzdüse
- ① Sans encoche en bas de jupe pour le passage de la pissette d 'huile sous pression
- ① Sin escotadura
- ① Senza passaggio per spruzzatore olio
- ② A = 41.450
- ③ With recesses on crankshaft side
- ③ Mit kurbelwellenseitigen Aussparungen
- ③ Avec évidements côté vilebrequin
- ③ Con escotaduras en la cara del cigüeñal
- ③ Con nicchie sul lato albero motore

79.50 **17**

AMF	3cyl.	1422cc	55kW (75PS)	Diesel	Turbo Intercooled	TD12589
BAY	3cyl.	1422cc	55kW (75PS)	Diesel	Turbo Intercooled	TD16336
BMS	3cyl.	1422cc	59kW (80PS)	Diesel	Turbo Intercooled	TD18157
BNM	3cyl.	1422cc	51kW (70PS)	Diesel	Turbo Intercooled	TD18159
BNV	3cyl.	1422cc	59kW (80PS)	Diesel	Turbo Intercooled	TD18158
BWB	3cyl.	1422cc	51kW (70PS)	Diesel	Turbo Intercooled	TD20514
FOX 1.4 TDI			04/05→12/09	POLO IV 1.4 TDI		07/03→06/05
LUPO I 1.4 TDI			01/99→07/05	POLO IV 1.4 TDi		01/03→12/07
POLO 1.4 TDI			10/99→11/09			

- 87-114900-80 STD ① ②
- 87-114907-80 0.50mm ①

- 08-114900-00 STD
- 08-114907-00 0.50mm
- 08-114911-00 1.00mm

- 14-027950-00 D B 82.50 C 152.00 D 85.50 E 4.70

A 45.80
B- 17.65
BØ 38.00
C 1.10
D 69.80
② 26x63
AK KK NB RT TP



- 1.75 CK P
- 2.00 P
- 3.00 CR P

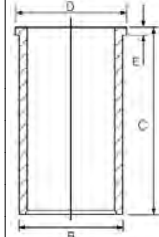



87-114900-85 STD ② ③
87-114907-85 0.50mm ③

A 45.80
B- 17.65
BØ 38.00
C 1.10
D 69.80
 26x63



AK KK NB RT TP

08-114900-00 STD
08-114907-00 0.50mm
08-114911-00 1.00mm

1.75  CK P
 2.00  P
 3.00  CR P

① To cylinder 1 & 2
 ② Bowl capacity 23.75cm³
 ③ To cylinder 3

① an Zylinder 1 & 2
 ② Volumen der Kolbenmulde 23.75cm³
 ③ an Zylinder 3

① sur cylindre 1 & 2
 ② Volume de la cavité du piston 23.75cm³
 ③ sur cylindre 3

① en el cilindro 1 & 2
 ② Vol. cavidad pistón 23.75cm³
 ③ en el cilindro 3

① a cilindro 1 & 2
 ② Volume camera pistone 23.75cm³
 ③ a cilindro 3

79.50

18

CAYA	4cyl.	1598cc	55kW (75PS)	Diesel	Turbo Intercooled	TD23105
CAYB	4cyl.	1598cc	66kW (90PS)	Diesel	Turbo Intercooled	TD22638
CAYC	4cyl.	1598cc	77kW (105PS)	Diesel	Turbo Intercooled	TD22639
CAYD	4cyl.	1598cc	75kW (102PS)	Diesel	Turbo Intercooled	TD24364
CAYE	4cyl.	1598cc	55kW (75PS)	Diesel	Turbo Intercooled	TD24365
CFWA	3cyl.	1199cc	55kW (75PS)	Diesel	Turbo Intercooled	TD23610
CLNA	4cyl.	1598cc	77kW (105PS)	Diesel	Turbo Intercooled	TD25704

BEETLE 1.6 TDI	10/11→07/16	JETTA III 1.6 TDI	06/09→10/10
CADDY Body/MPV 1.6 TDI	05/15→	JETTA IV 1.6 TDI	04/10→07/15
CADDY III Body/MPV 1.6 TDI	08/10→05/15	PASSAT B6 1.6 TDI	08/09→11/10
CADDY III MPV 1.6 TDI	08/10→05/15	PASSAT B7 1.6 TDI	08/10→12/14
CADDY IV Body/MPV 1.6 TDI	05/15→09/20	PASSAT B7 1.6 TDi BlueMotion	08/10→12/14
CADDY IV MPV 1.6 TDI	05/15→09/20	POLO 1.2 TDi BlueMotion	10/09→05/14
CADDY MPV 1.6 TDI	05/15→	POLO 1.6 TDi	06/09→05/14
GOLF VI 1.6 TDI	02/09→05/16	POLO 1.6 TDi BlueMotion	06/09→05/14
GOLF VI 1.6 TDi	02/09→11/12	POLO V 1.2 TDI	10/09→
GOLF VI 1.6 TDi BlueMotion	05/09→11/12	POLO V 1.6 TDI	06/09→
GOLF PLUS 1.6 TDi	02/09→08/14	TOURAN 1.6 TDI	05/10→05/15
GOLF PLUS V 1.6 TDI	02/09→12/13	TOURAN VAN 1.6 TDI	05/10→05/15
GOLF VAN VI 1.6 TDi	12/09→10/12	VENTO 1.6 TDI	07/10→08/14
GOLF VAN VI 1.6 TDi BlueMotion	07/09→05/14		

87-432900-00 STD ①
87-432905-00 0.25mm
87-432907-00 0.50mm

A 45.30
B- 10.70
B- 4.70
BØ 49.00
D 67.80
 26x66



(0790MA-104)
 KK RT TP

08-432900-00 STD
08-432905-00 0.25mm
08-432907-00 0.50mm

1.75  GDC P
 2.00  P
 3.00  CR P



① Bowl capacity 19.75cm³

① Volumen der Kolbenmulde 19.75cm³

① Volume de la cavité du piston 19.75cm³

① Vol. cavidad pistón 19.75cm³

① Volume camera pistone 19.75cm³

79.50

19

028.B	4cyl.	1896cc	43kW (58PS)	Diesel		TD22609
AHB	4cyl.	1716cc	42kW (57PS)	Diesel		TD15028
AHG	4cyl.	1716cc	42-44kW (57-60PS)	Diesel		TD11207
AKU	4cyl.	1716cc	44kW (60PS)	Diesel		TD9513
AKW	4cyl.	1716cc	42kW (57PS)	Diesel		TD9687





ANC	4cyl.	1896cc	44kW (60PS)	Diesel		TD20491
BGL	4cyl.	1896cc	37kW (50PS)	Diesel		TD25870
BGM (Euro 3)	4cyl.	1896cc	29kW (40PS)	Diesel		TD25871
CDXA	4cyl.	1896cc	55kW (75PS)	Diesel	Turbo	TD23291
CDXB	4cyl.	1896cc	29kW (40PS)	Diesel	Turbo	TD23292
CADDY II Body/MPV 1.7 SDI			07/96→09/00	POLO III 1.7 SDI		04/97→10/99
CADDY II MPV 1.7 SDI			07/96→09/00	POLO III 60 1.7 SDI		08/97→10/99
LUPO I 1.7 SDI			09/98→07/05	POLO III CLASSIC 57 1.7 SDI		07/97→09/01
POLO 1.7 SDI			08/97→09/01			

14-027950-00 D B 82.50 C 152.00 D 85.50 E 4.70

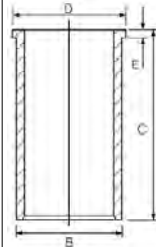

79.50 **20**

1X	4cyl.	1896cc	44-45kW (60-61PS)	Diesel		TD3997
1Y	4cyl.	1896cc	47-50kW (64-68PS)	Diesel		TD4960
AAB	5cyl.	2370cc	57kW (78PS)	Diesel		TD4000
ADG	4cyl.	1896cc	43kW (58PS)	Diesel		TD20098
AEF	4cyl.	1896cc	47kW (64PS)	Diesel		TD4020
AJA	5cyl.	2370cc	55kW (75PS)	Diesel		TD11049
BGG	4cyl.	1896cc	47kW (64PS)	Diesel		TD21349
CADDY Body/MPV 1.9 D			02/98→06/09	PASSAT B3/B4 1.9 D		05/89→10/93
CADDY II 1.9 D			06/96→12/00	POLO 1.9 D		10/99→09/01
CADDY II Body/MPV 1.9 D			11/95→01/04	POLO III 64 1.9 D		10/94→10/99
CADDY II MPV 1.9 D			11/95→01/04	POLO III CLASSIC 64 1.9 D		01/96→10/96
CADDY III MPV 1.9 D			10/05→06/09	SAVEIRO II 1.9 D		02/98→02/02
CADDY MPV 1.9 D			10/05→06/09	SAVEIRO III 1.9 D		07/02→09/05
GOLF III 1.9			08/93→02/99	TRANSPORTER IV 1.9 D		07/90→12/95
GOLF III 1.9 D			11/91→04/99	TRANSPORTER IV 2.4 D		07/90→04/03
GOL III 1.9 D			06/02→06/06	TRANSPORTER Passenger VAN 2.4 TDI		09/92→12/94
GOL IV 1.9 D			07/05→12/10	VENTO 1.9 D		11/91→09/98
PARATI III 1.9 D			08/02→	VOYAGE 1.9 D		06/96→09/01

14-027950-00 D B 82.50 C 152.00 D 85.50 E 4.70

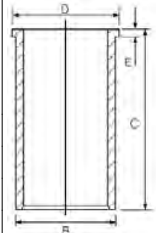

87-990100-40 STD
87-990105-40 0.25mm
87-990107-40 0.50mm
87-990111-40 1.00mm

A 39.65
B- 1.90
D 65.70
 24x64
(07945)
AK RT

08-990100-00 STD
08-990105-00 0.25mm
08-990107-00 0.50mm
08-990111-00 1.00mm

1.75 CR P
2.00 P
3.00 CR P

A = 39.400

79.50 **21**

1Z	4cyl.	1896cc	66kW (90PS)	Diesel	Turbo Intercooled	TD4961
AEY	4cyl.	1896cc	47-48kW (64-65PS)	Diesel		TD4985







AFD	4cyl.	1896cc	58kW (79PS)	Diesel	Turbo	TD16184
AFN	4cyl.	1896cc	81kW (110PS)	Diesel	Turbo Intercooled	TD4987
AGD	4cyl.	1896cc	47kW (64PS)	Diesel		TD9372
AGR	4cyl.	1896cc	66kW (90PS)	Diesel	Turbo Intercooled	TD9364
AHF	4cyl.	1896cc	81kW (110PS)	Diesel	Turbo Intercooled	TD9788
AHH	4cyl.	1896cc	66kW (90PS)	Diesel	Turbo Intercooled	TD10927
AHU	4cyl.	1896cc	66-67kW (90-91PS)	Diesel	Turbo Intercooled	TD4990
ALE	4cyl.	1896cc	66kW (90PS)	Diesel	Turbo Intercooled	TD9512
ALH	4cyl.	1896cc	66-67kW (90-91PS)	Diesel	Turbo Intercooled	TD9455
ARD	4cyl.	1896cc	44kW (60PS)	Diesel		TD20099
ASV	4cyl.	1896cc	81kW (110PS)	Diesel	Turbo Intercooled	TD13773
AVG	4cyl.	1896cc	81kW (110PS)	Diesel	Turbo Intercooled	TD14988
AVM (Euro 3)	4cyl.	1896cc	63kW (86PS)	Diesel	Turbo	TD18705
BEQ	4cyl.	1896cc	33kW (45PS)	Diesel		TD20100
BEU	4cyl.	1896cc	43kW (58PS)	Diesel	Turbo	TD20101
BJC	4cyl.	1896cc	53kW (72PS)	Diesel	Turbo Intercooled	TD22453
BXT	4cyl.	1896cc	30kW (41PS)	Diesel	Turbo	TD25869



BORA 1.9 TDI	05/99→05/05	POLO 1.9 SDI	05/96→09/01
BORA I 1.9 TDI	10/98→05/05	POLO 1.9 TDI	05/97→09/01
CADDY II Body/MPV 1.9 SDI	11/95→01/04	POLO III 64 1.9 SDI	07/96→10/99
CADDY II Body/MPV 1.9 TDI	09/96→01/04	POLO III CLASSIC 1.9 SDI	06/96→09/01
CADDY II MPV 1.9 SDI	11/95→01/04	POLO III CLASSIC 1.9 TDI	01/97→08/99
CADDY II MPV 1.9 TDI	10/96→01/04	POLO III CLASSIC 64 1.9 SDI	12/95→08/99
GOLF III 1.9 SDI	07/95→04/99	POLO III CLASSIC 90 1.9 TDI	09/96→09/01
GOLF III 1.9 TDI	08/91→12/99	POLO III CLASSIC 110 1.9 TDI	06/98→01/02
GOLF IV 1.9 TDI	08/97→05/06	SHARAN 1.9 TDI	09/95→03/10
GOLF VAN IV 1.9 TDI	05/99→05/06	SHARAN VAN 1.9 TDI	09/96→05/03
NEW BEETLE 1.9 TDI	01/98→06/04	Tremo	09/98→
PASSAT B3/B4 1.9 TDI	10/93→05/97	VENTO 1.9 SDI	04/97→09/98
PASSAT B5 1.9 TDI	10/96→11/00	VENTO 1.9 TDI	09/93→09/98
PASSAT B5 1.9 TDI/4motion	06/97→08/00	VOYAGE 1.9 TDI	09/99→09/01

87-114900-60 STD ① ②
87-114907-60 0.50mm ① ② ③

A 45.80
B- 17.65
BØ 38.00
C 1.10
D 68.80
 26x66
 (07987)
AK KK NB RT



08-114900-00 STD
08-114907-00 0.50mm
08-114911-00 1.00mm

1.75  CK P
 2.00  P
 3.00  CR P

14-027950-00 D **B 82.50 C 152.00 D 85.50 E 4.70**

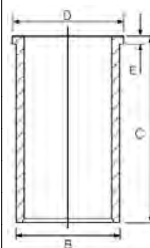



87-114900-70 STD ② ④
87-114907-70 0.50mm ② ③ ④

A 45.80
B- 17.65
BØ 38.00
C 1.10
D 68.80
 26x66
 (07987A)
AK KK NB RT



08-114900-00 STD
08-114907-00 0.50mm
08-114911-00 1.00mm

1.75  CK P
 2.00  P
 3.00  CR P



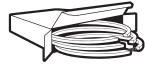

- 87-114900-90 STD ①
- 87-114907-90 0.50mm ① ⑤
- 87-114900-95 STD ④
- 87-114907-95 0.50mm ④ ⑤

- A 45.80
- B- 17.65
- BØ 38.00
- C 1.10
- D 71.80
- 26x66



AK NB RT

- 08-114900-00 STD
- 08-114907-00 0.50mm
- 08-114911-00 1.00mm

- 1.75 CK P
- 2.00 P
- 3.00 CR P

- ① To cylinder 1 & 2
- ② Bowl capacity 23.54cm3
- ③ A = 45.550, D = 68.550
- ④ To cylinder 3 & 4
- ⑤ A = 45.550, D = 71.550
- ① an Zylinder 1 & 2
- ② Volumen der Kolbenmulde 23.54cm3
- ④ an Zylinder 3 & 4
- ① sur cylindre 1 & 2
- ② Volume de la cavité du piston 23.54cm3
- ④ sur cylindre 3 & 4
- ① en el cilindro 1 & 2
- ② Vol. cavidad pistón 23.54cm3
- ④ en el cilindro 3 & 4
- ① a cilindro 1 & 2
- ② Volume camera pistone 23.54cm3
- ④ a cilindro 3 & 4

79.50 **22**

AAZ	4cyl.	1896cc	55kW (75PS)	Diesel	Turbo	TD4972
ABL	4cyl.	1896cc	50kW (68PS)	Diesel	Turbo	TD4009
ADE	4cyl.	1896cc	56kW (76PS)	Diesel	Turbo	TD20097

CALIFORNIA T4 Camper 1.9 TD	07/94→04/02	GOLF IV 1.9 TD	10/97→09/99
GOLF III 1.9 D	08/91→07/95	PASSAT B3/B4 1.9 TD	03/91→05/97
GOLF III 1.9 TD	07/93→04/99	TRANSPORTER IV 1.9 TD	10/92→04/03
GOLF III 1.9 TD, GTD	11/91→08/97	VENTO 1.9 TD	11/91→09/98

- 87-990100-10 STD
- 87-990107-10 0.50mm ①
- 87-990111-10 1.00mm ①

- A 45.65
- B- 1.90
- D 71.70
- 26x66



AK HA RT

- 08-990100-00 STD
- 08-990105-00 0.25mm
- 08-990107-00 0.50mm
- 08-990111-00 1.00mm

- 1.75 CR P
- 2.00 P
- 3.00 CR P

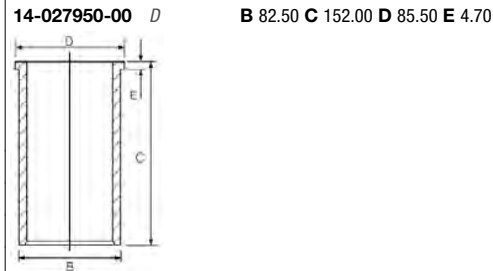

① A = 45.430

79.50 **23**

AGP	4cyl.	1896cc	50kW (68PS)	Diesel	TD9452
AQM	4cyl.	1896cc	50kW (68PS)	Diesel	TD11351
ASX	4cyl.	1896cc	47kW (64PS)	Diesel	TD15495
ASY	4cyl.	1896cc	47kW (64PS)	Diesel	TD16338
AYQ	4cyl.	1896cc	47kW (64PS)	Diesel	TD16863

BORA I 1.9 SDI	10/98→05/05	GOLF VAN IV 1.9 SDI	05/99→05/06
CADDY II Body/MPV 1.9 SDI	11/95→01/04	POLO 1.9 SDI	08/99→11/09
CADDY II MPV 1.9 SDI	11/95→01/04	POLO III CLASSIC 68 1.9 SDI	08/99→01/02
GOLF IV 1.9 SDI	08/97→06/06	POLO IV 1.9 SDI	09/02→04/12





87-114900-20 STD 1 2
87-114907-20 0.50mm 1 3

A 39.80
B- 17.75
BØ 38.00
C 1.00
D 60.80
 24x58
 (07959-109)



08-114900-00 STD
08-114907-00 0.50mm
08-114911-00 1.00mm

1.75 CK P
 2.00 P
 3.00 CR P

14-027950-00 D **B** 82.50 **C** 152.00 **D** 85.50 **E** 4.70

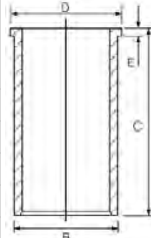

87-114900-30 STD 2 4
87-114907-30 0.50mm 3 4

A 39.80
B- 17.75
BØ 38.00
C 1.00
D 60.80
 24x58
 (07959A109)



08-114900-00 STD
08-114907-00 0.50mm
08-114911-00 1.00mm

1.75 CK P
 2.00 P
 3.00 CR P

- 1 To cylinder 1 & 2
- 2 Bowl capacity 23.60cm³
- 3 A = 39.550, D = 60.550
- 4 To cylinder 3 & 4

- 1 an Zylinder 1 & 2
- 2 Volumen der Kolbenmulde 23.60cm³
- 4 an Zylinder 3 & 4

- 1 sur cylindre 1 & 2
- 2 Volume de la cavité du piston 23.60cm³
- 4 sur cylindre 3 & 4

- 1 en el cilindro 1 & 2
- 2 Vol. cavidad pistón 23.60cm³
- 4 en el cilindro 3 & 4

- 1 a cilindro 1 & 2
- 2 Volume camera pistone 23.60cm³
- 4 a cilindro 3 & 4

79.50

24

AJM	4cyl.	1896cc	85kW (115PS)	Diesel	Turbo Intercooled	TD12588
ATJ	4cyl.	1896cc	85kW (115PS)	Diesel	Turbo Intercooled	TD16258
AUY	4cyl.	1896cc	85kW (115PS)	Diesel	Turbo Intercooled	TD14915
BVK	4cyl.	1896cc	85kW (115PS)	Diesel	Turbo Intercooled	TD20489

BORA 1.9 TDI	05/99→06/01	PASSAT B5 1.9 TDI	08/98→11/00
BORA I 1.9 TDI	12/98→01/02	SHARAN 1.9 TDI	03/00→03/10
GOLF IV 1.9 TDI	12/98→06/01	SHARAN VAN 1.9 TDI	04/00→03/10
GOLF VAN IV 1.9 TDI	05/99→04/02		

87-114900-05 STD 1 2
87-114907-05 0.50mm 1 2 3
 →09/02

A 45.80
B- 17.80
BØ 38.00
C 1.30
D 68.80
 26x66
 (07969L-101)



AK KK NB RT TP

08-114900-00 STD
08-114907-00 0.50mm
08-114911-00 1.00mm

1.75 CK P
 2.00 P
 3.00 CR P

14-027950-00 D **B** 82.50 **C** 152.00 **D** 85.50 **E** 4.70

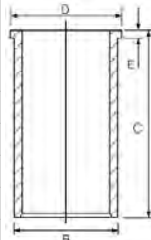



87-114900-15 STD ① ④
87-114907-15 0.50mm ① ③ ④
 →09/02

A 45.80
B- 17.80
BØ 38.00
C 1.30
D 68.80
 26x66



(07969L-102)

AK KK NB RT TP

08-114900-00 STD
08-114907-00 0.50mm
08-114911-00 1.00mm

1.75  CK P
 2.00  P
 3.00  CR P

87-114900-55 STD ② ⑤ ⑥
87-114907-55 0.50mm ② ③ ⑤
 09/02→

A 45.80
B- 17.60
BØ 38.00
C 1.10
D 68.80
 26x66



(07901D101)

AK KK NB RT TP

08-114900-00 STD
08-114907-00 0.50mm
08-114911-00 1.00mm

1.75  CK P
 2.00  P
 3.00  CR P

87-114900-56 STD ④ ⑤ ⑥
87-114907-56 0.50mm ③ ④ ⑤
 09/02→

A 45.80
B- 17.60
BØ 38.00
C 1.10
D 68.60
 26x66



(07901D102)

AK KK NB RT TP

08-114900-00 STD
08-114907-00 0.50mm
08-114911-00 1.00mm

1.75  CK P
 2.00  P
 3.00  CR P

① For side angled injection nozzle

① Nur für schräg angeordnete Einspritzdüsen

① Pour buse d'injection latérale angulaire

① Para la boquilla de inyección lateral angular

① Per il lato angolato dell'ugello olio

② To cylinder 1 & 2

② an Zylinder 1 & 2

② sur cylindre 1 & 2

② en el cilindro 1 & 2

② a cilindro 1 & 2

③ A = 45.550, D = 68.550

④ To cylinder 3 & 4

④ an Zylinder 3 & 4

④ sur cylindre 3 & 4

④ en el cilindro 3 & 4

④ a cilindro 3 & 4

⑤ For newer design straight injection nozzle

⑤ Für neuere Ausführungen, direkt einspritzende Düsen

⑤ Pour buse d'injection droite à conception plus récente

⑤ Para el más reciente diseño de boquilla de inyección directa

⑤ Per la più recente progettazione dell'ugello olio non angolato

⑥ Bowl capacity 23.60cm³

⑥ Volumen der Kolbenmulde 23.60cm³

⑥ Volume de la cavité du piston 23.60cm³

⑥ Vol. cavidad pistón 23.60cm³

⑥ Volume camera pistone 23.60cm³

 **79.50**

25

ANU	4cyl.	1896cc	66kW (90PS)	Diesel	Turbo Intercooled	TD13443
ATD	4cyl.	1896cc	74kW (101PS)	Diesel	Turbo Intercooled	TD15473
AVB	4cyl.	1896cc	74kW (101PS)	Diesel	Turbo Intercooled	TD15152
AVQ	4cyl.	1896cc	74kW (100PS)	Diesel	Turbo Intercooled	TD16861
AXR	4cyl.	1896cc	74kW (101PS)	Diesel	Turbo Intercooled	TD16337
BEW	4cyl.	1896cc	74kW (101PS)	Diesel	Turbo Intercooled	TD19255
BJB	4cyl.	1896cc	77kW (105PS)	Diesel	Turbo Intercooled	TD17078
BKC	4cyl.	1896cc	77kW (105PS)	Diesel	Turbo Intercooled	TD17079
BLS	4cyl.	1896cc	77kW (105PS)	Diesel	Turbo Intercooled	TD18224





BMT	4cyl.	1896cc	74kW (101PS)	Diesel	Turbo Intercooled	TD20494
BRU	4cyl.	1896cc	66kW (90PS)	Diesel	Turbo Intercooled	TD17468
BSU	4cyl.	1896cc	55kW (75PS)	Diesel	Turbo Intercooled	TD18755
BSW	4cyl.	1896cc	77kW (105PS)	Diesel	Turbo Intercooled	TD18771
BXE	4cyl.	1896cc	77kW (105PS)	Diesel	Turbo Intercooled	TD18908
BXF	4cyl.	1896cc	66kW (90PS)	Diesel	Turbo Intercooled	TD18907
BXJ	4cyl.	1896cc	66kW (90PS)	Diesel	Turbo Intercooled	TD20493

BORA 1.9 TDI	09/00→05/05	PASSAT B5 1.9 TDI	02/00→11/00
BORA I 1.9 TDI	09/00→05/05	PASSAT B5.5 1.9 TDI	11/00→05/05
CADDY III Body/MPV 1.9 TDI	04/04→08/10	PASSAT B6 1.9 TDI	03/05→11/10
CADDY III MPV 1.9 TDI	04/04→08/10	POLO 1.9 TDI	10/01→11/09
GOLF IV 1.9 TDI	09/00→06/06	POLO IV 1.9 TDI	09/02→
GOLF V 1.9 TDI	10/03→07/09	POLO IV 1.9 TDI	07/03→12/10
GOLF PLUS V 1.9 TDI	01/05→01/09	SHARAN 1.9 TDI	09/95→03/10
GOLF TDI	11/03→02/06	SHARAN VAN 1.9 TDI	09/96→05/03
GOLF VAN IV 1.9 TDI	02/00→06/06	TOURAN 1.9 TDI	02/03→05/10
JETTA III 1.9 TDI	08/05→10/10	TOURAN VAN 1.9 TDI	08/03→05/10
NEW BEETLE 1.9 TDI	02/01→09/10		

87-114900-65 STD ① ②
87-114907-65 0.50mm ① ③

A 45.80
B- 17.20
BØ 38.00
C 1.10
D 68.80
 26x66



(07901D-301)
AK KK NB RT TP

08-114900-00 STD
08-114907-00 0.50mm
08-114911-00 1.00mm

1.75  CK P
 2.00  P
 3.00  CR P

14-027950-00 D B 82.50 C 152.00 D 85.50 E 4.70

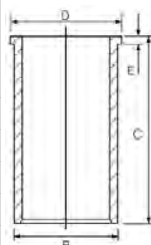

87-114900-66 STD ② ④
87-114907-66 0.50mm ③ ④

A 45.80
B- 17.20
BØ 38.00
C 1.10
D 68.80
 26x66



(07901D-302)
AK KK NB RT TP

08-114900-00 STD
08-114907-00 0.50mm
08-114911-00 1.00mm

1.75  CK P
 2.00  P
 3.00  CR P

- ① To cylinder 1 & 2
- ② Bowl capacity 22.85cm³
- ③ A = 45.550, D = 68.550
- ④ To cylinder 3 & 4

- ① an Zylinder 1 & 2
- ② Volumen der Kolbenmulde 22.85cm³
- ④ an Zylinder 3 & 4

- ① sur cylindre 1 & 2
- ② Volume de la cavité du piston 22.85cm³
- ④ sur cylindre 3 & 4

- ① en el cilindro 1 & 2
- ② Vol. cavidad pistón 22.85cm³
- ④ en el cilindro 3 & 4

- ① a cilindro 1 & 2
- ② Volume camera pistone 22.85cm³
- ④ a cilindro 3 & 4

79.50

26

ARL	4cyl.	1896cc	110kW (150PS)	Diesel	Turbo Intercooled	TD15484
ASZ	4cyl.	1896cc	96kW (130PS)	Diesel	Turbo Intercooled	TD16231
AVF	4cyl.	1896cc	96kW (130PS)	Diesel	Turbo Intercooled	TD15153
AWX	4cyl.	1896cc	96kW (130PS)	Diesel	Turbo Intercooled	TD15154
BUK	4cyl.	1896cc	118kW (160PS)	Diesel	Turbo Intercooled	TD29051

BORA 1.9 TDI	11/00→05/05	PASSAT B5.5 1.9 TDI	11/00→05/05
BORA I 1.9 TDI	05/00→05/05	POLO 1.9 TDI	11/03→11/09
GOLF IV 1.9 TDI	02/00→06/06	SHARAN 1.9 TDI	11/02→03/10
GOLF VAN IV 1.9 TDI	04/01→05/06	SHARAN VAN 1.9 TDI	11/02→05/03





87-114900-25 STD ① ②
87-114907-25 0.50mm ① ③
 →09/02

A 45.80
B- 17.90
BØ 38.00
C 1.10
D 68.80
 26x66
 (07969K101)
AK KK NB RT TP

08-114900-00 STD
08-114907-00 0.50mm
08-114911-00 1.00mm

1.75 CK P
 2.00 P
 3.00 CR P

14-027950-00 D
B 82.50 C 152.00 D 85.50 E 4.70

87-114900-35 STD ② ④
87-114907-35 0.50mm ③ ④
 →09/02

A 45.80
B- 17.90
BØ 38.00
C 1.10
D 68.80
 26x66
 (07969K102)
AK KK NB RT TP

08-114900-00 STD
08-114907-00 0.50mm
08-114911-00 1.00mm

1.75 CK P
 2.00 P
 3.00 CR P

87-114900-45 STD ① ⑤
87-114907-45 0.50mm ① ③
 09/02→

A 45.80
B- 17.50
BØ 38.00
C 1.10
D 68.80
 26x66
 (07901C105)
AK KK NB RT TP

08-114900-00 STD
08-114907-00 0.50mm
08-114911-00 1.00mm

1.75 CK P
 2.00 P
 3.00 CR P

87-114900-46 STD ④ ⑤
87-114907-46 0.50mm ③ ④
 09/02→

A 45.80
B- 17.50
BØ 38.00
C 1.10
D 68.80
 26x66
 (07901C106)
AK KK NB RT TP

08-114900-00 STD
08-114907-00 0.50mm
08-114911-00 1.00mm

1.75 CK P
 2.00 P
 3.00 CR P

① To cylinder 1 & 2
 ② Bowl capacity 24.60cm3
 ③ A = 45.550, D = 68.550
 ④ To cylinder 3 & 4
 ⑤ Bowl capacity 24.05cm3

① an Zylinder 1 & 2
 ② Volumen der Kolbenmulde 24.60cm3
 ④ an Zylinder 3 & 4
 ⑤ Volumen der Kolbenmulde 24.05cm3

① sur cylindre 1 & 2
 ② Volume de la cavité du piston 24.60cm3
 ④ sur cylindre 3 & 4
 ⑤ Volume de la cavité du piston 24.05cm3

① en el cilindro 1 & 2
 ② Vol. cavidad pistón 24.60cm3
 ④ en el cilindro 3 & 4
 ⑤ Vol. cavidad pistón 24.05cm3

① a cilindro 1 & 2
 ② Volume camera pistone 24.60cm3
 ④ a cilindro 3 & 4
 ⑤ Volume camera pistone 24.05cm3



79.50 **27**

AXB	4cyl.	1896cc	77kW (105PS)	Diesel	Turbo Intercooled	TD16867
------------	-------	---------------	---------------------	---------------	--------------------------	----------------

AXC	4cyl.	1896cc	63kW (85PS)	Diesel	Turbo Intercooled	TD16881
------------	-------	---------------	--------------------	---------------	--------------------------	----------------

CALIFORNIA T5 Camper 1.9 TDI	05/07→11/09	TRANSPORTER V 1.9 TDI	04/03→11/09
MULTIVAN V 1.9 TDI	04/03→11/09		

87-114900-45 STD ① ②
87-114907-45 0.50mm ① ③
 09/02→

A 45.80
B- 17.50
BØ 38.00
C 1.10
D 68.80
 26x66



(07901C105)
AK KK NB RT TP

08-114900-00 STD
08-114907-00 0.50mm
08-114911-00 1.00mm

1.75  CK P
 2.00  P
 3.00  CR P

14-027950-00 D **B 82.50 C 152.00 D 85.50 E 4.70**

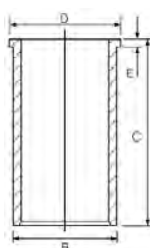

87-114900-46 STD ② ④
87-114907-46 0.50mm ③ ④
 09/02→

A 45.80
B- 17.50
BØ 38.00
C 1.10
D 68.80
 26x66



(07901C106)
AK KK NB RT TP

08-114900-00 STD
08-114907-00 0.50mm
08-114911-00 1.00mm

1.75  CK P
 2.00  P
 3.00  CR P

- ① To cylinder 1 & 2
- ② Bowl capacity 24.05cm³
- ③ A = 45.550, D = 68.550
- ④ To cylinder 3 & 4

- ① an Zylinder 1 & 2
- ② Volumen der Kolbenmulde 24.05cm³
- ④ an Zylinder 3 & 4

- ① sur cylindre 1 & 2
- ② Volume de la cavité du piston 24.05cm³
- ④ sur cylindre 3 & 4

- ① en el cilindro 1 & 2
- ② Vol. cavidad pistón 24.05cm³
- ④ en el cilindro 3 & 4

- ① a cilindro 1 & 2
- ② Volume camera pistone 24.05cm³
- ④ a cilindro 3 & 4

79.50 **28**

BLT	4cyl.	1896cc	96kW (130PS)	Diesel	Turbo Intercooled	TD17467
------------	-------	---------------	---------------------	---------------	--------------------------	----------------

BRR	4cyl.	1896cc	62kW (84PS)	Diesel	Turbo Intercooled	TD20159
------------	-------	---------------	--------------------	---------------	--------------------------	----------------

BRS	4cyl.	1896cc	75kW (102PS)	Diesel	Turbo Intercooled	TD18994
------------	-------	---------------	---------------------	---------------	--------------------------	----------------

CALIFORNIA T5 Camper 1.9 TDI	05/07→11/09	POLO 1.9 TDI	11/03→11/09
MULTIVAN V 1.9 TDI	01/06→11/09	TRANSPORTER V 1.9 TDI	01/06→11/09

87-114900-45 STD ① ②
87-114907-45 0.50mm ① ③

A 45.80
B- 17.50
BØ 38.00
C 1.10
D 68.80
 26x66

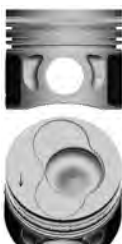

(07901C105)
AK KK NB RT TP

08-114900-00 STD
08-114907-00 0.50mm
08-114911-00 1.00mm

1.75  CK P
 2.00  P
 3.00  CR P

14-027950-00 D **B 82.50 C 152.00 D 85.50 E 4.70**

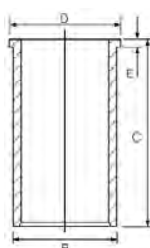



87-114900-46 STD ② ④
87-114907-46 0.50mm ③ ④

A 45.80
B- 17.50
BØ 38.00
C 1.10
D 68.80
 26x66



(07901C106)
AK KK NB RT TP

08-114900-00 STD
08-114907-00 0.50mm
08-114911-00 1.00mm

1.75  CK P
 2.00  P
 3.00  CR P

- ① To cylinder 1 & 2
- ② Bowl capacity 24.05cm³
- ③ A = 45.550, D = 68.550
- ④ To cylinder 3 & 4

- ① an Zylinder 1 & 2
- ② Volumen der Kolbenmulde 24.05cm³

- ① sur cylindre 1 & 2
- ② Volume de la cavité du piston 24.05cm³

- ① en el cilindro 1 & 2
- ② Vol. cavidad pistón 24.05cm³

- ① a cilindro 1 & 2
- ② Volume camera pistone 24.05cm³

- ④ an Zylinder 3 & 4

- ④ sur cylindre 3 & 4

- ④ en el cilindro 3 & 4

- ④ a cilindro 3 & 4

79.50 **29**

CLHA (Euro 5)	4cyl.	1598cc	77kW (105PS)	Diesel	Turbo Intercooled	TD27195
CLHB (Euro 5)	4cyl.	1598cc	66kW (90PS)	Diesel	Turbo Intercooled	TD27961
CRKA (Euro 6)	4cyl.	1598cc	66kW (90PS)	Diesel	Turbo Intercooled	TD27962
CRKB (Euro 5/6)	4cyl.	1598cc	81kW (110PS)	Diesel	Turbo Intercooled	TD27963
CXXA (Euro 6)	4cyl.	1598cc	66kW (90PS)	Diesel	Turbo Intercooled	TD28095
CXXB (Euro 6)	4cyl.	1598cc	81kW (110PS)	Diesel	Turbo Intercooled	TD28098
DCXA	4cyl.	1598cc	88kW (120PS)	Diesel	Turbo Intercooled	TD29841
DCZA	4cyl.	1598cc	88kW (120PS)	Diesel	Turbo Intercooled	TD32772

GOLF VII 1.6 TDI	08/12→07/18	PASSAT B8 1.6 TDI	08/14→
GOLF VII 1.6 TDi BlueMotion	08/12→03/17	TOURAN 1.6 TDI	05/15→05/16
GOLF VAN VII 1.6 TDi BlueMotion	05/13→03/17		

87-444100-00 STD
87-444105-00 0.25mm
87-444107-00 0.50mm

A 45.30
B- 11.00
BØ 49.00
D 68.30
 26x66



AK KK RT TP

08-444100-00 STD
08-444105-00 0.25mm
08-444107-00 0.50mm

1.75  GDC P
 2.00  P
 2.00  CR P



81.00 **30**

1P	4cyl.	1781cc	72kW (98PS)	Petrol	TD3995
2H	4cyl.	1781cc	72kW (98PS)	Petrol	TD4965
ABS	4cyl.	1781cc	63-66kW (86-90PS)	Petrol	TD4975
ADZ	4cyl.	1781cc	63-66kW (86-90PS)	Petrol	TD4980
DS	4cyl.	1781cc	66kW (90PS)	Petrol	TD4996
DX	4cyl.	1781cc	82kW (112PS)	Petrol	TD4063
DZ	4cyl.	1781cc	82kW (112PS)	Petrol	TD4998
EV	4cyl.	1781cc	82kW (112PS)	Petrol	TD4069
EX	4cyl.	1781cc	66kW (90PS)	Petrol	TD5000
GU	4cyl.	1781cc	66kW (90PS)	Petrol	TD5007
GX	4cyl.	1781cc	66kW (90PS)	Petrol	TD4100
GZ	4cyl.	1781cc	82kW (112PS)	Petrol	TD4102
HT	4cyl.	1781cc	74-77kW (100-104PS)	Petrol	TD4109





HV	4cyl.	1781cc	66kW (90PS)	Petrol	TD4111
JH	4cyl.	1781cc	66-75kW (90-102PS)	Petrol	TD4117
JV	4cyl.	1781cc	66kW (90PS)	Petrol	TD5017
KT	4cyl.	1781cc	82kW (112PS)	Petrol	TD4124
PB	4cyl.	1781cc	82kW (112PS)	Petrol	TD9367
PF	4cyl.	1781cc	75-79kW (102-107PS)	Petrol	TD4139
RH	4cyl.	1781cc	62kW (84PS)	Petrol	TD5026
RV	4cyl.	1781cc	75-77kW (102-105PS)	Petrol	TD4151

CADDY I 1.8	08/85→07/92	JETTA I 1.8	08/82→02/84
FOX 1.8	10/90→12/93	JETTA II 1.8	01/84→12/92
GOLF I 1.8	08/82→04/93	JETTA II 1.8 Cat	01/87→10/91
GOLF I 1.8 GTI	08/82→12/83	PASSAT B2 1.8	01/83→03/88
GOLF II 1.8	08/84→12/92	PASSAT B3/B4 1.8	02/88→05/97
GOLF II 1.8 GTI	08/83→10/91	POLO 1.8	01/95→09/01
GOLF II 1.8 GTI Cat	01/87→10/91	POLO III CLASSIC 90 1.8	01/97→09/01
GOLF II 1.8 i Cat	08/87→10/91	SANTANA 1.8	01/83→12/99
GOLF III 1.8	08/91→12/99	SCIROCCO 1.8	08/82→07/92
GOLF IV 1.8	06/98→06/02	VENTO 1.8	11/91→09/98

87-109400-50 STD ①
87-109407-50 0.50mm ① ②

A 32.20
B- 4.40
B0 55.70
B+ 1.30
D 62.50
 20x57



(08130E-101)

08-109400-10 STD
08-109407-10 0.50mm

1.50  PS P
 1.75  P
 3.00  CR P

① Pistons to be replaced in Engine Sets only ① Kolben nur in Motorsätzen zu ersetzen ① Piston à remplacer dans jeu moteur ① Pistones de repuesto para juegos de motores solamente ① Il pistone può essere rimpiazzato solamente completo

② A = 31.900, D = 62.200

81.00

31

AAM	4cyl.	1781cc	55kW (75PS)	Petrol	TD4004
ACC	4cyl.	1781cc	66-67kW (90-91PS)	Petrol	TD4011
ADD	4cyl.	1781cc	63-75kW (86-102PS)	Petrol	TD15496
ADF	4cyl.	1781cc	50kW (68PS)	Petrol	TD21353
ANN	4cyl.	1781cc	55kW (75PS)	Petrol	TD10847
JN	4cyl.	1781cc	66-76kW (90-103PS)	Petrol	TD5014
RP	4cyl.	1781cc	65-66kW (88-90PS)	Petrol	TD5027

FOX 1.8	09/86→12/90	JETTA II 1.8 Cat	08/87→10/91
GOLF II 1.8 i	08/87→07/91	PASSAT B2 1.8	01/83→03/88
GOLF II 1.8 i Cat	08/87→10/91	PASSAT B3/B4 1.8	02/88→05/97
GOLF III 1.8	08/91→04/99	POLO III CLASSIC 90 1.8	01/97→09/01
GOLF IV 1.8	06/98→06/02	SANTANA 1.8	09/83→12/85
JETTA II 1.8	08/87→12/88	VENTO 1.8	11/91→09/98

87-109700-10 STD
87-109705-10 0.25mm
87-109707-10 0.50mm

A 32.20
B- 8.10
B0 56.80
B+ 1.10
D 62.30
 20x54
 (08131-122)



08-109700-00 STD
08-109705-00 0.25mm
08-109707-00 0.50mm

1.50  CR P
 1.75  P
 3.00  CR P



81.00 **32**

ADP	4cyl.	1595cc	74kW (101PS)	Petrol	TD16253
AEH	4cyl.	1595cc	74kW (100PS)	Petrol	TD9450
AEK	4cyl.	1595cc	74kW (101PS)	Petrol	TD4982
AFT	4cyl.	1595cc	74kW (101PS)	Petrol	TD4988
AFV	4cyl.	1781cc	82kW (112PS)	Petrol	TD28049
AKL	4cyl.	1595cc	74-76kW (100-103PS)	Petrol	TD9451
AKS	4cyl.	1595cc	74kW (101PS)	Petrol	TD9991
APF	4cyl.	1595cc	74kW (101PS)	Petrol	TD12848
ARM	4cyl.	1595cc	74kW (101PS)	Petrol	TD16255
AUR	4cyl.	1595cc	74kW (101PS)	Petrol	TD15611
AWH	4cyl.	1595cc	74kW (101PS)	Petrol	TD15465

BORA 1.6	05/99→05/05	POLO 1.6	05/97→10/04
BORA I 1.6	10/98→05/05	POLO 1.8	01/99→12/03
GOLF III 1.6	07/94→04/99	POLO III CLASSIC 1.6	05/96→09/01
GOLF IV 1.6	08/97→05/04	POLO III CLASSIC 1.8	08/00→07/02
NEW BEETLE 1.6	10/99→09/00	POLO III CLASSIC 100 1.6	12/95→09/01
PASSAT B3/B4 1.6	07/94→08/96	VENTO 1.6	10/94→09/98
PASSAT B5 1.6	10/96→11/00		

87-105900-00 STD
87-105907-00 0.50mm ①

A 32.00
B- 2.30
BØ 61.40
B+ 0.70
D 53.70
 20x57

08-105900-00 STD
08-105907-00 0.50mm

1.20 NT ②
 1.50 P
 2.00 CR ②

① A = 31.700, D = 53.400
 ② Steel ② Stahl ② Acier ② Acero ② Acciaio

81.00 **33**

ADR	4cyl.	1781cc	92kW (125PS)	Petrol	TD5557
AGN	4cyl.	1781cc	92kW (125PS)	Petrol	TD9363
APT	4cyl.	1781cc	92kW (125PS)	Petrol	TD11497
ARG	4cyl.	1781cc	92kW (125PS)	Petrol	TD16237

BORA 1.8	05/99→05/05	PASSAT B5 1.8	10/96→11/00
BORA I 1.8	10/98→05/05	PASSAT B5 1.8/4motion	12/96→11/00
GOLF IV 1.8	08/97→06/06		

87-502900-00 STD ①
87-502907-00 0.50mm ① ②

A 32.55
C 3.60
D 56.55
 20x59
 (08192)
AK

08-502900-00 STD
08-502905-00 0.25mm
08-502907-00 0.50mm

1.50 CK P
 1.75 P
 2.00 CR P

① Conrod gap 27.50mm ① Pleuelaugenabstand 27.50mm ① Distance entre bielle 27.50mm ① Distancia del biela 27.50mm ① Distanza dalla bielle 27.50mm
 ② A = 32.250, D = 56.250

81.00 **34**

AEB	4cyl.	1781cc	110-112kW (150-152PS)	Petrol	Turbo Intercooled	TD5558
AGU	4cyl.	1781cc	110kW (150PS)	Petrol	Turbo Intercooled	TD9456





AJH	4cyl.	1781cc	110kW (150PS)	Petrol	Turbo Intercooled	TD10887
ANB	4cyl.	1781cc	110kW (150PS)	Petrol	Turbo Intercooled	TD16256
APH	4cyl.	1781cc	110kW (150PS)	Petrol	Turbo Intercooled	TD13441
APU	4cyl.	1781cc	110kW (150PS)	Petrol	Turbo Intercooled	TD16257
AQA	4cyl.	1781cc	110kW (150PS)	Petrol	Turbo Intercooled	TD22620
ARZ	4cyl.	1781cc	110kW (150PS)	Petrol	Turbo Intercooled	TD16385
AVC	4cyl.	1781cc	110kW (150PS)	Petrol	Turbo Intercooled	TD15467
AWC	4cyl.	1781cc	110kW (150PS)	Petrol	Turbo Intercooled	TD14914
AWD	4cyl.	1781cc	110kW (150PS)	Petrol	Turbo Intercooled	TD20628
BORA 1.8 T			05/00→05/05	NEW BEETLE 1.8 T		10/99→09/10
BORA II 1.8 T			05/00→05/05	PASSAT B5 1.8 T		10/96→11/00
GOLF IV 1.8 T			08/97→06/06	SHARAN 1.8 T 20V		09/97→03/10

87-502900-10 *STD*
 87-502905-10 0.25mm
 87-502907-10 0.50mm

08-502900-00 *STD*
 08-502905-00 0.25mm
 08-502907-00 0.50mm

A 32.70
B- 2.05
BØ 70.00
D 53.70
 20x59



1.50  CK P
 1.75  P
 2.00  CR P

AK

81.00

35

AHL	4cyl.	1595cc	74kW (101PS)	Petrol	TD5556
PASSAT B5 1.6			10/96→11/00		

87-105900-00 *STD*
 87-105907-00 0.50mm ¹
 →Eng.8D X 400 000

08-105900-00 *STD*
 08-105907-00 0.50mm

A 32.00
B- 2.30
BØ 61.40
B+ 0.70
D 53.70
 20x57



1.20  NT ²
 1.50  P
 2.00  CR ²

87-148300-00 *STD*
 87-148307-00 0.50mm
 Eng.8D X 400 001→

08-148300-00 *STD*
 08-148307-00 0.50mm

A 29.08
B- 2.70
BØ 62.30
D 50.70
 19x42



1.00  NT ²
 1.20  P
 2.00  CR P

TP

¹ A = 31.700, D = 53.400
² Steel

² Stahl

² Acier

² Acero

² Acciaio

81.00
36

ALZ	4cyl.	1595cc	75kW (102PS)	Petrol	TD15148
ANA	4cyl.	1595cc	74kW (101PS)	Petrol	TD16254
AVU	4cyl.	1595cc	75kW (102PS)	Petrol	TD15475
AYD	4cyl.	1595cc	75kW (102PS)	Petrol	TD15466
BFQ	4cyl.	1595cc	75kW (102PS)	Petrol	TD18137
BFS	4cyl.	1595cc	75kW (102PS)	Petrol	TD16743
BGU (Euro 4)	4cyl.	1595cc	75kW (102PS)	Petrol	TD17067
BSE (Euro 4/5)	4cyl.	1595cc	75kW (102PS)	Petrol	TD18222
BSF (Euro 2)	4cyl.	1595cc	75kW (102PS)	Petrol	TD18223
CHGA	4cyl.	1595cc	75kW (102PS)	Petrol	TD22180
BORA 1.6			08/00→05/05	GOLF PLUS V 1.6	05/05→12/13
BORA I 1.6			08/00→05/05	JETTA III 1.6	09/04→10/10
CADDY III Body/MPV 1.6			04/04→05/15	NEW BEETLE 1.6	06/00→09/10
CADDY III MPV 1.6			04/04→05/15	PASSAT B5 1.6	10/96→11/00
GOLF IV 1.6			08/00→06/06	PASSAT B5.5 1.6	11/00→05/05
GOLF V 1.6			01/04→07/09	PASSAT B6 1.6	05/05→11/10
GOLF VI 1.6			10/08→07/13	TOURAN 1.6	07/03→05/10

87-148300-00 STD
87-148307-00 0.50mm

A 29.08
B- 2.70
BØ 62.30
D 50.70
 19x42

08-148300-00 STD
08-148307-00 0.50mm

1.00 NT
1.20 P
2.00 CR P

 Steel

 Stahl

 Acier

 Acero

 Acciaio

81.00
37

ARX	4cyl.	1781cc	110kW (150PS)	Petrol	Turbo Intercooled	TD15485
AUM	4cyl.	1781cc	110kW (150PS)	Petrol	Turbo Intercooled	TD15486
AUQ	4cyl.	1781cc	132-142kW (179-193PS)	Petrol	Turbo Intercooled	TD16420
AWM	4cyl.	1781cc	125kW (170PS)	Petrol	Turbo Intercooled	TD16423
AWP	4cyl.	1781cc	132kW (179PS)	Petrol	Turbo Intercooled	TD19253
AWT	4cyl.	1781cc	110kW (150PS)	Petrol	Turbo Intercooled	TD15149
AWU	4cyl.	1781cc	110kW (150PS)	Petrol	Turbo Intercooled	TD15468
AWV	4cyl.	1781cc	110kW (150PS)	Petrol	Turbo Intercooled	TD15469
BJX	4cyl.	1781cc	110kW (150PS)	Petrol	Turbo Intercooled	TD18799
BKF	4cyl.	1781cc	110kW (150PS)	Petrol	Turbo Intercooled	TD21071
BNU	4cyl.	1781cc	132kW (180PS)	Petrol	Turbo Intercooled	TD21072
BORA 1.8 T			05/00→05/05	NEW BEETLE 1.8 T		10/99→09/10
BORA 1.8 Turbo			01/05→12/14	PASSAT B5.5 1.8		11/03→05/05
BORA I 1.8 T			05/00→05/05	PASSAT B5.5 1.8 T		02/01→11/05
GOLF IV 1.8 GTI			01/07→12/10	PASSAT B5.5 1.8 T 20V		11/00→05/05
GOLF IV 1.8 T			08/97→06/06	POLO 1.8 GTI		09/05→11/09
GOLF IV 1.8 T GTI			08/01→06/05			





87-502900-30 STD
87-502907-30 0.50mm

A 32.70
C 1.90
D 53.70
19x49

TP



08-502900-00 STD
08-502905-00 0.25mm
08-502907-00 0.50mm

1.50 CK P
1.75 P
2.00 CR P



81.00

38

AZV	4cyl.	1968cc	100kW (136PS)	Diesel	Turbo Intercooled	TD16862
BKD	4cyl.	1968cc	103kW (140PS)	Diesel	Turbo Intercooled	TD17080
BKP	4cyl.	1968cc	103kW (140PS)	Diesel	Turbo Intercooled	TD18135
BMA	4cyl.	1968cc	100kW (136PS)	Diesel	Turbo Intercooled	TD18225
BMN	4cyl.	1968cc	125kW (170PS)	Diesel	Turbo Intercooled	TD18471
BMR	4cyl.	1968cc	125kW (170PS)	Diesel	Turbo Intercooled	TD18188
BUZ	4cyl.	1968cc	120kW (163PS)	Diesel	Turbo Intercooled	TD20499
BVD	4cyl.	1968cc	90kW (122PS)	Diesel	Turbo Intercooled	TD18542
BVE	4cyl.	1968cc	90kW (122PS)	Diesel	Turbo Intercooled	TD18543
BWV	4cyl.	1968cc	88kW (120PS)	Diesel	Turbo Intercooled	TD20498

GOLF V 2.0 TDI	10/03→07/09	PASSAT B6 2.0 TDI	03/05→11/10
GOLF V 2.0 TDI 16V	10/03→07/09	PASSAT B6 2.0 TDI 16V	03/05→11/10
GOLF PLUS V 2.0 TDI	05/05→12/13	TOURAN 2.0 TDI	02/03→05/10
GOLF PLUS V 2.0 TDI 16V	01/05→12/13	TOURAN 2.0 TDI 16V	08/03→05/10
JETTA III 2.0 TDI	09/05→10/10	TOURAN VAN 2.0 TDI	02/03→05/10
JETTA III 2.0 TDI 16V	08/05→10/10	TOURAN VAN 2.0 TDi	08/03→05/10

87-139500-00 STD ①
87-139507-00 0.50mm ②

A 45.83
B- 17.80
BØ 38.00
D 68.80
26x66

(07901J)
AK KK NB RT TP



08-139500-00 STD
08-139507-00 0.50mm

1.75 CK P
2.00 P
3.00 CR P



① Bowl capacity 23.75cm³ ② Volumen der Kolbenmulde 23.75cm³ ③ Volume de la cavité du piston 23.75cm³ ④ Vol. cavidad pistón 23.75cm³ ⑤ Volume camera pistone 23.75cm³

81.00

39

BDJ	4cyl.	1968cc	51kW (70PS)	Diesel	TD17358
BDK	4cyl.	1968cc	55kW (75PS)	Diesel	TD17359
BST	4cyl.	1968cc	51kW (70PS)	Diesel	TD20501

CADDY III Body/MPV 2.0 SDI	03/04→08/10	GOLF V 2.0 SDI	01/04→11/08
CADDY III MPV 2.0 SDI	03/04→08/10		





87-139500-30 STD ① ②
87-139507-30 0.50mm ①

A 37.80
B- 17.35
BØ 38.00
C 0.70
D 58.80
 22x60

(08102-205)
AK RT TP



08-139500-00 STD
08-139507-00 0.50mm

1.75  CK P
 2.00  P
 3.00  CR P

87-139500-40 STD ② ③
87-139507-40 0.50mm ③

A 37.80
B- 17.35
BØ 38.00
C 0.70
D 58.80
 22x60

(08102-206)
AK RT TP



08-139500-00 STD
08-139507-00 0.50mm

1.75  CK P
 2.00  P
 3.00  CR P

① To cylinder 1 & 2
 ② Bowl capacity 24.50cm³
 ③ To cylinder 3 & 4

① an Zylinder 1 & 2
 ② Volumen der Kolbenmulde 24.50cm³
 ③ an Zylinder 3 & 4

① sur cylindre 1 & 2
 ② Volume de la cavité du piston 24.50cm³
 ③ sur cylindre 3 & 4

① en el cilindro 1 & 2
 ② Vol. cavidad pistón 24.50cm³
 ③ en el cilindro 3 & 4

① a cilindro 1 & 2
 ② Volume camera pistone 24.50cm³
 ③ a cilindro 3 & 4

81.00						40
BGW	4cyl.	1968cc	100kW (136PS)	Diesel	Turbo Intercooled	TD18539
BHW	4cyl.	1968cc	100kW (136PS)	Diesel	Turbo Intercooled	TD22177
BMM	4cyl.	1968cc	103kW (140PS)	Diesel	Turbo Intercooled	TD18482
BMP	4cyl.	1968cc	103kW (140PS)	Diesel	Turbo Intercooled	TD18136
BRT	4cyl.	1968cc	103kW (140PS)	Diesel	Turbo Intercooled	TD19105
BVH	4cyl.	1968cc	100kW (136PS)	Diesel	Turbo Intercooled	TD20520
CADDY III Body/MPV 2.0 TDI			09/07→08/10	PASSAT B5.5 2.0 TDI		12/03→05/05
CADDY III MPV 2.0 TDI			09/07→08/10	PASSAT B6 2.0 TDI		03/05→05/09
EOS 2.0 TDI			06/06→05/08	SHARAN 2.0 TDI		11/05→03/10
GOLF V 2.0 TDI			12/04→07/09	TOURAN 2.0 TDI		12/05→05/10
GOLF PLUS V 2.0 TDI			12/05→05/11	TOURAN VAN 2.0 TDi		12/05→05/10
JETTA III 2.0 TDI			10/05→10/10			

87-139500-10 STD ① ②
87-139507-10 0.50mm ① ③

A 45.83
B- 17.50
BØ 38.00
C 0.70
D 68.80
 26x66

(07901D833)
AK KK NB RT TP



08-139500-00 STD
08-139507-00 0.50mm

1.75  CK P
 2.00  P
 3.00  CR P





87-139500-20 STD ② ④
87-139507-20 0.50mm ③ ④

A 45.83
B- 17.50
BØ 38.00
C 0.70
D 68.80
 26x66



(07901D834)
AK KK NB RT TP

08-139500-00 STD
08-139507-00 0.50mm

1.75 CK P
 2.00 P
 3.00 CR P

- ① To cylinder 1 & 2 ① an Zylinder 1 & 2 ① sur cylindre 1 & 2 ① en el cilindro 1 & 2 ① a cilindro 1 & 2
- ② Bowl capacity 23.30cm³ ② Volumen der Kolbenmulde 23.30cm³ ② Volume de la cavité du piston 23.30cm³ ② Vol. cavidad pistón 23.30cm³ ② Volume camera pistone 23.30cm³
- ③ A = 45.550
- ④ To cylinder 3 & 4 ④ an Zylinder 3 & 4 ④ sur cylindre 3 & 4 ④ en el cilindro 3 & 4 ④ a cilindro 3 & 4

81.00							41
CAAA (Euro 5)	4cyl.	1968cc	62kW (84PS)	Diesel	Turbo Intercooled	TD23411	
CAAB (Euro 5)	4cyl.	1968cc	75kW (102PS)	Diesel	Turbo Intercooled	TD23412	
CAAC (Euro 5)	4cyl.	1968cc	103kW (140PS)	Diesel	Turbo Intercooled	TD23414	
CAAD	4cyl.	1968cc	84kW (114PS)	Diesel	Turbo Intercooled	TD26334	
CAAE	4cyl.	1968cc	100kW (136PS)	Diesel	Turbo Intercooled	TD24473	
CBAA	4cyl.	1968cc	100kW (136PS)	Diesel	Turbo Intercooled	TD20798	
CBAB	4cyl.	1968cc	103kW (140PS)	Diesel	Turbo Intercooled	TD20799	
CBAC	4cyl.	1968cc	105kW (143PS)	Diesel	Turbo Intercooled	TD20800	
CBBA	4cyl.	1968cc	120kW (163PS)	Diesel	Turbo Intercooled	TD21661	
CBBB	4cyl.	1968cc	125kW (170PS)	Diesel	Turbo Intercooled	TD20949	
CBDA	4cyl.	1968cc	100kW (136PS)	Diesel	Turbo Intercooled	TD22715	
CBDB	4cyl.	1968cc	103kW (140PS)	Diesel	Turbo Intercooled	TD21070	
CBDC	4cyl.	1968cc	81kW (110PS)	Diesel	Turbo Intercooled	TD21109	
CCHA	4cyl.	1968cc	103kW (140PS)	Diesel	Turbo Intercooled	TD24471	
CCHB	4cyl.	1968cc	100kW (136PS)	Diesel	Turbo Intercooled	TD24474	
CDBA	4cyl.	1968cc	90kW (122PS)	Diesel	Turbo Intercooled	TD24402	
CDCA	4cyl.	1968cc	120kW (163PS)	Diesel	Turbo Intercooled	TD24403	
CEGA	4cyl.	1968cc	125kW (170PS)	Diesel	Turbo Intercooled	TD24125	
CJAA	4cyl.	1968cc	103-104kW (140-141PS)	Diesel	Turbo Intercooled	TD23179	
AMAROK 2.0 BitDI		09/10→08/12		JETTA IV 2.0 TDI		02/11→	
AMAROK 2.0 TDI		09/10→10/13		MULTIVAN V 2.0 TDI		09/09→08/15	
BEETLE 2.0 TDI		04/11→07/16		MULTIVAN VI 2.0 TDI		04/15→12/19	
CALIFORNIA T5 Camper 2.0 TDI		09/09→08/15		PASSAT B6 2.0 BlueTDI		01/09→11/10	
CALIFORNIA T6 Camper 2.0 TDI		04/15→12/19		PASSAT B6 2.0 TDI		03/05→11/10	
EOS 2.0 TDI 16V		05/08→08/15		PASSAT B6 2.0 TDI 16V		03/05→11/10	
GOLF V 2.0 TDI		06/07→07/09		PASSAT CC B6 2.0 BlueTDI		05/09→11/10	
GOLF V 2.0 TDI 16V		06/07→07/09		PASSAT CC B6 2.0 TDI		05/08→01/12	
GOLF VI 2.0 TDI		10/08→07/13		SCIROCCO 2.0 TDi		08/08→05/14	
GOLF VI 2.0 TDi		09/09→11/12		SCIROCCO III 2.0 TDI		08/08→11/17	
GOLF PLUS V 2.0 TDI		05/05→12/13		TIGUAN 2.0 TDI		09/07→07/18	
GOLF PLUS V 2.0 TDI 16V		01/05→12/13		TIGUAN VAN 2.0 TDI		11/07→07/18	
GOLF VAN VI 2.0 TDI		07/09→05/14		TRANSPORTER V 2.0 TDI		09/09→08/15	
JETTA III 2.0 TDI		09/05→10/10		TRANSPORTER VI 2.0 TDI		04/15→12/19	
JETTA III 2.0 TDI 16V		08/05→10/10		TRANSPORTER VI / CARAVELLE VI 2.0 TDI		04/15→12/19	





87-432300-00 STD ①
87-432307-00 0.50mm ①

A 45.80
B- 12.70
BØ 50.88
D 68.80
26x66



(07901G202)
AK KK NB RT TP

08-432300-00 STD ②
08-432307-00 0.50mm

1.75 GDC P
2.00 P
3.00 CR P



① OE 03L 107 065G, Gen 1 engine only

① OE 03L 107 065G, nur für Motoren der Generation 1

① N°OE 03L 107 065G, uniquement pour Moteur de génération 1

① OE 03L 107 065G, Generación 1 solo motor

① Solo motore Generation 1

② 08-432300-00 OE: 03L198151A

81.00 **42**

CFFA	4cyl.	1968cc	100kW (136PS)	Diesel	Turbo Intercooled	TD23312
CFFB	4cyl.	1968cc	103kW (140PS)	Diesel	Turbo Intercooled	TD23178
CFFD	4cyl.	1968cc	81kW (110PS)	Diesel	Turbo Intercooled	TD24215
CFFE	4cyl.	1968cc	85kW (115PS)	Diesel	Turbo Intercooled	TD25739
CFGB	4cyl.	1968cc	125kW (170PS)	Diesel	Turbo Intercooled	TD23180
CFGC	4cyl.	1968cc	130kW (177PS)	Diesel	Turbo Intercooled	TD26990
CFHB	4cyl.	1968cc	100kW (136PS)	Diesel	Turbo Intercooled	TD24314
CFHC	4cyl.	1968cc	103kW (140PS)	Diesel	Turbo Intercooled	TD24315
CFHE	4cyl.	1968cc	62kW (85PS)	Diesel	Turbo Intercooled	TD25438
CFHF	4cyl.	1968cc	81kW (110PS)	Diesel	Turbo Intercooled	TD24366
CFJA	4cyl.	1968cc	125kW (170PS)	Diesel	Turbo Intercooled	TD24994
CFJB	4cyl.	1968cc	130kW (177PS)	Diesel	Turbo Intercooled	TD27973
CKTB	4cyl.	1968cc	80kW (109PS)	Diesel	Turbo Intercooled	TD25415
CKTC	4cyl.	1968cc	100kW (136PS)	Diesel	Turbo Intercooled	TD25416
CKUB	4cyl.	1968cc	120kW (163PS)	Diesel	Bi-Turbo Intercooled	TD25417
CKUC	4cyl.	1968cc	105kW (142PS)	Diesel	Turbo Intercooled	TD25418
CLCA	4cyl.	1968cc	81kW (110PS)	Diesel	Turbo Intercooled	TD24835
CLCB	4cyl.	1968cc	103kW (140PS)	Diesel	Turbo Intercooled	TD24600
CLJA	4cyl.	1968cc	103kW (140PS)	Diesel	Turbo Intercooled	TD24963
CLLA	4cyl.	1968cc	125kW (170PS)	Diesel	Turbo Intercooled	TD24441
CNEA	4cyl.	1968cc	132kW (180PS)	Diesel	Turbo Intercooled	TD26330
CNFA	4cyl.	1968cc	90kW (122PS)	Diesel	Turbo Intercooled	TD26995
CNFB	4cyl.	1968cc	103kW (140PS)	Diesel	Turbo Intercooled	TD26996
CSHA	4cyl.	1968cc	132kW (180PS)	Diesel	Turbo Intercooled	TD26331
CSLA	4cyl.	1968cc	80kW (109PS)	Diesel	Turbo Intercooled	TD33129
CSLB	4cyl.	1968cc	84kW (114PS)	Diesel	Turbo Intercooled	TD28424
CSLC	4cyl.	1968cc	103kW (140PS)	Diesel	Turbo Intercooled	TD32186
CSNA	4cyl.	1968cc	120kW (163PS)	Diesel	Bi-Turbo Intercooled	TD30982

AMAROK 2.0 BiTDI	09/11→	GOLF PLUS 2.0 TDI	11/09→08/14
AMAROK 2.0 TDI	09/10→	GOLF PLUS V 2.0 TDI	05/05→12/13
BEETLE 2.0 TDI	04/11→07/16	GOLF PLUS V 2.0 TDI 16V	01/05→12/13
CADDY Body/MPV 2.0 TDI	05/15→	GOLF VAN VI 2.0 TDI	07/09→05/14
CADDY III Body/MPV 2.0 TDI	08/10→05/15	JETTA IV 2.0 TDI	10/10→
CADDY III Body/MPV 2.0 TDI 16V	11/10→05/15	PASSAT B7 2.0 TDI	08/10→06/15
CADDY III MPV 2.0 TDI	08/10→05/15	PASSAT B7 2.0 TDI BlueMotion	08/10→12/14
CADDY III MPV 2.0 TDI 16V	11/10→05/15	PASSAT CC B6 2.0 TDI	06/08→01/12
CADDY IV Body/MPV 2.0 TDI	05/15→09/20	SCIROCCO 2.0 TDI	08/08→05/14
CADDY IV MPV 2.0 TDI	05/15→09/20	SCIROCCO III 2.0 TDI	08/08→11/17
CADDY MPV 2.0 TDI	05/15→	SHARAN 2.0 TDI	05/10→





CC B7 2.0 TDI	11/11→12/16	SHARAN VAN 2.0 TDI	05/10→11/15
CRAFTER 30-35 2.0 TDI	05/11→12/16	TIGUAN 2.0 TDI	09/07→07/18
CRAFTER 30-50 2.0 TDI	05/11→12/16	TIGUAN VAN 2.0 TDI	11/07→07/18
EOS 2.0 TDI	11/10→08/15	TOURAN 2.0 TDI	12/05→05/15
EOS 2.0 TDI 16V	05/08→08/15	TOURAN VAN 2.0 TDI	05/10→05/15
GOLF VI 2.0 TDI	10/08→05/16	TOURAN VAN 2.0 TDI	05/10→01/13
GOLF VI 2.0 TDI	09/09→11/12		

87-432300-10 STD ① ②

87-432307-10 0.50mm ① ②

A 45.80
B- 13.10
BØ 50.88
D 68.80
26x66



(07901G220)

AK KK NB RT TP

08-432300-10 STD ③ ④

08-432307-10 0.50mm ③ ④

1.75 GDC P
2.00 MO P
3.00 CR P



① OE 03L 107 065S, Gen 2 engine only

① OE 03L 107 065S, nur für Motoren der Generation 2

① N°OE 03L 107 065S, uniquement pour Moteur de génération 2

① OE 03L 107 065G, Generación 2 solo motor

① Solo motore Generation 2

② A = 45.500

③ Only fit to pistons equivalent to OE 03L 107065 AG, 03L 1070 65 S

③ Nur für OE Kolben 03L 107065 AG und 03L 107065 S

③ Seulement adapté aux pistons équivalents à OE 03L 107065 AG et 03L 107065 S

③ Cabido solamente a los pistones equivalentes a OE 03L 107065 AG y 03L 107065 S

③ Adattato soltanto ai pistoni equivalenti OE a 03L 107065 AG e 03L 107065 S

④ 08-432300-10 OE: 03L198151C

81.00

43

CKFC (Euro 5)	4cyl.	1968cc	110kW (150PS)	Diesel	Turbo Intercooled	TD27197
CRBC (Euro 5)	4cyl.	1968cc	110kW (150PS)	Diesel	Turbo Intercooled	TD27202
CRFD (Euro 5)	4cyl.	1968cc	105kW (143PS)	Diesel	Turbo Intercooled	TD34041
CRLB (Euro 6)	4cyl.	1968cc	110kW (150PS)	Diesel	Turbo Intercooled	TD27196
CRLD (Euro 6)	4cyl.	1968cc	81kW (110PS)	Diesel	Turbo Intercooled	TD32536
CRMB (Euro 6)	4cyl.	1968cc	110kW (150PS)	Diesel	Turbo Intercooled	TD27198
CRUA	4cyl.	1968cc	110kW (150PS)	Diesel	Turbo Intercooled	TD31407
CRVA (Euro 5)	4cyl.	1968cc	81kW (110PS)	Diesel	Turbo Intercooled	TD27965
CRVC (Euro 5)	4cyl.	1968cc	105kW (143PS)	Diesel	Turbo Intercooled	TD29264
CUUA	4cyl.	1968cc	81kW (110PS)	Diesel	Turbo Intercooled	TD30261
CUUB	4cyl.	1968cc	110kW (150PS)	Diesel	Turbo Intercooled	TD28213
CUUD	4cyl.	1968cc	75kW (102PS)	Diesel	Turbo Intercooled	TD31239
CUUE	4cyl.	1968cc	90kW (122PS)	Diesel	Turbo Intercooled	TD31241
CUUF	4cyl.	1968cc	55kW (75PS)	Diesel	Turbo Intercooled	TD31240
CUVA (Euro 6)	4cyl.	1968cc	85kW (115PS)	Diesel	Turbo Intercooled	TD31371
CUVC (Euro 6)	4cyl.	1968cc	110kW (150PS)	Diesel	Turbo Intercooled	TD30995
CVCA	4cyl.	1968cc	110kW (150PS)	Diesel	Turbo Intercooled	TD30260
DEJA (Euro 6)	4cyl.	1968cc	110kW (150PS)	Diesel	Turbo Intercooled	TD34412
DEJB (Euro 6)	4cyl.	1968cc	81kW (110PS)	Diesel	Turbo Intercooled	TD34423
DFLA (Euro 6)	4cyl.	1968cc	110kW (150PS)	Diesel	Turbo Intercooled	TD33098
DFSB	4cyl.	1968cc	110kW (150PS)	Diesel	Turbo Intercooled	TD32527
DFSC	4cyl.	1968cc	55kW (75PS)	Diesel	Turbo Intercooled	TD32531
DFSD	4cyl.	1968cc	75kW (102PS)	Diesel	Turbo Intercooled	TD32601
DFSE	4cyl.	1968cc	90kW (122PS)	Diesel	Turbo Intercooled	TD32602
DFSF	4cyl.	1968cc	55kW (75PS)	Diesel	Turbo Intercooled	TD32532

BEETLE 2.0 TDI	06/14→09/18	GOLF VAN VII 2.0 TDI BlueMotion	04/13→03/17
CADDY Body/MPV 2.0 TDI	05/15→	JETTA IV 2.0 TDI	10/10→
CADDY IV Body/MPV 2.0 TDI	05/15→09/20	PASSAT B7 2.0 TDI	06/14→
CADDY IV MPV 2.0 TDI	05/15→09/20	PASSAT B8 2.0 TDI	08/14→
CADDY MPV 2.0 TDI	05/15→	SCIROCCO III 2.0 TDI	11/13→11/17



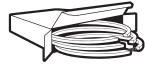

CC B7 2.0 TDI	05/15→12/16	SHARAN 2.0 TDI	05/11→
GOLF VI 2.0 TDI	11/13→05/16	TIGUAN 2.0 TDI	05/15→07/20
GOLF VII 2.0 TDI	08/12→	TOURAN 2.0 TDI	11/15→07/19
GOLF VII 2.0 TDI BlueMotion	05/13→05/14		

87-447500-10 STD ①

08-447500-00 STD ② ③

08-447507-00 0.50mm ② ③

- A 45.80
- B- 12.90
- BØ 50.88
- D 68.80
- 26x66



- 1.75 GDC P
- 2.00 P
- 2.00 CR NT



AK KK NB RT TP

① OE 04L 107 065A
② EA288 Engine family
③ 2014>

① OE 04L 107 065A
② EA288 Motorenfamilie

① OE 04L 107 065A
② Famille de moteurs EA288

① OE 04L 107 065A
② Familia de motores EA288

① OE 04L 107 065A
② Motori famiglia EA288

81.00 **44**

CXFA (Euro 6)	4cyl.	1968cc	110kW (150PS)	Diesel	Turbo Intercooled	TD31318
CXGA (Euro 6)	4cyl.	1968cc	62kW (84PS)	Diesel	Turbo Intercooled	TD31319
CXGB (Euro 6)	4cyl.	1968cc	75kW (102PS)	Diesel	Turbo Intercooled	TD31328
CXHA (Euro 6)	4cyl.	1968cc	110kW (150PS)	Diesel	Turbo Intercooled	TD31329
CXHB (Euro 6)	4cyl.	1968cc	84kW (114PS)	Diesel	Turbo Intercooled	TD33445
CXHC (Euro 6)	4cyl.	1968cc	81kW (110PS)	Diesel	Turbo Intercooled	TD38699
DASA	4cyl.	1968cc	90kW (122PS)	Diesel	Turbo Intercooled	TD35058
DASB	4cyl.	1968cc	103kW (140PS)	Diesel	Turbo Intercooled	TD35117
DASC (Euro 5)	4cyl.	1968cc	80kW (109PS)	Diesel	Turbo	TD36932
DAUA	4cyl.	1968cc	103kW (140PS)	Diesel	Turbo Intercooled	TD34187
DAUB	4cyl.	1968cc	75kW (102PS)	Diesel	Turbo Intercooled	TD34186
DAVA	4cyl.	1968cc	130kW (177PS)	Diesel	Bi-Turbo Intercooled	TD34188
DAWA	4cyl.	1968cc	130kW (177PS)	Diesel	Bi-Turbo Intercooled	TD35106

CALIFORNIA T6 Camper 2.0 TDI	04/15→	MULTIVAN VI 2.0 TDI	04/15→
CRAFTER 2.0 TDI	09/16→	TRANSPORTER VI 2.0 TDI	04/15→
CRAFTER 2.0 TDI RWD	11/16→	TRANSPORTER VI / CARAVELLE VI 2.0 TDI	04/15→
GRAND CALIFORNIA Camper 2.0 TDI	04/19→		

87-447500-30 STD

08-447500-00 STD ① ②

87-447507-30 0.50mm

08-447507-00 0.50mm ① ②

- A 45.80
- B- 13.50
- BØ 51.00
- D 68.80
- 26x66



- 1.75 GDC P
- 2.00 P
- 2.00 CR NT



AK KK NB RT TP

① EA288 Engine family
② 2014>

① EA288 Motorenfamilie

① Famille de moteurs EA288

① Familia de motores EA288

① Motori famiglia EA288

81.00 **45**

ACV	5cyl.	2461cc	75kW (102PS)	Diesel	Turbo Intercooled	TD4978
AGX	5cyl.	2461cc	55kW (75PS)	Diesel	Turbo Intercooled	TD9295
AHD	5cyl.	2461cc	75kW (102PS)	Diesel	Turbo Intercooled	TD9294
AHY	5cyl.	2461cc	111kW (151PS)	Diesel	Turbo Intercooled	TD10748
AJT	5cyl.	2461cc	65kW (88PS)	Diesel	Turbo Intercooled	TD10747
ANJ	5cyl.	2461cc	80kW (109PS)	Diesel	Turbo Intercooled	TD13446





APA	5cyl.	2461cc	66kW (90PS)	Diesel	Turbo Intercooled	TD13445
AUF	5cyl.	2461cc	75kW (102PS)	Diesel	Turbo Intercooled	TD16857
AXG	5cyl.	2461cc	111kW (151PS)	Diesel	Turbo Intercooled	TD17505
AXL	5cyl.	2461cc	75kW (102PS)	Diesel	Turbo Intercooled	TD18687
AYC	5cyl.	2461cc	75kW (102PS)	Diesel	Turbo Intercooled	TD17504
AYY	5cyl.	2461cc	65kW (88PS)	Diesel	Turbo Intercooled	TD17503
BBE	5cyl.	2461cc	61kW (83PS)	Diesel	Turbo Intercooled	TD16451
BBF	5cyl.	2461cc	70kW (95PS)	Diesel	Turbo Intercooled	TD16452

CALIFORNIA T4 Camper 2.5 TDI	05/98→04/03	LT 28-46 II 2.5 SDI	09/96→07/06
LT 28-35 II 2.5 SDI	07/96→07/06	LT 28-46 II 2.5 TDI	05/96→07/06
LT 28-35 II 2.5 TDI	05/96→07/06	TRANSPORTER IV 2.5 TDI	09/95→04/03

<p>87-501500-00 STD ①</p> <p>87-501507-00 0.50mm ① ②</p> <p>A 45.75 B- 17.20 BØ 39.60 C 1.35 D 69.75 26x68</p> <p>AK HA NB RT</p>	<p>08-501500-00 STD</p> <p>08-501507-00 0.50mm</p> <p>2.50 PS P 2.00 CR P 3.00 CR P</p>	<p>14-020420-00 D</p> <p>14-020421-00 D</p> <p>B 84.00 C 158.00 D 85.00 E 5.00 B 84.50 C 158.00 D 85.50 E 5.50</p>
---	---	--

<p>87-501500-10 STD ③</p> <p>87-501507-10 0.50mm ② ③</p> <p>A 45.75 B- 17.20 BØ 39.60 C 1.35 D 69.75 26x68</p> <p>AK HA NB RT</p>	<p>08-501500-00 STD</p> <p>08-501507-00 0.50mm</p> <p>2.50 PS P 2.00 CR P 3.00 CR P</p>	
---	---	--

① To cylinder 1 & 2 ① an Zylinder 1 & 2 ① sur cylindre 1 & 2 ① en el cilindro 1 & 2 ① a cilindro 1 & 2
 ② A = 45.500, D = 69.500
 ③ To cylinder 3 - 5 ③ an Zylinder 3-5 ③ sur cylindre 3-5 ③ en el cilindro 3-5 ③ a cilindro 3-5

81.00						46
ANF	5cyl.	2461cc	55kW (75PS)	Diesel		TD20502
ANG	5cyl.	2461cc	88kW (120PS)	Diesel	Turbo Intercooled	TD20503
ANH	5cyl.	2461cc	111kW (151PS)	Diesel	Turbo Intercooled	TD20504
BCT	5cyl.	2461cc	40kW (55PS)	Diesel		TD22630
BCU	5cyl.	2461cc	74kW (100PS)	Diesel	Turbo Intercooled	TD22631
BCV	5cyl.	2461cc	108kW (147PS)	Diesel	Turbo Intercooled	TD22632
BPD	5cyl.	2461cc	120kW (163PS)	Diesel	Turbo Intercooled	TD20507
BTW	5cyl.	2461cc	121kW (165PS)	Diesel	Turbo Intercooled	TD20676
TOUAREG 2.5 R5 TDI			08/03→05/10			





14-020420-00 *D* **B 84.00 C 158.00 D 85.00 E 5.00**
 14-020421-00 *D* **B 84.50 C 158.00 D 85.50 E 5.50**

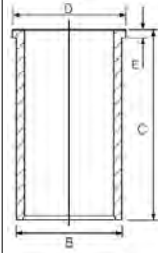

81.00

47

AVR	5cyl.	2461cc	80kW (109PS)	Diesel	Turbo Intercooled	TD15497
BBR	5cyl.	2461cc	80kW (109PS)	Diesel	Turbo Intercooled	TD22627
LT 28-35 II 2.5 TDI		05/99→07/06		LT 28-46 II 2.5 TDI		05/99→07/06

87-501500-40 *STD*
 87-501507-40 *0.50mm*

08-501500-00 *STD*
 08-501507-00 *0.50mm*

A 45.80
B- 16.80
BØ 46.00
C 1.35
C 1.35
D 69.80
 26x68





2.50  PS P
 2.00  CR P
 3.00  CR P

AK NB RT

81.00

48

AXD	5cyl.	2461cc	96kW (130PS)	Diesel	Turbo Intercooled	TD16868
AXE	5cyl.	2461cc	96-128kW (131-174PS)	Diesel	Turbo Intercooled	TD16869
BAC	5cyl.	2461cc	128kW (174PS)	Diesel	Turbo Intercooled	TD16855
BLJ	5cyl.	2461cc	120kW (163PS)	Diesel	Turbo Intercooled	TD20505
BLK	5cyl.	2461cc	120kW (163PS)	Diesel	Turbo Intercooled	TD20506
CALIFORNIA T5 Camper 2.5 TDI		05/07→11/09		TOUAREG 2.5 R5 TDI		01/03→05/10
CALIFORNIA T5 Camper 2.5 TDi		05/07→11/09		TRANSPORTER V 2.5 TDI		04/03→11/09
MULTIVAN V 2.5 TDI		04/03→11/09		TRANSPORTER V 2.5 TDi		11/03→11/09

87-421000-10 *STD* 
 87-421007-10 *0.50mm* 

08-421000-00 *STD*
 08-421007-00 *0.50mm*

A 45.75
B- 18.20
BØ 37.80
C 1.40
D 69.75
 26x65



2.50  CK P
 2.00  P
 3.00  CR P

AK KK NB RT

14-020420-00 *D* **B 84.00 C 158.00 D 85.00 E 5.00**
 14-020421-00 *D* **B 84.50 C 158.00 D 85.50 E 5.50**

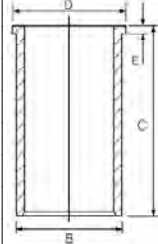



87-421000-20 STD ②
87-421007-20 0.50mm ②

A 45.75
B- 18.20
Bø 37.80
C 1.40
D 69.75
① 26x65

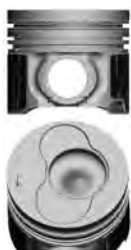

AK KK NB RT

08-421000-00 STD
08-421007-00 0.50mm

2.50 CK P
2.00 P
3.00 CR P



① To cylinder 1 & 2
② To cylinder 3 - 5

① an Zylinder 1 & 2
② an Zylinder 3-5

① sur cylindre 1 & 2
② sur cylindre 3-5

① en el cilindro 1 & 2
② en el cilindro 3-5

① a cilindro 1 & 2
② a cilindro 3-5

81.00

49

BJL	5cyl.	2461cc	100kW (136PS)	Diesel	Turbo Intercooled	TD18893
BJM	5cyl.	2461cc	120kW (163PS)	Diesel	Turbo Intercooled	TD18894
CECA	5cyl.	2461cc	100kW (136PS)	Diesel	Turbo Intercooled	TD24721
CECB	5cyl.	2461cc	120kW (163PS)	Diesel	Turbo Intercooled	TD24722

CRAFTER 30-35 2.5 TDI

04/06→05/13

CRAFTER 30-50 2.5 TDI

04/06→05/13

87-421000-30 STD
87-421007-30 0.50mm

A 45.75
B- 16.65
Bø 46.00
C 1.35
C 1.35
D 68.75
① 26x66



(0811C-101)

AK KK NB RT TP

08-421000-00 STD
08-421007-00 0.50mm

2.50 CK P
2.00 P
3.00 CR P



14-020420-00 D B 84.00 C 158.00 D 85.00 E 5.00
14-020421-00 D B 84.50 C 158.00 D 85.50 E 5.50

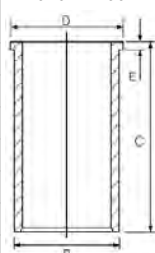

82.50

50

2E	4cyl.	1984cc	85kW (115PS)	Petrol	TD4963
ADY	4cyl.	1984cc	85kW (115PS)	Petrol	TD4979
AGG	4cyl.	1984cc	85kW (115PS)	Petrol	TD4989
AKR	4cyl.	1984cc	85kW (115PS)	Petrol	TD11354

CORRADO 2.0 i

04/93→12/95

SHARAN 2.0

09/95→03/10

GOLF III 2.0

11/91→04/99

SHARAN VAN 2.0

09/96→07/02

GOLF IV 2.0

06/98→06/02

VENTO 2.0

11/91→09/98

PASSAT B3/B4 2.0

09/89→05/97

87-501800-20 STD
87-501807-20 0.50mm ①

A 30.90
B- 5.70
Bø 64.00
B+ 0.90
D 51.80
① 21x55



(08241B-103)

08-501800-00 STD
08-501807-00 0.50mm

1.20 PS
1.50 P
2.00 CR P



① A = 30.600, D = 51.500



82.50 **51**

ABF	4cyl.	1984cc	110kW (150PS)	Petrol	TD4007
GOLF III 2.0 GTI			08/91→09/97	PASSAT B3/B4 2.0 16V	01/94→05/97
GOLF III 2.0 GTI 16V			08/92→08/97		

87-501800-40 STD

A 31.60
C 3.20
D 51.60
21x56
(08238A)

08-501800-00 STD
08-501807-00 0.50mm

1.20 PS
1.50 P
2.00 CR P

82.50 **52**

AXW	4cyl.	1984cc	110kW (150PS)	Petrol	TD17081
BLR	4cyl.	1984cc	110kW (150PS)	Petrol	TD18134
BLX	4cyl.	1984cc	110kW (150PS)	Petrol	TD17985
BLY	4cyl.	1984cc	110kW (150PS)	Petrol	TD17986
BVX	4cyl.	1984cc	110kW (150PS)	Petrol	TD18912
BVY	4cyl.	1984cc	110kW (150PS)	Petrol	TD18468
BVZ	4cyl.	1984cc	110kW (150PS)	Petrol	TD18469

EOS 2.0 FSI		03/06→05/08	PASSAT B6 2.0 FSI	03/05→11/10
GOLF V 2.0 FSI		01/04→11/08	TOURAN 2.0 FSI	10/03→01/07
GOLF PLUS V 2.0 FSI		05/05→06/08	TOURAN VAN 2.0 FSI	05/04→01/07
JETTA III 2.0 FSI		08/05→10/10		

87-435100-00 STD 1

A 29.38
B+ 12.46
D 59.85
19x44
(08240B301)
TP

08-435100-10 STD

1.20 PVD NT 2
1.50
2.00 CR

1 Elastoval® 2 Steel 2 Stahl 2 Acier 2 Acero 2 Acciaio

82.50 **53**

AXX	4cyl.	1984cc	147kW (200PS)	Petrol	Turbo Intercooled	TD18540
BPY	4cyl.	1984cc	147kW (200PS)	Petrol	Turbo Intercooled	TD18883
BWA	4cyl.	1984cc	147kW (200PS)	Petrol	Turbo Intercooled	TD18541

EOS 2.0 TFSI		03/06→08/15	JETTA III 2.0 TFSI	10/05→10/10
GOLF V 2.0 GTI		10/04→02/09	PASSAT B6 2.0 TFSI	07/05→11/10
GOLF V 2.0 TFSI		06/07→07/09		

87-438500-00 STD
87-438507-00 0.50mm

A 29.50
B- 6.10
BØ 49.52
C 1.36
C 1.36
D 50.50
20x59
AK RT TP

08-438500-00 STD
08-438507-00 0.50mm

1.20 PVD 1
1.50 P
2.00 CR P

1 Steel 1 Stahl 1 Acier 1 Acero 1 Acciaio



82.50 **54**

CAWA	4cyl.	1984cc	125kW (170PS)	Petrol	Turbo Intercooled	TD20733
CAWB	4cyl.	1984cc	147kW (200PS)	Petrol	Turbo Intercooled	TD20732
CCTA	4cyl.	1984cc	147-157kW (200-213PS)	Petrol	Turbo Intercooled	TD20795
CCZA	4cyl.	1984cc	147kW (200PS)	Petrol	Turbo Intercooled	TD22172
CCZB	4cyl.	1984cc	155kW (211PS)	Petrol	Turbo & Supercharged	TD22181
CCZC	4cyl.	1984cc	125kW (170PS)	Petrol	Turbo Intercooled	TD24964
CCZD	4cyl.	1984cc	132kW (180PS)	Petrol	Turbo Intercooled	TD25421
CFPA (Euro 4)	4cyl.	1984cc	118kW (160PS)	Petrol	Turbo Intercooled	TD25736
CJKA	4cyl.	1984cc	150kW (204PS)	Petrol	Turbo Intercooled	TD26335
CJKB	4cyl.	1984cc	110kW (150PS)	Petrol	Turbo	TD26535

AMAROK 2.0 TSI	12/10→10/16	PASSAT B6 2.0 TFSI	07/05→11/10
BEETLE 2.0 TFSI	04/11→07/16	PASSAT B7 2.0 TFSI	11/10→12/14
CALIFORNIA T5 Camper 2.0 TSI	05/11→08/15	PASSAT B7 2.0 TSI	11/10→12/15
CALIFORNIA T6 Camper 2.0 TSI	04/15→07/19	PASSAT CC B6 2.0 TFSI	06/08→01/12
CC B7 2.0 TFSI	11/11→12/16	PASSAT CC B6 2.0 TSI	11/10→01/12
CC B7 2.0 TSI	11/11→12/16	SCIROCCO 2.0 TFSI	11/09→05/14
EOS 2.0 TFSI	03/06→08/15	SCIROCCO III 2.0 TFSI	05/08→11/09
EOS 2.0 TSI	11/09→08/15	SCIROCCO III 2.0 TSI	11/09→11/17
GOLF V 2.0 GTI	10/04→02/09	SHARAN 2.0 TFSI	12/10→11/15
GOLF V 2.0 TFSI	06/07→07/09	SHARAN VAN 2.0 TSI	12/10→11/15
GOLF VI 2.0 GTI	02/09→11/13	TIGUAN 2.0 TFSI	09/07→07/18
GOLF VI 2.0 TSI	01/10→05/16	TIGUAN 2.0 TSI	05/11→07/18
GOLF VI 2.0 TFSI	07/09→07/13	TIGUAN VAN 2.0 TSI	11/09→07/18
JETTA III 2.0 TFSI	10/05→10/10	TRANSPORTER V 2.0 TSI	05/11→08/15
JETTA IV 2.0 TFSI	12/10→	TRANSPORTER VI 2.0 TSI	04/15→07/19
MULTIVAN V 2.0 TSI	05/11→08/15	TRANSPORTER VI / CARAVELLE VI 2.0 TSI	04/15→07/19
MULTIVAN VI 2.0 TSI	04/15→07/19		

87-443800-10 STD

- A 29.60
- B- 6.15
- BØ 49.60
- C 3.60
- D 50.00
- 23x51

RT



Stahl

08-443800-00 STD

08-443807-00 0.50mm

- 1.20 PVD NT
- 1.20 P
- 2.00 CR P



Acier

Acero

Acciaio

82.50 **55**

CDA A	4cyl.	1798cc	118kW (160PS)	Petrol	Turbo Intercooled	TD22641
CDAB	4cyl.	1798cc	112kW (152PS)	Petrol	Turbo Intercooled	TD23735

CC B7 1.8 TSI	11/11→12/16	PASSAT B7 1.8 TSI	08/10→12/14
GOLF VI 1.8 TSI	06/09→01/11	PASSAT CC B6 1.8 TSI	06/08→01/12
PASSAT B6 1.8 TSI	05/07→10/11	SHARAN 1.8 TSI	11/11→
PASSAT B7 1.8 TFSI	08/10→12/14		

87-443800-00 STD

87-443807-00 0.50mm

- A 29.85
- B- 4.70
- B- 5.65
- B+ 5.65
- C 2.00
- D 56.00
- 23x54

RT TP



Stahl

08-443800-00 STD

08-443807-00 0.50mm

- 1.20 PVD NT
- 1.20 P
- 2.00 CR P



Acier

Acero

Acciaio



83.00 **56**

BKS	V6cyl.	2967cc	165kW (224PS)	Diesel	Turbo Intercooled	TD18031
BMK	V6cyl.	2967cc	165kW (224PS)	Diesel	Turbo Intercooled	TD18023
BUN	V6cyl.	2967cc	155kW (211PS)	Diesel	Turbo Intercooled	TD21182

PHAETON 3.0 V6 TDI	09/04→05/07	TOUAREG 3.0 TDI	04/06→05/10
TOUAREG 3.0 V6 TDI	11/04→05/10		



87-434300-00 STD
87-434307-00 0.50mm

A 46.30
B- 15.10
BØ 45.00
D 70.80
 30x68

AK KK RT



08-434300-00 STD
08-434307-00 0.50mm

2.00  CK
 2.00  CK
 3.00  CR

92.00 **57**

2L	4cyl.	2446cc	58-61kW (79-83PS)	Diesel	TD4966
-----------	-------	---------------	--------------------------	---------------	---------------

TARO 2.4 D	04/89→03/97
------------	-------------



87-373800-00 STD

A 49.20
B- 1.60
D 86.25
 27x74

AK



08-373800-00 STD
08-373807-00 0.50mm

2.00  CR P
 2.00  P
 4.00  CR P

14-010850-00 D **B 96.07 C 179.00**



87-373800-10 STD

A 44.30
B- 1.50
D 80.30
 27x70

AK TP



08-373800-00 STD
08-373807-00 0.50mm

2.00  CR P
 2.00  P
 4.00  CR P

14-040130-00 D **B 96.00 C 160.00 D 100.80 E 3.50 F 1.00**

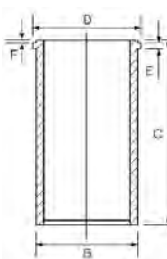

92.00 **58**

CG	4cyl.	2710cc	48kW (65PS)	Diesel	TD11148
-----------	-------	---------------	--------------------	---------------	----------------

LT 28-35 I 2.7 D	11/75→01/80
------------------	-------------





14-043450-00 D

B 96.91 C 191.19 D 101.00 E 3.91 F 0.70

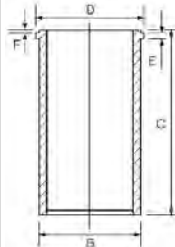

93.00

59

AGK	4cyl.	2799cc	92kW (125PS)	Diesel	Turbo Intercooled	TD9522
ATA	4cyl.	2799cc	96kW (130PS)	Diesel	Turbo Intercooled	TD13444
AUH	4cyl.	2799cc	116kW (158PS)	Diesel	Turbo Intercooled	TD16450
BCQ	4cyl.	2799cc	116kW (158PS)	Diesel	Turbo Intercooled	TD20509
LT 28-35 II 2.8 TDI		07/97→06/06		LT 28-46 II 2.8 TDI		07/97→07/06

87-143000-00 STD

87-143007-00 0.50mm

A 56.20

B- 18.50

BØ 47.10

C 1.50

D 86.20

35x77

AK HA RT



08-143000-00 STD

08-143007-00 0.50mm

2.50 CR P

2.00 P

3.00 CR P





70.80 **1**

188 A4.000 4cyl. 1242cc 44kW (60PS) Petrol TD24580

10 1.2 60 10/05 →

87-138400-40 *STD*
87-138406-40 *0.40mm*

A 28.00
B- 1.80
C 1.10
D 48.00
18x53

08-138400-00 *STD*
08-138406-00 *0.40mm*
08-138408-00 *0.60mm*

1.19 NT P
1.20 P
2.50 P

14-021080-00 *D* B 73.80 C 128.00 D 75.00 E 5.00

72.00 **2**

TU1JP 4cyl. 1124cc 44kW (60PS) Petrol TD26420

KORAL 1.1 10/02 → 11/08

87-426300-00 *STD*













A 27.70
B+ 0.10
D 47.50
18x55













08-426300-00 *STD*

1.50 NT
1.50 P
2.50 P

NUMERICAL PARTS LIST













Numerische Teilenummernliste • Liste des références produits
Liste da referencias

				9					9					9
87-100100-00	FORD	234	70		87-105500-00	FIAT	182	46		87-109700-10	AUDI	48	22	
87-101100-00	VOLVO	842	58		87-105500-00	LADA	328	5		87-109700-10	SEAT	727	27	
87-101100-10	VOLVO	842	57		87-105500-00	PEUGEOT	623	34		87-109700-10	VW	871	31	
87-101500-00	NISSAN	562	13		87-105500-00	SUZUKI	768	7		87-109705-10	AUDI	48	22	
87-101500-00	OPEL	583	30		87-105507-00	CITROËN	107	33		87-109705-10	SEAT	727	27	
87-101500-00	RENAULT	659	26		87-105507-00	FIAT	182	46		87-109705-10	VW	871	31	
87-101500-00	VAUXHALL	795	31		87-105507-00	LADA	328	5		87-109707-10	AUDI	48	22	
87-101500-00	VOLVO	816	10		87-105507-00	PEUGEOT	623	34		87-109707-10	SEAT	727	27	
87-101507-00	NISSAN	562	13		87-105507-00	SUZUKI	768	7		87-109707-10	VW	871	31	
87-101507-00	OPEL	583	30		87-105900-00	AUDI	49	23		87-109800-10	AUDI	41	10	
87-101507-00	RENAULT	659	26		87-105900-00	AUDI	50	26		87-109800-10	VOLVO	814	7	
87-101507-00	VAUXHALL	795	31		87-105900-00	SEAT	727	28		87-109800-10	VW	859	15	
87-101507-00	VOLVO	816	10		87-105900-00	SKODA	748	21		87-109807-10	AUDI	41	10	
87-101700-00	PERKINS	601	14		87-105900-00	VW	872	32		87-109807-10	VOLVO	814	7	
87-101700-10	PERKINS	601	14		87-105900-00	VW	873	35		87-109807-10	VW	859	15	
87-102700-00	OPEL	574	5		87-105907-00	AUDI	49	23		87-109811-10	AUDI	41	10	
87-102700-00	VAUXHALL	786	6		87-105907-00	AUDI	50	26		87-109811-10	VOLVO	814	7	
87-102700-10	CHEVROLET	79	4		87-105907-00	SEAT	727	28		87-109811-10	VW	859	15	
87-102700-10	OPEL	575	7		87-105907-00	SKODA	748	21		87-110900-00	ALFA ROMEO	28	21	
87-102700-10	VAUXHALL	787	8		87-105907-00	VW	872	32		87-110906-00	ALFA ROMEO	28	21	
87-102707-00	OPEL	574	5		87-105907-00	VW	873	35		87-112400-00	CITROËN	113	47	
87-102707-00	VAUXHALL	786	6		87-107000-10	FORD	214	26		87-112400-00	PEUGEOT	630	51	
87-102707-10	CHEVROLET	79	4		87-107000-10	FORD	215	27		87-112407-00	CITROËN	113	47	
87-102707-10	OPEL	575	7		87-107007-10	FORD	214	26		87-112407-00	PEUGEOT	630	51	
87-102707-10	VAUXHALL	787	8		87-107007-10	FORD	215	27		87-113500-00	FORD	222	43	
87-102800-10	OPEL	588	42		87-107011-10	FORD	214	26		87-113500-10	FORD	222	44	
87-102800-10	VAUXHALL	799	43		87-107011-10	FORD	215	27		87-113507-00	FORD	222	43	
87-102807-10	OPEL	588	42		87-107100-30	ALFA ROMEO	30	28		87-113507-10	FORD	222	44	
87-102807-10	VAUXHALL	799	43		87-107100-40	ALFA ROMEO	30	26		87-113511-00	FORD	222	43	
87-102900-10	OPEL	587	41		87-107600-00	FORD	222	42		87-113511-10	FORD	222	44	
87-102900-10	VAUXHALL	799	42		87-107607-00	FORD	222	42		87-114400-00	BMW	73	9	
87-103200-00	DEUTZ/KHD	146	3		87-108200-00	CITROËN	115	53		87-114400-00	LAND ROVER	344	4	
87-103207-00	DEUTZ/KHD	146	3		87-108200-00	FIAT	192	73		87-114400-00	ROVER	687	11	
87-103800-00	CITROËN	103	24		87-108200-00	IVECO	275	13		87-114400-10	BMW	75	13	
87-103800-00	PEUGEOT	619	26		87-108200-00	PEUGEOT	633	59		87-114400-10	LAND ROVER	345	6	
87-103806-00	CITROËN	103	24		87-108200-00	RENAULT	669	44		87-114400-30	BMW	73	9	
87-103806-00	PEUGEOT	619	26		87-108208-00	CITROËN	115	53		87-114400-40	BMW	74	11	
87-103900-00	IVECO	290	33		87-108208-00	FIAT	192	73		87-114400-40	BMW	76	14	
87-103900-30	IVECO	291	34		87-108208-00	IVECO	275	13		87-114400-60	BMW	74	10	
87-103900-40	IVECO	289	31		87-108208-00	PEUGEOT	633	59		87-114400-60	BMW	76	14	
87-104000-00	CITROËN	104	28		87-108208-00	RENAULT	669	44		87-114400-65	BMW	74	10	
87-104000-00	FIAT	178	39		87-109100-00	MERCEDES-BENZ	471	39		87-114405-00	BMW	73	9	
87-104000-00	PEUGEOT	620	30		87-109100-00	MERCEDES-BENZ	472	41		87-114405-00	LAND ROVER	344	4	
87-104008-00	CITROËN	104	28		87-109100-10	DAEWOO	129	4		87-114405-00	ROVER	687	11	
87-104008-00	FIAT	178	39		87-109100-10	MERCEDES-BENZ	471	39		87-114405-10	BMW	75	13	
87-104008-00	PEUGEOT	620	30		87-109100-10	MERCEDES-BENZ	471	40		87-114405-10	LAND ROVER	345	6	
87-104100-00	NISSAN	558	2		87-109100-10	SSANGYONG	760	7		87-114405-30	BMW	73	9	
87-104100-00	RENAULT	646	3		87-109107-00	MERCEDES-BENZ	471	39		87-114405-40	BMW	74	11	
87-104107-00	NISSAN	558	2		87-109107-00	MERCEDES-BENZ	472	41		87-114405-40	BMW	76	14	
87-104107-00	RENAULT	646	3		87-109107-10	DAEWOO	129	4		87-114405-60	BMW	74	10	
87-104200-00	DACIA	126	12		87-109107-10	MERCEDES-BENZ	471	39		87-114405-60	BMW	76	14	
87-104200-00	NISSAN	562	12		87-109107-10	MERCEDES-BENZ	471	40		87-114700-00	CHEVROLET	84	19	
87-104200-00	RENAULT	657	21		87-109107-10	SSANGYONG	760	7		87-114700-00	CITROËN	109	36	
87-104200-10	DACIA	126	12		87-109200-00	SCANIA	700	5		87-114700-00	FIAT	185	53	
87-104200-10	NISSAN	562	12		87-109400-50	AUDI	52	29		87-114700-00	LANCIA	341	31	
87-104200-10	RENAULT	657	21		87-109400-50	SEAT	726	26		87-114700-00	PEUGEOT	624	37	
87-104200-30	DACIA	125	10		87-109400-50	VW	870	30		87-114700-00	SUZUKI	769	10	
87-104200-30	NISSAN	562	11		87-109407-50	AUDI	52	29		87-114700-10	CITROËN	109	37	
87-104200-30	RENAULT	655	19		87-109407-50	SEAT	726	26		87-114700-10	FIAT	185	54	
87-104200-40	DACIA	125	11		87-109407-50	VW	870	30		87-114700-10	LANCIA	341	28	
87-104200-40	RENAULT	656	20		87-109500-00	AUDI	40	9		87-114700-10	PEUGEOT	625	38	
87-104207-00	DACIA	126	12		87-109500-00	VOLVO	814	6		87-114700-10	SUZUKI	769	9	
87-104207-00	NISSAN	562	12		87-109500-00	VW	859	16		87-114700-30	CITROËN	111	42	
87-104207-00	RENAULT	657	21		87-109505-00	AUDI	40	9		87-114700-30	FIAT	184	52	
87-104207-10	DACIA	126	12		87-109505-00	VOLVO	814	6		87-114700-30	LANCIA	341	29	
87-104207-10	NISSAN	562	12		87-109505-00	VW	859	16		87-114700-30	PEUGEOT	627	43	
87-104207-10	RENAULT	657	21		87-109507-00	AUDI	40	9		87-114700-40	CITROËN	110	38	
87-104207-40	DACIA	125	11		87-109507-00	VOLVO	814	6		87-114700-40	FIAT	185	55	
87-104207-40	RENAULT	656	20		87-109507-00	VW	859	16		87-114700-40	FORD	217	32	
87-104300-00	MAN	406	37		87-109511-00	AUDI	40	9		87-114700-40	LANCIA	341	30	
87-104300-10	MAN	406	37		87-109511-00	VOLVO	814	6		87-114700-40	PEUGEOT	625	39	
87-105500-00	CITROËN	107	33		87-109511-00	VW	859	16		87-114700-40	VOLVO	816	11	

	 	 9		 	 9		 	 9
87-114708-00	CHEVROLET	84 19	87-114900-65	VW	866 25	87-114907-56	FORD	210 19
87-114708-00	CITROËN	109 36	87-114900-66	AUDI	45 17	87-114907-56	SEAT	725 24
87-114708-00	FIAT	185 53	87-114900-66	FORD	211 20	87-114907-56	VW	865 24
87-114708-00	LANCIA	341 31	87-114900-66	SEAT	722 22	87-114907-60	AUDI	42 14
87-114708-00	PEUGEOT	624 37	87-114900-66	SKODA	746 18	87-114907-60	FORD	209 18
87-114708-00	SUZUKI	769 10	87-114900-66	VW	866 25	87-114907-60	SEAT	720 18
87-114708-10	CITROËN	109 37	87-114900-70	AUDI	42 14	87-114907-60	SKODA	743 15
87-114708-10	FIAT	185 54	87-114900-70	FORD	209 18	87-114907-60	VW	862 21
87-114708-10	LANCIA	341 28	87-114900-70	SEAT	720 18	87-114907-65	AUDI	45 17
87-114708-10	PEUGEOT	625 38	87-114900-70	SKODA	743 15	87-114907-65	FORD	211 20
87-114708-10	SUZUKI	769 9	87-114900-70	VW	862 21	87-114907-65	SEAT	722 22
87-114708-40	CITROËN	110 38	87-114900-80	AUDI	41 11	87-114907-65	SKODA	746 18
87-114708-40	FIAT	185 55	87-114900-80	SEAT	719 15	87-114907-65	VW	866 25
87-114708-40	FORD	217 32	87-114900-80	SKODA	742 12	87-114907-66	AUDI	45 17
87-114708-40	LANCIA	341 30	87-114900-80	VW	860 17	87-114907-66	FORD	211 20
87-114708-40	PEUGEOT	625 39	87-114900-85	AUDI	41 11	87-114907-66	SEAT	722 22
87-114708-40	VOLVO	816 11	87-114900-85	SEAT	719 15	87-114907-66	SKODA	746 18
87-114900-05	AUDI	44 16	87-114900-85	SKODA	742 12	87-114907-66	VW	866 25
87-114900-05	FORD	210 19	87-114900-85	VW	860 17	87-114907-70	AUDI	42 14
87-114900-05	SEAT	725 24	87-114900-90	AUDI	42 14	87-114907-70	FORD	209 18
87-114900-05	VW	865 24	87-114900-90	FORD	209 18	87-114907-70	SEAT	720 18
87-114900-15	AUDI	44 16	87-114900-90	SEAT	720 18	87-114907-70	SKODA	743 15
87-114900-15	FORD	210 19	87-114900-90	SKODA	743 15	87-114907-70	VW	862 21
87-114900-15	SEAT	725 24	87-114900-90	VW	862 21	87-114907-80	AUDI	41 11
87-114900-15	VW	865 24	87-114900-95	AUDI	42 14	87-114907-80	SEAT	719 15
87-114900-20	SEAT	722 20	87-114900-95	FORD	209 18	87-114907-80	SKODA	742 12
87-114900-20	SKODA	744 16	87-114900-95	SEAT	720 18	87-114907-80	VW	860 17
87-114900-20	VW	864 23	87-114900-95	SKODA	743 15	87-114907-85	AUDI	41 11
87-114900-25	AUDI	46 18	87-114900-95	VW	862 21	87-114907-85	SEAT	719 15
87-114900-25	SEAT	723 23	87-114907-05	AUDI	44 16	87-114907-85	SKODA	742 12
87-114900-25	SKODA	745 17	87-114907-05	FORD	210 19	87-114907-85	VW	860 17
87-114900-25	VW	867 26	87-114907-05	SEAT	725 24	87-114907-90	AUDI	42 14
87-114900-30	SEAT	722 20	87-114907-05	VW	865 24	87-114907-90	FORD	209 18
87-114900-30	SKODA	744 16	87-114907-15	AUDI	44 16	87-114907-90	SEAT	720 18
87-114900-30	VW	864 23	87-114907-15	FORD	210 19	87-114907-90	SKODA	743 15
87-114900-35	AUDI	46 18	87-114907-15	SEAT	725 24	87-114907-90	VW	862 21
87-114900-35	SEAT	723 23	87-114907-15	VW	865 24	87-114907-95	AUDI	42 14
87-114900-35	SKODA	745 17	87-114907-20	SEAT	722 20	87-114907-95	FORD	209 18
87-114900-35	VW	867 26	87-114907-20	SKODA	744 16	87-114907-95	SEAT	720 18
87-114900-45	AUDI	46 18	87-114907-20	VW	864 23	87-114907-95	SKODA	743 15
87-114900-45	FORD	212 21	87-114907-25	AUDI	46 18	87-114907-95	VW	862 21
87-114900-45	SEAT	723 23	87-114907-25	SEAT	723 23	87-115800-00	MERCEDES-BENZ	516 79
87-114900-45	SKODA	745 17	87-114907-25	SKODA	745 17	87-116100-00	AUDI	39 5
87-114900-45	VW	867 26	87-114907-25	VW	867 26	87-116100-00	SEAT	717 11
87-114900-45	VW	869 27	87-114907-30	SEAT	722 20	87-116100-00	SKODA	740 8
87-114900-45	VW	869 28	87-114907-30	SKODA	744 16	87-116100-00	VW	856 10
87-114900-46	AUDI	46 18	87-114907-30	VW	864 23	87-116107-00	AUDI	39 5
87-114900-46	FORD	212 21	87-114907-35	AUDI	46 18	87-116107-00	SEAT	717 11
87-114900-46	SEAT	723 23	87-114907-35	SEAT	723 23	87-116107-00	SKODA	740 8
87-114900-46	SKODA	745 17	87-114907-35	SKODA	745 17	87-116107-00	VW	856 10
87-114900-46	VW	867 26	87-114907-35	VW	867 26	87-117900-00	MERCEDES-BENZ	461 21
87-114900-46	VW	869 27	87-114907-45	AUDI	46 18	87-117900-00	MERCEDES-BENZ	462 23
87-114900-46	VW	869 28	87-114907-45	FORD	212 21	87-117900-10	MERCEDES-BENZ	461 21
87-114900-55	AUDI	44 16	87-114907-45	SEAT	723 23	87-117900-10	MERCEDES-BENZ	461 22
87-114900-55	AUDI	47 19	87-114907-45	SKODA	745 17	87-117900-20	MERCEDES-BENZ	461 22
87-114900-55	FORD	210 19	87-114907-45	VW	867 26	87-117900-20	MERCEDES-BENZ	462 23
87-114900-55	SEAT	725 24	87-114907-45	VW	869 27	87-117900-20	MERCEDES-BENZ	463 24
87-114900-55	VW	865 24	87-114907-45	VW	869 28	87-117907-00	MERCEDES-BENZ	461 21
87-114900-56	AUDI	44 16	87-114907-46	AUDI	46 18	87-117907-00	MERCEDES-BENZ	462 23
87-114900-56	AUDI	47 19	87-114907-46	FORD	212 21	87-117907-10	MERCEDES-BENZ	461 21
87-114900-56	FORD	210 19	87-114907-46	SEAT	723 23	87-117907-10	MERCEDES-BENZ	461 22
87-114900-56	SEAT	725 24	87-114907-46	SKODA	745 17	87-117907-20	MERCEDES-BENZ	461 22
87-114900-56	VW	865 24	87-114907-46	VW	867 26	87-117907-20	MERCEDES-BENZ	462 23
87-114900-60	AUDI	42 14	87-114907-46	VW	869 27	87-117907-20	MERCEDES-BENZ	463 24
87-114900-60	FORD	209 18	87-114907-46	VW	869 28	87-118006-00	ALFA ROMEO	24 12
87-114900-60	SEAT	720 18	87-114907-55	AUDI	44 16	87-118006-00	FIAT	176 34
87-114900-60	SKODA	743 15	87-114907-55	AUDI	47 19	87-118006-00	LANCIA	336 18
87-114900-60	VW	862 21	87-114907-55	FORD	210 19	87-119000-00	MERCEDES-BENZ	470 38
87-114900-65	AUDI	45 17	87-114907-55	SEAT	725 24	87-119800-00	HONDA	240 4
87-114900-65	FORD	211 20	87-114907-55	VW	865 24	87-119800-00	LAND ROVER	346 7
87-114900-65	SEAT	722 22	87-114907-56	AUDI	44 16	87-119800-00	MG	532 10
87-114900-65	SKODA	746 18	87-114907-56	AUDI	47 19	87-119800-00	ROVER	688 12

NUMERICAL PARTS LIST









Numerische Teilenummernliste • Liste des références produits
Liste da referencias

	 	 9		 	 9		 	 9
87-119807-00	HONDA	240 4	87-123407-00	RENAULT	652 13	87-127407-00	NISSAN	565 20
87-119807-00	LAND ROVER	346 7	87-123407-10	DACIA	123 5	87-127407-00	OPEL	591 50
87-119807-00	MG	532 10	87-123407-10	DACIA	123 6	87-127407-00	RENAULT	664 33
87-119807-00	ROVER	688 12	87-123407-10	NISSAN	559 6	87-127407-00	VAUXHALL	802 51
87-121800-00	IVECO	296 45	87-123407-10	RENAULT	652 13	87-127407-10	RENAULT	664 32
87-121800-10	IVECO	296 44	87-123407-10	SUZUKI	768 5	87-127800-00	DEUTZ/KHD	147 7
87-121900-00	IVECO	299 52	87-123407-20	DACIA	124 7	87-127900-00	DEUTZ/KHD	149 11
87-122000-00	IVECO	300 55	87-123407-20	NISSAN	560 7	87-127907-00	DEUTZ/KHD	149 11
87-122200-00	CITROËN	115 52	87-123407-20	RENAULT	652 14	87-131500-00	RENAULT	673 56
87-122200-00	FIAT	191 72	87-123407-30	NISSAN	560 8	87-135300-00	CITROËN	94 6
87-122200-00	IVECO	274 12	87-123407-30	RENAULT	653 15	87-135300-00	FORD	203 4
87-122200-00	PEUGEOT	632 58	87-123407-40	DACIA	123 4	87-135300-00	MAZDA	413 1
87-122200-00	RENAULT	668 43	87-123407-40	DACIA	124 8	87-135300-00	PEUGEOT	610 7
87-122200-10	FIAT	191 71	87-123407-40	NISSAN	558 4	87-135300-00	TOYOTA	775 2
87-122200-10	IVECO	272 9	87-123407-40	RENAULT	651 12	87-135300-10	CITROËN	95 7
87-122200-10	IVECO	274 11	87-123407-40	RENAULT	654 17	87-135300-10	PEUGEOT	611 8
87-122200-10	OPEL	593 58	87-123407-50	DACIA	124 8	87-135300-10	SUZUKI	767 3
87-122200-10	RENAULT	668 41	87-123407-50	RENAULT	654 16	87-135307-00	CITROËN	94 6
87-122200-10	VAUXHALL	804 58	87-123407-50	RENAULT	654 17	87-135307-00	FORD	203 4
87-122208-00	CITROËN	115 52	87-123700-30	FORD	227 56	87-135307-00	MAZDA	413 1
87-122208-00	FIAT	191 72	87-123700-30	FORD	228 57	87-135307-00	PEUGEOT	610 7
87-122208-00	IVECO	274 12	87-123721-30	FORD	227 56	87-135307-00	TOYOTA	775 2
87-122208-00	PEUGEOT	632 58	87-123721-30	FORD	228 57	87-135500-00	RENAULT	678 65
87-122208-00	RENAULT	668 43	87-123900-10	DEUTZ/KHD	158 32	87-135500-10	RENAULT	677 62
87-122208-10	FIAT	191 71	87-124000-00	FIAT	178 37	87-136000-00	MERCEDES-BENZ	523 88
87-122208-10	IVECO	272 9	87-124000-30	ALFA ROMEO	25 14	87-136000-10	MERCEDES-BENZ	523 88
87-122208-10	IVECO	274 11	87-124000-30	FIAT	177 36	87-136400-00	MERCEDES-BENZ	464 27
87-122208-10	OPEL	593 58	87-124000-30	LANCIA	336 19	87-136400-30	MERCEDES-BENZ	464 26
87-122208-10	RENAULT	668 41	87-124000-30	OPEL	585 35	87-136407-00	MERCEDES-BENZ	464 27
87-122208-10	VAUXHALL	804 58	87-124000-30	SAAB	693 5	87-136407-30	MERCEDES-BENZ	464 26
87-123200-00	RENAULT	679 68	87-124000-30	SUZUKI	768 6	87-136500-00	MAN	382 5
87-123200-00	VOLVO	835 44	87-124000-30	VAUXHALL	796 36	87-136500-10	MAN	382 5
87-123200-00	VOLVO	835 45	87-124008-00	FIAT	178 37	87-136500-30	MAN	384 6
87-123200-00	VOLVO	836 47	87-124008-30	ALFA ROMEO	25 14	87-136500-55	MAN	386 8
87-123200-00	VOLVO	837 49	87-124008-30	FIAT	177 36	87-136500-60	MAN	384 6
87-123200-10	RENAULT	679 68	87-124008-30	LANCIA	336 19	87-136500-65	MAN	384 7
87-123200-10	VOLVO	836 48	87-124008-30	OPEL	585 35	87-136500-70	MAN	384 6
87-123200-10	VOLVO	837 49	87-124008-30	SAAB	693 5	87-136500-75	MAN	384 7
87-123200-10	VOLVO	840 54	87-124008-30	SUZUKI	768 6	87-136500-85	MAN	384 7
87-123200-10	VOLVO	841 55	87-124008-30	VAUXHALL	796 36	87-136500-90	MAN	386 8
87-123200-40	RENAULT	679 68	87-124500-00	MAN	407 38	87-136500-91	MAN	386 8
87-123200-40	VOLVO	835 45	87-124500-20	MAN	407 38	87-136500-95	MAN	388 10
87-123200-40	VOLVO	836 46	87-124500-30	MAN	410 42	87-136507-65	MAN	384 7
87-123200-40	VOLVO	836 47	87-124800-00	FIAT	176 33	87-136600-00	FORD	213 22
87-123200-40	VOLVO	836 48	87-124800-00	LANCIA	336 17	87-136607-00	FORD	213 22
87-123200-40	VOLVO	837 49	87-124806-00	FIAT	176 33	87-136700-00	MERCEDES-BENZ	449 1
87-123200-40	VOLVO	841 55	87-124806-00	LANCIA	336 17	87-136700-00	SMART	755 1
87-123200-40	VOLVO	841 56	87-125600-00	CHEVROLET	82 13	87-136705-00	MERCEDES-BENZ	449 1
87-123200-50	VOLVO	838 50	87-125600-00	OPEL	581 23	87-136705-00	SMART	755 1
87-123400-00	DACIA	123 5	87-125600-00	VAUXHALL	793 24	87-136707-00	MERCEDES-BENZ	449 1
87-123400-00	NISSAN	559 6	87-125607-00	CHEVROLET	82 13	87-136707-00	SMART	755 1
87-123400-00	RENAULT	652 13	87-125607-00	OPEL	581 23	87-136900-00	DEUTZ/KHD	153 19
87-123400-10	DACIA	123 5	87-125607-00	VAUXHALL	793 24	87-136900-00	DEUTZ/KHD	154 23
87-123400-10	DACIA	123 6	87-126000-00	CHEVROLET	84 18	87-136900-00	DEUTZ/KHD	155 24
87-123400-10	NISSAN	559 6	87-126000-00	OPEL	588 44	87-136900-10	DEUTZ/KHD	153 20
87-123400-10	RENAULT	652 13	87-126000-00	VAUXHALL	800 45	87-136900-10	DEUTZ/KHD	153 21
87-123400-10	SUZUKI	768 5	87-126000-10	OPEL	588 43	87-136900-10	DEUTZ/KHD	155 24
87-123400-20	DACIA	124 7	87-126000-10	SAAB	694 7	87-136900-10	VOLVO	821 23
87-123400-20	NISSAN	560 7	87-126000-10	VAUXHALL	799 44	87-136900-30	DEUTZ/KHD	153 21
87-123400-20	RENAULT	652 14	87-126007-00	CHEVROLET	84 18	87-136900-30	DEUTZ/KHD	154 23
87-123400-30	NISSAN	560 8	87-126007-00	OPEL	588 44	87-136900-30	DEUTZ/KHD	155 25
87-123400-30	RENAULT	653 15	87-126007-00	VAUXHALL	800 45	87-137500-10	NISSAN	566 22
87-123400-40	DACIA	123 4	87-126007-10	OPEL	588 43	87-137500-10	OPEL	592 54
87-123400-40	DACIA	124 8	87-126007-10	SAAB	694 7	87-137500-10	RENAULT	665 35
87-123400-40	NISSAN	558 4	87-126007-10	VAUXHALL	799 44	87-137500-10	VAUXHALL	803 54
87-123400-40	RENAULT	651 12	87-126300-10	BEDFORD	68 10	87-137500-30	NISSAN	566 21
87-123400-40	RENAULT	654 17	87-126311-10	BEDFORD	68 10	87-137500-30	OPEL	592 53
87-123400-50	DACIA	124 8	87-127400-00	NISSAN	565 20	87-137500-30	RENAULT	665 34
87-123400-50	RENAULT	654 16	87-127400-00	OPEL	591 50	87-137500-30	VAUXHALL	803 53
87-123400-50	RENAULT	654 17	87-127400-00	RENAULT	664 33	87-137507-10	NISSAN	566 22
87-123407-00	DACIA	123 5	87-127400-00	VAUXHALL	802 51	87-137507-10	OPEL	592 54
87-123407-00	NISSAN	559 6	87-127400-10	RENAULT	664 32	87-137507-10	RENAULT	665 35

				9					9					9
87-137507-10	VAUXHALL	803	54	87-139500-20	VW	876	40	87-143600-30	SCANIA	703	10			
87-137507-30	NISSAN	566	21	87-139500-30	VW	875	39	87-143600-50	SCANIA	702	9			
87-137507-30	OPEL	592	53	87-139500-40	VW	875	39	87-143600-60	SCANIA	709	22			
87-137507-30	RENAULT	665	34	87-139507-00	AUDI	52	30	87-143600-70	SCANIA	704	13			
87-137507-30	VAUXHALL	803	53	87-139507-00	DAEWOO	540	2	87-143800-00	MAN	407	39			
87-137600-00	CHEVROLET	79	2	87-139507-00	SEAT	729	33	87-143800-10	MAN	407	39			
87-137600-00	FIAT	166	7	87-139507-00	SKODA	749	25	87-143800-20	MAN	407	39			
87-137600-00	LANCIA	332	4	87-139507-00	VW	875	38	87-143800-30	MAN	405	36			
87-137600-00	OPEL	573	3	87-139507-10	AUDI	53	31	87-143800-40	MAN	405	36			
87-137600-00	SUBARU	765	1	87-139507-10	JEEP	314	2	87-143800-50	MAN	408	40			
87-137600-00	SUZUKI	767	1	87-139507-10	SEAT	729	34	87-143800-60	MAN	408	40			
87-137600-00	VAUXHALL	785	3	87-139507-10	SKODA	749	26	87-144200-00	CHEVROLET	81	9			
87-137606-00	CHEVROLET	79	2	87-139507-10	VW	876	40	87-144200-00	OPEL	578	16			
87-137606-00	FIAT	166	7	87-139507-20	AUDI	53	31	87-144200-00	VAUXHALL	790	17			
87-137606-00	LANCIA	332	4	87-139507-20	JEEP	314	2	87-144207-00	CHEVROLET	81	9			
87-137606-00	OPEL	573	3	87-139507-20	SEAT	729	34	87-144207-00	OPEL	578	16			
87-137606-00	SUBARU	765	1	87-139507-20	SKODA	749	26	87-144207-00	VAUXHALL	790	17			
87-137606-00	SUZUKI	767	1	87-139507-20	VW	876	40	87-145000-00	IVECO	280	21			
87-137606-00	VAUXHALL	785	3	87-139507-30	VW	875	39	87-145007-00	IVECO	280	21			
87-138000-00	FIAT	187	61	87-139507-40	VW	875	39	87-145100-00	FIAT	164	2			
87-138000-00	IVECO	268	1	87-140000-00	LAND ROVER	346	8	87-145106-00	FIAT	164	2			
87-138000-10	FIAT	188	62	87-140007-00	LAND ROVER	346	8	87-145108-00	FIAT	164	2			
87-138000-10	IVECO	268	2	87-140500-00	COMPRESSOR	119	5	87-145206-00	ALFA ROMEO	27	20			
87-138006-00	FIAT	187	61	87-140600-00	MERCEDES-BENZ	449	2	87-145300-00	ALFA ROMEO	28	22			
87-138006-00	IVECO	268	1	87-140600-00	SMART	755	2	87-145306-00	ALFA ROMEO	28	22			
87-138006-10	FIAT	188	62	87-140800-00	FORD	218	34	87-145400-00	ALFA ROMEO	25	13			
87-138006-10	IVECO	268	2	87-140800-10	FORD	220	37	87-145400-30	ALFA ROMEO	24	11			
87-138008-10	FIAT	188	62	87-140800-10	JAGUAR	310	5	87-145406-30	ALFA ROMEO	24	11			
87-138008-10	IVECO	268	2	87-140807-00	FORD	218	34	87-146100-00	ALFA ROMEO	25	15			
87-138400-00	FIAT	171	20	87-140807-10	FORD	220	37	87-146100-00	FIAT	178	38			
87-138400-00	LANCIA	334	10	87-140807-10	JAGUAR	310	5	87-146100-00	LANCIA	337	20			
87-138400-10	FIAT	170	18	87-141200-00	CHEVROLET	83	16	87-146100-00	OPEL	586	36			
87-138400-10	LANCIA	335	13	87-141200-00	OPEL	584	32	87-146100-00	SAAB	692	4			
87-138400-30	FIAT	172	22	87-141200-00	SAAB	692	2	87-146100-00	VAUXHALL	797	37			
87-138400-30	LANCIA	334	12	87-141200-00	VAUXHALL	795	33	87-146100-10	ALFA ROMEO	26	16			
87-138400-40	FIAT	170	19	87-141207-00	CHEVROLET	83	16	87-146100-10	OPEL	586	36			
87-138400-40	LANCIA	334	11	87-141207-00	OPEL	584	32	87-146100-10	SAAB	692	4			
87-138400-40	ZASTAVA	888	1	87-141207-00	SAAB	692	2	87-146100-10	VAUXHALL	797	37			
87-138406-00	FIAT	171	20	87-141207-00	VAUXHALL	795	33	87-146106-10	ALFA ROMEO	26	16			
87-138406-00	LANCIA	334	10	87-141300-00	FORD	207	12	87-146106-10	OPEL	586	36			
87-138406-10	FIAT	170	18	87-141300-00	FORD	207	13	87-146106-10	SAAB	692	4			
87-138406-10	LANCIA	335	13	87-141300-00	MAZDA	415	8	87-146106-10	VAUXHALL	797	37			
87-138406-30	FIAT	172	22	87-141300-10	FORD	207	12	87-146108-00	ALFA ROMEO	25	15			
87-138406-30	LANCIA	334	12	87-141300-20	FORD	208	14	87-146108-00	FIAT	178	38			
87-138406-40	FIAT	170	19	87-141307-00	FORD	207	12	87-146108-00	LANCIA	337	20			
87-138406-40	LANCIA	334	11	87-141307-00	FORD	207	13	87-146108-00	OPEL	586	36			
87-138406-40	ZASTAVA	888	1	87-141307-10	MAZDA	415	8	87-146108-00	SAAB	692	4			
87-138408-10	FIAT	170	18	87-141307-10	FORD	207	12	87-146108-00	VAUXHALL	797	37			
87-138408-10	LANCIA	335	13	87-141307-20	FORD	208	14	87-146400-00	MERCEDES-BENZ	494	56			
87-138900-10	CITROËN	97	11	87-141800-00	MERCEDES-BENZ	514	77	87-146500-00	DEUTZ/KHD	146	4			
87-138900-10	PEUGEOT	612	11	87-141900-00	VOLVO	821	22	87-146507-00	DEUTZ/KHD	146	4			
87-138900-30	CITROËN	97	11	87-142000-00	VOLVO	822	25	87-148100-00	FORD	223	45			
87-138900-30	PEUGEOT	612	11	87-142100-00	DEUTZ/KHD	147	5	87-148100-10	FORD	223	47			
87-138900-30	PEUGEOT	613	12	87-142107-00	DEUTZ/KHD	147	5	87-148100-30	FORD	223	46			
87-139400-00	CITROËN	102	23	87-142300-00	FIAT	170	17	87-148100-30	LAND ROVER	348	15			
87-139400-00	PEUGEOT	618	25	87-142300-00	LANCIA	333	9	87-148100-40	FORD	224	48			
87-139407-00	CITROËN	102	23	87-142306-00	FIAT	170	17	87-148100-80	FORD	224	49			
87-139407-00	PEUGEOT	618	25	87-142306-00	LANCIA	333	9	87-148100-85	FORD	224	49			
87-139500-00	AUDI	52	30	87-142308-00	FIAT	170	17	87-148105-00	FORD	223	45			
87-139500-00	MITSUBISHI	540	2	87-142308-00	LANCIA	333	9	87-148105-10	FORD	223	47			
87-139500-00	SEAT	729	33	87-142400-00	ALFA ROMEO	31	29	87-148105-30	FORD	223	46			
87-139500-00	SKODA	749	25	87-142400-00	FIAT	184	50	87-148105-30	LAND ROVER	348	15			
87-139500-00	VW	875	38	87-142400-00	LANCIA	340	26	87-148105-40	FORD	224	48			
87-139500-10	AUDI	53	31	87-142406-00	ALFA ROMEO	31	29	87-148105-80	FORD	224	49			
87-139500-10	JEEP	314	2	87-142406-00	FIAT	184	50	87-148107-00	FORD	223	45			
87-139500-10	SEAT	729	34	87-142406-00	LANCIA	340	26	87-148107-10	FORD	223	47			
87-139500-10	SKODA	749	26	87-142500-00	VOLVO	818	16	87-148107-30	FORD	223	46			
87-139500-10	VW	876	40	87-142900-00	IVECO	294	39	87-148107-30	LAND ROVER	348	15			
87-139500-20	AUDI	53	31	87-143000-00	VW	887	59	87-148107-40	FORD	224	48			
87-139500-20	JEEP	314	2	87-143007-00	VW	887	59	87-148107-80	FORD	224	49			
87-139500-20	SEAT	729	34	87-143600-00	SCANIA	703	10	87-148107-85	FORD	224	49			
87-139500-20	SKODA	749	26	87-143600-00	SCANIA	703	11	87-148300-00	AUDI	50	26			

NUMERICAL PARTS LIST















Numerische Teilenummernliste • Liste des références produits
Liste da referencias















			9				9				9
87-148300-00	AUDI	51	27	87-167600-00	DEUTZ/KHD	156	28	87-207500-00	IVECO	293	38
87-148300-00	SEAT	728	31	87-167607-00	DEUTZ/KHD	156	28	87-207500-00	NEW HOLLAND	552	11
87-148300-00	SKODA	748	24	87-167611-00	DEUTZ/KHD	156	28	87-207500-10	IVECO	293	37
87-148300-00	VW	873	35	87-172500-00	DEUTZ/KHD	148	10	87-207500-10	NEW HOLLAND	551	10
87-148300-00	VW	874	36	87-172511-00	DEUTZ/KHD	148	10	87-207500-30	IVECO	293	37
87-148307-00	AUDI	50	26	87-174100-00	DAF	138	11	87-207500-30	NEW HOLLAND	551	10
87-148307-00	AUDI	51	27	87-174100-00	LEYLAND	361	7	87-207700-00	IVECO	298	49
87-148307-00	SEAT	728	31	87-174100-30	DAF	139	12	87-207800-00	IVECO	301	57
87-148307-00	SKODA	748	24	87-174300-00	MERCEDES-BENZ	473	44	87-207800-00	NEW HOLLAND	554	19
87-148307-00	VW	873	35	87-174307-00	MERCEDES-BENZ	473	44	87-207800-10	IVECO	302	58
87-148307-00	VW	874	36	87-174311-00	MERCEDES-BENZ	473	44	87-208100-10	FORD	232	65
87-152000-10	CITROËN	107	32	87-174600-00	DEUTZ/KHD	151	16	87-209800-00	FIAT	164	1
87-152000-10	FIAT	182	47	87-174600-30	DEUTZ/KHD	151	16	87-209800-00	FIAT	165	5
87-152000-10	FSO	236	4	87-174600-30	IVECO	280	20	87-209800-00	FSO	236	1
87-152000-10	HYUNDAI	247	13	87-174607-30	DEUTZ/KHD	151	16	87-209800-00	LANCIA	331	1
87-152000-10	LADA	327	4	87-174607-30	IVECO	280	20	87-209800-00	LANCIA	331	2
87-152000-10	LDV	355	1	87-176000-00	MERCEDES-BENZ	500	62	87-209800-00	SEAT	714	1
87-152000-10	PEUGEOT	622	33	87-176000-10	MERCEDES-BENZ	499	61	87-209800-10	FIAT	165	4
87-152000-10	ROVER	687	10	87-176407-00	MERCEDES-BENZ	497	59	87-209800-10	FIAT	165	5
87-152000-10	SUZUKI	769	8	87-176600-00	MERCEDES-BENZ	456	14	87-209800-10	LANCIA	331	1
87-152000-10	TALBOT	772	3	87-176607-00	MERCEDES-BENZ	456	14	87-209806-00	FIAT	164	1
87-152007-10	CITROËN	107	32	87-176611-00	MERCEDES-BENZ	456	14	87-209806-00	FIAT	165	5
87-152007-10	FIAT	182	47	87-176700-00	MERCEDES-BENZ	472	42	87-209806-00	FSO	236	1
87-152007-10	FSO	236	4	87-176708-00	MERCEDES-BENZ	472	42	87-209806-00	LANCIA	331	1
87-152007-10	HYUNDAI	247	13	87-176800-00	MERCEDES-BENZ	498	60	87-209806-00	LANCIA	331	2
87-152007-10	LADA	327	4	87-176900-00	MERCEDES-BENZ	504	66	87-209806-00	SEAT	714	1
87-152007-10	LDV	355	1	87-176911-00	MERCEDES-BENZ	504	66	87-209806-10	FIAT	165	4
87-152007-10	PEUGEOT	622	33	87-178200-20	MERCEDES-BENZ	479	46	87-209806-10	FIAT	165	5
87-152007-10	ROVER	687	10	87-178207-20	MERCEDES-BENZ	479	46	87-209806-10	LANCIA	331	1
87-152007-10	SUZUKI	769	8	87-178211-20	MERCEDES-BENZ	479	46	87-209808-00	FIAT	164	1
87-152007-10	TALBOT	772	3	87-178800-00	MERCEDES-BENZ	473	44	87-209808-00	FIAT	165	5
87-152010-10	CITROËN	107	32	87-178807-00	MERCEDES-BENZ	473	44	87-209808-00	FSO	236	1
87-152010-10	FIAT	182	47	87-178811-00	MERCEDES-BENZ	473	44	87-209808-00	LANCIA	331	1
87-152010-10	FSO	236	4	87-179000-10	DAF	135	5	87-209808-00	LANCIA	331	2
87-152010-10	HYUNDAI	247	13	87-179300-05	MERCEDES-BENZ	511	73	87-209808-00	SEAT	714	1
87-152010-10	LADA	327	4	87-179300-16	MERCEDES-BENZ	511	73	87-209808-10	FIAT	165	4
87-152010-10	LDV	355	1	87-179300-05	MERCEDES-BENZ	510	72	87-209808-10	FIAT	165	5
87-152010-10	PEUGEOT	622	33	87-179300-20	MERCEDES-BENZ	512	74	87-209808-10	LANCIA	331	1
87-152010-10	ROVER	687	10	87-179300-50	MERCEDES-BENZ	513	75	87-214800-10	FORD	232	66
87-152010-10	SUZUKI	769	8	87-179300-60	MERCEDES-BENZ	518	83	87-214807-10	FORD	232	66
87-152010-10	TALBOT	772	3	87-179300-65	MERCEDES-BENZ	507	70	87-214809-10	FORD	232	66
87-152700-00	CITROËN	114	49	87-179300-65	MERCEDES-BENZ	519	84	87-244500-10	IVECO	290	32
87-152700-00	FIAT	190	70	87-179300-70	MERCEDES-BENZ	506	69	87-244500-40	IVECO	292	36
87-152700-00	PEUGEOT	630	53	87-179300-80	MERCEDES-BENZ	518	82	87-244500-40	NEW HOLLAND	550	8
87-152700-00	TALBOT	773	5	87-179300-85	MERCEDES-BENZ	507	70	87-245200-30	ALFA ROMEO	31	31
87-152707-00	CITROËN	114	49	87-179300-90	MERCEDES-BENZ	507	70	87-245200-30	FIAT	189	66
87-152707-00	FIAT	190	70	87-179500-10	MERCEDES-BENZ	466	31	87-245200-30	IVECO	270	5
87-152707-00	PEUGEOT	630	53	87-179507-10	MERCEDES-BENZ	466	31	87-245200-30	RENAULT	666	37
87-152707-00	TALBOT	773	5	87-181100-10	JOHN DEERE	317	3	87-245200-40	ALFA ROMEO	32	32
87-154200-00	CITROËN	93	1	87-181100-20	JOHN DEERE	317	2	87-245200-40	FIAT	189	67
87-154200-00	FIAT	169	13	87-181700-00	MERCEDES-BENZ	505	68	87-245200-40	IVECO	271	7
87-154200-00	LANCIA	333	7	87-183000-00	MERCEDES-BENZ	465	29	87-245200-40	RENAULT	666	38
87-154200-00	PEUGEOT	609	2	87-183007-00	MERCEDES-BENZ	465	29	87-245500-00	IVECO	295	43
87-154200-10	FIAT	169	15	87-183300-00	MERCEDES-BENZ	459	18	87-245500-00	NEW HOLLAND	554	17
87-154200-10	LANCIA	333	8	87-183307-00	MERCEDES-BENZ	459	18	87-245500-10	IVECO	295	42
87-154200-30	FIAT	169	16	87-202400-00	FORD	234	71	87-245500-10	NEW HOLLAND	554	17
87-154206-00	CITROËN	93	1	87-202400-10	FORD	233	69	87-245500-30	IVECO	295	43
87-154206-00	FIAT	169	13	87-202407-10	FORD	233	69	87-246200-00	ISUZU	253	4
87-154206-00	LANCIA	333	7	87-203500-00	FORD	230	62	87-247800-00	IVECO	284	28
87-154206-00	PEUGEOT	609	2	87-206800-00	IVECO	277	17	87-247800-00	NEW HOLLAND	549	7
87-154206-10	FIAT	169	15	87-206800-00	IVECO	279	19	87-247800-10	IVECO	288	30
87-154206-10	LANCIA	333	8	87-206800-00	NEW HOLLAND	547	3	87-247800-10	NEW HOLLAND	551	9
87-154206-30	FIAT	169	16	87-206800-10	IVECO	277	17	87-252500-10	DEUTZ/KHD	146	1
87-154208-00	CITROËN	93	1	87-206800-10	IVECO	279	19	87-252500-30	DEUTZ/KHD	146	2
87-154208-00	FIAT	169	13	87-206800-10	NEW HOLLAND	547	3	87-252507-10	DEUTZ/KHD	146	1
87-154208-00	LANCIA	333	7	87-206808-00	IVECO	277	17	87-252507-30	DEUTZ/KHD	146	2
87-154208-00	PEUGEOT	609	2	87-206808-00	IVECO	279	19	87-252800-00	DEUTZ/KHD	147	6
87-154208-30	FIAT	169	16	87-206808-00	NEW HOLLAND	547	3	87-263100-10	LAND ROVER	349	17
87-154300-00	CITROËN	93	3	87-207200-00	IVECO	276	14	87-263100-10	ROVER	689	15
87-154300-00	PEUGEOT	609	3	87-207200-00	NEW HOLLAND	547	2	87-263107-00	LAND ROVER	349	16
87-154400-00	CITROËN	96	10	87-207208-00	IVECO	276	14	87-263107-00	ROVER	689	15
87-154400-00	PEUGEOT	611	10	87-207208-00	NEW HOLLAND	547	2	87-263107-10	LAND ROVER	349	17

				9					9					9
87-263107-10	ROVER	689	15	87-307107-20	CHEVROLET	81	8	87-321500-10	CITROËN	103	25			
87-269806-00	LADA	327	2	87-307107-20	OPEL	578	15	87-321500-10	PEUGEOT	619	27			
87-279600-10	MWM	545	1	87-307107-20	VAUXHALL	790	16	87-321507-10	CITROËN	103	25			
87-280200-10	MAN	395	23	87-307200-00	OPEL	589	45	87-321507-10	PEUGEOT	619	27			
87-280400-00	MAN	395	24	87-307200-00	VAUXHALL	800	46	87-321510-10	CITROËN	103	25			
87-283100-00	MAN	401	32	87-307600-10	OPEL	582	25	87-321510-10	PEUGEOT	619	27			
87-283100-00	MAN	404	35	87-307600-10	VAUXHALL	793	26	87-322000-00	PERKINS	597	5			
87-283100-30	MAN	400	31	87-307600-40	CHEVROLET	83	14	87-323607-00	CITROËN	104	26			
87-283100-80	MAN	402	33	87-307600-40	HONDA	240	2	87-323607-00	HONDA	240	3			
87-283100-85	MAN	402	33	87-307600-40	OPEL	582	26	87-323607-00	PEUGEOT	620	28			
87-285800-00	MAN	380	2	87-307600-40	VAUXHALL	794	27	87-325600-00	PERKINS	602	16			
87-285900-00	MAN	381	4	87-307607-40	CHEVROLET	83	14	87-325600-10	NISSAN	569	27			
87-285900-10	MAN	380	3	87-307607-40	HONDA	240	2	87-325600-10	PERKINS	600	13			
87-285900-40	MAN	387	9	87-307607-40	OPEL	582	26	87-325600-30	NISSAN	569	27			
87-287100-30	HYUNDAI	248	17	87-307607-40	VAUXHALL	794	27	87-325600-30	PERKINS	600	13			
87-287100-30	HYUNDAI	249	18	87-307700-00	OPEL	585	34	87-325800-00	CITROËN	102	21			
87-287100-30	HYUNDAI	249	18	87-307700-00	SAAB	692	3	87-325800-00	NISSAN	561	9			
87-287107-30	HYUNDAI	248	17	87-307700-00	VAUXHALL	796	35	87-325800-00	PEUGEOT	618	23			
87-287107-30	HYUNDAI	249	18	87-307700-10	OPEL	585	33	87-325800-00	ROVER	686	6			
87-287107-30	HYUNDAI	249	18	87-307700-10	VAUXHALL	796	34	87-325806-00	CITROËN	102	21			
87-287500-20	MERCEDES-BENZ	469	36	87-307707-00	OPEL	585	34	87-325806-00	NISSAN	561	9			
87-287500-20	SSANGYONG	759	5	87-307707-00	SAAB	692	3	87-325806-00	PEUGEOT	618	23			
87-287500-30	DAEWOO	129	3	87-307707-00	VAUXHALL	796	35	87-325806-00	ROVER	686	6			
87-287500-30	MERCEDES-BENZ	469	37	87-307707-10	OPEL	585	33	87-326300-00	CITROËN	113	48			
87-287500-30	SSANGYONG	759	6	87-307707-10	VAUXHALL	796	34	87-326300-00	DAF	134	2			
87-287505-30	DAEWOO	129	3	87-307800-10	CHEVROLET	82	11	87-326300-00	FIAT	188	64			
87-287505-30	MERCEDES-BENZ	469	37	87-307800-10	OPEL	580	21	87-326300-00	PEUGEOT	630	52			
87-287505-30	SSANGYONG	759	6	87-307800-10	VAUXHALL	792	22	87-326307-00	CITROËN	113	48			
87-287507-20	MERCEDES-BENZ	469	36	87-307807-10	CHEVROLET	82	11	87-326307-00	DAF	134	2			
87-287507-20	SSANGYONG	759	5	87-307807-10	OPEL	580	21	87-326307-00	FIAT	188	64			
87-287507-30	DAEWOO	129	3	87-307807-10	VAUXHALL	792	22	87-326307-00	PEUGEOT	630	52			
87-287507-30	MERCEDES-BENZ	469	37	87-314600-00	PERKINS	596	4	87-333300-00	RENAULT	645	1			
87-287507-30	SSANGYONG	759	6	87-314600-10	PERKINS	597	5	87-333500-00	RENAULT	649	10			
87-289300-00	MERCEDES-BENZ	490	54	87-318000-00	PERKINS	602	17	87-333500-00	VOLVO	813	4			
87-289300-10	MERCEDES-BENZ	490	54	87-318700-00	FORD	229	60	87-335300-00	RENAULT	682	74			
87-289600-00	MERCEDES-BENZ	521	87	87-318700-00	LDV	356	5	87-335300-00	RENAULT	682	75			
87-306307-00	BEDFORD	66	1	87-318700-00	PEUGEOT	632	57	87-335900-00	RENAULT	681	71			
87-306307-00	OPEL	577	13	87-318700-10	CITROËN	115	51	87-335900-30	RENAULT	681	72			
87-306307-00	VAUXHALL	789	14	87-318700-10	DAF	134	3	87-336500-00	DACIA	127	14			
87-306311-00	BEDFORD	66	1	87-318700-10	FORD	229	59	87-336500-00	OPEL	583	29			
87-306311-00	OPEL	577	13	87-318700-10	LDV	356	7	87-336500-00	RENAULT	658	23			
87-306311-00	VAUXHALL	789	14	87-318700-10	PEUGEOT	631	55	87-336500-00	VAUXHALL	795	30			
87-306800-10	LADA	328	6	87-318700-10	SSANGYONG	760	9	87-336500-10	DACIA	127	15			
87-306800-10	OPEL	590	48	87-318700-30	CITROËN	115	51	87-336500-10	RENAULT	658	24			
87-306800-10	VAUXHALL	801	49	87-318700-30	DAF	134	3	87-336507-00	DACIA	127	14			
87-306800-30	CHEVROLET	85	20	87-318700-30	FORD	229	59	87-336507-00	OPEL	583	29			
87-306800-30	DAEWOO	129	2	87-318700-30	LDV	356	7	87-336507-00	RENAULT	658	23			
87-306800-30	ISUZU	253	1	87-318700-30	PEUGEOT	631	55	87-336507-00	VAUXHALL	795	30			
87-306800-30	OPEL	590	47	87-318700-30	SSANGYONG	760	9	87-336507-10	DACIA	127	15			
87-306800-30	VAUXHALL	801	48	87-318706-00	FORD	229	60	87-336507-10	RENAULT	658	24			
87-306807-10	LADA	328	6	87-318706-00	LDV	356	5	87-337500-00	RENAULT	674	58			
87-306807-10	OPEL	590	48	87-318706-00	PEUGEOT	632	57	87-337500-00	RENAULT	676	60			
87-306807-10	VAUXHALL	801	49	87-318706-10	CITROËN	115	51	87-337500-10	RENAULT	674	58			
87-306900-00	OPEL	580	20	87-318706-10	DAF	134	3	87-337500-10	RENAULT	676	60			
87-306900-00	VAUXHALL	792	21	87-318706-10	FORD	229	59	87-337500-50	RENAULT	676	61			
87-306900-10	BEDFORD	66	3	87-318706-10	LDV	356	7	87-346500-00	RENAULT	670	49			
87-306900-10	CHEVROLET	81	10	87-318706-10	PEUGEOT	631	55	87-373800-00	TOYOTA	776	6			
87-306900-10	OPEL	578	17	87-318706-10	SSANGYONG	760	9	87-373800-00	VW	886	57			
87-306900-10	VAUXHALL	791	18	87-318708-00	FORD	229	60	87-373800-10	TOYOTA	776	6			
87-306907-00	OPEL	580	20	87-318708-00	LDV	356	5	87-373800-10	VW	886	57			
87-306907-00	VAUXHALL	792	21	87-318708-00	PEUGEOT	632	57	87-404500-00	COMPRESSOR	118	4			
87-306907-10	BEDFORD	66	3	87-318710-30	CITROËN	115	51	87-404511-00	COMPRESSOR	118	4			
87-306907-10	CHEVROLET	81	10	87-318710-30	DAF	134	3	87-405500-10	VOLVO	817	15			
87-306907-10	OPEL	578	17	87-318710-30	FORD	229	59	87-407100-00	VOLVO	826	31			
87-306907-10	VAUXHALL	791	18	87-318710-30	LDV	356	7	87-420900-00	MERCEDES-BENZ	524	89			
87-306907-20	OPEL	581	22	87-318710-30	PEUGEOT	631	55	87-420900-10	MERCEDES-BENZ	524	89			
87-306907-20	VAUXHALL	792	23	87-318710-30	SSANGYONG	760	9	87-420900-50	MERCEDES-BENZ	525	90			
87-307100-20	BEDFORD	66	2	87-318711-00	FORD	229	60	87-421000-10	VW	882	48			
87-307100-20	CHEVROLET	81	8	87-318711-00	LDV	356	5	87-421000-20	VW	882	48			
87-307100-20	OPEL	578	15	87-318711-00	PEUGEOT	632	57	87-421000-30	VW	883	49			
87-307100-20	VAUXHALL	790	16	87-319000-00	PERKINS	600	11	87-421007-10	VW	882	48			
87-307107-20	BEDFORD	66	2	87-319000-10	PERKINS	599	9	87-421007-20	VW	882	48			

NUMERICAL PARTS LIST















Numerische Teilenummernliste • Liste des références produits
Liste da referencias













														
87-421007-30	VW		883	49	87-424200-00	KIA		322	5	87-427400-10	MERCEDES-BENZ		455	13
87-421600-00	CITROËN		116	55	87-424207-00	HYUNDAI		244	6	87-427400-20	MERCEDES-BENZ		454	11
87-421600-00	FIAT		192	74	87-424207-00	KIA		322	5	87-427400-30	MERCEDES-BENZ		454	11
87-421600-00	IVECO		276	15	87-424300-00	FORD		201	2	87-427400-60	MERCEDES-BENZ		454	12
87-421600-00	DAEWOO		543	9	87-424307-00	FORD		201	2	87-427400-70	MERCEDES-BENZ		454	12
87-421600-00	PEUGEOT		633	60	87-424400-00	FORD		209	16	87-427400-80	MERCEDES-BENZ		453	10
87-421600-10	CITROËN		116	54	87-424407-00	FORD		209	16	87-427400-90	MERCEDES-BENZ		453	10
87-421600-10	FIAT		192	75	87-424500-00	MAZDA		416	11	87-427407-00	MERCEDES-BENZ		455	13
87-421600-10	IVECO		276	16	87-424507-00	MAZDA		416	11	87-427407-10	MERCEDES-BENZ		455	13
87-421600-10	PEUGEOT		633	61	87-424600-00	MAZDA		413	3	87-427500-00	MERCEDES-BENZ		451	7
87-422000-00	NISSAN		564	16	87-424607-00	MAZDA		413	3	87-427500-00	NISSAN		540	3
87-422000-00	OPEL		587	40	87-424700-00	MAZDA		414	7	87-427500-00	SMART		756	4
87-422000-00	RENAULT		662	30	87-424707-00	MAZDA		414	7	87-427507-00	MERCEDES-BENZ		451	7
87-422000-00	VAUXHALL		798	41	87-424800-00	HYUNDAI		244	7	87-427507-00	MITSUBISHI		540	3
87-422000-10	NISSAN		564	17	87-424800-00	KIA		322	6	87-427507-00	SMART		756	4
87-422000-10	OPEL		587	39	87-424807-00	HYUNDAI		244	7	87-427600-10	MERCEDES-BENZ		450	5
87-422000-10	RENAULT		661	29	87-424807-00	KIA		322	6	87-427700-10	CITROËN		112	44
87-422000-10	VAUXHALL		798	40	87-424900-00	FIAT		176	32	87-427700-10	FIAT		186	57
87-422007-00	NISSAN		564	16	87-424900-00	MERCEDES-BENZ		449	3	87-427700-10	FORD		221	39
87-422007-00	OPEL		587	40	87-424900-00	NISSAN		563	14	87-427700-10	JAGUAR		310	6
87-422007-00	RENAULT		662	30	87-424900-00	OPEL		584	31	87-427700-10	LAND ROVER		347	11
87-422007-00	VAUXHALL		798	41	87-424900-00	RENAULT		661	28	87-427700-10	PEUGEOT		628	45
87-422007-10	NISSAN		564	17	87-424900-00	VAUXHALL		795	32	87-427700-30	CITROËN		112	45
87-422007-10	OPEL		587	39	87-424907-00	FIAT		176	32	87-427700-30	FIAT		186	58
87-422007-10	RENAULT		661	29	87-424907-00	MERCEDES-BENZ		449	3	87-427700-30	FORD		220	38
87-422007-10	VAUXHALL		798	40	87-424907-00	NISSAN		563	14	87-427700-30	PEUGEOT		628	46
87-422100-00	PERKINS		600	12	87-424907-00	OPEL		584	31	87-427700-40	FORD		219	36
87-422200-10	BMW		70	2	87-424907-00	RENAULT		661	28	87-427700-40	LAND ROVER		347	11
87-422207-10	BMW		70	2	87-424907-00	VAUXHALL		795	32	87-427700-50	CITROËN		112	43
87-422300-00	RENAULT		659	25	87-425200-00	LADA		327	3	87-427700-50	FORD		219	35
87-422300-10	RENAULT		660	27	87-425300-00	BMW		71	6	87-427700-50	PEUGEOT		627	44
87-422307-00	RENAULT		659	25	87-425307-00	BMW		71	6	87-427707-10	CITROËN		112	44
87-422307-10	RENAULT		660	27	87-425600-00	ALFA ROMEO		21	1	87-427707-10	FIAT		186	57
87-422400-10	TOYOTA		778	10	87-425600-00	FIAT		167	8	87-427707-10	FORD		221	39
87-422407-10	TOYOTA		778	10	87-425600-00	LANCIA		332	5	87-427707-10	JAGUAR		310	6
87-423000-00	MAN		390	15	87-425600-00	OPEL		574	4	87-427707-10	LAND ROVER		347	11
87-423000-10	MAN		389	14	87-425600-00	VAUXHALL		786	4	87-427707-10	PEUGEOT		628	45
87-423300-00	MINI		536	9	87-425606-00	ALFA ROMEO		21	1	87-427707-30	CITROËN		112	45
87-423307-00	MINI		536	9	87-425606-00	FIAT		167	8	87-427707-30	FIAT		186	58
87-423400-00	FORD		221	40	87-425606-00	LANCIA		332	5	87-427707-30	FORD		220	38
87-423400-00	MAZDA		415	10	87-425606-00	OPEL		574	4	87-427707-30	PEUGEOT		628	46
87-423400-00	VOLVO		816	12	87-425606-00	VAUXHALL		786	4	87-427707-40	FORD		219	36
87-423407-00	FORD		221	40	87-425608-00	ALFA ROMEO		21	1	87-427707-40	LAND ROVER		347	11
87-423407-00	MAZDA		415	10	87-425608-00	FIAT		167	8	87-427707-50	CITROËN		112	43
87-423407-00	VOLVO		816	12	87-425608-00	LANCIA		332	5	87-427707-50	FORD		219	35
87-423900-00	HYUNDAI		243	2	87-425608-00	OPEL		574	4	87-427707-50	PEUGEOT		627	44
87-423900-00	KIA		321	2	87-425608-00	VAUXHALL		786	4	87-427800-00	OPEL		581	24
87-423907-00	HYUNDAI		243	2	87-426100-00	FORD		205	10	87-427800-00	VAUXHALL		793	25
87-423907-00	KIA		321	2	87-426100-00	MAZDA		414	5	87-427807-00	OPEL		581	24
87-424000-00	CITROËN		98	13	87-426107-00	FORD		205	10	87-427807-00	VAUXHALL		793	25
87-424000-00	FIAT		173	27	87-426107-00	MAZDA		414	5	87-427900-00	IVECO		281	22
87-424000-00	FORD		204	8	87-426200-00	PERKINS		603	21	87-428000-00	IVECO		301	56
87-424000-00	MAZDA		413	4	87-426300-00	CITROËN		94	4	87-428600-00	MAN		391	16
87-424000-00	MINI		534	3	87-426300-00	PEUGEOT		610	4	87-428600-00	MAN		392	17
87-424000-00	PEUGEOT		614	15	87-426300-00	ZASTAVA		888	2	87-428600-10	MAN		393	20
87-424000-00	SUZUKI		767	4	87-426600-00	TOYOTA		775	4	87-428700-00	MERCEDES-BENZ		465	28
87-424000-00	VOLVO		813	3	87-426700-00	TOYOTA		775	3	87-428707-00	MERCEDES-BENZ		465	28
87-424008-00	CITROËN		98	13	87-426707-00	TOYOTA		775	3	87-428800-00	IVECO		297	46
87-424008-00	FIAT		173	27	87-426900-00	HYUNDAI		245	8	87-428900-00	MERCEDES-BENZ		488	53
87-424008-00	FORD		204	8	87-426900-00	KIA		322	7	87-429100-00	MAN		388	12
87-424008-00	MAZDA		413	4	87-426900-10	HYUNDAI		245	8	87-429100-10	MAN		388	12
87-424008-00	MINI		534	3	87-426907-00	KIA		322	7	87-429200-00	CHRYSLER		87	4
87-424008-00	PEUGEOT		614	15	87-426907-00	HYUNDAI		245	8	87-429200-00	JEEP		315	4
87-424008-00	SUZUKI		767	4	87-426907-00	KIA		322	7	87-429200-00	LDV		356	4
87-424008-00	VOLVO		813	3	87-426907-10	HYUNDAI		245	8	87-429200-00	LTI		365	1
87-424100-00	MINI		534	2	87-426907-10	KIA		322	7	87-429200-00	VM		807	3
87-424100-00	SUBARU		765	2	87-427000-00	MERCEDES-BENZ		517	80	87-429300-10	ALFA ROMEO		23	9
87-424100-00	TOYOTA		775	1	87-427000-00	MITSUBISHI		544	11	87-429300-10	CHRYSLER		87	2
87-424107-00	MINI		534	2	87-427100-00	SMART		755	3	87-429300-10	FIAT		174	30
87-424107-00	SUBARU		765	2	87-427105-00	SMART		755	3	87-429300-10	JEEP		314	1
87-424107-00	TOYOTA		775	1	87-427107-00	SMART		755	3	87-429300-10	LANCIA		335	16
87-424200-00	HYUNDAI		244	6	87-427400-00	MERCEDES-BENZ		455	13	87-429306-10	ALFA ROMEO		23	9

	 				 				 		
87-429306-10	CHRYSLER	87	2	87-431900-00	HYUNDAI	246	10	87-433600-00	VOLVO	813	2
87-429306-10	FIAT	174	30	87-431900-00	HYUNDAI	246	11	87-433607-00	CITROËN	98	14
87-429306-10	JEEP	314	1	87-431900-00	KIA	324	9	87-433607-00	FIAT	173	26
87-429306-10	LANCIA	335	16	87-431907-00	HYUNDAI	246	10	87-433607-00	FORD	205	9
87-429400-00	FORD	216	29	87-431907-00	HYUNDAI	246	11	87-433607-00	PEUGEOT	614	16
87-429407-00	FORD	216	29	87-431907-00	KIA	324	9	87-433607-00	VOLVO	813	2
87-429500-00	CHEVROLET	80	7	87-432200-00	BMW	75	12	87-433700-00	HONDA	240	1
87-429500-00	OPEL	576	10	87-432200-00	MINI	537	12	87-433707-00	HONDA	240	1
87-429500-00	VAUXHALL	788	11	87-432205-00	BMW	75	12	87-433800-00	MAN	410	43
87-429500-10	OPEL	576	11	87-432205-00	MINI	537	12	87-433900-10	AUDI	39	6
87-429500-10	SUZUKI	767	2	87-432207-00	BMW	75	12	87-433900-10	SEAT	718	13
87-429500-10	VAUXHALL	788	12	87-432207-00	MINI	537	12	87-433900-10	SKODA	741	10
87-429500-30	CHEVROLET	80	6	87-432300-00	AUDI	53	32	87-433900-10	VW	857	12
87-429500-30	OPEL	575	9	87-432300-00	SEAT	730	35	87-433907-10	AUDI	39	6
87-429500-30	VAUXHALL	788	10	87-432300-00	SKODA	750	27	87-433907-10	SEAT	718	13
87-429500-40	CHEVROLET	80	5	87-432300-00	VW	877	41	87-433907-10	SKODA	741	10
87-429500-40	OPEL	575	8	87-432300-10	AUDI	54	33	87-433907-10	VW	857	12
87-429500-40	VAUXHALL	787	9	87-432300-10	SEAT	730	36	87-434100-00	IVECO	299	51
87-429507-00	CHEVROLET	80	7	87-432300-10	SKODA	750	28	87-434200-00	HYUNDAI	245	9
87-429507-00	OPEL	576	10	87-432300-10	VW	878	42	87-434200-00	KIA	323	8
87-429507-00	VAUXHALL	788	11	87-432307-00	AUDI	53	32	87-434207-00	HYUNDAI	245	9
87-429507-10	OPEL	576	11	87-432307-00	SEAT	730	35	87-434207-00	KIA	323	8
87-429507-10	SUZUKI	767	2	87-432307-00	SKODA	750	27	87-434300-00	AUDI	58	41
87-429507-10	VAUXHALL	788	12	87-432307-00	VW	877	41	87-434300-00	VW	886	56
87-429507-30	CHEVROLET	80	6	87-432307-10	AUDI	54	33	87-434307-00	AUDI	58	41
87-429507-30	OPEL	575	9	87-432307-10	SEAT	730	36	87-434307-00	VW	886	56
87-429507-30	VAUXHALL	788	10	87-432307-10	SKODA	750	28	87-434400-00	VOLVO	839	51
87-429507-40	CHEVROLET	80	5	87-432307-10	VW	878	42	87-434400-10	RENAULT	680	69
87-429507-40	OPEL	575	8	87-432400-00	CITROËN	104	27	87-434400-10	VOLVO	839	52
87-429507-40	VAUXHALL	787	9	87-432400-00	JAGUAR	309	1	87-434400-30	VOLVO	840	53
87-429600-00	RENAULT	679	67	87-432400-00	LAND ROVER	344	3	87-434600-00	BMW	70	4
87-429600-10	RENAULT	678	66	87-432400-00	PEUGEOT	620	29	87-434600-10	BMW	71	5
87-429900-00	AUDI	40	7	87-432407-00	CITROËN	104	27	87-435000-00	RENAULT	670	47
87-429900-00	SEAT	718	14	87-432407-00	JAGUAR	309	1	87-435100-00	AUDI	56	36
87-429900-00	SKODA	741	11	87-432407-00	LAND ROVER	344	3	87-435100-00	SEAT	732	40
87-429900-00	VW	858	13	87-432407-00	PEUGEOT	620	29	87-435100-00	SKODA	751	30
87-429907-00	AUDI	40	7	87-432500-00	DAF	140	14	87-435100-00	VW	884	52
87-429907-00	SEAT	718	14	87-432500-10	DAF	140	14	87-435200-00	NISSAN	565	19
87-429907-00	SKODA	741	11	87-432900-00	AUDI	47	20	87-435200-00	OPEL	589	46
87-429907-00	VW	858	13	87-432900-00	SEAT	719	16	87-435200-00	RENAULT	663	31
87-430000-00	DEUTZ/KHD	154	22	87-432900-00	SKODA	742	13	87-435200-00	VAUXHALL	800	47
87-430000-00	RENAULT	672	54	87-432900-00	VW	861	18	87-435207-00	NISSAN	565	19
87-430000-00	VOLVO	822	24	87-432905-00	AUDI	47	20	87-435207-00	OPEL	589	46
87-430200-00	JAGUAR	311	9	87-432905-00	SEAT	719	16	87-435207-00	RENAULT	663	31
87-430200-00	LAND ROVER	347	12	87-432905-00	SKODA	742	13	87-435207-00	VAUXHALL	800	47
87-430207-00	JAGUAR	311	9	87-432905-00	VW	861	18	87-435300-00	CHEVROLET	82	12
87-430207-00	LAND ROVER	347	12	87-432907-00	AUDI	47	20	87-435300-00	OPEL	579	19
87-430300-00	CHEVROLET	83	15	87-432907-00	SEAT	719	16	87-435300-00	VAUXHALL	791	20
87-430300-00	OPEL	582	27	87-432907-00	SKODA	742	13	87-435307-00	CHEVROLET	82	12
87-430300-00	VAUXHALL	794	28	87-432907-00	VW	861	18	87-435307-00	OPEL	579	19
87-430307-00	CHEVROLET	83	15	87-433200-00	FIAT	172	24	87-435307-00	VAUXHALL	791	20
87-430307-00	OPEL	582	27	87-433200-00	LANCIA	335	14	87-435407-00	HYUNDAI	244	5
87-430307-00	VAUXHALL	794	28	87-433200-00	VAUXHALL	786	5	87-435500-00	OPEL	579	18
87-430400-00	HYUNDAI	247	12	87-433206-00	FIAT	172	24	87-435500-00	SAAB	692	1
87-430400-10	HYUNDAI	246	11	87-433206-00	LANCIA	335	14	87-435500-00	VAUXHALL	791	19
87-430400-10	KIA	324	9	87-433206-00	VAUXHALL	786	5	87-435507-00	OPEL	579	18
87-430407-00	HYUNDAI	247	12	87-433300-00	DAF	141	18	87-435507-00	SAAB	692	1
87-430407-10	HYUNDAI	246	11	87-433400-00	JEEP	314	3	87-435507-00	VAUXHALL	791	19
87-430407-10	KIA	324	9	87-433400-00	MERCEDES-BENZ	452	9	87-435700-00	ALFA ROMEO	21	2
87-430600-00	MERCEDES-BENZ	449	4	87-433400-10	MERCEDES-BENZ	451	8	87-435700-00	CHEVROLET	79	1
87-430607-00	MERCEDES-BENZ	449	4	87-433405-00	JEEP	314	3	87-435700-00	CHRYSLER	87	1
87-431000-00	MAN	397	26	87-433405-00	MERCEDES-BENZ	452	9	87-435700-00	FIAT	167	9
87-431000-00	MAN	398	27	87-433407-00	JEEP	314	3	87-435700-00	LANCIA	332	6
87-431000-10	MAN	399	29	87-433407-00	MERCEDES-BENZ	452	9	87-435700-00	OPEL	573	2
87-431000-10	MAN	399	30	87-433407-10	MERCEDES-BENZ	451	8	87-435700-00	PEUGEOT	609	1
87-431300-00	VOLVO	828	33	87-433500-00	MINI	536	8	87-435700-00	VAUXHALL	785	2
87-431300-00	VOLVO	829	34	87-433505-00	MINI	536	8	87-435700-10	OPEL	573	1
87-431600-10	MAN	389	13	87-433507-00	MINI	536	8	87-435700-10	VAUXHALL	785	1
87-431700-00	HYUNDAI	248	15	87-433600-00	CITROËN	98	14	87-435706-00	ALFA ROMEO	21	2
87-431700-00	KIA	324	11	87-433600-00	FIAT	173	26	87-435706-00	CHEVROLET	79	1
87-431707-00	HYUNDAI	248	15	87-433600-00	FORD	205	9	87-435706-00	CHRYSLER	87	1
87-431707-00	KIA	324	11	87-433600-00	PEUGEOT	614	16	87-435706-00	FIAT	167	9

NUMERICAL PARTS LIST













Numerische Teilenummernliste • Liste des références produits
Liste da referencias

														
87-435706-00	LANCIA	332	6		87-437700-00	mitsubishi		540	1	87-443800-10	VW		885	54
87-435706-00	OPEL	573	2		87-437700-00	NISSAN		561	10	87-443807-00	AUDI		57	39
87-435706-00	PEUGEOT	609	1		87-437707-00	LADA		327	1	87-443807-00	SEAT		733	43
87-435706-00	VAUXHALL	785	2		87-437707-00	MAZDA		414	6	87-443807-00	SKODA		752	33
87-435706-10	OPEL	573	1		87-437707-00	MITSUBISHI		540	1	87-443807-00	VW		885	55
87-435706-10	VAUXHALL	785	1		87-437707-00	NISSAN		561	10	87-443900-10	AUDI		38	1
87-436100-00	NISSAN	567	24		87-438500-00	AUDI		56	37	87-443900-10	SEAT		714	2
87-436100-30	NISSAN	567	24		87-438500-00	SEAT		732	41	87-443900-10	SKODA		738	1
87-436107-00	NISSAN	567	24		87-438500-00	SKODA		752	31	87-443900-10	VW		852	1
87-436107-30	NISSAN	567	24		87-438500-00	VW		884	53	87-444100-00	AUDI		48	21
87-436500-00	ALFA ROMEO	28	23		87-438507-00	AUDI		56	37	87-444100-00	SEAT		726	25
87-436500-00	CHRYSLER	87	3		87-438507-00	SEAT		732	41	87-444100-00	SKODA		747	19
87-436500-00	FIAT	181	45		87-438507-00	SKODA		752	31	87-444100-00	VW		870	29
87-436500-00	LANCIA	339	24		87-438507-00	VW		884	53	87-444105-00	AUDI		48	21
87-436500-00	OPEL	586	37		87-438800-00	RENAULT		677	64	87-444105-00	SEAT		726	25
87-436500-00	SAAB	693	6		87-438800-00	VOLVO		831	39	87-444105-00	SKODA		747	19
87-436500-00	VAUXHALL	797	38		87-438900-00	VOLVO		823	26	87-444105-00	VW		870	29
87-436506-00	ALFA ROMEO	28	23		87-439100-10	CITROËN		108	34	87-444107-00	AUDI		48	21
87-436506-00	CHRYSLER	87	3		87-439100-10	JAGUAR		309	3	87-444107-00	SEAT		726	25
87-436506-00	FIAT	181	45		87-439100-10	LAND ROVER		345	5	87-444107-00	SKODA		747	19
87-436506-00	LANCIA	339	24		87-439100-10	PEUGEOT		623	35	87-444107-00	VW		870	29
87-436506-00	OPEL	586	37		87-439107-10	CITROËN		108	34	87-444200-00	MITSUBISHI		542	8
87-436506-00	SAAB	693	6		87-439107-10	JAGUAR		309	3	87-444200-10	MITSUBISHI		542	8
87-436506-00	VAUXHALL	797	38		87-439107-10	LAND ROVER		345	5	87-444207-00	MITSUBISHI		542	8
87-436700-00	CITROËN	111	41		87-439107-10	PEUGEOT		623	35	87-444207-10	MITSUBISHI		542	8
87-436700-00	FORD	218	33		87-440500-00	MERCEDES-BENZ		450	6	87-444500-00	MERCEDES-BENZ		501	64
87-436700-00	JAGUAR	309	4		87-440900-00	MERCEDES-BENZ		460	20	87-444600-00	MERCEDES-BENZ		496	58
87-436700-00	LAND ROVER	346	9		87-441600-00	MAN		393	19	87-444600-10	MERCEDES-BENZ		495	57
87-436700-00	PEUGEOT	627	42		87-441900-00	FIAT		182	48	87-444700-00	KAMAZ		319	1
87-436700-10	CITROËN	111	40		87-442300-10	AUDI		38	2	87-444800-10	CITROËN		101	19
87-436700-10	FIAT	184	51		87-442300-10	SEAT		714	3	87-444800-10	MINI		535	5
87-436700-10	LANCIA	340	27		87-442300-10	SKODA		738	2	87-444800-10	PEUGEOT		616	20
87-436700-10	LAND ROVER	346	10		87-442300-10	VW		852	2	87-444800-30	MINI		535	6
87-436700-10	MITSUBISHI	540	4		87-442400-00	DEUTZ/KHD		152	18	87-444800-30	PEUGEOT		617	22
87-436700-10	PEUGEOT	626	41		87-442400-10	DEUTZ/KHD		150	12	87-444800-40	CITROËN		100	17
87-436708-00	CITROËN	111	41		87-442407-00	DEUTZ/KHD		152	18	87-444800-40	MINI		534	4
87-436708-00	FORD	218	33		87-442407-10	DEUTZ/KHD		150	12	87-444800-40	PEUGEOT		616	18
87-436708-00	JAGUAR	309	4		87-442900-00	CITROËN		95	8	87-444800-50	BMW		70	1
87-436708-00	LAND ROVER	346	9		87-442900-00	PEUGEOT		611	9	87-444800-50	CITROËN		100	18
87-436708-00	PEUGEOT	627	42		87-442907-00	CITROËN		95	8	87-444800-50	MINI		535	7
87-436708-10	CITROËN	111	40		87-442907-00	PEUGEOT		611	9	87-444800-50	PEUGEOT		616	19
87-436708-10	FIAT	184	51		87-443100-00	CITROËN		108	35	87-444807-10	CITROËN		101	19
87-436708-10	LANCIA	340	27		87-443100-00	FIAT		186	56	87-444807-10	MINI		535	5
87-436708-10	LAND ROVER	346	10		87-443100-00	PEUGEOT		624	36	87-444807-10	PEUGEOT		616	20
87-436708-10	MITSUBISHI	540	4		87-443100-10	CITROËN		110	39	87-444807-50	BMW		70	1
87-436708-10	PEUGEOT	626	41		87-443100-10	PEUGEOT		626	40	87-444807-50	CITROËN		100	18
87-436800-00	ALFA ROMEO	21	4		87-443108-00	CITROËN		108	35	87-444807-50	MINI		535	7
87-436800-00	FIAT	172	23		87-443108-00	FIAT		186	56	87-444807-50	PEUGEOT		616	19
87-436800-00	LANCIA	335	15		87-443108-00	PEUGEOT		624	36	87-445400-00	DAF		136	8
87-436806-00	ALFA ROMEO	21	4		87-443108-10	CITROËN		110	39	87-446200-00	ISUZU		254	6
87-436806-00	FIAT	172	23		87-443200-00	MAN		397	26	87-446300-00	ISUZU		255	8
87-436806-00	LANCIA	335	15		87-443200-00	MAN		399	29	87-446400-00	HYUNDAI		247	14
87-436900-00	SEAT	717	12		87-443200-00	MAN		398	28	87-446407-00	HYUNDAI		247	14
87-436900-00	SKODA	740	9		87-443500-00	MITSUBISHI		542	7	87-447500-10	AUDI		55	34
87-436900-00	VW	856	11		87-443500-10	MITSUBISHI		542	7	87-447500-10	SEAT		731	37
87-436907-00	SEAT	717	12		87-443507-00	MITSUBISHI		542	7	87-447500-10	SKODA		751	29
87-436907-00	SKODA	740	9		87-443600-00	SEAT		715	4	87-447500-10	VW		879	43
87-436907-00	VW	856	11		87-443600-00	SKODA		738	3	87-447500-30	VW		880	44
87-437000-00	FORD	215	28		87-443600-00	VW		852	3	87-447507-00	VW		880	44
87-437000-10	FORD	214	26		87-443700-00	DACIA		126	13	87-447800-00	SEAT		716	8
87-437007-00	FORD	215	28		87-443700-00	RENAULT		657	22	87-447800-00	SKODA		739	6
87-437007-10	FORD	214	26		87-443707-00	DACIA		126	13	87-447807-00	VW		854	7
87-437400-10	CHEVROLET	79	3		87-443707-00	RENAULT		657	22	87-447807-00	SEAT		716	8
87-437400-10	OPEL	574	6		87-443800-00	AUDI		57	39	87-447807-00	SKODA		739	6
87-437400-10	VAUXHALL	786	7		87-443800-00	SEAT		733	43	87-447807-00	VW		854	7
87-437407-10	CHEVROLET	79	3		87-443800-00	SKODA		752	33	87-447900-00	ISUZU		254	7
87-437407-10	OPEL	574	6		87-443800-00	VW		885	55	87-448500-00	HYUNDAI		243	1
87-437407-10	VAUXHALL	786	7		87-443800-10	AUDI		57	38	87-448500-00	KIA		321	1
87-437500-00	DAF	139	13		87-443800-10	SEAT		733	42	87-448507-00	HYUNDAI		243	1
87-437600-00	SCANIA	704	12		87-443800-10	SKODA		752	32	87-448507-00	KIA		321	1
87-437700-00	LADA	327	1		87-443800-10	VW		885	55	87-449000-00	FORD		203	5
87-437700-00	MAZDA	414	6		87-443800-10	SEAT		733	42	87-449007-00	FORD		203	5

	 	 9		 	 9		 	 9			
87-449500-00	AUDI	38	3	87-501500-10	VW	880	45	87-521600-00	MG	531	7
87-449500-00	SEAT	715	5	87-501500-40	VW	882	47	87-521600-00	ROVER	687	9
87-449500-00	SKODA	739	4	87-501507-00	VW	880	45	87-521700-00	AUSTIN MORRIS	62	6
87-449500-00	VW	853	4	87-501507-10	VW	880	45	87-521700-00	MG	529	1
87-449700-30	BMW	72	7	87-501507-40	VW	882	47	87-521700-00	ROVER	684	2
87-449700-30	BMW	72	8	87-501800-10	AUDI	58	40	87-521707-00	AUSTIN MORRIS	62	6
87-449700-30	MINI	536	10	87-501800-20	AUDI	56	35	87-521707-00	MG	529	1
87-449700-30	MINI	537	11	87-501800-20	SEAT	732	38	87-521707-00	ROVER	684	2
87-449700-40	BMW	72	8	87-501800-20	VW	883	50	87-521711-00	AUSTIN MORRIS	62	6
87-449700-40	MINI	537	11	87-501800-40	SEAT	732	39	87-521711-00	MG	529	1
87-449707-30	BMW	72	7	87-501800-40	VW	884	51	87-521711-00	ROVER	684	2
87-449707-30	BMW	72	8	87-501807-10	AUDI	58	40	87-521714-00	AUSTIN MORRIS	62	6
87-449707-30	MINI	536	10	87-501807-20	AUDI	56	35	87-521714-00	MG	529	1
87-449707-30	MINI	537	11	87-501807-20	SEAT	732	38	87-521714-00	ROVER	684	2
87-449707-40	BMW	72	8	87-501807-20	VW	883	50	87-521800-20	LAND ROVER	351	21
87-449707-40	MINI	537	11	87-502700-00	VOLVO	820	21	87-521800-20	ROVER	690	17
87-449900-00	VM	807	1	87-502800-00	SEAT	716	10	87-521807-20	LAND ROVER	351	21
87-450000-00	DACIA	122	1	87-502800-00	VW	855	9	87-521807-20	ROVER	690	17
87-450000-00	NISSAN	558	1	87-502807-00	SEAT	716	10	87-521811-20	LAND ROVER	351	21
87-450000-00	RENAULT	645	2	87-502807-00	VW	855	9	87-521811-20	ROVER	690	17
87-450007-00	DACIA	122	1	87-502900-00	AUDI	49	24	87-521907-00	AUSTIN MORRIS	63	8
87-450007-00	NISSAN	558	1	87-502900-00	SEAT	727	29	87-521907-00	MG	531	8
87-450007-00	RENAULT	645	2	87-502900-00	SKODA	747	20	87-521911-00	AUSTIN MORRIS	63	8
87-450400-00	DACIA	122	3	87-502900-00	VW	872	33	87-521911-00	MG	531	8
87-450400-00	RENAULT	647	6	87-502900-10	AUDI	50	25	87-522307-00	AUSTIN MORRIS	60	1
87-450400-10	DACIA	122	2	87-502900-10	SEAT	728	30	87-522309-00	AUSTIN MORRIS	60	1
87-450400-10	NISSAN	558	3	87-502900-10	SKODA	748	22	87-522314-00	AUSTIN MORRIS	60	1
87-450400-10	RENAULT	647	5	87-502900-10	VW	872	34	87-522400-00	AUSTIN MORRIS	60	3
87-450500-00	ALFA ROMEO	21	3	87-502900-30	AUDI	51	28	87-522400-00	MINI	534	1
87-450500-00	FIAT	168	10	87-502900-30	SEAT	729	32	87-522400-00	ROVER	684	1
87-450600-00	FIAT	188	63	87-502900-30	SKODA	748	23	87-522600-00	JAGUAR	310	7
87-450600-00	IVECO	268	3	87-502900-30	VW	874	37	87-522607-00	JAGUAR	310	7
87-450900-00	FIAT	168	12	87-502905-10	AUDI	50	25	87-522700-00	LAND ROVER	344	1
87-451700-00	MAN	392	17	87-502905-10	SEAT	728	30	87-522700-00	LOTUS	364	1
87-452400-00	FORD	202	3	87-502905-10	SKODA	748	22	87-522700-00	MG	530	5
87-452407-00	FORD	202	3	87-502905-10	VW	872	34	87-522700-00	ROVER	686	7
87-452600-00	NISSAN	567	24	87-502905-10	AUDI	49	24	87-522700-10	LOTUS	364	2
87-452607-00	NISSAN	567	24	87-502907-00	SEAT	727	29	87-522700-10	MG	530	6
87-452700-00	CITROËN	102	22	87-502907-00	SKODA	747	20	87-522700-10	ROVER	686	8
87-452700-00	PEUGEOT	618	24	87-502907-00	VW	872	33	87-522900-00	RENAULT	670	48
87-452707-00	CITROËN	102	22	87-502907-10	AUDI	50	25	87-522900-10	RENAULT	672	52
87-452707-00	PEUGEOT	618	24	87-502907-10	SEAT	728	30	87-522900-30	RENAULT	672	53
87-452800-10	FORD	206	11	87-502907-10	SKODA	748	22	87-522900-40	RENAULT	671	51
87-452800-30	FORD	208	15	87-502907-10	VW	872	34	87-523000-00	DEUTZ/KHD	156	26
87-452800-30	VOLVO	815	9	87-502907-30	AUDI	51	28	87-523000-00	IVECO	294	41
87-452807-10	FORD	206	11	87-502907-30	SEAT	729	32	87-523000-00	NEW HOLLAND	553	16
87-452807-30	FORD	208	15	87-502907-30	SKODA	748	23	87-523600-00	JAGUAR	311	10
87-452807-30	VOLVO	815	9	87-502907-30	VW	874	37	87-523800-00	LISTER	363	2
87-452900-00	FORD	216	30	87-520100-00	LAND ROVER	348	13	87-523807-00	LISTER	363	2
87-452907-00	FORD	216	30	87-520100-00	LDV	355	2	87-523811-00	LISTER	363	2
87-453000-00	CITROËN	101	20	87-520100-00	ROVER	688	13	87-524000-00	JAGUAR	312	12
87-453000-00	PEUGEOT	617	21	87-520100-10	LAND ROVER	348	14	87-524000-10	JAGUAR	312	12
87-453007-00	CITROËN	101	20	87-520100-10	ROVER	688	14	87-524007-00	JAGUAR	312	12
87-453007-00	PEUGEOT	617	21	87-520107-00	LAND ROVER	348	13	87-524007-10	JAGUAR	312	12
87-453100-00	CITROËN	99	16	87-520107-00	LDV	355	2	87-524009-00	JAGUAR	312	12
87-453100-00	OPEL	577	14	87-520107-00	ROVER	688	13	87-524100-00	AUSTIN MORRIS	61	5
87-453100-00	PEUGEOT	615	17	87-520107-10	LAND ROVER	348	14	87-524100-00	MG	529	1
87-453100-00	VAUXHALL	790	15	87-520107-10	ROVER	688	14	87-524100-00	MG	529	2
87-453107-00	CITROËN	99	16	87-520200-00	FIAT	189	68	87-524100-00	ROVER	684	3
87-453107-00	OPEL	577	14	87-520200-00	IVECO	270	6	87-524107-00	AUSTIN MORRIS	61	5
87-453107-00	PEUGEOT	615	17	87-520200-00	RENAULT	666	39	87-524107-00	MG	529	1
87-453107-00	VAUXHALL	790	15	87-520500-00	FSO	236	2	87-524107-00	MG	529	2
87-453200-00	OPEL	577	12	87-520500-00	MG	530	4	87-524107-00	ROVER	684	3
87-453200-00	VAUXHALL	789	13	87-520500-00	ROVER	685	5	87-524111-00	AUSTIN MORRIS	61	5
87-453207-00	OPEL	577	12	87-521300-00	NEW HOLLAND	552	12	87-524111-00	MG	529	1
87-453207-00	VAUXHALL	789	13	87-521300-10	NEW HOLLAND	552	13	87-524111-00	MG	529	2
87-453500-00	AUDI	38	4	87-521307-00	NEW HOLLAND	552	12	87-524111-00	ROVER	684	3
87-453500-00	SEAT	715	6	87-521400-00	NEW HOLLAND	553	14	87-524114-00	AUSTIN MORRIS	61	5
87-453500-00	SKODA	739	5	87-521407-00	NEW HOLLAND	553	14	87-524114-00	MG	529	1
87-453500-00	VW	853	5	87-521500-00	LAND ROVER	353	24	87-524114-00	MG	529	2
87-501400-00	VOLVO	819	19	87-521500-10	LAND ROVER	352	23	87-524114-00	ROVER	684	3
87-501500-00	VW	880	45	87-521600-00	LAND ROVER	344	2	87-524307-10	AUSTIN MORRIS	60	2

NUMERICAL PARTS LIST













Numerische Teilenummernliste • Liste des références produits
Liste da referencias













				9					9					9
87-524307-10	ROVER	684	1		87-740300-00	DEUTZ/KHD	157	29		87-783800-30	ALFA ROMEO	26	18	
87-524311-10	AUSTIN MORRIS	60	2		87-740300-00	IVECO	300	53		87-783800-30	FIAT	179	41	
87-524311-10	ROVER	684	1		87-740900-00	DEUTZ/KHD	150	13		87-783800-30	FIAT	180	43	
87-524314-10	AUSTIN MORRIS	60	2		87-740900-30	DEUTZ/KHD	150	13		87-783800-30	LANCIA	337	22	
87-524314-10	ROVER	684	1		87-741200-10	COMPRESSOR	118	2		87-783808-30	ALFA ROMEO	26	18	
87-524400-00	LAND ROVER	350	19		87-741207-10	COMPRESSOR	118	2		87-783808-30	FIAT	179	41	
87-524400-00	ROVER	689	16		87-741211-10	COMPRESSOR	118	2		87-783808-30	FIAT	180	43	
87-525000-00	LISTER	363	1		87-741600-00	DAF	135	6		87-783808-30	LANCIA	337	22	
87-525007-00	LISTER	363	1		87-741800-00	DEUTZ/KHD	148	10		87-783900-00	IVECO	283	25	
87-525011-00	LISTER	363	1		87-741807-00	DEUTZ/KHD	148	10		87-783900-00	NEW HOLLAND	549	6	
87-525014-00	LISTER	363	1		87-741807-20	DEUTZ/KHD	148	8		87-783900-10	IVECO	283	26	
87-525100-00	PERKINS	597	5		87-743100-00	MERCEDES-BENZ	468	35		87-784107-00	FORD	201	1	
87-525100-10	PERKINS	596	4		87-743100-00	SSANGYONG	758	4		87-784800-00	FORD	227	55	
87-525200-00	LEYLAND	360	5		87-743100-10	MERCEDES-BENZ	466	32		87-784800-00	FORD	227	56	
87-525200-00	PERKINS	599	10		87-743100-10	SSANGYONG	758	2		87-784821-00	FORD	227	55	
87-525300-00	LEYLAND	359	3		87-743100-40	MERCEDES-BENZ	467	33		87-784821-00	FORD	227	56	
87-525400-00	TRIUMPH MOTORCYCLE	780	1		87-743107-00	MERCEDES-BENZ	468	35		87-785000-00	FORD	203	6	
87-525411-00	TRIUMPH MOTORCYCLE	780	1		87-743107-00	SSANGYONG	758	4		87-785000-00	MAZDA	413	2	
87-525414-00	TRIUMPH MOTORCYCLE	780	1		87-743107-10	MERCEDES-BENZ	466	32		87-785007-00	FORD	203	6	
87-525507-00	JAGUAR	311	8		87-743107-10	SSANGYONG	758	2		87-785007-00	MAZDA	413	2	
87-525509-00	JAGUAR	311	8		87-743107-40	MERCEDES-BENZ	467	33		87-785011-00	FORD	203	6	
87-525700-00	TRIUMPH	779	1		87-743107-50	MERCEDES-BENZ	468	35		87-785011-00	MAZDA	413	2	
87-525707-00	TRIUMPH	779	1		87-743107-50	SSANGYONG	758	4		87-785300-10	IVECO	298	48	
87-525709-00	TRIUMPH	779	1		87-743120-10	MERCEDES-BENZ	466	32		87-785500-00	FIAT	174	29	
87-525711-00	TRIUMPH	779	1		87-743120-10	SSANGYONG	758	2		87-785500-00	FSO	236	3	
87-525900-00	AUSTIN MORRIS	63	8		87-743200-00	MERCEDES-BENZ	520	86		87-785506-00	FIAT	174	29	
87-525900-00	MG	531	8		87-743400-30	DAF	141	19		87-785506-00	FSO	236	3	
87-525907-00	AUSTIN MORRIS	63	8		87-743400-40	DAF	141	16		87-785508-00	FIAT	174	29	
87-525907-00	MG	531	8		87-743400-50	DAF	141	17		87-785508-00	FSO	236	3	
87-525909-00	AUSTIN MORRIS	63	8		87-743600-10	MERCEDES-BENZ	457	15		87-786400-00	FORD	217	31	
87-525909-00	MG	531	8		87-743600-30	MERCEDES-BENZ	457	16		87-786407-00	FORD	217	31	
87-525911-00	AUSTIN MORRIS	63	8		87-743607-10	MERCEDES-BENZ	457	15		87-786500-00	FORD	213	22	
87-525911-00	MG	531	8		87-743607-30	MERCEDES-BENZ	457	16		87-786507-00	FORD	213	22	
87-525914-00	AUSTIN MORRIS	63	8		87-744600-00	DEUTZ/KHD	148	10		87-849000-00	HYUNDAI	243	3	
87-525914-00	MG	531	8		87-744611-00	DEUTZ/KHD	148	10		87-849000-00	KIA	321	3	
87-526300-00	HINO	238	1		87-780300-10	FORD	225	51		87-849007-00	HYUNDAI	243	3	
87-526300-00	TOYOTA	778	9		87-780300-30	FORD	226	52		87-849007-00	KIA	321	3	
87-526600-00	AUSTIN MORRIS	62	7		87-780307-10	FORD	225	51		87-849200-00	HYUNDAI	244	4	
87-526600-00	MG	529	3		87-780311-10	FORD	225	51		87-849200-00	KIA	321	4	
87-527200-00	ALFA ROMEO	22	6		87-780314-10	FORD	225	51		87-849207-00	HYUNDAI	244	4	
87-527600-00	FIAT	166	6		87-780600-10	FORD	214	24		87-849207-00	KIA	321	4	
87-527606-00	FIAT	166	6		87-780607-00	FORD	214	25		87-854700-00	FIAT	191	71	
87-527608-00	FIAT	166	6		87-780607-10	FORD	214	24		87-854700-00	IVECO	272	9	
87-528300-00	FIAT	168	11		87-780609-00	FORD	214	25		87-854700-00	OPEL	593	58	
87-528306-00	FIAT	168	11		87-780609-10	FORD	214	24		87-854700-00	VAUXHALL	804	58	
87-528400-00	FIAT	173	25		87-780611-10	FORD	214	24		87-854708-00	FIAT	191	71	
87-528406-00	FIAT	173	25		87-780614-00	FORD	214	25		87-854708-00	IVECO	272	9	
87-528408-00	FIAT	173	25		87-780614-10	FORD	214	24		87-854708-00	OPEL	593	58	
87-528500-00	ALFA ROMEO	23	10		87-780617-00	FORD	214	25		87-854708-00	VAUXHALL	804	58	
87-529907-00	JAGUAR	309	2		87-780617-10	FORD	214	24		87-879200-00	CHEVROLET	84	17	
87-529909-00	JAGUAR	309	2		87-781900-10	IVECO	278	18		87-879200-00	DAEWOO	129	1	
87-529911-00	JAGUAR	309	2		87-781900-10	NEW HOLLAND	548	4		87-879200-00	OPEL	587	38	
87-530100-00	AUSTIN MORRIS	63	10		87-781900-30	IVECO	279	19		87-879200-00	VAUXHALL	798	39	
87-530100-00	MG	532	9		87-781900-30	NEW HOLLAND	547	3		87-879207-00	CHEVROLET	84	17	
87-530107-00	AUSTIN MORRIS	63	10		87-781908-10	IVECO	278	18		87-879207-00	DAEWOO	129	1	
87-530107-00	MG	532	9		87-781908-10	NEW HOLLAND	548	4		87-879207-00	OPEL	587	38	
87-530109-00	AUSTIN MORRIS	63	10		87-781908-30	IVECO	279	19		87-879207-00	VAUXHALL	798	39	
87-530109-00	MG	532	9		87-781908-30	NEW HOLLAND	547	3		87-896800-00	STEYR	763	3	
87-530400-00	ALFA ROMEO	22	5		87-782000-00	IVECO	282	24		87-962000-30	SCANIA	705	15	
87-704200-10	BMW	70	3		87-782000-00	NEW HOLLAND	548	5		87-962000-50	SCANIA	708	20	
87-704207-10	BMW	70	3		87-782008-00	IVECO	282	24		87-962000-80	SCANIA	706	16	
87-714400-00	LAND ROVER	351	20		87-782008-00	NEW HOLLAND	548	5		87-990100-10	AUDI	43	15	
87-714400-00	LDV	355	3		87-782100-00	IVECO	306	63		87-990100-10	SEAT	721	19	
87-740000-10	MERCEDES-BENZ	487	51		87-782606-00	LANCIA	331	3		87-990100-10	VW	864	22	
87-740000-20	MERCEDES-BENZ	487	52		87-782608-00	LANCIA	331	3		87-990100-40	AUDI	42	13	
87-740000-30	MERCEDES-BENZ	480	47		87-782900-00	FORD	233	67		87-990100-40	SEAT	720	17	
87-740000-40	MERCEDES-BENZ	482	48		87-782906-00	FORD	233	67		87-990100-40	SKODA	743	14	
87-740000-50	MERCEDES-BENZ	484	50		87-783000-00	IVECO	304	60		87-990100-40	VW	862	20	
87-740007-10	MERCEDES-BENZ	487	51		87-783000-10	IVECO	305	61		87-990105-40	AUDI	42	13	
87-740007-20	MERCEDES-BENZ	487	52		87-783000-10	IVECO	305	62		87-990105-40	SEAT	720	17	
87-740007-40	MERCEDES-BENZ	482	48		87-783000-15	IVECO	305	61		87-990105-40	SKODA	743	14	
87-740007-50	MERCEDES-BENZ	484	50		87-783000-30	IVECO	305	61		87-990105-40	VW	862	20	

			
87-990107-10	AUDI	43	15
87-990107-10	SEAT	721	19
87-990107-10	VW	864	22
87-990107-40	AUDI	42	13
87-990107-40	SEAT	720	17
87-990107-40	SKODA	743	14
87-990107-40	VW	862	20
87-990111-10	AUDI	43	15
87-990111-10	SEAT	721	19
87-990111-10	VW	864	22
87-990111-40	AUDI	42	13
87-990111-40	SEAT	720	17
87-990111-40	SKODA	743	14
87-990111-40	VW	862	20
87-990707-00	COMPRESSOR	118	1

NUMERICAL PARTS LIST













Numerische Teilenummernliste • Liste des références produits
Liste da referencias













	 	 9		 	 9		 	 9			
13-451070-00	MERCEDES-BENZ	514	76	14-010920-00	ROVER	689	16	14-013481-00	FIAT	190	70
13-451070-00	MERCEDES-BENZ	517	80	14-010920-00	ROVER	690	17	14-013481-00	PEUGEOT	630	53
13-451220-00	MERCEDES-BENZ	524	89	14-010940-00	IVECO	284	28	14-013481-00	PEUGEOT	631	54
13-451220-00	MERCEDES-BENZ	525	90	14-010940-00	IVECO	285	29	14-013481-00	TALBOT	773	5
14-000230-00	COMPRESSOR	118	3	14-010940-00	IVECO	288	30	14-013481-00	TALBOT	773	6
14-000230-00	COMPRESSOR	118	4	14-010940-00	IVECO	289	31	14-013700-00	FORD	231	63
14-000240-00	COMPRESSOR	118	3	14-010940-00	IVECO	290	32	14-014090-00	FORD	226	54
14-000240-00	COMPRESSOR	118	4	14-010940-00	IVECO	290	33	14-014090-00	FORD	227	55
14-000350-00	COMPRESSOR	119	5	14-010940-00	IVECO	291	34	14-014090-00	FORD	227	56
14-010170-00	IVECO	277	17	14-010940-00	IVECO	292	35	14-014090-00	FORD	228	57
14-010170-00	IVECO	279	19	14-010940-00	IVECO	292	36	14-014120-00	FORD	232	66
14-010170-00	NEW HOLLAND	547	3	14-010940-00	NEW HOLLAND	549	7	14-014640-00	FORD	232	66
14-010180-00	IVECO	282	24	14-010940-00	NEW HOLLAND	550	8	14-014730-00	ALFA ROMEO	26	18
14-010180-00	IVECO	283	25	14-010940-00	NEW HOLLAND	551	9	14-014730-00	ALFA ROMEO	27	19
14-010180-00	IVECO	283	26	14-010941-10	IVECO	284	28	14-014730-00	CITROËN	105	29
14-010180-00	IVECO	284	27	14-010941-10	IVECO	285	29	14-014730-00	FIAT	179	40
14-010180-00	NEW HOLLAND	548	5	14-010941-10	IVECO	288	30	14-014730-00	FIAT	180	42
14-010180-00	NEW HOLLAND	549	6	14-010941-10	IVECO	289	31	14-014730-00	FIAT	180	43
14-010181-00	IVECO	282	24	14-010941-10	IVECO	290	32	14-014730-00	LANCIA	337	22
14-010181-00	IVECO	283	25	14-010941-10	IVECO	290	33	14-014730-00	LANCIA	338	23
14-010181-00	IVECO	283	26	14-010941-10	IVECO	291	34	14-015590-00	HYUNDAI	248	16
14-010181-00	IVECO	284	27	14-010941-10	IVECO	292	36	14-015590-00	HYUNDAI	248	17
14-010181-00	NEW HOLLAND	548	5	14-010941-10	NEW HOLLAND	549	7	14-015590-00	HYUNDAI	249	18
14-010181-00	NEW HOLLAND	549	6	14-010941-10	NEW HOLLAND	550	8	14-015590-00	HYUNDAI	249	18
14-010182-00	IVECO	282	24	14-010941-10	NEW HOLLAND	551	9	14-015590-00	HYUNDAI	249	18
14-010182-00	IVECO	283	25	14-010970-00	HYUNDAI	249	19	14-015590-00	MITSUBISHI	541	5
14-010182-00	IVECO	283	26	14-010970-00	MITSUBISHI	544	10	14-015590-00	MITSUBISHI	541	6
14-010182-00	IVECO	284	27	14-010991-00	FIAT	169	13	14-015590-00	MITSUBISHI	542	8
14-010182-00	NEW HOLLAND	548	5	14-010991-00	FIAT	169	14	14-018002-00	IVECO	300	54
14-010182-00	NEW HOLLAND	549	6	14-010991-00	FIAT	169	15	14-020110-00	FORD	230	61
14-010620-00	IVECO	276	14	14-010991-00	FIAT	169	16	14-020110-00	ISUZU	254	5
14-010620-00	NEW HOLLAND	547	2	14-010991-00	FIAT	170	17	14-020110-00	LTi	365	2
14-010770-00	FORD	231	64	14-010991-00	LANCIA	333	7	14-020110-00	NISSAN	568	26
14-010770-00	FORD	232	65	14-010991-00	LANCIA	333	8	14-020200-00	IVECO	298	25
14-010780-00	IVECO	278	18	14-010991-00	LANCIA	333	9	14-020200-00	NISSAN	562	13
14-010780-00	NEW HOLLAND	548	4	14-011001-00	FIAT	164	1	14-020280-00	OPEL	583	30
14-010781-00	IVECO	278	18	14-011001-00	FIAT	164	2	14-020280-00	RENAULT	659	26
14-010781-00	NEW HOLLAND	548	4	14-011001-00	FIAT	164	3	14-020280-00	VAUXHALL	795	31
14-010782-00	IVECO	278	18	14-011001-00	FIAT	165	4	14-020280-00	VOLVO	816	10
14-010782-00	NEW HOLLAND	548	4	14-011001-00	FIAT	165	5	14-020290-00	CITROËN	104	28
14-010820-00	NEW HOLLAND	552	12	14-011001-00	FSO	236	1	14-020290-00	FIAT	178	39
14-010820-00	NEW HOLLAND	552	13	14-011001-00	LANCIA	331	1	14-020290-00	PEUGEOT	620	30
14-010820-00	NEW HOLLAND	553	14	14-011001-00	LANCIA	331	2	14-020300-00	MERCEDES-BENZ	461	21
14-010830-00	FORD	204	7	14-011001-00	LANCIA	331	2	14-020300-00	MERCEDES-BENZ	461	22
14-010840-00	KIA	324	10	14-011001-00	SEAT	714	1	14-020300-00	MERCEDES-BENZ	462	23
14-010840-00	MAZDA	415	9	14-011021-00	IVECO	277	17	14-020300-00	MERCEDES-BENZ	463	24
14-010850-00	TOYOTA	776	6	14-011021-00	IVECO	279	19	14-020300-00	MERCEDES-BENZ	463	25
14-010850-00	TOYOTA	777	7	14-011022-00	NEW HOLLAND	547	3	14-020300-00	MERCEDES-BENZ	464	27
14-010850-00	VW	886	57	14-011022-00	IVECO	277	17	14-020330-00	RENAULT	680	70
14-010880-00	FORD	213	23	14-011022-00	IVECO	279	19	14-020330-00	RENAULT	681	71
14-010880-00	FORD	214	24	14-011022-00	NEW HOLLAND	547	3	14-020330-00	RENAULT	682	75
14-010880-00	FORD	214	25	14-011031-00	NEW HOLLAND	547	1	14-020350-00	NISSAN	564	18
14-010890-00	AUSTIN MORRIS	61	4	14-011041-00	ALFA ROMEO	30	27	14-020351-00	NISSAN	564	18
14-010890-00	AUSTIN MORRIS	61	5	14-011041-00	ALFA ROMEO	31	29	14-020420-00	VW	880	45
14-010890-00	AUSTIN MORRIS	62	6	14-011041-00	FIAT	183	49	14-020420-00	VW	881	46
14-010890-00	MG	529	1	14-011041-00	FIAT	184	50	14-020420-00	VW	882	48
14-010890-00	MG	529	2	14-011041-00	LANCIA	339	25	14-020420-00	VW	883	49
14-010890-00	ROVER	684	2	14-011041-00	LANCIA	340	26	14-020421-00	VW	880	45
14-010890-00	ROVER	684	3	14-011061-00	IVECO	276	14	14-020421-00	VW	881	46
14-010900-00	ALFA ROMEO	23	8	14-011061-00	NEW HOLLAND	547	2	14-020421-00	VW	882	48
14-010900-00	BEDFORD	66	4	14-011560-10	DAF	136	8	14-020421-00	VW	883	49
14-010900-00	FORD	209	17	14-012260-00	MERCEDES-BENZ	478	45	14-020450-00	CHEVROLET	85	21
14-010900-00	PERKINS	596	2	14-012260-00	MERCEDES-BENZ	480	47	14-020450-00	OPEL	591	49
14-010920-00	AUSTIN MORRIS	64	11	14-012260-00	MERCEDES-BENZ	482	48	14-020450-00	SUBARU	765	3
14-010920-00	LAND ROVER	349	16	14-012260-00	MERCEDES-BENZ	483	49	14-020450-00	VAUXHALL	802	50
14-010920-00	LAND ROVER	349	17	14-012260-00	MERCEDES-BENZ	484	50	14-020490-00	DEUTZ/KHD	147	6
14-010920-00	LAND ROVER	350	18	14-012260-00	MERCEDES-BENZ	487	51	14-020510-00	RENAULT	680	70
14-010920-00	LAND ROVER	350	19	14-012260-00	MERCEDES-BENZ	487	52	14-020510-00	RENAULT	682	75
14-010920-00	LAND ROVER	351	20	14-012470-00	FIAT	174	28	14-020530-00	CITROËN	107	32
14-010920-00	LAND ROVER	351	21	14-013401-00	IVECO	277	17	14-020530-00	CITROËN	107	33
14-010920-00	LDV	355	3	14-013401-00	IVECO	279	19	14-020530-00	FIAT	182	46
14-010920-00	ROVER	689	15	14-013481-00	CITROËN	114	49	14-020530-00	FIAT	182	47
14-010920-00	ROVER	689	15	14-013481-00	CITROËN	114	50	14-020530-00	FSO	236	4

				9					9					9
14-020530-00	HYUNDAI	247	13		14-020760-00	CITROËN	94	6		14-021220-00	PERKINS	598	6	
14-020530-00	LADA	327	4		14-020760-00	FORD	203	4		14-021221-00	PERKINS	596	4	
14-020530-00	LADA	328	5		14-020760-00	MAZDA	413	1		14-021221-00	PERKINS	597	5	
14-020530-00	LDV	355	1		14-020760-00	PEUGEOT	610	6		14-021221-00	PERKINS	598	6	
14-020530-00	PEUGEOT	622	33		14-020760-00	PEUGEOT	610	7		14-021230-00	IVECO	301	57	
14-020530-00	PEUGEOT	623	34		14-020760-00	TOYOTA	775	2		14-021230-00	IVECO	302	58	
14-020530-00	ROVER	687	10		14-020761-00	CITROËN	94	5		14-021230-00	IVECO	303	59	
14-020530-00	SUZUKI	768	7		14-020761-00	CITROËN	94	6		14-021230-00	IVECO	304	60	
14-020530-00	SUZUKI	769	8		14-020761-00	FORD	203	4		14-021230-00	IVECO	305	61	
14-020530-00	TALBOT	772	3		14-020761-00	MAZDA	413	1		14-021230-00	IVECO	305	62	
14-020540-00	FORD	222	43		14-020761-00	PEUGEOT	610	6		14-021232-00	IVECO	301	57	
14-020540-00	FORD	222	44		14-020761-00	PEUGEOT	610	7		14-021232-00	IVECO	302	58	
14-020540-00	FORD	223	45		14-020761-00	TOYOTA	775	2		14-021232-00	IVECO	303	59	
14-020540-00	FORD	223	46		14-020780-00	ISUZU	254	6		14-021232-00	IVECO	304	60	
14-020540-00	FORD	223	47		14-020870-00	PERKINS	603	20		14-021232-00	IVECO	305	61	
14-020540-00	FORD	224	48		14-020870-00	PERKINS	603	21		14-021232-00	IVECO	305	62	
14-020540-00	FORD	224	49		14-020900-00	CITROËN	98	13		14-021240-00	PERKINS	596	3	
14-020590-00	PERKINS	603	19		14-020900-00	CITROËN	98	14		14-021311-00	ALFA ROMEO	26	18	
14-020600-00	HYUNDAI	249	18		14-020900-00	CITROËN	99	15		14-021311-00	ALFA ROMEO	27	19	
14-020600-00	MITSUBISHI	541	5		14-020900-00	FIAT	173	27		14-021311-00	CITROËN	105	29	
14-020600-00	MITSUBISHI	541	6		14-020900-00	FORD	204	8		14-021311-00	FIAT	180	42	
14-020600-00	MITSUBISHI	542	8		14-020900-00	FORD	205	9		14-021311-00	FIAT	180	43	
14-020610-00	CUMMINS	120	1		14-020900-00	MINI	534	3		14-021311-00	LANCIA	337	22	
14-020650-00	DACIA	123	4		14-020900-00	PEUGEOT	614	15		14-021311-00	LANCIA	338	23	
14-020650-00	DACIA	123	5		14-020900-00	PEUGEOT	614	16		14-021321-00	CITROËN	115	52	
14-020650-00	DACIA	123	6		14-020900-00	SUZUKI	767	4		14-021321-00	CITROËN	115	53	
14-020650-00	DACIA	124	7		14-020900-00	VOLVO	813	2		14-021321-00	FIAT	191	71	
14-020650-00	DACIA	124	8		14-021051-00	ALFA ROMEO	25	14		14-021321-00	FIAT	191	72	
14-020650-00	DACIA	125	9		14-021051-00	ALFA ROMEO	25	15		14-021321-00	FIAT	192	73	
14-020650-00	NISSAN	558	4		14-021051-00	ALFA ROMEO	26	17		14-021321-00	IVECO	272	9	
14-020650-00	NISSAN	559	5		14-021051-00	FIAT	177	35		14-021321-00	IVECO	274	10	
14-020650-00	NISSAN	559	6		14-021051-00	FIAT	177	36		14-021321-00	IVECO	274	11	
14-020650-00	NISSAN	560	7		14-021051-00	FIAT	178	37		14-021321-00	IVECO	274	12	
14-020650-00	NISSAN	560	8		14-021051-00	FIAT	178	38		14-021321-00	IVECO	275	13	
14-020650-00	RENAULT	650	11		14-021051-00	LANCIA	336	19		14-021321-00	OPEL	593	58	
14-020650-00	RENAULT	651	12		14-021051-00	LANCIA	337	20		14-021321-00	PEUGEOT	632	58	
14-020650-00	RENAULT	652	13		14-021051-00	LANCIA	337	21		14-021321-00	PEUGEOT	633	59	
14-020650-00	RENAULT	652	14		14-021051-00	SUZUKI	768	6		14-021321-00	RENAULT	668	41	
14-020650-00	RENAULT	653	15		14-021080-00	FIAT	170	19		14-021321-00	RENAULT	668	42	
14-020650-00	RENAULT	654	16		14-021080-00	FIAT	171	21		14-021321-00	RENAULT	668	43	
14-020650-00	RENAULT	654	17		14-021080-00	FIAT	172	22		14-021321-00	RENAULT	669	44	
14-020650-00	SUZUKI	768	5		14-021080-00	LANCIA	334	10		14-021321-00	VAUXHALL	804	58	
14-020660-00	CITROËN	115	51		14-021080-00	LANCIA	334	11		14-021350-00	MERCEDES-BENZ	472	42	
14-020660-00	DAF	134	3		14-021080-00	LANCIA	334	12		14-021350-00	MERCEDES-BENZ	473	43	
14-020660-00	DAF	135	4		14-021080-00	LANCIA	335	13		14-021361-00	IVECO	284	28	
14-020660-00	FORD	228	58		14-021080-00	ZASTAVA	888	1		14-021361-00	IVECO	285	29	
14-020660-00	FORD	229	59		14-021120-00	CITROËN	112	44		14-021361-00	IVECO	288	30	
14-020660-00	FORD	229	60		14-021120-00	CITROËN	112	45		14-021361-00	IVECO	289	31	
14-020660-00	LDV	356	5		14-021120-00	FIAT	186	57		14-021361-00	IVECO	290	32	
14-020660-00	LDV	356	6		14-021120-00	FIAT	186	58		14-021361-00	IVECO	290	33	
14-020660-00	LDV	356	7		14-021120-00	FORD	219	36		14-021361-00	IVECO	291	34	
14-020660-00	PEUGEOT	631	55		14-021120-00	FORD	220	38		14-021361-00	IVECO	292	36	
14-020660-00	PEUGEOT	632	56		14-021120-00	FORD	221	39		14-021361-00	NEW HOLLAND	549	7	
14-020660-00	PEUGEOT	632	57		14-021120-00	JAGUAR	310	6		14-021361-00	NEW HOLLAND	550	8	
14-020660-00	SSANGYONG	760	8		14-021120-00	LAND ROVER	347	11		14-021361-00	NEW HOLLAND	551	9	
14-020660-00	SSANGYONG	760	9		14-021120-00	PEUGEOT	628	45		14-021362-00	IVECO	284	28	
14-020660-00	TALBOT	773	7		14-021120-00	PEUGEOT	628	46		14-021362-00	IVECO	285	29	
14-020730-00	FORD	231	64		14-021130-00	AUSTIN MORRIS	63	9		14-021362-00	IVECO	288	30	
14-020730-00	FORD	232	65		14-021130-00	LEYLAND	359	1		14-021362-00	IVECO	289	31	
14-020740-00	FORD	233	68		14-021140-00	BEDFORD	68	10		14-021362-00	IVECO	290	32	
14-020740-00	FORD	233	69		14-021150-00	NISSAN	566	23		14-021362-00	IVECO	290	33	
14-020740-00	FORD	234	70		14-021160-00	NISSAN	563	15		14-021362-00	IVECO	291	34	
14-020740-00	FORD	234	71		14-021170-00	NISSAN	563	15		14-021362-00	IVECO	292	36	
14-020741-00	FORD	233	68		14-021180-00	BEDFORD	67	6		14-021362-00	NEW HOLLAND	549	7	
14-020741-00	FORD	233	69		14-021180-00	ISUZU	253	2		14-021362-00	NEW HOLLAND	550	8	
14-020741-00	FORD	234	70		14-021190-00	BEDFORD	67	8		14-021362-00	NEW HOLLAND	551	9	
14-020741-00	FORD	234	71		14-021190-00	ISUZU	253	3		14-021363-00	IVECO	284	28	
14-020742-00	FORD	233	68		14-021190-00	OPEL	591	52		14-021363-00	IVECO	285	29	
14-020742-00	FORD	233	69		14-021190-00	SSANGYONG	758	1		14-021363-00	IVECO	288	30	
14-020742-00	FORD	234	70		14-021190-00	VAUXHALL	802	52		14-021363-00	IVECO	289	31	
14-020742-00	FORD	234	71		14-021220-00	PERKINS	596	4		14-021363-00	IVECO	290	32	
14-020760-00	CITROËN	94	5		14-021220-00	PERKINS	597	5		14-021363-00	IVECO	290	33	

NUMERICAL PARTS LIST













Nummerische Teilenummernliste • Liste des références produits
Liste da referencias















				9					9					9
14-021363-00	IVECO	291	34		14-021493-00	IVECO	291	34		14-021571-00	SKODA	739	6	
14-021363-00	IVECO	292	36		14-021493-00	IVECO	292	36		14-021571-00	SKODA	740	7	
14-021363-00	NEW HOLLAND	549	7		14-021493-00	NEW HOLLAND	549	7		14-021571-00	VOLVO	814	5	
14-021363-00	NEW HOLLAND	550	8		14-021493-00	NEW HOLLAND	550	8		14-021571-00	VOLVO	814	6	
14-021363-00	NEW HOLLAND	551	9		14-021493-00	NEW HOLLAND	551	9		14-021571-00	VOLVO	814	7	
14-021371-00	ALFA ROMEO	31	31		14-021494-00	IVECO	284	28		14-021571-00	VW	854	7	
14-021371-00	ALFA ROMEO	32	32		14-021494-00	IVECO	285	29		14-021571-00	VW	855	8	
14-021371-00	FIAT	188	65		14-021494-00	IVECO	288	30		14-021571-00	VW	855	9	
14-021371-00	FIAT	189	66		14-021494-00	IVECO	289	31		14-021571-00	VW	859	15	
14-021371-00	FIAT	189	67		14-021494-00	IVECO	290	32		14-021571-00	VW	859	16	
14-021371-00	FIAT	189	68		14-021494-00	IVECO	290	33		14-021580-00	IVECO	299	50	
14-021371-00	IVECO	269	4		14-021494-00	IVECO	291	34		14-021590-00	IVECO	301	57	
14-021371-00	IVECO	270	5		14-021494-00	IVECO	292	36		14-021590-00	IVECO	302	58	
14-021371-00	IVECO	270	6		14-021494-00	NEW HOLLAND	549	7		14-021590-00	IVECO	303	59	
14-021371-00	IVECO	271	7		14-021494-00	NEW HOLLAND	550	8		14-021590-00	IVECO	304	60	
14-021371-00	LANCIA	342	32		14-021494-00	NEW HOLLAND	551	9		14-021590-00	IVECO	305	61	
14-021371-00	RENAULT	665	36		14-021520-00	CITROËN	115	51		14-021590-00	IVECO	305	62	
14-021371-00	RENAULT	666	37		14-021520-00	DAF	134	3		14-021610-00	FORD	233	68	
14-021371-00	RENAULT	666	38		14-021520-00	DAF	135	4		14-021610-00	FORD	233	69	
14-021371-00	RENAULT	666	39		14-021520-00	FORD	228	58		14-021610-00	FORD	234	70	
14-021372-00	ALFA ROMEO	31	31		14-021520-00	FORD	229	59		14-021610-00	FORD	234	71	
14-021372-00	ALFA ROMEO	32	32		14-021520-00	FORD	229	60		14-021611-00	FORD	233	68	
14-021372-00	FIAT	188	65		14-021520-00	LDV	356	5		14-021611-00	FORD	233	69	
14-021372-00	FIAT	189	66		14-021520-00	LDV	356	6		14-021611-00	FORD	234	70	
14-021372-00	FIAT	189	67		14-021520-00	LDV	356	7		14-021611-00	FORD	234	71	
14-021372-00	FIAT	189	68		14-021520-00	PEUGEOT	631	55		14-021850-00	MERCEDES-BENZ	473	44	
14-021372-00	IVECO	269	4		14-021520-00	PEUGEOT	632	56		14-021850-00	MERCEDES-BENZ	478	45	
14-021372-00	IVECO	270	5		14-021520-00	PEUGEOT	632	57		14-021850-00	MERCEDES-BENZ	479	46	
14-021372-00	IVECO	270	6		14-021520-00	SSANGYONG	760	8		14-021850-00	MERCEDES-BENZ	483	49	
14-021372-00	IVECO	271	7		14-021520-00	SSANGYONG	760	9		14-021930-00	ISUZU	255	8	
14-021372-00	LANCIA	342	32		14-021520-00	TALBOT	773	7		14-022060-00	ALFA ROMEO	21	1	
14-021372-00	RENAULT	665	36		14-021540-00	IVECO	277	17		14-022060-00	FIAT	166	7	
14-021372-00	RENAULT	666	37		14-021540-00	IVECO	279	19		14-022060-00	FIAT	167	8	
14-021372-00	RENAULT	666	38		14-021540-00	NEW HOLLAND	547	3		14-022060-00	LANCIA	332	4	
14-021372-00	RENAULT	666	39		14-021560-10	IVECO	301	57		14-022060-00	LANCIA	332	5	
14-021410-00	DAF	137	10		14-021560-10	IVECO	302	58		14-022110-00	FORD	219	35	
14-021410-00	DAF	138	11		14-021560-10	IVECO	303	59		14-022190-00	MERCEDES-BENZ	458	17	
14-021410-00	DAF	139	12		14-021560-10	IVECO	304	60		14-022190-00	SEAT	733	44	
14-021410-00	DAF	141	16		14-021560-10	IVECO	305	61		14-022560-00	ALFA ROMEO	32	33	
14-021410-00	DAF	141	17		14-021560-10	IVECO	305	62		14-022560-00	FIAT	190	69	
14-021410-00	DAF	141	18		14-021560-10	NEW HOLLAND	554	19		14-022560-00	IVECO	272	8	
14-021410-00	DAF	141	19		14-021560-10	NEW HOLLAND	555	20		14-022560-00	LANCIA	342	33	
14-021410-00	LEYLAND	361	7		14-021561-10	IVECO	301	57		14-022560-00	OPEL	593	57	
14-021410-00	LEYLAND	361	8		14-021561-10	IVECO	302	58		14-022560-00	RENAULT	667	40	
14-021491-00	IVECO	284	28		14-021561-10	IVECO	303	59		14-022560-00	SEAT	734	45	
14-021491-00	IVECO	285	29		14-021561-10	IVECO	304	60		14-022560-00	VAUXHALL	804	57	
14-021491-00	IVECO	288	30		14-021561-10	IVECO	305	61		14-022830-00	MAN	394	21	
14-021491-00	IVECO	289	31		14-021561-10	IVECO	305	62		14-023470-00	AUDI	40	8	
14-021491-00	IVECO	290	32		14-021561-10	NEW HOLLAND	554	19		14-023470-00	VW	858	14	
14-021491-00	IVECO	290	33		14-021561-10	NEW HOLLAND	555	20		14-023520-00	BEDFORD	67	5	
14-021491-00	IVECO	291	34		14-021562-10	IVECO	301	57		14-023520-00	OPEL	583	28	
14-021491-00	IVECO	292	36		14-021562-10	IVECO	302	58		14-023520-00	VAUXHALL	794	29	
14-021491-00	NEW HOLLAND	549	7		14-021562-10	IVECO	303	59		14-023551-00	IVECO	282	24	
14-021491-00	NEW HOLLAND	550	8		14-021562-10	IVECO	304	60		14-023551-00	IVECO	283	26	
14-021491-00	NEW HOLLAND	551	9		14-021562-10	IVECO	305	61		14-023551-00	IVECO	284	27	
14-021492-00	IVECO	284	28		14-021562-10	IVECO	305	62		14-023551-00	NEW HOLLAND	548	5	
14-021492-00	IVECO	285	29		14-021562-10	NEW HOLLAND	554	19		14-023551-00	NEW HOLLAND	549	6	
14-021492-00	IVECO	288	30		14-021562-10	NEW HOLLAND	555	20		14-023560-00	ALFA ROMEO	26	18	
14-021492-00	IVECO	289	31		14-021563-10	IVECO	301	57		14-023560-00	ALFA ROMEO	27	19	
14-021492-00	IVECO	290	32		14-021563-10	IVECO	302	58		14-023560-00	CITROËN	105	29	
14-021492-00	IVECO	290	33		14-021563-10	IVECO	303	59		14-023560-00	FIAT	180	42	
14-021492-00	IVECO	291	34		14-021563-10	IVECO	304	60		14-023560-00	FIAT	180	43	
14-021492-00	IVECO	292	36		14-021563-10	IVECO	305	61		14-023560-00	LANCIA	337	22	
14-021492-00	NEW HOLLAND	549	7		14-021563-10	IVECO	305	62		14-023560-00	LANCIA	338	23	
14-021492-00	NEW HOLLAND	550	8		14-021563-10	NEW HOLLAND	554	19		14-023730-00	RENAULT	654	18	
14-021492-00	NEW HOLLAND	551	9		14-021563-10	NEW HOLLAND	555	20		14-023730-00	VOLVO	815	8	
14-021493-00	IVECO	284	28		14-021571-00	AUDI	40	8		14-023751-00	ALFA ROMEO	26	18	
14-021493-00	IVECO	285	29		14-021571-00	AUDI	40	9		14-023751-00	ALFA ROMEO	27	19	
14-021493-00	IVECO	288	30		14-021571-00	AUDI	41	10		14-023751-00	CITROËN	105	29	
14-021493-00	IVECO	289	31		14-021571-00	SEAT	716	8		14-023751-00	FIAT	179	40	
14-021493-00	IVECO	290	32		14-021571-00	SEAT	716	9		14-023751-00	FIAT	180	42	
14-021493-00	IVECO	290	33		14-021571-00	SEAT	716	10		14-023751-00	FIAT	180	43	

	 	 9		 	 9		 	 9
14-023751-00	LANCIA	337 22	14-025802-00	MERCEDES-BENZ	473 44	14-027680-00	MAN	381 4
14-023751-00	LANCIA	338 23	14-025802-00	MERCEDES-BENZ	478 45	14-027680-00	MAN	382 5
14-024070-00	DAF	136 9	14-025802-00	MERCEDES-BENZ	479 46	14-027680-00	MAN	384 6
14-024100-00	BEDFORD	68 9	14-025802-00	MERCEDES-BENZ	480 47	14-027680-00	MAN	384 7
14-024100-00	OPEL	592 55	14-025802-00	MERCEDES-BENZ	482 48	14-027680-00	MAN	386 8
14-024100-00	VAUXHALL	803 55	14-025802-00	MERCEDES-BENZ	483 49	14-027680-00	MAN	387 9
14-024160-00	BEDFORD	67 7	14-025802-00	MERCEDES-BENZ	484 50	14-027680-00	MAN	388 10
14-024160-00	OPEL	591 51	14-025802-00	MERCEDES-BENZ	487 51	14-027680-00	MAN	388 12
14-024241-00	MERCEDES-BENZ	497 59	14-025802-00	MERCEDES-BENZ	487 52	14-027680-00	MAN	389 13
14-024670-00	AUDI	40 8	14-025804-00	MERCEDES-BENZ	473 44	14-027681-00	MAN	379 1
14-024670-00	VW	858 14	14-025804-00	MERCEDES-BENZ	478 45	14-027681-00	MAN	380 2
14-024680-00	PERKINS	596 4	14-025804-00	MERCEDES-BENZ	479 46	14-027681-00	MAN	380 3
14-024680-00	PERKINS	597 5	14-025804-00	MERCEDES-BENZ	480 47	14-027681-00	MAN	381 4
14-024680-00	PERKINS	598 6	14-025804-00	MERCEDES-BENZ	482 48	14-027681-00	MAN	382 5
14-024710-00	AUSTIN MORRIS	64 11	14-025804-00	MERCEDES-BENZ	483 49	14-027681-00	MAN	384 6
14-024710-00	LAND ROVER	349 16	14-025804-00	MERCEDES-BENZ	484 50	14-027681-00	MAN	384 7
14-024710-00	LAND ROVER	349 17	14-025804-00	MERCEDES-BENZ	487 51	14-027681-00	MAN	386 8
14-024710-00	LAND ROVER	350 18	14-025804-00	MERCEDES-BENZ	487 52	14-027681-00	MAN	387 9
14-024710-00	LAND ROVER	350 19	14-025833-00	PERKINS	596 4	14-027681-00	MAN	388 10
14-024710-00	LAND ROVER	351 20	14-025833-00	PERKINS	597 5	14-027681-00	MAN	388 12
14-024710-00	LAND ROVER	351 21	14-025833-00	PERKINS	598 6	14-027681-00	MAN	389 13
14-024710-00	LDV	355 3	14-025871-00	PERKINS	596 4	14-027790-00	STEYR	763 2
14-024710-00	ROVER	689 16	14-025871-00	PERKINS	597 5	14-027950-00	AUDI	41 11
14-024710-00	ROVER	690 17	14-025871-00	PERKINS	598 6	14-027950-00	AUDI	42 12
14-024740-00	CITROËN	103 25	14-025873-00	PERKINS	596 4	14-027950-00	AUDI	42 13
14-024740-00	CITROËN	104 26	14-025873-00	PERKINS	597 5	14-027950-00	AUDI	42 14
14-024740-00	HONDA	240 3	14-025873-00	PERKINS	598 6	14-027950-00	AUDI	43 15
14-024740-00	PEUGEOT	619 27	14-025881-00	MERCEDES-BENZ	473 44	14-027950-00	AUDI	44 16
14-024740-00	PEUGEOT	620 28	14-025881-00	MERCEDES-BENZ	478 45	14-027950-00	AUDI	45 17
14-024781-00	IVECO	284 28	14-025881-00	MERCEDES-BENZ	479 46	14-027950-00	AUDI	46 18
14-024781-00	IVECO	285 29	14-025881-00	MERCEDES-BENZ	480 47	14-027950-00	AUDI	47 19
14-024781-00	IVECO	288 30	14-025881-00	MERCEDES-BENZ	482 48	14-027950-00	FORD	209 18
14-024781-00	IVECO	289 31	14-025881-00	MERCEDES-BENZ	483 49	14-027950-00	FORD	210 19
14-024781-00	IVECO	290 32	14-025881-00	MERCEDES-BENZ	484 50	14-027950-00	FORD	211 20
14-024781-00	IVECO	290 33	14-025881-00	MERCEDES-BENZ	487 51	14-027950-00	FORD	212 21
14-024781-00	IVECO	291 34	14-025881-00	MERCEDES-BENZ	487 52	14-027950-00	SEAT	719 15
14-024781-00	IVECO	292 36	14-025883-00	MERCEDES-BENZ	473 44	14-027950-00	SEAT	720 17
14-024830-00	CITROËN	103 25	14-025883-00	MERCEDES-BENZ	478 45	14-027950-00	SEAT	720 18
14-024830-00	CITROËN	104 26	14-025883-00	MERCEDES-BENZ	479 46	14-027950-00	SEAT	721 19
14-024830-00	HONDA	240 3	14-025883-00	MERCEDES-BENZ	480 47	14-027950-00	SEAT	722 20
14-024830-00	PEUGEOT	619 27	14-025883-00	MERCEDES-BENZ	482 48	14-027950-00	SEAT	722 21
14-024830-00	PEUGEOT	620 28	14-025883-00	MERCEDES-BENZ	483 49	14-027950-00	SEAT	722 22
14-025070-00	SEAT	716 7	14-025883-00	MERCEDES-BENZ	484 50	14-027950-00	SEAT	723 23
14-025070-00	VW	854 6	14-025883-00	MERCEDES-BENZ	487 51	14-027950-00	SEAT	725 24
14-025380-10	NISSAN	569 27	14-025883-00	MERCEDES-BENZ	487 52	14-027950-00	SKODA	742 12
14-025380-10	PERKINS	600 13	14-025890-00	MERCEDES-BENZ	504 66	14-027950-00	SKODA	743 14
14-025380-10	PERKINS	601 14	14-025890-00	MERCEDES-BENZ	505 67	14-027950-00	SKODA	743 15
14-025380-10	PERKINS	601 15	14-025891-00	MERCEDES-BENZ	504 66	14-027950-00	SKODA	744 16
14-025380-10	PERKINS	602 16	14-025891-00	MERCEDES-BENZ	505 67	14-027950-00	SKODA	745 17
14-025480-00	MERCEDES-BENZ	466 30	14-025892-00	MERCEDES-BENZ	504 66	14-027950-00	SKODA	746 18
14-025480-00	MERCEDES-BENZ	466 31	14-025892-00	MERCEDES-BENZ	505 67	14-027950-00	VW	860 17
14-025530-00	DAF	135 5	14-026240-00	MERCEDES-BENZ	457 15	14-027950-00	VW	861 19
14-025530-00	DAF	135 6	14-026240-00	MERCEDES-BENZ	457 16	14-027950-00	VW	862 20
14-025530-00	DAF	136 7	14-026240-00	MERCEDES-BENZ	459 18	14-027950-00	VW	862 21
14-025800-00	MERCEDES-BENZ	473 44	14-026240-00	MERCEDES-BENZ	459 19	14-027950-00	VW	864 22
14-025800-00	MERCEDES-BENZ	478 45	14-026380-00	MERCEDES-BENZ	466 32	14-027950-00	VW	864 23
14-025800-00	MERCEDES-BENZ	479 46	14-026380-00	MERCEDES-BENZ	467 33	14-027950-00	VW	865 24
14-025800-00	MERCEDES-BENZ	480 47	14-026380-00	MERCEDES-BENZ	468 35	14-027950-00	VW	866 25
14-025800-00	MERCEDES-BENZ	482 48	14-026380-00	SSANGYONG	758 2	14-027950-00	VW	867 26
14-025800-00	MERCEDES-BENZ	483 49	14-026380-00	SSANGYONG	758 3	14-027950-00	VW	869 27
14-025800-00	MERCEDES-BENZ	484 50	14-026380-00	SSANGYONG	758 4	14-027950-00	VW	869 28
14-025800-00	MERCEDES-BENZ	487 51	14-027200-00	RENAULT	680 70	14-028240-00	STEYR	764 4
14-025800-00	MERCEDES-BENZ	487 52	14-027200-00	RENAULT	682 75	14-028360-00	AUDI	40 8
14-025801-00	MERCEDES-BENZ	473 44	14-027210-00	MERCEDES-BENZ	466 32	14-028360-00	AUDI	40 9
14-025801-00	MERCEDES-BENZ	478 45	14-027210-00	MERCEDES-BENZ	467 33	14-028360-00	AUDI	41 10
14-025801-00	MERCEDES-BENZ	479 46	14-027210-00	MERCEDES-BENZ	468 34	14-028360-00	SEAT	716 8
14-025801-00	MERCEDES-BENZ	480 47	14-027210-00	MERCEDES-BENZ	468 35	14-028360-00	SEAT	716 9
14-025801-00	MERCEDES-BENZ	482 48	14-027210-00	SSANGYONG	758 2	14-028360-00	SEAT	716 10
14-025801-00	MERCEDES-BENZ	483 49	14-027210-00	SSANGYONG	758 4	14-028360-00	SKODA	739 6
14-025801-00	MERCEDES-BENZ	484 50	14-027680-00	MAN	379 1	14-028360-00	SKODA	740 7
14-025801-00	MERCEDES-BENZ	487 51	14-027680-00	MAN	380 2	14-028360-00	VOLVO	814 5
14-025801-00	MERCEDES-BENZ	487 52	14-027680-00	MAN	380 3	14-028360-00	VOLVO	814 6

NUMERICAL PARTS LIST













Numerische Teilenummernliste • Liste des références produits
Liste da referencias











											
14-028360-00	VOLVO	814	7	14-028932-00	IVECO	274	12	14-049310-00	PERKINS	600	12
14-028360-00	VW	854	7	14-028932-00	IVECO	275	13	14-102800-00	OPEL	588	42
14-028360-00	VW	855	8	14-028932-00	LANCIA	342	33	14-102800-00	VAUXHALL	799	43
14-028360-00	VW	855	9	14-028932-00	OPEL	593	57	14-112800-00	SCANIA	701	6
14-028360-00	VW	858	14	14-028932-00	OPEL	593	58	14-112800-00	SCANIA	702	9
14-028360-00	VW	859	15	14-028932-00	PEUGEOT	632	58	14-112800-00	SCANIA	703	10
14-028360-00	VW	859	16	14-028932-00	PEUGEOT	633	59	14-112800-00	SCANIA	703	11
14-028610-00	MERCEDES-BENZ	488	53	14-028932-00	RENAULT	667	40	14-112800-00	SCANIA	706	17
14-028610-00	MERCEDES-BENZ	490	54	14-028932-00	RENAULT	668	41	14-260070-00	IVECO	296	44
14-028610-00	MERCEDES-BENZ	493	55	14-028932-00	RENAULT	668	42	14-260070-00	IVECO	296	45
14-028710-00	FIAT	175	31	14-028932-00	RENAULT	668	43	14-260080-00	IVECO	306	63
14-028930-00	ALFA ROMEO	32	33	14-028932-00	RENAULT	669	44	14-260080-00	IVECO	307	64
14-028930-00	CITROËN	115	52	14-028932-00	VAUXHALL	804	57	14-260500-00	UTB	781	1
14-028930-00	CITROËN	115	53	14-028932-00	VAUXHALL	804	58	14-261790-00	RENAULT	669	45
14-028930-00	FIAT	190	69	14-028960-00	ALFA ROMEO	25	14	14-265940-00	RENAULT	669	46
14-028930-00	FIAT	191	71	14-028960-00	ALFA ROMEO	25	15	14-265950-00	RENAULT	670	49
14-028930-00	FIAT	191	72	14-028960-00	ALFA ROMEO	26	17	14-265950-00	RENAULT	671	50
14-028930-00	FIAT	192	73	14-028960-00	FIAT	177	35	14-265960-00	RENAULT	670	48
14-028930-00	IVECO	272	8	14-028960-00	FIAT	177	36	14-265960-00	RENAULT	670	49
14-028930-00	IVECO	272	9	14-028960-00	FIAT	178	37	14-265960-00	RENAULT	671	50
14-028930-00	IVECO	274	10	14-028960-00	FIAT	178	38	14-265960-00	RENAULT	671	51
14-028930-00	IVECO	274	11	14-028960-00	LANCIA	336	19	14-265960-00	RENAULT	672	52
14-028930-00	IVECO	274	12	14-028960-00	LANCIA	337	20	14-265960-00	RENAULT	672	53
14-028930-00	IVECO	275	13	14-028960-00	LANCIA	337	21	14-370870-00	FORD	230	62
14-028930-00	LANCIA	342	33	14-028960-00	SUZUKI	768	6	14-374990-00	SCANIA	699	2
14-028930-00	OPEL	593	57	14-029750-00	DEUTZ/KHD	146	1	14-374990-00	SCANIA	699	3
14-028930-00	OPEL	593	58	14-029750-00	DEUTZ/KHD	146	2	14-400510-00	VOLVO	816	13
14-028930-00	PEUGEOT	632	58	14-029750-00	DEUTZ/KHD	146	3	14-400510-00	VOLVO	817	15
14-028930-00	PEUGEOT	633	59	14-030350-00	MAN	388	11	14-450030-00	MAN	400	31
14-028930-00	RENAULT	667	40	14-040040-00	RENAULT	681	71	14-450030-00	MAN	401	32
14-028930-00	RENAULT	668	41	14-040040-00	RENAULT	681	72	14-450030-00	MAN	402	33
14-028930-00	RENAULT	668	42	14-040040-00	RENAULT	682	73	14-450030-00	MAN	403	34
14-028930-00	RENAULT	668	43	14-040120-00	PERKINS	602	17	14-450030-00	MAN	404	35
14-028930-00	RENAULT	669	44	14-040120-00	PERKINS	602	18	14-450030-00	MAN	405	36
14-028930-00	VAUXHALL	804	57	14-040130-00	TOYOTA	776	6	14-450030-00	MAN	406	37
14-028930-00	VAUXHALL	804	58	14-040130-00	TOYOTA	777	7	14-450030-00	MAN	407	38
14-028931-00	ALFA ROMEO	32	33	14-040130-00	VW	886	57	14-450030-00	MAN	407	39
14-028931-00	CITROËN	115	52	14-040150-00	HINO	238	1	14-450040-00	SCANIA	705	15
14-028931-00	CITROËN	115	53	14-040150-00	TOYOTA	778	8	14-450110-00	SCANIA	705	15
14-028931-00	FIAT	190	69	14-040150-00	TOYOTA	778	9	14-450160-00	VOLVO	835	44
14-028931-00	FIAT	191	71	14-040160-00	TOYOTA	776	5	14-450160-00	VOLVO	835	45
14-028931-00	FIAT	191	72	14-040190-00	PERKINS	602	17	14-450160-00	VOLVO	836	46
14-028931-00	FIAT	192	73	14-040190-00	PERKINS	602	18	14-450160-00	VOLVO	836	47
14-028931-00	IVECO	272	8	14-040200-00	LEYLAND	359	4	14-450250-00	MERCEDES-BENZ	521	87
14-028931-00	IVECO	272	9	14-040200-00	LEYLAND	360	5	14-450250-00	MERCEDES-BENZ	523	88
14-028931-00	IVECO	274	10	14-040200-00	PERKINS	598	8	14-450250-00	MERCEDES-BENZ	526	91
14-028931-00	IVECO	274	11	14-040200-00	PERKINS	599	9	14-450370-00	MAN	394	22
14-028931-00	IVECO	274	12	14-040200-00	PERKINS	599	10	14-450370-00	MAN	395	23
14-028931-00	IVECO	275	13	14-040200-00	PERKINS	600	11	14-450370-00	MAN	395	24
14-028931-00	LANCIA	342	33	14-040200-00	VOLVO	818	17	14-450380-00	MERCEDES-BENZ	514	77
14-028931-00	OPEL	593	57	14-041140-00	PERKINS	602	17	14-450380-00	MERCEDES-BENZ	515	78
14-028931-00	OPEL	593	58	14-041140-00	PERKINS	602	18	14-450380-00	MERCEDES-BENZ	516	79
14-028931-00	PEUGEOT	632	58	14-041610-00	PERKINS	602	17	14-450480-00	MERCEDES-BENZ	514	77
14-028931-00	PEUGEOT	633	59	14-041610-00	PERKINS	602	18	14-450480-00	MERCEDES-BENZ	515	78
14-028931-00	RENAULT	667	40	14-043450-00	PERKINS	598	7	14-450480-00	MERCEDES-BENZ	516	79
14-028931-00	RENAULT	668	41	14-043450-00	VW	886	58	14-450520-00	VOLVO	823	27
14-028931-00	RENAULT	668	42	14-045570-00	FORD	231	63	14-450520-00	VOLVO	824	29
14-028931-00	RENAULT	668	43	14-045820-00	LEYLAND	359	4	14-450530-00	VOLVO	832	40
14-028931-00	RENAULT	669	44	14-045820-00	LEYLAND	360	5	14-450530-00	VOLVO	833	42
14-028931-00	VAUXHALL	804	57	14-045820-00	PERKINS	598	8	14-450590-00	RENAULT	679	68
14-028931-00	VAUXHALL	804	58	14-045820-00	PERKINS	599	9	14-450590-00	VOLVO	836	48
14-028932-00	ALFA ROMEO	32	33	14-045820-00	PERKINS	599	10	14-450590-00	VOLVO	837	49
14-028932-00	CITROËN	115	52	14-045820-00	PERKINS	600	11	14-450590-00	VOLVO	838	50
14-028932-00	CITROËN	115	53	14-045820-00	VOLVO	818	17	14-450590-00	VOLVO	840	54
14-028932-00	FIAT	190	69	14-045821-00	LEYLAND	359	4	14-450590-00	VOLVO	841	56
14-028932-00	FIAT	191	71	14-045821-00	LEYLAND	360	5	14-450630-00	MAN	389	14
14-028932-00	FIAT	191	72	14-045821-00	PERKINS	598	8	14-450630-00	MAN	390	15
14-028932-00	FIAT	192	73	14-045821-00	PERKINS	599	9	14-450630-00	MAN	391	16
14-028932-00	IVECO	272	8	14-045821-00	PERKINS	599	10	14-450630-00	MAN	392	17
14-028932-00	IVECO	272	9	14-045821-00	PERKINS	600	11	14-450630-00	MAN	393	18
14-028932-00	IVECO	274	10	14-045821-00	VOLVO	818	17	14-450630-00	MAN	393	20
14-028932-00	IVECO	274	11	14-049300-00	PERKINS	600	12	14-450710-00	JOHN DEERE	317	2

	  	 9		  	 9		  	 9
14-450710-00	JOHN DEERE	317 3	14-452930-00	MAN	404 35	14-615230-00	IVECO	293 37
14-450710-00	JOHN DEERE	318 4	14-452930-00	MAN	405 36	14-615230-00	IVECO	293 38
14-450790-00	MERCEDES-BENZ	524 89	14-452930-00	MAN	406 37	14-630120-00	RENAULT	648 7
14-450790-00	MERCEDES-BENZ	525 90	14-452930-00	MAN	407 38	14-633860-00	DEUTZ/KHD	156 26
14-450810-00	VOLVO	821 22	14-452930-00	MAN	407 39	14-633860-00	IVECO	294 41
14-450850-00	SCANIA	701 8	14-455210-00	FORD	230 62	14-633860-00	IVECO	295 42
14-450850-00	SCANIA	705 15	14-456000-00	VOLVO	832 40	14-633860-00	IVECO	295 43
14-450880-00	IVECO	297 47	14-456000-00	VOLVO	833 41	14-633860-00	NEW HOLLAND	553 15
14-450880-00	IVECO	298 48	14-456000-00	VOLVO	833 42	14-634910-00	CITROËN	105 30
14-450880-00	NEW HOLLAND	554 18	14-456000-00	VOLVO	834 43	14-634910-00	CITROËN	106 31
14-450920-00	RENAULT	677 62	14-456330-00	MERCEDES-BENZ	519 85	14-634910-00	FIAT	181 44
14-450920-00	RENAULT	677 63	14-456330-00	MERCEDES-BENZ	520 86	14-634910-00	PEUGEOT	621 31
14-450920-00	RENAULT	678 65	14-456980-00	MERCEDES-BENZ	502 65	14-634910-00	PEUGEOT	621 32
14-450960-00	DEUTZ/KHD	158 31	14-456980-00	MERCEDES-BENZ	512 74	14-636470-00	CITROËN	93 2
14-450960-00	DEUTZ/KHD	158 32	14-456980-00	MERCEDES-BENZ	513 75	14-636470-00	CITROËN	93 3
14-451030-00	VOLVO	842 57	14-458110-00	MERCEDES-BENZ	498 60	14-636470-00	PEUGEOT	609 3
14-451030-00	VOLVO	842 58	14-458110-00	MERCEDES-BENZ	499 61	14-636470-00	PEUGEOT	610 5
14-451030-00	VOLVO	842 59	14-458110-00	MERCEDES-BENZ	500 62	14-636470-00	TALBOT	772 1
14-451040-00	MAN	397 26	14-458110-00	MERCEDES-BENZ	501 63	14-636500-00	CITROËN	113 46
14-451040-00	MAN	398 27	14-458170-00	VOLVO	825 30	14-636500-00	FIAT	187 59
14-451040-00	MAN	399 29	14-458170-00	VOLVO	826 31	14-636500-00	FIAT	187 60
14-451040-00	MAN	399 30	14-458170-00	VOLVO	827 32	14-636500-00	PEUGEOT	628 47
14-451080-00	STEYR	763 1	14-458170-00	VOLVO	830 37	14-636500-00	PEUGEOT	629 48
14-451090-00	MAN	396 25	14-458170-00	VOLVO	831 38	14-636500-00	TALBOT	772 4
14-451160-00	MERCEDES-BENZ	505 68	14-458180-00	VOLVO	832 40	14-636600-00	CITROËN	96 10
14-451160-00	MERCEDES-BENZ	506 69	14-458180-00	VOLVO	833 41	14-636600-00	CITROËN	97 11
14-451160-00	MERCEDES-BENZ	507 70	14-458180-00	VOLVO	833 42	14-636600-00	CITROËN	97 12
14-451160-00	MERCEDES-BENZ	509 71	14-458190-00	SCANIA	701 8	14-636600-00	PEUGEOT	611 10
14-451160-00	MERCEDES-BENZ	510 72	14-458190-00	SCANIA	705 14	14-636600-00	PEUGEOT	612 11
14-451160-00	MERCEDES-BENZ	511 73	14-458190-00	SCANIA	706 16	14-636600-00	PEUGEOT	613 12
14-451160-00	MERCEDES-BENZ	518 82	14-458580-00	MERCEDES-BENZ	521 87	14-636600-00	PEUGEOT	613 13
14-451160-00	MERCEDES-BENZ	518 83	14-458580-00	MERCEDES-BENZ	523 88	14-636600-00	TALBOT	772 2
14-451160-00	MERCEDES-BENZ	519 84	14-458580-00	MERCEDES-BENZ	526 91	14-670020-00	SCANIA	707 18
14-451170-00	IHC	251 1	14-459040-00	VOLVO	824 28	14-670050-00	MAN	408 40
14-451190-00	RENAULT	680 69	14-459040-00	VOLVO	828 33	14-671680-00	SCANIA	707 18
14-451190-00	VOLVO	839 51	14-459040-00	VOLVO	829 34	14-671680-00	SCANIA	708 19
14-451190-00	VOLVO	839 52	14-459040-00	VOLVO	829 35	14-673080-00	SCANIA	707 18
14-451220-00	MERCEDES-BENZ	524 89	14-459040-00	VOLVO	829 36	14-673200-00	VOLVO	824 29
14-451220-00	MERCEDES-BENZ	525 90	14-459050-00	VOLVO	819 19	14-673200-00	VOLVO	825 30
14-451660-00	MERCEDES-BENZ	498 60	14-459050-00	VOLVO	820 20	14-673200-00	VOLVO	826 31
14-451660-00	MERCEDES-BENZ	499 61	14-459050-00	VOLVO	820 21	14-673200-00	VOLVO	827 32
14-451660-00	MERCEDES-BENZ	500 62	14-480040-00	DEUTZ/KHD	153 19	14-673200-00	VOLVO	830 37
14-451660-00	MERCEDES-BENZ	501 63	14-480040-00	DEUTZ/KHD	153 20	14-676420-00	ALFA ROMEO	31 30
14-452030-00	MERCEDES-BENZ	505 68	14-480040-00	DEUTZ/KHD	153 21	14-676420-00	CHRYSLER	88 5
14-452030-00	MERCEDES-BENZ	506 69	14-480040-00	DEUTZ/KHD	154 23	14-676420-00	FORD	226 53
14-452030-00	MERCEDES-BENZ	507 70	14-480040-00	DEUTZ/KHD	155 24	14-676420-00	JEEP	315 5
14-452030-00	MERCEDES-BENZ	509 71	14-480040-00	DEUTZ/KHD	155 25	14-676420-00	LAND ROVER	352 22
14-452030-00	MERCEDES-BENZ	510 72	14-480040-00	VOLVO	821 23	14-676420-00	OPEL	593 56
14-452030-00	MERCEDES-BENZ	511 73	14-480070-00	RENAULT	673 55	14-676420-00	ROVER	690 18
14-452030-00	MERCEDES-BENZ	518 82	14-480070-00	RENAULT	673 56	14-676420-00	VAUXHALL	804 56
14-452030-00	MERCEDES-BENZ	518 83	14-480070-00	RENAULT	674 57	14-676420-00	VM	807 2
14-452030-00	MERCEDES-BENZ	519 84	14-480070-00	RENAULT	674 58	14-684840-00	DEUTZ/KHD	156 26
14-452310-00	MERCEDES-BENZ	498 60	14-480070-00	RENAULT	676 61	14-684840-00	IVECO	294 41
14-452310-00	MERCEDES-BENZ	499 61	14-480080-00	RENAULT	674 57	14-684840-00	IVECO	295 42
14-452310-00	MERCEDES-BENZ	500 62	14-480080-00	RENAULT	674 58	14-684840-00	IVECO	295 43
14-452310-00	MERCEDES-BENZ	501 63	14-480080-00	RENAULT	675 59	14-684840-00	NEW HOLLAND	553 15
14-452740-00	JOHN DEERE	317 1	14-480320-00	PERKINS	596 4	14-684840-00	NEW HOLLAND	553 16
14-452910-00	MAN	409 41	14-480320-00	PERKINS	597 5	14-684840-00	NEW HOLLAND	554 17
14-452910-00	MAN	410 42	14-480320-00	PERKINS	598 6	14-710010-00	JAGUAR	311 10
14-452920-00	MAN	400 31	14-480440-00	RENAULT	677 64	14-710010-00	JAGUAR	312 11
14-452920-00	MAN	401 32	14-480440-00	VOLVO	831 39	14-710020-00	LAND ROVER	344 1
14-452920-00	MAN	402 33	14-480460-00	VOLVO	823 26	14-710020-00	LAND ROVER	344 2
14-452920-00	MAN	403 34	14-573140-00	VOLVO	819 18	14-710020-00	LOTUS	364 1
14-452920-00	MAN	404 35	14-600420-00	FORD	221 41	14-710020-00	LOTUS	364 2
14-452920-00	MAN	405 36	14-600420-00	PEUGEOT	629 49	14-710020-00	MG	530 5
14-452920-00	MAN	406 37	14-604060-00	FORD	225 50	14-710020-00	MG	530 6
14-452920-00	MAN	407 38	14-604060-00	PEUGEOT	629 50	14-710020-00	MG	531 7
14-452920-00	MAN	407 39	14-610020-00	IVECO	294 40	14-710020-00	ROVER	686 7
14-452930-00	MAN	400 31	14-611250-00	IVECO	293 37	14-710020-00	ROVER	686 8
14-452930-00	MAN	401 32	14-611250-00	IVECO	293 38	14-710020-00	ROVER	687 9
14-452930-00	MAN	402 33	14-611250-00	NEW HOLLAND	551 10	14-710030-00	FSO	236 2
14-452930-00	MAN	403 34	14-611250-00	NEW HOLLAND	552 11	14-710030-00	MG	530 4

NUMERICAL PARTS LIST













Numerische Teilenummernliste • Liste des références produits
Liste da referencias

											
14-710030-00	ROVER	685	4	15-450380-00	MERCEDES-BENZ	515	78	15-452920-00	MAN	406	37
14-710030-00	ROVER	685	5	15-450380-00	MERCEDES-BENZ	516	79	15-452920-00	MAN	407	38
14-740060-00	IVECO	294	39	15-450590-00	RENAULT	679	68	15-452920-00	MAN	407	39
14-740130-00	RENAULT	678	66	15-450590-00	VOLVO	836	48	15-452930-00	MAN	400	31
14-740130-00	RENAULT	679	67	15-450590-00	VOLVO	837	49	15-452930-00	MAN	401	32
14-900030-00	DEUTZ/KHD	157	29	15-450590-00	VOLVO	838	50	15-452930-00	MAN	402	33
14-900030-00	DEUTZ/KHD	157	30	15-450590-00	VOLVO	840	54	15-452930-00	MAN	403	34
14-900030-00	IVECO	300	53	15-450590-00	VOLVO	841	56	15-452930-00	MAN	404	35
14-900050-00	DEUTZ/KHD	157	29	15-450630-00	MAN	389	14	15-452930-00	MAN	405	36
14-900050-00	DEUTZ/KHD	157	30	15-450630-00	MAN	390	15	15-452930-00	MAN	406	37
14-900050-00	IVECO	300	53	15-450630-00	MAN	391	16	15-452930-00	MAN	407	38
14-900060-00	DEUTZ/KHD	150	13	15-450630-00	MAN	392	17	15-452930-00	MAN	407	39
14-900060-00	DEUTZ/KHD	151	15	15-450630-00	MAN	393	18	15-456330-00	MERCEDES-BENZ	519	85
14-900060-00	DEUTZ/KHD	151	16	15-450630-00	MAN	393	20	15-456330-00	MERCEDES-BENZ	520	86
14-900060-00	DEUTZ/KHD	152	17	15-450790-00	MERCEDES-BENZ	524	89	15-456980-00	MERCEDES-BENZ	502	65
14-900060-00	IVECO	280	20	15-450790-00	MERCEDES-BENZ	525	90	15-456980-00	MERCEDES-BENZ	512	74
14-900060-00	IVECO	281	23	15-450810-00	VOLVO	821	22	15-456980-00	MERCEDES-BENZ	513	75
14-900070-00	DEUTZ/KHD	156	27	15-450850-00	SCANIA	701	8	15-457590-00	VOLVO	819	18
14-900070-00	DEUTZ/KHD	156	28	15-450850-00	SCANIA	705	15	15-457960-00	VOLVO	832	40
14-900080-00	DEUTZ/KHD	148	9	15-450870-00	LEYLAND	359	2	15-457960-00	VOLVO	833	41
14-900080-00	DEUTZ/KHD	148	10	15-450870-00	LEYLAND	359	3	15-457960-00	VOLVO	833	42
14-900100-00	DEUTZ/KHD	150	13	15-450870-00	LEYLAND	360	6	15-457960-00	VOLVO	834	43
14-900100-00	DEUTZ/KHD	151	14	15-451030-00	VOLVO	842	57	15-458110-00	MERCEDES-BENZ	498	60
14-900100-00	DEUTZ/KHD	151	15	15-451030-00	VOLVO	842	58	15-458110-00	MERCEDES-BENZ	499	61
14-900100-00	DEUTZ/KHD	151	16	15-451030-00	VOLVO	842	59	15-458110-00	MERCEDES-BENZ	500	62
14-900100-00	IVECO	280	20	15-451040-00	MAN	397	26	15-458110-00	MERCEDES-BENZ	501	63
14-900100-00	IVECO	281	23	15-451040-00	MAN	398	27	15-458180-00	VOLVO	832	40
14-900110-00	DEUTZ/KHD	151	15	15-451040-00	MAN	399	29	15-458180-00	VOLVO	833	41
14-900110-00	DEUTZ/KHD	151	16	15-451040-00	MAN	399	30	15-458180-00	VOLVO	833	42
14-900110-00	IVECO	281	23	15-451070-10	MERCEDES-BENZ	514	76	15-458190-00	SCANIA	701	8
14-900110-00	IVECO	281	23	15-451070-10	MERCEDES-BENZ	517	80	15-458190-00	SCANIA	705	14
15-112800-00	SCANIA	701	6	15-451070-10	MERCEDES-BENZ	517	81	15-458190-00	SCANIA	706	16
15-112800-00	SCANIA	702	9	15-451070-10	DAF	140	14	15-458580-00	MERCEDES-BENZ	521	87
15-112800-00	SCANIA	703	10	15-451160-00	MERCEDES-BENZ	505	68	15-458580-00	MERCEDES-BENZ	523	88
15-112800-00	SCANIA	703	11	15-451160-00	MERCEDES-BENZ	506	69	15-458580-00	MERCEDES-BENZ	526	91
15-112800-00	SCANIA	706	17	15-451160-00	MERCEDES-BENZ	507	70	15-458840-00	VOLVO	832	40
15-260040-00	IVECO	299	51	15-451160-00	MERCEDES-BENZ	509	71	15-458840-00	VOLVO	833	41
15-260040-00	IVECO	299	52	15-451160-00	MERCEDES-BENZ	510	72	15-458840-00	VOLVO	833	42
15-260050-10	IVECO	300	55	15-451160-00	MERCEDES-BENZ	511	73	15-458840-00	VOLVO	834	43
15-260050-10	IVECO	301	56	15-451160-00	MERCEDES-BENZ	518	82	15-458900-00	VOLVO	816	13
15-260070-00	IVECO	296	44	15-451160-00	MERCEDES-BENZ	518	83	15-458900-00	VOLVO	817	15
15-260070-00	IVECO	296	45	15-451160-00	MERCEDES-BENZ	519	84	15-458910-00	VOLVO	819	19
15-260080-00	IVECO	306	63	15-451190-00	RENAULT	680	69	15-458910-00	VOLVO	820	20
15-260080-00	IVECO	307	64	15-451190-00	VOLVO	839	51	15-458910-00	VOLVO	820	21
15-265960-00	RENAULT	670	48	15-451190-00	VOLVO	839	52	15-459030-00	VOLVO	832	40
15-265960-00	RENAULT	670	49	15-451220-00	MERCEDES-BENZ	524	89	15-459030-00	VOLVO	833	42
15-265960-00	RENAULT	671	50	15-451220-00	MERCEDES-BENZ	525	90	15-459040-00	VOLVO	824	28
15-265960-00	RENAULT	671	51	15-451230-00	DAF	139	13	15-459040-00	VOLVO	828	33
15-265960-00	RENAULT	672	52	15-451230-00	DAF	140	14	15-459040-00	VOLVO	829	34
15-265960-00	RENAULT	672	53	15-451230-00	DAF	140	15	15-459040-00	VOLVO	829	35
15-370040-00	PERKINS	596	1	15-451270-00	RENAULT	679	68	15-459040-00	VOLVO	829	36
15-450030-00	MAN	400	31	15-451270-00	VOLVO	836	48	15-459230-00	VOLVO	824	28
15-450030-00	MAN	401	32	15-451270-00	VOLVO	837	49	15-459230-00	VOLVO	828	33
15-450030-00	MAN	402	33	15-451270-00	VOLVO	838	50	15-459230-00	VOLVO	829	34
15-450030-00	MAN	403	34	15-451270-00	VOLVO	840	54	15-459230-00	VOLVO	829	35
15-450030-00	MAN	404	35	15-451270-00	VOLVO	841	55	15-459230-00	VOLVO	829	36
15-450030-00	MAN	405	36	15-451270-00	VOLVO	841	56	15-459340-00	VOLVO	818	16
15-450030-00	MAN	406	37	15-452030-00	MERCEDES-BENZ	505	68	15-459350-00	VOLVO	826	31
15-450030-00	MAN	407	38	15-452030-00	MERCEDES-BENZ	506	69	15-459350-00	VOLVO	827	32
15-450030-00	MAN	407	39	15-452030-00	MERCEDES-BENZ	507	70	15-459350-00	VOLVO	830	37
15-450110-00	SCANIA	705	15	15-452030-00	MERCEDES-BENZ	509	71	15-480040-00	DEUTZ/KHD	153	19
15-450130-00	VOLVO	817	14	15-452030-00	MERCEDES-BENZ	510	72	15-480040-00	DEUTZ/KHD	153	20
15-450160-00	VOLVO	835	44	15-452030-00	MERCEDES-BENZ	511	73	15-480040-00	DEUTZ/KHD	153	21
15-450160-00	VOLVO	835	45	15-452030-00	MERCEDES-BENZ	518	82	15-480040-00	DEUTZ/KHD	154	23
15-450160-00	VOLVO	836	46	15-452030-00	MERCEDES-BENZ	518	83	15-480040-00	DEUTZ/KHD	155	24
15-450160-00	VOLVO	836	47	15-452030-00	MERCEDES-BENZ	519	84	15-480040-00	DEUTZ/KHD	155	25
15-450190-00	RENAULT	674	57	15-452920-00	MAN	400	31	15-480040-00	VOLVO	821	23
15-450190-00	RENAULT	674	58	15-452920-00	MAN	401	32	15-480050-00	RENAULT	673	55
15-450220-00	RENAULT	677	62	15-452920-00	MAN	402	33	15-480050-00	RENAULT	673	56
15-450220-00	RENAULT	677	63	15-452920-00	MAN	403	34	15-480070-00	RENAULT	673	55
15-450220-00	RENAULT	678	65	15-452920-00	MAN	404	35	15-480070-00	RENAULT	673	56
15-450380-00	MERCEDES-BENZ	514	77	15-452920-00	MAN	405	36	15-480070-00	RENAULT	674	57

	 				 		
15-480070-00	RENAULT	674	58	15-677620-00	VOLVO	824	29
15-480070-00	RENAULT	676	61	15-677620-00	VOLVO	825	30
15-480080-00	RENAULT	674	57	15-677620-00	VOLVO	826	31
15-480080-00	RENAULT	674	58	15-677620-00	VOLVO	827	32
15-480080-00	RENAULT	675	59	15-677620-00	VOLVO	830	37
15-480090-00	RENAULT	670	47	15-679320-00	SCANIA	708	20
15-480090-00	RENAULT	670	48	15-679320-00	SCANIA	708	21
15-480090-00	RENAULT	671	51				
15-480090-00	RENAULT	672	52				
15-480090-00	RENAULT	672	53				
15-480230-00	VOLVO	822	25				
15-480440-00	RENAULT	677	64				
15-480440-00	VOLVO	831	39				
15-480450-00	DEUTZ/KHD	154	22				
15-480450-00	RENAULT	672	54				
15-480450-00	VOLVO	822	24				
15-570030-00	SCANIA	704	13				
15-570050-00	SCANIA	701	6				
15-570050-00	SCANIA	701	7				
15-570050-00	SCANIA	702	9				
15-570050-00	SCANIA	703	11				
15-570050-00	SCANIA	704	12				
15-570060-00	SCANIA	701	6				
15-570060-00	SCANIA	701	7				
15-570060-00	SCANIA	702	9				
15-570060-00	SCANIA	703	11				
15-570060-00	SCANIA	704	12				
15-570090-00	SCANIA	709	23				
15-600020-00	SCANIA	699	1				
15-600020-00	SCANIA	700	5				
15-608890-00	SCANIA	699	3				
15-608890-00	SCANIA	700	4				
15-610060-00	MERCEDES-BENZ	526	92				
15-632000-00	ALFA ROMEO	29	24				
15-632000-00	ALFA ROMEO	30	25				
15-632000-00	ALFA ROMEO	30	26				
15-632000-00	ALFA ROMEO	30	28				
15-632100-00	ALFA ROMEO	22	7				
15-632500-00	ALFA ROMEO	22	5				
15-632600-00	ALFA ROMEO	23	10				
15-634910-00	CITROËN	105	30				
15-634910-00	CITROËN	106	31				
15-634910-00	FIAT	181	44				
15-634910-00	PEUGEOT	621	31				
15-634910-00	PEUGEOT	621	32				
15-636600-00	CITROËN	96	10				
15-636600-00	CITROËN	97	11				
15-636600-00	CITROËN	97	12				
15-636600-00	PEUGEOT	611	10				
15-636600-00	PEUGEOT	612	11				
15-636600-00	PEUGEOT	613	12				
15-636600-00	PEUGEOT	613	13				
15-636600-00	TALBOT	772	2				
15-636700-00	CITROËN	95	9				
15-636700-00	PEUGEOT	613	14				
15-636700-00	RENAULT	648	8				
15-670050-00	MAN	408	40				
15-670070-00	SCANIA	709	22				
15-673200-00	VOLVO	824	29				
15-673200-00	VOLVO	825	30				
15-673200-00	VOLVO	826	31				
15-673200-00	VOLVO	827	32				
15-673200-00	VOLVO	830	37				
15-676420-00	ALFA ROMEO	31	30				
15-676420-00	CHRYSLER	88	5				
15-676420-00	FORD	226	53				
15-676420-00	JEEP	315	5				
15-676420-00	LAND ROVER	352	22				
15-676420-00	OPEL	593	56				
15-676420-00	ROVER	690	18				
15-676420-00	VAUXHALL	804	56				
15-676420-00	VM	807	2				









NUMERICAL PARTS LIST

Numerische Teilenummernliste • Liste des références produits
Liste da referencias

											
88-103200-00	DEUTZ/KHD	146	3	88-520500-00	FSO	236	2	89-176000-00	MERCEDES-BENZ	500	62
88-104000-00	CITROËN	104	28	88-520500-00	MG	530	4	89-176000-10	MERCEDES-BENZ	499	61
88-104000-00	FIAT	178	39	88-520500-00	ROVER	685	5	89-179300-05	MERCEDES-BENZ	511	73
88-104000-00	PEUGEOT	620	30	88-522700-00	LAND ROVER	344	1	89-179300-06	MERCEDES-BENZ	511	73
88-104300-00	MAN	406	37	88-522700-00	LOTUS	364	1	89-179300-15	MERCEDES-BENZ	510	72
88-115800-00	MERCEDES-BENZ	516	79	88-522700-00	MG	530	5	89-179300-21	MERCEDES-BENZ	512	74
88-121800-00	IVECO	296	45	88-522700-00	ROVER	686	7	89-179300-50	MERCEDES-BENZ	513	75
88-123900-10	DEUTZ/KHD	158	32	88-523000-00	DEUTZ/KHD	156	26	89-179300-65	MERCEDES-BENZ	507	70
88-124500-30	MAN	410	42	88-523000-00	IVECO	294	41	89-179300-65	MERCEDES-BENZ	519	84
88-136000-20	MERCEDES-BENZ	523	88	88-523000-00	NEW HOLLAND	553	16	89-179300-66	MERCEDES-BENZ	507	70
88-136500-00	MAN	382	5	88-523600-00	JAGUAR	311	10	89-179300-66	MERCEDES-BENZ	519	84
88-136500-10	MAN	382	5	88-527600-00	FIAT	166	6	89-179300-70	MERCEDES-BENZ	506	69
88-136500-65	MAN	384	7	88-528300-00	FIAT	168	11	89-179300-71	MERCEDES-BENZ	506	69
88-136900-00	DEUTZ/KHD	153	19	88-528400-00	FIAT	173	25	89-179300-80	MERCEDES-BENZ	518	82
88-136900-00	DEUTZ/KHD	154	23	88-740300-00	DEUTZ/KHD	157	29	89-179300-81	MERCEDES-BENZ	518	82
88-136900-00	DEUTZ/KHD	155	24	88-740300-00	IVECO	300	53	89-179300-85	MERCEDES-BENZ	507	70
88-138900-10	CITROËN	97	11	88-740300-10	DEUTZ/KHD	157	29	89-179300-86	MERCEDES-BENZ	507	70
88-138900-10	PEUGEOT	612	11	88-740300-10	IVECO	300	53	89-179300-90	MERCEDES-BENZ	507	70
88-138900-30	CITROËN	97	11	88-740900-00	DEUTZ/KHD	150	13	89-179300-91	MERCEDES-BENZ	507	70
88-138900-30	PEUGEOT	612	11	88-743400-30	DAF	141	19	89-181700-60	MERCEDES-BENZ	505	68
88-138900-30	PEUGEOT	613	12	88-743400-40	DAF	141	16	89-181700-61	MERCEDES-BENZ	505	68
88-140500-00	COMPRESSOR	119	5	88-743400-50	DAF	141	17	89-280200-10	MAN	395	23
88-140500-10	COMPRESSOR	119	5	88-744600-00	DEUTZ/KHD	148	10	89-280400-00	MAN	395	24
88-141800-00	MERCEDES-BENZ	514	77	88-785300-10	IVECO	298	48	89-283100-00	MAN	401	32
88-141900-00	VOLVO	821	22	88-785500-00	FIAT	174	29	89-283100-00	MAN	404	35
88-142000-00	VOLVO	822	25	88-785500-00	FSO	236	3	89-283100-30	MAN	400	31
88-142900-00	IVECO	294	39	89-101100-00	VOLVO	842	58	89-283100-40	MAN	401	32
88-143800-50	MAN	408	40	89-101100-10	VOLVO	842	57	89-283100-80	MAN	402	33
88-154300-00	CITROËN	93	3	89-107100-30	ALFA ROMEO	30	28	89-283100-85	MAN	402	33
88-154300-00	PEUGEOT	609	3	89-107100-40	ALFA ROMEO	30	26	89-289600-00	MERCEDES-BENZ	521	87
88-154400-00	CITROËN	96	10	89-109200-30	SCANIA	700	5	89-316900-00	CITROËN	113	46
88-154400-00	PEUGEOT	611	10	89-110200-40	ALFA ROMEO	30	25	89-316900-00	FIAT	187	60
88-172500-00	DEUTZ/KHD	148	10	89-121800-00	IVECO	296	45	89-316900-00	PEUGEOT	628	47
88-174100-30	DAF	139	12	89-121900-30	IVECO	299	52	89-316900-00	TALBOT	772	4
88-174600-00	DEUTZ/KHD	151	16	89-122000-30	IVECO	300	55	89-334600-00	DAF	134	1
88-176800-00	MERCEDES-BENZ	498	60	89-123200-10	RENAULT	679	68	89-334600-00	RENAULT	646	4
88-181100-10	JOHN DEERE	317	3	89-123200-10	VOLVO	836	48	89-334600-00	VOLVO	813	1
88-181100-20	JOHN DEERE	317	2	89-123200-10	VOLVO	837	49	89-336400-10	RENAULT	649	9
88-181800-10	JOHN DEERE	317	1	89-123200-10	VOLVO	840	54	89-337500-00	RENAULT	674	58
88-207500-00	IVECO	293	38	89-123200-10	VOLVO	841	55	89-337500-10	RENAULT	674	58
88-207500-00	NEW HOLLAND	552	11	89-123200-30	VOLVO	835	44	89-337500-40	RENAULT	674	58
88-207500-10	IVECO	293	37	89-123200-35	RENAULT	679	68	89-337500-50	RENAULT	676	61
88-207500-10	NEW HOLLAND	551	10	89-123200-35	VOLVO	835	45	89-346500-10	RENAULT	670	49
88-207500-30	IVECO	293	37	89-123200-35	VOLVO	837	49	89-405500-10	VOLVO	817	15
88-207500-30	NEW HOLLAND	551	10	89-123200-40	VOLVO	835	45	89-405500-30	VOLVO	817	15
88-245500-00	IVECO	295	43	89-123200-40	VOLVO	836	46	89-405600-60	VOLVO	833	42
88-245500-00	NEW HOLLAND	554	17	89-123200-40	VOLVO	836	47	89-407100-00	VOLVO	826	31
88-245500-10	IVECO	295	42	89-124500-00	MAN	407	38	89-407100-20	VOLVO	830	37
88-245500-10	NEW HOLLAND	554	17	89-131400-40	RENAULT	673	56	89-420900-30	MERCEDES-BENZ	524	89
88-252800-00	DEUTZ/KHD	147	6	89-131500-30	RENAULT	673	56	89-420900-50	MERCEDES-BENZ	525	90
88-285900-00	MAN	381	4	89-135500-10	RENAULT	677	62	89-427000-00	MERCEDES-BENZ	517	80
88-285900-10	MAN	380	3	89-135500-30	RENAULT	678	65	89-427000-00	DAF	544	11
88-285900-40	MAN	387	9	89-136000-00	MERCEDES-BENZ	523	88	89-428000-00	IVECO	301	56
88-289300-00	MERCEDES-BENZ	490	54	89-136000-10	MERCEDES-BENZ	523	88	89-428600-00	MAN	391	16
88-289600-30	MERCEDES-BENZ	521	87	89-136800-10	VOLVO	829	35	89-428600-00	MAN	392	17
88-325600-10	NISSAN	569	27	89-136900-10	DEUTZ/KHD	153	20	89-430000-00	DEUTZ/KHD	154	22
88-325600-10	PERKINS	600	13	89-136900-10	DEUTZ/KHD	153	21	89-430000-00	RENAULT	672	54
88-335300-00	RENAULT	682	75	89-136900-10	DEUTZ/KHD	155	24	89-430000-00	VOLVO	822	24
88-335900-00	RENAULT	681	71	89-136900-10	VOLVO	821	23	89-431000-00	MAN	397	26
88-335900-10	RENAULT	681	71	89-141900-00	VOLVO	821	22	89-431000-00	MAN	398	27
88-335900-30	RENAULT	681	72	89-142500-30	VOLVO	818	16	89-431000-10	MAN	399	29
88-404500-00	COMPRESSOR	118	4	89-143600-00	SCANIA	703	10	89-431000-10	MAN	399	30
88-404500-10	COMPRESSOR	118	4	89-143600-00	SCANIA	703	11	89-431300-00	VOLVO	828	33
88-420900-00	MERCEDES-BENZ	524	89	89-143600-30	SCANIA	703	10	89-434100-00	IVECO	299	51
88-420900-10	MERCEDES-BENZ	524	89	89-143600-60	SCANIA	709	22	89-434400-00	VOLVO	839	51
88-423000-00	MAN	390	15	89-143600-70	SCANIA	704	13	89-434400-10	VOLVO	839	52
88-423000-10	MAN	389	14	89-143800-00	MAN	407	39	89-435000-00	RENAULT	670	47
88-428600-00	MAN	391	16	89-143800-10	MAN	407	39	89-437600-00	SCANIA	704	12
88-428600-00	MAN	392	17	89-143800-20	MAN	407	39	89-438800-00	RENAULT	677	64
88-429600-00	RENAULT	679	67	89-143800-30	MAN	405	36	89-438800-00	VOLVO	831	39
88-429600-10	RENAULT	678	66	89-151200-00	CITROËN	106	31	89-438900-00	VOLVO	823	26
88-433300-00	DAF	141	18	89-151200-00	PEUGEOT	621	31	89-501400-00	VOLVO	819	19









			
89-502600-00	VOLVO	829	36
89-522900-00	RENAULT	670	48
89-522900-10	RENAULT	672	52
89-522900-30	RENAULT	672	53
89-522900-40	RENAULT	671	51
89-522900-50	RENAULT	671	51
89-525300-00	LEYLAND	359	3
89-527200-00	ALFA ROMEO	22	6
89-527300-00	ALFA ROMEO	22	7
89-528500-00	ALFA ROMEO	23	10
89-530400-00	ALFA ROMEO	22	5
89-743200-00	MERCEDES-BENZ	520	86
89-962000-30	SCANIA	705	15
89-962000-50	SCANIA	708	20
89-962000-80	SCANIA	706	16

NÜRAL PISTONS FITTED WITH GOETZE RING SETS









 Nüral Piston	 GOETZE Rings Set	 Nüral Piston	 GOETZE Rings Set	 Nüral Piston	 GOETZE Rings Set	 Nüral Piston	 GOETZE Rings Set
87-100100-00	08-100100-00	87-110100-00	08-110100-00	87-116107-00	08-116107-00	87-136400-00	08-136400-00
87-101100-00	08-101100-00	87-110900-00	08-110900-00	87-117900-00	08-117900-00	87-136400-30	08-136400-10
87-101100-10	08-101100-00	87-110906-00	08-110906-00	87-117900-10	08-117900-00	87-136407-00	08-136407-10
87-101300-00	08-101300-00	87-112400-00	08-112400-00	87-117900-20	08-117900-00	87-136407-30	08-136407-10
87-101307-00	08-101307-00	87-112407-00	08-112407-00	87-117907-00	08-117907-00	87-136500-00	08-136500-00
87-101500-00	08-101500-00	87-113500-00	08-113500-00	87-117907-10	08-117907-00	87-136500-10	08-136500-10
87-101507-00	08-101507-00	87-113500-10	08-113500-00	87-117907-20	08-117907-00	87-136500-30	08-136500-30
87-101700-00	08-101700-00	87-113507-00	08-113507-00	87-118006-00	08-118006-00	87-136500-40	08-136500-30
87-101700-10	08-101700-00	87-113507-10	08-113507-00	87-119000-00	08-119000-00	87-136500-60	08-136500-30
87-102700-00	08-102700-00	87-113511-00	08-113511-00	87-119800-00	08-119800-00	87-136500-65	08-136500-30
87-102700-10	08-102700-00	87-113511-10	08-113511-00	87-119807-00	08-119807-00	87-136500-70	08-136500-30
87-102707-00	08-102707-00	87-114400-00	08-114400-00	87-121800-00	08-121800-00	87-136500-75	08-136500-30
87-102707-10	08-102707-00	87-114400-10	08-114400-00	87-121800-10	08-121800-00	87-136500-85	08-136500-30
87-102800-00	08-102800-00	87-114400-30	08-114400-00	87-121900-00	08-121900-00	87-136500-90	08-136500-30
87-102807-10	08-102807-00	87-114400-40	08-114400-40	87-122000-00	08-122000-00	87-136500-91	08-136500-30
87-102900-10	08-102900-00	87-114400-60	08-114400-40	87-122200-00	08-122200-00	87-136500-95	08-136500-10
87-103000-30	08-103000-00	87-114400-65	08-114400-45	87-122200-10	08-122200-00	87-136507-65	08-136507-30
87-103000-40	08-103000-00	87-114405-00	08-114405-00	87-122208-00	08-122208-00	87-136600-00	08-136600-00
87-103200-00	08-103200-00	87-114405-10	08-114405-00	87-122208-10	08-122208-00	87-136607-00	08-136607-00
87-103207-00	08-103207-00	87-114405-30	08-114405-00	87-123200-00	08-123200-00	87-136700-00	08-136700-00
87-103800-00	08-103800-00	87-114405-40	08-114405-40	87-123200-10	08-123200-00	87-136705-00	08-136705-00
87-103806-00	08-103806-00	87-114405-60	08-114405-40	87-123200-40	08-123200-00	87-136707-00	08-136707-00
87-103900-00	08-103900-00	87-114700-00	08-114700-00	87-123200-50	08-123200-00	87-136800-30	08-136800-00
87-103900-30	08-103900-00	87-114700-10	08-114700-00	87-123400-00	08-123400-00	87-136900-00	08-136900-00
87-103900-40	08-103900-00	87-114700-30	08-114700-00	87-123400-10	08-123400-00	87-136900-10	08-136900-00
87-104000-00	08-104000-00	87-114700-40	08-114700-00	87-123400-20	08-123400-00	87-136900-30	08-136900-00
87-104008-00	08-104008-00	87-114708-00	08-114708-00	87-123400-30	08-123400-30	87-137500-10	08-137500-10
87-104100-00	08-104100-00	87-114708-10	08-114708-00	87-123400-40	08-123400-30	87-137500-30	08-137500-00
87-104105-00	08-104105-00	87-114708-40	08-114708-00	87-123400-50	08-123400-30	87-137507-10	08-137507-10
87-104107-00	08-104107-00	87-114900-05	08-114900-00	87-123407-00	08-123407-00	87-137507-30	08-137507-00
87-104200-00	08-104200-00	87-114900-15	08-114900-00	87-123407-10	08-123407-00	87-137600-00	08-137600-00
87-104200-10	08-104200-00	87-114900-20	08-114900-00	87-123407-20	08-123407-00	87-137606-00	08-137606-00
87-104200-30	08-104200-00	87-114900-25	08-114900-00	87-123407-30	08-123407-30	87-138000-00	08-138000-00
87-104200-40	08-104200-00	87-114900-30	08-114900-00	87-123407-40	08-123407-30	87-138000-10	08-138000-00
87-104207-00	08-104207-00	87-114900-35	08-114900-00	87-123407-50	08-123407-30	87-138006-00	08-138006-00
87-104207-10	08-104207-00	87-114900-45	08-114900-00	87-123700-30	08-123700-00	87-138006-10	08-138006-00
87-104207-40	08-104207-00	87-114900-46	08-114900-00	87-123721-30	08-123721-00	87-138008-00	08-138008-00
87-104300-00	08-104300-00	87-114900-55	08-114900-00	87-123900-10	08-123900-10	87-138008-10	08-138008-00
87-104300-10	08-104300-00	87-114900-56	08-114900-00	87-124000-00	08-124000-00	87-138400-00	08-138400-00
87-105500-00	08-105500-00	87-114900-60	08-114900-00	87-124000-30	08-124000-00	87-138400-10	08-138400-00
87-105507-00	08-105507-00	87-114900-65	08-114900-00	87-124008-00	08-124008-00	87-138400-30	08-138400-00
87-105900-00	08-105900-00	87-114900-66	08-114900-00	87-124008-30	08-124008-00	87-138400-60	08-138400-00
87-105907-00	08-105907-00	87-114900-70	08-114900-00	87-124500-00	08-124500-00	87-138406-00	08-138406-00
87-107000-00	08-107000-00	87-114900-80	08-114900-00	87-124500-20	08-124500-00	87-138406-10	08-138406-00
87-107000-10	08-107000-00	87-114900-85	08-114900-00	87-124500-30	08-124500-00	87-138406-30	08-138406-00
87-107007-10	08-107007-00	87-114900-90	08-114900-00	87-124800-00	08-124800-00	87-138406-40	08-138406-00
87-107011-10	08-107011-00	87-114900-95	08-114900-00	87-124806-00	08-124806-00	87-138408-10	08-138408-00
87-107100-30	08-107100-00	87-114905-90	08-114905-00	87-125600-00	08-125600-00	87-138900-10	08-138900-00
87-107100-40	08-107100-10	87-114907-05	08-114907-00	87-125607-00	08-125607-00	87-138900-30	08-138900-00
87-107600-00	08-107600-00	87-114907-15	08-114907-00	87-126000-00	08-126000-00	87-139400-00	08-139400-00
87-107607-00	08-107607-00	87-114907-20	08-114907-00	87-126000-10	08-126000-00	87-139407-00	08-139407-00
87-108200-00	08-108200-00	87-114907-25	08-114907-00	87-126007-00	08-126007-00	87-139500-00	08-139500-00
87-108208-00	08-108208-00	87-114907-30	08-114907-00	87-126007-10	08-126007-00	87-139500-10	08-139500-00
87-109100-00	08-109100-00	87-114907-35	08-114907-00	87-126300-10	08-126300-10	87-139500-20	08-139500-00
87-109100-10	08-109100-00	87-114907-45	08-114907-00	87-126311-10	08-126311-10	87-139500-30	08-139500-00
87-109107-00	08-109107-00	87-114907-46	08-114907-00	87-127400-00	08-127400-00	87-139500-40	08-139500-00
87-109107-10	08-109107-00	87-114907-55	08-114907-00	87-127400-10	08-127400-00	87-139507-00	08-139507-00
87-109200-00	08-109200-00	87-114907-56	08-114907-00	87-127407-00	08-127407-00	87-139507-10	08-139507-00
87-109400-50	08-109400-10	87-114907-60	08-114907-00	87-127407-10	08-127407-00	87-139507-20	08-139507-00
87-109407-50	08-109407-10	87-114907-65	08-114907-00	87-127800-00	08-127800-00	87-139507-30	08-139507-00
87-109500-00	08-109500-00	87-114907-66	08-114907-00	87-127900-00	08-127900-00	87-139507-40	08-139507-00
87-109505-00	08-109505-00	87-114907-70	08-114907-00	87-127907-00	08-127907-00	87-140000-00	08-140000-00
87-109507-00	08-109507-00	87-114907-80	08-114907-00	87-131500-00	08-131500-10	87-140007-00	08-140007-00
87-109511-00	08-109511-00	87-114907-85	08-114907-00	87-135300-00	08-135300-00	87-140500-00	08-140500-00
87-109700-10	08-109700-00	87-114907-90	08-114907-00	87-135300-10	08-135300-00	87-140800-00	08-140800-00
87-109705-10	08-109705-00	87-114907-95	08-114907-00	87-135307-00	08-135307-00	87-140800-10	08-140800-00
87-109707-10	08-109707-00	87-114911-20	08-114911-00	87-135500-00	08-135500-10	87-140807-00	08-140807-00
87-109800-10	08-109800-00	87-114911-70	08-114911-00	87-135500-10	08-135500-10	87-140807-10	08-140807-00
87-109807-10	08-109807-00	87-115800-00	08-115800-00	87-136000-00	08-136000-00	87-141200-00	08-141200-00
87-109811-10	08-109811-00	87-116100-00	08-116100-00	87-136000-10	08-136000-00	87-141207-00	08-141207-00

Nüral Kolben ausgestattet mit Goetze Kolbenringsätzen
 Pistons Nüral équipés de jeux de segments Goetze
 Pistones Nüral equipados con conjuntos de segmentos Goetze

Tłoki Nüral z zamontowanymi zestawami pierścieni Goetze
 Поршни Nüral, оснащаемые кольцами Goetze
 Goetze يتم تركيب كياسات Nüral باستخدام مجموعات حلقات









 Nüral Piston	 GOETZE Rings Set	 Nüral Piston	 GOETZE Rings Set	 Nüral Piston	 GOETZE Rings Set	 Nüral Piston	 GOETZE Rings Set
87-141300-00	08-141300-00	87-152007-10	08-152007-00	87-202407-10	08-202407-10	87-306800-30	08-306800-00
87-141300-10	08-141300-10	87-152010-10	08-152010-00	87-203500-00	08-203500-10	87-306807-10	08-306807-00
87-141300-20	08-141300-10	87-152700-00	08-152700-00	87-206607-10	08-206607-00	87-306900-00	08-306900-00
87-141307-00	08-141307-00	87-152707-00	08-152707-00	87-206800-00	08-206800-00	87-306907-10	08-306907-00
87-141307-10	08-141307-10	87-154200-00	08-154200-00	87-206808-00	08-206808-00	87-306907-00	08-306907-00
87-141307-20	08-141307-10	87-154200-10	08-154200-00	87-206808-00	08-206808-00	87-306907-10	08-306907-00
87-141800-00	08-141800-00	87-154200-30	08-154200-00	87-207200-00	08-207200-00	87-306907-20	08-306907-00
87-141900-00	08-141900-00	87-154206-00	08-154206-00	87-207208-00	08-207208-00	87-307100-20	08-307100-00
87-142000-00	08-142000-00	87-154206-10	08-154206-00	87-207500-00	08-207500-00	87-307107-20	08-307107-00
87-142100-00	08-142100-00	87-154206-30	08-154206-00	87-207500-10	08-207500-00	87-307200-00	08-307200-00
87-142107-00	08-142107-00	87-154208-00	08-154208-00	87-207500-30	08-207500-00	87-307600-10	08-307600-00
87-142300-00	08-142300-00	87-154208-30	08-154208-00	87-207700-00	08-207700-00	87-307600-40	08-307600-00
87-142306-00	08-142306-00	87-154300-00	08-154300-00	87-207800-00	08-207800-30	87-307607-40	08-307607-00
87-142308-00	08-142308-00	87-154400-00	08-154400-00	87-207800-10	08-207800-10	87-307700-00	08-307700-00
87-142400-00	08-142400-00	87-167600-00	08-167600-10	87-208100-10	08-208100-10	87-307700-10	08-307700-00
87-142406-00	08-142406-00	87-167607-00	08-167607-10	87-209800-00	08-209800-00	87-307707-00	08-307707-00
87-142500-00	08-142500-00	87-167611-00	08-167611-10	87-209800-10	08-209800-00	87-307707-10	08-307707-00
87-142900-00	08-142900-00	87-172500-00	08-172500-00	87-209806-00	08-209806-00	87-307800-10	08-307800-00
87-143000-00	08-143000-00	87-172511-00	08-172511-00	87-209806-10	08-209806-00	87-307807-10	08-307807-00
87-143007-00	08-143007-00	87-174100-00	08-174100-10	87-209808-00	08-209808-00	87-313400-00	08-313400-00
87-143600-00	08-143600-10	87-174100-30	08-174100-10	87-209808-10	08-209808-00	87-314600-00	08-314600-00
87-143600-30	08-143600-10	87-174300-00	08-174300-10	87-214800-10	08-214800-10	87-314600-10	08-314600-00
87-143600-60	08-143600-10	87-174307-00	08-174307-10	87-214807-10	08-214807-10	87-318000-00	08-318000-10
87-143600-70	08-143600-10	87-174311-00	08-174311-10	87-214809-10	08-214809-10	87-318700-00	08-318700-10
87-143800-00	08-143800-00	87-174600-00	08-174600-10	87-214811-10	08-214811-10	87-318700-10	08-318700-10
87-143800-10	08-143800-00	87-174600-30	08-174600-10	87-244500-10	08-244500-00	87-318700-30	08-318700-10
87-143800-20	08-143800-00	87-174607-30	08-174607-10	87-244500-40	08-244500-00	87-318706-00	08-318706-10
87-143800-30	08-143800-00	87-176000-00	08-176000-10	87-245200-30	08-245200-00	87-318706-10	08-318706-10
87-143800-40	08-143800-00	87-176000-10	08-176000-00	87-245200-40	08-245200-00	87-318706-30	08-318706-10
87-143800-50	08-143800-00	87-176407-00	08-176407-10	87-245200-50	08-245200-00	87-318708-00	08-318708-10
87-143800-60	08-143800-00	87-176600-00	08-176600-00	87-245500-00	08-245500-00	87-318708-30	08-318708-10
87-144200-00	08-144200-00	87-176607-00	08-176607-00	87-245500-10	08-245500-00	87-318710-30	08-318710-10
87-144207-00	08-144207-00	87-176611-00	08-176611-00	87-245500-30	08-245500-00	87-318711-00	08-318711-10
87-145000-00	08-145000-00	87-176700-00	08-176700-00	87-247200-00	08-247200-10	87-319000-00	08-319000-30
87-145007-00	08-145007-00	87-176708-00	08-176708-00	87-247800-00	08-247800-00	87-319000-10	08-319000-30
87-145100-00	08-145100-00	87-176800-00	08-176800-10	87-247800-10	08-247800-00	87-321500-10	08-321500-00
87-145106-00	08-145106-00	87-176900-00	08-176900-30	87-252500-10	08-252500-00	87-321507-10	08-321507-00
87-145108-00	08-145108-00	87-176911-00	08-176911-10	87-252500-30	08-252500-10	87-321510-10	08-321510-00
87-145206-00	08-145206-00	87-178200-20	08-178200-10	87-252507-10	08-252507-00	87-322000-00	08-322000-00
87-145300-00	08-145300-00	87-178207-00	08-178207-10	87-252507-30	08-252507-10	87-323607-00	08-323607-00
87-145306-00	08-145306-00	87-178211-20	08-178211-10	87-252800-00	08-252800-00	87-325600-00	08-325600-00
87-145400-00	08-145400-00	87-178800-00	08-178800-00	87-263100-10	08-263100-00	87-325600-10	08-325600-00
87-145400-30	08-145400-00	87-178807-00	08-178807-00	87-263107-00	08-263107-00	87-325600-30	08-325600-00
87-145406-30	08-145406-00	87-178811-00	08-178811-00	87-263107-10	08-263107-00	87-325800-00	08-325800-00
87-146100-00	08-146100-00	87-179000-10	08-179000-10	87-269806-00	08-269806-00	87-325806-00	08-325806-00
87-146100-10	08-146100-00	87-179300-05	08-179300-10	87-279600-10	08-279600-00	87-326300-00	08-326300-00
87-146106-10	08-146106-00	87-179300-06	08-179300-10	87-280200-10	08-280200-00	87-326307-00	08-326307-00
87-146108-00	08-146108-00	87-179300-10	08-179300-10	87-280400-00	08-280400-10	87-333300-00	08-333300-00
87-146400-00	08-146400-00	87-179300-15	08-179300-10	87-283100-00	08-283100-00	87-333500-00	08-333500-00
87-146500-00	08-146500-00	87-179300-20	08-179300-10	87-283100-30	08-283100-00	87-334400-00	08-334400-00
87-146507-00	08-146507-00	87-179300-30	08-179300-10	87-283100-80	08-283100-00	87-335100-10	08-335100-00
87-148100-00	08-148100-00	87-179300-50	08-179300-10	87-283100-85	08-283100-00	87-335300-00	08-335300-00
87-148100-10	08-148100-00	87-179300-55	08-179300-10	87-285800-00	08-285800-00	87-335900-00	08-335900-00
87-148100-30	08-148100-00	87-179300-60	08-179300-10	87-285900-00	08-285900-00	87-335900-30	08-335900-00
87-148100-40	08-148100-00	87-179300-65	08-179300-10	87-285900-05	08-285900-00	87-336500-00	08-336500-00
87-148100-80	08-148100-00	87-179300-70	08-179300-10	87-285900-10	08-285900-00	87-336500-10	08-336500-00
87-148100-85	08-148100-00	87-179300-80	08-179300-10	87-285900-40	08-285900-00	87-336507-00	08-336507-00
87-148105-00	08-148105-00	87-179300-85	08-179300-10	87-287100-30	08-287100-00	87-336510-10	08-336510-00
87-148105-10	08-148105-00	87-179300-90	08-179300-10	87-287107-30	08-287107-00	87-337300-00	08-337300-00
87-148105-30	08-148105-00	87-179500-10	08-179500-00	87-287500-20	08-287500-00	87-337500-00	08-337500-00
87-148105-80	08-148105-00	87-179507-10	08-179507-00	87-287500-30	08-287500-00	87-337500-10	08-337500-00
87-148107-00	08-148107-00	87-181100-10	08-181100-00	87-287505-30	08-287505-00	87-337500-50	08-337500-00
87-148107-10	08-148107-00	87-181100-20	08-181100-00	87-287507-20	08-287507-00	87-346500-00	08-346500-10
87-148107-30	08-148107-00	87-181700-00	08-181700-00	87-287507-30	08-287507-00	87-373800-00	08-373800-00
87-148107-40	08-148107-00	87-183000-00	08-183000-00	87-289300-00	08-289300-00	87-373800-10	08-373800-00
87-148107-80	08-148107-00	87-183007-00	08-183007-00	87-289300-10	08-289300-00	87-404500-00	08-404500-00
87-148107-85	08-148107-00	87-183300-00	08-183300-00	87-289600-00	08-289600-00	87-404511-00	08-404511-00
87-148300-00	08-148300-00	87-183307-00	08-183307-00	87-306307-00	08-306307-00	87-405500-10	08-405500-10
87-148307-00	08-148307-00	87-202400-10	08-202400-10	87-306311-00	08-306311-00	87-407000-00	08-407000-10
87-152000-10	08-152000-00	87-202400-10	08-202400-10	87-306800-10	08-306800-00	87-407100-00	08-407100-10

NÜRAL PISTONS FITTED WITH GOETZE RING SETS

 Niiral Piston	 GOETZE Rings Set	 Niiral Piston	 GOETZE Rings Set	 Niiral Piston	 GOETZE Rings Set	 Niiral Piston	 GOETZE Rings Set
87-420900-00	08-420900-00	87-427400-60	08-427400-00	87-433300-00	08-433300-00	87-440500-00	08-440500-00
87-420900-10	08-420900-00	87-427400-70	08-427400-00	87-433400-00	08-433400-00	87-440900-00	08-440900-00
87-420900-50	08-420900-00	87-427400-80	08-427400-00	87-433400-10	08-433400-00	87-441900-00	08-441900-00
87-421000-10	08-421000-00	87-427400-90	08-427400-00	87-433405-00	08-433405-00	87-442300-10	08-442300-10
87-421000-20	08-421000-00	87-427407-00	08-427407-00	87-433407-00	08-433407-00	87-442400-00	08-442400-00
87-421000-30	08-421000-00	87-427407-10	08-427407-00	87-433407-10	08-433407-00	87-442400-10	08-442400-00
87-421107-10	08-421107-00	87-427500-00	08-427500-00	87-433500-00	08-433500-00	87-442407-00	08-442407-00
87-421107-20	08-421107-00	87-427507-00	08-427507-00	87-433505-00	08-433505-00	87-442407-10	08-442407-00
87-421107-30	08-421107-00	87-427600-10	08-427600-10	87-433507-00	08-433507-00	87-443100-00	08-443100-00
87-421600-00	08-421600-00	87-427700-10	08-427700-00	87-433600-00	08-433600-00	87-443100-10	08-443100-00
87-422000-00	08-422000-00	87-427700-30	08-427700-00	87-433607-00	08-433607-00	87-443108-00	08-443108-00
87-422000-10	08-422000-00	87-427700-40	08-427700-00	87-433700-00	08-433700-00	87-443108-10	08-443108-00
87-422007-00	08-422007-00	87-427700-50	08-427700-00	87-433707-00	08-433707-00	87-443600-00	08-443600-00
87-422007-10	08-422007-00	87-427707-10	08-427707-00	87-433800-00	08-433800-00	87-443700-00	08-443700-00
87-422100-00	08-422100-00	87-427707-30	08-427707-00	87-433900-10	08-433900-00	87-443707-00	08-443707-00
87-422200-10	08-422200-00	87-427707-40	08-427707-00	87-433907-10	08-433907-00	87-443800-00	08-443800-00
87-422207-10	08-422207-00	87-427707-50	08-427707-00	87-434100-00	08-434100-00	87-443800-10	08-443800-00
87-422300-00	08-422300-00	87-427800-00	08-427800-00	87-434200-00	08-434200-00	87-443807-00	08-443807-00
87-422300-10	08-422300-00	87-427807-00	08-427807-00	87-434207-00	08-434207-00	87-443900-10	08-443900-00
87-422307-00	08-422307-00	87-427900-00	08-427900-00	87-434300-00	08-434300-00	87-444100-00	08-444100-00
87-422307-10	08-422300-00	87-428000-00	08-428000-00	87-434307-00	08-434307-00	87-444105-00	08-444105-00
87-422400-10	08-422400-00	87-428600-00	08-428600-00	87-434400-00	08-434400-00	87-444107-00	08-444107-00
87-422407-10	08-422407-00	87-428600-10	08-428600-00	87-434400-10	08-434400-00	87-444500-00	08-444500-00
87-423000-00	08-423000-00	87-428700-00	08-428700-00	87-434400-30	08-434400-00	87-444600-00	08-444600-00
87-423000-10	08-423000-00	87-428707-00	08-428707-00	87-434600-00	08-434600-00	87-444600-10	08-444600-00
87-423300-00	08-423300-00	87-428800-00	08-428800-00	87-434600-10	08-434600-00	87-444800-10	08-444800-10
87-423400-00	08-423400-00	87-428900-00	08-428900-00	87-435000-00	08-435000-00	87-444800-50	08-444800-10
87-423407-00	08-423407-00	87-429100-00	08-429100-00	87-435100-00	08-435100-10	87-444807-10	08-444807-10
87-423900-00	08-423900-00	87-429100-10	08-429100-00	87-435200-00	08-435200-00	87-444807-50	08-444807-10
87-424000-00	08-424000-00	87-429200-00	08-429200-00	87-435207-00	08-435207-00	87-445400-00	08-445400-00
87-424008-00	08-424008-00	87-429300-10	08-429300-10	87-435300-00	08-435300-00	87-446200-00	08-446200-00
87-424100-00	08-424100-00	87-429306-10	08-429306-10	87-435307-00	08-435307-00	87-446300-00	08-446300-00
87-424107-00	08-424107-00	87-429400-00	08-429400-00	87-435407-00	08-435407-00	87-447500-10	08-447500-00
87-424300-00	08-424300-00	87-429407-00	08-429407-00	87-435500-00	08-435500-00	87-447500-30	08-447500-00
87-424307-00	08-424307-00	87-429500-00	08-429500-00	87-435507-00	08-435507-00	87-447507-30	08-447507-00
87-424400-00	08-424400-00	87-429500-10	08-429500-00	87-435700-00	08-435700-00	87-447800-00	08-447800-00
87-424407-00	08-424407-00	87-429500-30	08-429500-00	87-435700-10	08-435700-00	87-447807-00	08-447807-00
87-424500-00	08-424500-00	87-429500-40	08-429500-00	87-435706-00	08-435706-00	87-447900-00	08-447900-00
87-424507-00	08-424507-00	87-429507-00	08-429507-00	87-435706-10	08-435706-00	87-448500-00	08-448500-00
87-424600-00	08-424600-00	87-429507-10	08-429507-00	87-436100-00	08-436100-00	87-448507-00	08-448507-00
87-424607-00	08-424607-00	87-429507-30	08-429507-00	87-436100-30	08-436100-00	87-450000-00	08-450000-10
87-424700-00	08-424700-00	87-429900-00	08-429900-00	87-436107-00	08-436107-00	87-450007-10	08-450007-10
87-424707-00	08-424707-00	87-429907-00	08-429907-00	87-436107-30	08-436107-00	87-450400-00	08-450400-00
87-424800-00	08-424800-30	87-430000-00	08-430000-00	87-436500-00	08-436500-00	87-450400-10	08-450400-00
87-424807-00	08-424807-30	87-430200-00	08-430200-00	87-436506-00	08-436506-00	87-450500-00	08-450500-00
87-424900-00	08-424900-00	87-430300-00	08-430300-00	87-436700-00	08-436700-00	87-450600-00	08-450600-00
87-424907-00	08-424907-00	87-430600-00	08-430600-00	87-436700-10	08-436700-00	87-452400-00	08-452400-00
87-425200-00	08-425200-00	87-431000-00	08-431000-00	87-436708-00	08-436708-00	87-452407-00	08-452400-00
87-425300-00	08-425300-00	87-431000-10	08-431000-00	87-436708-10	08-436708-00	87-452600-00	08-452600-00
87-425307-00	08-425307-00	87-431300-00	08-431300-00	87-436800-00	08-436800-00	87-452607-00	08-452607-00
87-425600-00	08-425600-00	87-431600-00	08-431600-00	87-436806-00	08-436806-00	87-452800-10	08-452800-10
87-425606-00	08-425606-00	87-431600-10	08-431600-00	87-436900-00	08-436900-00	87-452800-30	08-452800-10
87-425608-00	08-425608-00	87-431700-00	08-431700-00	87-436900-15	08-436900-00	87-452900-00	08-452900-00
87-426100-00	08-426100-00	87-431707-00	08-431707-00	87-436907-00	08-436907-00	87-452907-00	08-452907-00
87-426107-00	08-426107-00	87-431900-00	08-431900-00	87-436907-15	08-436907-00	87-453000-00	08-453000-00
87-426200-00	08-426200-00	87-431907-00	08-431907-00	87-437000-00	08-437000-00	87-453007-00	08-453007-00
87-426300-00	08-426300-00	87-432200-00	08-432200-00	87-437000-10	08-437000-00	87-453100-00	08-453100-00
87-426600-00	08-426600-00	87-432205-00	08-432205-00	87-437007-00	08-437007-00	87-501400-00	08-501400-00
87-426700-00	08-426700-00	87-432207-00	08-432207-00	87-437007-10	08-437007-00	87-501500-00	08-501500-00
87-426707-00	08-426707-00	87-432300-00	08-432300-00	87-437400-10	08-437400-00	87-501500-10	08-501500-00
87-426900-00	08-426900-00	87-432300-10	08-432300-10	87-437407-10	08-437407-00	87-501500-30	08-501500-00
87-426900-10	08-426900-00	87-432307-00	08-432307-00	87-437500-00	08-437500-00	87-501500-40	08-501500-00
87-427000-00	08-427000-00	87-432307-10	08-432307-10	87-437600-00	08-437600-00	87-501507-00	08-501507-00
87-427100-00	08-427100-00	87-432400-00	08-432400-00	87-437700-00	08-437700-00	87-501507-10	08-501507-00
87-427105-00	08-427105-00	87-432500-00	08-432500-00	87-437707-00	08-437707-00	87-501507-30	08-501507-00
87-427107-00	08-427107-00	87-432500-10	08-432500-00	87-438500-00	08-438500-00	87-501507-40	08-501507-00
87-427400-00	08-427400-00	87-432900-00	08-432900-00	87-438507-00	08-438507-00	87-501800-10	08-501800-00
87-427400-10	08-427400-00	87-432905-00	08-432907-00	87-438800-00	08-438800-00	87-501800-20	08-501800-00
87-427400-20	08-427400-00	87-432907-00	08-432907-00	87-438900-00	08-438900-00	87-501800-40	08-501800-00
87-427400-30	08-427400-00	87-433200-00	08-433200-00	87-439100-10	08-439100-10	87-501807-10	08-501807-00

Nüral Kolben ausgestattet mit Goetze Kolbenringsätzen
 Pistons Nüral équipés de jeux de segments Goetze
 Pistones Nüral equipados con conjuntos de segmentos Goetze

Łłoki Nüral z zamontowanymi zestawami pierścieni Goetze
 Поршни Nüral, оснащаемые кольцами Goetze
 Goetze يتم تركيب كياسات Nüral باستخدام مجموعات حلقات

 Nüral Piston	 GOETZE Rings Set	 Nüral Piston	 GOETZE Rings Set	 Nüral Piston	 GOETZE Rings Set	 Nüral Piston	 GOETZE Rings Set
87-501807-20	08-501807-00	87-525100-10	08-525100-00	87-743400-30	08-743400-00	87-962000-80	08-962000-00
87-502700-00	08-502700-00	87-525200-00	08-525200-00	87-743400-40	08-743400-00	87-990100-10	08-990100-00
87-502800-00	08-502800-00	87-525300-00	08-525300-00	87-743400-50	08-743400-00	87-990100-40	08-990100-00
87-502807-00	08-502807-00	87-525400-00	08-525400-00	87-743600-10	08-743600-00	87-990105-40	08-990105-00
87-502900-00	08-502900-00	87-525407-00	08-525407-00	87-743600-30	08-743600-00	87-990107-10	08-990107-00
87-502900-10	08-502900-00	87-525411-00	08-525411-00	87-743607-10	08-743607-00	87-990107-40	08-990107-00
87-502900-30	08-502900-00	87-525414-00	08-525414-00	87-743607-30	08-743607-00	87-990111-10	08-990111-00
87-502905-10	08-502905-00	87-525507-00	08-525507-00	87-744600-00	08-744600-00	87-990111-40	08-990111-00
87-502907-00	08-502907-00	87-525509-00	08-525509-00	87-744611-00	08-744611-00	87-990707-00	08-990707-00
87-502907-10	08-502907-00	87-525700-00	08-525700-00	87-780300-10	08-780300-10		
87-502907-30	08-502907-00	87-525707-00	08-525707-00	87-780300-30	08-780300-10		
87-520100-00	08-520100-00	87-525709-00	08-525709-00	87-780307-10	08-780307-10		
87-520100-10	08-520100-00	87-525711-00	08-525711-00	87-780311-10	08-780311-10		
87-520107-00	08-520107-00	87-525900-00	08-525900-00	87-780314-10	08-780314-10		
87-520107-10	08-520107-00	87-525907-00	08-525907-00	87-780600-10	08-780600-10		
87-520200-00	08-520200-00	87-525909-00	08-525909-00	87-780607-00	08-780607-10		
87-520500-00	08-520500-00	87-525911-00	08-525911-00	87-780607-10	08-780607-10		
87-521300-00	08-521300-00	87-525914-00	08-525914-00	87-780609-00	08-780609-10		
87-521300-10	08-521300-00	87-526300-00	08-526300-00	87-780609-10	08-780609-10		
87-521307-00	08-521307-00	87-526600-00	08-526600-00	87-780611-10	08-780611-10		
87-521307-10	08-521307-00	87-527200-00	08-527200-00	87-780614-00	08-780614-10		
87-521400-00	08-521400-00	87-527600-00	08-527600-00	87-780614-10	08-780614-10		
87-521407-00	08-521407-00	87-527606-00	08-527606-00	87-780617-00	08-780617-10		
87-521500-00	08-521500-00	87-527608-00	08-527608-00	87-780617-10	08-780617-10		
87-521500-10	08-521500-00	87-528300-00	08-528300-00	87-781900-10	08-781900-00		
87-521600-00	08-521600-00	87-528306-00	08-528306-00	87-781900-30	08-781900-10		
87-521700-00	08-521700-00	87-528400-00	08-528400-00	87-781908-10	08-781908-00		
87-521707-00	08-521707-00	87-528406-00	08-528406-00	87-781908-30	08-781908-10		
87-521711-00	08-521711-00	87-528408-00	08-528408-00	87-782000-00	08-782000-00		
87-521714-00	08-521714-00	87-528500-00	08-528500-00	87-782000-10	08-782000-00		
87-521800-20	08-521800-20	87-528600-00	08-528600-00	87-782008-00	08-782008-00		
87-521807-20	08-521807-20	87-529000-00	08-529000-00	87-782100-00	08-782100-00		
87-521811-20	08-521811-20	87-529907-00	08-529907-00	87-782600-00	08-782600-00		
87-522307-00	08-522307-10	87-529909-00	08-529909-00	87-782608-00	08-782608-00		
87-522309-00	08-522309-10	87-529911-00	08-529911-00	87-782900-00	08-782900-00		
87-522311-00	08-522311-10	87-530100-00	08-530100-00	87-782906-00	08-782906-00		
87-522314-00	08-522314-10	87-530107-00	08-530107-00	87-783000-00	08-783000-00		
87-522400-00	08-522400-00	87-530109-00	08-530109-00	87-783000-10	08-783000-00		
87-522600-00	08-522600-00	87-530400-00	08-530400-00	87-783000-15	08-783000-00		
87-522607-00	08-522607-00	87-704200-10	08-704200-10	87-783000-30	08-783000-00		
87-522700-00	08-522700-00	87-704207-10	08-704207-00	87-783800-10	08-783800-00		
87-522700-10	08-522700-00	87-714400-00	08-714400-00	87-783800-30	08-783800-00		
87-522900-00	08-522900-00	87-740000-10	08-740000-10	87-783808-30	08-783808-00		
87-522900-10	08-522900-00	87-740000-20	08-740000-10	87-783900-00	08-783900-00		
87-522900-30	08-522900-00	87-740000-30	08-740000-00	87-783900-10	08-783900-00		
87-522900-40	08-522900-00	87-740000-40	08-740000-10	87-784107-00	08-784107-00		
87-523000-00	08-523000-00	87-740000-50	08-740000-10	87-784800-00	08-784800-00		
87-523500-00	08-523500-00	87-740007-10	08-740007-10	87-784821-00	08-784821-00		
87-523600-00	08-523600-00	87-740007-20	08-740007-10	87-785000-00	08-785000-00		
87-523800-00	08-523800-00	87-740007-40	08-740007-10	87-785007-00	08-785007-00		
87-523807-00	08-523807-00	87-740007-50	08-740007-10	87-785011-00	08-785011-00		
87-523811-00	08-523811-00	87-740300-00	08-740300-10	87-785300-10	08-785300-00		
87-524000-00	08-524000-00	87-740900-00	08-740900-10	87-785500-00	08-785500-00		
87-524000-10	08-524000-00	87-740900-30	08-740900-10	87-785506-00	08-785506-00		
87-524007-00	08-524007-00	87-741200-10	08-741200-00	87-785508-00	08-785508-00		
87-524007-10	08-524007-00	87-741207-10	08-741207-00	87-786300-00	08-786300-00		
87-524009-00	08-524009-00	87-741211-10	08-741211-00	87-786400-00	08-786400-00		
87-524100-00	08-524100-00	87-741600-00	08-741600-00	87-786407-00	08-786407-00		
87-524107-00	08-524107-00	87-741800-00	08-741800-00	87-786500-00	08-786500-00		
87-524111-00	08-524111-00	87-741807-00	08-741807-00	87-786507-00	08-786507-00		
87-524114-00	08-524114-00	87-741807-20	08-741807-00	87-849000-00	08-849000-00		
87-524307-10	08-524307-10	87-743100-00	08-743100-00	87-849200-00	08-849200-50		
87-524311-10	08-524311-10	87-743100-10	08-743100-00	87-849207-00	08-849207-50		
87-524314-10	08-524314-10	87-743100-40	08-743100-00	87-854700-00	08-854700-00		
87-524400-00	08-524400-00	87-743107-00	08-743107-00	87-854708-00	08-854708-00		
87-525000-00	08-525000-00	87-743107-10	08-743107-00	87-879200-00	08-879200-00		
87-525007-00	08-525007-00	87-743107-40	08-743107-00	87-879207-00	08-879207-00		
87-525011-00	08-525011-00	87-743107-50	08-743107-00	87-962000-10	08-962000-00		
87-525014-00	08-525014-00	87-743120-10	08-743120-00	87-962000-30	08-962000-00		
87-525100-00	08-525100-00	87-743200-00	08-743200-00	87-962000-50	08-962000-00		

PISTON CLEARANCE & PROTRUSION DATA

EN

FBP	From base of piston
FPC	From piston crown
ABP	At base of piston
PCL	At pin centre line
FOC	From flat of crown
MP (D)	Measurement point (Datum)
BD	Bore diameter
PD	Piston diameter

ES

FBP	Desde la base del pistón
FPC	Desde la corona del pistón
ABP	En la base del pistón
PCL	En el centro del bulón
FOC	Desde la base de la corona
MP (D)	Punto de medida (dato)
BD	Diámetro de cilindro
PD	Diámetro de pistón

DE

FBP	Vom unteren Ende des Kolbenschafts
FPC	Vom Kolbenboden
ABP	Am unteren Ende des Kolbenschafts
PCL	Maß Kolbenblozen-Mitte
FOC	Flach vom Kolbenboden
MP (D)	Messepunkte
BD	Durchmesser Bohrung
PD	Durchmesser Kolben

PL

FBP	Od bazy tłoka
FPC	Od korony tłoka
ABP	W bazie tłoka
PCL	W osi centralnej sworznia
FOC	Od płaszczyzny korony
MP (D)	Punkt pomiarowy (Datum)
BD	Średnica cylindra
PD	Średnica tłoka

IT

FBP	Dalla base del pistone
FPC	Dalla testa del pistone
ABP	Alla base del pistone
PCL	All'asse foro spinotto
FOC	Dal piano testa
MP (D)	Punto di misurazione (dati)
BD	Alesaggio
PD	Diametro pistone

RU

FBP	От основания поршня
FPC	От головки поршня
ABP	У основания поршня
PCL	У оси поршневого пальца
FOC	От плоскости головки поршня
MP (D)	Точка измерения (начало отсчета)
BD	Диаметр цилиндра
PD	Диаметр поршня

FR

FBP	De la base du piston
FPC	De la tête du piston
ABP	À la base du piston
PCL	Au centre de l'axe
FOC	Du plat de la tête
MP (D)	Point de mesure (Système géodésique)
BD	Diamètre d'alésage
PD	Diamètre de piston

AR

FBP	من قاعدة المكبس
FPC	من تاج المكبس
ABP	على قاعدة المكبس
PCL	الخط المركزي للمسمار
FOC	من مسطح من التاج
MP (D)	نقطة القياس (بالمرجع)
BD	قطر الثقب
PD	قطر المكبس

PISTON CLEARANCE DATA

Kolben spiel • Dato de holgura del pistón
Jeu de piston • Dati di tolleranza pistone





87-100100-00	0.160		30.00mm FBP	111.770	111.610	87-121900-00	0.110		18.00mm FBP	125.000	124.890
87-101100-00	0.140		27.00mm FBP	144.000	143.860	87-122000-00	0.110		21.00mm FBP	135.000	134.890
87-101100-10	0.140		27.00mm FBP	144.000	143.860	87-122200-00	0.090		12.00mm FBP	94.400	94.310
87-101300-00	0.010		44.00mm FPC	67.105	67.095	87-122200-10	0.090		12.00mm FBP	94.400	94.310
87-101500-00	0.060		17.00mm FBP	80.000	79.940	87-123200-00	0.140		12.00mm FBP	131.000	130.860
87-101700-00	0.050		3.00mm FBP	100.000	99.950	87-123200-10	0.055		36.00mm FBP	131.000	130.945
87-102700-00	0.022		37.00mm FPC	72.500	72.478	87-123200-50	0.060		30.00mm FBP	131.010	130.950
87-102700-10	0.022		39.00mm FPC	72.500	72.478	87-123400-00	0.055		10.00mm FBP	76.000	75.945
87-102800-10	0.046		6.80mm FBP	83.975	83.929	87-123400-10	0.051		56.00mm FPC	76.000	75.949
87-102900-10	0.046		6.80mm FBP	83.975	83.929	87-123400-20	0.048		10.00mm FBP	76.000	75.952
87-103200-00	0.070		13.50mm FBP	91.000	90.930	87-123400-30	0.048		10.00mm FBP	76.000	75.952
87-103800-00	0.040		10.00mm FBP	78.500	78.460	87-123400-40	0.055		10.00mm FBP	76.000	75.945
87-103900-00	0.140		12.00mm FBP	104.000	103.860	87-123400-50	0.051		10.00mm FBP	76.000	75.949
87-103900-30	0.140		12.00mm FBP	104.000	103.860	87-123700-30	0.037		15.50mm FBP	93.660	93.623
87-103900-40	0.140		14.50mm FBP	104.000	103.860	87-123900-10	0.137		22.00mm FBP	132.010	131.873
87-104000-00	0.070		12.00mm FBP	82.200	82.130	87-124000-00	0.060		15.50mm FBP	82.000	81.940
87-104100-00	0.040		10.00mm FBP	69.000	68.960	87-124000-30	0.070		9.00mm FBP	82.000	81.930
87-104200-00	0.043		12.25mm FBP	79.500	79.457	87-124500-00	0.145		20.00mm FBP	128.000	127.855
87-104200-10	0.043		12.25mm FBP	79.500	79.457	87-124500-20	0.145		20.00mm FBP	128.000	127.855
87-104200-30	0.030		12.50mm FBP	79.510	79.480	87-124500-30	0.150		18.00mm FBP	128.000	127.850
87-104300-00	0.140		27.00mm FBP	128.000	127.860	87-124800-00	0.038		10.00mm FBP	80.500	80.462
87-104300-10	0.140		27.00mm FBP	128.000	127.860	87-125600-00	0.025		14.50mm FBP	79.000	78.975
87-105500-00	0.050		14.00mm FBP	83.000	82.950	87-126000-00	0.045		14.00mm FBP	84.000	83.955
87-105900-00	0.045		9.00mm FBP	81.010	80.965	87-126000-10	0.045		14.00mm FBP	84.000	83.955
87-107000-00	0.043		62.50mm FPC	82.500	82.457	87-126300-10	0.195		7.62mm FBP	103.190	102.995
87-107000-10	0.080		12.00mm FBP	82.500	82.420	87-127400-00	0.080		20.00mm FBP	87.000	86.920
87-107100-40	0.050		17.00mm FBP	84.000	83.950	87-127400-10	0.090		25.00mm FBP	87.000	86.910
87-107600-00	0.030		39.00mm FPC	89.600	89.570	87-127800-00	0.090		16.00mm FBP	98.000	97.910
87-108200-00	0.087		13.00mm FBP	94.400	94.313	87-127900-00	0.090		16.00mm FBP	101.000	100.910
87-109100-00	0.036		19.00mm FBP	90.900	90.864	87-131500-00	0.115		20.00mm FBP	120.030	119.915
87-109100-10	0.036		19.00mm FBP	90.900	90.864	87-135300-00	0.060		13.00mm FBP	73.700	73.640
87-109200-00	0.090		109.00mm FPC	115.000	114.910	87-135500-00	0.030		0.00mm ABP	123.000	122.970
87-109400-50	0.025		12.00mm FBP	81.010	80.985	87-136000-00	0.123		15.00mm FBP	130.000	129.877
87-109500-00	0.030		10.00mm FBP	76.510	76.480	87-136000-10	0.123		15.00mm FBP	130.000	129.877
87-109800-10	0.030		12.00mm FBP	76.510	76.480	87-136400-00	0.040		9.50mm FBP	88.009	87.969
87-110100-00	0.075		17.00mm FBP	92.000	91.925	87-136400-30	0.040		9.5mm FBP	88.009	87.969
87-110900-00	0.038		12.50mm FBP	83.000	82.962	87-136500-00	0.100		17.00mm FBP	108.000	107.900
87-112400-00	0.060		12.00mm FBP	92.000	91.940	87-136500-10	0.100		17.00mm FBP	108.000	107.900
87-113500-00	0.040		12.50mm FBP	89.910	89.870	87-136500-30	0.115		17.00mm FBP	108.000	107.885
87-113500-10	0.068		12.50mm FBP	89.910	89.842	87-136500-40	0.115		17.00mm FBP	108.000	107.885
87-114400-00	0.045		12.00mm FBP	84.000	83.955	87-136500-60	0.091		17.00mm FBP	108.000	107.909
87-114400-10	0.050		12.00mm FBP	84.000	83.950	87-136500-65	0.116		17.00mm FBP	108.000	107.884
87-114400-30	0.050		12.75mm FBP	84.000	83.950	87-136500-70	0.091		17.00mm FBP	108.000	107.909
87-114400-40	0.055		12.75mm FBP	84.000	83.945	87-136500-75	0.116		17.00mm FBP	108.000	107.884
87-114400-60	0.055		12.75mm FBP	84.000	83.945	87-136500-85	0.116		17.00mm FBP	108.000	107.884
87-114400-65	0.055		12.75mm FBP	84.000	83.945	87-136500-90	0.140		19.00mm FBP	108.000	107.860
87-114700-00	0.090		20.00mm FBP	85.000	84.910	87-136500-91	0.140		19.00mm FBP	108.000	107.860
87-114700-10	0.065		10.00mm FBP	85.000	84.935	87-136600-00	0.030		7.00mm FBP	80.600	80.570
87-114700-30	0.075		15.00mm FBP	85.000	84.925	87-136700-00	0.030		23.00mm FBP	64.000	63.970
87-114700-40	0.056		15.00mm FBP	85.000	84.944	87-136800-30	0.120		28.00mm FBP	120.640	120.520
87-114900-05	0.050		10.00mm FBP	79.510	79.460	87-136900-00	0.100		18.00mm FBP	108.000	107.900
87-114900-15	0.050		10.00mm FBP	79.510	79.460	87-136900-10	0.110		18.00mm FBP	108.000	107.890
87-114900-20	0.050		10.50mm FBP	79.510	79.460	87-137500-10	0.100		0.00mm ABP	89.000	88.900
87-114900-25	0.050		10.00mm FBP	79.510	79.460	87-137500-30	0.120		25.00mm FBP	89.000	88.880
87-114900-30	0.050		10.50mm FBP	79.510	79.460	87-137600-00	0.070		12.00mm FBP	69.600	69.530
87-114900-35	0.050		10.00mm FBP	79.510	79.460	87-138000-00	0.092		15.00mm FBP	88.005	87.913
87-114900-45	0.050		10.00mm FBP	79.510	79.460	87-138000-10	0.092		15.00mm FBP	88.002	87.910
87-114900-46	0.050		10.00mm FBP	79.510	79.460	87-138400-00	0.038		10.00mm FBP	70.800	70.762
87-114900-55	0.050		10.00mm FBP	79.510	79.460	87-138400-10	0.030		8.50mm FBP	70.800	70.770
87-114900-56	0.050		10.00mm FBP	79.510	79.460	87-138400-30	0.040		15.00mm FBP	70.800	70.760
87-114900-60	0.070		10.00mm FBP	79.510	79.440	87-138400-40	0.100		9.00mm FBP	70.800	70.700
87-114900-65	0.050		10.00mm FBP	79.510	79.460	87-138900-10	0.030		10.00mm FBP	75.000	74.970
87-114900-66	0.050		10.00mm FBP	79.510	79.460	87-138900-30	0.020		41.50mm FPC	75.000	74.980
87-114900-70	0.050		10.00mm FBP	79.510	79.460	87-139400-00	0.025		5.00mm FBP	78.500	78.475
87-114900-80	0.050		10.00mm FBP	79.510	79.460	87-139500-00	0.060		10.00mm FBP	81.010	80.950
87-114900-85	0.070		10.00mm FBP	79.510	79.440	87-139500-10	0.050		10.00mm FBP	81.010	80.960
87-114900-90	0.070		10.00mm FBP	79.510	79.440	87-139500-20	0.050		10.00mm FBP	81.010	80.960
87-114900-95	0.070		10.00mm FBP	79.510	79.440	87-139500-30	0.075		10.50mm FBP	81.010	80.935
87-115800-00	0.150		15.00mm FBP	128.000	127.850	87-139500-40	0.075		10.50mm FBP	81.010	80.935
87-116100-00	0.035		12.00mm FBP	76.510	76.475	87-140000-00	0.082		14.00mm FBP	84.442	84.360
87-117900-00	0.040		10.50mm FBP	88.000	87.969	87-140500-00	0.070		12.00mm FBP	100.000	99.930
87-117900-10	0.031		9.50mm FBP	88.000	87.969	87-140800-00	0.055		12.00mm FBP	86.000	85.945
87-117900-20	0.040		10.50mm FBP	88.000	87.969	87-140800-10	0.055		12.00mm FBP	86.000	85.945
87-119000-00	0.018		7.50mm FBP	89.905	89.887	87-141200-00	0.035		8.00mm FBP	80.500	80.465
87-119800-00	0.100		0.00mm ABP	84.450	84.350	87-141300-00	0.030		10.00mm FBP	79.000	78.970
87-121800-00	0.120		18.00mm FBP	115.000	114.880	87-141300-10	0.030		10.00mm FBP	79.000	78.970
87-121800-10	0.100		18.00mm FBP	115.000	114.900	87-141300-20	0.020		15.00mm FBP	79.000	78.980



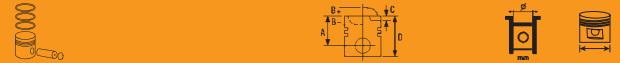







87-141800-00	0.115		30.00mm FBP	128.000	127.885	87-203500-00	0.100		24.00mm FBP	100.000	99.900
87-141900-00	0.081		120.00mm FPC	106.990	106.909	87-206800-00	0.110		15.00mm FBP	100.000	99.890
87-142000-00	0.110		28.00mm FBP	120.000	119.890	87-206800-10	0.092		0.00mm ABP	100.000	99.908
87-142100-00	0.110		18.00mm FBP	94.000	93.890	87-207200-00	0.090		15.00mm FBP	95.000	94.910
87-142300-00	0.035		12.50mm FBP	70.000	69.965	87-207500-00	0.150		25.00mm FBP	110.000	109.850
87-142400-00	0.070		15.00mm FBP	84.000	83.930	87-207500-10	0.140		40.00mm FBP	110.000	109.860
87-142500-00	0.115		25.00mm FBP	98.430	98.315	87-207500-30	0.140		40.00mm FBP	110.000	109.860
87-142900-00	0.140		22.00mm FBP	112.000	111.860	87-207800-00	0.230		35.00mm FBP	137.000	136.770
87-143000-00	0.100		15.00mm FBP	93.000	92.900	87-207800-10	0.145		30.50mm FBP	137.000	136.855
87-143600-00	0.055		3.60mm FBP	131.000	130.945	87-208100-10	0.178		22.31mm FBP	106.698	106.520
87-143600-30	0.140		20.00mm FBP	127.000	126.860	87-209800-00	0.020		16.00mm FBP	65.000	64.980
87-143600-50	0.140		20.00mm FBP	127.000	126.860	87-209800-10	0.020		16.00mm FBP	65.000	64.980
87-143600-60	0.140		36.00mm FBP	127.000	126.860	87-214800-10	0.129		26.42mm FBP	107.213	107.084
87-143600-70	0.210			127.000	126.790	87-244500-10	0.139		12.00mm FBP	104.000	103.861
87-143800-00	0.150		27.00mm FBP	128.000	127.850	87-244500-40	0.129		12.00mm FBP	104.000	103.871
87-143800-10	0.150		27.00mm FBP	128.000	127.850	87-245200-30	0.040		30.00mm FBP	93.000	92.960
87-143800-20	0.150		27.00mm FBP	128.000	127.850	87-245200-40	0.080		15.00mm FBP	93.000	92.920
87-143800-30	0.150		27.00mm FBP	128.000	127.850	87-245200-50	0.080		15.00mm FBP	93.000	92.920
87-143800-40	0.150		27.00mm FBP	128.000	127.850	87-245500-00	0.180		35.00mm FBP	115.000	114.820
87-143800-50	0.120		19.50mm FBP	128.000	127.880	87-245500-10	0.180		35.00mm FBP	115.000	114.820
87-143800-60	0.120		19.50mm FBP	128.000	127.880	87-246200-00	0.031		17.74mm FBP	93.021	92.990
87-145000-00	0.100		13.00mm FBP	102.000	101.900	87-247200-00	0.080		17.50mm FBP	86.000	85.920
87-145100-00	0.040		14.00mm FBP	65.000	64.960	87-247800-00	0.129		17.00mm FBP	104.000	103.871
87-145300-00	0.045		11.00mm FBP	83.000	82.955	87-247800-10	0.129		0.00mm ABP	104.000	103.871
87-145400-00	0.046		11.00mm FBP	82.000	81.954	87-252500-10	0.070		13.50mm FBP	91.000	90.930
87-145400-30	0.038		11.00mm FBP	82.000	81.962	87-252800-00	0.090		18.00mm FBP	94.000	93.910
87-146100-00	0.045		10.00mm FBP	82.000	81.955	87-263100-10	0.060		0.00mm ABP	90.475	90.415
87-146100-10	0.055		10.00mm FBP	82.000	81.945	87-279600-10	0.050		20.00mm FBP	105.000	104.950
87-146400-00	0.130		15.00mm FBP	106.000	105.870	87-280200-10	0.140		19.00mm FBP	125.000	124.860
87-146500-00	0.100		21.00mm FBP	94.000	93.900	87-280400-00	0.130		27.50mm FBP	125.000	124.870
87-148100-00	0.060		12.50mm FBP	89.905	89.845	87-283100-00	0.140		27.00mm FBP	128.000	127.860
87-148100-10	0.030		12.50mm FBP	89.900	89.870	87-283100-30	0.150		25.00mm FBP	128.000	127.850
87-148100-30	0.030		12.50mm FBP	89.900	89.870	87-283100-80	0.140		27.00mm FBP	128.000	127.860
87-148100-40	0.030		12.50mm FBP	89.900	89.870	87-283100-85	0.140		27.00mm FBP	128.000	127.860
87-148100-80	0.060		12.50mm FBP	89.905	89.845	87-285800-00	0.136		19.00mm FBP	108.000	107.864
87-148100-85	0.050		12.50mm FBP	89.900	89.850	87-285900-00	0.113		19.00mm FBP	108.000	107.887
87-148300-00	0.025		9.00mm FBP	81.000	80.975	87-285900-05	0.113		19.00mm FBP	108.000	107.887
87-152000-10	0.070		25.00mm FBP	83.000	82.930	87-285900-10	0.126		19.00mm FBP	108.000	107.874
87-154200-00	0.030		12.00mm FBP	70.000	69.970	87-285900-40	0.113		13.50mm FBP	108.000	107.887
87-154200-10	0.030		12.00mm FBP	70.000	69.970	87-287100-30	0.040		19.00mm FBP	91.100	91.060
87-154200-30	0.020		15.00mm FBP	70.000	69.980	87-287500-20	0.046		3.00mm FBP	89.900	89.854
87-154300-00	0.056		9.00mm FBP	72.000	71.944	87-287500-30	0.046		3.00mm FBP	89.900	89.854
87-154400-00	0.040		10.00mm FBP	75.000	74.960	87-289300-00	0.130		17.00mm FBP	102.000	101.870
87-167600-00	0.110		14.50mm FBP	120.000	119.890	87-289300-10	0.130		17.50mm FBP	102.000	101.870
87-172500-00	0.110		17.00mm FBP	100.000	99.890	87-289600-00	0.130		15.00mm FBP	130.000	129.870
87-174100-00	0.140		14.00mm FBP	130.000	129.860	87-306800-10	0.030		10.00mm FBP	86.000	85.970
87-174100-30	0.140		0.00mm ABP	130.000	129.860	87-306800-30	0.020		11.00mm FBP	86.000	85.980
87-174300-00	0.100		14.00mm FBP	97.000	96.900	87-306900-00	0.011		42.45mm FPC	79.000	78.989
87-174600-00	0.105		15.00mm FBP	102.005	101.900	87-306900-10	0.030		14.00mm FBP	79.000	78.970
87-174600-30	0.110		0.00mm ABP	102.000	101.890	87-307100-20	0.020		9.00mm FBP	77.600	77.580
87-176000-00	0.150		33.00mm FBP	125.000	124.850	87-307200-00	0.020		6.68mm FBP	84.800	84.780
87-176000-10	0.153		15.00mm FBP	125.000	124.847	87-307600-10	0.020		64.00mm FPC	78.975	78.955
87-176700-00	0.025		13.50mm FBP	90.900	90.875	87-307600-40	0.040		30.00mm FBP	79.000	78.960
87-176800-00	0.150		25.00mm FBP	125.000	124.850	87-307700-00	0.030		16.00mm FBP	81.580	81.550
87-176900-00	0.100		45.00mm FBP	128.000	127.900	87-307700-10	0.035		16.00mm FBP	81.580	81.545
87-178200-20	0.100		15.00mm FBP	97.000	96.900	87-307800-10	0.030		6.00mm FBP	79.000	78.970
87-178800-00	0.100		14.00mm FBP	97.000	96.900	87-313400-00	0.095		17.50mm FBP	79.375	79.280
87-179000-10	0.130		0.00mm ABP	104.175	104.045	87-314600-00	0.100		3.00mm FBP	91.480	91.380
87-179300-05	0.150		15.00mm FBP	128.000	127.850	87-314600-10	0.140		2.87mm FBP	91.480	91.340
87-179300-10	0.155		15.00mm FBP	128.000	127.845	87-318000-00	0.070		27.00mm FBP	101.054	100.984
87-179300-15	0.150		12.00mm FBP	128.000	127.850	87-318700-00	0.090		15.00mm FBP	94.000	93.910
87-179300-20	0.150		21.00mm FBP	128.000	127.850	87-318700-10	0.120		15.80mm FBP	94.000	93.880
87-179300-30	0.150		0.00mm ABP	128.000	127.850	87-318700-30	0.115		79.42mm FPC	94.022	93.907
87-179300-50	0.170		21.50mm FBP	128.000	127.830	87-319000-00	0.080		24.00mm FBP	98.480	98.400
87-179300-55	0.170		21.50mm FBP	128.000	127.830	87-319000-10	0.050		40.00mm FBP	98.480	98.430
87-179300-60	0.170		26.30mm FBP	128.000	127.830	87-321500-10	0.070		20.00mm FBP	80.000	79.930
87-179300-65	0.160		27.00mm FBP	128.000	127.840	87-322000-00	0.140		5.00mm FBP	91.480	91.340
87-179300-70	0.140		15.00mm FBP	128.000	127.860	87-325600-00	0.110		14.00mm FBP	100.000	99.890
87-179300-80	0.160		27.00mm FBP	128.000	127.840	87-325600-10	0.102		7.50mm FBP	100.000	99.898
87-179300-85	0.150		27.00mm FBP	128.000	127.850	87-325800-00	0.070		12.00mm FBP	77.000	76.930
87-179300-90	0.150		15.00mm FBP	128.000	127.850	87-326300-00	0.090		12.00mm FBP	92.010	91.920
87-179500-10	0.025		9.00mm FBP	89.000	88.975	87-333300-00	0.043		46.50mm FPC	58.008	57.965
87-181100-10	0.120		18.00mm FBP	106.500	106.380	87-334400-00	0.060		10.50mm FBP	88.000	87.940
87-181100-20	0.100		18.00mm FBP	106.500	106.400	87-335300-00	0.140		0.00mm FBP	135.030	134.890
87-181700-00	0.230		64.00 mm FBP	128.000	127.770	87-335900-00	0.140		17.00mm FBP	135.030	134.890
87-202400-00	0.180		22.35mm FBP	111.760	111.580	87-335900-30	0.100		29.00mm FBP	135.000	134.900
87-202400-10	0.192		22.40mm FBP	111.778	111.586	87-336500-00	0.025		12.00mm FBP	80.000	79.975

PISTON CLEARANCE DATA

Kolbenspiel • Dato de holgura del pistón
 Jeu de piston • Dati di tolleranza pistone





											
87-336500-10	0.040		12.50mm FBP	80.000	79.960	87-432900-00	0.147		35.00mm FBP	79.510	79.363
87-337300-00	0.030		14.00mm FBP	74.000	73.970	87-433300-00	0.160		30.00mm FBP	130.000	129.840
87-337500-00	0.030		35.00mm FBP	120.000	119.970	87-433400-00	0.054		19.00mm FBP	83.000	82.946
87-337500-10	0.055		20.00mm FBP	120.000	119.945	87-433400-10	0.123		37.80mm FBP	83.007	82.884
87-346500-00	0.085		27.00mm FBP	102.000	101.915	87-433500-00	0.035		10.00mm FBP	77.000	76.965
87-373800-00	0.030		15.00mm FBP	92.000	91.970	87-433600-00	0.060		12.00mm FBP	75.000	74.940
87-373800-10	0.050		10.00mm FBP	92.000	91.950	87-433700-00	0.015		14.00mm FBP	75.000	74.985
87-404500-00	0.080		5.70mm FBP	90.000	89.920	87-433800-00	0.122		27.00mm FBP	128.000	127.878
87-405500-10	0.100		21.30mm FBP	98.400	98.300	87-433900-10	0.050		9.50mm FBP	76.500	76.450
87-407000-00	0.110		12.00mm FBP	104.770	104.660	87-434200-00	0.060		15.50mm FBP	77.200	77.140
87-407100-00	0.160		25.00mm FBP	120.640	120.480	87-434300-00	0.060		9.00mm FBP	83.000	82.940
87-420900-00	0.203		64.00mm FBP	130.000	129.797	87-434400-00	0.150		40.00mm FBP	131.000	130.850
87-420900-10	0.123		15.00mm FBP	130.000	129.877	87-434400-10	0.070		0.00mm APC	131.010	130.940
87-420900-50	0.103		15.00mm FBP	130.000	129.897	87-434600-00	0.033		11.50mm FBP	84.000	83.967
87-421000-10	0.040		15.00mm FBP	81.000	80.960	87-434600-10	0.033		11.50mm FBP	84.000	83.967
87-421000-20	0.040		15.00mm FBP	81.000	80.960	87-435000-00	0.040		24.00mm FBP	102.000	101.960
87-421000-30	0.060		13.00mm FBP	81.010	80.950	87-435100-00	0.040		8.00mm FBP	82.510	82.470
87-422000-00	0.070		13.50mm FBP	84.000	83.930	87-435200-00	0.085		14.00mm FBP	85.010	84.925
87-422000-10	0.090		13.50mm FBP	84.000	83.910	87-435300-00	0.040		15.00mm FBP	79.010	78.970
87-422100-00	0.100		14.00mm FBP	100.000	99.900	87-435700-10	0.354		7.00mm FBP	69.905	69.551
87-422200-10	0.050		8.00mm FBP	80.000	79.950	87-436100-00	0.060		10.00mm FBP	89.000	88.940
87-422300-00	0.080		22.50mm FBP	80.000	79.920	87-436100-30	0.060		12.00mm FBP	89.000	88.940
87-422300-10	0.075		14.00mm FBP	80.000	79.925	87-436500-00	0.065		10.00mm FBP	83.000	82.955
87-422400-10	0.080		15.00mm FBP	96.000	95.920	87-436700-00	0.052		17.00mm FBP	85.000	84.948
87-423000-00	0.120		16.00mm FBP	120.000	119.880	87-436700-10	0.067		17.00mm FBP	85.000	84.933
87-423000-10	0.120		16.00mm FBP	120.000	119.880	87-436800-00	0.030		9.00mm FBP	72.000	71.970
87-424000-00	0.055		12.00mm FBP	75.000	74.945	87-436900-00	0.050		12.00mm FBP	76.510	76.460
87-424300-00	0.040		9.00mm FBP	71.900	71.860	87-436900-15	0.040		6.00mm FBP	76.500	76.460
87-424400-00	0.030		10.00mm FBP	79.000	78.970	87-437000-10	0.055		12.00mm FBP	82.500	82.445
87-424500-00	0.040		10.00mm FBP	89.000	88.960	87-437400-10	0.025		10.30mm FBP	72.492	72.467
87-424600-00	0.020			74.000	73.980	87-437600-00	0.060		33.00mm FBP	127.000	126.940
87-424700-00	0.030			78.000	77.970	87-437700-00	0.030		7.00mm FBP	78.000	77.970
87-424800-00	0.350		9.00mm FBP	77.000	76.650	87-438500-00	0.030		10.00mm FBP	82.500	82.470
87-424900-00	0.080		10.00mm FBP	80.000	79.920	87-438800-00	0.060		0.00mm APC	123.010	122.950
87-425200-00	0.015		10.00mm FBP	82.000	81.985	87-438900-00	0.110		30.00mm FBP	120.010	119.900
87-425300-00	0.045		9.00mm FBP	84.000	83.955	87-439100-10	0.069		14.00mm FBP	84.009	83.940
87-425600-00	0.054		7.00mm FBP	69.615	69.561	87-440500-00	0.052		15.00mm FBP	83.008	82.956
87-426100-00	0.035		15.00mm FBP	76.010	75.975	87-440900-00	0.020		14.40mm FBP	88.008	87.988
87-426200-00	0.080		14.00mm FBP	105.000	104.920	87-441900-00	0.055		14.50mm FBP	83.565	83.510
87-426300-00	0.030		8.50mm FBP	72.000	71.970	87-442400-00	0.110		21.00mm FBP	102.000	101.890
87-426600-00	0.040		5.00mm FBP	82.200	82.160	87-443100-00	0.544		17.00mm FBP	85.544	85.000
87-426700-00	0.040		0.00mm ABP	79.000	78.960	87-444100-00	0.090		10.00mm FBP	79.510	79.420
87-427000-00	0.130		30.00mm FBP	128.000	127.870	87-444200-00	0.040		12.00mm FBP	91.100	91.060
87-427100-00	0.020		6.00mm FBP	66.500	66.480	87-444200-10	0.040		12.00mm FBP	91.100	91.060
87-427400-00	0.041		16.50mm FBP	83.000	82.959	87-444500-00	0.050		69.00mm FTP	125.000	124.950
87-427400-10	0.041		16.50mm FBP	83.000	82.959	87-444700-00	0.130		27.00mm FBP	120.000	119.870
87-427400-20	0.043		16.50mm FBP	83.009	82.966	87-444800-50	0.043		10.00mm FBP	77.000	76.965
87-427400-30	0.034		16.50mm FBP	83.000	82.966	87-445400-00	0.130		21.55mm FBP	107.000	106.870
87-427500-00	0.031		16.50mm FBP	83.000	82.969	87-446200-00	0.055		12.50mm FBP	112.000	111.945
87-427600-10	0.030		15.00mm FBP	82.000	81.970	87-446300-00	0.070		18.00mm FBP	115.000	114.930
87-427700-10	0.030		11.82mm FBP	86.000	85.970	87-446400-00	0.110		14.00mm FBP	84.000	83.890
87-427700-30	0.030		11.82mm FBP	86.000	85.970	87-449000-00	0.040		11.00mm FBP	73.960	73.920
87-427700-40	0.060		11.82mm FBP	86.005	85.945	87-450000-00	0.025		8.00mm FBP	69.000	68.975
87-427700-50	0.050		11.82mm FBP	86.000	85.950	87-450500-00	0.054		7.00mm FBP	69.605	69.551
87-427900-00	0.115		12.00mm FBP	102.000	101.885	87-450900-00	0.060		13.00mm FBP	70.000	69.940
87-428000-00	0.116		18.00mm FBP	135.000	134.884	87-501400-00	0.110		12.00mm FBP	104.770	104.660
87-428600-00	0.120		16.00mm FBP	120.000	119.880	87-501500-00	0.050		60.50mm FPC	81.010	80.960
87-428600-10	0.120		16.00mm FBP	120.000	119.880	87-501500-10	0.050		60.50mm FPC	81.010	80.960
87-428700-00	0.031		9.50mm FBP	88.000	87.969	87-501500-30	0.050		60.50mm FPC	81.010	80.960
87-428800-00	0.084		15.00mm FBP	117.000	116.916	87-501800-10	0.035		12.00mm FBP	82.510	82.475
87-428900-00	0.130		17.50mm FBP	102.000	101.870	87-501800-20	0.040		12.00mm FBP	82.510	82.470
87-429100-00	0.091		17.00mm FBP	108.000	107.909	87-501800-40	0.035		12.00mm FBP	82.510	82.475
87-429100-10	0.136		19.30mm FBP	108.000	107.864	87-502700-00	0.100		23.00mm FBP	104.775	104.675
87-429200-00	0.080		16.00mm FBP	92.000	91.920	87-502800-00	0.020		9.00mm FBP	76.500	76.480
87-429300-10	0.060		7.00mm FBP	79.500	79.445	87-502900-00	0.035		15.00mm FBP	81.010	80.975
87-429500-10	0.360		10.00mm FBP	73.760	73.400	87-502900-10	0.060		0.00mm ABP	81.010	80.950
87-429500-40	0.04					87-502900-30	0.060		12.00mm FBP	81.010	80.950
87-429600-10	0.100		58.5mm FBP	124.000	123.762	87-520100-00	0.030		0.00mm ABP	88.860	88.830
87-429900-00	0.045		10.00mm FBP	76.500	76.455	87-520100-10	0.030		0.00mm ABP	88.860	88.830
87-430000-00	0.140		21.00mm FBP	108.000	107.860	87-520200-00	0.110		21.00mm FBP	93.000	92.890
87-431000-00	0.130		16.00mm FBP	126.000	125.870	87-520500-00	0.020		35.50mm FPC	74.970	74.950
87-431000-10	0.130		16.00mm FBP	126.000	125.870	87-521300-00	0.160		0.00mm ABP	111.760	111.600
87-431700-00	0.100		12.00mm FBP	91.000	90.900	87-521300-10	0.135		29.30mm FBP	111.760	111.625
87-432200-00	0.050		15.00mm FBP	84.000	83.950	87-521400-00	0.180		29.00mm FBP	111.770	111.590
87-432300-00	0.060		10.00mm FBP	81.010	80.950	87-521500-00	0.015		49.00mm FPC	94.000	93.985
87-432300-10	0.060		10.00mm FBP	81.010	80.950	87-521500-10	0.010		0.00mm ABP	94.000	93.990
87-432500-00	0.070		25.00 mm FBP	130.000	129.930	87-521600-00	0.028		0.03mm FPC	80.000	79.972











											
87-521700-00	0.030		7.00mm FBP	70.625	70.595	87-785300-10	0.168		19.70mm FBP	120.000	119.832
87-521800-20	0.080		15.00mm FBP	90.475	90.395	87-785500-00	0.070		57.25mm FPC	77.000	76.930
87-522400-00	0.010		5.10mm FBP	64.567	64.557	87-786300-00	0.015		46.40mm FPC	76.000	75.985
87-522600-00	0.100		77.75mm FOC	86.990	86.890	87-786400-00	0.030		9.00mm FBP	84.800	84.770
87-522700-00	0.010		35.50mm FPC	80.000	79.990	87-786500-00	0.040		10.00mm FBP	80.600	80.560
87-522700-10	0.030		10.00mm FBP	80.000	79.970	87-854700-00	0.077		17.00mm FBP	94.400	94.323
87-522900-00	0.010		0.00mm ABP	82.994	82.984	87-962000-30	0.140		12.00mm FBP	127.000	126.860
87-522900-10	0.070		12.00mm FBP	102.021	101.951	87-962000-50	0.140		30.67mm FBP	127.000	126.860
87-522900-30	0.055		12.00mm FBP	102.000	101.945	87-962000-80	0.120		27.00mm FBP	127.000	126.880
87-522900-40	0.080		108.20mm FPC	102.015	101.935	87-990100-10	0.030		15.00mm FBP	79.510	79.480
87-523000-00	0.160		30.00mm FBP	115.000	114.840	87-990100-40	0.163		10.00mm FBP	79.510	79.347
87-523500-00	0.140		8.60mm FBP	104.775	104.635						
87-523600-00	0.021		68.50mm FPC	90.000	89.979						
87-523800-00	0.185		2.20mm FBP	95.250	95.065						
87-524000-00	0.018		65.00mm FOC	92.075	92.057						
87-524000-10	0.026		65.00mm FOC	92.075	92.049						
87-524100-00	0.030		6.00mm FBP	70.625	70.595						
87-524400-00	0.013		72.00mm FPC	90.475	90.462						
87-525000-00	0.095		0.00mm ABP	87.312	87.217						
87-525100-00	0.140		10.00mm FBP	91.480	91.340						
87-525100-10	0.110		6.00mm FBP	91.480	91.370						
87-525200-00	0.150		10.00mm FBP	98.480	98.330						
87-525300-00	0.160		3.00mm FBP	98.000	97.840						
87-525400-00	0.129		0.00mm ABP	71.000	70.871						
87-525700-00	0.031		12.00mm FBP	74.688	74.657						
87-525900-00	0.020		0.00mm ABP	80.251	80.231						
87-526300-00	0.110		20.00mm FBP	95.000	94.890						
87-526600-00	0.048		0.00mm ABP	73.500	73.452						
87-527600-00	0.040		22.00mm FBP	67.400	67.360						
87-528300-00	0.050		15.00mm FBP	70.000	69.950						
87-528400-00	0.055		57.25mm FPC	73.500	73.445						
87-528500-00	0.040		15.00mm FBP	80.000	79.960						
87-528600-00	0.060		7.00mm FBP	65.000	64.940						
87-529000-00	0.060		16.00mm FBP	95.000	94.940						
87-530100-00	0.061		0.00mm ABP	83.343	83.282						
87-530400-00	0.040		16.00mm FBP	74.000	73.960						
87-704200-10	0.015		12.00mm FBP	84.000	83.985						
87-714400-00	0.040		9.00mm FBP	90.475	90.435						
87-740000-10	0.120		13.00mm FBP	97.500	97.380						
87-740000-20	0.110		20.00mm FBP	97.500	97.390						
87-740000-30	0.120		19.00mm FBP	97.500	97.380						
87-740000-40	0.110		16.00mm FBP	97.500	97.390						
87-740000-50	0.110		16.00mm FBP	97.500	97.390						
87-740300-00	0.120		13.00mm FBP	125.000	124.880						
87-740900-00	0.105		16.00mm FBP	102.000	101.895						
87-740900-30	0.110		21.50mm FBP	102.000	101.890						
87-741200-10	0.050		12.00mm FBP	85.000	84.950						
87-741600-00	0.060		15.00mm FBP	104.175	104.115						
87-741800-00	0.110		16.00mm FBP	100.000	99.890						
87-743100-00	0.031		9.50mm FBP	89.000	88.969						
87-743100-10	0.030		10.50mm FBP	89.000	88.970						
87-743100-40	0.031		9.50mm FBP	89.000	88.969						
87-743200-00	0.141		15.00mm FBP	130.000	129.859						
87-743400-30	0.140		33.00mm FBP	130.000	129.860						
87-743400-40	0.150		21.00mm FBP	130.000	129.850						
87-743400-50	0.150		21.00mm FBP	130.000	129.850						
87-743600-10	0.030		18.00mm FBP	87.000	86.970						
87-743600-30	0.040		12.00mm FBP	87.000	86.960						
87-744600-00	0.105		16.20mm FBP	100.000	99.895						
87-780300-10	0.040		0.00mm ABP	90.800	90.760						
87-780300-30	0.040		25.00mm FBP	90.800	90.760						
87-780600-10	0.060		10.00mm FBP	80.980	80.920						
87-781900-10	0.119		17.00mm FBP	100.000	99.881						
87-781900-30	0.108		0.00mm ABP	100.000	99.892						
87-782000-00	0.130		15.00mm FBP	103.000	102.870						
87-782000-10	0.133		0.00mm ABP	103.000	102.867						
87-782100-00	0.173		21.00mm FBP	145.000	144.827						
87-782900-00	0.050		8.00mm FBP	107.185	107.135						
87-783000-00	0.180		33.00mm FBP	137.000	136.820						
87-783000-10	0.180		33.00mm FBP	137.035	136.855						
87-783000-15	0.180		42.50mm FBP	137.000	136.820						
87-783000-30	0.180		33.00mm FBP	137.000	136.820						
87-783800-10	0.080		15.00mm FBP	82.600	82.520						
87-783800-30	0.030		15.00mm FBP	82.600	82.570						
87-783900-10	0.120		25.50mm FBP	103.000	102.880						
87-784800-00	0.040		15.50mm FBP	93.670	93.630						
87-785000-00	0.030		15.00mm FBP	74.000	73.970						

											
87-102800-10	OPEL 84 MM STD		+0.40	+0.50		STD gasket	M.BENZ-PKW 88 MM STD		+0.38	+0.62	
87-102800-10	OPEL 84 MM STD		+0.51	+0.60		1 notch gasket	87-121900-00	IVECO LKW 125 MM STD	+0.20	+0.25	
87-102800-10	OPEL 84 MM STD		+0.61	+0.70		2 notch gasket	87-122200-00	IVECO 94,4 MM STD	+0.45	+0.50	1.20mm gasket
87-102900-10	OPEL 83,975 MM STD		+0.40	+0.50		STD gasket	87-122200-00	IVECO 94,4 MM STD	+0.51	+0.60	1.30mm gasket
87-102900-10	OPEL 83,975 MM STD		+0.69	+0.76		2 notch gasket	87-122200-00	IVECO 94,4 MM STD	+0.61	+0.70	1.40mm gasket
87-102900-10	OPEL 83,975 MM STD		+0.76	+0.83		3 notch gasket	87-122200-00	IVECO 94,4 MM STD	+0.71	+0.80	1.50mm gasket
87-103200-00	KHD 91 MM STD		+0.59	+0.69		1 notch gasket	87-122200-10	IVECO 94,4 MM STD	+0.40	+0.50	1.20mm gasket
87-103200-00	KHD 91 MM STD		+0.69	+0.76		2 notch gasket	87-122200-10	IVECO 94,4 MM STD	+0.51	+0.60	1.30mm gasket
87-103200-00	KHD 91 MM STD		+0.76	+0.83		3 notch gasket	87-122200-10	IVECO 94,4 MM STD	+0.61	+0.70	1.40mm gasket
87-103900-00	IVECO 104 MM STD		+0.53	+0.72			87-122200-10	IVECO 94,4 MM STD	+0.71	+0.80	1.50mm gasket
87-103900-30	IVECO-TRK 104 MM STD		+0.48	+0.79			87-123400-10	RENAULT 76 MM STD	+0.25	+0.30	
87-104000-00	PEUGEOT 82,2 MM STD		+0.51	+0.55		1.26mm gasket	87-123700-30	FORD 93.67 MM STD	+0.25	+0.40	
87-104000-00	PEUGEOT 82,2 MM STD		+0.55	+0.59		1.30mm gasket	87-124000-30	FIAT-PKW 82 MM STD	+0.79	+0.88	STD gasket
87-104000-00	PEUGEOT 82,2 MM STD		+0.59	+0.63		1.34mm gasket	87-124000-30	FIAT-PKW 82 MM STD	+0.88	+0.96	1 notch gasket
87-104300-00	MAN 128 MM STD		+0.01	+0.33			87-124000-30	FIAT-PKW 82 MM STD	+0.96	+1.05	2 notch gasket
87-104300-10	MAN 128 MM STD KH-0,20		+0.01	+0.33			87-124500-00	MAN 128 MM STD	+0.10	+0.33	
87-105500-00	PEUGEOT 83 MM STD		+0.56	+0.67		1.36mm gasket	87-124500-10	MAN 128 MM STD KH 0,20 MM	+0.10	+0.33	
87-105500-00	PEUGEOT 83 MM STD		+0.68	+0.71		1.40mm gasket	87-126600-00	PEUGEOT 85.00 MM STD	+0.65	+0.75	1.52mm gasket
87-105500-00	PEUGEOT 83 MM STD		+0.72	+0.75		1.44mm gasket	87-126600-00	PEUGEOT 85.00 MM STD	+0.77	+0.81	1.57mm gasket
87-105500-00	PEUGEOT 83 MM STD		+0.76	+0.79		1.48mm gasket	87-126600-00	PEUGEOT 85.00 MM STD	+0.82	+0.86	1.62mm gasket
87-105500-00	PEUGEOT 83 MM STD		+0.80	+0.83		1.52mm gasket	87-135800-00	PEUGEOT 92 MM STD	+0.50	+0.60	1.30mm gasket
87-105900-00	VAG 81 MM STD		+0.66	+0.86		1 notch gasket	87-136400-00	M.BENZ 88 MM STD	+0.38	+0.60	
87-105900-00	VAG 81 MM STD		+0.81	+0.90		2 notch gasket	87-136500-10	MAN 108 MM STD	+0.09	+0.39	
87-105900-00	VAG 81 MM STD		+0.91	+1.02		3 notch gasket	87-140800-00	FORD-PKW 86 MM STD	+0.43	+0.52	1.10mm gasket
87-107000-00	FORD 82.50 MM STD		+0.50	+0.60			87-140800-00	FORD-PKW 86 MM STD	+0.52	+0.57	1.15mm gasket
87-109500-00	AUDI 76,5 MM STD		+0.67	+0.80		1 notch gasket	87-140800-00	FORD-PKW 86 MM STD	+0.57	+0.62	1.20mm gasket
87-109500-00	AUDI 76,5 MM STD		+0.81	+0.90		2 notch gasket	87-140800-10	FORD 86,01 MM FORD	+0.43	+0.52	1.10mm gasket
87-109500-00	AUDI 76,5 MM STD		+0.91	+1.02		3 notch gasket	87-140800-10	FORD 86,01 MM FORD	+0.52	+0.57	1.15mm gasket
87-109800-10	VAG 76,51 MM STD		+0.65	+0.80		1 notch gasket	87-140800-10	FORD 86,01 MM FORD	+0.57	+0.62	1.20mm gasket
87-109800-10	VAG 76,51 MM STD		+0.81	+0.90		2 notch gasket	87-141300-00	FORD 79 MM STD	-1.40	-1.60	
87-109800-10	VAG 76,51 MM STD		+0.91	+1.02		3 notch gasket	87-141800-00	M.BENZ-LKW 128 MM STD	+0.22	+0.71	
87-113500-00	FORD 89,91 MM STD		+0.45	+0.53		1 hole gasket	87-143200-00	HATZ 75 MM STD	+0.65	+0.75	Together with gasket
87-113500-00	FORD 89,91 MM STD		+0.53	+0.65		2 hole gasket	87-143300-00	HATZ 80 MM STD	+0.80	+0.90	Together with gasket
87-113500-00	FORD 89,91 MM STD		+0.65	+0.70		3 hole gasket	87-143500-00	HATZ 108 MM STD	+1.10	+1.30	
87-113500-10	FORD 89.9 MM STD		+0.45	+0.53		1 hole gasket	87-143800-00	MAN 128 MM STD	+0.01	+0.33	
87-113500-10	FORD 89.9 MM STD		+0.53	+0.65		2 hole gasket	87-143800-10	MAN 128 MM STD KH 0,20 MM	+0.01	+0.33	
87-113500-10	FORD 89.9 MM STD		+0.65	+0.70		3 hole gasket	87-143800-20	MAN 128 MM STD KH 0,40 MM	+0.01	+0.33	
87-114400-00	BMW 84 MM STD		+0.80	+0.90		1 notch gasket	87-143800-30	MAN 128 MM STD	+0.01	+0.33	
87-114400-00	BMW 84 MM STD		+0.90	+1.00		2 notch gasket	87-143800-40	MAN 128 MM STD	+0.01	+0.33	
87-114400-10	BMW 84 MM STD		+0.80	+0.90		1 notch gasket	87-144000-00	LAND-ROVER 90,47 MM STD	+0.10	+0.15	1.10mm gasket
87-114400-10	BMW 84 MM STD		+0.90	+1.00		2 notch gasket	87-152000-10	PEUGEOT 83 MM STD	+0.35	+0.54	1.49mm gasket
87-114400-30	BMW 84 MM STD		+0.85	+0.90		1 notch gasket	87-152000-10	PEUGEOT 83 MM STD	+0.65	+0.77	1.60mm gasket
87-114400-30	BMW 84 MM STD		+0.90	+1.00		2 notch gasket	87-152000-10	PEUGEOT 83 MM STD	+0.77	+0.83	1.73mm gasket
87-114400-30	BMW 84 MM STD		+1.00	+1.10		3 notch gasket	87-167600-00	KHD 120 MM STD	+1.10	+1.30	Together with gasket
87-114700-00	PEUGEOT 85 MM STD		+0.55	+0.60		1.25mm gasket	87-172500-00	KHD 100 MM STD	+1.00	+1.20	Together with gasket
87-114700-00	PEUGEOT 85 MM STD		+0.61	+0.65		1.30mm gasket	87-174100-00	DAF 130 MM STD	-0.25	+0.25	
87-114700-00	PEUGEOT 85 MM STD		+0.66	+0.70		1.35mm gasket	87-174100-30	DAF 130 MM STD	-0.25	+0.25	
87-114700-00	PEUGEOT 85 MM STD		+0.71	+0.75		1.40mm gasket	87-174300-00	MERCEDES 97 MM STD	-0.70	+0.30	
87-114900-80	VAG 79,51 MM STD		+0.81	+0.96		1.53mm gasket	87-174300-10	MERCEDES 97 MM STD	-0.70	+0.30	
87-114900-80	VAG 79,51 MM STD		+0.96	+1.01		1.57mm gasket	87-176000-00	M.BENZ-LKW 125 MM STD	+0.07	+0.43	
87-114900-80	VAG 79,51 MM STD		+1.01	+1.03		1.61mm gasket	87-176400-00	M.BENZ-LKW 115 MM STD	+0.08	+0.41	
87-114900-85	VAG 79,51 MM STD		+0.81	+0.96		1.53mm gasket	87-176700-00	M.BENZ 90.9 MM STD	+0.50	+0.90	
87-114900-85	VAG 79,51 MM STD		+0.96	+1.01		1.57mm gasket	87-176800-00	M.BENZ-LKW 125 MM STD	+0.07	+0.43	
87-114900-85	VAG 79,51 MM STD		+1.01	+1.03		1.61mm gasket	87-176900-00	M.BENZ 128 MM STD	+0.09	+0.30	
87-114900-90	VAG 79,51 MM STD		+0.91	+1.00		1 notch gasket	87-176900-10	MERCEDES 128 MM STD	-0.10	+0.22	
87-114900-90	VAG 79,51 MM STD		+1.01	+1.10		2 notch gasket	87-178200-20	MERCEDES 97 MM STD	-0.70	+0.30	
87-114900-90	VAG 79,51 MM STD		+1.10	+1.20		3 notch gasket	87-178400-00	KHD 102 MM STD	+1.00	+1.20	Together with gasket
87-114900-95	VAG 79,51 MM STD		+0.91	+1.00		1 notch gasket	87-178800-00	MERCEDES PKW 97 MM STD	-0.08	+0.30	
87-114900-95	VAG 79,51 MM STD		+1.01	+1.10		2 notch gasket	87-179300-10	M.BENZ-LKW 128 MM STD	+0.17	+0.53	
87-114900-95	VAG 79,51 MM STD		+1.10	+1.20		3 notch gasket	87-179300-15	M.BENZ-LKW 128 MM STD	+0.17	+0.53	
87-117900-00	M.BENZ-PKW 88 MM STD		+0.38	+0.62			87-179300-50	M.BENZ-LKW 128 MM STD	+0.07	+0.43	

PISTON PROTRUSION DATA

Kolbenüberstands-Daten • Altura del pistón en PMS
Données de dépassement de piston • Dati di tolleranza pistone

					
87-179300-65	M.BENZ-LKW 128 MM STD	-0.10	+0.32		
87-179300-70	M.BENZ-LKW 128 MM STD	-0.07	+0.43		
87-179300-80	M.BENZ-LKW 128 MM STD	+0.07	+0.43		
87-179300-85	M.BENZ-LKW 128 MM STD	+0.17	+0.53		
87-179300-86	M.BENZ-LKW 128 MM STD	+0.17	+0.53		
87-179700-00	M.BENZ 95,5 MM STD	+0.50	+0.90		
87-181100-10	JOHN DEERE 106,5 MM STD	+0.10	+0.30		
87-181700-00	M.BENZ-LKW 128 MM STD	+0.17	+0.53		
87-181800-00	J.DEERE 102 MM STD	-0.07	0.00		
87-181800-10	J.DEERE 102 MM STD	-0.07	0.00		
87-181800-20	J.DEERE 106.5 MM STD	+0.14	+0.20		
87-183300-00	M.BENZ 87 MM STD	+0.73	+0.96		
87-202400-00	FORD-TRK 111,76 MM STD	+0.18	+0.61		
87-202400-10	FORD-TRK 111,76 MM STD	+0.28	+0.58		
87-202400-30	FORD-TRK 111,76 MM STD	+0.28	+0.58		
87-202800-00	FORD-LKW 104,775 MM STD	-0.15	+0.40		
87-203500-00	FORDSON 100 MM STD	-0.700	+0.127		
87-206800-00	IVECO 100 MM STD	+0.46	+0.79		
87-207200-00	IVECO 95 MM STD	+0.46	+0.79		
87-207300-00	FORD PKW 93,67 MM STD	-0.114	+0.213		
87-207800-00	IVECO 137 MM STD	-0.27	+0.22		
87-207800-10	IVECO-LKW 137 MM STD	-0.275	+0.225		
87-208100-10	FORD TRK 106,68 MM STD	-0.05	-0.15		
87-214800-10	FORD 107,21 MM STD	-0.15	+0.40		
87-214900-10	IVECO 115 MM STD	-0.29	+0.10		
87-215500-00	FORD 80 MM STD	+0.43	+0.62	1 notch gasket	
87-215500-00	FORD 80 MM STD	+0.62	+0.68	2 notch gasket	
87-215500-00	FORD 80 MM STD	+0.68	+0.74	3 notch gasket	
87-243300-00	IHC LKW 98,425 MM STD	+0.46	+0.77		
87-243600-00	IHC LKW 98,425 MM STD	-0.40	-0.55		
87-244500-10	IVECO 104 MM STD	+0.46	+0.79		
87-247800-00	IVECO 104 MM STD	+0.355	+0.761		
87-247800-10	IVECO 104 MM STD	+0.46	+0.79		
87-248000-10	ISUZU 93 MM STD	0.00	+0.70		
87-252800-00	KHD 94 MM STD	+0.43	+0.64	1 notch gasket	
87-252800-00	KHD 94 MM STD	+0.64	+0.74	2 notch gasket	
87-252800-00	KHD 94 MM STD	+0.74	+0.84	3 notch gasket	
87-274800-00	MAN 121 MM STD	+0.05	+0.35		
87-274800-10	MAN 121 MM STD	+0.05	+0.35		
87-274800-20	MAN 121 MM STD KH -0,20	+0.05	+0.35		
87-274800-30	MAN 121 MM STD KH -0,40	+0.05	+0.35		
87-279600-10	MWM 105 MM STD	-0.28	-0.60		
87-280200-10	MAN 125 MM STD	0.00	+0.32		
87-283100-00	MAN 128 MM STD	+0.010	+0.038		
87-283100-30	MAN 128 MM STD	0.00	+0.20		
87-283100-80	MAN 128 MM STD	+0.01	+0.38		
87-283100-85	MAN 128 MM STD KH 0,20 MM	+0.01	+0.38		
87-283100-86	MAN 128 MM STD KH 0,40 MM	+0.01	+0.38		
87-285900-20	MAN 108 MM STD	+0.15	+0.32		
87-285900-40	MAN 108 MM STD	+0.15	+0.32		
87-288000-10	MITSUBISHI 91.10 MM STD	+0.55	+0.65		
87-288300-00	MITSUBISHI 104 MM STD	+0.60	+0.70		
87-288300-10	MITSUBISHI 104 MM STD	+0.60	+0.70		
87-289300-10	M.BENZ-LKW 102 MM STD	+0.28	+0.50		
87-289600-00	M.BENZ-LKW 130 MM STD	+0.27	+0.61		
87-305900-00	OPEL 80 MM STD	0.00	+0.75	1.30mm gasket	
87-305900-00	OPEL 80 MM STD	+0.75	+0.85	1.40mm gasket	
87-305900-00	OPEL 80 MM STD	+0.85	+1.05	1.50mm gasket	
87-306700-10	OPEL 82,5 MM STD	0.00	+0.75	1.30mm gasket	
87-306700-10	OPEL 82,5 MM STD	+0.75	+0.85	1.40mm gasket	
87-306700-10	OPEL 82,5 MM STD	+0.85	+1.05	1.50mm gasket	
87-307600-20	OPEL 79 MM STD	+0.58	+0.64	STD gasket	
87-307600-20	OPEL 79 MM STD	+0.65	+0.70	1 hole gasket	
87-307600-20	OPEL 79 MM STD	+0.70	+0.78	2 hole gasket	
87-307600-40	OPEL 79 MM STD	+0.63	+0.70	1.45mm gasket	
87-307600-40	OPEL 79 MM STD	+0.70	+0.76	1.50mm gasket	
87-307600-40	OPEL 79 MM STD	+0.76	+0.83	1.55mm gasket	
87-314600-00	PERKINS TRK 91,48 MM STD	0.00	-0.13		
87-314600-10	PERKINS 91,48 MM STD	0.00	-0.13		
87-315000-00	PERKINS-TRK 98,48 MM STD	+0.28	+0.48		
87-318000-00	PERKINS 101,054 MM STD KH -0,30 MM	+0.08	+0.25		
87-318700-10	PEUGEOT 94 MM STD	0.00	+0.84		
87-321500-00	PEUGEOT 80 MM STD	+0.54	+0.77	1.61mm gasket	
87-321500-00	PEUGEOT 80 MM STD	+0.77	+0.82	1.73mm gasket	
87-321500-10	PEUGEOT 80 MM STD	+0.54	+0.77	1.61mm gasket	
87-321500-10	PEUGEOT 80 MM STD	+0.77	+0.82	1.73mm gasket	
87-322100-00	PERKINS 98,48 MM STD	+0.38	+0.53		
87-322700-00	PERKINS TRK 101.054 MM STD	+0.08	+0.25		
87-325600-00	PERKINS LKW 100 MM STD	+0.382	+0.504		
87-325800-00	FORD 73,7 MM STD	+0.618	+0.725	1.252mm gasket	
87-326300-00	PEUGEOT 92 MM STD	+0.64	+0.74		
87-326500-00	PERKINS-LKW 100 MM STD	+0.382	+0.504		
87-335000-00	RENAULT 78 MM STD	0.00	+0.885	1.65mm gasket	
87-335000-00	RENAULT 78 MM STD	+0.885	+0.985	1.75mm gasket	
87-335000-00	RENAULT 78 MM STD	+0.985	+1.085	1.85mm gasket	
87-335000-10	RENAULT 78 MM STD	0.00	+0.885	1.65mm gasket	
87-335000-10	RENAULT 78 MM STD	+0.885	+0.985	1.75mm gasket	
87-335000-10	RENAULT 78 MM STD	+0.985	+1.085	1.85mm gasket	
87-336500-00	RENAULT 80 MM STD	0.00	+0.87	1.65mm gasket	
87-336500-00	RENAULT 80 MM STD	+0.87	+1.00	1.75mm gasket	
87-336500-00	RENAULT 80 MM STD	+1.00	+...	1.85mm gasket	
87-336500-10	RENAULT 80 MM STD	+0.55	+0.65	1.40mm gasket	
87-336500-10	RENAULT 80 MM STD	+0.65	+0.75	1.50mm gasket	
87-336500-10	RENAULT 80 MM STD	+0.75	+0.85	1.60mm gasket	
87-335000-00	RENAULT 78 MM STD	0.00	+0.885	1.65mm gasket	
87-335000-00	RENAULT 78 MM STD	+0.885	+0.985	1.75mm gasket	
87-335000-00	RENAULT 78 MM STD	+0.985	+1.085	1.85mm gasket	
87-335000-10	RENAULT 78 MM STD	0.00	+0.885	1.65mm gasket	
87-335000-10	RENAULT 78 MM STD	+0.885	+0.985	1.75mm gasket	
87-335000-10	RENAULT 78 MM STD	+0.985	+1.085	1.85mm gasket	
87-336500-00	RENAULT 80 MM STD	0.00	+0.87	1.65mm gasket	
87-336500-00	RENAULT 80 MM STD	+0.87	+1.00	1.75mm gasket	
87-336500-00	RENAULT 80 MM STD	+1.00	+...	1.85mm gasket	
87-336500-10	RENAULT 80 MM STD	+0.55	+0.65	1.40mm gasket	
87-336500-10	RENAULT 80 MM STD	+0.65	+0.75	1.50mm gasket	
87-336500-10	RENAULT 80 MM STD	+0.75	+0.85	1.60mm gasket	
87-361900-00	STEYR 100 MM STD	+0.25	+0.28		
87-373800-10	TOYOTA 92 MM STD	+0.68	+0.77	B gasket	
87-373800-10	TOYOTA 92 MM STD	+0.78	+0.87	D gasket	
87-373800-10	TOYOTA 92 MM STD	+0.88	+0.97	F gasket	
87-396300-00	VOLVO 120,65 MM STD	-0.50	+0.20		
87-405600-60	VOLVO 130,18 MM STD	-0.50	+0.45		
87-405600-70	VOLVO 130,18 MM STD	-0.05	+0.45		
87-421000-10	VAG 81 MM STD	0.00	+0.75		
87-421000-20	VAG 81 MM STD	0.00	+0.75		
87-421900-00	M.BENZ-PKW 93,75 MM STD	+0.50	+0.90		
87-424000-00	PEUGEOT 75 MM STD	+0.53	+0.63	1.25mm gasket	
87-424000-00	PEUGEOT 75 MM STD	+0.63	+0.68	1.30mm gasket	
87-424000-00	PEUGEOT 75 MM STD	+0.68	+0.73	1.35mm gasket	
87-424000-00	PEUGEOT 75 MM STD	+0.73	+0.78	1.40mm gasket	
87-424000-00	PEUGEOT 75 MM STD	+0.78	+0.88	1.45mm gasket	
87-425000-00	PERKINS-TRK 103 MM STD	+0.35	+0.55	1.70mm gasket	

											
87-425400-00	PERKINS-TRK 103 MM STD		+0.35	+0.55	1.70mm gasket		87-990100-40	VAG 79,51 MM STD	+0.87	+0.90	2 notch gasket
87-426200-00	PERKINS-TRK 105 MM STD		+0.36	+0.50			87-990100-40	VAG 79,51 MM STD	+0.91	+1.02	3 notch gasket
87-427700-10	FORD-PKW 86,01 MM STD		+0.43	+0.52	1.10mm gasket		88-103200-00	KHD 91 MM STD	+0.59	+0.69	1 notch gasket
87-427700-10	FORD-PKW 86,01 MM STD		+0.52	+0.57	1.15mm gasket		88-103200-00	KHD 91 MM STD	+0.69	+0.76	2 notch gasket
87-427700-10	FORD-PKW 86,01 MM STD		+0.57	+0.62	1.20mm gasket		88-103200-00	KHD 91 MM STD	+0.76	+0.83	3 notch gasket
87-427700-30	FORD-PKW 86,01 MM STD		+0.43	+0.52	1.10mm gasket		88-104300-00	MAN 128 MM STD	+0.01	+0.33	
87-427700-30	FORD-PKW 86,01 MM STD		+0.52	+0.57	1.15mm gasket		88-136500-10	MAN 108 MM STD	+0.09	+0.39	
87-427700-30	FORD-PKW 86,01 MM STD		+0.57	+0.62	1.20mm gasket		88-141800-00	M.BENZ-LKW 128 MM STD	+0.22	+0.71	
87-431700-00	KIA 91 MM STD		+0.06	+0.24			88-152000-30	PEUGEOT 83 MM STD	+0.35	+0.54	1.49mm gasket
87-431800-00	KIA 94.545 MM STD		+0.30	+0.40			88-172500-00	KHD 100 MM STD	+1.00	+1.20	Together with gasket
87-431900-00	HYUNDAI 83 MM STD		+0.30	+0.39			88-174100-30	DAF 130 MM STD	0.25	+0.25	
87-432000-00	HYUNDAI 91.1 MM STD		+0.45	+0.60			88-176800-00	M.BENZ-LKW 125 MM STD	-0.07	+0.43	
87-501400-00	VOLVO 104,77 MM STD		+0.20	+0.70			88-179300-10	M.BENZ-LKW 128 MM STD	+0.17	+0.53	
87-520900-00	FORD 104,775 MM STD		+0.152	+0.380			88-181100-10	J.DEERE 106,5 MM STD	+0.10	+0.30	
87-521100-00	NISSAN 93 MM STD		+0.11	+0.16			88-181100-20	J.DEERE 106,5 MM STD	+0.14	+0.20	
87-521200-00	MITSUBISHI 91.10 MM STD		+0.65	+0.90			88-181700-00	M.BENZ-LKW 128 MM STD	+0.17	+0.53	
87-521400-00	FORD-TRK 111,76 MM STD		0.00	+0.50			88-181800-00	J.DEERE 102 MM STD	-0.07	0.00	
87-521800-20	LAND ROVER 90.47 MM STD		+0.50	+0.60	1 notch gasket		88-181800-10	J.DEERE 102 MM STD	-0.07	0.00	
87-521800-20	LAND ROVER 90.47 MM STD		+0.61	+0.70	2 notch gasket		88-203500-00	FORD LKW 100 MM STD	+0.700	+0.127	
87-521800-20	LAND ROVER 90.47 MM STD		+0.71	+0.80	3 notch gasket		88-243300-00	IHC LKW 98,425 MM STD	+0.45	+0.77	
87-525300-00	BMC 98 MM STD		0.00	+0.20			88-243600-00	IHC LKW 98,425 MM STD	-0.40	-0.55	
87-714400-00	LAND ROVER 90.47 MM STD		+0.10	+0.15	1.10mm Gasket		88-252800-00	KHD 94 MM STD	+0.43	+0.64	1 notch gasket
87-714800-20	KHD 100 MM STD		+1.00	+1.20	Together with gasket		88-274800-00	MAN 121 MM STD	+0.05	+0.35	
87-740000-20	M.BENZ-LKW 97,5 MM STD		+0.38	+0.62			88-743400-10	DAF 130 MM STD	0.00	+0.25	
87-740000-40	MERCEDES 97.5 MM STD		+0.38	+0.62			88-743400-30	DAF 130 MM STD	0.00	+0.25	
87-740000-50	MERCEDES 97.5 MM STD		+0.38	+0.62			88-960900-00	SCANIA 115 MM STD	+0.07	+0.50	
87-740300-00	KHD 125 MM STD		+1.15	+1.30	Together with gasket		89-124500-00	MAN 128 MM STD	+0.10	+0.33	
87-740300-10	KHD 125 MM STD		+1.15	+1.30	Together with gasket		89-143800-00	MAN 128 MM STD	+0.01	+0.33	
87-741800-00	KHD 100 MM STD		+1.00	+1.20	Together with gasket		89-143800-10	MAN 128 MM STD KH: 0,20 MM	+0.01	+0.33	
87-741800-20	KHD 100 MM STD		+1.00	+1.20	Together with gasket		89-143800-20	MAN 128 MM STD KH: 0,40 MM	+0.01	+0.33	
87-743100-00	M.BENZ 89 MM STD		+0.83	+1.06			89-143800-30	MAN 128 MM STD	+0.01	+0.33	
87-743100-10	M.BENZ 89 MM STD		+0.84	+1.06	1.80mm gasket		89-179300-05	M.BENZ-LKW 128 MM STD	-0.07	+0.43	
87-743100-10	M.BENZ 89 MM STD		+1.03	+1.06	2.00mm gasket		89-179300-15	M.BENZ-LKW 128 MM STD	+0.17	+0.53	
87-743100-30	M.BENZ 89 MM STD		+0.73	+0.97			89-179300-18	M.BENZ-LKW 128 MM STD	+0.17	+0.53	
87-743100-40	M.BENZ 89 MM STD		+0.83	+1.06	1.74mm gasket		89-179300-60	M.BENZ LKW 128 MM STD	+0.17	+0.53	
87-743100-40	M.BENZ 89 MM STD		+1.03	+1.26	1.97mm gasket		89-179300-65	M.BENZ-LKW 128 MM STD	-0.10	+0.32	
87-743200-00	M.BENZ-LKW 130 MM STD		+0.07	+0.43			89-179300-66	M.BENZ-LKW 128 MM STD	-0.10	+0.32	
87-743400-10	DAF 130 MM STD		0.00	+0.25			89-179300-70	M.BENZ-LKW 128 MM STD	-0.07	+0.43	
87-743400-30	DAF 130 MM STD		0.00	+0.25			89-179300-71	M.BENZ-LKW 128 MM STD	-0.07	+0.43	
87-743400-40	DAF 130 MM STD		0.00	+0.25			89-179300-80	M.BENZ-LKW 128 MM STD	+0.07	+0.43	
87-743400-50	DAF 130 MM STD		0.00	+0.25			89-179300-85	M.BENZ-LKW 128 MM STD	+0.17	+0.53	
87-743600-10	M.BENZ 87,00 MM STD		+0.735	+0.965			89-179300-86	M.BENZ-LKW 128 MM STD	+0.17	+0.53	
87-744600-00	KHD 100 MM STD		+1.00	+1.20	Together with gasket		89-181700-00	M.BENZ-LKW 128 MM STD	+0.17	+0.53	
87-781900-10	FIAT 100 MM STD		+0.365	+0.761			89-181700-60	M.BENZ-LKW 128 MM STD	+0.17	+0.53	
87-781900-30	IVECO 100 MM STD		+0.365	+0.761			89-289600-00	M.BENZ-LKW 130 MM STD	+0.27	+0.61	
87-782000-00	IVECO-TRK 103 MM STD		+0.465	+0.785			89-243300-10	IHC LKW 98,425 MM STD	+0.45	+0.77	
87-782900-00	FORD 107,21 MM STD		+0.152	+0.380			89-243600-10	IHC LKW 98,425 MM STD	-0.40	-0.55	
87-783000-30	IVECO 137 MM STD		-0.27	+0.22			89-280200-10	MAN 125 MM STD	0.00	+0.32	
87-784800-00	FORD 93,67 MM STD		+0.30	+0.40			89-283100-00	MAN 128 MM STD	+0.010	+0.038	
87-784800-10	FORD 93,67 MM STD		+0.35	+0.45			89-283100-30	MAN 128 MM STD	0.00	+0.20	
87-854700-00	IVECO 94,4 MM STD		+0.40	+0.50	1.20mm gasket		89-283100-80	MAN 128 MM STD	+0.01	+0.33	
87-854700-00	IVECO 94,4 MM STD		+0.51	+0.60	1.30mm gasket		89-283100-85	MAN 128 MM STD KH:0,20 MM	+0.01	+0.33	
87-854700-00	IVECO 94,4 MM STD		+0.61	+0.70	1.40mm gasket		89-283100-86	MAN 128 MM STD KH:0,40 MM	+0.01	+0.33	
87-854700-00	IVECO 94,4 MM STD		+0.71	+0.80	1.50mm gasket		89-289600-30	M.BENZ-LKW 130 MM STD	+0.27	+0.61	
87-960900-00	SCANIA 115 MM STD		+0.07	+0.50			89-396300-00	VOLVO 120,65 MM STD	-0.50	+0.20	
87-962000-10	SCANIA 127 MM STD		+0.95	+1.35	Together with gasket		89-405600-00	VOLVO 130,18 MM STD	-0.50	+0.45	
87-962000-40	SCANIA 127 MM STD		+0.95	+1.35	Together with gasket		89-405600-60	VOLVO 130,18 MM STD	-0.50	+0.45	
87-990100-10	AUDI 79,5 MM STD		+0.66	+0.86	1 notch gasket		89-405600-70	VOLVO-LKW 130,18 MM STD	-0.05	+0.45	
87-990100-10	AUDI 79,5 MM STD		+0.87	+0.90	2 notch gasket		89-405600-80	VOLVO-LKW 130,18 MM STD	-0.05	+0.45	
87-990100-10	AUDI 79,5 MM STD		+0.91	+1.02	3 notch gasket		89-743200-00	M.BENZ-LKW 130 MM STD	+0.07	+0.43	
87-990100-40	VAG 79,51 MM STD		+0.66	+0.86	1 notch gasket		89-960900-00	SCANIA 115 MM STD	+0.07	+0.50	
							89-962000-10	SCANIA 127 MM STD	+0.95	+1.35	Together with gasket

ENGINE EXPERTISE

A COMPLETE ENGINE OFFER

TOP ENGINE



AE

BEARINGS



GLYCO

PISTON RINGS



GOETZE

PISTON



Niral

FITTED WITH GOETZE RINGS

GASKETS



Payen

ENGINE EXPERTISE





CHECK OUT OUR CATALOGUES



CATAE902 - Belts and Timing Belt kits

CATAE190I - Valves & Components

CATAE150I - Camshaft, Kits and Components

CATPAI80I - Oil Seals

CATPAI40I - Gaskets, Oil Seals and Cylinder Headbolts



CATGY220I
Engine Bearings



CATGT190I
Piston Rings



CATGT150I
Liners



Combined E&S catalogues per vehicle makes:

CATMX130I - Audi / Seat / Skoda / Volkswagen

CATMX1402 - PSA Renault

CATMX1403 - BMW / Mini / Mercedes-Benz / Smart / Porsche

CATMX150I - Alfa / Fiat / Lancia / Iveco

CATMX160I - Ford - Jaguar - Land Rover - Opel - Saab

Visit <http://www.fmecat.eu>
Online catalogue website. Available 24/7

ENGINE EXPERTISE





GOETZE®



UP TO 50% LESS OIL CONSUMPTION

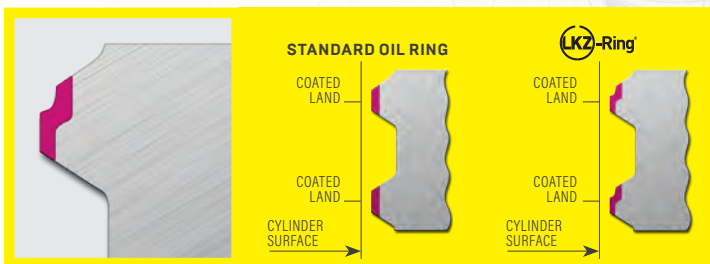

GOETZE® BRINGS ITS INNOVATIVE, OE-PROVEN TECHNOLOGY TO THE AFTERMARKET

- Reduced oil consumption up to -50%* and friction up to -15%*
- Cuts CO₂ and improves fuel consumption
- Variety of surface treatments: CKS, GDC®, PVD
- Winner of the prestigious Automotive News PACE™ award

* Compared to conventional two-piece oil rings



ENGINE EXPERTISE





garagegurus.tech/en-eu